

Symaro™

Economizer duct sensor

QFR9530, QFR9500, QAR9530



Acquire air temperature and humidity in ducts

- Operating voltage 24 VAC or 15...35 VDC
- Relative humidity outputs 0...10 VDC (QFR9500 & QFR9530)
- Temperature outputs NTC 10k type II thermistor (QFR9530 & QAR9530)
- For use with Siemens economizer controllers or other HVAC controllers requiring a 0...10 V RH signal and NTC 10k type II thermistor temperature signal

Use

The sensor is used to acquire air temperature and humidity in ducts.

Functions

Relative humidity (QFR9530 & QFR9500)	The sensor acquires the relative humidity in the duct via its capacitive humidity sensing element whose electrical capacitance changes as a function of relative humidity. The electronic measuring circuit converts the sensor's signal to a continuous 0...10 VDC signal, corresponding to a relative humidity range of 0...100 %.
Temperature (QFR9530 & QAR9530)	The sensor acquires the temperature in the duct via its sensing element whose electrical resistance changes as a function of the temperature. The signal is delivered to a suitable controller for further handling.

Sensing element

NTC 10k

Characteristic:

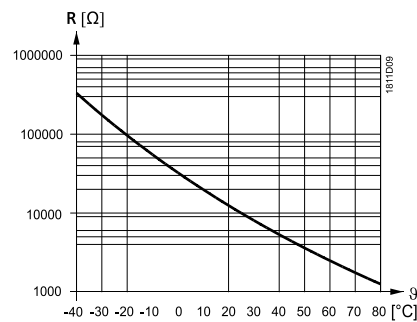

Accuracy:

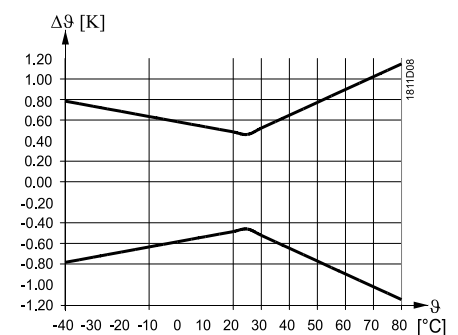

Legend

R	Resistance value in Ohm
θ	Temperature in degrees Celsius
Δθ	Temperature differential in Kelvin

Mechanical design

The duct sensor consists of a housing, a printed circuit board, and connection terminals. The bisectonal housing consists of a front and rear (snap-on design). The measuring circuit, connection terminals, and the setting elements are located on the printed circuit board inside the housing front. The humidity and temperature sensing elements are also located on the printed circuit board.

Type summary

Model number	Orderable part number	Description
QFR9530	S55720-S501	Duct sensor to acquire temperature, relative humidity
QFR9500	S55720-S502	Duct sensor to acquire relative humidity
QAR9530	S55720-S503	Duct sensor to acquire temperature

Ordering and delivery

When ordering, provide both name and type reference, e.g. duct sensor QFR9530.

Title	Document ID:
Mounting instructions	A6V11937904
CE declaration	A5W00119471A
RCM declaration	A5W00119472A
Environmental product declaration	A5W00119622A

All documentation can be downloaded at <http://siemens.com/bt/download>.

Equipment combinations

The duct sensors are used together with the Siemens POL series economizer controller.

Notes

Security

	CAUTION
	<p>National safety regulations</p> <p>Failure to comply with national safety regulations may result in personal injury and property damage.</p> <ul style="list-style-type: none"> Observe national provisions and comply with the appropriate safety regulations.

Engineering

Powering the sensor requires a transformer for safety extra low-voltage (SELV) with separate windings for 100 % duty. When sizing and protecting the transformer, comply with all local safety regulations.

When sizing the transformer, consider the sensor's power consumption.

For correct wiring, see the related device data sheets.

Observe all permissible line lengths.

Cable routing and cable selection

Note that when routing cables, the longer the cable runs and the closer the cables, the greater the electrical interference. Use shielded cables in EMC-prone environments.

Twisted pair cables are required for both secondary supply lines and signal lines.

Mounting

- The sensors can be mounted on the inner wall of the duct as illustrated below.

Permitted

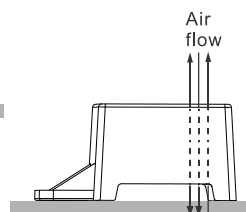
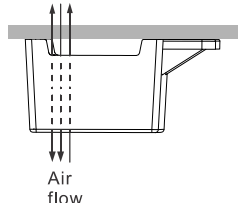
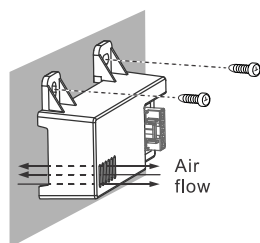

Not permitted

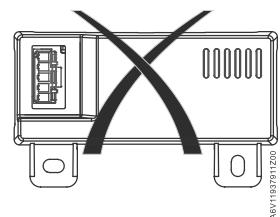

- ⚠ Do not use sensors in areas with possible acid fumes or chemical vapors that can corrode sensor metal parts or with volatile or explosive gases.

Mounting instructions

Mounting instructions are enclosed in the package.

Disposal

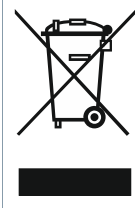

The device is considered an electronic device for disposal in accordance with European Directive and may not be disposed of as domestic waste.

- Use only designated channels for disposing the devices.
- Comply with all local and currently applicable laws and regulations.

FCC

This device complies with part 15 of the FCC rules. Operation is subject to the following two conditions:

1. This device may not cause harmful interference;
2. This device must accept any interference received, including interference that may cause undesired operation.

Changes or modifications not expressly approved by the party responsible for compliance could void the user's authority to operate the equipment.

NOTE: This equipment has been tested and found to comply with the limits for a Class B digital device, pursuant to part 15 of the FCC Rules. These limits are designed to provide reasonable protection against harmful interference in a residential installation. This equipment generates, uses and can radiate radio frequency energy and, if not installed and used in accordance with the instructions, may cause harmful interference to radio communications. However, there is no guarantee that interference will not occur in a particular installation. If this equipment does cause harmful interference to radio or television reception, which can be determined by turning the equipment off and on, the user is encouraged to try to correct the interference by one or more of the following measures:

- Reorient or relocate the receiving antenna.
- Increase the separation between the equipment and receiver.
- Connect the equipment into an outlet on a circuit different from that to which the receiver is connected.
- Consult the dealer or an experienced radio/TV technician for help.

Power supply	
Operating voltage	24 VAC (-20 %...+20 %) (class 2) or 15...35 VDC (SELV)
Frequency	50/60 Hz at 24 VAC
External supply line protection (EU)	Fuse slow max. 10 A or Circuit breaker max. 13 A Characteristic B, C, D as per EN 60898 or Power source with current limitation of max. 10 A
Power consumption	
QFR9530	0.6 VA
QFR9500	0.5 VA
QAR9530	0.1 VA

Functional data (temperature with QFR9530 & QAR9530)	
Range of use	-40...149 °F (-40...65 °C)
Measuring range	-40...149 °F (-40...65 °C)
Measuring accuracy at 25 °C	±0.5 K
Time constant	< 3.5 min in 2 m/s moved air

Functional data (humidity with QFR9530 & QFR9500)	
Range of use	0...100 % r.h.
Measuring range	0...100 % r.h.
Measuring accuracy 0...100 % r.h.	±5 % r.h.
Time constant at 0...50 °C and 10...80 % r.h.	< 20 s

Ambient conditions and protection classification	
Protection degree of housing	IP20 as per EN 60529 in built-in state
Protection class	III as per EN 60730-1
Environmental conditions	
Storage	IEC 60721-3-1
• Climatic conditions	Class 1K3
– Temperature	-40...149 °F (-40...65 °C)
– Humidity	0...100 % r.h., 85 °F (29.4 °C) max. dew point
• Mechanical conditions	Class 2M2
Transport	IEC 60721-3-2
• Climatic conditions	Class 2K3
– Temperature	-40...158 °F (-40...70 °C)
– Humidity	< 95 % r.h., 85 °F (29.4 °C) max. dew point
• Mechanical conditions	Class 2M2
Operation	IEC 60721-3-3
• Climatic conditions	Class 3K5
– Temperature (housing with electronics)	-40...149 °F (-40...65 °C)
– Humidity	0...100 % r.h., 85 °F (29.4 °C) max. dew point
• Mechanical conditions	Class 3M2

Standards, directives and approvals	
Product standard	EN 60730-1 Automatic electrical controls for household and similar use
Electromagnetic compatibility (applications)	For use in residential, commerce, light industrial and industrial environments
EU conformity (CE)	A5W00119471A *)
RCM conformity	A5W00119472A *)
UL	UL 916, UL 2043, http://ul.com/database
Environmental compatibility	The product environmental declaration (A5W00119622A *) contains data on environmentally compatible product design and assessments (RoHS compliance, materials composition, packaging, environmental benefit, disposal).

General	
Cable lengths for measuring signals Perm. cable lengths	< 20 m
Electrical connections screw terminals	Solid or stranded: 1 × 24 AWG...1 × 16 AWG (1 × 0.25 mm ² ...1 × 1.5 mm ²) Solid: 2 × 24 AWG...2 × 22 AWG (2 × 0.25 mm ² ...2 × 0.5 mm ²) Stranded: 2 × 24 AWG...2 × 20 AWG (2 × 0.25 mm ² ...2 × 0.75 mm ²)
Female connector	TE series 1-1123722 or equivalent
Materials and colors	
Front housing	Polycarbonate, RAL 7035 (light-gray)
Rear housing	Polycarbonate, RAL 7035 (light-gray)
Packaging	Corrugated cardboard
Weight including package	
QFR9530	99 g
QFR9500	94 g
QAR9530	91 g

*) The documents can be downloaded from <http://siemens.com/bt/download>.

Connection terminals

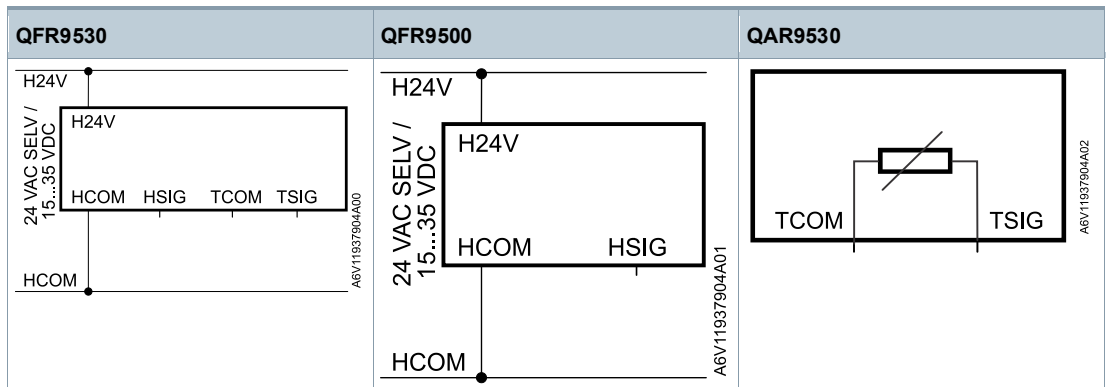

- H24V Operating voltage 24 VAC (-20 %...+20 %) or 15...35 VDC
- HCOM System ground and measuring neutral
- HSIG Relative humidity signal output 0...10 VDC
- TCOM & TSIG NTC 10k passive temperature output (interchangeable)

Dimensions

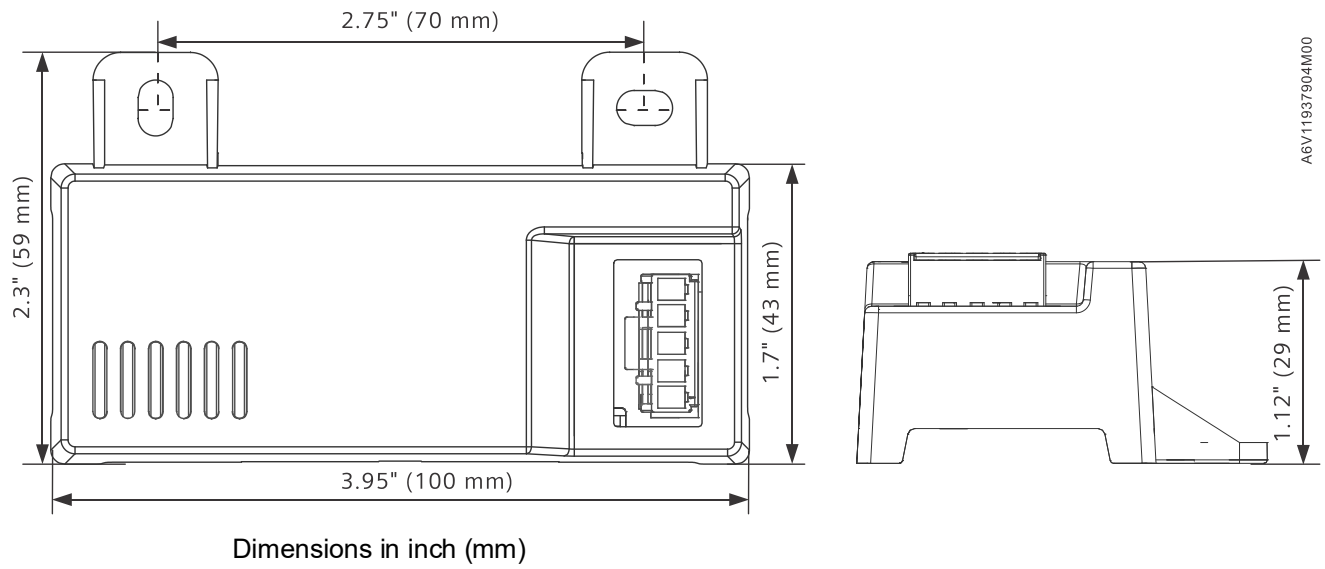

Issued by
Siemens Switzerland Ltd
Smart Infrastructure
Global Headquarters
Theilerstrasse 1a
CH-6300 Zug
+41 58 724 2424
www.siemens.com/buildingtechnologies

© Siemens Switzerland Ltd, 2020
Technical specifications and availability subject to change without notice.

Document ID A6V11937911_enUS_c
Edition 2021-10-13