

SIEMENS

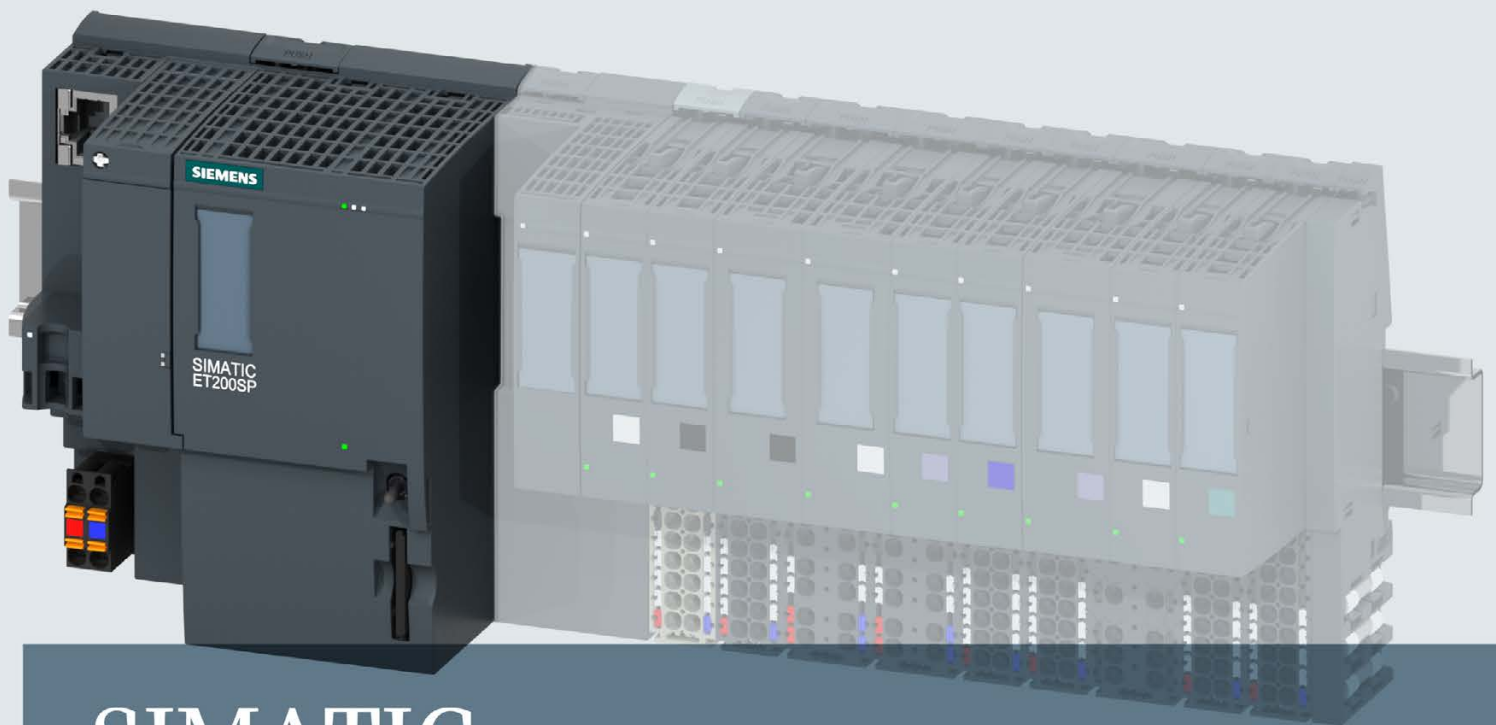

SIMATIC

ET 200SP

CPU 1512SP-1 PN (6ES7512-1DK00-0AB0)

Manual

Edition

12/2014

Answers for industry.

SIEMENS

SIMATIC

ET 200SP
CPU 1512SP-1 PN
(6ES7512-1DK00-0AB0)

Manual

Preface

Documentation guide

1

Product overview

2

Wiring

3

Interrupts, error messages,
diagnostics and system
alarms

4

Technical specifications

5



Dimension drawing

A

Legal information

Warning notice system

This manual contains notices you have to observe in order to ensure your personal safety, as well as to prevent damage to property. The notices referring to your personal safety are highlighted in the manual by a safety alert symbol, notices referring only to property damage have no safety alert symbol. These notices shown below are graded according to the degree of danger.

| |
|--|
|  DANGER |
| indicates that death or severe personal injury will result if proper precautions are not taken. |
|  WARNING |
| indicates that death or severe personal injury may result if proper precautions are not taken. |
|  CAUTION |
| indicates that minor personal injury can result if proper precautions are not taken. |
| NOTICE |
| indicates that property damage can result if proper precautions are not taken. |

If more than one degree of danger is present, the warning notice representing the highest degree of danger will be used. A notice warning of injury to persons with a safety alert symbol may also include a warning relating to property damage.

Qualified Personnel

The product/system described in this documentation may be operated only by **personnel qualified** for the specific task in accordance with the relevant documentation, in particular its warning notices and safety instructions. Qualified personnel are those who, based on their training and experience, are capable of identifying risks and avoiding potential hazards when working with these products/systems.

Proper use of Siemens products

Note the following:

| |
|--|
|  WARNING |
| Siemens products may only be used for the applications described in the catalog and in the relevant technical documentation. If products and components from other manufacturers are used, these must be recommended or approved by Siemens. Proper transport, storage, installation, assembly, commissioning, operation and maintenance are required to ensure that the products operate safely and without any problems. The permissible ambient conditions must be complied with. The information in the relevant documentation must be observed. |

Trademarks

All names identified by ® are registered trademarks of Siemens AG. The remaining trademarks in this publication may be trademarks whose use by third parties for their own purposes could violate the rights of the owner.

Disclaimer of Liability

We have reviewed the contents of this publication to ensure consistency with the hardware and software described. Since variance cannot be precluded entirely, we cannot guarantee full consistency. However, the information in this publication is reviewed regularly and any necessary corrections are included in subsequent editions.

Preface

Purpose of the documentation

This manual supplements the ET 200SP distributed I/O system (<http://support.automation.siemens.com/WW/view/en/58649293>) system manual as well as the function manuals. All cross-system functions are described in the system manual and in the function manuals.

The information provided in this manual and the system manual allows you to commission the CPU 1512SP-1 PN.

Conventions

STEP 7: In this documentation, "STEP 7" is used as a synonym for all versions of the configuration and programming software "STEP 7 (TIA Portal)".

Please also observe the notes marked as follows:

Note

A note contains important information on the product described in the documentation, on the handling of the product or on the section of the documentation to which particular attention should be paid.

Security information

Siemens provides products and solutions with industrial security functions that support the secure operation of plants, solutions, machines, equipment and/or networks. They are important components in a holistic industrial security concept. With this in mind, Siemens' products and solutions undergo continuous development. Siemens recommends strongly that you regularly check for product updates.

For the secure operation of Siemens products and solutions, it is necessary to take suitable preventive action (e.g. cell protection concept) and integrate each component into a holistic, state-of-the-art industrial security concept. Third-party products that may be in use should also be considered. You can find more information about industrial security on the Internet (<http://www.siemens.com/industrialsecurity>).

To stay informed about product updates as they occur, sign up for a product-specific newsletter. You can find more information on the Internet (<http://support.automation.siemens.com>).

Table of contents

| | | |
|----------|--|-----------|
| | Preface | 4 |
| 1 | Documentation guide | 6 |
| 2 | Product overview | 8 |
| 2.1 | Operating principle | 8 |
| 2.2 | Properties | 9 |
| 2.3 | Operating and display elements | 12 |
| 2.3.1 | Front view of the module with BusAdapter | 12 |
| 2.4 | Mode switch | 13 |
| 2.5 | Functions | 13 |
| 2.5.1 | PROFINET IO | 13 |
| 2.5.2 | PROFenergy | 14 |
| 2.5.3 | PROFIBUS DP | 15 |
| 2.5.4 | Memory reset | 16 |
| 2.5.5 | Restoring the factory settings of the CPU | 18 |
| 3 | Wiring | 20 |
| 4 | Interrupts, error messages, diagnostics and system alarms | 25 |
| 4.1 | Status and error display of the CPU | 25 |
| 5 | Technical specifications | 28 |
| A | Dimension drawing | 38 |

Documentation guide

The documentation for the SIMATIC ET 200SP distributed I/O system is arranged into three areas.

This arrangement enables you to access the specific content you require.

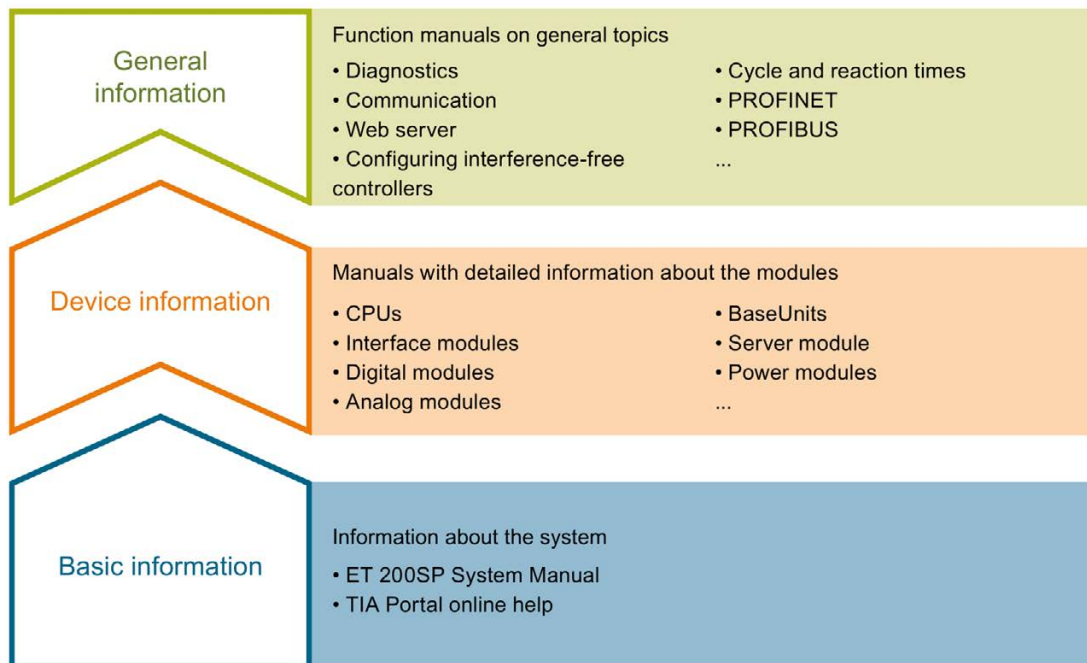

Basic information

The system manual describes in detail the configuration, installation, wiring and commissioning of the SIMATIC ET 200SP. distributed I/O system. The STEP 7 online help supports you in the configuration and programming.

Device information

Product manuals contain a compact description of the module-specific information, such as properties, terminal diagrams, characteristics and technical specifications.

General information

The function manuals contain detailed descriptions on general topics regarding the SIMATIC ET 200SP distributed I/O system, e.g. diagnostics, communication, Web server, designing interference-free controllers.

You can download the documentation free of charge from the Internet (<http://w3.siemens.com/mcms/industrial-automation-systems-simatic/en/manual-overview/tech-doc-et200/Pages/Default.aspx>).

Changes and supplements to the manuals are documented in a Product Information.

Manual Collection ET 200SP

The Manual Collection contains the complete documentation on the SIMATIC ET 200SP distributed I/O system gathered together in one file.

You can find the Manual Collection on the Internet (<http://support.automation.siemens.com/WW/view/en/84133942>).

My Documentation Manager

The My Documentation Manager is used to combine entire manuals or only parts of these to your own manual.

You can export the manual as PDF file or in a format that can be edited later.

You can find the My Documentation Manager on the Internet (<http://support.automation.siemens.com/WW/view/en/38715968>).

Applications & Tools

Applications & Tools supports you with various tools and examples for solving your automation tasks. Solutions are shown in interplay with multiple components in the system - separated from the focus in individual products.

You can find Applications & Tools on the Internet (<http://support.automation.siemens.com/WW/view/en/20208582>).

CAx Download Manager

The CAx Download Manager is used to access the current product data for your CAx or CAe systems.

You configure your own download package with a few clicks.

In doing so you can select:

- Product images, 2D dimension drawings, 3D models, internal circuit diagrams, EPLAN macro files
- Manuals, characteristics, operating manuals, certificates
- Product master data

You can find the CAx Download Manager on the Internet (<http://support.automation.siemens.com/WW/view/en/42455541>).

TIA Selection Tool

With the TIA Selection Tool, you can select, configure and order devices for Totally Integrated Automation (TIA).

This tool is the successor of the SIMATIC Selection Tool and combines the known configurators for automation technology into one tool.

With the TIA Selection Tool, you can generate a complete order list from your product selection or product configuration.

You can find the TIA Selection Tool on the Internet (<http://w3.siemens.com/mcmts/topics/en/simatic/tia-selection-tool>).

Product overview

2.1 Operating principle

The CPU includes the operating system and executes the user program. The user program is located on the SIMATIC memory card and is processed in the CPU work memory.

The PROFINET interfaces available on the CPU enable simultaneous communication with PROFINET devices, PROFINET controllers, HMI devices, programming devices, other controllers and additional systems. The CPU 1512SP-1 PN supports operation as an IO controller, I-device or standalone CPU.

With its optional PROFIBUS interface, CM DP, CPU 1512SP-1 PN supports the configuration of PROFIBUS networks in addition to PROFINET IO. When you use the interface as a PROFIBUS DP interface, you can configure the CPU 1512SP-1 PN as a DP master or as an intelligent DP slave (I-slave).

IO controller

CPU 1512SP-1 PN sends and receives data from the connected IO devices within a PROFINET IO system. You can operate the CPU with a maximum of 128 connected IO devices, a maximum of 64 of which use IRT (Isochronous Realtime).

I-device

The "I-device" (intelligent IO device) functionality allows you to exchange data with an IO controller. CPU 1512SP-1 PN thus fulfills the role of an intelligent distributed pre-processing unit for sub-processes. The I-device is connected as an IO device to a higher-level IO controller for this purpose.

Advantages:

- Interference-resistant configuration due to short signal and encoder wiring
- Reduced wiring requirements for transmission of the data via PROFINET

Standalone CPU

You can also use the CPU 1512SP-1 PN in the ET 200SP distributed I/O system as a "central system" without a higher-level controller.

DP master

To use the ET 200SP as a DP master, you need the CPU and the optional communication module, CM DP. When used as a DP master, ET 200SP exchanges data with the connected DP slaves via PROFIBUS DP.

Intelligent DP slave (I-slave)

To use the ET 200SP as an intelligent DP slave (I-slave), you need the CPU and the optional communication module, CM DP. As an I-slave, ET 200SP is connected via PROFIBUS DP to the higher-level DP master and exchanges data with it.

2.2 Properties

Article number

6ES7512-1DK00-0AB0

View of the module

The figure below shows the CPU 1512SP-1 PN.

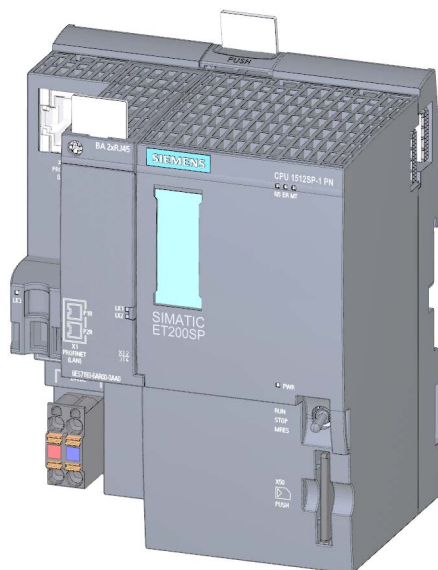

Figure 2-1 CPU 1512SP-1 PN

Properties

The CPU 1512SP-1 PN has the following technical properties:

- Communication:

- Interfaces

The CPU 1512SP-1 PN has a PROFINET interface (X1) with an integrated 3-port switch. Port 1 and port 2 are located on the pluggable BusAdapter. Port 3 is integrated in the housing of the CPU. The CPU supports the BusAdapters BA 2xRJ45 and BA 2xFC. You connect the PROFINET IO to the CPU via the BusAdapter. Port 1 and port 2 can also be used as ring ports for the configuration of redundant ring structures in Ethernet (media redundancy).

Note

The CPU is delivered without a BusAdapter. You can find the article numbers of the supported BusAdapters in the "Accessories/spare parts" section of the Distributed automation system ET 200SP

(<http://support.automation.siemens.com/WW/view/en/58649293>) system manual.

The PROFINET interface supports PROFINET IO RT (Realtime) and IRT (Isochronous Realtime) in addition to PROFINET basic functionality. PROFINET IO communication or real-time settings can be configured on the interface.

The CM DP is optionally available with a PROFIBUS interface (X2). You can find more information about this expansion module in the manual CM DP communication module (<http://support.automation.siemens.com/WW/view/en/90156526>).

You can find information about connecting the PROFINET IO BusAdapter to the CPU as well as connecting the optional PROFIBUS interface to the interface module in the system manual ET 200SP distributed I/O system (<http://support.automation.siemens.com/WW/view/en/58649293>).

- Integrated Web server:

The CPU is accessible via an integrated Web server for diagnostic purposes. You can read the following information with the Web server:

- Start page with general CPU information
 - Identification information
 - Contents of the diagnostics buffer
 - Query of module states
 - Alarms (without acknowledgment option)
 - Information about communication
 - PROFINET topology
 - Tag status
 - Watch tables
 - Memory usage
 - Data logs (if used)

- Integrated technology:
 - Motion Control
PLC-Open blocks for programming motion functionality via PROFINET IO IRT with PROFIdrive interface.
The functionality supports speed-controlled axes, positioning axes, synchronous axes and external encoders.
 - Integrated closed-loop control functionality
 - Universal PID controller and 3-point controller with integrated tuning
 - Integrated temperature controller
- Trace functionality:
 - Trace functionality supports you in troubleshooting and optimizing the user program, especially for motion control or closed-loop control applications.
- Integrated system diagnostics:
 - The alarms for the system diagnostics are automatically created by the system and displayed on a PG/PC, HMI device or the Web server. System diagnostics information is also available when the CPU is in STOP mode.
- Integrated security:
 - Know-how protection
The assignment of passwords protects user blocks against unauthorized access and modifications.
 - Copy protection
Copy protection links user blocks to the serial number of the SIMATIC memory card or to the serial number of the CPU. User programs cannot run without the corresponding SIMATIC memory card or CPU.
 - Access protection
Extended access protection provides high-quality protection against unauthorized configuration changes. You can use authorization levels to assign separate rights to different user groups.
 - Integrity protection
The system protects the data transferred to the CPU against manipulation. The CPU detects erroneous or manipulated engineering data.

You can find additional information on the topic of "Protection" in the system manual ET 200SP distributed I/O system (<http://support.automation.siemens.com/WW/view/en/58649293>).
- The CPU 1512SP-1 PN supports the following additional functions:
 - Firmware update
 - PROFIenergy
 - Shared device
 - Configuration control
 - Isochronous mode

2.3 Operating and display elements

2.3.1 Front view of the module with BusAdapter

The figure on the left shows the CPU 1512SP-1 PN including a plugged BA 2xRJ45 BusAdapter. The figure on the right shows a separate view of the BA 2xRJ45 BusAdapter.

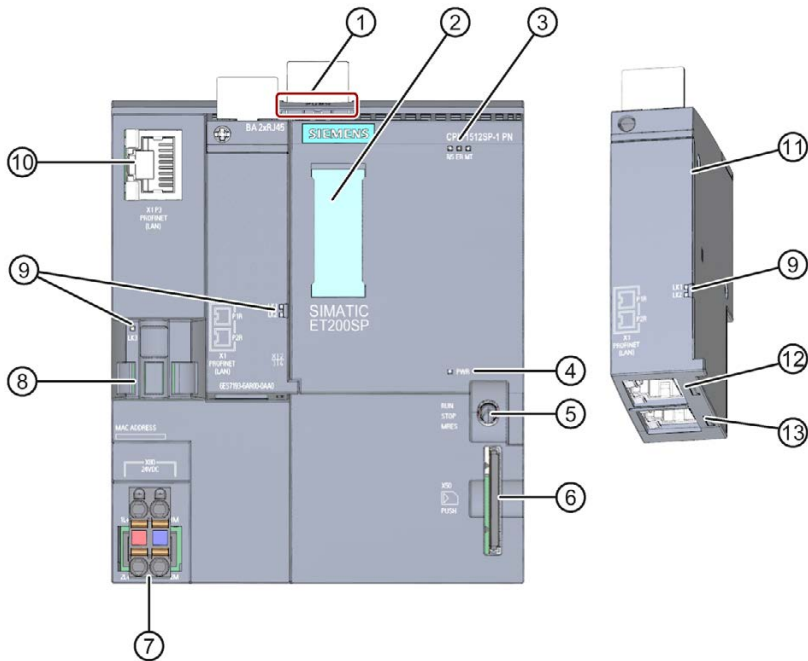

- ① Mounting rail release
- ② Labeling strips
- ③ LEDs for status and error displays
- ④ LED for display of the supply voltage
- ⑤ Mode switch
- ⑥ Slot for the SIMATIC memory card
- ⑦ Connection for supply voltage (included in product package)
- ⑧ Cable support and attachment for port P3 of the PROFINET interface
- ⑨ LEDs for status displays of the PROFINET interface: LK1 and LK2 on BusAdapter, LK3 on CPU
- ⑩ Port P3 of the PROFINET interface: RJ45 socket
- ⑪ Separate view of the BusAdapter
- ⑫ Port P1 R of the PROFINET interface: RJ45 socket on BusAdapter BA 2xRJ45
R: Ring port for configuring a ring topology with media redundancy
- ⑬ Port P2 R of the PROFINET interface: RJ45 socket on BusAdapter BA 2xRJ45
R: Ring port for configuring a ring topology with media redundancy

Figure 2-2 Front view of the CPU 1512SP-1 PN with BusAdapter

2.4 Mode switch

Use the mode switch to set the CPU operating mode.

The following table shows the position of the switch and the corresponding meaning.

Table 2- 1 Mode switch settings

| Position | Meaning | Explanation |
|----------|--------------|---|
| RUN | RUN mode | The CPU is executing the user program. |
| STOP | STOP mode | The user program is not being executed. |
| MRES | Memory reset | Position for CPU memory reset. |

2.5 Functions

2.5.1 PROFINET IO

PROFINET is a fieldbus standard of the PROFIBUS user organization that defines a cross-vendor communications and engineering model.

As part of PROFINET, PROFINET IO is a communication concept that is used to implement modular, distributed applications. PROFINET IO IRT allows defined response times and highly precise plant behavior.

A PROFINET IO system consists of the following PROFINET devices:

- IO controller
Device used to address the connected IO devices.
- IO device
A distributed field device that is assigned to an IO controller.

The PROFINET IO controller operating mode allows direct access to IO devices via Industrial Ethernet (for example from an S7-1500 CPU as IO controller to a CPU 1512SP-1 PN as IO device).

With the PROFINET IO device operating mode, you can operate the CPU 1512SP-1 PN as an "intelligent" PROFINET IO device on Industrial Ethernet.

Note

The BusAdapter BA 2xRJ45 (6ES7193-6AR00-0AA) or BusAdapter BA 2xFC (6ES7193-6AF00-0AA0) is required for standard-compliant operation of the CPU 1512SP-1 PN (6ES7512-1DK00-0AB0) as PROFINET IO controller and PROFINET IO device.

General properties of PROFINET IO

PROFINET IO provides the following properties and functions:

- Real-time communication (RT)
- Isochronous real-time communication (IRT)
- Media redundancy
- Prioritized startup
- Device replacement without exchangeable medium
- I-device
- IO controller
- Shared device
- Isochronous mode

Reference

You can find additional information on the "PROFINET IO" topic in the STEP 7 online help and in the PROFINET System Description (<http://support.automation.siemens.com/WW/view/en/19292127>) manual.

2.5.2 PROFIenergy

PROFIenergy

PROFIenergy is a PROFINET-based data interface for switching off consumers centrally and with full coordination during pause times regardless of the manufacturer or device type. Through this, the process should only be provided with the energy that is absolutely required. The majority of the energy is saved by the process; the PROFINET device itself only contributes a few watts of savings potential.

Additional information

- See the PROFINET (<http://support.automation.siemens.com/WW/view/en/68039307>) function manual
- You will find more information on PROFIenergy in the PROFINET specification on the Internet (<http://www.profibus.com>).

2.5.3 PROFIBUS DP

With its optional PROFIBUS interface, CM DP, CPU 1512SP-1 PN supports the configuration of PROFIBUS networks in addition to PROFINET IO.

PROFIBUS is the fieldbus network for the cell and field level. Physically, PROFIBUS is an electrical network based on a shielded two-wire cable or an optical network based on a fiber optic cable.

Data transfer via PROFIBUS DP provides a standardized interface (EN 50170 Vol. 2) for the transfer of process input and process output data between a DP master and field devices (DP slaves).

The transmission behavior via PROFIBUS DP is characterized by cyclical data exchange between the DP master and the DP slaves.

A DP system based on the PROFIBUS DP standard (IEC 61158 Type 3) consists of the following devices:

- DP master

A device of this function class handles the actual control task.

The device sends and receives process input and process output signals.

- DP slave

This is a device in the field area which reads or outputs the process signals. The devices can be modular or compact.

Using the optional CM DP module, the CPU 1512SP-1 PN can be configured as a DP master or as an intelligent DP slave (I-slave). The DP interface enables a transmission rate of up to 12 Mbps.

When in master mode, the CPU sends its configured bus parameters on the PROFIBUS DP interface. This means, for example, that a programming device can obtain the correct parameters so that you can go online with the PG without any further settings. Transmission of the bus parameters can be activated/deactivated in the configuration. As default, the CPU sends the bus parameters.

Properties of the PROFIBUS DP interface of the CM DP module

The PROFIBUS DP interface of the optional CM DP module has the following properties and functions:

- PROFIBUS DP master
- I-slave
- Time-of-day synchronization
- Line diagnostics
- S7 services

Reference

You will find additional information on "PROFIBUS DP" in the STEP 7 online help and in the PROFIBUS with STEP 7 (<http://support.automation.siemens.com/WWW/view/en/59193579>) function manual.

2.5.4 Memory reset

Apart from a few exceptions, a "memory reset" involves clearing all internal memories and then reading in the data on the SIMATIC memory card.

Options

You have the following options for resetting the memory of the CPU:

- Using the mode selector
- Using STEP 7

Procedure using the mode selector

To perform a memory reset of the CPU using the mode selector, follow these steps:

1. Set the mode selector to STOP.
Result: The RUN/STOP LED lights up yellow.
2. Set the mode selector to the MRES position. Hold the switch in this position until the RUN/STOP LED lights up yellow for the 2nd time and remains lit (this takes three seconds). After this, release the switch.
3. Within the next three seconds, return the mode selector to the MRES position, and then back to STOP.

Result: The CPU performs a memory reset. During the memory reset, the RUN/STOP LED flashes yellow. The RUN/STOP LED lights yellow when the CPU has completed the memory reset.

Procedure using STEP 7

To perform a memory reset of the CPU via STEP 7, follow these steps:

1. Open the "Online tools" task card of the CPU.
2. Click the "MRES" button in the "CPU operator panel" pane.
3. Click "OK" to confirm the security prompt.

Result: The CPU is in STOP mode and performs a memory reset.

Response of the memory objects to the memory reset

The following table provides an overview of which memory objects are retained and which are initialized in the case of a memory reset.

Table 2- 2 Retentive characteristics of the memory objects

| Memory object | Contents |
|--|-------------|
| Actual values of the data blocks, instance data blocks | Initialized |
| Bit memories, timers and counters | Initialized |
| Retentive tags of technology objects (for example, calibration values of absolute encoders)* | Retained |
| Diagnostics buffer entries (retentive area) | Retained |
| Diagnostics buffer entries (non-retentive area) | Initialized |
| IP address | Retained |
| Counter readings of the operating hours counters | Retained |
| Time | Retained |

* The retentive tags of technology objects are retained, but the contents of certain tags are partially re-initialized.

Reference

You can find additional information on the topic of "Memory reset" in the system manual ET 200SP distributed I/O system (<http://support.automation.siemens.com/WW/view/en/58649293>).

2.5.5 Restoring the factory settings of the CPU

The CPU can be reset to its factory state using "Reset to factory settings". The function deletes all information that was stored internally on the CPU.

Note

If you want to remove a PROFINET CPU and use it elsewhere with a different program or put it into storage, we recommend that you reset the CPU to its factory settings. Remember that the Reset to factory settings function also deletes the IP address parameters.

Options

You have the following options for returning the CPU to the factory settings:

- Using the mode selector
- Using STEP 7

Procedure using the mode selector

Make sure that there is no SIMATIC memory card in the CPU and that the CPU is in STOP mode (RUN/STOP LED lights up yellow).

Reset to the factory settings as follows:

1. Set the mode selector to STOP.

Intermediate result: The RUN/STOP LED lights up yellow.

2. Set the mode selector to the MRES position. Hold the mode selector in this position until the RUN/STOP LED lights up yellow for the 2nd time and remains lit (this takes three seconds). After this, release the switch.
3. Within the next three seconds, return the mode selector to the MRES position, and then back to STOP.

Result: The CPU executes a reset to factory settings, during which time the RUN/STOP LED flashes yellow. The RUN/STOP LED lit yellow indicates that the CPU has been reset to the factory settings and is in STOP mode. The "Reset to factory settings" event is entered in the diagnostics buffer.

Procedure using STEP 7

Make sure that there is an online connection to the CPU.

1. Open the online and diagnostics view of the CPU.
2. In the "Functions" folder, select the "Reset to factory settings" group.
3. Select the option button "Retain IP address" if you want to keep the IP address. Select the option button "Delete IP address" if you want to delete the IP address.
4. Click "Reset".
5. Click "OK" to confirm the security prompt.

Result: The CPU goes into STOP mode and is reset to factory settings.

Behavior of the memory objects with a reset to factory settings

The properties of the CPU are set to the following values:

Table 2- 3 Properties of CPU objects in the factory settings

| Memory object | Contents |
|--|---|
| Actual values of the data blocks, instance data blocks | Initialized |
| Bit memories, timers and counters | Initialized |
| Certain retentive tags of technology objects (for example, calibration values of absolute encoders) | Initialized |
| Diagnostics buffer entries (retentive area) | Initialized |
| Diagnostics buffer entries (non-retentive area) | Initialized |
| IP address | Depending on the procedure: <ul style="list-style-type: none"> Using the mode selector: it is deleted Using STEP 7: depends on the setting for the option boxes "Retain IP address"/"Delete IP address" |
| Counter readings of the operating hours counters | Initialized |
| Time | Initialized |

Reference

You can find additional information on the topic of "Reset to factory settings" in the system manual ET 200SP distributed I/O system (<http://support.automation.siemens.com/WW/view/en/58649293>) and in the online help for STEP 7.

This section provides information on the pin assignment of the individual interfaces and the block diagram of the CPU 1512SP-1 PN.

24 V DC supply voltage (X80)

The connector for the supply voltage is plugged in when the CPU ships from the factory.

The following figure shows the pin assignment for a 24 V DC supply voltage.

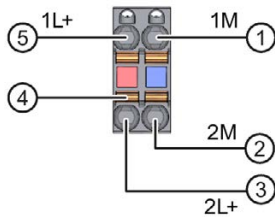

- ① Ground of the supply voltage
- ② Ground of the supply voltage for loop-through (permitted value 10 A)
- ③ + 24 V DC of the supply voltage for loop-through (permitted value 10 A)
- ④ Spring NC contacts
- ⑤ + 24 V DC of the supply voltage

Internally jumpered:

- ① and ②
- ③ and ⑤

Figure 3-1 Supply voltage connection

PROFINET IO interface on the CPU (X1 P3)

The table below shows the pin assignment of the PROFINET IO interface integrated in the CPU. The assignment corresponds to the Ethernet standard for an RJ45 plug.

Table 3- 1 Pin assignment PROFINET IO interface on the CPU

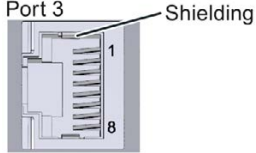
| View | Signal name | | Designation |
|---|-------------|------|-----------------|
|  | 1 | TD | Transmit data + |
| | 2 | TD_N | Transmit data - |
| | 3 | RD | Receive data + |
| | 4 | GND | Ground |
| | 5 | GND | Ground |
| | 6 | RD_N | Receive data - |
| | 7 | GND | Ground |
| | 8 | GND | Ground |

PROFINET IO interface on the BA 2xRJ45 BusAdapter (X1 P1 R and X1 P2 R)

The table below shows the pin assignment of the PROFINET IO interface on the BA 2xRJ45 BusAdapter. The assignment corresponds to the Ethernet standard for an RJ45 plug.

Table 3- 2 Pin assignment PROFINET IO interface on the BA 2xRJ45 BusAdapter

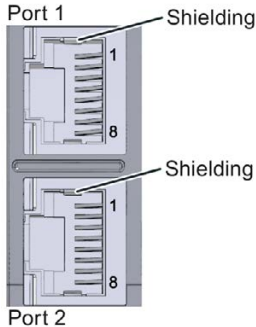
| View | Signal name | | Designation |
|---|-------------|------|-----------------|
|  | 1 | TD | Transmit data + |
| | 2 | TD_N | Transmit data - |
| | 3 | RD | Receive data + |
| | 4 | GND | Ground |
| | 5 | GND | Ground |
| | 6 | RD_N | Receive data - |
| | 7 | GND | Ground |
| | 8 | GND | Ground |

PROFINET IO interface on the BA 2xFC BusAdapter (X1 P1 R and X1 P2 R)

The table below shows the pin assignment of the PROFINET IO interface on the BA 2xFC BusAdapter.

Table 3- 3 Pin assignment PROFINET IO interface on the BA 2xFC BusAdapter

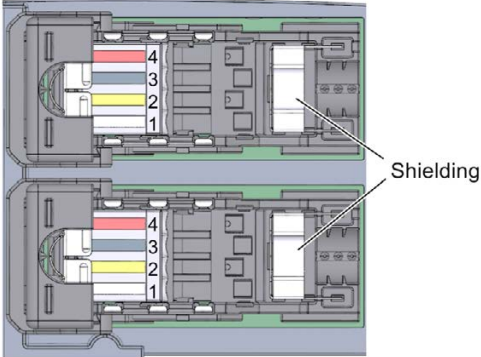
| View | Signal name | | Designation |
|--|-------------|------|-----------------|
|  <p>Port 1</p> <p>Port 2</p> <p>Shielding</p> | 1 | TD | Transmit data + |
| | 2 | TD_N | Transmit data - |
| | 3 | RD | Receive data + |
| | 4 | RD_N | Receive data - |

Reference

You can find additional information on the topics of "Connecting the CPU" and "Accessories/spare parts" in the system manual ET 200SP distributed I/O system (<http://support.automation.siemens.com/WW/view/en/58649293>).

Assignment of the MAC addresses

The MAC address is a globally unique device identifier that is assigned to each PROFINET device in the factory. Its 6 bytes are divided into 3 bytes for the manufacturer ID and 3 bytes for the device ID (serial number). The front of the CPU 1512SP-1 PN is lasered with the MAC address of the PROFINET interface.

The PROFINET interface (X1) of the CPU 1512SP-1 PN has three ports. Port 3 is located on the CPU. Ports 1 and 2 are located on the optional BusAdapter. In addition to the PROFINET interface, each PROFINET port also has a separate MAC address. There is therefore a total of four MAC addresses for the CPU 1512SP-1 PN.

The MAC addresses of the PROFINET ports are needed for the LLDP protocol, for example for the neighborhood discovery function.

The table below shows how the MAC addresses are assigned.

Table 3- 4 Assignment of the MAC addresses

| | Assignment |
|----------------------|---|
| MAC address 1 | PROFINET interface X1 <ul style="list-style-type: none"> • Visible in STEP 7 for accessible devices • Lasered on the front of the CPU (start of the number range) |
| MAC address 2 | Port X1 P1 R (required for LLDP, for example) |
| MAC address 3 | Port X1 P2 R (required for LLDP, for example) |
| MAC address 4 | Port X1 P3 (required for LLDP, for example) |

Block diagram

The following figure shows the block diagram of the CPU 1512SP-1 PN.

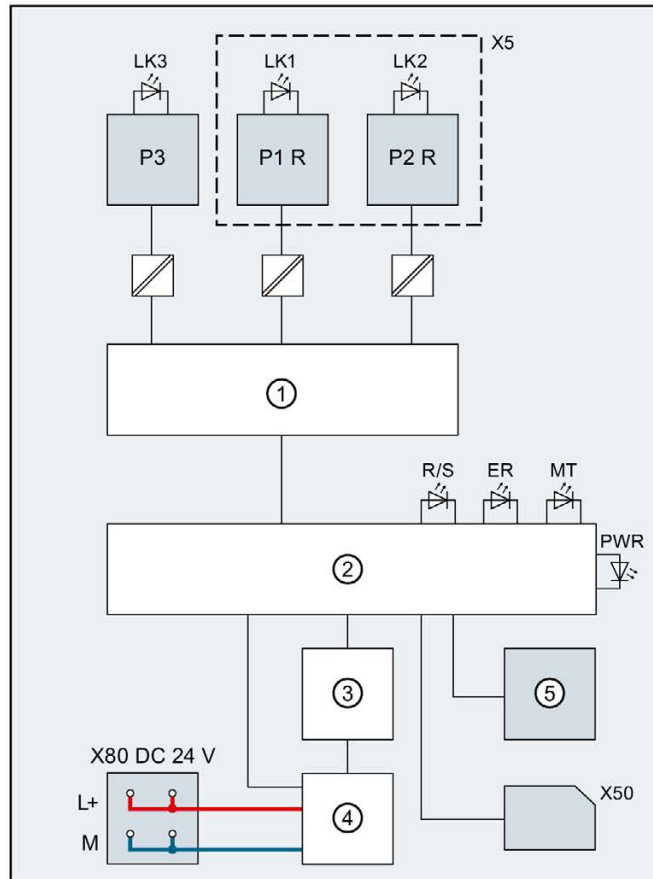

| | | | |
|-------------|-----------------------------|-----------|------------------------------|
| ① | Switch | P1 R | PROFINET interface X1 Port 1 |
| ② | Electronics | P2 R | PROFINET interface X1 Port 2 |
| ③ | Backplane bus interface | P3 | PROFINET interface X1 Port 3 |
| ④ | Internal supply voltage | L+ | 24 V DC supply voltage |
| ⑤ | RUN/STOP/MRES mode selector | M | Ground |
| X5 | BusAdapter | LK1, 2, 3 | LED Link TX/RX |
| X50 | SIMATIC memory card | R/S | RUN/STOP LED (yellow/green) |
| X80 24 V DC | Infeed of supply voltage | ER | ERROR LED (red) |
| | | MT | MAINT LED (yellow) |
| | | PWR | POWER LED (green) |

Figure 3-2 Block diagram of the CPU 1512SP-1 PN

Interrupts, error messages, diagnostics and system alarms

4

The status and error displays of the CPU 1512SP-1 PN are described below.

You will find additional information on "Interrupts" in the STEP 7 online help.

You can find additional information on the topics of "Diagnostics" and "System alarms" in the Diagnostics (<http://support.automation.siemens.com/WW/view/en/59192926>) function manual.

4.1 Status and error display of the CPU

LED displays

The figure below shows the LED displays of the CPU 1512SP-1 PN and the BA 2xRJ45 BusAdapter.

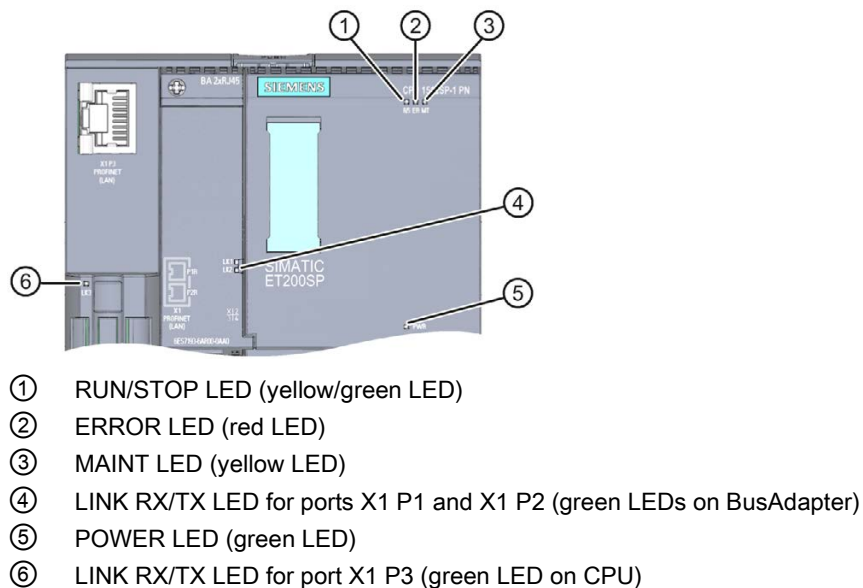

















































Figure 4-1 LED displays on the CPU and BusAdapter

4.1 Status and error display of the CPU

Meaning of the LED displays

CPU 1512SP-1 PN features an LED for monitoring the supply voltage of the electronics (PWR) and three LEDs for displaying the current operating and diagnostics status. The following table shows the meaning of the various combinations of colors for the POWER, RUN/STOP, ERROR and MAINT LEDs.



Table 4- 1 Meaning of the LEDs

| POWER LED | RUN/STOP LED | ERROR LED | MAINT LED | Meaning |
|--|---|--|---|--|
|  LED off |  LED off |  LED off |  LED off | Missing or insufficient supply voltage on the CPU. |
|  LED lit green |  LED off |  LED flashes red |  LED off | An error has occurred. |
|  LED lit green |  LED lit green |  LED off |  LED off | CPU is in RUN mode. |
|  LED lit green |  LED lit green |  LED flashes red |  LED off | A diagnostics event is pending. |
|  LED lit green |  LED lit green |  LED off |  LED lit yellow | Maintenance demanded for the plant. The affected hardware must be checked/replaced within a short period of time. |
| | | | | Active Force job |
| | | | | PROFlenergy pause |
|  LED lit green |  LED lit green |  LED off |  LED flashes yellow | Maintenance required for the plant. The affected hardware must be checked/replaced within a foreseeable period of time. |
| | | | | Bad configuration |
|  LED lit green |  LED lit yellow |  LED off |  LED flashes yellow | Firmware update successfully completed. |
|  LED lit green |  LED lit yellow |  LED off |  LED off | CPU is in STOP mode. |
|  LED lit green |  LED lit yellow |  LED flashes red |  LED flashes yellow | The program on the SIMATIC memory card is causing an error. |
| | | | | CPU defective |
|  LED lit green |  LED flashes yellow |  LED off |  LED off | CPU is performing internal activities during STOP, e.g. startup after STOP. |
| | | | | Download of the user program from the SIMATIC memory card |
|  LED lit green |  LED flashes yellow/green |  LED off |  LED off | Startup (transition from RUN → STOP) |
|  LED lit green |  LED flashes yellow/green |  LED flashes red |  LED flashes yellow | Startup (CPU booting) |
| | | | | Test of LEDs during startup, inserting a module. |
| | | | | LED flashing test |

Meaning of the LEDs of the interfaces: X1 P1 R, X1 P2 R and X1 P3

Each port has a LINK LED (LK1, LK2, LK3). The table below shows the various "LED scenarios" of the ports of the CPU 1512SP-1 PN.

Table 4- 2 Meaning of the LED

| LINK LED | Meaning |
|--|--|
|  LED off | There is no Ethernet connection between the PROFINET interface of the PROFINET device and the communication partner. No data is currently being sent/received via the PROFINET interface. There is no LINK connection. |
|  LED flashes green | The "LED flashing test" is being performed. |
|  LED lit green | There is an Ethernet connection between the PROFINET interface of your PROFINET device and a communication partner. |

Technical specifications

| | 6ES7512-1DK00-0AB0 |
|--|-----------------------|
| Product type designation | CPU 1512SP-1 PN |
| General information | |
| Hardware version | FS02 |
| Firmware version | V1.7 |
| Engineering with | |
| STEP 7 TIA Portal can be configured/integrated as of version | V13 SP1 |
| Configuration control | |
| via data record | Yes |
| Operator controls | |
| Mode selector | 1 |
| Supply voltage | |
| Type of supply voltage | 24 V DC |
| Low limit of permitted range (DC) | 19.2 V |
| High limit of permitted range (DC) | 28.8 V |
| Reverse polarity protection | Yes |
| Power and voltage failure backup | |
| Power/voltage failure backup time | 5 ms |
| Input current | |
| Current consumption (rated value) | 0.6 A |
| Inrush current, max. | 4.7 A; rated value |
| I^2t | 0.14 A ² s |
| Power | |
| Incoming power to the backplane bus | 8.75 W |
| Power loss | |
| Power loss, typ. | 5.6 W |
| Memory | |
| Number of slots for SIMATIC memory card | 1 |
| SIMATIC memory card required | Yes |
| Work memory | |
| Integrated (for program) | 200 KB |
| Integrated (for data) | 1 MB |
| Load memory | |
| Plug-in (SIMATIC memory card), max. | 32 GB |
| Buffering | |
| Maintenance-free | Yes |

| 6ES7512-1DK00-0AB0 | |
|--|--|
| CPU processing time | |
| For bit operations, typ. | 48 ns |
| For word operations, typ. | 58 ns |
| For fixed-point arithmetic, typ. | 77 ns |
| For floating-point arithmetic, typ. | 307 ns |
| CPU blocks | |
| Number of elements (total) | 2000; an element can be taken to mean blocks such as DBs, FBs and FCs, as well as UDTs, global constants, etc. |
| DB | |
| Number range | 1 to 65535 |
| Size, max. | 1 MB; for absolutely addressed DBs, the max. size is 64 KB |
| FB | |
| Number range | 1 to 65535 |
| Size, max. | 200 KB |
| FC | |
| Number range | 1 to 65535 |
| Size, max. | 200 KB |
| OB | |
| Size, max. | 200 KB |
| Number of free-cycle OBs | 100 |
| Number of time-of-day interrupt OBs | 20 |
| Number of time-delay interrupt OBs | 20 |
| Number of cyclic interrupt OBs | 20 |
| Number of hardware interrupt OBs | 50 |
| Number of DPV1 interrupt OBs | 3 |
| Number of isochronous mode OBs | 1 |
| Number of technology synchronous interrupt OBs | 2 |
| Number of restart OBs | 100 |
| Number of asynchronous error OBs | 4 |
| Number of synchronous error OBs | 2 |
| Number of diagnostic interrupt OBs | 1 |
| Nesting depth | |
| Per priority class | 24 |
| Timers/counters and their retentivity | |
| S7 counters | |
| Quantity | 2048 |
| Retentivity | Yes |
| • Adjustable | Yes |

| | 6ES7512-1DK00-0AB0 |
|--|---|
| IEC counters | |
| Quantity | Unlimited (limited only by work memory) |
| Retentivity | |
| • Adjustable | Yes |
| S7 timers | |
| Quantity | 2048 |
| Retentivity | |
| • Adjustable | Yes |
| IEC timers | |
| Quantity | Unlimited (limited only by work memory) |
| Retentivity | |
| • Adjustable | Yes |
| Data areas and their retentivity | |
| Total retentive data area (including timers, counters, bit memories), max. | 128 KB; for bit memories, timers, counters, DBs and technological data (axes), usable retentive memory: 88 KB |
| Bit memory | |
| Number, max. | 16 KB |
| Number of clock memory bits | 8; 8 clock memory bits, grouped in one clock memory byte |
| Data blocks | |
| Retentivity adjustable | Yes |
| Retentivity preset | No |
| Local data | |
| Per priority class, max. | 64 KB max. 16 KB per block |
| Address area | |
| Number of I/O modules | 2048; max. number of modules/submodules |
| I/O address area | |
| Inputs | 32 KB; all inputs are in the process image |
| Outputs | 32 KB; all outputs are in the process image |
| Of which per integrated IO subsystem | |
| • Inputs (volume) | 8 KB |
| • Outputs (volume) | 8 KB |
| Of which per CM/CP | |
| • Inputs (volume) | 8 KB |
| • Outputs (volume) | 8 KB |
| Process image partitions | |
| Number of process image partitions, max. | 32 |
| Hardware configuration | |
| Number of hierarchical IO systems | 20 |
| Number of DP masters | |
| Via CM | 1 |

| 6ES7512-1DK00-0AB0 | |
|------------------------------------|--|
| Number of IO controllers | |
| Integrated | 1 |
| Via CM | 0 |
| Rack | |
| Modules per rack, max. | 64; CPU + 64 modules + server module (configuration width max. 1 m) |
| Rack, number of rows, max. | 1 |
| PtP CM | |
| Number of PtP CMs | The number of PtP CMs you can connect is only limited by the available slots |
| Time | |
| Clock | |
| Type | Hardware clock |
| Deviation per day, max. | 10 s; typ.: 2 s |
| Buffered period | 6 wk; at 40 °C ambient temperature, typ. |
| Operating hours counter | |
| Quantity | 16 |
| Time-of-day synchronization | |
| Supported | Yes |
| On DP, master | Yes; via CM DP module |
| On DP, slave | Yes; via CM DP module |
| In AS, master | Yes |
| In AS, slave | Yes |
| On Ethernet via NTP | Yes |
| Interfaces | |
| Number of PROFINET interfaces | 1 |
| Number of PROFIBUS interfaces | 1; via CM DP module |
| 1. interface | |
| Interface hardware | |
| • Number of ports | 3; 1. Integr. + 2. via BusAdapter |
| • Integrated switch | Yes |
| • RJ45 (Ethernet) | Yes; X1 |
| Protocols | |
| • PROFINET IO controller | Yes |
| • PROFINET IO device | Yes |
| • SIMATIC communication | Yes |
| • Open IE communication | Yes |
| • Web server | Yes |
| • Media redundancy | Yes |

| 6ES7512-1DK00-0AB0 | |
|---|--|
| 2. interface | |
| Interface hardware | |
| • Number of ports | 1 |
| • RS 485 | Yes; via CM DP module |
| Protocols | |
| • SIMATIC communication | Yes |
| • PROFIBUS DP master | Yes |
| • PROFIBUS DP slave | Yes |
| Interface hardware | |
| RJ45 (Ethernet) | |
| 100 Mbps | Yes |
| Autonegotiation | Yes |
| Autocrossing | Yes |
| Industrial Ethernet status LED | Yes |
| RS 485 | |
| Transmission rate, max. | 12 Mbps |
| Protocols | |
| Number of connections | |
| Number of connections, max. | 88 |
| Number of connections reserved for ES/HMI/Web | 10 |
| Number of connections via integrated interfaces | 88 |
| Number of S7 routing connections | 16 |
| PROFINET IO controller | |
| Services | |
| • PG/OP communication | Yes |
| • S7 routing | Yes |
| • Isochronous mode | Yes |
| • Open IE communication | Yes |
| • IRT | Yes |
| • MRP | Yes; as MRP redundancy manager and/or MRP client; max. number of devices in the ring: 50 |
| • PROFINergy | Yes |
| • Prioritized startup | Yes; max. 32 PROFINET devices |
| • Number of connectable IO devices, max. | 128; a maximum of 253 distributed I/O devices in total can be connected by means of PROFIBUS or PROFINET |
| • Number of IO devices with IRT and the "high performance" option, max. | 64 |
| • Number of IO devices that you can connect for RT, max. | 128 |

| | 6ES7512-1DK00-0AB0 |
|---|--|
| <ul style="list-style-type: none"> • Of which are in line, max. | 128 |
| <ul style="list-style-type: none"> • Number of IO devices that can be activated/deactivated simultaneously, max. | 8 |
| <ul style="list-style-type: none"> • Number of IO devices per tool changeover, max. | 8 |
| <ul style="list-style-type: none"> • Update times | The minimum value of the update time also depends on the communication portion set for PROFINET IO, on the number of IO devices, and on the quantity of configured user data |
| With RT | |
| <ul style="list-style-type: none"> • With send clock of 250 μs | 250 μ s to 128 ms |
| <ul style="list-style-type: none"> • With send clock of 500 μs | 500 μ s to 256 ms |
| <ul style="list-style-type: none"> • With send clock of 1 ms | 1 ms to 512 ms |
| <ul style="list-style-type: none"> • With send clock of 2 ms | 2 ms to 512 ms |
| <ul style="list-style-type: none"> • With send clock of 4 ms | 4 ms to 512 ms |
| With IRT and the "high performance" option | |
| <ul style="list-style-type: none"> • With send clock of 250 μs | 250 μ s to 4 ms |
| <ul style="list-style-type: none"> • With send clock of 500 μs | 500 μ s to 8 ms |
| <ul style="list-style-type: none"> • With send clock of 1 ms | 1 ms to 16 ms |
| <ul style="list-style-type: none"> • With send clock of 2 ms | 2 ms to 32 ms |
| <ul style="list-style-type: none"> • With send clock of 4 ms | 4 ms to 64 ms |
| <ul style="list-style-type: none"> • With IRT with the "high performance" option and parameter assignment for so-called "uneven" send clocks | Update time = set "uneven" send clock (any multiple of 125 μ s: 375 μ s, 625 μ s to 3.875 μ s) |
| PROFINET IO device | |
| Services | |
| <ul style="list-style-type: none"> • PG/OP communication | Yes |
| <ul style="list-style-type: none"> • S7 routing | Yes |
| <ul style="list-style-type: none"> • Isochronous mode | No |
| <ul style="list-style-type: none"> • Open IE communication | Yes |
| <ul style="list-style-type: none"> • IRT, supported | Yes |
| <ul style="list-style-type: none"> • MRP, supported | Yes |
| <ul style="list-style-type: none"> • PROFIenergy | Yes |
| <ul style="list-style-type: none"> • Shared device | Yes |
| <ul style="list-style-type: none"> • Number of IO controllers with shared device, max. | 4 |

| | 6ES7512-1DK00-0AB0 |
|---|---|
| SIMATIC communication | |
| S7 communication, as server | Yes |
| S7 communication, as client | Yes |
| User data per job, max. | See online help (S7 communication, user data size) |
| Open IE communication | |
| TCP/IP | Yes |
| <ul style="list-style-type: none"> Data length, max. | 64 KB |
| <ul style="list-style-type: none"> Several passive connections per port, supported | Yes |
| ISO-on-TCP (RFC1006) | Yes |
| <ul style="list-style-type: none"> Data length, max. | 64 KB |
| UDP | Yes |
| <ul style="list-style-type: none"> Data length, max. | 1472 bytes |
| DHCP | No |
| SNMP | Yes |
| DGP | Yes |
| LLDP | Yes |
| Web server | |
| HTTP | Yes; standard and user-defined pages |
| HTTPS | Yes; standard and user-defined pages |
| PROFIBUS DP master | |
| Number of connections, max. | 48 |
| Services | |
| <ul style="list-style-type: none"> PG/OP communication | Yes |
| <ul style="list-style-type: none"> S7 routing | Yes |
| <ul style="list-style-type: none"> Data record routing | Yes |
| <ul style="list-style-type: none"> Isochronous mode | No |
| <ul style="list-style-type: none"> Constant bus cycle time | No |
| <ul style="list-style-type: none"> Number of DP slaves | 125 |
| <ul style="list-style-type: none"> Activation/deactivation of DP slaves | Yes |
| Further protocols | |
| MODBUS | Yes; MODBUS TCP |
| Media redundancy | |
| Switchover time on line interruption, typ. | 200 ms |
| Number of devices in the ring, max. | 50 |
| Isochronous mode | |
| Isochronous mode (application synchronized up to terminal) | Yes; only with PROFINET; with a minimum OB 6x cycle of 625 μs |

| 6ES7512-1DK00-0AB0 | |
|---|--|
| S7 signaling functions | |
| Number of stations that can be logged in for signaling functions, max. | 32 |
| Block-related alarms | Yes |
| Number of configurable interrupts, max. | 5000 |
| Number of simultaneously active interrupts in interrupt pool | |
| <ul style="list-style-type: none"> • Number of reserved user interrupts | 300 |
| <ul style="list-style-type: none"> • Number of reserved interrupts for system diagnostics | 100 |
| <ul style="list-style-type: none"> • Number of reserved interrupts for motion technology objects | 80 |
| Test/commissioning functions | |
| Joint commissioning (Team Engineering) | Yes; parallel online access possible for up to 3 engineering systems |
| Status block | Yes; up to 8 at the same time |
| Single-step | No |
| Status/modify | |
| Status/modify tag | Yes |
| Tags | Inputs, outputs, bit memories, DBs, timers, counters |
| Of which are status tags, max. | 200; per job |
| Of which are modify tags, max. | 200; per job |
| Force | |
| Force | Yes |
| Forcing, tags | Inputs, outputs |
| Number of tags, max. | 200 |
| Diagnostics buffer | |
| Available | Yes |
| No. of entries, max. | 1000 |
| <ul style="list-style-type: none"> • Of which are power failure-proof | 500 |
| Traces | |
| Number of configurable traces | 4; up to 512 KB data possible per trace |
| Interrupts/diagnostics/status information | |
| Diagnostic indicator LED | |
| RUN/STOP LED | Yes |
| ERROR LED | Yes |
| MAINT LED | Yes |
| Monitoring of the supply voltage (PWR LED) | Yes |
| Connection display LINK TX/RX | Yes |

| | 6ES7512-1DK00-0AB0 |
|--|---|
| Supported technology objects | |
| Motion | Yes |
| <ul style="list-style-type: none"> • Speed-controlled axis <ul style="list-style-type: none"> – Number of speed-controlled axes, max. | 6; max. number of speed-controlled axes (requirement: no other motion technology objects have been created) |
| <ul style="list-style-type: none"> • Positioning axis <ul style="list-style-type: none"> – Number of positioning axes, max. | 6; max. number of positioning axes (requirement: no other motion technology objects have been created) |
| <ul style="list-style-type: none"> • Synchronous axes (relative gearing) <ul style="list-style-type: none"> – Number of axes, max. | 3; max. number of synchronous axes (requirement: no other motion technology objects have been created) |
| <ul style="list-style-type: none"> • External encoders <ul style="list-style-type: none"> – Number of external encoders, max. | 6; max. number of external encoders (requirement: no other motion technology objects have been created) |
| Controller | |
| <ul style="list-style-type: none"> • PID_Compact | Yes; universal PID controller with integrated optimization |
| <ul style="list-style-type: none"> • PID_3Step | Yes; PID controller with integrated optimization for valves |
| <ul style="list-style-type: none"> • PID temp | Yes; PID controller with integrated optimization for temperature |
| Counting and measuring | |
| <ul style="list-style-type: none"> • High-speed counter | Yes |
| Standards, approvals, certificates | |
| Suitable for safety functions | No |
| Highest safety class achievable in safety mode | |
| Performance level according to EN ISO 13849-1:2008 | None |
| SIL according to IEC 61508:2010 | No |
| Ambient conditions | |
| Ambient temperature in operation | |
| Horizontal installation, min. | 0 °C |
| Horizontal installation, max. | 60 °C |
| Vertical installation, min. | 0 °C |
| Vertical installation, max. | 50 °C |
| Storage/transport temperature | |
| Min. | -40 °C |
| Max. | 70 °C |

| | 6ES7512-1DK00-0AB0 |
|---|-------------------------------|
| Configuring | |
| Programming | |
| Programming language | |
| • LAD | Yes |
| • FBD | Yes |
| • STL | Yes |
| • SCL | Yes |
| • GRAPH | Yes |
| Know-how protection | |
| User program protection | Yes |
| Copy protection | Yes |
| Block protection | Yes |
| Access protection | |
| Protection level: Write protection | Yes |
| Protection level: Read/write protection | Yes |
| Protection level: Complete protection | Yes |
| Cycle time monitoring | |
| Low limit | Adjustable minimum cycle time |
| High limit | Adjustable maximum cycle time |
| Dimensions | |
| Width | 100 mm |
| Height | 117 mm |
| Depth | 75 mm |
| Weights | |
| Weight, approx. | 310 g |

General technical specifications

You can find information on the general technical specifications, such as standards and approvals, electromagnetic compatibility, protection class, etc., in the system manual ET 200SP distributed I/O system

(<http://support.automation.siemens.com/WW/view/en/58649293>).

Dimension drawing

This section contains a dimension drawing of the module mounted on a mounting rail. Always observe the specified dimensions for installation in cabinets, control rooms, etc.

Dimension drawing of the CPU 1512SP-1 PN

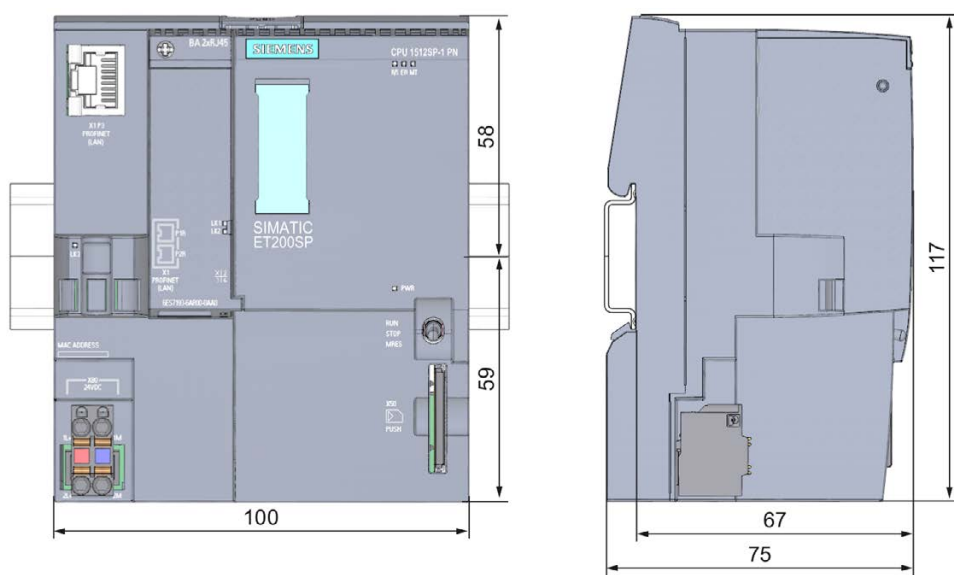

Figure A-1 Dimension drawing CPU 1512SP-1 PN