

SIEMENS

SENTRON



Power Monitoring Device SENTRON PAC3200

Manual

<u>Introduction</u>	1
<u>Safety instructions</u>	2
<u>Description</u>	3
<u>Operation planning</u>	4
<u>Installation</u>	5
<u>Connection</u>	6
<u>Startup</u>	7
<u>Operator control</u>	8
<u>Parameterize</u>	9
<u>Maintenance and servicing</u>	10
<u>Technical data</u>	11
<u>Dimension drawings</u>	12
<u>Appendix</u>	A
<u>ESD Guidelines</u>	B
<u>List of abbreviations</u>	C

Safety Guidelines

This manual contains notices you have to observe in order to ensure your personal safety, as well as to prevent damage to property. The notices referring to your personal safety are highlighted in the manual by a safety alert symbol, notices referring only to property damage have no safety alert symbol. These notices shown below are graded according to the degree of danger.

 DANGER
indicates that death or severe personal injury will result if proper precautions are not taken.
 WARNING
indicates that death or severe personal injury may result if proper precautions are not taken.
 CAUTION
with a safety alert symbol, indicates that minor personal injury can result if proper precautions are not taken.
CAUTION
without a safety alert symbol, indicates that property damage can result if proper precautions are not taken.
NOTICE
indicates that an unintended result or situation can occur if the corresponding information is not taken into account.

If more than one degree of danger is present, the warning notice representing the highest degree of danger will be used. A notice warning of injury to persons with a safety alert symbol may also include a warning relating to property damage.

Qualified Personnel

The device/system may only be set up and used in conjunction with this documentation. Commissioning and operation of a device/system may only be performed by **qualified personnel**. Within the context of the safety notes in this documentation qualified persons are defined as persons who are authorized to commission, ground and label devices, systems and circuits in accordance with established safety practices and standards.

Prescribed Usage

Note the following:

 WARNING
This device may only be used for the applications described in the catalog or the technical description and only in connection with devices or components from other manufacturers which have been approved or recommended by Siemens. Correct, reliable operation of the product requires proper transport, storage, positioning and assembly as well as careful operation and maintenance.

Trademarks

All names identified by ® are registered trademarks of the Siemens AG. The remaining trademarks in this publication may be trademarks whose use by third parties for their own purposes could violate the rights of the owner.

Disclaimer of Liability

We have reviewed the contents of this publication to ensure consistency with the hardware and software described. Since variance cannot be precluded entirely, we cannot guarantee full consistency. However, the information in this publication is reviewed regularly and any necessary corrections are included in subsequent editions.

Security information

Siemens provides products and solutions with industrial security functions that support the secure operation of plants, systems, machines and networks.

In order to protect plants, systems, machines and networks against cyber threats, it is necessary to implement – and continuously maintain – a holistic, state-of-the-art industrial security concept. Siemens' products and solutions only form one element of such a concept.

Customer is responsible to prevent unauthorized access to its plants, systems, machines and networks. Systems, machines and components should only be connected to the enterprise network or the internet if and to the extent necessary and with appropriate security measures (e.g. use of firewalls and network segmentation) in place.

Additionally, Siemens' guidance on appropriate security measures should be taken into account. For more information about industrial security, please visit <http://www.siemens.com/industrialsecurity>.

Siemens' products and solutions undergo continuous development to make them more secure. Siemens strongly recommends to apply product updates as soon as available and to always use the latest product versions. Use of product versions that are no longer supported, and failure to apply latest updates may increase customer's exposure to cyber threats.

To stay informed about product updates, subscribe to the Siemens Industrial Security RSS Feed under <http://www.siemens.com/industrialsecurity>.

Open Source Software

The product contains, among other things, Open Source Software developed by third parties. The Open Source Software used in the product and the license agreements concerning this software can be found in the `Readme_OSS`.

These Open Source Software files are protected by copyright. Your compliance with those license conditions will entitle you to use the Open Source Software as foreseen in the relevant license. In the event of conflicts between Siemens license conditions and the Open Source Software license conditions, the Open Source Software conditions shall prevail with respect to the Open Source Software portions of the software.

The Open Source Software is licensed royalty-free. Insofar as the applicable Open Source Software License Conditions provide for it you can order the source code of the Open Source Software by contacting the following address:

Siemens AG
Energie Management, Low Voltage & Products
Siemensstraße 10
93055 Regensburg
Germany

Internet: Technical Assistance (www.siemens.de/lowvoltage/support-request)

Keyword: Open Source Request (please specify Product name and version, if applicable)

- against payment of the shipping and handling charges - for a period of at least 3 years since purchase of the Product. We are liable for the Product including the Open Source Software contained in it pursuant to the license conditions applicable to the Product. Any liability for the Open Source Software beyond the program flow intended for the Product is explicitly excluded. Furthermore any liability for defects resulting from modifications to the Open Source Software by you or third parties is excluded. We do not provide any technical support for the Product if it has been modified.

Table of contents

1	Introduction	11
1.1	Purpose of this document	11
1.2	Orientation aids	12
1.3	Components of the product.....	12
1.4	Contents of the CD for the SENTRON PAC Power Monitoring Device.....	13
1.5	Technical support.....	13
1.6	Further documentation	15
2	Safety instructions	17
2.1	Safety notes	17
3	Description	19
3.1	Features	19
3.2	Measuring inputs.....	22
3.3	Measured variables.....	24
3.4	Power demands and counters	32
3.5	Tariffs	33
3.6	Limits.....	34
3.7	Behavior in the case of power failure and power restore	36
3.8	Digital inputs and outputs.....	36
3.9	Ethernet port	38
3.9.1	Ethernet.....	38
3.9.2	Modbus TCP	38
3.9.3	Modbus measured variables with the function codes 0x03 and 0x04	40
3.9.4	Structure - Digital input status and digital output status with the function codes 0x03 and 0x04	44
3.9.5	Structure - Device diagnostics and device status with the function codes 0x03 and 0x04	45
3.9.6	Structure - Limit values with function codes 0x03 and 0x04.....	45
3.9.7	Modbus status parameters with the function code 0x02	46
3.9.8	Modbus settings with the function codes 0x03, 0x04 and 0x10	47
3.9.9	MODBUS communication parameter with the function codes 0x03, 0x04 and 0x10	58
3.9.10	Modbus device information with the function codes 0x03, 0x04 and 0x10	59
3.9.11	Modbus command parameters	61
3.9.12	MODBUS standard device identification with the function code 0x2B	62
3.10	Slot for expansion modules.....	63
3.11	Slots on the rear of the device	64
4	Operation planning	65
4.1	Operation planning.....	65

5	Installation	67
5.1	Unpacking	67
5.2	Tools.....	68
5.3	Mounting dimensions	68
5.4	Installation steps	68
5.5	Deinstalling.....	72
6	Connection	73
6.1	Safety notes	73
6.2	Connections	75
6.3	Connecting the cables to the terminals.....	81
6.4	Connection examples.....	82
7	Startup.....	91
7.1	Overview	91
7.2	Applying the supply voltage	92
7.3	Parameterizing the device.....	93
7.4	LANGUAGE/REGIONAL.....	93
7.4.1	Setting the language	93
7.5	BASIC PARAMETERS.....	95
7.5.1	VOLTAGE INPUTS	95
7.5.1.1	Set the connection type.....	95
7.5.1.2	Measurement using voltage transformers.....	96
7.5.1.3	Setting the conversion ratio of the voltage transformer	97
7.5.1.4	Setting the voltage input.....	98
7.5.2	CURRENT INPUT	99
7.5.2.1	Setting the conversion ratio of the current transformer.....	99
7.6	Applying the measuring voltage.....	100
7.7	Applying the measuring current	101
7.8	Check the displayed measured values	102
8	Operator control.....	103
8.1	Device interface	103
8.1.1	Displays and operator controls	103
8.1.2	Display of the measured variables	110
8.1.3	Display of the "MAIN MENU"	113
8.1.4	Display of the "SETTINGS" menu.....	114
8.1.5	Display of the device settings	115
8.1.6	Edit mode of the device settings	116
8.2	Operator input steps.....	117
8.2.1	Operator input steps in the measured variable display.....	117
8.2.2	Operator input steps in the "MAIN MENU"	119
8.2.3	Operator input steps in the "SETTINGS" menu.....	120
8.2.4	Operator input steps in device settings display.....	121
8.2.5	Operator input steps in edit mode of the device settings.....	122

9	Parameterize	127
9.1	Introduction	127
9.2	Parameterizing the operator interface	128
9.2.1	Groups of settings	128
9.2.2	Device information	131
9.2.3	Language, regional settings	132
9.2.4	Basic parameters	133
9.2.5	Power demand	136
9.2.6	Integrated I/O	137
9.2.7	Communication	140
9.2.8	Display	141
9.2.9	Advanced	142
9.2.10	PAC PROFIBUS DP expansion module	149
9.2.11	PAC RS485 expansion module	150
9.2.12	Password management	150
9.2.12.1	Introduction	150
9.2.12.2	Calling password management	150
9.2.12.3	Switch on password protection	151
9.2.12.4	Switch off password protection	151
9.2.12.5	Change password	152
9.2.12.6	Password lost - what to do?	154
10	Maintenance and servicing	155
10.1	Cleaning	155
10.2	Repair	156
10.3	Disposal	156
11	Technical data	157
11.1	Technical data	157
11.2	Labeling	165
12	Dimension drawings	167
12.1	Dimension drawings	167
A	Appendix	171
A.1	Certification marks	171
A.2	Correction sheet	172
B	ESD Guidelines	173
B.1	Electrostatic sensitive devices (ESD)	173
C	List of abbreviations	175
C.1	Abbreviations	175
	Glossary	177
	Index	179

Tables

Table 1-1	Contacts in your region - worldwide	14
Table 1-2	Online service and support	14
Table 1-3	Technical Support	14
Table 3-1	Device versions	20
Table 3-2	Available connection types	23
Table 3-3	Measured variables	24
Table 3-4	Display of the measured variables depending on the connection type	26
Table 3-5	Available measured variables	28
Table 3-6	Available measured variables	40
Table 3-7	Structure - Status of the digital inputs and status of the digital outputs	44
Table 3-8	Modbus offset 205, tab 2: Structure device status and device diagnostics	45
Table 3-9	Modbus Offset 203, Register 2: Limit Violations	45
Table 3-10	Status parameters	46
Table 3-11	Settings parameters	47
Table 3-12	Settings parameter for the digital input	48
Table 3-13	Settings parameter for the digital output	48
Table 3-14	Settings parameter for language, phase labels and universal counters source	49
Table 3-15	Settings parameter for the display	49
Table 3-16	Settings parameter for limit value 0	50
Table 3-17	Settings parameter for limit value 1	51
Table 3-18	Settings parameter for limit value 2	52
Table 3-19	Settings parameter for limit value 3	53
Table 3-20	Settings parameter for limit value 4	55
Table 3-21	Settings parameter for limit value 5	56
Table 3-22	Communication parameters	58
Table 3-23	I&M 0 parameter of the SENTRON PAC Power Monitoring Device with the function codes 0x03 and 0x04	59
Table 3-24	I&M 1-4 parameters with the function codes 0x03, 0x04 and 0x10	60
Table 3-25	I&M 0 parameter of the module in slot 1 with the function codes 0x03 and 0x04	60
Table 3-26	Command parameters	61
Table 3-27	MODBUS standard device identification parameters	62
Table 7-1	Connection of supply voltage	92
Table 7-2	Available connection types	95
Table 8-1	Assignments of the function keys in the "MAIN MENU"	114

Table 8-2	Assignments of the function keys in the "SETTINGS" menu.....	115
Table 8-3	Assignments of the function keys in the device settings display	116
Table 8-4	Assignments of the function keys in edit mode of the device settings.....	117
Table 11-1	AC/DC multi-range power supply.....	159
Table 11-2	Extra-low voltage DC power supply:.....	159
Table A-1	Errors, comments, and suggestions for improvements	172
Table B-1	Protective measures	174
Table C-1	Meaning of abbreviations.....	175

Figures

Figure 2-1	Safety-related symbols on the device.....	18
Figure 3-1	Overload display	25
Figure 3-2	Display of the measured voltage in the case of connection type 3P4W.....	26
Figure 3-3	Display of the measured voltage in the case of connection type 1P2W.....	26
Figure 3-4	"LIMIT LOGIC" device setting	34
Figure 3-5	Representation of limit violations	35
Figure 3-6	Energy pulse output	36
Figure 3-7	Pulse length and turn-off time	37
Figure 3-8	"COMMUNICATION" device setting	38
Figure 3-9	Enter IP address	39
Figure 3-10	Typical display with entered values	39
Figure 3-11	Switching the protocol to MODBUS TCP.....	39
Figure 3-12	Restart prompt	39
Figure 3-13	SENTRON PAC3200 with screw terminals, rear.....	63
Figure 3-14	Not available for use! Slot for memory card and battery compartment	64
Figure 4-1	Mounting position.....	65
Figure 5-1	Installation step E - Strain relief for RJ45 connector	71
Figure 5-2	Deinstallation, releasing the locking hooks.....	72
Figure 6-1	Connection designations, view of the rear and top of the device with screw terminals.....	75
Figure 6-2	Connection designations, view of the rear and top of the device with ring lug terminals	76
Figure 6-3	Terminal labeling with screw terminals	77
Figure 6-4	Labeling of the ring lug terminals.....	78
Figure 6-5	Terminal block: digital input and output, reference potential	79
Figure 6-6	Connecting cables to the screw terminal	81
Figure 6-7	Connecting the cables to the ring lug terminals:.....	82

Figure 6-8	Connection type 3P4W, without voltage transformer, with three current transformers	83
Figure 6-9	Connection type 3P4W, with voltage transformer, with three current transformers	83
Figure 6-10	Connection type 3P4WB, without voltage transformer, with one current transformer	84
Figure 6-11	Connection type 3P4WB, with voltage transformer, with one current transformer	84
Figure 6-12	Connection type 3P3W, without voltage transformer, with three current transformers	85
Figure 6-13	Connection type 3P3W, with voltage transformer, with three current transformers	85
Figure 6-14	Connection type 3P3W, without voltage transformer, with two current transformers	86
Figure 6-15	Connection type 3P3W, with voltage transformer, with two current transformers	86
Figure 6-16	Connection type 3P3WB, without voltage transformer, with one current transformer	87
Figure 6-17	Connection type 3P3WB, with voltage transformer, with one current transformer	87
Figure 6-18	Connection type 3P4W, without voltage transformer, with two current transformers	88
Figure 6-19	Connection type 1P2W, without voltage transformer, with one current transformer	88
Figure 6-20	Connection type 3P3W, with voltage transformer, with three current transformers	89
Figure 7-1	Language selection	93
Figure 7-2	"SETTINGS" menu	94
Figure 7-3	"LANGUAGE" edit mode	94
Figure 7-4	"CONNECTION TYPE" device setting	96
Figure 7-5	Device setting "USE PTs?"	96
Figure 7-6	Device setting "USE PTs?"	97
Figure 7-7	"VOLTAGE INPUTS" device setting	98
Figure 7-8	"VOLTAGE INPUTS" device setting	98
Figure 7-9	"CURRENT INPUTS" device setting	99
Figure 7-10	Device setting "CURRENT INPUTS - CT PRIMARY?"	100
Figure 8-1	Device interface	103
Figure 8-2	Information structure and navigation	106
Figure 8-3	Scroll bar of the menu list	107
Figure 8-4	Start of the list/end of the list	108
Figure 8-5	Scroll bar	108
Figure 8-6	Maximum/minimum symbols	109
Figure 8-7	Display of the measured variables	110
Figure 8-8	Display of main menu	113
Figure 8-9	Display of the "SETTINGS" menu	114
Figure 8-10	Display of the device settings	115
Figure 8-11	Edit mode of the device settings	116
Figure 8-12	Display the instantaneous, maximum/minimum or average value	118
Figure 8-13	Reset the maximum or minimum value to the instantaneous value	118

Figure 8-14	Calling the "MAIN MENU"	119
Figure 8-15	Cancel menu selection.....	120
Figure 8-16	Displaying a setting.....	121
Figure 8-17	Calling edit mode	121
Figure 8-18	Exiting the display	121
Figure 8-19	Enter password	122
Figure 8-20	Switching a device setting ON/OFF	122
Figure 8-21	Device setting, switching between several alternatives.....	122
Figure 8-22	Selecting from several settings.....	123
Figure 8-23	Defining multi-digit values	123
Figure 8-24	Exiting edit mode	123
Figure 9-1	"Settings" menu.....	128
Figure 9-2	"INFORMATION" device setting	131
Figure 9-3	"LANGUAGE SETTING" device setting.....	132
Figure 9-4	"BASIC PARAMETERS" device setting.....	133
Figure 9-5	"VOLTAGE INPUTS" device setting	133
Figure 9-6	"CURRENT INPUTS" device setting.....	135
Figure 9-7	"POWER DEMAND" device setting	136
Figure 9-8	"INTEGRATED I/O" device setting	137
Figure 9-9	"DIGITAL OUTPUT" device setting.....	137
Figure 9-10	"DIGITAL OUTPUT" device setting.....	138
Figure 9-11	"DIGITAL INPUT" device setting.....	139
Figure 9-12	"DIGITAL INPUT" device setting.....	139
Figure 9-13	"COMMUNICATION" device setting	140
Figure 9-14	"DISPLAY" device setting	141
Figure 9-15	"INVERT DISPLAY" device setting switched on.....	142
Figure 9-16	"DISPLAY TEST" device setting	142
Figure 9-17	"ADVANCED" device setting	142
Figure 9-18	"PASSWORD PROTECTION" device setting.....	143
Figure 9-19	"LIMITS" device setting	143
Figure 9-20	"LIMIT 0" device setting	144
Figure 9-21	Effect of delay and hysteresis on upper and lower limit violations	146
Figure 9-22	"LIMIT LOGIC" device settings	147
Figure 9-23	"RESET" device setting	148
Figure 9-24	"PASSWORD PROTECTION" device setting.....	151
Figure 9-25	Switch off password protection	152

Figure 9-26	Change password	153
Figure 9-27	Change password - Password protection on	154
Figure 11-1	Device labeling.....	165
Figure 12-1	Panel cutout	167
Figure 12-2	Frame dimensions with optional PAC PROFIBUS DP expansion module connected	168
Figure 12-3	Frame dimensions with optional PAC PROFIBUS DP expansion module connected	168
Figure 12-4	Side-by-side installation	169
Figure 12-5	Clearances, device with screw terminal (on the left), device with ring lug terminal (on the right)	170
Figure B-1	ESD work center	174

Introduction

1.1 Purpose of this document

This present manual describes the SENTRON PAC3200 Power Monitoring Device.

It is intended for the use of:

- Planners
- Plant operators
- Commissioning engineers
- Service and maintenance personnel

Required basic knowledge

A general knowledge of the field of electrical engineering is required to understand this manual.

Knowledge of the relevant safety regulations and standards is required for installing and connecting the device.

Validity range

This manual applies to the following delivery versions of the device:

SENTRON PAC3200 for panel mounting with

- LC display
- Screw terminal
- Ring lug terminal

Those device properties valid at the time of publication of the manual are described.

1.2 Orientation aids

General information

The manual includes the following orientation aids:

- Table of contents
- List of figures and tables
- List of abbreviations
- Glossary
- Index

1.3 Components of the product

Description

The package includes:

- 1 SENTRON PAC3200 Power Monitoring Device
- 2 brackets for panel mounting
- 1 SENTRON PAC3200 operating instructions
- 1 CD-ROM

1.4 Contents of the CD for the SENTRON PAC Power Monitoring Device

CD contents

The SENTRON PAC CD includes the following files:

- The manual for the SENTRON PAC Power Monitoring Device in all available languages
- The operating instructions for the SENTRON PAC Power Monitoring Device in all available languages
- The manual for the PAC PROFIBUS DP expansion module in all available languages
- The operating instructions for the PAC PROFIBUS DP expansion module in all available languages
- The GSD files for the PAC PROFIBUS DP expansion module and the SENTRON PAC Power Monitoring Device.

Note**Specific GSD file**

This GSD file is only designed for the use of the PAC PROFIBUS DP expansion module with a specific type of the SENTRON PAC Power Monitoring Device.

- The manual for the PAC RS485 expansion module in all available languages
- The operating instructions for the PAC RS485 expansion module in all available languages
- The SENTRON powerconfig software including online help in all available languages.
- The language packages for the SENTRON PAC Power Monitoring Device

This CD is supplied with the SENTRON PAC Power Monitoring Device.

1.5 Technical support

Contact for technical problems and other questions

Help is available from:

- Service and support contacts in your region - worldwide
- Online service and support
- Technical support

Contacts in the region

Contacts in your region can provide support worldwide.

Table 1-1 Contacts in your region - worldwide

Utility	Address, number
Internet:	Service and support (http://www.siemens.com/automation/service&support) under "Contact us > Contacts"

Support address:

SIEMENS AG
A&D CD MM1
Gleiwitzerstr. 555
D-90475 Nuremberg

Online support

This comprehensive information system is available day and night via the Internet. Online service and support offers product support, services and support, and support tools from the shop.

Table 1-2 Online service and support

Utility	Address, number
Internet:	Online service and support (http://www.siemens.com/automation/service&support)

Technical Support

Technical support offers:

- Expert advice on technical queries over a broad subject area
- Tailored services relating to our products and systems

If you require technical support or you have questions about the product, contact Technical Support.

Table 1-3 Technical Support

Utility	Address, number
Phone:	+49 (0)180-50-50-222
Fax:	+49 (0)180-50-50-223
Internet:	Support request (http://www.siemens.com/automation/support-request)

1.6 Further documentation

Overview

You can find further details in the following manuals:

- SIMATIC NET "PROFIBUS network manual"
- "SETRON PAC3200" operating instructions
- "PAC PROFIBUS DP Expansion Module" manual
- "PAC PROFIBUS DP Expansion Module" operating instructions
- "PAC RS485 expansion module" manual
- "PAC RS485 expansion module" operating instructions

Safety instructions

2.1 Safety notes

General safety notes

**! DANGER**

Danger! High voltage

Will cause death or serious injury.

Turn off and lock out all power supplying this device before working on this device.

Safety-related symbols on the device

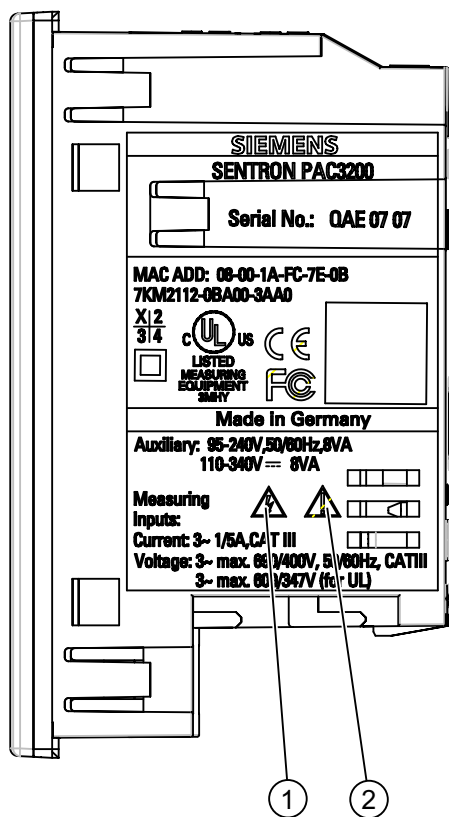



Figure 2-1 Safety-related symbols on the device

	Symbol	Meaning
(1)		Danger of electric shock.
(2)		Caution! General hazard area.

See also

Applying the measuring current (Page 101)

Applying the measuring voltage (Page 100)

Applying the supply voltage (Page 92)

Description

3.1 Features

The SENTRON PAC3200 is a Power Monitoring Device for displaying all the relevant system parameters in low-voltage power distribution. It is capable of single-phase, two-phase or three-phase measurement and can be used in two-wire, three-wire, four-wire, TN, TT and IT systems.

Thanks to its compact design in 96 x 96 mm format, it is an ideal replacement for all conventional analog indicating instruments.

Thanks to its large measured voltage range, the **SENTRON PAC3200 with multi-range power supply** can be connected direct in any low-voltage system up to a **rated system voltage of 690 V (max. 600 V for UL)**.

For the device version with **extra-low voltage power supply**, direct connection **to systems up to 500 V** is permissible.

Higher voltages can be measured using voltage transformers. For measuring current, either x/1 A or x/5 A current transformer can be used.

The large graphical LC display permits reading even from a distance. The SENTRON PAC3200 has backlighting that can be adjusted in steps for optimal readability even under poor lighting conditions.

The combination of four function keys with the multi-language plaintext displays makes intuitive user prompting possible. The experienced operator can also use direct navigation for quicker selection of the desired display menu.

The SENTRON PAC3200 has a range of useful monitoring, diagnostics and service functions, a two-tariff active energy and reactive energy counter, a universal counter, and a working hours counter for monitoring the running time of connected loads.

The integral Ethernet interface or an optionally available interface module can be used for communication.

In addition, the SENTRON PAC3200 has a multifunctional digital input and digital output. The parameters can be set either direct on the device or via the communications interface.

Password protection is integrated via the front of the device to guard against unauthorized access.

Device versions

The device is available in the following versions:

Table 3-1 Device versions

SENTRON PAC3200 Power Monitoring Device	
Order No.	Description
7KM2112-0BA00-2AA0	SENTRON PAC3200 with multi-range power supply with ring lug terminals
7KM2112-0BA00-3AA0	SENTRON PAC3200 with multi-range power supply with screw terminals
7KM2111-1BA00-3AA0	SENTRON PAC3200 with extra-low voltage power supply with screw terminals

Measurement

- Derivation of more than 50 measured variables from the basic measured variables with maximum and minimum values (slave pointer function), as well as mean values for phase-to-neutral voltages, phase-to-phase voltages and currents. The minimum and maximum values are indicated in addition to the mean values.
- With the **multi-range power supply**, the SENTRON PAC3200 **can be connected direct to 690 V (max. 600 V for UL) industrial systems** (measuring category III, pollution degree 2). Higher voltages using voltage transformers.
- With the **extra-low voltage power supply**, the SENTRON PAC3200 **can be connected direct to systems up to 500 V**.
- For current transformers x/1 A and x/5 A. Conversion ratio and current direction programmable.
- Can be used in 2-, 3- and 4-wire systems. Suitable for TN, TT and IT systems.
- High measuring accuracy: 0.5% of the measured value for energy.

Counters and power demand

- A total of 10 energy counters capture active energy, reactive energy, apparent energy for off-peak and on-peak, import and export.
- Calculation and storage of the last demand period mean value for active power and reactive power for simple generation of load profiles using software. Programmable demand period from 1 to 60 mins.
- Configurable universal counter for counting limit violations and status changes at the digital input or output, or for indicating the active power or reactive power of a connected pulse encoder, e.g. S0 interface.
- Working hours counter for monitoring the runtime of a connected load.

Monitoring functions

- Monitoring of 6 limit values. The limit values can be combined according to logic AND/OR. A group message that indicates the violation of at least one limit value can be generated using an OR operation.
- Phase sequence monitor.
- Status monitoring of the digital input.
- Monitoring the operating status of the SENTRON PAC3200.

Displays and controls

- Large backlit graphics LC display for optimal readability even from a distance.
- Menu-driven parameterization and operation with plaintext display.
- Choice of output language for menu and text displays.
- Phase labels selectable (L1, L2, L3 \Leftrightarrow a, b, c).

Power supply

- AC/DC multi-range power supply:
Supply by 95 to 240 V AC $\pm 10\%$ / 50 / 60 Hz or
110 to 340 V DC $\pm 10\%$.
- Extra-low voltage DC power supply:
Supply by 24 V, 48 V and 60 V DC $\pm 10\%$ or
22 to 65 V DC $\pm 10\%$.

Installation format

- Panel-mounting format 96 x 96 mm.
- Only 51-mm installation depth without expansion module, 73-mm installation depth with expansion module. The interface connector is plugged into the expansion module on the side and thus does not increase the installation depth.

Interface

- Integrated Ethernet interface.
- Expandable with optional expansion module (e.g. PAC PROFIBUS DP Expansion Module).
- Expandable with optional expansion module (e.g. PAC RS485 Expansion Module).

Input and output

- Multifunctional digital input for tariff changing, demand period synchronization, status monitoring or acquisition of energy pulses from third-party devices.
- Multifunctional digital output, programmable as energy pulse output for active energy or reactive energy pulses, for showing the direction of rotation, indicating the working hours of the SENTRON PAC3200, outputting limit violations, or as a switching output for remote control via PC.

Protection

Password protection on the device by means of 4-character code.

See also

Measured variables (Page 24)

Connection (Page 73)

Technical data (Page 157)

3.2 Measuring inputs

Current measurement

 CAUTION
AC current measurement only The device is not suitable for measuring DC current.

SENTRON PAC3200 is designed for:

- **Measuring current of 1 A or 5 A for connecting standard current transformers.** Each current measuring input can take a continuous load of 10 A (max. 300 V). Surge withstand capability is possible for currents up to 100 A and a duration of 1 s.

Voltage measurement

 CAUTION
AC voltage measurement only The device is not suitable for measuring DC voltage.

SENTRON PAC3200 is designed for:

- **Direct measurement on the system or using voltage transformers.** The measuring voltage inputs of the device measure direct via protective impedances. External voltage transformers are required to measure higher voltages than the permissible rated input voltages.
- **Measuring voltage to 400 V / 690 V (max. 347 V / 600 V for UL) with multi-range power supply.** The device is designed for measuring input voltages up to 400 V to the neutral conductor and 690 V to the external conductor.
- **Measuring voltage to 289 V / 500 V with extra-low voltage power supply.** The device is designed for measuring input voltages up to 289 V to the neutral conductor and 500 V to the external conductor.

Connection types

Five connection types have been provided for connecting two-wire, three-wire or four-wire systems with balanced or unbalanced load.

Table 3-2 Available connection types

Short code	Connection type
3P4W	3 phases, 4 conductors, unbalanced load
3P3W	3 phases, 3 conductors, unbalanced load
3P4WB	3 phases, 4 conductors, balanced load
3P3WB	3 phases, 3 conductors, balanced load
1P2W	Single-phase AC

The input circuit of the device must correspond to one of the connection types listed. Select the suitable connection type for the purpose.

You can find connection examples in the chapter "Connecting".



CAUTION

Local power supply conditions

Before connecting the SENTRON PAC3200, you must ensure that the local power supply conditions agree with the specifications on the type plate.

The short code of the connection type must be entered in the device settings at startup. You can find the instructions for parameterizing the connection type in the chapter "Starting up".

See also

Connection (Page 73)

Set the connection type (Page 95)

Applying the measuring voltage (Page 100)

Applying the measuring current (Page 101)

3.3 Measured variables

Overview

The table below lists all measured variables that the device records or derives from basic variables.

Table 3-3 Measured variables

Root-mean-square values	Designation	Instantaneous value	Min.	Max.	Mean value over all phases	Mean value over demand period	Total value	Unit
Phase-to-neutral voltage	$V_{a-n} / V_{b-n} / V_{c-n}$	✓	✓	✓	✓ ¹⁾			[V, kV]
Phase-to-phase voltage	$V_{a-b} / V_{b-c} / V_{c-a}$	✓	✓	✓	✓ ¹⁾			[V, kV]
Current	$I_a / I_b / I_c$	✓	✓	✓	✓ ¹⁾			[A, kA]
Apparent power per phase	$VA_a / VA_b / VA_c$	✓	✓	✓				[VA, kVA, MVA, GVA]
Active power per phase import/export	$\pm W_a / \pm W_b / \pm W_c$	✓	✓	✓				[W, kW, MW, GW]
Reactive power per phase positive/negative	$\pm VAR_a / \pm VAR_b / VAR_c$	✓	✓	✓				[var, kvar, Mvar, Gvar]
Total apparent power	VA_{total}	✓	✓	✓				[VA, kVA, MVA, GVA]
Total active power import/export	$\pm W_{total}$	✓	✓	✓		✓ ²⁾		[W, kW, MW, GW]
Total reactive power positive/negative	$\pm VAR_{total}$	✓	✓	✓		✓ ²⁾		[var, kvar, Mvar, Gvar]
Power factor	$ PF_a / PF_b / PF_c $	✓	✓	✓				[%]
Total power factor	PF_{total}	✓	✓	✓		✓		[%]
Line frequency	f	✓	✓	✓				[Hz]
THD voltage	THD- $V_a / THD-V_b / THD-V_c$	✓		✓				[%]
THD current	THD- $I_a / THD-I_b / THD-I_c$	✓		✓				[%]
Active energy import ³⁾ / export	$\pm W_{a...c}$						✓	[Wh, kWh, MWh, GWh]
Reactive energy positive ⁴⁾ / negative	$\pm WVAR_{a...c}$						✓	[varh, kvarh, Mvarh, Gvarh]
Apparent energy	$\pm W_{SL1...3}$						✓	[VAh, kVAh, MVAh, GVAh]
Universal counter								⁵⁾

Root-mean-square values	Designation	Instantaneous value	Min.	Max.	Mean value over all phases	Mean value over demand period	Total value	Unit
Working hours counter	Bh (load runtime)						✓	[h]
Voltage unbalance	Unbal.V						✓	[%]
Current unbalance	Unbal. A						✓	[%]

- 1) Instantaneous, minimum and maximum value in each case.
- 2) Mean value of the total power of the system/plant. Can only be called via bus.
- 3) The current tariff is shown on the display. The "+" sign stands for "Active energy import". The "-" sign stands for "Active energy export".
- 4) The current tariff is shown on the display. The "+" sign stands for "Reactive energy import". The "-" sign stands for "Reactive energy export".
- 5) The unit depends on the settings: no unit or "kWh" or "kvarh" in the case of pulse counter function.

Overload display

Voltage or current overload is indicated on the display.

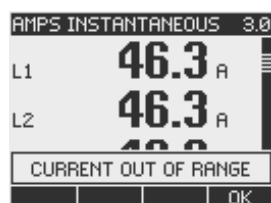

Figure 3-1 Overload display

Zero point suppression level

The zero point suppression level can be set via the interface in the range 0% to 10% of the measuring range final value (default value 0.0%). Currents within this range are indicated on the display with "0" (zero).

Current direction

The current direction can be changed on the device or via the interface for all phases in common. This means it is not necessary to change the terminal connections of the current transformer in the event of connection errors.

Display of the measured variables depending on the connection type

The total extent of representable measured variables is restricted by the method of connecting the device.

A measured value that cannot be indicated because of the connection method is shown on the display by means of a broken line "----".



Figure 3-2 Display of the measured voltage in the case of connection type 3P4W



Figure 3-3 Display of the measured voltage in the case of connection type 1P2W

The table below, "Display of the measured values depending on the connection type", shows which measured values can be represented depending on the connection type.

Table 3-4 Display of the measured variables depending on the connection type

Connection type	3P4W	3P3W	3P4WB	3P3WB	1P2W
Measured variable					
Voltage a-n	✓		✓		✓
Voltage b-n	✓				
Voltage c-n	✓				
Average Voltage a-n, b-n, c-n	✓				
Voltage a-b	✓	✓		✓	
Voltage b-c	✓	✓		✓	
Voltage c-a	✓	✓		✓	
Average Voltage a-b,b-c ,c-a	✓	✓		✓	
Current a	✓	✓	✓	✓	✓
Current b	✓	✓			
Current c	✓	✓			
Average Current a, b, c	✓	✓			
Apparent Power a	✓		✓		✓
Apparent Power b	✓				
Apparent Power c	✓				

Connection type	3P4W	3P3W	3P4WB	3P3WB	1P2W
Measured variable					
Active Power a	✓		✓		✓
Active Power b	✓				
Active Power c	✓				
Reactive Power a	✓		✓		✓
Reactive Power b	✓				
Reactive Power c	✓				
Total Apparent Power	✓	✓	✓	✓	✓
Total Active Power	✓	✓	✓	✓	✓
Total Reactive Power	✓	✓	✓	✓	✓
Power Factor a	✓		✓		✓
Power Factor b	✓				
Power Factor c	✓				
Total Power Factor	✓	✓	✓	✓	✓
Frequency	✓	✓	✓	✓	✓
THD Voltage a	✓		✓		✓
THD Voltage b	✓				
THD Voltage c	✓				
THD Current a	✓	✓	✓	✓	✓
THD Current b	✓	✓			
THD Current c	✓	✓			
Active Energy Import	✓	✓	✓	✓	✓
Active Energy Export	✓	✓	✓	✓	✓
Reactive Energy Positive	✓	✓	✓	✓	✓
Reactive Energy Negative	✓	✓	✓	✓	✓
Apparent Energy	✓	✓	✓	✓	✓
Voltage Unbalance	✓				
Current Unbalance	✓				
Universal Counter	✓	✓	✓	✓	✓
Working Hours Counter	✓	✓	✓	✓	✓

See also

Features (Page 19)

Parameterize (Page 127)

Connection examples (Page 82)

Description

3.3 Measured variables

Measured variables of the SENTRON PAC Power Monitoring Device

The measured variables are provided by the SENTRON PAC Power Monitoring Device.

Table 3-5 Available measured variables

Name	Abb. EN + IEC	Abb. EN + NAFTA	Format	Unit	Value range	Access
Voltage V _{a-n}	V _{L1-N}	V _{a-n}	Float	V	-	R
Voltage V _{b-n}	V _{L2-N}	V _{b-n}	Float	V	-	R
Voltage V _{c-n}	V _{L3-N}	V _{c-n}	Float	V	-	R
Voltage V _{a-b}	V _{L1-L2}	V _{a-b}	Float	V	-	R
Voltage V _{b-c}	V _{L2-L3}	V _{b-c}	Float	V	-	R
Voltage V _{c-a}	V _{L3-L1}	V _{c-a}	Float	V	-	R
Current a	I _{L1}	I _a	Float	A	-	R
Current b	I _{L2}	I _b	Float	A	-	R
Current c	I _{L3}	I _c	Float	A	-	R
Apparent Power a	VA _{L1}	VA _a	Float	VA	-	R
Apparent Power b	VA _{L2}	VA _b	Float	VA	-	R
Apparent Power c	VA _{L3}	VA _c	Float	VA	-	R
Active Power a	± W _{L1}	± W _a	Float	W	-	R
Active Power b	± W _{L2}	± W _b	Float	W	-	R
Active Power c	± W _{L3}	± W _c	Float	W	-	R
Reactive Power a	± var _{L1}	± var _a	Float	var	-	R
Reactive Power b	± var _{L2}	± var _b	Float	var	-	R
Reactive Power c	± var _{L3}	± var _c	Float	var	-	R
Power Factor a	PF _{L1}	PF _a	Float	-	0 ... 1	R
Power Factor b	PF _{L2}	PF _b	Float	-	0 ... 1	R
Power Factor c	PF _{L3}	PF _c	Float	-	0 ... 1	R
THD-R Voltage a	THD-V _{L1}	THD-V _a	Float	%	0 ... 100	R
THD-R Voltage b	THD-V _{L2}	THD-V _b	Float	%	0 ... 100	R
THD-R Voltage c	THD-V _{L3}	THD-V _c	Float	%	0 ... 100	R
THD-R Current a	THD-I _{L1}	THD-I _a	Float	%	0 ... 100	R
THD-R Current b	THD-I _{L2}	THD-I _b	Float	%	0 ... 100	R
THD-R Current c	THD-I _{L3}	THD-I _c	Float	%	0 ... 100	R
Frequency	f	f	Float	Hz	45 ... 65	R
Average Voltage V _{ph-n}	U _{L-N} MW	V _{ph-n} AVG	Float	V	-	R
Average Voltage V _{ph-ph}	V _{L-L} AVG	V _{ph-ph} AVG	Float	V	-	R
Average Current	I _{AVG}	I _{AVG}	Float	A	-	R
Total Apparent Power	Total VA	Total VA	Float	VA	-	R
Total Active Power	Total W	Total W	Float	W	-	R
Total Reactive Power	Total var	Total var	Float	var	-	R
Total Power Factor	Total PF	Total PF	Float	-	-	R

Name	Abb. EN + IEC	Abb. EN + NAFTA	Format	Unit	Value range	Access
Amplitude Unbalance - Voltage	Unbal. V	Unbal. V	Float	%	0 ... 100	R
Amplitude Unbalance - Current	Unbal.. A	Unbal. A	Float	%	0 ... 200	R
Maximum Voltage V_{a-n}	$\blacktriangle V_{L1-N}$	$\blacktriangle V_{a-n}$	Float	V	-	R
Maximum Voltage V_{b-n}	$\blacktriangle V_{L2-N}$	$\blacktriangle V_{b-n}$	Float	V	-	R
Maximum Voltage V_{c-n}	$\blacktriangle V_{L3-N}$	$\blacktriangle V_{c-n}$	Float	V	-	R
Max. Voltage V_{a-b}	$\blacktriangle V_{L1-L2}$	$\blacktriangle V_{a-b}$	Float	V	-	R
Max. Voltage V_{b-c}	$\blacktriangle V_{b-c}$	$\blacktriangle V_{b-c}$	Float	V	-	R
Max. Voltage V_{c-a}	$\blacktriangle V_{L3-L1}$	$\blacktriangle V_{c-a}$	Float	V	-	R
Maximum Current a	$\blacktriangle I_{L1}$	$\blacktriangle I_a$	Float	A	-	R
Maximum Current b	$\blacktriangle I_{L2}$	$\blacktriangle I_b$	Float	A	-	R
Maximum Current c	$\blacktriangle I_{L3}$	$\blacktriangle I_c$	Float	A	-	R
Maximum Apparent Power a	$\blacktriangle VA_{L1}$	$\blacktriangle VA_a$	Float	VA	-	R
Maximum Apparent Power b	$\blacktriangle VA_{L2}$	$\blacktriangle VA_b$	Float	VA	-	R
Maximum Apparent Power c	$\blacktriangle VA_{L3}$	$\blacktriangle VA_c$	Float	VA	-	R
Maximum Active Power a	$\blacktriangle \pm W_{L1}$	$\blacktriangle \pm W_a$	Float	W	-	R
Maximum Active Power b	$\blacktriangle \pm W_{L2}$	$\blacktriangle \pm W_b$	Float	W	-	R
Maximum Active Power c	$\blacktriangle \pm W_{L3}$	$\blacktriangle \pm W_c$	Float	W	-	R
Maximum Reactive Power a	$\blacktriangle \pm var_{L1}$	$\blacktriangle \pm var_a$	Float	var	-	R
Maximum Reactive Power b	$\blacktriangle \pm var_{L2}$	$\blacktriangle \pm var_b$	Float	var	-	R
Maximum Reactive Power c	$\blacktriangle \pm var_{L3}$	$\blacktriangle \pm var_c$	Float	var	-	R
Maximum Power Factor a	$\blacktriangle PF_{L1} $	$\blacktriangle PF_a $	Float		0 ... 1	R
Maximum Power Factor b	$\blacktriangle PF_{L2} $	$\blacktriangle PF_b $	Float		0 ... 1	R
Maximum Power Factor c	$\blacktriangle PF_{L3} $	$\blacktriangle PF_c $	Float		0 ... 1	R
Maximum THD-R Voltage a	$\blacktriangle THD-V_{L1}$	$\blacktriangle THD-V_a$	Float	%	0 ... 100	R
Maximum THD-R Voltage b	$\blacktriangle THD-V_{L2}$	$\blacktriangle THD-V_b$	Float	%	0 ... 100	R
Maximum THD-R Voltage c	$\blacktriangle THD-V_{L3}$	$\blacktriangle THD-V_c$	Float	%	0 ... 100	R
Maximum THD-R Current a	$\blacktriangle THD-I_{L1}$	$\blacktriangle THD-I_a$	Float	%	0 ... 100	R
Maximum THD-R Current b	$\blacktriangle THD-I_{L2}$	$\blacktriangle THD-I_b$	Float	%	0 ... 100	R
Maximum THD-R Current c	$\blacktriangle THD-I_{L3}$	$\blacktriangle THD-I_c$	Float	%	0 ... 100	R
Max. Frequency	$\blacktriangle f$	$\blacktriangle f$	Float	Hz	45 ... 65	R
Max. Average Voltage V_{ph-n}	$\blacktriangle V_{L-N MW}$	$\blacktriangle V_{ph-n AVG}$	Float	V	-	R
Max. Average Voltage V_{ph-ph}	$\blacktriangle V_{L-L MW}$	$\blacktriangle V_{ph-ph AVG}$	Float	V	-	R
Max. Average Current	$\blacktriangle I_{AVG}$	$\blacktriangle I_{AVG}$	Float	A	-	R
Max. Total Apparent Power	$\blacktriangle Total VA$	$\blacktriangle Total VA$	Float	VA	-	R
Max. Total Active Power	$\blacktriangle Total W$	$\blacktriangle Total W$	Float	W	-	R
Max. Total Reactive Power	$\blacktriangle Total var$	$\blacktriangle Total var$	Float	var	-	R
Maximum Total Power Factor	$\blacktriangle Total PF$	$\blacktriangle Total PF$	Float		-	R
Minimum Voltage V_{a-n}	$\blacktriangledown V_{L1-N}$	$\blacktriangledown V_{a-n}$	Float	V	-	R
Minimum Voltage V_{b-n}	$\blacktriangledown V_{L2-N}$	$\blacktriangledown V_{b-n}$	Float	V	-	R
Minimum Voltage V_{c-n}	$\blacktriangledown V_{L3-N}$	$\blacktriangledown V_{c-n}$	Float	V	-	R
Min. Voltage U_{a-b}	$\blacktriangledown V_{L1-L2}$	$\blacktriangledown V_{a-b}$	Float	V	-	R

Description

3.3 Measured variables

Name	Abb. EN + IEC	Abb. EN + NAFTA	Format	Unit	Value range	Access
Min. Voltage U_{b-c}	▼ V_{L2-L3}	▼ V_{b-c}	Float	V	-	R
Min. Voltage U_{L3-L1}	▼ V_{L3-L1}	▼ V_{c-a}	Float	V	-	R
Minimum Current a	▼ I_{L1}	▼ I_a	Float	A	-	R
Minimum Current b	▼ I_{L2}	▼ I_b	Float	A	-	R
Minimum Current c	▼ I_{L3}	▼ I_c	Float	A	-	R
Minimum Apparent Power a	▼ VA_{L1}	▼ VA_a	Float	VA	-	R
Minimum Apparent Power b	▼ VA_{L2}	▼ VA_b	Float	VA	-	R
Minimum Apparent Power c	▼ VA_{L3}	▼ VA_c	Float	VA	-	R
Minimum Active Power a	± W_{L1}	▼± W_a	Float	W	-	R
Minimum Active Power b	± W_{L2}	▼± W_b	Float	W	-	R
Minimum Active Power c	± W_{L3}	▼± W_c	Float	W	-	R
Minimum Reactive Power a	▼± var_{L1}	▼± var_a	Float	var	-	R
Minimum Reactive Power b	▼± var_{L2}	▼± var_b	Float	var	-	R
Minimum Reactive Power c	▼± var_{L3}	▼± var_c	Float	var	-	R
Minimum Power Factor a	▼ $ PF_{L1} $	▼ $ PF_a $	Float	-	0 ... 1	R
Minimum Power Factor b	▼ $ PF_{L2} $	▼ $ PF_b $	Float	-	0 ... 1	R
Minimum Power Factor c	▼ $ PF_{L3} $	▼ $ PF_c $	Float	-	0 ... 1	R
Min. Frequency	▼ f	▼ f	Float	Hz	45 ... 65	R
Min. Average Voltage V_{ph-n}	▼ $V_{L-N MW}$	▼ $V_{ph-n AVG}$	Float	V	-	R
Min. Average Voltage V_{ph-ph}	▼ $V_{L-L MW}$	▼ $V_{ph-ph AVG}$	Float	V	-	R
Min. Average Current	▼ I_{AVG}	▼ I_{AVG}	Float	A	-	R
Min. Total Apparent Power	▼Total VA	▼Total VA	Float	VA	-	R
Min. Total Active Power	▼Total W	▼Total W	Float	W	-	R
Min. Total Reactive Power	▼Total var	▼Total var	Float	var	-	R
Minimum Total Power Factor	▼Total PF	▼Total PF	Float	var	-	R
Limit Violations	-	-	Unsigned long	-	Byte 3 Bit 0 Limit 0	R
Device Diagnostics and Device Status	-	-	Unsigned long	-	Byte 0 System status	R
Status of the Digital Outputs	-	-	Unsigned long	-	Byte 3 Bit 0 Output 0	R
Status of the Digital Inputs	-	-	Unsigned long	-	Byte 3 Bit 0 Input 0	R
Active Tariff	-	-	Unsigned long	-	-	R
Working Hours Counter	-	-	Unsigned long	s	0 ... 999999999	RW
Universal Counter	-	-	Unsigned long	-	0 ... 999999999	RW
Relevant Parameter Changes Counter	-	-	Unsigned long	-	-	R
Counter All Parameter Changes	-	-	Unsigned long	-	-	R
Counter Limit Violations	-	-	-	-	-	R

Name	Abb. EN + IEC	Abb. EN + NAFTA	Format	Unit	Value range	Access
Demand Active Power - Import	-	-	Float	W	-	R
Demand Reactive Power - Import	-	-	Float	var	-	R
Demand Active Power - Export	-	-	Float	W	-	R
Demand Reactive Power - Export	-	-	Float	var	-	R
Maximum Active Power Reading during the period	-	-	Float	W	-	R
Minimum Active Power Reading during the period	-	-	Float	W	-	R
Maximum Reactive Power Reading during the period	-	-	Float	var	-	R
Minimum Reactive Power Reading during the period	-	-	Float	var	-	R
Demand Period	-	-	Unsigned long	s	-	R
Time Since Start of the active demand period	-	-	Unsigned long	s	-	R
Active Energy Import Tariff 1	-	-	Double	Wh	Overflow 1.0e+12	RW
Active Energy Import Tariff 2	-	-	Double	Wh	Overflow 1.0e+12	RW
Active Energy Export Tariff 1	-	-	Double	Wh	Overflow 1.0e+12	RW
Active Energy Export Tariff 2	-	-	Double	Wh	Overflow 1.0e+12	RW
Reactive Energy Import Tariff 1	-	-	Double	varh	Overflow 1.0e+12	RW
Reactive Energy Import Tariff 2	-	-	Double	varh	Overflow 1.0e+12	RW
Reactive Energy Export Tariff 1	-	-	Double	varh	Overflow 1.0e+12	RW
Reactive Energy Export Tariff 2	-	-	Double	varh	Overflow 1.0e+12	RW
Apparent Energy Tariff 1	-	-	Double	VAh	Overflow 1.0e+12	RW
Apparent Energy Tariff 2	-	-	Double	VAh	Overflow 1.0e+12	RW

Abbrev.: Abbreviation
R Read; read access
W Write; write access
RW Read Write; read and write access

3.4 Power demands and counters

Acquisition of power demand.

Values that can be read out:

SENTRON PAC3200 supplies the power demand of the last completed demand period:

- Average values for active power and reactive power, import and export.
- Minimum and maximum value within the period.
- Length of the demand period in seconds. The period may be shorter for reasons of external synchronization.
- Time in seconds since the last synchronization or since completion of the last period.

Note

The power demand can only be read out via the interface and is not represented on the display. The average values of the last demand period can only be retrieved during the active demand period.

Example: Period length and length of the demand period

Period length: 15 minutes; time of day: 13:03; time in seconds: 180 s.

The following can be calculated from this: The last demand period ended at 13:00. The active demand period will end at 13:15 or in 12 minutes.

Settable parameters:

- Period length in minutes (adjustable between 1 and 60 mins, default 15 mins).
- Synchronization via bus or digital input.

Energy counter

SENTRON PAC3200 has energy counters for off-peak and on-peak energy types (total of 10 counters):

- Active energy import
- Active energy export
- Reactive energy positive
- Reactive energy negative
- Apparent energy

Configurable universal counter

SENTRON PAC3200 provides one configurable counter.

The following counting options are available:

- Pulse counting via the digital input for kWh/kvarh
- Status changes at the digital input (rising edge only)
- Status changes at the digital output (rising edge only)
- Limit violations

Working hours counter

The working hours counter is used for monitoring the runtime of a connected load. (Counts only in the case of energy counting).

3.5 Tariffs

SENTRON PAC3200 supports 2 tariffs for the integrated energy counter (on-peak and off-peak).

Control of tariff switching

Switching between on-peak and on-peak can be controlled via the digital input or the communication interfaces.

Time-related switching is only possible using a higher-level system. SENTRON PAC3200 does not have its own clock.

Tariff switching after synchronization

When synchronizing the power demand values via the communication interfaces or the digital input, the tariff change will only become effective after expiry of the period. Without synchronization, the tariff change takes effect immediately.

The synchronization frame contains the length of the demand period in minutes. The synchronization command is ignored if the period length sent to the device with the synchronization frame is different to the length parameterized in the device.

3.6 Limits

The SENTRON PAC3200 has a function for monitoring up to 6 limit values. These can be monitored for violation of the upper or lower limit. If a limit value is violated, specific actions can be triggered.

In addition, the limit values can be combined with each other using a logic operation. The result of the logic operation can also be used to trigger specific actions in the same way as the individual limit values.

The limit violations are shown on the display.

Defining the limit values

The following must be specified for each of the six limit values in order to define the limit monitoring:

- Limit value monitoring ON/OFF
- Monitored measured variable
- Upper or lower limit violated
- Limit value
- Time delay
- Hysteresis

Combination of the limit values

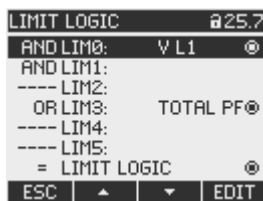

Figure 3-4 "LIMIT LOGIC" device setting

The following operators are available:

- AND
- OR

The placeholder "----" means: This limit value is not combined with any other limit value.

The logic combines limit values 0 to 5 as follows:

(((op_{LIM0} LIM0 op_{LIM1} LIM1) op_{LIM2} LIM2) op_{LIM3} LIM3) op_{LIM4} LIM4) op_{LIM5} LIM5)

- LIM0 represents limit value 0
- LIM1 represents limit value 1
- LIMx represents limit value x
- op represents the logic operator AND/OR in the formula

The brackets in the formula show that the AND/OR priority rule does not apply.

The result of the logic operation is the "LIMIT LOGIC".

Displaying limit violations

- Indication of limit violation on the display:
"MAIN MENU> SETTINGS > ADVANCED > LIMITS" and
"... > LIMITS > LIMIT LOGIC".

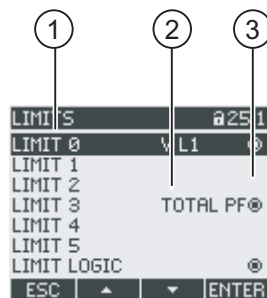

Figure 3-5 Representation of limit violations

- (1) Limit value designation
- (2) Monitored data source
- (3) Limit value currently violated: Yes , No
- Outputting the limit violation to the digital output.
- Output of limit violations via the interface.
- Counting limit violations with the universal counter.

3.7 Behavior in the case of power failure and power restore

After a power failure, the device starts back at zero with the calculation of the power demand of the total active power and total reactive power.

Counter statuses and maximum/minimum values are written from the volatile to the non-volatile memory at the following intervals:

Counter values	Every 5 mins.
Maximum/minimum values	Every 5 secs., if available

3.8 Digital inputs and outputs

SENTRON PAC3200 has:

- one multifunctional digital input,
- one multifunctional digital output.

Digital output

The following functions can be assigned to the digital output:

- Energy pulse output, programmable for active energy pulses or reactive energy pulses
- Indication of the direction of rotation
- Displaying the operating status of the SENTRON PAC3200
- Signaling limit violations
- Switching output for remote control via the interface

Energy pulse output

The digital output supplies a number of pulses proportional to the energy measured.

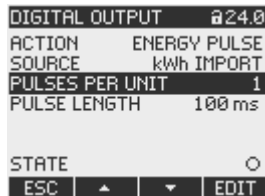

Figure 3-6 Energy pulse output

The digital output is passive and implemented exclusively as a switch.

Implementation of the pulse function corresponds to the IEC 62053-31 standard.

Pulse length, turn-off time

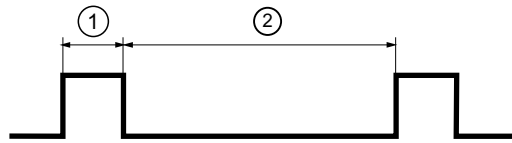

Figure 3-7 Pulse length and turn-off time

- (1) Pulse length
- (2) Turn-off time

- **Pulse length:**
Time for which the signal at the binary digital output is at "high". The minimum pulse length is 30 ms and the maximum 500 ms.
- **Turn-off time:**
Time for which the signal at the digital output is at "low". The turn-off time depends on the measured energy, for example, and can be days or months. The minimum turn-off time is 30 ms.
- **Minimum turn-off time:**
The minimum turn-off time is specified by the programmed pulse length.

Digital input

The following functions can be assigned to the digital input:

- Tariff switching for two-tariff active and reactive energy counters.
- Synchronization of the measuring period by means of the synchronization pulse of a system control center or other device.
- Status monitoring: Acquisition of statuses and messages of connected signal encoders.
- Energy pulse input for active or reactive energy pulses (S0 interface). Data is transferred with the help of weighted pulses, e.g., a parameterizable number of pulses is transferred for each kWh.

A maximum voltage of 24 V can be applied to the digital input. Higher voltages require an external voltage divider.

3.9 Ethernet port

3.9.1 Ethernet

Electrical connection

NOTICE
Incorrect network settings can adversely affect and interfere with the functions of other network nodes The network settings for Ethernet are defined by the system administrator and set accordingly on the device. If the setting data is not known, the (patch) cable must not be connected.

The SENTRON PAC3200 has an RJ45 socket on the top. The device can be connected to Ethernet with an RJ45 connector, type T-568B.

3.9.2 Modbus TCP

Support of MODBUS TCP via Ethernet interface

The SEAbus TCP protocol is the default.

You change the transmission protocol from SEAbus TCP (default setting) to MODBUS TCP with F4 **MENU** > "SETTINGS> COMMUNICATION > PROTOCOL".

Before user data can be transmitted via MODBUS TCP, a TCP/IP connection must first be established between the client and the server. The port number 502 is established for MODBUS TCP on the server side.

Before changing to MODBUS TCP, enter the network parameters for IP-ADDRESS, SUBNET and GATEWAY. Ask your network administrator for suitable values.

Setting the network parameters

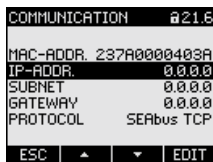

Figure 3-8 "COMMUNICATION" device setting

Use F4 **EDIT** to switch to edit mode.

F3 **→** runs through the digits of the value from left to right.

F2 **+** increments the value at the selected digit. The highest value of the available set of values is followed again by the lowest.

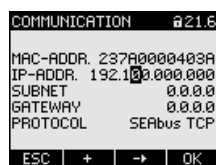

Figure 3-9 Enter IP address

F4 **OK** saves the set IP ADDRESS and returns to display mode.

Change to the next line SUBNET with F3 **▼**, and press F4 **EDIT**.

Repeat the procedure described for the settings SUBNET and GATEWAY.

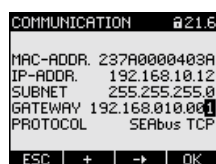

Figure 3-10 Typical display with entered values

Switching from the SEAbus TCP protocol to MODBUS TCP

Use F3 **▼** to change to the "PROTOCOL" entry

Press F4 **EDIT**.

Switch the protocol from "SEAbus TCP" to "MODBUS TCP" with F2 **+**

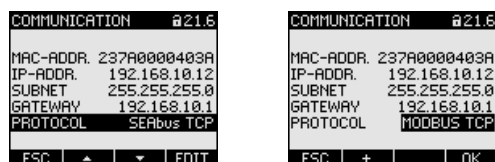

Figure 3-11 Switching the protocol to MODBUS TCP

Confirm your selection with F4 **OK**.

F1 **ESC** terminates the input and a message window prompts you to restart.



Figure 3-12 Restart prompt

F4 **OK** carries out a restart - your settings become effective.

3.9.3 Modbus measured variables with the function codes 0x03 and 0x04

Measured variables of the SENTRON PAC Power Monitoring Device

The measured variables are provided by the SENTRON PAC Power Monitoring Device. You can use the MODBUS function codes 0x03 and 0x04 on all the measured variables listed below.

NOTICE
<p>Error in the case of inconsistent access to measured values</p> <p>Please ensure the start offset of the register is correct when making read accesses.</p> <p>Please ensure the start offset and the number of registers are correct when making write accesses.</p> <p>If a value consists of two registers, a read command applied in the second register, for example, will generate an error code. SENTRON PAC will also output an error code if, for example, a write operation ends in the middle of a multi-register value.</p>

Table 3-6 Available measured variables

Offset	Number of registers	Name	Format	Unit	Value range	Access
1	2	Voltage V_{a-n}	Float	V	-	R
3	2	Voltage V_{b-n}	Float	V	-	R
5	2	Voltage V_{c-n}	Float	V	-	R
7	2	Voltage V_{a-b}	Float	V	-	R
9	2	Voltage V_{b-c}	Float	V	-	R
11	2	Voltage V_{c-a}	Float	V	-	R
13	2	Current a	Float	A	-	R
15	2	Current b	Float	A	-	R
17	2	Current c	Float	A	-	R
19	2	Apparent Power a	Float	VA	-	R
21	2	Apparent Power b	Float	VA	-	R
23	2	Apparent Power c	Float	VA	-	R
25	2	Active Power a	Float	W	-	R
27	2	Active Power b	Float	W	-	R
29	2	Active Power c	Float	W	-	R
31	2	Reactive Power a	Float	var	-	R
33	2	Reactive Power b	Float	var	-	R
35	2	Reactive Power c	Float	var	-	R
37	2	Power Factor a	Float	-	0 ... 1	R
39	2	Power Factor b	Float	-	0 ... 1	R
41	2	Power Factor c	Float	-	0 ... 1	R
43	2	THD-R Voltage a	Float	%	0 ... 100	R
45	2	THD-R Voltage b	Float	%	0 ... 100	R

Offset	Number of registers	Name	Format	Unit	Value range	Access
47	2	THD-R Voltage c	Float	%	0 ... 100	R
49	2	THD-R Current a	Float	%	0 ... 100	R
51	2	THD-R Current b	Float	%	0 ... 100	R
53	2	THD-R Current c	Float	%	0 ... 100	R
55	2	Frequency	Float	Hz	45 ... 65	R
57	2	Average Voltage V_{ph-n}	Float	V	-	R
59	2	Average Voltage V_{ph-ph}	Float	V	-	R
61	2	Average Current	Float	A	-	R
63	2	Total Apparent Power	Float	VA	-	R
65	2	Total Active Power	Float	W	-	R
67	2	Total Reactive Power	Float	var	-	R
69	2	Total Power Factor	Float		-	R
71	2	Amplitude Unbalance - Voltage	Float	%	0 ... 100	R
73	2	Amplitude Unbalance - Current	Float	%	0 ... 200	R
75	2	Maximum Voltage V_{a-n}	Float	V	-	R
77	2	Maximum Voltage V_{b-n}	Float	V	-	R
79	2	Maximum Voltage V_{c-n}	Float	V	-	R
81	2	Max. Voltage V_{a-b}	Float	V	-	R
83	2	Max. Voltage V_{b-c}	Float	V	-	R
85	2	Max. Voltage V_{c-a}	Float	V	-	R
87	2	Maximum Current a	Float	A	-	R
89	2	Maximum Current b	Float	A	-	R
91	2	Maximum Current c	Float	A	-	R
93	2	Maximum Apparent Power a	Float	VA	-	R
95	2	Maximum Apparent Power b	Float	VA	-	R
97	2	Maximum Apparent Power c	Float	VA	-	R
99	2	Maximum Active Power a	Float	W	-	R
101	2	Maximum Active Power b	Float	W	-	R
103	2	Maximum Active Power c	Float	W	-	R
105	2	Maximum Reactive Power a	Float	var	-	R
107	2	Maximum Reactive Power b	Float	var	-	R
109	2	Maximum Reactive Power c	Float	var	-	R
111	2	Maximum Power Factor a	Float		0 ... 1	R
113	2	Maximum Power Factor b	Float		0 ... 1	R
115	2	Maximum Power Factor c	Float		0 ... 1	R
117	2	Maximum THD-R Voltage a	Float	%	0 ... 100	R
119	2	Maximum THD-R Voltage b	Float	%	0 ... 100	R
121	2	Maximum THD-R Voltage c	Float	%	0 ... 100	R
123	2	Maximum THD-R Current a	Float	%	0 ... 100	R
125	2	Maximum THD-R Current b	Float	%	0 ... 100	R
127	2	Maximum THD-R Current c	Float	%	0 ... 100	R

Description

3.9 Ethernet port

Offset	Number of registers	Name	Format	Unit	Value range	Access
129	2	Max. Frequency	Float	Hz	45 ... 65	R
131	2	Max. Average Voltage V_{ph-n}	Float	V	-	R
133	2	Max. Average Voltage V_{ph-ph}	Float	V	-	R
135	2	Max. Average Current	Float	A	-	R
137	2	Max. Total Apparent Power	Float	VA	-	R
139	2	Max. Total Active Power	Float	W	-	R
141	2	Max. Total Reactive Power	Float	var	-	R
143	2	Maximum Total Power Factor	Float		-	R
145	2	Minimum Voltage V_{a-n}	Float	V	-	R
147	2	Minimum Voltage V_{b-n}	Float	V	-	R
149	2	Minimum Voltage V_{c-n}	Float	V	-	R
151	2	Min. Voltage V_{a-b}	Float	V	-	R
153	2	Min. Voltage V_{b-c}	Float	V	-	R
155	2	Min. Voltage V_{c-a}	Float	V	-	R
157	2	Minimum Current a	Float	A	-	R
159	2	Minimum Current b	Float	A	-	R
161	2	Minimum Current c	Float	A	-	R
163	2	Minimum Apparent Power a	Float	VA	-	R
165	2	Minimum Apparent Power b	Float	VA	-	R
167	2	Minimum Apparent Power c	Float	VA	-	R
169	2	Minimum Active Power a	Float	W	-	R
171	2	Minimum Active Power b	Float	W	-	R
173	2	Minimum Active Power c	Float	W	-	R
175	2	Minimum Reactive Power a	Float	var	-	R
177	2	Minimum Reactive Power b	Float	var	-	R
179	2	Minimum Reactive Power c	Float	var	-	R
181	2	Minimum Power Factor a	Float	-	0 ... 1	R
183	2	Minimum Power Factor b	Float	-	0 ... 1	R
185	2	Minimum Power Factor c	Float	-	0 ... 1	R
187	2	Min. Frequency	Float	Hz	45 ... 65	R
189	2	Min. Average Voltage V_{ph-n}	Float	V	-	R
191	2	Min. Average Voltage V_{ph-ph}	Float	V	-	R
193	2	Min. Average Current	Float	A	-	R
195	2	Min. Total Apparent Power	Float	VA	-	R
197	2	Min. Total Active Power	Float	W	-	R
199	2	Min. Total Reactive Power	Float	var	-	R
201	2	Minimum Total Power Factor	Float	var	-	R
203	2	Limit Violations*	Unsigned long	-	Byte 3 Bit 0 Limit 0	R
205	2	Device Diagnostics and Device Status*	Unsigned long	-	Byte 0 System status	R
207	2	Status of the digital outputs*	Unsigned long	-	Byte 3 Bit 0 Output 0	R

Offset	Number of registers	Name	Format	Unit	Value range	Access
209	2	Status of the digital inputs*	Unsigned long	-	Byte 3 Bit 0 Input 0	R
211	2	Active Tariff	Unsigned long	-	0 = Tariff 1 1 = Tariff 2	R
213	2	Working hours counter	Unsigned long	s	0 ... 999999999	RW
215	2	Universal counter	Unsigned long	-	0 ... 999999999	RW
217	2	Relevant Parameter Changes Counter	Unsigned long	-	-	R
219	2	Counter All Parameter Changes	Unsigned long	-	-	R
221	2	Counter Limit Violations	-	-	-	R
501	2	Demand Active Power - Import	Float	W	-	R
503	2	Demand Reactive Power - Import	Float	var	-	R
505	2	Demand Active Power - Export	Float	W	-	R
507	2	Demand Reactive Power - Export	Float	var	-	R
509	2	Maximum Active Power Reading during the period	Float	W	-	R
511	2	Minimum Active Power Reading during the period	Float	W	-	R
513	2	Maximum Reactive Power Reading during the period	Float	var	-	R
515	2	Minimum Reactive Power Reading during the period	Float	var	-	R
517	2	Demand Period	Unsigned long	s	-	R
519	2	Time Since Start of the active demand period	Unsigned long	s	-	R
801	4	Active Energy Import Tariff 1	Double	Wh	Overflow 1.0e+12	RW
805	4	Active Energy Import Tariff 2	Double	Wh	Overflow 1.0e+12	RW
809	4	Active Energy Export Tariff 1	Double	Wh	Overflow 1.0e+12	RW
813	4	Active Energy Export Tariff 2	Double	Wh	Overflow 1.0e+12	RW
817	4	Reactive Energy Import Tariff 1	Double	varh	Overflow 1.0e+12	RW
821	4	Reactive Energy Import Tariff 2	Double	varh	Overflow 1.0e+12	RW
825	4	Reactive Energy Export Tariff 1	Double	varh	Overflow 1.0e+12	RW
829	4	Reactive Energy Export Tariff 2	Double	varh	Overflow 1.0e+12	RW
833	4	Apparent Energy Tariff 1	Double	VAh	Overflow 1.0e+12	RW
837	4	Apparent Energy Tariff 2	Double	VAh	Overflow 1.0e+12	RW

The following tables contain further details of all measured variables indicated by at least one *.

Abbr. in the "Access" column	Abbreviation
R	Read; read access
W	Write; write access
RW	Read Write; read and write access

See also

Structure - Digital input status and digital output status with the function codes 0x03 and 0x04 (Page 44)

Structure - Device diagnostics and device status with the function codes 0x03 and 0x04 (Page 45)

Structure - Limit values with function codes 0x03 and 0x04 (Page 45)

3.9.4 Structure - Digital input status and digital output status with the function codes 0x03 and 0x04

The following are available via MODBUS:

- "Status of the Digital Inputs"
- "Status of the Digital Outputs"

Input status and output status of the SENTRON PAC Power Monitoring Device

Table 3-7 Structure - Status of the digital inputs and status of the digital outputs

Name	Length	Status	Byte	Bit	Bit mask	Access
Status of the Digital Outputs	32 bits	DO	3	0	0x00000001	R
Status of the Digital Inputs	32 bits	DI	3	0	0x00000001	R

See also

Modbus measured variables with the function codes 0x03 and 0x04 (Page 40)

3.9.5 Structure - Device diagnostics and device status with the function codes 0x03 and 0x04

Design

Table 3-8 Modbus offset 205, tab 2: Structure device status and device diagnostics

Byte	Bit	Device status	Type	Bit mask	Value range	Access
0	0	No synchronization pulse	Status	0x01000000	0 = Not active 1 = active	R
0	1	Device Configuration menu is active	Status	0x02000000		R
0	2	Voltage overload	Status	0x04000000		R
0	3	Current overload	Status	0x08000000		R
1	0	Module slot 1	Status	0x00010000		R
1	1	Maximum pulse rate exceeded	Status	0x00020000		R
2	0	Relevant parameter changes ¹⁾	saving	0x00000100		R
2	1	Upper or lower limit violation ¹⁾	saving	0x00000200		R
2	2	Maximum pulse rate exceeded ¹⁾	saving	0x00000400		R
2	3	Restart of the device ¹⁾	saving	0x00000800		R
2	4	Resetting of energy counter by user ¹⁾	saving	0x00001000	R	

1) Only these device statuses are to be acknowledged.

See also

Modbus measured variables with the function codes 0x03 and 0x04 (Page 40)

3.9.6 Structure - Limit values with function codes 0x03 and 0x04

Structure of the limit values

Table 3-9 Modbus Offset 203, Register 2: Limit Violations

Byte	Bit	Status	Bit mask	Value range	Access
3	0	Limit 0	0x00000001	0 = No limit violation 1 = Limit violation	R
3	1	Limit 1	0x00000002		R
3	2	Limit 2	0x00000004		R
3	3	Limit 3	0x00000008		R
3	4	Limit 4	0x00000010		R
3	5	Limit 5	0x00000020		R
0	0	Limit Logic	0x01000000		R

See also

Modbus measured variables with the function codes 0x03 and 0x04 (Page 40)

3.9.7 Modbus status parameters with the function code 0x02

Status parameters

You can use the MODBUS function code 0x02 on all the status parameters listed below.

Table 3-10 Status parameters

Offset	Number of registers	Name	Format	Value range	Access
0	0	Limit 0 status	Bit	0 = No limit violation 1 = Limit violation	R
1	0	Limit 1 status	Bit		R
2	0	Limit 2 status	Bit		R
3	0	Limit 3 status	Bit		R
4	0	Limit 4 status	Bit		R
5	0	Limit 5 status	Bit		R
50	0	Limit Logic status	Bit	0 = Not active 1 = active	R
108	0	Relevant parameter changes	Bit		R
109	0	Upper or lower limit violation	Bit		R
110	0	Maximum pulse rate exceeded	Bit		R
111	0	Restart of the device	Bit		R
112	0	Resetting of energy counter by user	Bit		R
116	0	Module slot 1	Bit		R
117	0	Maximum pulse rate exceeded	Bit		R
124	0	No synchronization pulse	Bit		R
125	0	Device Configuration menu is active	Bit		R
126	0	Voltage overload	Bit		R
127	0	Current overload	Bit		R
200	0	Digital input 0	Bit		R
300	0	Digital output 0	Bit		R

See also

Modbus measured variables with the function codes 0x03 and 0x04 (Page 40)

3.9.8 Modbus settings with the function codes 0x03, 0x04 and 0x10

Addressing the settings

You can use the MODBUS function codes 0x03, 0x04 for read accesses and 0x10 for write accesses on all the settings parameters listed below.

Table 3-11 Settings parameters

Offset	Number of registers	Name	Unit	Format	Value range	Access	
50001	2	Connection type	-	unsigned long	0 =	3P4W	RW
					1 =	3P3W	
					2 =	3P4WB	
					3 =	3P3WB	
					4 =	1P2W	
50003	2	Voltage measurement using voltage transformers?	-	unsigned long	0 =	No	RW
					1 =	Yes	
50005	2	Primary voltage	-	unsigned long	1 ... 999999 V	RW	
50007	2	Secondary voltage	-	unsigned long	1 ... 690 V	RW	
50011	2	Primary current	-	unsigned long	1 ... 99999 A	RW	
50013	2	Secondary current	-	unsigned long	1 A, 5 A	RW	
50015	2	Invert CT polarity?	-	unsigned long	0 =	No	RW
					1 =	Yes	
50019	2	Zero point suppression level (% rated current)	%	float	0.0 ... 10.0	RW	
50021	2	Demand Period	Min.	unsigned long	1 ... 60	RW	
50023	2	Synchronization	-	unsigned long	0 =	No synchronization	RW
					1 =	Synchronization via bus	
					2 =	Synchronization via the digital input	

Table 3-12 Settings parameter for the digital input

Offset	Number of registers	Name	Unit	Format	Value range	Access	
50025	2	"Action" mode	-	unsigned long	0 =	Status only	RW
					1 =	Pulse input	
					2 =	High tariff/low tariff switch	
					3 =	DEMAND synchronization	
50029	2	"Pulse input" mode	-	unsigned long	0 =	Import kWh	RW
					1 =	Export kWh	
					2 =	Import kvarh	
					3 =	Export kvarh	
50031	2	Pulses per unit (pulses per 1000 Wh / VARh)	-	unsigned long	1 ... 999	RW	

Table 3-13 Settings parameter for the digital output

Offset	Number of registers	Name	Unit	Format	Value range	Access	
50033	2	Switching function Assignment to a vector group	-	unsigned long	0 ... 99	RW	
50035	2	"Action" mode	-	unsigned long	0 =	Off	RW
					1 =	Device on	
					2 =	Remote output	
					3 =	Direction of rotation	
					4 =	Limit violation	
					5 =	Energy pulse	
50037	2	"Limit violation" mode	-	unsigned long	0 =	Limit Logic	RW
					1 =	Limit 0	
					2 =	Limit 1	
					3 =	Limit 2	
					4 =	Limit 3	
					5 =	Limit 4	
					6 =	Limit 5	
50041	2	"Energy pulse" mode	-	unsigned long	0 =	Import kWh	RW
					1 =	Export kWh	
					2 =	Import kvarh	
					3 =	Export kvarh	
50043	2	Pulses per unit (pulses per 1000 Wh / VARh)	-	unsigned long	1 ... 999	RW	
50045	2	Pulse length	ms	unsigned long	30 ... 500	RW	

Table 3-14 Settings parameter for language, phase labels and universal counters source

Offset	Number of registers	Name	Unit	Format	Value range	Access	
50047	2	Active language	-	unsigned long	0 =	German	RW
					1 =	English	
					2 =	Portuguese	
					3 =	Turkish	
					4 =	Spanish	
					5 =	Italian	
					6 =	Russian	
					7 =	French	
50049	2	Phase labels IEC/NAFTA	-	unsigned long	0 =	IEC	RW
					1 =	NAFTA	
50051	2	Universal counter source	-	unsigned long	0 =	Digital input	RW
					1 =	Digital output	
					2 =	Limit Logic	
					3 =	Limit 0	
					4 =	Limit 1	
					5 =	Limit 2	
					6 =	Limit 3	
					7 =	Limit 4	
					8 =	Limit 5	

Table 3-15 Settings parameter for the display

Offset	Number of registers	Name	Unit	Format	Value range	Access
50053	2	Refresh time	ms	unsigned long	330 ... 3000	RW
50055	2	Contrast	-	unsigned long	1 ... 10	RW
50057	2	Backlight level - Normal mode	%	unsigned long	0 ... 3	RW
50059	2	Backlight dimmed	%	unsigned long	0 ... 3	RW
50061	2	Backlight time until dimmed	Min.	unsigned long	0 ... 240	RW

Description

3.9 Ethernet port

Table 3-16 Settings parameter for limit value 0

Offset	Number of registers	Name	Unit	Format	Value range	Access
50063	2	ON/OFF	-	unsigned long	0 = OFF	RW
					1 = ON	
50065	2	Hysteresis	%	float	0.0 ... 20.0	RW
50067	2	Delay	s	unsigned long	0 ... 10	RW
50069	2	Operation in Limit Logic	-	unsigned long	0 = not used	RW
					1 = AND	
					2 = OR	
50071	2	Source	-	unsigned long	0 = V_L1	RW
					1 = V_L2	
					2 = V_L3	
					3 = V_L12	
					4 = V_L23	
					5 = V_L31	
					6 = I_L1	
					7 = I_L2	
					8 = I_L3	
					9 = VA_L1	
					10 = VA_L2	
					11 = VA_L3	
					12 = P_L1	
					13 = P_L2	
					14 = P_L3	
					15 = VAR_L1	
					16 = VAR_L2	
					17 = VAR_L3	
					18 = PF_L1	
					19 = PF_L2	
					20 = PF_L3	
					21 = THDV_L1	
					22 = THDV_L2	
					23 = THDV_L3	
					24 = THDI_L1	
					25 = THDI_L2	
					26 = THDI_L3	
					27 = FREQ	
					28 = V_LN_AVG	
					29 = V_LL_AVG	
					30 = I_AVG	
					31 = VA_SUM	

Offset	Number of registers	Name	Unit	Format	Value range	Access
					32 = P_SUM	
					33 = VAR_SUM	
					34 = PF_SUM	
					35 = V_BAL	
					36 = I_BAL	
50073	2	Value	-	float	-	RW
50075	2	Modus \geq / $<$	-	unsigned long	0 = greater than	RW
					1 = less than	

Table 3-17 Settings parameter for limit value 1

Offset	Number of registers	Name	Unit	Format	Value range	Access
50077	2	ON/OFF	-	unsigned long	0 = OFF	RW
					1 = ON	
50079	2	Hysteresis	%	float	0.0 ... 20.0	RW
50081	2	Delay	s	unsigned long	0 ... 10	RW
50083	2	Operation in Limit Logic	-	unsigned long	0 = not used	RW
					1 = AND	
					2 = OR	
50085	2	Source	-	unsigned long	0 = V_L1	RW
					1 = V_L2	
					2 = V_L3	
					3 = V_L12	
					4 = V_L23	
					5 = V_L31	
					6 = I_L1	
					7 = I_L2	
					8 = I_L3	
					9 = VA_L1	
					10 = VA_L2	
					11 = VA_L3	
					12 = P_L1	
					13 = P_L2	
					14 = P_L3	
					15 = VAR_L1	
					16 = VAR_L2	
					17 = VAR_L3	
					18 = PF_L1	
					19 = PF_L2	
					20 = PF_L3	

Description

3.9 Ethernet port

Offset	Number of registers	Name	Unit	Format	Value range	Access
					21 = THDV_L1 22 = THDV_L2 23 = THDV_L3 24 = THDI_L1 25 = THDI_L2 26 = THDI_L3 27 = FREQ 28 = V_LN_AVG 29 = V_LL_AVG 30 = I_AVG 31 = VA_SUM 32 = P_SUM 33 = VAR_SUM 34 = PF_SUM 35 = V_BAL 36 = I_BAL	
50087	2	Value	-	float	-	RW
50089	2	Modus $\geq / <$	-	unsigned long	0 = greater than 1 = less than	RW

Table 3-18 Settings parameter for limit value 2

Offset	Number of registers	Name	Unit	Format	Value range	Access
50091	2	ON/OFF	-	unsigned long	0 = OFF 1 = ON	RW
50093	2	Hysteresis	%	float	0.0 ... 20.0	RW
50095	2	Delay	s	unsigned long	0 ... 10	RW
50097	2	Operation in Limit Logic	-	unsigned long	0 = not used 1 = AND 2 = OR	RW
50099	2	Source	-	unsigned long	0 = V_L1 1 = V_L2 2 = V_L3 3 = V_L12 4 = V_L23 5 = V_L31 6 = I_L1 7 = I_L2 8 = I_L3 9 = VA_L1	RW

Offset	Number of registers	Name	Unit	Format	Value range	Access
					10 = VA_L2	
					11 = VA_L3	
					12 = P_L1	
					13 = P_L2	
					14 = P_L3	
					15 = VAR_L1	
					16 = VAR_L2	
					17 = VAR_L3	
					18 = PF_L1	
					19 = PF_L2	
					20 = PF_L3	
					21 = THDV_L1	
					22 = THDV_L2	
					23 = THDV_L3	
					24 = THDI_L1	
					25 = THDI_L2	
					26 = THDI_L3	
					27 = FREQ	
					28 = V_LN_AVG	
					29 = V_LL_AVG	
					30 = I_AVG	
					31 = VA_SUM	
					32 = P_SUM	
					33 = VAR_SUM	
					34 = PF_SUM	
					35 = V_BAL	
					36 = I_BAL	
50101	2	Value	-	float	-	RW
50103	2	Modus \geq / $<$	-	unsigned long	0 = greater than	RW
					1 = less than	

Table 3-19 Settings parameter for limit value 3

Offset	Number of registers	Name	Unit	Format	Value range	Access
50105	2	ON/OFF	-	unsigned long	0 = OFF	RW
					1 = ON	
50107	2	Hysteresis	%	float	0.0 ... 20.0	RW
50109	2	Delay	s	unsigned long	0 ... 10	RW
50111	2	Operation in Limit Logic	-	unsigned long	0 = not used	RW
					1 = AND	

Description

3.9 Ethernet port

Offset	Number of registers	Name	Unit	Format	Value range	Access	
50113	2	Source	-	unsigned long	2 =	OR	RW
					0 =	V_L1	
					1 =	V_L2	
					2 =	V_L3	
					3 =	V_L12	
					4 =	V_L23	
					5 =	V_L31	
					6 =	I_L1	
					7 =	I_L2	
					8 =	I_L3	
					9 =	VA_L1	
					10 =	VA_L2	
					11 =	VA_L3	
					12 =	P_L1	
					13 =	P_L2	
					14 =	P_L3	
					15 =	VAR_L1	
					16 =	VAR_L2	
					17 =	VAR_L3	
					18 =	PF_L1	
					19 =	PF_L2	
					20 =	PF_L3	
					21 =	THDV_L1	
					22 =	THDV_L2	
					23 =	THDV_L3	
					24 =	THDI_L1	
					25 =	THDI_L2	
					26 =	THDI_L3	
					27 =	FREQ	
					28 =	V_LN_AVG	
					29 =	V_LL_AVG	
					30 =	I_AVG	
					31 =	VA_SUM	
					32 =	P_SUM	
					33 =	VAR_SUM	
					34 =	PF_SUM	
					35 =	V_BAL	
36 =	I_BAL						
50115	2	Value	-	float	-	RW	
50117	2	Modus ≥ / <	-	unsigned long	0 =	greater than	RW
					1 =	less than	

Table 3-20 Settings parameter for limit value 4

Offset	Number of registers	Name	Unit	Format	Value range	Access
50119	2	ON/OFF	-	unsigned long	0 = OFF	RW
					1 = ON	
50121	2	Hysteresis	%	float	0.0 ... 20.0	RW
50123	2	Delay	s	unsigned long	0 ... 10	RW
50125	2	Operation in Limit Logic	-	unsigned long	0 = not used	RW
					1 = AND	
					2 = OR	
50127	2	Source	-	unsigned long	0 = V_L1	RW
					1 = V_L2	
					2 = V_L3	
					3 = V_L12	
					4 = V_L23	
					5 = V_L31	
					6 = I_L1	
					7 = I_L2	
					8 = I_L3	
					9 = VA_L1	
					10 = VA_L2	
					11 = VA_L3	
					12 = P_L1	
					13 = P_L2	
					14 = P_L3	
					15 = VAR_L1	
					16 = VAR_L2	
					17 = VAR_L3	
					18 = PF_L1	
					19 = PF_L2	
					20 = PF_L3	
					21 = THDV_L1	
					22 = THDV_L2	
					23 = THDV_L3	
					24 = THDI_L1	
					25 = THDI_L2	
					26 = THDI_L3	
					27 = FREQ	
					28 = V_LN_AVG	
					29 = V_LL_AVG	
					30 = I_AVG	

Description

3.9 Ethernet port

Offset	Number of registers	Name	Unit	Format	Value range	Access
					31 = VA_SUM 32 = P_SUM 33 = VAR_SUM 34 = PF_SUM 35 = V_BAL 36 = I_BAL	
50129	2	Value	-	float	-	RW
50131	2	Modus ≥ / <	-	unsigned long	0 = greater than 1 = less than	RW

Table 3-21 Settings parameter for limit value 5

Offset	Number of registers	Name	Unit	Format	Value range	Access
50133	2	ON/OFF	-	unsigned long	0 = OFF 1 = ON	RW
50135	2	Hysteresis	%	float	0.0 ... 20.0	RW
50137	2	Delay	s	unsigned long	0 ... 10	RW
50139	2	Operation in Limit Logic	-	unsigned long	0 = not used 1 = AND 2 = OR	RW
50141	2	Source	-	unsigned long	0 = V_L1 1 = V_L2 2 = V_L3 3 = V_L12 4 = V_L23 5 = V_L31 6 = I_L1 7 = I_L2 8 = I_L3 9 = VA_L1 10 = VA_L2 11 = VA_L3 12 = P_L1 13 = P_L2 14 = P_L3 15 = VAR_L1 16 = VAR_L2 17 = VAR_L3 18 = PF_L1 19 = PF_L2	RW

Offset	Number of registers	Name	Unit	Format	Value range	Access
					20 = PF_L3	
					21 = THDV_L1	
					22 = THDV_L2	
					23 = THDV_L3	
					24 = THDI_L1	
					25 = THDI_L2	
					26 = THDI_L3	
					27 = FREQ	
					28 = V_LN_AVG	
					29 = V_LL_AVG	
					30 = I_AVG	
					31 = VA_SUM	
					32 = P_SUM	
					33 = VAR_SUM	
					34 = PF_SUM	
					35 = V_BAL	
					36 = I_BAL	
50143	2	Value	-	float	-	RW
50145	2	Modus \geq / $<$	-	unsigned long	0 = greater than	RW
					1 = less than	

See also

Modbus measured variables with the function codes 0x03 and 0x04 (Page 40)

Connection examples (Page 82)

3.9.9 MODBUS communication parameter with the function codes 0x03, 0x04 and 0x10

Addressing the communication parameters

Table 3-22 Communication parameters

Offset	Number of registers	Name	Unit	Format	Applicable MODBUS function codes	Value range from ... to	Access								
63001	2	IP address	-	unsigned long	<ul style="list-style-type: none"> • 0x03 • 0x04 • 0x10 	0 ... FFFFFFFFh	RW								
63003	2	Subnet mask	-	unsigned long	<ul style="list-style-type: none"> • 0x03 • 0x04 • 0x10 	0 ... FFFFFFFFh	RW								
63005	2	Gateway	-	unsigned long	<ul style="list-style-type: none"> • 0x03 • 0x04 • 0x10 	0 ... FFFFFFFFh	RW								
63007	2	Bootloader version	-	unsigned long	<ul style="list-style-type: none"> • 0x03 • 0x04 	char, uchar, uchar, uchar	R								
63009	2	Password protection ON/OFF	-	unsigned long	<ul style="list-style-type: none"> • 0x03 • 0x04 	0, 1	R								
63015	2	Ethernet protocol	-	unsigned long	<ul style="list-style-type: none"> • 0x03 • 0x04 • 0x10 	<table border="1" style="border-collapse: collapse;"> <tr> <td style="padding: 2px;">0 =</td> <td style="padding: 2px;">MODBUS TCP</td> </tr> <tr> <td style="padding: 2px;">1 =</td> <td style="padding: 2px;">SEAbus TCP</td> </tr> </table>	0 =	MODBUS TCP	1 =	SEAbus TCP	RW				
0 =	MODBUS TCP														
1 =	SEAbus TCP														
63017	2	Protocol ¹⁾	-	unsigned long	<ul style="list-style-type: none"> • 0x03 • 0x04 • 0x10 	<table border="1" style="border-collapse: collapse;"> <tr> <td style="padding: 2px;">0 =</td> <td style="padding: 2px;">MODBUS RTU</td> </tr> <tr> <td style="padding: 2px;">1 =</td> <td style="padding: 2px;">SEAbus serial</td> </tr> </table>	0 =	MODBUS RTU	1 =	SEAbus serial	RW				
0 =	MODBUS RTU														
1 =	SEAbus serial														
63019	2	MODBUS address or Seabus address ¹⁾	-	unsigned long	<ul style="list-style-type: none"> • 0x03 • 0x04 • 0x10 	1 ... 247	RW								
63021	2	Baudrate ¹⁾	-	unsigned long	<ul style="list-style-type: none"> • 0x03 • 0x04 • 0x10 	0 = 4,800 bit/s 1 = 9,600 bit/s 2 = 19,200 bit/s 3 = 38,400 bit/s Default value = 2	RW								
63023	2	Data bits / Parity bits / Stop bits ¹⁾	-	unsigned long	<ul style="list-style-type: none"> • 0x03 • 0x04 • 0x10 	<table border="1" style="border-collapse: collapse;"> <tr> <td style="padding: 2px;">0 =</td> <td style="padding: 2px;">8N2</td> </tr> <tr> <td style="padding: 2px;">1 =</td> <td style="padding: 2px;">8E1</td> </tr> <tr> <td style="padding: 2px;">2 =</td> <td style="padding: 2px;">8O1</td> </tr> <tr> <td style="padding: 2px;">3 =</td> <td style="padding: 2px;">8N1</td> </tr> </table>	0 =	8N2	1 =	8E1	2 =	8O1	3 =	8N1	RW
0 =	8N2														
1 =	8E1														
2 =	8O1														
3 =	8N1														
63025	2	Response time ¹⁾	ms	unsigned long	<ul style="list-style-type: none"> • 0x03 • 0x04 • 0x10 	0 ... 255 0 = Auto	RW								

1) Only for the PAC RS485 expansion module

See also

Modbus measured variables with the function codes 0x03 and 0x04 (Page 40)

3.9.10 Modbus device information with the function codes 0x03, 0x04 and 0x10

Addressing the device information parameters

You access the following device information parameters block-by-block only, e.g. read from Offset 64001 27 Register.

NOTICE
<p>Error in the case of inconsistent access to I&M data</p> <p>Please ensure the start offset and the number of registers are correct when making read accesses and write accesses. Always read or write the entire block.</p> <p>Please ensure the start offset and the number of registers are correct when making write accesses.</p> <p>If a value consists of several registers, a read command applied in the second register, for example, will generate an error code. SENTRON PAC will also output an error code if, for example, a write operation ends in the middle of a multi-register value.</p>

Table 3-23 I&M 0 parameter of the SENTRON PAC Power Monitoring Device with the function codes 0x03 and 0x04

Offset	Total registers	Number of registers per parameter	Name	Format	Value range from ... to	Access
Start offset 64001	27	[1]	Manufacturer's ID	unsigned short	0 ... 65535 Standard: 42*)	R
[64002]		[10]	Order No.	Char 20	ASCII	R
[64012]		[8]	Serial number	Char 16	ASCII	R
[64020]		[1]	Hardware version	unsigned short	0 ... 65535	R
[64021]		[2]	Firmware version	1 char, 3 unsigned char	V 0.0.0 ... V 255.255.255	R
[64023]		[1]	Counter for changes	unsigned short	1 ... 65535	R
[64024]		[1]	Profile ID	unsigned short	3A00 ... F6FF	R
[64025]		[1]	Specific Profile ID	unsigned short	-	R
[64026]		[1]	Version of the I&M data	2 unsigned char	0.0 ... 255.255	R
[64027]		[1]	Supported I&M data	unsigned short	00 ... FF	R

*) 42 stands for Siemens AG

Table 3-24 I&M 1-4 parameters with the function codes 0x03, 0x04 and 0x10

Offset	Total registers	Number of registers per parameter	Name	Format	Value range from ... to	Access
Start offset 64028	89	[16]	Plant identifier	Char 32	ASCII	RW
[64044]		[11]	Location identifier	Char 22	ASCII	RW
[64055]		[8]	Installation date	Char 16	ASCII	RW
[64063]		[27]	Comment	Char 54	ASCII	RW
[64090]		[27]	Signature	Char 54	-	RW

Table 3-25 I&M 0 parameter of the module in slot 1 with the function codes 0x03 and 0x04

Offset	Total registers	Number of registers per parameter	Name	Format	Value range from ... to	Access
Start offset 64117	27	[1]	Manufacturer's ID	unsigned short	0 ... 65535 Standard: 42 ^{*)}	R
[64118]		[10]	Order No.	Char 20	ASCII	R
[64128]		[8]	Serial number	Char 16	ASCII	R
[64136]		[1]	Hardware version	unsigned short	0 ... 65535	R
[64137]		[2]	Firmware version	1 char, 3 unsigned char	V 0.0.0 ... V 255.255.255	R
[64139]		[1]	Counter for changes	unsigned short	1 ... 65535	R
[64140]		[1]	Profile ID	unsigned short	3A00 ... F6FF	R
[64141]		[1]	Specific Profile ID	unsigned short	-	R
[64142]		[1]	Version of the I&M data	2 unsigned char	0.0 ... 255.255	R
[64143]		[1]	Supported I&M data	unsigned short	00 ... FF	R

*) 42 stands for Siemens AG

See also

Modbus measured variables with the function codes 0x03 and 0x04 (Page 40)

3.9.11 Modbus command parameters

Addressing the command parameters

You can use MODBUS function code 0x06 on the command parameters.

Table 3-26 Command parameters

Offset	Number of registers	Name	Unit	Format	Value range from ... to	Access	
60002	1	Reset maximum values	-	unsigned short	0	W	
60003	1	Reset minimum values	-	unsigned short	0	W	
60004	1	Reset energy counter	-	unsigned short	0 =	All	W
					1 =	Active Energy Import Tariff 1	
					2 =	Active Energy Import Tariff 2	
					3 =	Active Energy Export Tariff 1	
					4 =	Active Energy Export Tariff 2	
					5 =	Reactive Energy Import Tariff 1	
					6 =	Reactive Energy Import Tariff 2	
					7 =	Reactive Energy Export Tariff 1	
					8 =	Reactive Energy Export Tariff 2	
					9 =	Apparent Energy Tariff 1	
					10 =	Apparent Energy Tariff 2	
60005	1	Synchronization of the demand period	Min.	unsigned short	1 ... 60	W	
60006	1	Switching tariff	-	unsigned short	0 =	High tariff	W
					1 =	Low tariff	
60007	1	Acknowledge the diagnostics bit ¹⁾ (cf. stored bits in unsigned long beginning offset 205)	-	unsigned short	0 ... ffffh	W	
60008	1	Switching outputs (if parameterized)	-	unsigned short	0 = output 0	OFF	W
					1 = output 0	ON	

Description

3.9 Ethernet port

Offset	Number of registers	Name	Unit	Format	Value range from ... to	Access
60009	1	Switching command for vector group	-	unsigned short	High 0 ... 99, Low 0 ... 1 High byte group assignment Low byte 1 = ON, 0 = OFF	W
65300	1	Activation of a changed IP configuration/ Ethernet configuration	-	unsigned short	0	W

1) The MODBUS master must acknowledge these diagnostics bits.

See also

Modbus measured variables with the function codes 0x03 and 0x04 (Page 40)

3.9.12 MODBUS standard device identification with the function code 0x2B

Addressing the MODBUS standard device identification

You can use MODBUS function code 0x2B on these device identification parameters.

Table 3-27 MODBUS standard device identification parameters

Object ID	Name	Format	Access
OID 0	Manufacturer	String	R
OID 1	Manufacturer device name	String	R
OID 2	Firmware version / bootloader version	String	R

See also

Modbus measured variables with the function codes 0x03 and 0x04 (Page 40)

3.10 Slot for expansion modules

Interface

The SENTRON PAC3200 has one slot (MOD1) for installing optionally available expansion modules. Only communication modules such as the PAC PROFIBUS DP expansion module can be used. Please consult the current catalogs to find out which modules are available for the SENTRON PAC3200.

The second slot (MOD2) has no function on the SENTRON PAC3200.

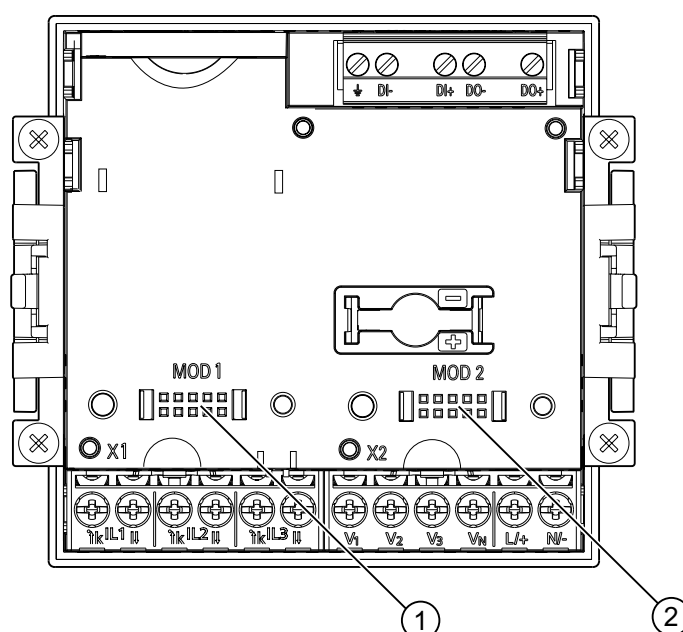

Figure 3-13 SENTRON PAC3200 with screw terminals, rear

- (1) MOD 1, connection that can be used on SENTRON PAC3200
- (2) MOD 2, cannot be used on SENTRON PAC3200

CAUTION

Avoid contamination of the contact area below the label "MOD1" since otherwise the expansion module cannot be connected or can even be damaged. Insertion of metal pins or wires into the contact openings can result in device failure.

You can find more detailed information on the PAC PROFIBUS DP expansion module in the operating instructions and the manual of the PAC PROFIBUS DP expansion module.

3.11 Slots on the rear of the device

Slot on the rear of the device

The SENTRON PAC3200 does not have a card reading device and does not require a battery. The insertion openings visible on the rear of the SENTRON PAC3200 cannot be used and are blanked off.

NOTICE

Housing slots on the rear of the device

Do not insert any objects into the housing slots on the rear of the device. Inserted objects cannot be removed.

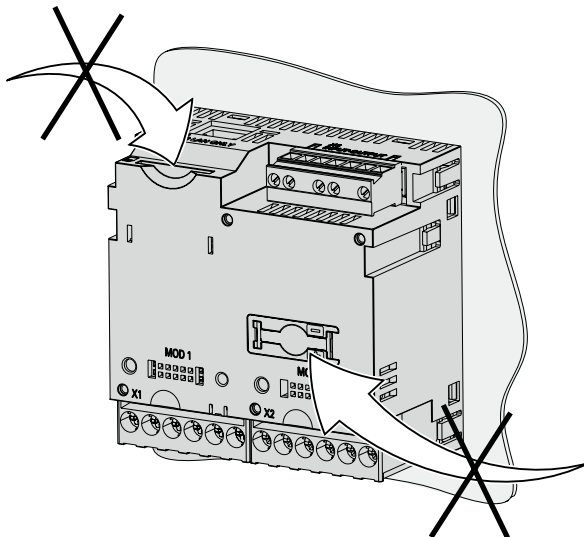

Figure 3-14 Not available for use! Slot for memory card and battery compartment

Operation planning

4.1 Operation planning

Mounting location

The SENTRON PAC3200 device is intended for installation in permanently installed switching panels within closed rooms.

Conductive panels and doors on control cabinets must be grounded. The doors of the control cabinet must be connected to the control cabinet using a grounding cable.

Mounting position

The device must be installed vertically.

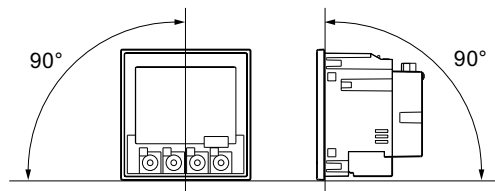

Figure 4-1 Mounting position

The preferred viewing angle is 6 o'clock (bottom view).

Installation space and ventilation

Sufficient clearance must be maintained between the device and neighboring components in order to comply with the permissible operating temperature. You can find dimension specifications in the "Dimension drawings" chapter.

Plan additional space for:

- Ventilation
- Wiring
- RJ45 plug connector and cable feed on the top of the device
- Optionally connectable expansion module on the rear of the device, including connector and cable feed

 **CAUTION**

Ensure ventilation

Please ensure that the ventilation slots of the housing are not obstructed. The wiring, cable feed or other components must not obstruct ventilation.

Environmental conditions

Only use the SENTRON PAC3200 device where the environmental conditions permit its operation:

Temperature range	
• Operating temperature range	- 10 °C through + 55 °C
• Storage temperature range	- 25 °C through + 70 °C
Relative humidity	95% at 25°C without condensation (normal conditions)
Operating altitude above sea level	Up to 2000 m
Degree of pollution	2
Degree of protection according to IEC 60529	
• Front	IP65
• Rear	IP20, NEMA 1A

Temperature compensation

To avoid condensation, the device must be stored at the operating location for at least 2 hours before power is connected.

See also

Dimension drawings (Page 167)

Installation

5.1 Unpacking

Observe the ESD Guidelines. Open the packaging carefully. Do not use excessive force.

Check the packaging

Carry out the following checks after receipt of the device and before installation:

- Ensure the packaging is undamaged.
- Make sure that the contents of the package are complete.
- Check the device for external damage.

Please contact your Siemens sales partner in the following cases:

- The packaging is damaged
- The contents of the package are not complete
- The device is damaged.



! WARNING

Damaged devices

Damaged devices may show signs of safety defects. They can result in serious injury and property damage.

Do not install or start up damaged devices.

Storage

Store the SENTRON PAC3200 in dry conditions.

NOTICE

Avoid condensation

Sudden fluctuations in temperature can lead to condensation. Condensation can affect the function of the device. Store the device in the operating room for at least 2 hours before commencing installation.

Installation

Install the expansion module before starting up the SENTRON PAC3200.

5.2 Tools

You require the following tools for installation:

- Cutting tool for the panel cutout
- Screwdriver PH2 cal. ISO 6789

Additional installation tools

You also require a self-adhesive cable clamp for strain relief.

5.3 Mounting dimensions

Mounting and clearance dimensions

You can find information on the cutout dimensions, frame dimensions and clearances in the Chapter "Dimension drawings".

See also

Dimension drawings (Page 167)

5.4 Installation steps

Proceed as follows to install the SENTRON PAC3200 in the switching panel:

Procedure

1. Cut a hole in the panel measuring $92.0^{+0.8} \times 92.0^{+0.8}$ mm² (if not already available).
2. Discharge any static from your body. Observe the ESD guidelines in the Appendix.

 CAUTION
Electrostatic sensitive devices Discharge your body of any static electricity! Touch the grounded control cabinet, for example, or a metal part that is connected to the building ground (heater, steel support).

3. Insert the device into the cutout from outside (Fig. "Installation cutout A").
4. Carry out all other installation steps from the inside of the switching panel.

5. Clamp the device to the switching panel with the two brackets provided (Fig. "Installation step B"). To do this, proceed as follows:
 - Hold the device firmly with one hand
 - Hang the brackets onto the left and right sides of the housing.
To do so, insert the lugs of the bracket (2) into the slot on the housing (1).
 - Tighten the locking hook.
To do so, place your index finger and middle finger on the support arms as shown in the Fig. "Installation step C" and engage the locking hook with your thumb.
The engage mechanism of both brackets enables the installation engineer to secure the device in the switching panel quickly and without tools.
If a higher level of protection is desired, the pressure can be increased evenly on all sides with the help of the four screws of the brackets.
6. Tighten the 4 screws evenly in the two brackets; tightening torque 0.025 to 0.03 Nm (Fig. "Installation step D"). The front of the switching panel is fully sealed with the standard, integrally extruded seal.
7. When using the Ethernet interface:
 - Ensure strain relief for the RJ45 connector.
Secure the Ethernet cable to the panel for this purpose. Fix the cable in position as shown in the Fig. "Installation - E" at location (3) using a self-adhesive cable clamp or other suitable small installation accessory.
8. An optional expansion module can be connected. You can find the installation instructions in the operating instructions of the expansion module.

Installation is complete.

NOTICE
Ensure that no tools or other potentially hazardous objects have been left at the installation location.

Installation steps

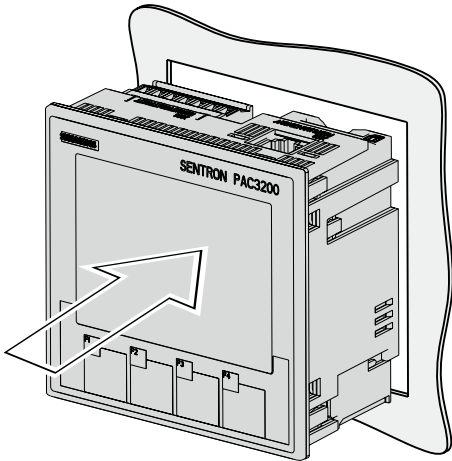

Installation step A, device with screw terminals

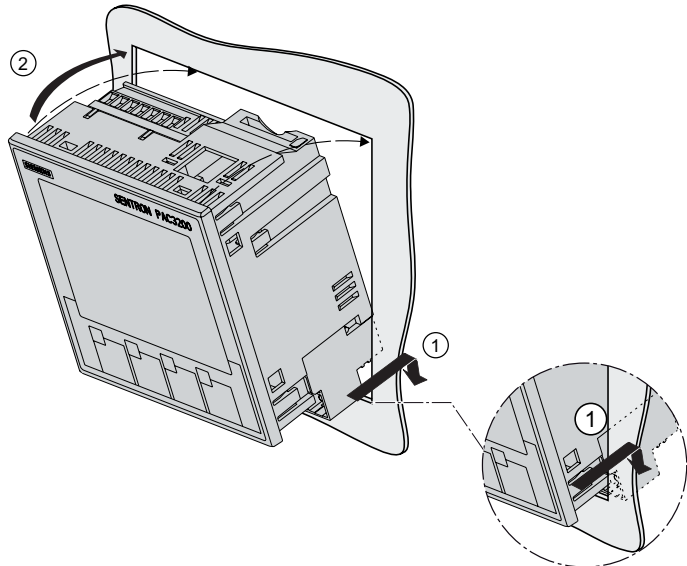

Installation step A, device with ring lug terminals

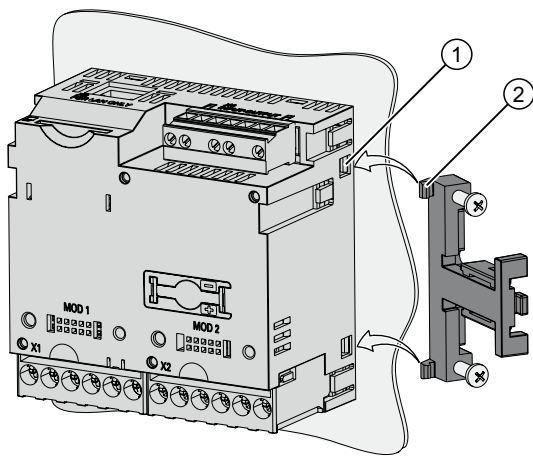

Installation step B

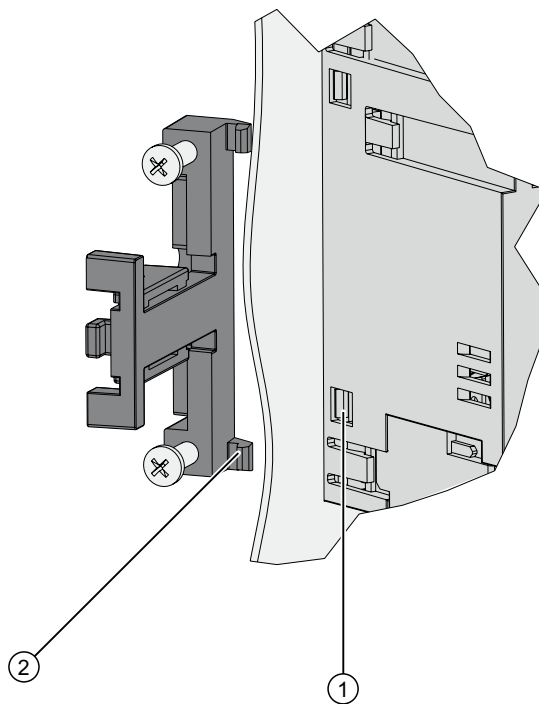

Installation step B, detail

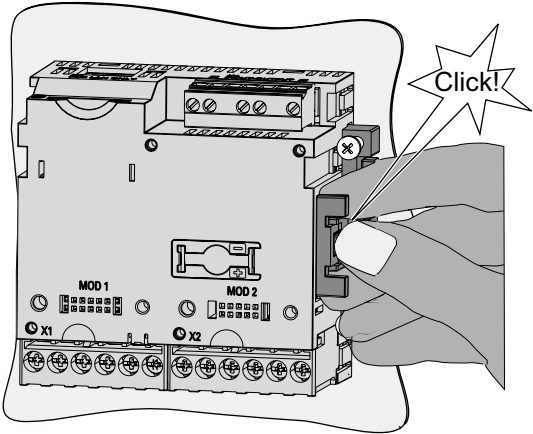

Installation step C

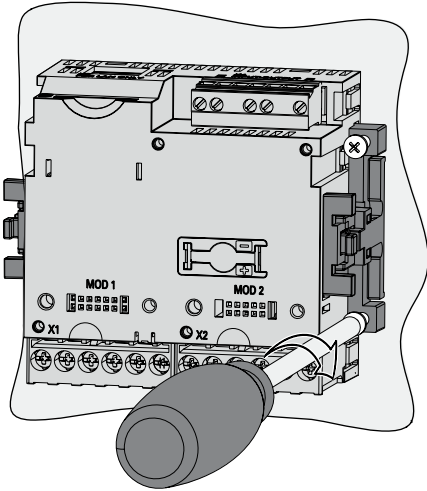

Installation step D

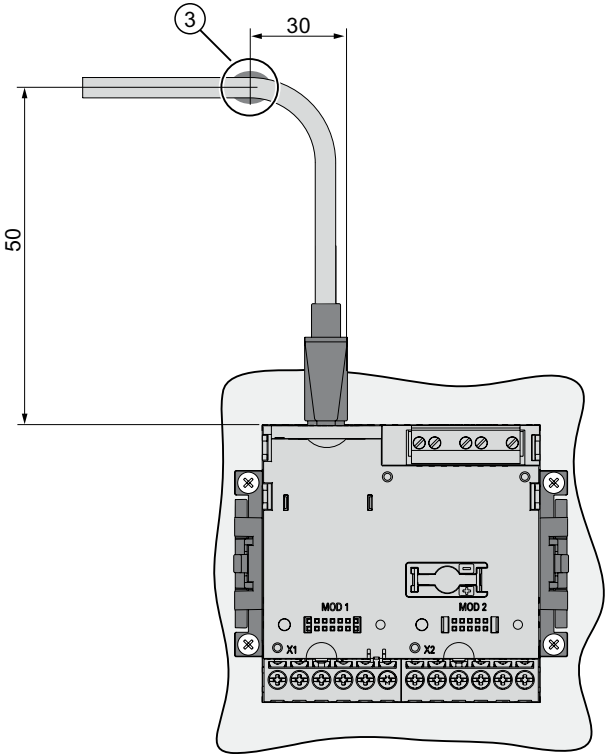

Figure 5-1 Installation step E - Strain relief for RJ45 connector

5.5 Deinstalling

Tools

You require the following tools to deinstall the device:

- PH2 screwdriver
- Slotted screwdriver

Deinstallation steps

1. Discharge any static from your body in accordance with the ESD guidelines.

CAUTION

Electrostatic sensitive devices
--

Ground your body! Discharge your body of any static electricity!
--

2. Start deinstallation on the inside of the switching panel.
3. Release the clamping arrangement on the switching panel. To do so, unscrew the four screws on the two brackets. Leave the screws in the brackets.
4. Hold the bracket as shown in the figure "Deinstallation".

 CAUTION

Mechanical tension

When releasing the locking hooks, the bracket may spring outwards from the device.
--

5. Carefully lever the locking hooks open with the slotted screwdriver or another suitable tool. The bracket releases immediately.
6. Go to the outside of the switching panel and remove the device from the cutout.
7. Pack the device into the original box together with the operating instructions and the delivered components listed in the operating instructions.

Deinstallation is complete.

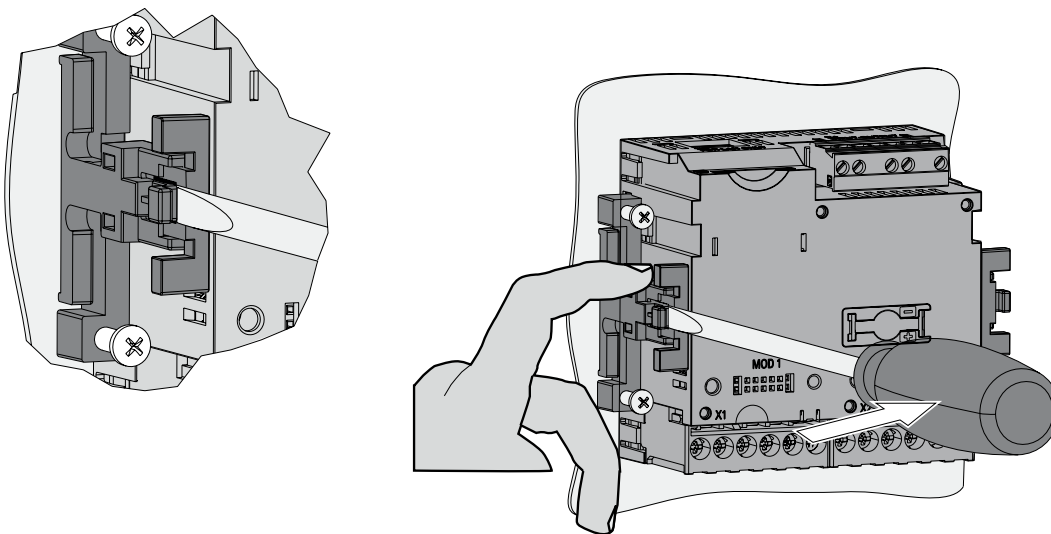

Figure 5-2 Deinstallation, releasing the locking hooks

Connection

6.1 Safety notes

Instructions



DANGER

Dangerous high voltages

Will cause death, serious injury or property damage.

The country-specific standards for setting up power systems must be taken into account when carrying out the electrical installation.

The following tasks are partly carried out when hazardous voltage is present. For this reason, they must only be carried out by qualified personnel who are familiar with and follow the safety regulations and cautionary measures.

Wear the prescribed protective clothing. Observe the general equipment regulations and safety regulations for working with high-voltage installations (e.g. DIN VDE, NFPA 70E as well as national or international regulations).

The limits given in the technical data must not be exceeded even at startup or when testing the device.

The secondary connections of intermediate current transformers must be short-circuited at the transformers before the current lines to the device are interrupted.

The polarity and phase assignment of the measuring transformer must be tested.

Before connecting the device, you must check that the system voltage agrees with the voltage specified on the type plate.

Check that all connections are correctly made before startup.

Ensure the polarity is correct when connecting a DC supply voltage.

Before power is applied to the device for the first time, it must have been located in the operating area for at least two hours in order to reach temperature balance and avoid humidity and condensation.

Condensation on the device is not permissible during operation.

Note

Qualified Personnel

In the context of the safety information in the user documentation, a qualified person is a person who is familiar with assembling, installing, commissioning, and operating the product and who has the relevant qualifications, such as:

- Training or instruction/authorization in operating and maintaining devices and systems according to the safety regulations for electrical circuits and devices.
 - Is trained in the proper care and use of protective equipment in accordance with established safety practices.
 - First aid training.
-

See also

Applying the measuring voltage (Page 100)

Applying the measuring current (Page 101)

Applying the supply voltage (Page 92)

Safety notes (Page 17)

6.2 Connections

Connection designations - device with screw terminals

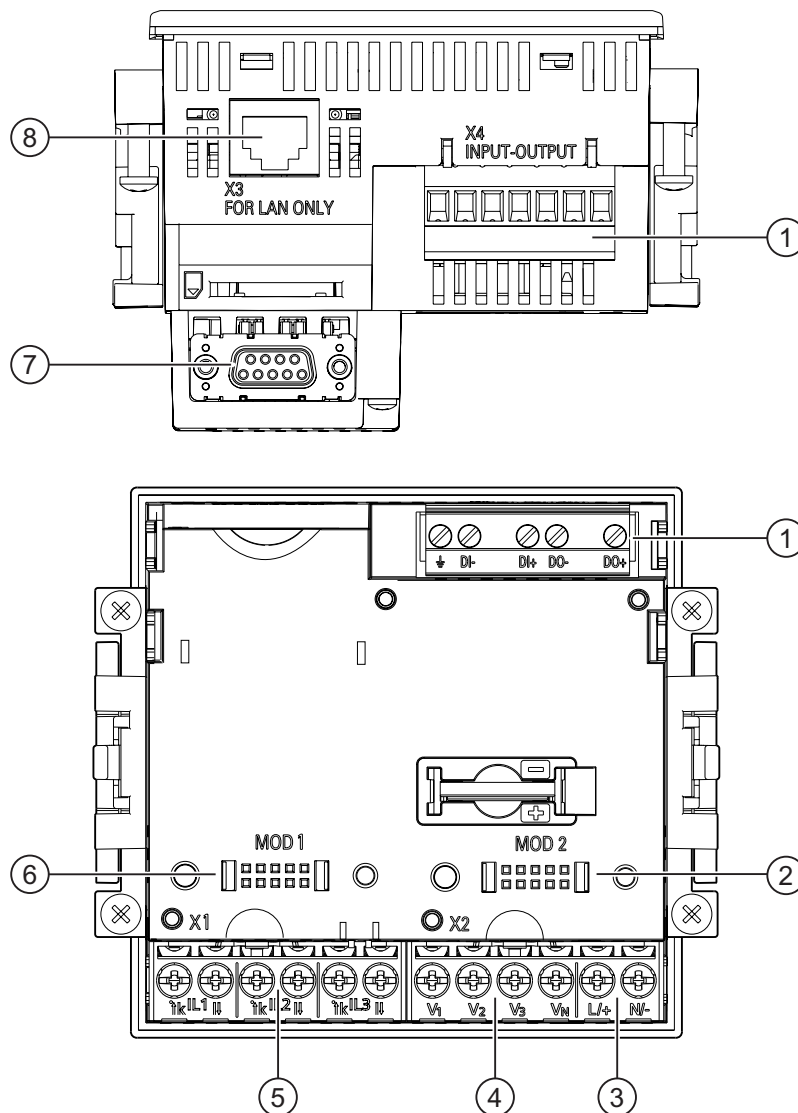

Figure 6-1 Connection designations, view of the rear and top of the device with screw terminals

- (1) Digital inputs and outputs, reference potential
- (2) Dummy connection. Cannot be used as a slot!
- (3) Supply voltage L+, N/-
- (4) Measuring inputs voltage V_1 , V_2 , V_3 , V_N
- (5) Measuring inputs current IL1, IL2, IL3
- (6) Slot for optional expansion modules
- (7) Optional expansion module, not included in scope of supply
- (8) Ethernet port, RJ45

Connection designations - device with ring lug terminals

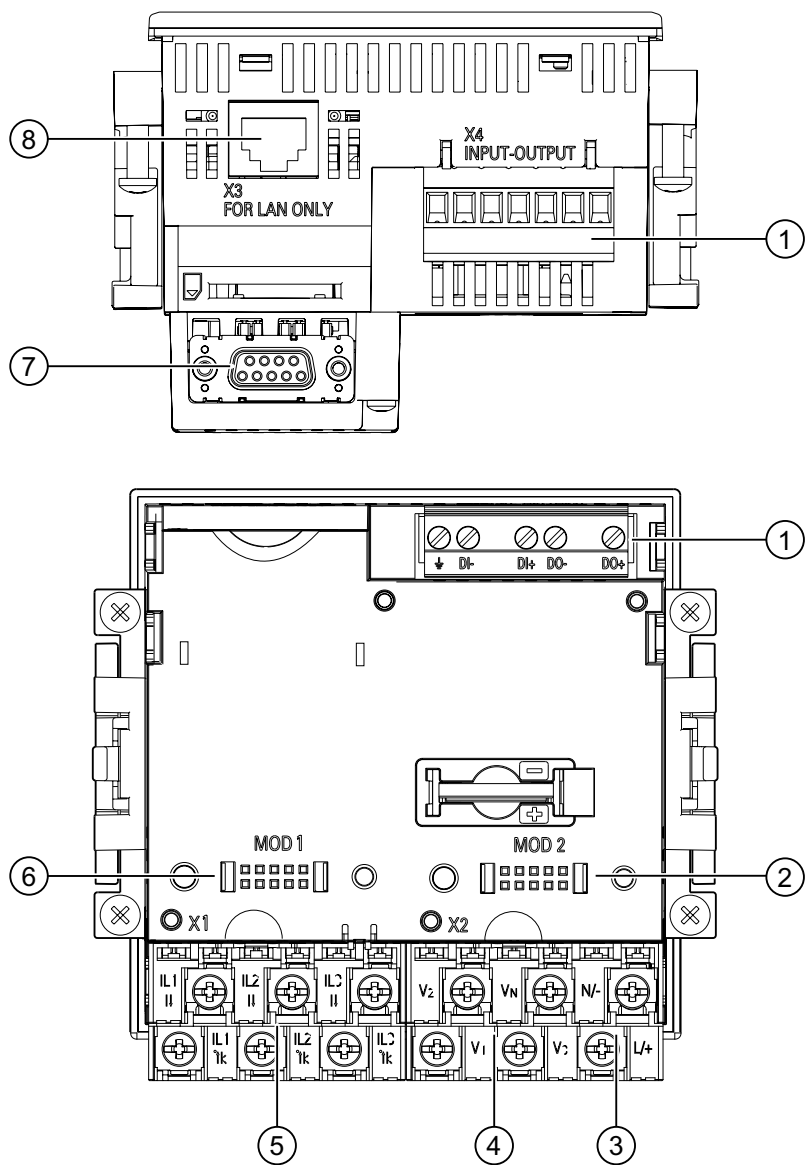

Figure 6-2 Connection designations, view of the rear and top of the device with ring lug terminals

- (1) Digital inputs and outputs, reference potential
- (2) Dummy connection. Cannot be used as a slot!
- (3) Supply voltage L+, N/-
- (4) Measuring inputs voltage V_1 , V_2 , V_3 , V_N
- (5) Measuring inputs current IL1, IL2, IL3
- (6) Slot for optional expansion modules
- (7) Optional expansion module, not included in scope of supply
- (8) Ethernet port, RJ45



! DANGER

Danger! High voltage
Will cause death, serious injury or considerable property damage.

Please observe the safety information on the device and in the operating instructions and the manual.

Note

Use of devices with ring lug terminals

Designed for use in:

- NAFTA / USA
- Regions in which open terminals are permitted.

Terminal labeling - device with screw terminals

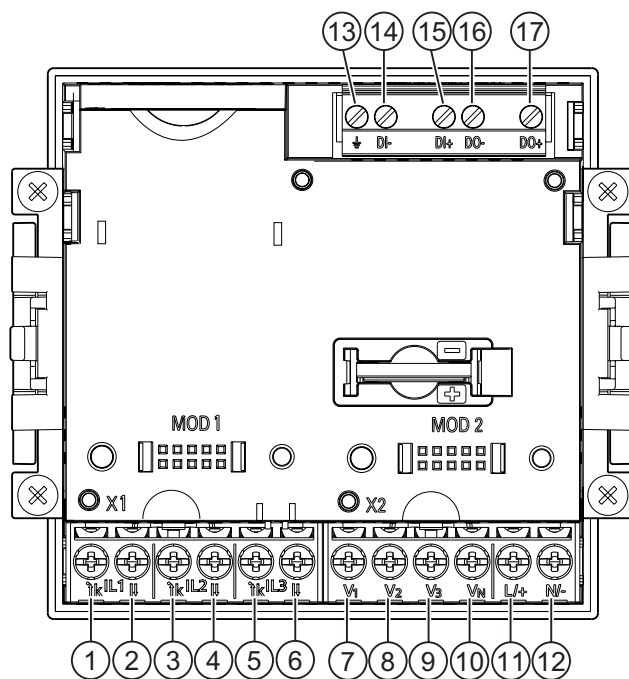

Figure 6-3 Terminal labeling with screw terminals

No.	Terminal		Function
(1)	IL1	·k	Phase current I_{L1} , input
(2)	IL1	l	Phase current I_{L1} , output
(3)	IL2	·k	Phase current I_{L2} , input
(4)	IL2	l	Phase current I_{L2} , output
(5)	IL3	·k	Phase current I_{L3} , input

6.2 Connections

No.	Terminal		Function
(6)	IL3	I	Phase current I _{L3} , output
(7)	V ₁		Phase-to-neutral voltage V _{L1}
(8)	V ₂		Phase-to-neutral voltage V _{L2}
(9)	V ₃		Phase-to-neutral voltage V _{L3}
(10)	V _N		Neutral conductor V _N
(11)	L/+		AC: Connection: Conductor (phase-to-neutral voltage) DC: Connection: +
(12)	N/-		AC: Connection: Neutral conductor DC: Connection: -
(13)	⊥		Reference potential
(14)	DI-		Digital input -
(15)	DI+		Digital input +
(16)	DO-		Digital output -
(17)	DO+		Digital output +

Terminal designation - device with ring lug terminals

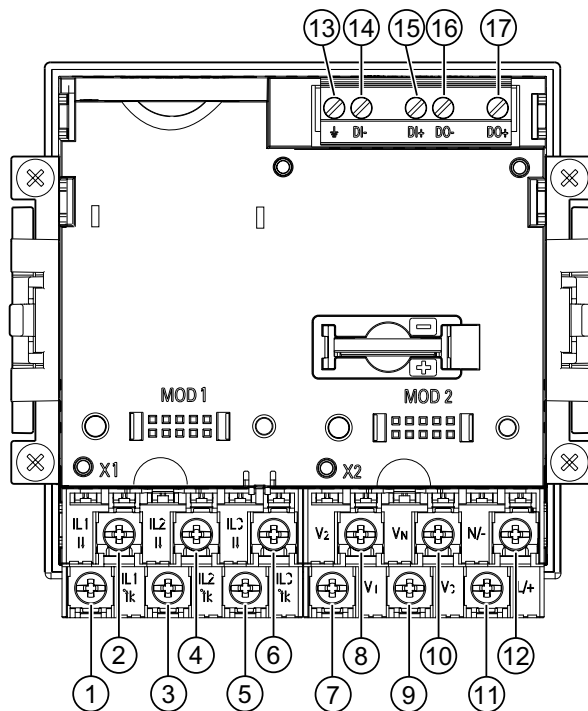

Figure 6-4 Labeling of the ring lug terminals

No.	Terminal		Function
(1)	IL1	k	Phase current I _{L1} , input
(2)	IL1	I	Phase current I _{L1} , output
(3)	IL2	k	Phase current I _{L2} , input

No.	Terminal		Function
(4)	IL2	I	Phase current I _{L2} , output
(5)	IL3	k	Phase current I _{L3} , input
(6)	IL3	I	Phase current I _{L3} , output
(7)	V ₁		Phase-to-neutral voltage V _{L1}
(8)	V ₂		Phase-to-neutral voltage V _{L2}
(9)	V ₃		Phase-to-neutral voltage V _{L3}
(10)	V _N		Neutral conductor V _N
(11)	L/+		AC: Connection: Conductor (phase-to-neutral voltage) DC: Connection: +
(12)	N/-		AC: Connection: Neutral conductor DC: Connection: -
(13)	\perp		Reference potential
(14)	DI-		Digital input -
(15)	DI+		Digital input +
(16)	DO-		Digital output -
(17)	DO+		Digital output +

Grounding

Conductive panels and doors on control cabinets must be grounded. The doors of the control cabinet must be connected to the control cabinet using a grounding cable.

Reference potential

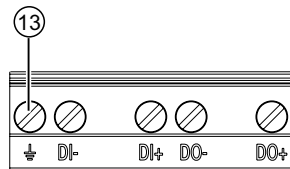



Figure 6-5 Terminal block: digital input and output, reference potential

(13) Reference potential terminal

The connection \perp "reference potential" discharges interference affecting the digital input and output and the RJ45 connector.

Connect the reference potential to the equipotential bonding strip in the control cabinet.

Supply voltage fuse protection

 CAUTION
Damage to the device due to non-fused supply voltage Damage to the device and the equipment may occur. Secure the supply voltage with an approved (UL / IEC) fuse: <ul style="list-style-type: none">• SENTRON PAC3200 with multi-range power supply 0.6 A, Type C.• SENTRON PAC3200 with extra-low voltage power supply 1.0 A, Type C.

If a fusible link is used, a suitable approved (UL / IEC) fuse holder has to be used. In addition, a suitable isolating device shall be connected upstream in order to permit disconnection of the device from the power supply.

Protecting the current measuring inputs



 DANGER
Electric shock and arc flashover in the case of open transformer circuits Will cause death, serious injury or considerable property damage. It is only possible to measure the current with current transformers . The circuits must NOT be protected with a fuse here! Never open the secondary circuit of the current transformers under load. Short-circuit the secondary current terminals of the current transformer before removing the device. The safety information for the current transformers used must be followed!

Protecting the voltage measuring inputs

 CAUTION
Damage to the device due to non-fused voltage measuring inputs Damage to the device and the equipment may occur. In the case of a direct connection and transformer connection , the device has to be safeguarded with an approved (UL / IEC) 10A backup fuse or an approved (UL / IEC) 10 A miniature circuit breaker . When using voltage transformers, their secondary connections must never be short-circuited.

6.3 Connecting the cables to the terminals

Connecting cables to the screw terminal

Tool: PZ2 cal. screwdriver ISO 6789

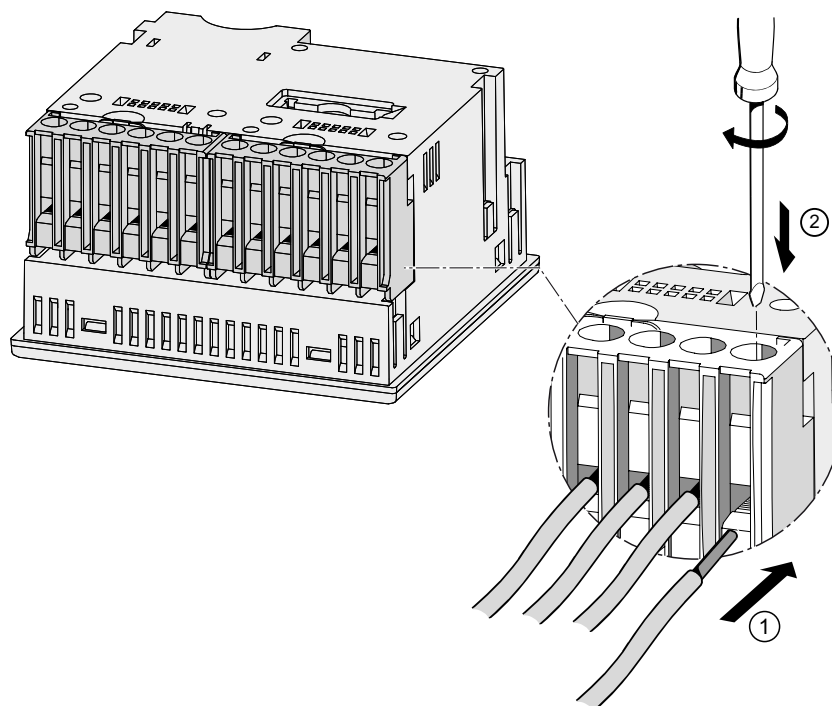

Figure 6-6 Connecting cables to the screw terminal

Connecting the cables to the ring lug terminals:

Note

The **SENTRON PAC3200 with ring lug terminal** is only intended for:

- use in NAFTA / USA
- Regions in which open terminals are permitted.



⚠ WARNING

Improper connection may result in death, serious injury, or property damage.

Ring lug terminals are intended exclusively for connecting ring lugs. Please ensure that the ring lugs are properly attached to the ends of the cables.

Tool: PZ2 cal. screwdriver ISO 6789

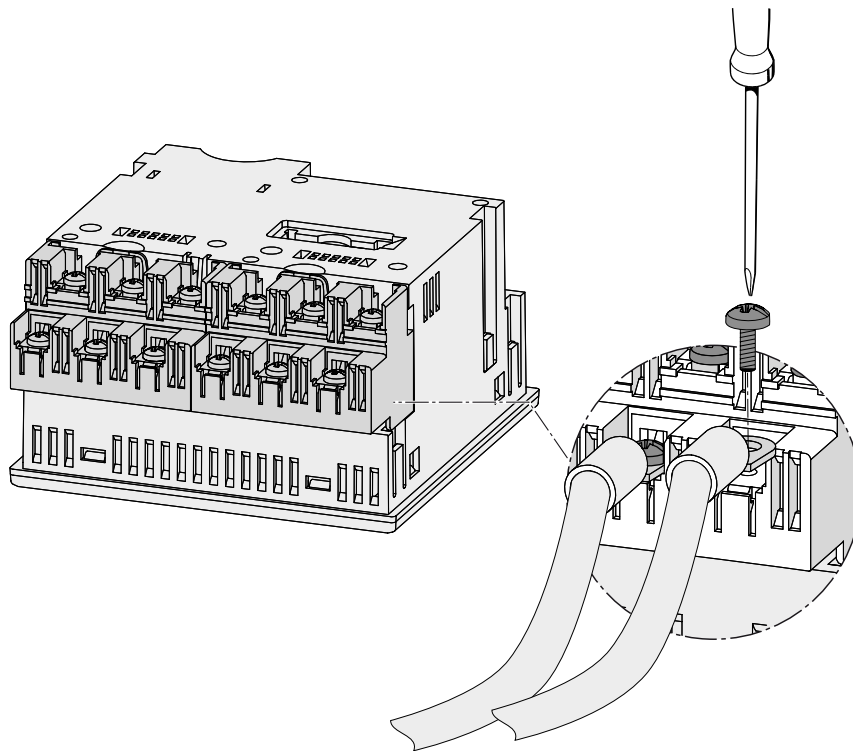

Figure 6-7 Connecting the cables to the ring lug terminals:

6.4 Connection examples

Some connection examples are listed below: They show connection in:

- Two-, three- or four-wire systems
- With balanced or unbalanced load
- With/without voltage transformer
- with current transformer

The device can be operated up to the maximum permissible voltage values with or without voltage measuring transformers.

It is only possible to measure the current with current transformers.

All input or output terminals not required for measuring remain free.

The wiring method must be made known to the device in the device settings. The connection types given below refer to the device parameterization.

Connection examples

(1) Three-phase measuring, four conductors, unbalanced load, without voltage transformers, with three current transformers

Connection type 3P4W

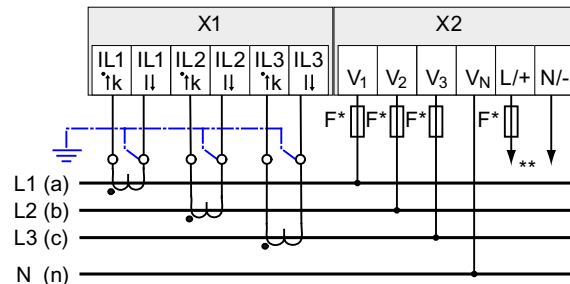

Figure 6-8 Connection type 3P4W, without voltage transformer, with three current transformers

- * Fuses must be provided by the customer.
- ** Connection of supply voltage

(2) Three-phase measuring, four conductors, unbalanced load, with voltage transformers, with three current transformers

Connection type 3P4W

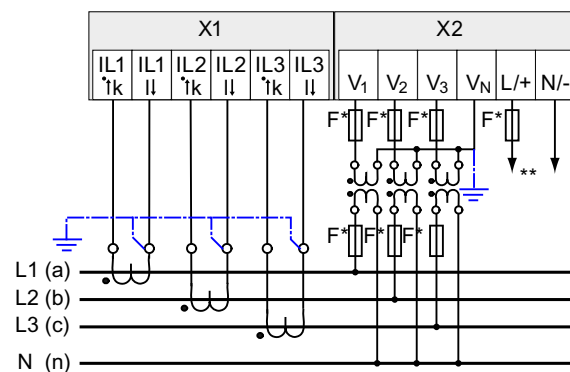

Figure 6-9 Connection type 3P4W, with voltage transformer, with three current transformers

- * Fuses must be provided by the customer.
- ** Connection of supply voltage

(3) Three-phase measuring, four conductors, balanced load, without voltage transformers, with one current transformer

Connection type 3P4WB

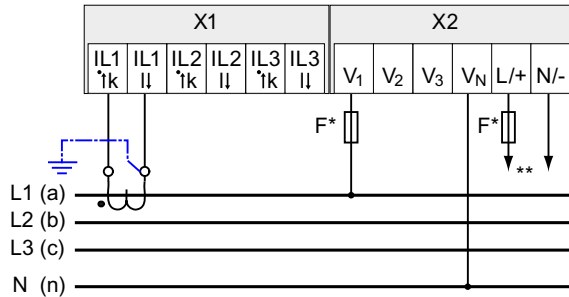

Figure 6-10 Connection type 3P4WB, without voltage transformer, with one current transformer

- * Fuses must be provided by the customer.
- ** Connection of supply voltage

(4) Three-phase measuring, four conductors, balanced load, with voltage transformers, with one current transformer

Connection type 3P4WB

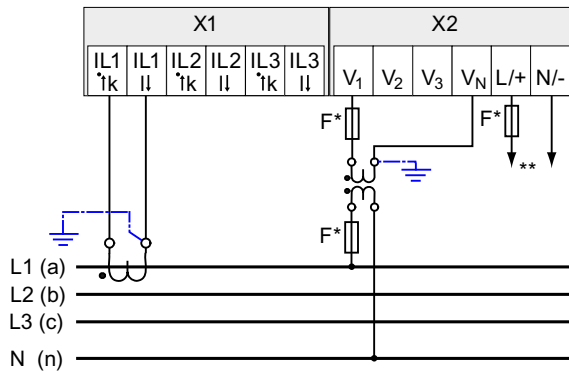

Figure 6-11 Connection type 3P4WB, with voltage transformer, with one current transformer

- * Fuses must be provided by the customer.
- ** Connection of supply voltage

(5) Three-phase measuring, three conductors, unbalanced load, without voltage transformers, with three current transformers

Connection type 3P3W

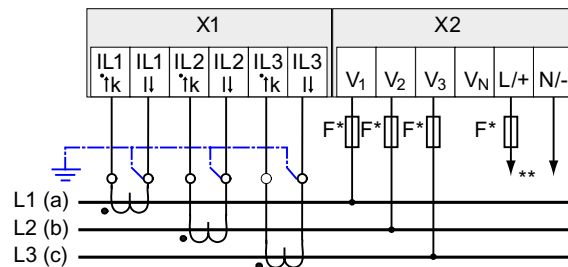

Figure 6-12 Connection type 3P3W, without voltage transformer, with three current transformers

- * Fuses must be provided by the customer.
- ** Connection of supply voltage

(6) Three-phase measuring, three conductors, unbalanced load, with voltage transformers, with three current transformers

Connection type 3P3W

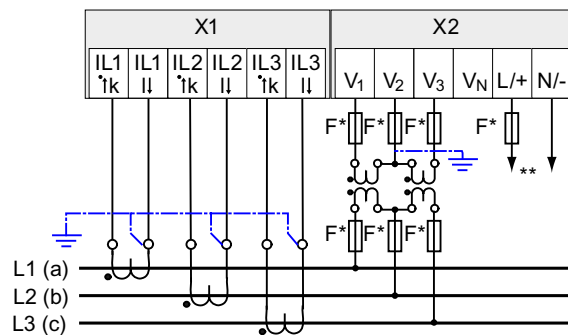

Figure 6-13 Connection type 3P3W, with voltage transformer, with three current transformers

- * Fuses must be provided by the customer.
- ** Connection of supply voltage

(7) Three-phase measuring, three conductors, unbalanced load, without voltage transformers, with two current transformers

Connection type 3P3W

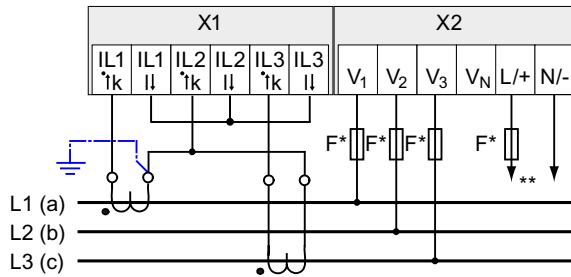

Figure 6-14 Connection type 3P3W, without voltage transformer, with two current transformers

- * Fuses must be provided by the customer.
- ** Connection of supply voltage

(8) Three-phase measuring, three conductors, unbalanced load, with voltage transformers, with two current transformers

Connection type 3P3W

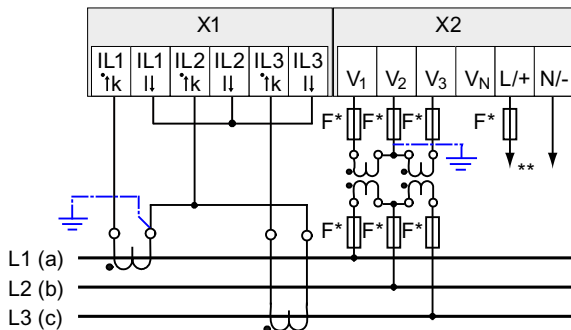

Figure 6-15 Connection type 3P3W, with voltage transformer, with two current transformers

- * Fuses must be provided by the customer.
- ** Connection of supply voltage

(9) Three-phase measuring, three conductors, balanced load, without voltage transformers, with one current transformer

Connection type 3P3WB

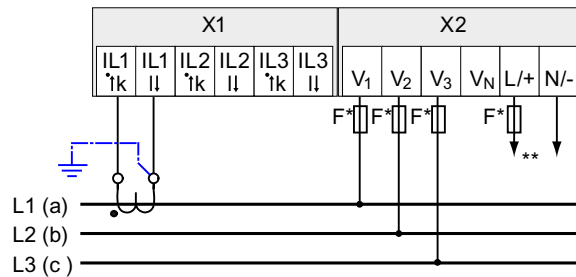

Figure 6-16 Connection type 3P3WB, without voltage transformer, with one current transformer

- * Fuses must be provided by the customer.
- ** Connection of supply voltage

(10) Three-phase measuring, three conductors, balanced load, with voltage transformers, with one current transformer

Connection type 3P3WB

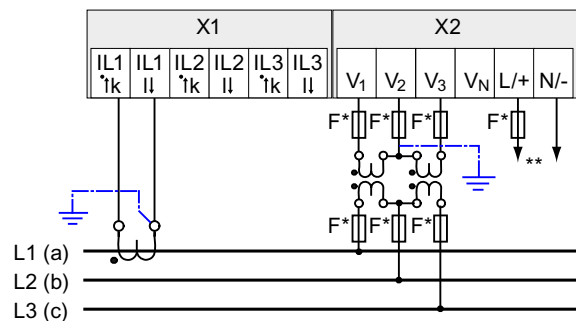

Figure 6-17 Connection type 3P3WB, with voltage transformer, with one current transformer

- * Fuses must be provided by the customer.
- ** Connection of supply voltage

(11) Two-phase measuring, three conductors, unbalanced load, without voltage transformers, with two current transformers

Connection type 3P4W

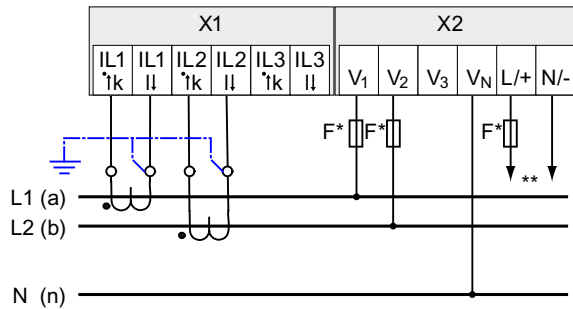

Figure 6-18 Connection type 3P4W, without voltage transformer, with two current transformers

* Fuses must be provided by the customer.

** Connection of supply voltage

The device indicates 0 (zero) V for L3.

(12) Single-phase measuring, two conductors, without voltage transformers, with one current transformer

Connection type 1P2W

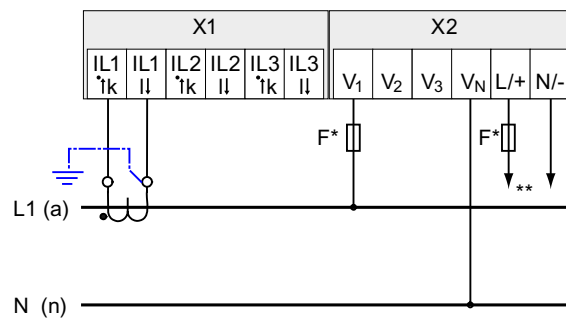

Figure 6-19 Connection type 1P2W, without voltage transformer, with one current transformer

* Fuses must be provided by the customer.

** Connection of supply voltage

(13) Three-phase measuring, four conductors, unbalanced load, with voltage transformers, with three current transformers

Connection type 3P3W

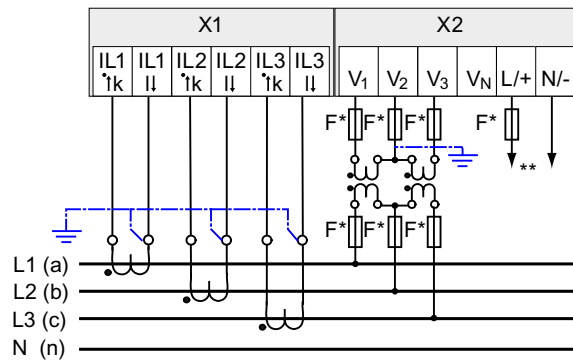

Figure 6-20 Connection type 3P3W, with voltage transformer, with three current transformers

* Fuses must be provided by the customer.

** Connection of supply voltage

See also

Measured variables (Page 24)

Applying the supply voltage (Page 92)

Startup

7.1 Overview

Prerequisites

1. The device has been installed.
2. The device has been connected in accordance with the possible connection methods.
3. An optional expansion module has been installed. If the SENTRON PAC3200 is to be operated with an expansion module, the module must be installed before the SENTRON PAC3200 is started up.

Steps for starting up the device

1. Apply the supply voltage
2. Parameterizing the device
3. Apply the measuring voltage
4. Apply the measuring current
5. Check the displayed measured values

NOTICE
Check the connections Incorrect connection can result in malfunctions and failure of the device. Before starting up the SENTRON PAC3200, check that all connections are correct.

7.2 Applying the supply voltage

A supply voltage is required to operate the device. Please consult the technical data or the type plate for the type and level of the possible supply voltage.

⚠ CAUTION

Observe limit values

Failure to do so may result in damage to the device and the equipment.

The limits given in the technical data and on the type plate must not be exceeded even at startup or when testing the device.

If a supply voltage is applied that does not comply with the specifications on the type plate, this can result in malfunctioning and failure of the device.

The SENTRON PAC3200 can be supplied with an **AC / DC multi-range power supply** or a **DC extra-low voltage power supply**.

Secure the supply voltage with an approved (UL / IEC) fuse appropriate to the power supply version:

- **SENTRON PAC3200 with multi-range power supply 0.6 A, Type C.**
- **SENTRON PAC3200 with extra-low voltage power supply 1.0 A, Type C.**

If a fusible link is used, a suitable approved (UL / IEC) fuse holder has to be used. In addition, a suitable isolating device shall be connected upstream in order to permit disconnection of the device from the power supply.

The supply voltage must not be picked off at the voltage transformers.

Procedure

Connect the supply voltage to terminals L/+ and N/-.

Table 7-1 Connection of supply voltage

Terminal marking	Connection
L/+	AC: Connection: Conductor (phase-to-neutral voltage) DC: Connection: +
N/-	AC: Connection: Neutral conductor DC: Connection: -

See also

- Applying the measuring voltage (Page 100)
- Safety notes (Page 73)
- Safety notes (Page 17)

7.3 Parameterizing the device

Procedure for parameterizing

To start up the device, you must specify the operating parameters listed below in the device settings:

- Connection type
- Voltage
 - Direct measurement on the system or using voltage transformers
 - Measuring input voltage in the case of direct measurement on the system
 - Primary and secondary voltage when measuring using voltage transformers
- Current
 - Primary and secondary current

The following settings are also useful:

- Language
- Password protection

See also

Password management (Page 150)

7.4 LANGUAGE/REGIONAL

7.4.1 Setting the language

First, set the language in which the display text is to appear.



The available languages are displayed:

- at initial startup,
- after resetting to factory settings, and
- after updating the firmware.

English is the default language.



Figure 7-1 Language selection

Select the desired language by pressing <F2>  or <F3> .

Apply the desired language with <F4> .

Changing the language

1. Exit the measured value display and call the "MAIN MENU":
<F4> **MENU**
2. In the main menu, go to the "SETTINGS" entry:
<F2> **▲** or <F3> **▼**
3. Call the "SETTINGS" entry:
<F4> **ENTER**
4. In the "SETTINGS" menu, go to the "LANGUAGE/REGIONAL" entry:
<F2> **▲** or <F3> **▼**

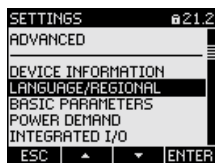

Figure 7-2 "SETTINGS" menu

5. Call the "LANGUAGE/REGIONAL" entry:
<F4> **ENTER**
The display shows the currently valid settings.
6. Open edit mode of the "LANGUAGE" device setting:
<F4> **EDIT**

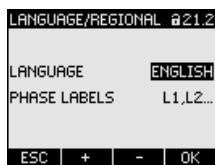

Figure 7-3 "LANGUAGE" edit mode

7. Scroll through the possible values with:
<F2> **+**
8. Accept the desired language with:
<F4> **OK**
The language is permanently saved and becomes effective immediately.
The display returns to display mode.
9. Return to one of the selection menus or to the measured values display:
<F1> **ESC**

7.5 BASIC PARAMETERS

7.5.1 VOLTAGE INPUTS

7.5.1.1 Set the connection type

Inform the device of the connection type executed. To do so, enter the short code for the connection type in the device settings.

Note

Connection type

The connection type executed must agree with the connection type entered in the device!

Table 7-2 Available connection types

Short code	Connection type
3P4W	3 phases, 4 conductors, unbalanced load
3P3W	3 phases, 3 conductors, unbalanced load
3P4WB	3 phases, 4 conductors, balanced load
3P3WB	3 phases, 3 conductors, balanced load
1P2W	Single-phase AC

You can find further information on the possible connection types, and on how the measured value representation depends on the connection type, in the "Description" chapter.

Procedure

- Exit the measured value display and call the "MAIN MENU":
<F4> **MENU**
- In the main menu, go to the "SETTINGS" entry:
<F2> **▲** or <F3> **▼**
- Call the "SETTINGS" entry:
<F4> **ENTER**
- In the "SETTINGS" menu, go to the "BASIC PARAMETERS" entry:
<F2> **▲** or <F3> **▼**
- Call the "BASIC PARAMETERS" entry:
<F4> **ENTER**
- In the "BASIC PARAMETERS" menu, call the "VOLTAGE INPUTS" entry:
<F4> **ENTER**
The display shows the currently valid settings.

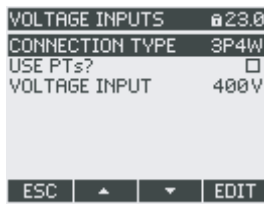

Figure 7-4 "CONNECTION TYPE" device setting

7. Open edit mode of the "CONNECTION TYPE" device setting:
<F4> **EDIT**
8. Scroll through the possible values with:
<F2> **+**
9. Accept the desired connection type:
<F4> **OK**
The connection type is permanently saved and becomes effective immediately.
The display returns to display mode.
10. Return to one of the selection menus or to the measured values display:
<F1> **ESC**

7.5.1.2 Measurement using voltage transformers

The factory setting is measurement direct on the system. At initial startup, the following steps must be carried out if you want to measure using voltage transformers.

Procedure

1. In the "SETTINGS" menu, call the "BASIC PARAMETERS" entry.
2. In the "BASIC PARAMETERS" menu, open the "VOLTAGE INPUTS" entry:
<F4> **ENTER**
The display shows the currently valid settings.
3. Go to the "USE PTs?" device setting:
<F2> **▲** or <F3> **▼**

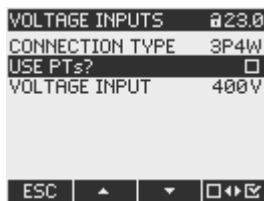

Figure 7-5 Device setting "USE PTs?"

4. Switch converter measurement on/off:
<F4> **☐↔☑**
 On: Measurement using voltage transformers.
 Off: Measurement direct on the low-voltage system.
The device setting is saved permanently and becomes effective immediately.
The display remains in display mode.
5. Return to one of the selection menus or to the measured values display:
<F1> **ESC**

7.5.1.3 Setting the conversion ratio of the voltage transformer

The factory setting is measurement direct on the system. At initial startup, the following steps must be carried out if you want to measure using voltage transformers.

The conversion ratio can only be set if measurement using voltage transformers is set in the device settings. Only then are the fields for primary and secondary voltage visible on the display.

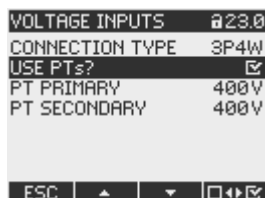

Figure 7-6 Device setting "USE PTs?"

Procedure

1. In the "SETTINGS" menu, call the "BASIC PARAMETERS" entry.
2. In the "BASIC PARAMETERS" menu, open the "VOLTAGE INPUTS" entry:
 <F4> **ENTER**
 The display shows the current settings.
 If the "PT PRIMARY" and "PT SECONDARY" fields are not visible, direct measurement on the system is set. Switch from direct measurement to measurement using voltage transformers. You can find the instructions for this in the "Measurement using voltage transformers" chapter.
3. Go to the "PT PRIMARY" device setting:
 <F2> **▲** or <F3> **▼**
4. Open edit mode of the "PT PRIMARY" device setting:
 <F4> **EDIT**
5. Set the desired value:
 <F2> **+** or <F3> **→**
6. Accept the value:
 <F4> **OK**
 The value of the primary voltage is permanently saved and becomes effective immediately.
 The display returns to display mode.
7. Go to the "PT SECONDARY" device setting:
 <F2> **▲** or <F3> **▼**
 Proceed in exactly the same way as when entering the primary voltage.
 The value of the secondary voltage is permanently saved and becomes effective immediately.
 The display returns to display mode.
8. Return to one of the selection menus or to the measured values display:
 <F1> **ESC**

Example:

You want to measure using voltage transformers for 10000 V/100 V on a 10 kV system. For this purpose, enter:

1. USE PTs?: On:
2. PT PRIMARY: 10000V
3. PT SECONDARY: 100V

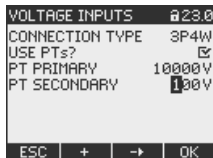

Figure 7-7 "VOLTAGE INPUTS" device setting

7.5.1.4 Setting the voltage input

The factory setting for the measuring reference voltage is 400 V. At initial startup, the following steps must be carried out if the available measuring voltage deviates from this.

Procedure

1. In the "SETTINGS" menu, call the "BASIC PARAMETERS" entry.
2. In the "BASIC PARAMETERS" menu, open the "VOLTAGE INPUTS" entry:
<F4> **ENTER**
The display shows the currently valid settings.
3. Go to the "VOLTAGE INPUTS" device setting:
<F2> **▲** or <F3> **▼**

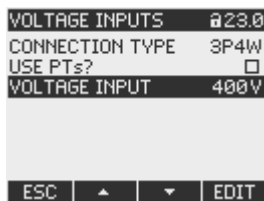

Figure 7-8 "VOLTAGE INPUTS" device setting

4. Open edit mode of the "VOLTAGE INPUTS" device setting:
<F4> **EDIT**
5. Set the desired value:
<F2> **+** and <F3> **→**
6. Accept the value:
<F4> **OK**
The value of the voltage input is permanently saved and becomes effective immediately. The display returns to display mode.
7. Return to one of the selection menus or to the measured values display:
<F1> **ESC**

7.5.2 CURRENT INPUT

7.5.2.1 Setting the conversion ratio of the current transformer

The factory setting is measurement using current transformers. If you want to measure using current transformers, the conversion ratio must be set at initial startup.

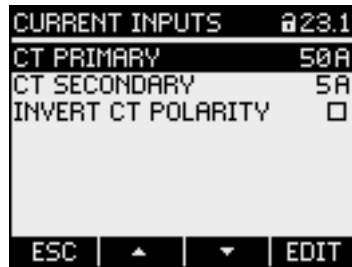

Figure 7-9 "CURRENT INPUTS" device setting

Procedure

1. In the "SETTINGS" menu, call the "BASIC PARAMETERS" entry.
2. In the "BASIC PARAMETERS" menu, open the "CURRENT INPUTS" entry:
<F4> **ENTER**
The display shows the currently valid settings.
3. Open edit mode of the "CT PRIMARY" device setting:
<F4> **EDIT**
4. Set the desired value of the primary current:
<F2> **+** and <F3> **→**
5. Accept the value with:
<F4> **OK**
The value of the primary current is permanently saved and becomes effective immediately.
The display returns to display mode.
6. Go to the "CT SECONDARY" device setting:
<F2> **▲** or <F3> **▼**
Set the desired value for the secondary current. Proceed in exactly the same way as when entering the primary current.
The value of the secondary current is saved permanently and becomes effective immediately.
The display returns to display mode.
7. Return to one of the selection menus or to the measured values display:
<F1> **ESC**

Example

You want to measure the current using current transformers for 5000 A/5 A.

For this purpose, enter:

1. CT PRIMARY: 5000A
2. CT SECONDARY: 5A

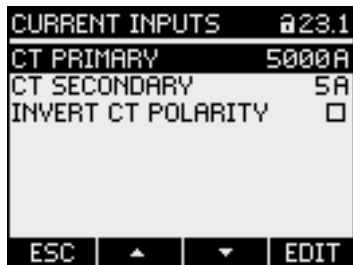

Figure 7-10 Device setting "CURRENT INPUTS - CT PRIMARY?"

7.6 Applying the measuring voltage

The **SENTRON PAC3200 with multi-range power supply** is designed for measuring in systems with rated AC voltages to

- 400 V phase-to-neutral (max. 347 V for UL) and
- 690 V phase-to-phase (max. 600 V for UL).

The **SENTRON PAC3200 with extra-low voltage power supply** is designed for measuring in systems with rated AC voltages to

- 289 V phase-to-neutral and
- 500 V phase-to-phase.

 CAUTION
Observe limit values The limits given in the technical data or on the type plate must not be exceeded even at startup or when testing the device. Measurement of DC voltage is not possible. External voltage transformers are required to measure higher voltages than the permissible rated input voltages.

See also

Applying the supply voltage (Page 92)

Measuring inputs (Page 22)

Safety notes (Page 73)

Safety notes (Page 17)

7.7 Applying the measuring current

The device is designed for connection of current transformers with secondary currents of 1 A and 5 A. It is only possible to measure alternating currents.

The current measuring inputs can each be loaded with 10 A (max. 300 V) continuously or with 100 A for 1 second.



! DANGER

Short-circuiting secondary connections of the current transformers

Will cause death, serious injury or considerable property damage.

Electric shock and danger of arcing in the case of open transformer circuits

It is only possible to measure the current with current transformers. The circuits must NOT be protected with a fuse here! Never open the secondary circuit of the current transformers under load. Short-circuit the secondary current terminals of the current transformer before removing the device. The safety information for the current transformers used must be followed!

! CAUTION

Do not measure direct currents

Direct currents cannot be measured with the device.

Direction of current flow

Please take account of the direction of current flow when connecting the current measuring inputs. With inverse connection, the measured values are inverted and receive a negative sign.

To correct the direction of current flow, it is not necessary to reverse the input terminals. Instead, change the interpretation of the direction in the device settings.

You can find more information in the chapter "Parameterizing", "INVERTED CURRENT".

See also

Safety notes (Page 17)

Measuring inputs (Page 22)

Safety notes (Page 73)

7.8 Check the displayed measured values

Correct connection type

With the help of the table "Displaying the measured variables depending on the connection type", check whether the measured variables are displayed in accordance with the connection type executed. Any deviation indicates a wiring fault or configuration error.

See also

Measured variables (Page 24)

Operator control

8.1 Device interface

8.1.1 Displays and operator controls

Displays and operator controls

The front of the SENTRON PAC3200 contains the following displays and operator controls.

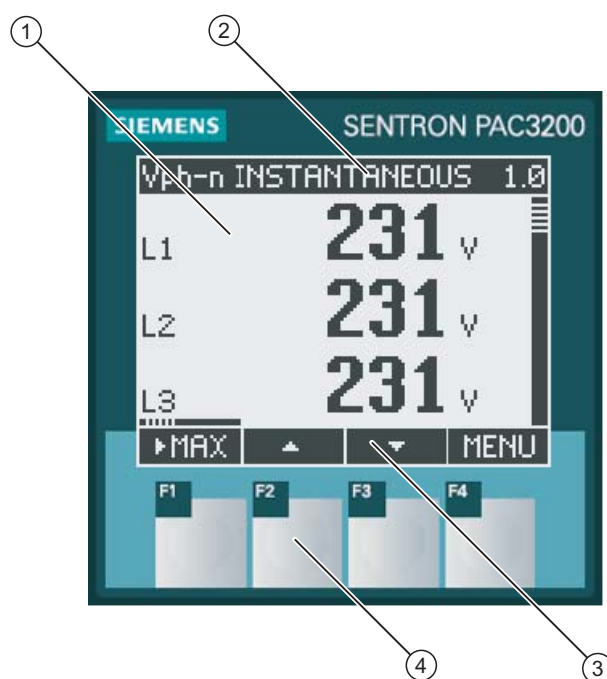

Figure 8-1 Device interface

- (1) Display of the measured values, device settings, selection menus
- (2) Display title
- (3) Labeling of the function keys
- (4) Surfaces of the function keys

Display: Display - Display title - Key labeling

The display is structured as follows:

- Display area - represents the current measured values, device settings and selection menus.
- Header area - specifies the information visible in the display area.
- Footer area - specifies the functions assigned to the function keys.

Function keys: Key labeling - Key surfaces

The four function keys F1 to F4 enable operator input to the device:

- Navigation in the menus
- Selection of the measured value displays
- Display and editing of the device settings

The keys have multiple assignments. Function assignments and key labeling change according to the context of operator input. The designation of the current key function can be seen above the key number in the footer area of the display.

A short press on the key triggers the function once. Holding the key down for longer switches on the autorepeat function after approximately 1 second. The function of the key is triggered repeatedly while the key is held down. Autorepeat is useful, for example, for fast incrementing of values when parameterizing the device.

Organization of information

The display organizes the viewable information as follows:

Measured variables

- Display of the measured variables
The display shows the measured values of the currently selected measured variable.

Menus

- "MAIN MENU"
The display lists the viewable measured variables.
- "SETTINGS" menu
The display lists the device settings.
The "SETTINGS" menu is a submenu of the "MAIN MENU".
The "SETTINGS" menu contains further submenus.

Device settings

- Display of the device settings
The display shows the values of the currently effective device settings.
- Edit mode of the device settings
The display enables editing of the device settings.

The figure below shows the structure.

Navigation through the views

Navigation through the measured variables, menus and device settings is assigned throughout to the function keys F1 and F4:

- F1 **ESC**: Cancels the last operator action. Returns from display of the device settings to display of the menu.
- F4 **MENU**: Calls the main menu.
- F4 **ENTER**: Calls the selected menu entry.
- F4 **EDIT**: Opens edit mode of the device setting.

The figure below shows the navigation paths. The display of the measured variables is the starting point and end point of the navigation. Repeated pressing of F1 returns you to the display of the measured variables.

Please note that additional functions are assigned to F4.

F4 **OK**: Permanently saves the last set value and returns from edit mode to display mode. If no editing is intended, the key closes the display and returns to the menu selection.

F4 **☐↔☑**: Is an ON/OFF switch.

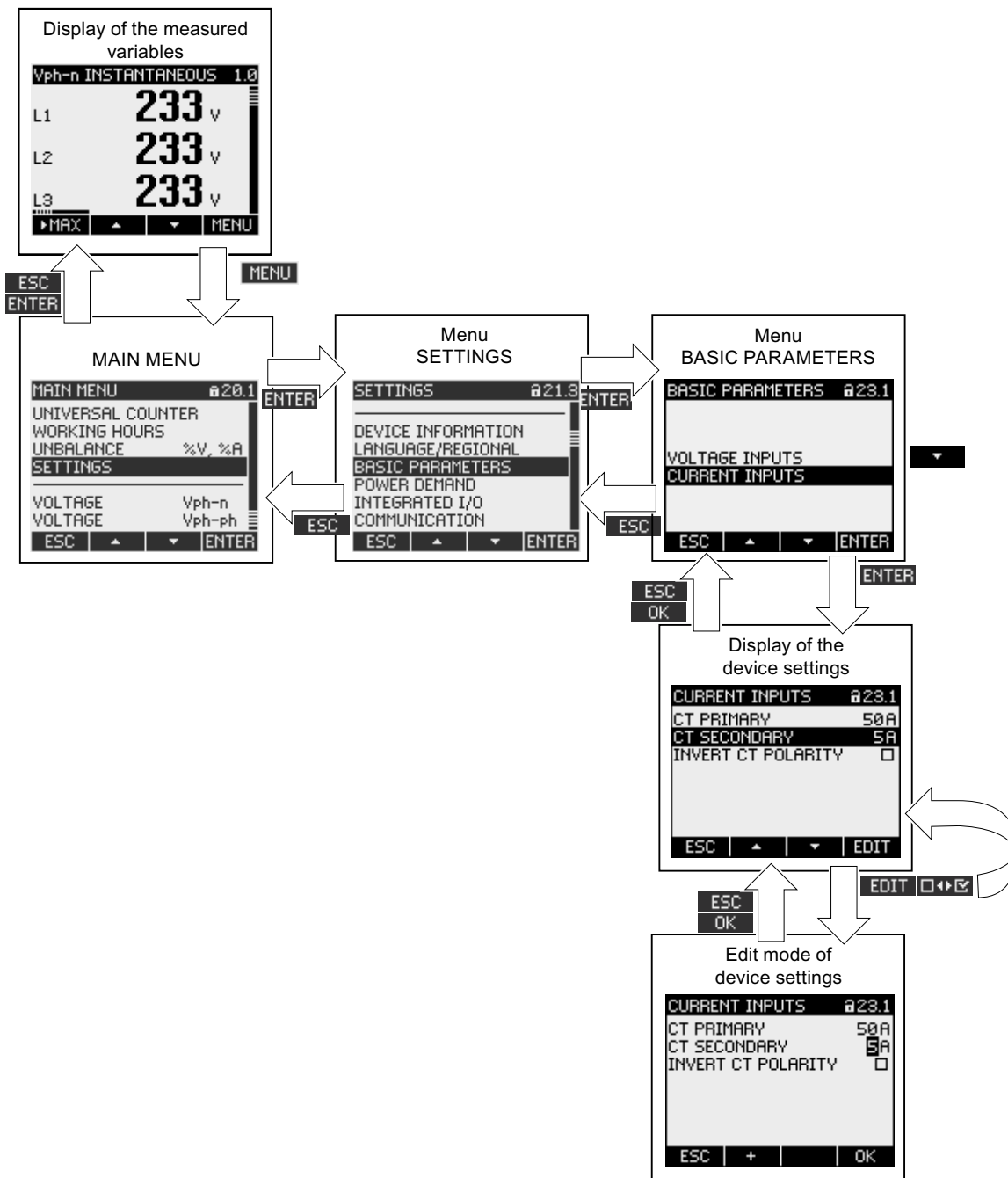



Figure 8-2 Information structure and navigation

Special display elements

Device protection symbol

The padlock symbol in the display title indicates whether the device settings are protected against unauthorized or inadvertent changes or not.

-  Device is protected.
-  Device is not protected.

If device protection is switched on, the device demands input of the valid password.

The password can be assigned or modified in the "ADVANCED > PASSWORD PROTECTION" device setting.

Note: The device protection symbol appears in all displays with the exception of the measured value display.

Display number

Each display is assigned a display number. The number is located on the right of the header area of the display.

Note: In the case of support requests, provide the display number if you are referring to a specific display.

Scroll bar

A scroll bar is positioned on the right edge of the display in menu displays. The slide  on the bar shows the relative position of the selection bar in the menu list.

- Slide at top position: Start of list
- Slide at bottom position: End of list

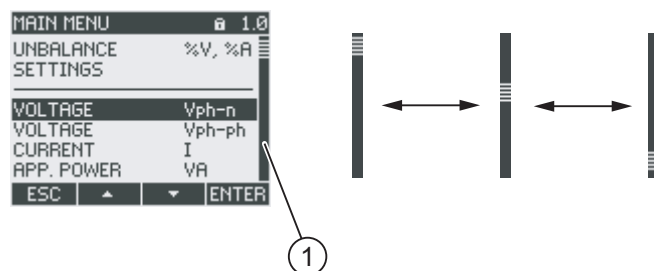



Figure 8-3 Scroll bar of the menu list

(1) Scroll bar of the menu list

Selection bar

The selection bar indicates the menu entry that can be called with F4 .

F2  and F3  move the selection bar over the menu entries.

- If all entries of the displayed menu can fit on the display, the selection bar moves across the stationary menu entries.
- If the menu list has more entries than can fit on the display, the display switches to scroll mode. The selection bar remains stationary in the middle of the display. The menu list rolls up and down "under" the bar.

Start of the list/end of the list

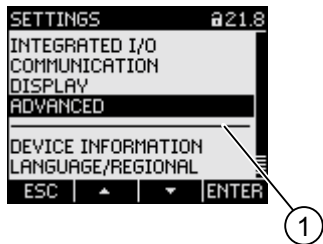



Figure 8-4 Start of the list/end of the list

- (1) Separating line between the start of the list and end of the list

In all menus, the end of the list is looped back in a circle to the start of the list. F3  jumps from the end of the list to the start of the list. F2  jumps from the start of the list to the end of the list.

A separating line indicates the interface between the end of the list and the start of the list if the menu contains more entries than can be shown on the display at one time.

Scroll bar of function key F1

The horizontal bar above function key F1 shows the multiple assignments of the function key. The key assignment changes every time you press the key.

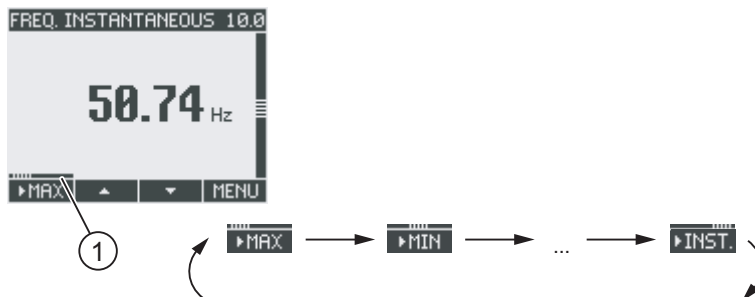

Figure 8-5 Scroll bar

- (1) Scroll bar of function key F1

Maximum/minimum value symbol

When displaying the maximum and minimum values, the measured variable designation is assigned a symbol to indicate the maximum or minimum value:

- ▲ Maximum
- ▼ Minimum

When displaying the average value, the maximum/minimum symbol indicates the following:

- (without symbol) current average value
- ▲ Maximum average
- ▼ Minimum average

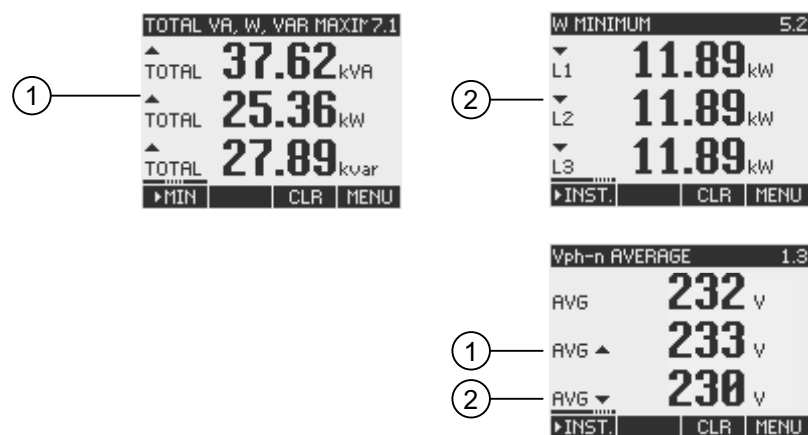

Figure 8-6 Maximum/minimum symbols

- (1) Maximum symbol
- (2) Minimum symbol

8.1.2 Display of the measured variables

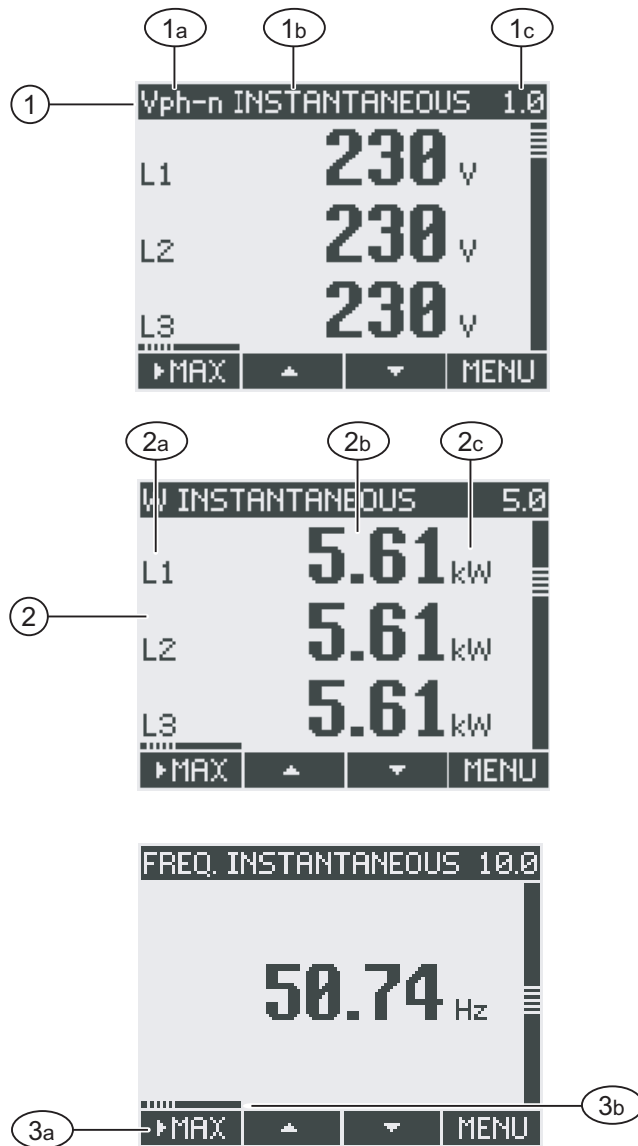

Figure 8-7 Display of the measured variables

- (1) Display title
 - a) Designation of the measured variable
 - b) Designation of the measured value property
 - c) Display number of the measured variable
- (2) Measured value display
 - a) Phase labels
 - b) Measured value
 - c) Unit of the measured variable
- (3) Function keys
 - a) Key labeling
 - b) Scroll bar of function key F1

Display title

The display title in the header of the display contains the following information:

- Designation of the measured variable
- Designation of the measured value property
- Display number of the measured variable

Designation of the measured variable

The first position in the display title contains the designation of the measured variable displayed. Since the length of the line is restricted, the unit of the measured variable is also used as the name.

The following table lists the designations:



Measured variable	Designations of the measured variable in the		Display Number
	Display title	Main menu	
Phase-to-neutral voltage $V_{a-n} / V_{b-n} / V_{c-n}$	Vph-n	VOLTAGE	1.0
Phase-to-phase voltage $V_{a-b} / V_{b-c} / V_{c-a}$	Vph-ph	VOLTAGE	2.0
Current $I_a / I_b / I_c$	AMPS	CURRENT	3.0
Apparent power $VA_a / VA_b / VA_c$	VA	APPARENT POWER	4.0
Active power $\pm W_a / \pm W_b / \pm W_c$	W	ACTIVE POWER	5.0
Reactive power $\pm VAR_a / \pm VAR_b / \pm VAR_c$	VAR	REACTIVE POWER	6.0
Collective power values: <ul style="list-style-type: none"> • Total apparent power • Total active power • Total reactive power 	TOTAL VA, W, VAR	TOTAL POWER	7.0
Power factor $ PF_a / PF_b / PF_c $	PF	POWER FACTOR	8.0
Total power factor	TOTAL PF	TOTAL POWER FACTOR	9.0
System frequency f	FREQ	FREQUENCY	10.0
THD voltage $THD-V_a / THD-V_b / THD-V_c$	THD-V	THD VOLTAGE	11.0
THD current $THD-I_a / THD-I_b / THD-I_c$	THD-I	THD CURRENT	12.0
Active energy import/export $\pm W_{a..c}$ <ul style="list-style-type: none"> • On peak • Off peak 	ACTIVE ENERGY	ACTIVE ENERGY	13.0 13.1
Reactive energy positive/negative $\pm Wvar_{a..c}$ <ul style="list-style-type: none"> • On peak • Off peak 	REACTIVE ENERGY	REACTIVE ENERGY	14.0 14.1
App. energy $Wva_{a..c}$ <ul style="list-style-type: none"> • On peak • Off peak 	APPARENT ENERGY	APPARENT ENERGY	15.0
Universal counter	UNIVERSAL COUNTER	UNIVERSAL COUNTER	16.0
Working hours counter Bh	WORKING HOURS	WORKING HOURS	17.0
Unbalance <ul style="list-style-type: none"> • Voltage • Current 	UNBAL. %V, %A	UNBALANCE	18.0
Device settings	SETTINGS	SETTINGS	20.1











Designation of the measured value property

The second position in the display title contains the currently displayed measured value property. The table below lists the measured value properties and their designations:

Designation of the measured value property	Measured value property of the measured variable
INSTANTANEOUS	Measured instantaneous value
MAXIMUM	Measured maximum value
MINIMUM	Measured minimum value
AVERAGE	Calculated average value
IMPORT	Import of energy/positive energy
EXPORT	Export of energy/negative energy

Function keys

The function keys have multiple assignments in the measured value display. F2  and F3  are only available when the instantaneous value is displayed.

Key function	F1	F2	F3	F4
Display the instantaneous value				
Display the maximum value				
Display the minimum value				
Display the average value				
Display import of energy/positive energy				
Display export of energy/negative energy				
Reset the maximum/minimum or average value to the instantaneous value				
Scroll up in the selection list				
Scroll down in the selection list				
Go to the menu selection				

See also

Operator input steps in the "MAIN MENU" (Page 119)

8.1.3 Display of the "MAIN MENU"

The "MAIN MENU" shows the choice of viewable measured variables. The additional menu entry "SETTINGS" branches to the menu for parameterizing the device.

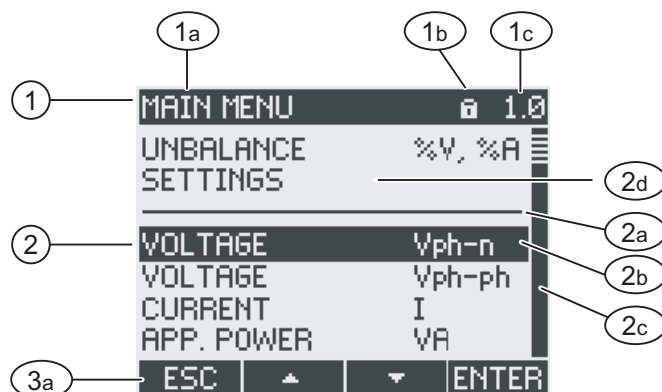

Figure 8-8 Display of main menu

- (1) Display title
 - a) "MAIN MENU"
 - b) Device protection symbol
 - c) Display number
- (2) List of viewable measured variables
 - a) Line separating the start and end of the list
 - b) Selection bar
 - c) Scroll bar
 - d) Changing to the menu for parameterizing the device
- (3) Function keys
 - a) Key labeling

Display title

The display title "MAIN MENU" remains.

Display number of the measured variable

The main menu has no visible display number of its own. The display number shown refers to the currently selected measured variable.

List of viewable measured variables

The menu list shows the choice of viewable measured variables.

Selection bar

The selection bar highlights the currently selected measured variable.

Changing to the menu for parameterizing the device

The "SETTINGS" menu entry branches to the menu for parameterizing the device.

Function keys

Table 8-1 Assignments of the function keys in the "MAIN MENU"

Key function	F1	F2	F3	F4
Reject the menu selection and return to the last displayed measured variable	ESC			
Scroll up in the selection list		▲		
Scroll down in the selection list			▼	
Display the selected measured variable				ENTER

8.1.4 Display of the "SETTINGS" menu

The "SETTINGS" menu shows the choice of device settings. The menu entries designate groups of related settings combined in one display. A menu entry can lead to further submenus.

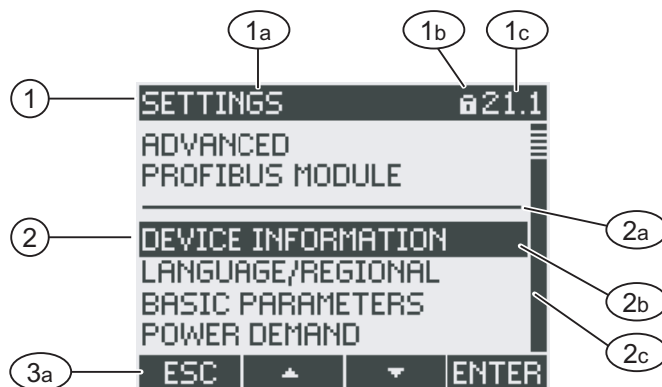

Figure 8-9 Display of the "SETTINGS" menu

- (1) Display title
 - a) "SETTINGS"
 - b) Device protection symbol
 - c) Display number of the device setting
- (2) List of device settings
 - a) Line separating the start and end of the list
 - b) Selection bar
 - c) Scroll bar
- (3) Function keys
 - a) Key labeling

The "SETTINGS" menu contains the same operator controls as the "MAIN MENU".

Function keys

Table 8-2 Assignments of the function keys in the "SETTINGS" menu

Key function	F1	F2	F3	F4
Reject the menu selection and return to the "MAIN MENU"	ESC			
Scroll up in the selection list		▲		
Scroll down in the selection list			▼	
Display the selected device setting				ENTER

8.1.5 Display of the device settings

Related device settings are listed under the display title. The currently valid settings are visible.

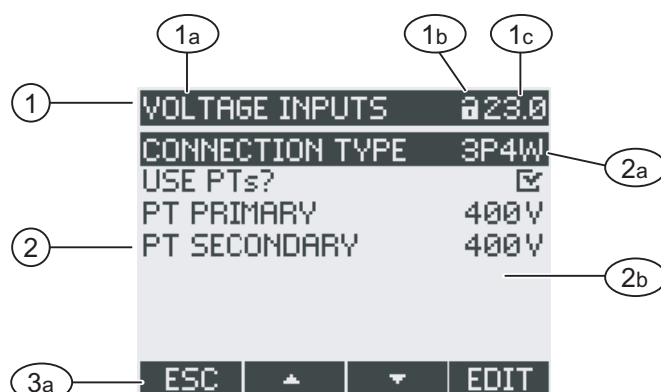

Figure 8-10 Display of the device settings

- (1) Display title
 - a) Designation of the selected group of device settings
 - b) Device protection symbol
 - c) Display number of the device setting
- (2) List of device settings
 - a) Selection bar
 - b) Current setting
- (3) Function keys
 - a) Key labeling

Display title

Specifies which group of device settings is currently selected.

Function keys

Table 8-3 Assignments of the function keys in the device settings display

Key function	F1	F2	F3	F4
Return to the menu selection	ESC			
Scroll up in the selection list		▲		
Scroll down in the selection list			▼	
Change to edit mode				EDIT
Switch the setting ON/OFF				☐↔☑
Return to the menu selection				OK

F4 **EDIT** switches edit mode on. The device settings can be changed in edit mode.

F4 **☐↔☑** is an ON/OFF switch. The change takes effect immediately. Calling edit mode is no longer applicable.

F4 **OK** is available when the device setting is displayed but cannot be edited. Like F1, F4 returns to the "SETTINGS" menu from this display.

See also

Edit mode of the device settings (Page 116)

8.1.6 Edit mode of the device settings

To edit the device settings, it is necessary to call edit mode. In display mode, the function for calling edit mode is assigned to F4 **EDIT**.

You can recognize edit mode because the selection bar reduces to the width of the selected value.

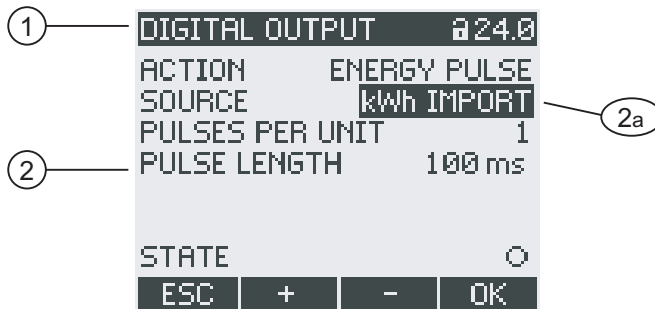

Figure 8-11 Edit mode of the device settings

- (1) Group title
- (2) List of device settings
 - a) Device setting in edit mode

Note: Display mode also includes edit functions! In display mode, F4 **☐↔☑** functions as an ON/OFF switch with immediate effect. Calling edit mode is no longer applicable.

Function keys

Table 8-4 Assignments of the function keys in edit mode of the device settings

Key function	F1	F2	F3	F4
Reject the changes and return to display mode				
Increment the numerical value by "1" or show the next selectable setting				
Decrement the numerical value by "1"				
Go to the next digit to the right in the multi-digit numerical value				
Save the changes and return to display mode				

See also

Display of the device settings (Page 115)

8.2 Operator input steps

8.2.1 Operator input steps in the measured variable display

Selecting the measured variable

When displaying the instantaneous value, it is possible to switch to other measured variables.

F2 switches to the previous measured variable.

F3 switches to the next measured variable.

The order of the measured variables corresponds to the order in the main menu.

If the maximum/minimum value or average value is displayed, F2 and F3 are not available. In this case, switch first to the display of the instantaneous value.

Note: It is also possible to select the measured variable in the main menu.

Display the instantaneous, maximum/minimum or average value

F1 switches the display on.

F1 : Display of the maximum value

F1 : Display of the minimum value

F1 : Display of the instantaneous value

F1 : Display of the average value

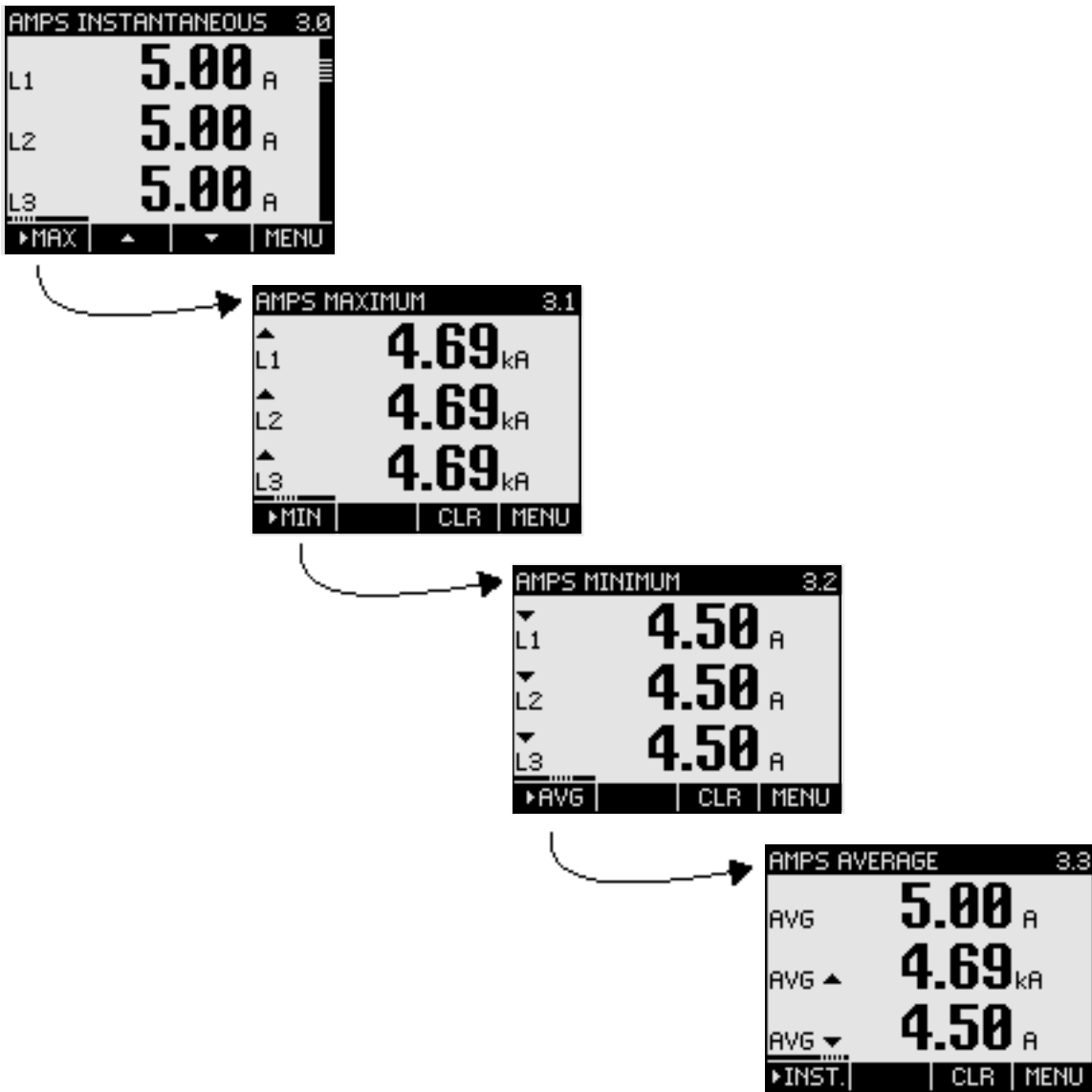

Figure 8-12 Display the instantaneous, maximum/minimum or average value

Reset the maximum or minimum value to the instantaneous value

F3 **CLR** resets the last reached maximum/minimum value to the instantaneous value.

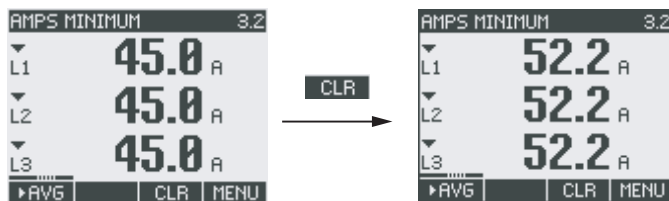

Figure 8-13 Reset the maximum or minimum value to the instantaneous value

Switch between import and export

F1 switches between import and export for active energy, reactive energy and apparent energy.

F1 **▶EXP.▶**: Display of export.

F1 **▶IMP.▶**: Display of import.

Calling the "MAIN MENU"

F4 **▶MENU▶** calls the menu selection. The selection bar is at the last displayed measured variable in the menu selection.

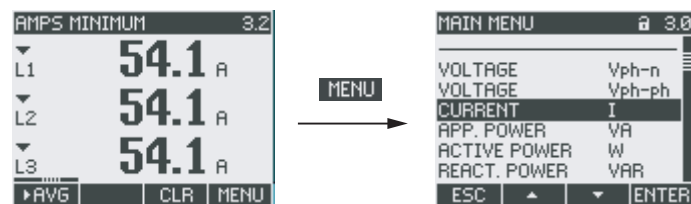

Figure 8-14 Calling the "MAIN MENU"

8.2.2 Operator input steps in the "MAIN MENU"

Selecting the measured variable

The selection bar highlights the currently selected menu entry (white text on a black background).

F2 **▶▲▶** moves the selection bar up in the menu list.

F3 **▶▼▶** moves the selection bar down in the menu list.

Note

Selecting the measured variable

In the measured value display, you can switch to other measured value displays without calling the main menu.

Displaying the measured variable

The selection bar highlights the currently selected menu entry (white text on a black background).

F4 **▶ENTER▶** calls the display of the selected measured variable.

Cancel menu selection

F1 **ESC** cancels menu selection and returns to the last displayed measured variable.

Note

Cancel menu selection

When returning from the main menu to the measured value display, the display switches to showing the instantaneous value.

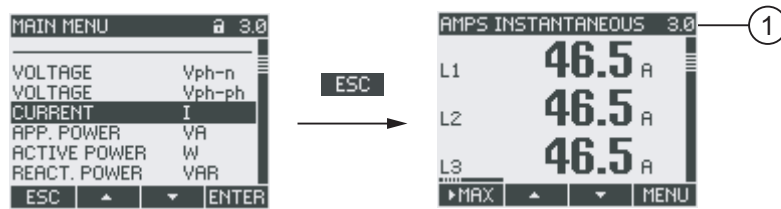

Figure 8-15 Cancel menu selection

- (1) Switching to display of the instantaneous value

Calling the "SETTINGS" menu

The "SETTINGS" menu entry calls the menu for parameterizing the device.

See also

Operator input steps in the measured variable display (Page 117)

8.2.3 Operator input steps in the "SETTINGS" menu

Selecting settings

The selection bar highlights the currently selected menu entry (white text on a black background).

F2 **▲** moves the selection bar up in the menu list.

F3 **▼** moves the selection bar down in the menu list.

Displaying a setting

The selection bar highlights the currently selected menu entry (white text on a black background).

F4 **ENTER** calls the display of the selected device setting.



Figure 8-16 Displaying a setting

Cancel menu selection

F1 **ESC** returns to the main menu.

8.2.4 Operator input steps in device settings display

Calling edit mode

F4 **EDIT** switches edit mode on. The device settings can be changed in edit mode.

You can recognize edit mode because the selection bar reduces to the width of the selected value.

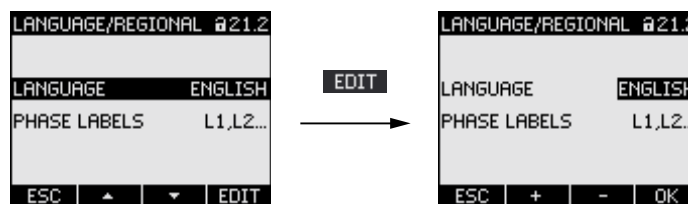

Figure 8-17 Calling edit mode

Exiting the display

F1 **ESC** closes the display and returns to the "SETTINGS" menu.

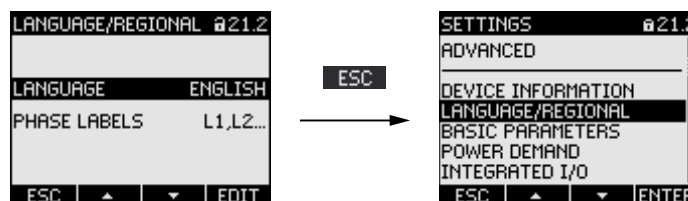

Figure 8-18 Exiting the display

8.2.5 Operator input steps in edit mode of the device settings

Enter password

If device protection is switched on, the SENTRON PAC3200 demands input of the valid password.



Figure 8-19 Enter password

You can find information on password management in the "Password management" chapter.

Change value

Switching a device setting ON/OFF

F4 switches a function or status ON/OFF. The setting takes effect immediately. Saving with F4 no longer applies.

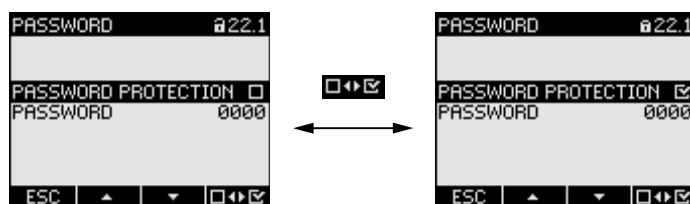

Figure 8-20 Switching a device setting ON/OFF

Switching between several options

F4 switches between options that cannot be in effect at the same time. When an option is switched on, the last valid option is switched off.

The setting takes effect immediately. Saving with F4 no longer applies.

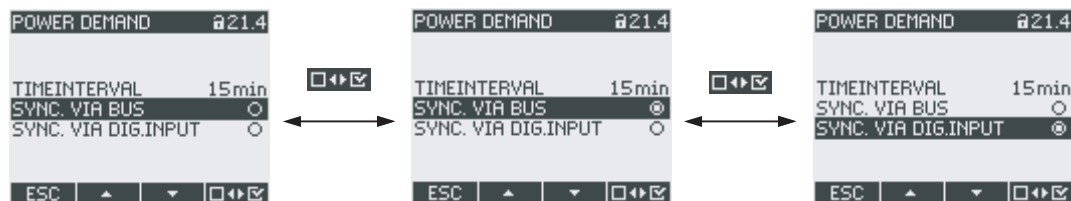

Figure 8-21 Device setting, switching between several alternatives

Selecting from several settings

F2 **+** scrolls up through the range of selectable settings.

F3 **-** scrolls down through the range of selectable settings.

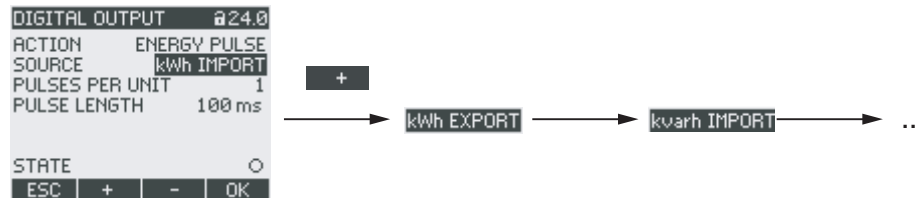

Figure 8-22 Selecting from several settings

Incrementing or decrementing a value

F2 **+** increases the value in increments of 1.

F3 **-** decreases the value in decrements of 1.

The highest value of the available set of values is followed again by the lowest.

Defining multi-digit values

If F3 **->** is available, the digits of a value can be changed, e.g. specific address digits of an address value.

F3 **->** runs through the digits of the value from left to right.

F2 **+** increments the value at the selected digit. The highest value of the available set of values is followed again by the lowest.

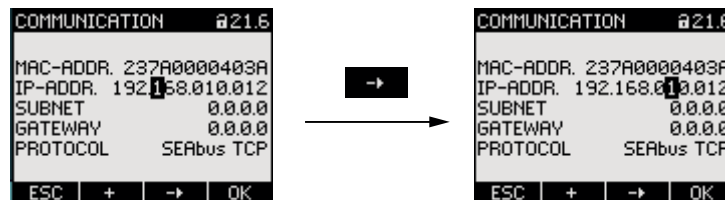

Figure 8-23 Defining multi-digit values

Saving the value

F4 **OK** saves the set value and returns to display mode.

Canceling editing

F1 **ESC** cancels editing and returns to display mode. All changes are discarded.

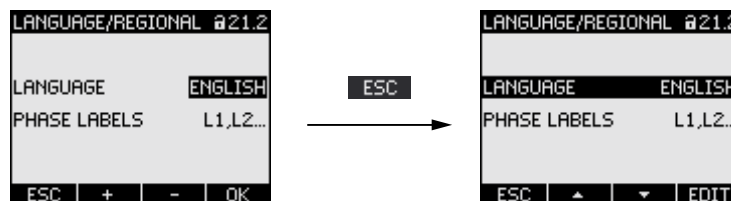

Figure 8-24 Exiting edit mode

Parameterize

9.1 Introduction

Device settings

The "Parameterization" chapter describes the device settings. These functions include:

- Adjustment to the physical conditions of use
- Integration into the communication system
- Country-specific settings, ergonomics, device protection

It is possible to set the device by means of:

- The operator interface of the device
- Configuration software

Note

Protection of the device settings

As delivered, the device settings are not protected. At startup, a password should be assigned and the device protection activated to guard against unauthorized or inadvertent changes.

See also

Advanced (Page 142)

9.2 Parameterizing the operator interface

9.2.1 Groups of settings

The device settings are arranged into the following groups. The "SETTINGS" menu shows the choice of groups:

- Device information
- Language/Regional
- Basic parameters
- Power demand
- Integrated I/O
- Communication
- Display
- Advanced
- PROFIBUS module (only if the optional PAC PROFIBUS DP expansion module is plugged in)

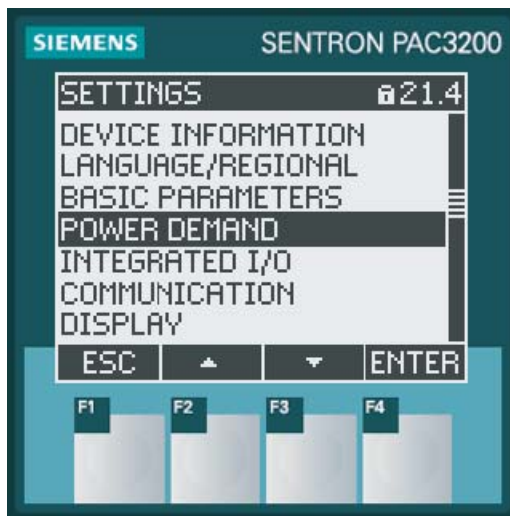

Figure 9-1 "Settings" menu

Overview - Menu tree and device settings

Below is the menu tree of the "SETTINGS" menu with all the device settings. The tree branches into multiple submenus.

MAIN MENU

SETTINGS

DEVICE INFORMATION 21.1

Manufacturer designation

Order No.

Serial number

Date code

Hardware revision level

Firmware revision level

Boot loader revision level

LANGUAGE/REGIONAL 21.2

LANGUAGE

PHASE LABELS

BASIC PARAMETERS 21.3

VOLTAGE INPUTS 23.0

CONNECTION TYPE

Use PTs?

VOLTAGE INPUT

PT PRIMARY

PT SECONDARY

CURRENT INPUTS 23.1

CT PRIMARY

CT SECONDARY

INVERT CT POLARITY

POWER DEMAND 21.4

TIME INTERVAL

SYNC. VIA BUS

SYNC. VIA DIG.INPUT

INTEGRATED I/O 24.0

DIGITAL OUTPUT 24.0

ACTION

SOURCE

PULSES PER UNIT

PULSE LENGTH

DIGITAL INPUT 24.1

ACTION

PULSES PER UNIT

UNIT

COMMUNICATION 21.6

MAC-ADR.
IP-ADDR.
SUBNET
GATEWAY
PROTOCOL

DISPLAY 21.7

CONTRAST
BACKLIGHT LEVEL
BACKLIGHT DIMMED
TIME UNTIL DIMMED
INVERT DISPLAY
REFRESH TIME
DISPLAY TEST

ADVANCED 22.8

PASSWORD PROTECTION 22.1

PASSWORD PROTECTION
PASSWORD

LIMITS 22.2

LIMIT 0
MONITORING
SOURCE
MODE
VALUE
PICKUP DELAY
HYSTERESIS
STATUS

LIMIT 1

...

LIMIT 2

...

LIMIT 3

...

LIMIT 4

...

LIMIT 5

...

LIMIT 6

...

```

LIMIT LOGIC
    LIM0
    LIM1
    LIM2
    LIM3
    LIM4
    LIM5
    = LIMIT LOGIC
UNIVERSAL COUNTER 22.3
    SOURCE
RESET 30.0
    CLEAR MIN/MAX-VALUES
    RESET COUNTERS
    UNIV.COUNTER RESET
    FACTORY DEFAULTS
    PARAM.
    EXECUTE
PROFIBUS MODULE 21.9
    PROFIBUS ADDRESS
RS485 MODULE 21.9
    ADDRESS
    BAUD RATE
    SETTINGS
    PROTOCOL
    RESPONSE TIME

```

9.2.2 Device information

The device information cannot be modified. Key F4 **OK** returns to the "SETTINGS" menu.

Call: "SETTINGS > DEVICE INFORMATION"

```

DEVICE INFORMATION @21.1
SIEMENS AG
7KM2112-0BA00-3AA0
S/N: 0000000000000001
D/T: 0
HW-REV:1
SW-REV:01.5.0
BL-REV: V1.0.0
ESC |      |      | OK

```

Figure 9-2 "INFORMATION" device setting

Device information

SIEMENS AG	Manufacturer designation.
<Order no.>	Order number of the device.
S/N:	Serial number of the device.
D/T:	Date code.
HW-REV:	Hardware revision level.
SW-REV:	Firmware revision level.
BL-REV:	Boot loader revision level.

9.2.3 Language, regional settings

Adapting the regional and language options.

Call: "SETTINGS > ANGUAGE/REGIONAL"



Figure 9-3 "LANGUAGE SETTING" device setting

Language and regional settings

LANGUAGE	Language of the display. Range: German, English, Portuguese, Turkish, Spanish, Italian, French, Chinese, Russian Default: English
PHASE LABELS	Designation of the phases on the display. Range: L1 L2 L3, a b c Default: L1 L2 L3

9.2.4 Basic parameters

Basic parameters are all those settings concerning the measuring inputs.

Call: "SETTINGS > BASIC PARAMETERS"

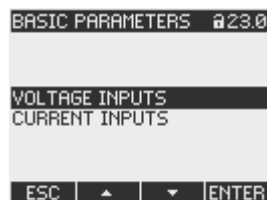

Figure 9-4 "BASIC PARAMETERS" device setting

VOLTAGE INPUTS

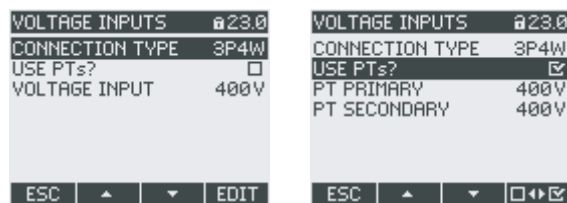

Figure 9-5 "VOLTAGE INPUTS" device setting

CONNECTION TYPE

Connection types:

- 3P4W: 3 phases,
4 conductors,
unbalanced load
- 3P3W: 3 phases,
3 conductors,
unbalanced load
- 3P4WB: 3 phases,
4 conductors,
balanced load
- 3P3WB: 3 phases,
3 conductors,
balanced load
- 1P2W: 1 phase,
2 conductors,
unbalanced load

Default: 3P4W

Use PTs?	<p>Measurement with/without voltage transformer</p> <p>ON/OFF switch: <input checked="" type="checkbox"/> ON / <input type="checkbox"/> OFF.</p> <p><input checked="" type="checkbox"/> ON: Measurement using voltage transformers.</p> <p>When measuring via voltage transformer, the device must know the voltage conversion ratio. For this purpose, the primary and secondary voltages must be specified in the fields "PT PRIMARY" and "PT SECONDARY".</p> <p>When changing from direct measurement to measurement using voltage transformers, the device accepts the last set reference measuring voltage as the secondary voltage and as the primary voltage.</p> <p><input type="checkbox"/> OFF: Measurement direct on the low-voltage system.</p> <p>When changing from measurement using voltage transformers to direct measurement, the device accepts the last set secondary voltage as the reference measuring voltage.</p> <p>Default: <input type="checkbox"/> Off</p>
VOLTAGE INPUT	<p>Rated voltage of the measuring system. Must be specified if measuring is done direct on the system without voltage transformers.</p> <p>SENTRON PAC3200 with multi-range power supply Range: 1 V to 690 V, freely adjustable (max. 600 V for UL) Default value: 400 V</p> <p>SENTRON PAC3200 with extra-low voltage power supply Range: 1 V to 500 V, freely adjustable Default value: 289 V</p>
PT PRIMARY	<p>The property "VOLTAGE INPUT" is only visible, if "USE PTs?" is set to "<input type="checkbox"/> Off".</p> <p>Primary voltage. Must be specified if a voltage transformer is used for measuring.</p> <p>Range: 1 V to 999999 V, freely adjustable Default value: 400 V</p> <p>The property "PT PRIMARY" is only visible, if "USE PTs?" is set to "<input checked="" type="checkbox"/> On".</p>

PT SECONDARY

Secondary voltage. Must be specified if a voltage transformer is used for measuring.

SENTRON PAC3200 with multi-range power supply

Range: 1 V to 690 V, freely adjustable (max. 600 V for UL)

Default value: 400 V

SENTRON PAC3200 with extra-low voltage power supply

Range: 1 V to 500 V, freely adjustable

Default value: 289 V

The property "PT SECONDARY" is only visible, if "USE PTs?" is set to ON".

CURRENT INPUT

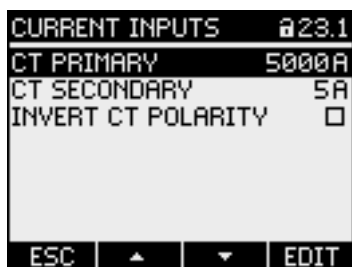

Figure 9-6 "CURRENT INPUTS" device setting

CAUTION

Please note current carrying capacity

Overload can destroy the SENTRON PAC3200.

When measuring using current transformers, the device must know the current conversion ratio. For this purpose, the primary and secondary currents must be specified in the fields "CT PRIMARY" and "CT SECONDARY".

CT PRIMARY Specify the primary current of the current transformer(s).

Range: 1 A to 99999 A, freely adjustable

Default: 50 A

CT SECONDARY Specify the secondary current of the current transformer(s).

Range: 1 A, 5 A

Default: 5 A

INVERT CT POLARITY Inversion of the direction of current flow
ON/OFF switch: ON / OFF.
 OFF: SENTRON PAC3200 interprets the direction of current flow in accordance with the wiring.
 On: Direction of current flow is inverted. SENTRON PAC3200 interprets the direction of current flow opposite to the wiring.
Default: OFF

9.2.5 Power demand

Device settings for acquiring the power demand.

Call: "SETTINGS > POWER DEMAND."

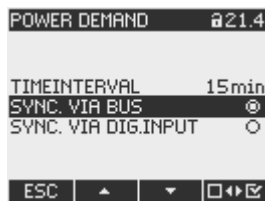

Figure 9-7 "POWER DEMAND" device setting

Power demand

TIME INTERVAL Time interval in minutes
Range: 1 to 60 min.
Default: 15 min.

SYNC. VIA BUS Synchronization via bus
Radio button: ON / OFF.
Default: OFF.

SYNC. VIA DIG.INPUT Synchronization via digital input
Radio button: ON / OFF.
Default: OFF.

If this option is activated, the "ACTION" field in the "DIGITAL INPUT" device setting is set to "DEMAND SYNC". See the chapter "Integrated I/O - DIGITAL INPUT".

See also

Integrated I/O (Page 137)

9.2.6 Integrated I/O

Device settings for using the digital input and output.

Call: "SETTINGS > INTEGRATED I/O".

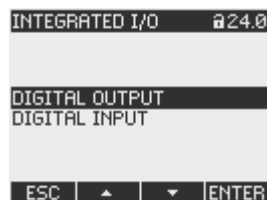

Figure 9-8 "INTEGRATED I/O" device setting

DIGITAL OUTPUT

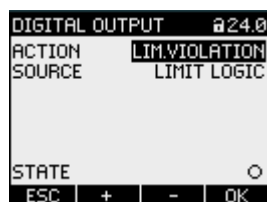

Figure 9-9 "DIGITAL OUTPUT" device setting

ACTION

Method of using the digital output:

- OFF: The digital output is switched off.
- DEVICE ON: The digital output is switched on.
- REMOTE OUTPUT: The digital output is controlled by remote access, e.g. SEAbus, SEAbus TCP, PROFIBUS DP, Modbus RTU, Modbus TCP.
- ROTATION: The digital output is switched on by a left-rotating electrical field and remains active while the direction of rotation of the field remains unchanged.
- LIM.VIOLATION: The digital output is switched on by a limit violation and remains active while the limit violation prevails.
The field "DIGITAL OUTPUT > SOURCE" selects the limit to be monitored. The definition of the limit is stored in "ADVANCED > LIMITS".

ENERGY PULSE: The digital output outputs the parameterized number of pulses per energy unit (e.g. kWh). The energy counter specified in the field "DIGITAL OUTPUT > SOURCE" is evaluated here.

Default: OFF.

SOURCE The field is available in the case of the actions "LIM.VIOLATION" and "ENERGY PULSE"

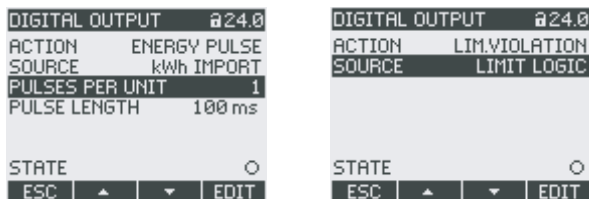

Figure 9-10 "DIGITAL OUTPUT" device setting

In the case of the action "LIM.VIOLATION":
the field "SOURCE" selects the limit whose status is given at the digital output.

- LIMIT LOGIC
- LIMIT 0
- LIMIT 1
- LIMIT 2
- LIMIT 3
- LIMIT 4
- LIMIT 5

Default: LIMIT LOGIC.

In the case of the action "ENERGY PULSE":
the field "SOURCE" selects the type of cumulative power and the import value that triggers the pulse when that value is reached.

- kWh IMPORT
- kWh EXPORT
- kvarh IMPORT
- kvarh EXPORT

The subdivision of the import value is defined in the field "DIGITAL OUTPUT > PULSES PER UNIT".

PULSES PER UNIT The field is available with the action "ENERGY PULSE".
Number of pulses per unit. The unit is defined in the field "DIGITAL OUTPUT > SOURCE".

Range: 1 to 999
Default: 1

PULSE LENGTH The field is available with the action "ENERGY PULSE".
 Pulse length.
 Range: 30 to 500 ms
 Default: 100 ms
 The minimum length of the pulse pause corresponds to the pulse duration specified.

DIGITAL INPUT

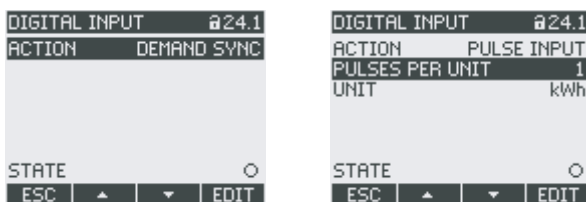

Figure 9-11 "DIGITAL INPUT" device setting

ACTION	Method of using the digital input: NONE: The digital input is switched off. PULSE INPUT: Counting of input pulses. Note: The universal counter must also be parameterized for pulse counting. In the "ADVANCED > UNIVERSAL COUNTER" device setting, set the field "SOURCE" to the value "DIG. INPUT". ON/OFF-PEAK: Switching between tariffs. Off-peak if input active. DEMAND SYNC: Synchronization of power demand. Default: NONE
---------------	--

PULSES PER UNIT The field is available with the action "PULSE INPUT".
 Range: 1 to 999
 Default: 1

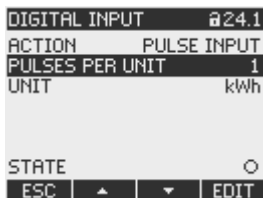

Figure 9-12 "DIGITAL INPUT" device setting

UNIT Visible with action "PULSE INPUT"
 Countable unit with pulse counting:
 kWh (active energy)
 kvarh (reactive energy)

9.2.7 Communication

Device address:

- MAC address
- TCP/IP addresses

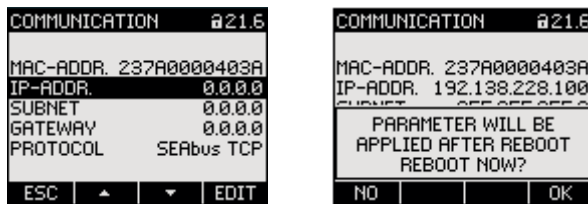

Figure 9-13 "COMMUNICATION" device setting

A change to the TCP/IP addresses only becomes effective after the device has been restarted.

If you exit the "COMMUNICATION" device setting with the F1 key **ESC**, the device asks if you want to restart.

- F1 key **NO**: Do not execute a restart. Address changes are saved on the device but do not become effective.
- F4 key **OK**: Execute a restart. Address changes become effective.

Device settings for communication

MAC-ADDR:	MAC address. Read only.
IP-ADDR.:	IP address.
SUBNET:	Subnet mask.
GATEWAY:	Gateway address.
PROTOCOL:	SEAbus TCP or MODBUS TCP

9.2.8 Display



Figure 9-14 "DISPLAY" device setting

Device settings of the display

CONTRAST	Contrast of the LC display. Range: 0 to 10. Default: 5
BACKLIGHT LEVEL	Intensity of the backlighting of the LC display. The value "0" switches the backlighting off. Range: 0 to 3. Default: 3
BACKLIGHT DIMMED	Intensity of the backlighting of the LC display. Set by the device after expiry of time until dimmed. See "TIME UNTIL DIMMED" The value "0" switches the backlighting off. Range: 0 to 3. Default: 1
TIME UNTIL DIMMED	Time after which the device switches the backlighting from "BACKLIGHT LEVEL" to "BACKLIGHT DIMMED". Range: 0 to 99 min. Default: 3 min.
INVERT DISPLAY	Inversion of the basic representation of the display. ON/OFF switch: <input checked="" type="checkbox"/> ON / <input type="checkbox"/> OFF. <input type="checkbox"/> OFF: Dark text on light background. <input checked="" type="checkbox"/> On: Light text on dark background. Default: <input checked="" type="checkbox"/> On:
REFRESH TIME	Refresh rate of the display. Range: 330 to 3000 ms Default: 330 ms. The tolerance of the refresh rate is 100 ms.

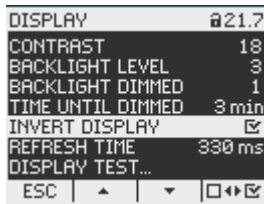

Figure 9-15 "INVERT DISPLAY" device setting switched on

DISPLAY TEST

Screen for testing the functional capability of the display.

Key F3 inverts the test screen.

Key F4 closes the display.



Figure 9-16 "DISPLAY TEST" device setting

9.2.9 Advanced

Call: "SETTINGS > ADVANCED".

Other device settings.

- Password protection
- Defining the limit values
- Defining the universal counter
- Resetting minimum/maximum values, counters and addresses



Figure 9-17 "ADVANCED" device setting

PASSWORD PROTECTION

You can protect the device settings against access with a password.

PASSWORD PROTECTION

Switches password protection ON / OFF.

ON: Password protection switched on

OFF: Password protection switched off

Default: switched off

PASSWORD

Four-digit, numeric password.

Default: 0000

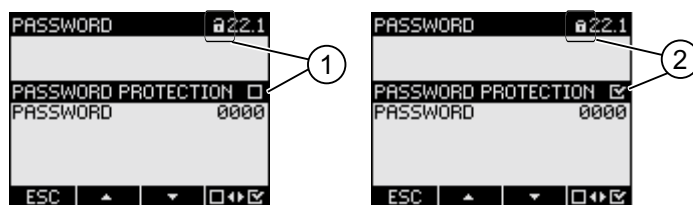

Figure 9-18 "PASSWORD PROTECTION" device setting

- (1) Password protection switched off
- (2) Password protection switched on

LIMITS

Monitoring of 6 limit values "LIMIT 0" to "LIMIT 5".

The limit value "LIMIT LOGIC" comprises limits 0 to 5.

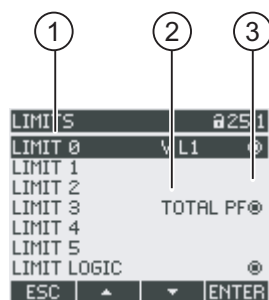

Figure 9-19 "LIMITS" device setting

- (1) Limit designation
- (2) Monitored data source
- (3) Limit currently violated: Yes, No

LIMIT 0, 1, 2, 3, 4, 5

MONITORING

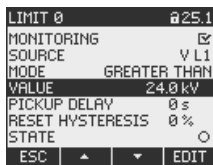

Figure 9-20 "LIMIT 0" device setting

Menu selection of the limits Each limit has the following properties:

Activation of limit monitoring.

ON/OFF switch: ON / OFF.

ON: Limit monitoring switched on.

OFF: Limit monitoring switched off.

Default: OFF

SOURCE

Monitored data source.

Range:

V L1, V L2, V L3,

V L12, V L23, V L31,

I L1 / I L2 / I L3

VA L1 / VA L2 / VA L3

W L1 / W L2 / W L3

VAR L1 / VAR L2 / VAR L3

PF L1, PF L2, PF L3,

THD-V L1, THD-V L2, THD-V L3,

THD-I L1, THD-I L2, THD-I L3,

FREQ.,

V LN AVG, V LL AVG, I AVG,

ΣVA, ΣW, ΣVAR,

TOTAL PF

UNBAL V, UNBAL I,

Default:

V L1

MODE

Relational operators

GREATER THAN, LOWER THAN the value in the VALUE field.

Default operator: GREATER THAN

VALUE

Monitored threshold.

Default: 0 V, corresponding to "SOURCE V L1"

PICKUP DELAY

Delay in reporting limit violation in seconds.

The delay refers to the occurrence of the limit violation or the point of exceeding the threshold defined in the "VALUE" field. See the figure below "Effect of delay".

Range: 0 to 10 s

Default: 0 s

HYSTERESIS

Threshold buffer, prolongs the limit violation.

The hysteresis refers to the disappearance of the limit violation or the point when the level returns below the defined threshold.

Range: 0.0 to 20.0%

Default: 0,0 %

The percentage value refers to the threshold value in the VALUE field. See the figure below "Effect of delay"

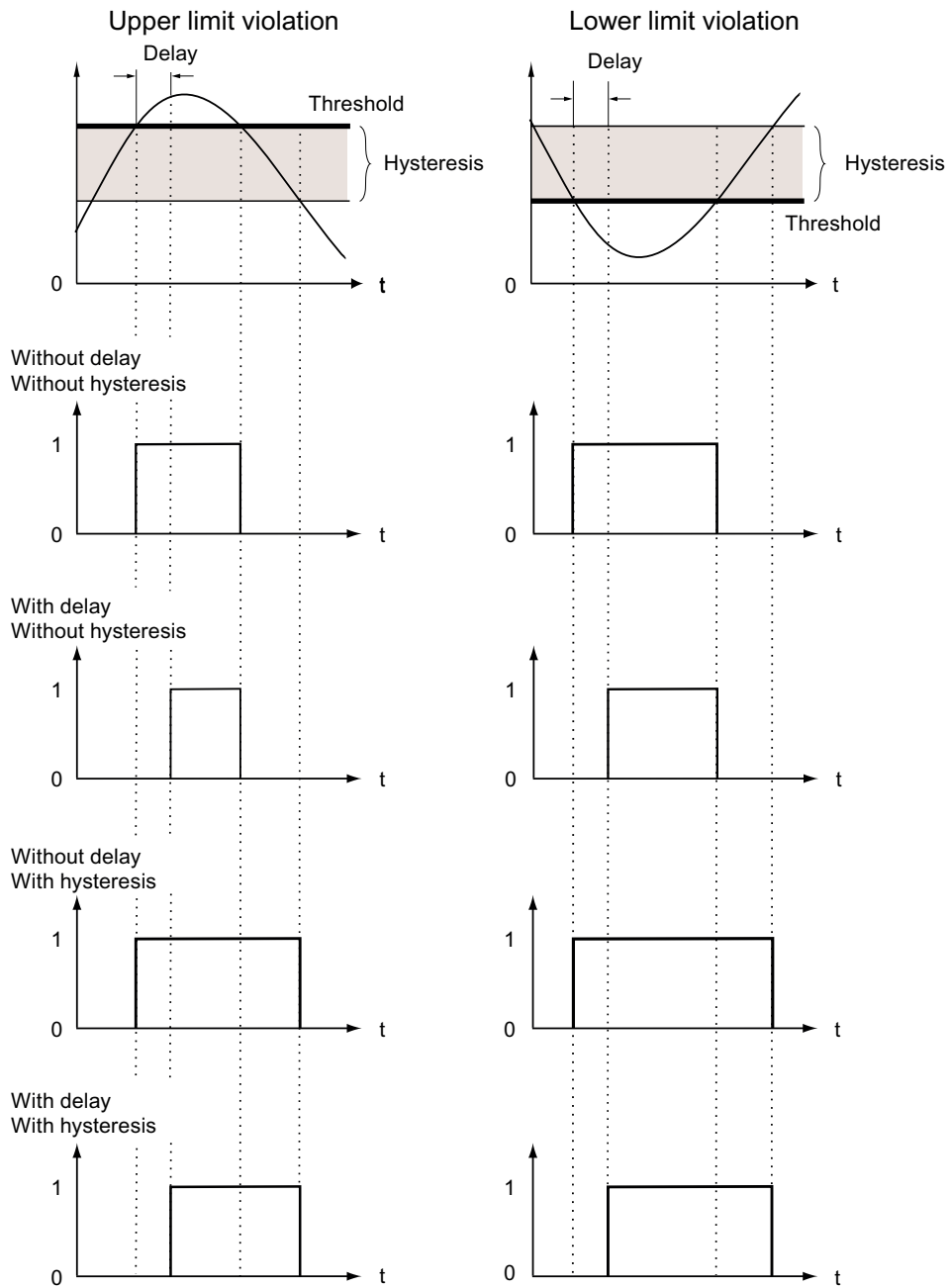

Figure 9-21 Effect of delay and hysteresis on upper and lower limit violations

STATUS

Indicates whether the limit value is currently violated.

- Yes, violation.
- No, no violation.

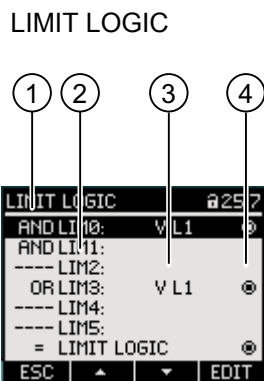

Figure 9-22 "LIMIT LOGIC" device settings

- (1) Logic operator
- (2) Limit designation
- (3) Monitored data source
- (4) Limit currently violated: Yes, No

LIM0, LIM1, ..., LIM5

Logic operator

Range: "----", AND, OR.

The value "----" means: not activated.

Default: "----"

You can find information on generating the logically combined limit "LIMIT LOGIC" in the Limits chapter.

UNIVERSAL COUNTER

Configurable universal counter for counting limit violations and status changes at the digital input or output, or for indicating the active power or reactive power of a connected pulse encoder, e.g. S0 interface.

SOURCE

Source of the count.

Range:

- DIG. INPUT,
- DIG. OUTPUT,
- LIMIT LOGIC,
- LIMIT 0,
- LIMIT 1,
- LIMIT 2,
- LIMIT 3,
- LIMIT 4,
- LIMIT 5

RESET

The "RESET" dialog box enables resetting of the device settings to the instantaneous values or the factory default values. The following groups of values can be reset:

- Maximum/minimum values
- Counters
- Universal counter
- Factory defaults
- Communication parameters



F4  does not immediately reset a value group but marks the group instead. The "EXECUTE..." menu entry resets the marked value groups.

NOTICE

Restart of the device

Resetting of the last two value groups "FACTORY DEFAULTS" and "COMMUNICATION PARAMETERS" results in restart of the device.

After calling the "EXECUTE" menu entry with the F4 key , a cautionary question appears on the display: "Really execute functions?". Answer the question with F1 or F4.

- F1 : Cancel action. The display returns to display mode. All selected value groups are deselected.
- F4 : Reset selected value groups.

After execution with F4 , the confirmation "SELECTION EXECUTED" appears on the screen or the device restarts.

Confirm the message "SELECTION EXECUTED" with F4 .

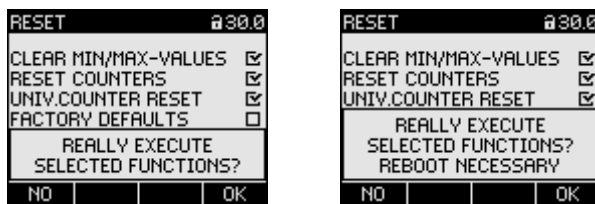

Figure 9-23 "RESET" device setting

CLEAR MIN/MAX-VALUES	Resets all minimum and maximum values to the instantaneous value.
RESET COUNTERS	Resets the following counters to 0 (zero): <ul style="list-style-type: none"> • Energy counter for active energy, reactive energy, apparent energy. • Working hours counter
UNIV.COUNTER RESET	Resets the configurable universal counter to 0 (zero).
FACTORY DEFAULTS	Resets the device settings to the default values. Clears minimum/maximum values. Resets all counters.

NOTICE**Access protection is switched off**

Resetting to the factory defaults deactivates device protection. Password protection is switched off. The password is set to the value "0000".

NOTICE**Counter - Reset**

Resetting to the factory defaults has the effect of resetting all counters!

COMMUNICATION PARAM.

Resets the entered TCP/IP address to:
0.0.0.0

EXECUTE

Reset function. Resets the selected value groups.

See also

Limits (Page 34)

9.2.10 PAC PROFIBUS DP expansion module

If the PAC PROFIBUS DP expansion module is plugged in , the device setting "PROFIBUS MODULE" is executed in the "SETTINGS" menu.

Call: "SETTINGS > PROFIBUS MODULE".

PROFIBUS ADDRESS

PROFIBUS address number of the device
Range: 0-126

9.2.11 PAC RS485 expansion module

PAC RS485 expansion module

If the PAC RS485 expansion module is plugged in, the device setting "RS485 MODULE" is executed in the "SETTINGS" menu.

Call: "SETTINGS > RS485 MODULE".

RS485 MODULE	Default values of the device
ADDRESS	126 (adjustable range: 0-126)
BAUD RATE	19200
SETTINGS	8N2
PROTOCOL	MODBUS RTU
RESPONSE TIME	0 ms

9.2.12 Password management

9.2.12.1 Introduction

Note:

The default password is:
0000

If no user-specific password has been assigned, the default password must be entered when password protection is switched on.

9.2.12.2 Calling password management

You can find password management in the device settings under "ADVANCED > PASSWORD"

To access password management:

1. Exit the measured value display. Call the "MAIN MENU":
F4 **MENU**
2. In the main menu, go to the "SETTINGS" entry:
F2 **▲** or F3 **▼**
3. Call the "SETTINGS" entry:
F4 **ENTER**
4. In the "SETTINGS" menu, go to the "ADVANCED" entry:
F2 **▲** or F3 **▼**
5. Call the "ADVANCED" entry:
F4 **ENTER**
6. In the "ADVANCED" menu, call the "PASSWORD PROTECTION" entry:
F4 **ENTER**



9.2.12.3 Switch on password protection

Password protection can be switched on at any time.

NOTICE

Password known?

Before you switch on password protection, make sure you and the group of authorized users are all in possession of the password. If password protection is switched on, the password is mandatory for all changes to the device settings. You also require the password to call the "PASSWORD" dialog box again in order to switch off access protection or to change the password.

Password protection is effective as soon as it is switched on! The password protection symbol in the display title changes from  "unprotected" to  "protected". While you are in the "PASSWORD PROTECTION" dialog box, you can switch password protection off again or view the password in the "PASSWORD" field.

To switch password protection on, proceed as follows:

1. Call the "PASSWORD PROTECTION" display.
2. Activate the field "PASSWORD PROTECTION" with F4 

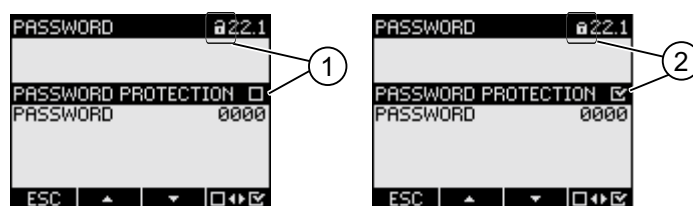



Figure 9-24 "PASSWORD PROTECTION" device setting



- (1)  Password protection switched **OFF**
- (2)  Password protection switched **ON**

9.2.12.4 Switch off password protection

If password protection is switched off, there is no protection against unauthorized or inadvertent changes to the device settings.

The password becomes visible on the display when password protection is switched off. The password remains saved and becomes effective again the next time password protection is switched on.

To switch off password protection:

1. Call the "PASSWORD PROTECTION" display.
2. Deactivate the "PASSWORD PROTECTION" field with F4 
The device opens the "ENTER PASSWORD" dialog box.
3. Enter the password and confirm with F4 
The display returns to the "PASSWORD PROTECTION" display. The password is visible on the display.

If you have given the correct password, password protection is switched off.
If you have given an incorrect password, password protection remains active. Start again at Step 2 and enter the correct password.

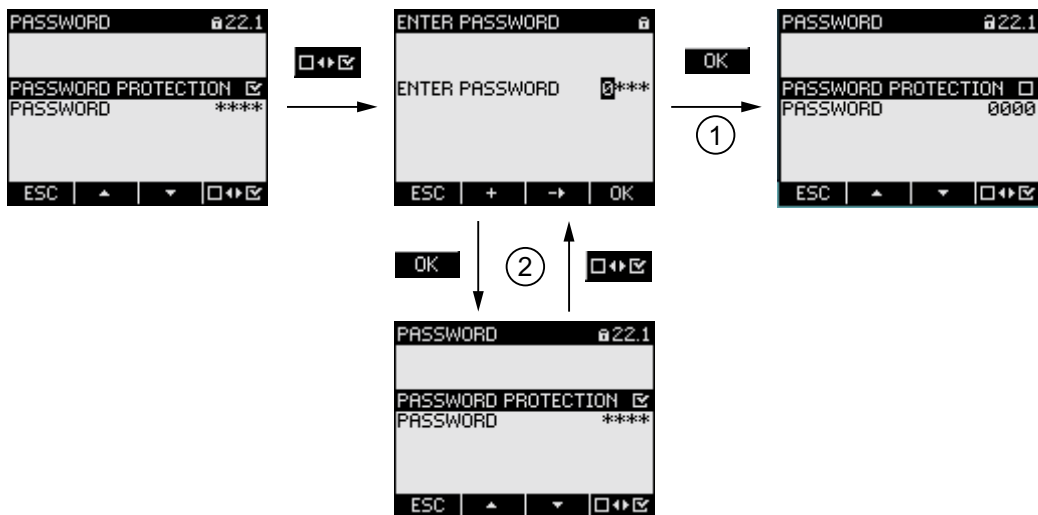

Figure 9-25 Switch off password protection

- (1) Password accepted
- (2) Password rejected







9.2.12.5 Change password

The password can be changed whether access protection is on or off. If access protection is switched on, the currently valid password is required in order to change the password.

Initial situation: Password protection switched off

If password protection is switched off, the password is also unprotected and can therefore be changed without restriction.

To change the password:

1. Call the "PASSWORD PROTECTION" display.
 2. Go to the "PASSWORD" device setting:
F2  or F3 
 3. Open edit mode of the "PASSWORD" device setting:
F4 
 4. Change the password with:
F2  and F3 
 5. Accept the new password with:
F4 
- The password is permanently saved and becomes effective immediately.
The display returns to display mode.

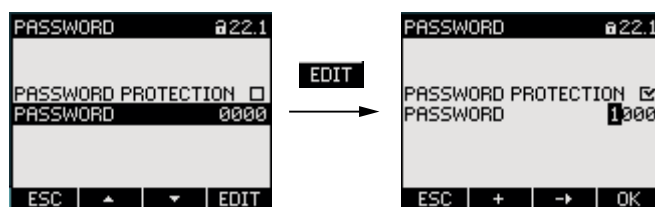









Figure 9-26 Change password

Initial situation: Password protection switched on:

If password protection is switched on, the valid password must be entered in order to change the password.

To change the password:

1. Call the "PASSWORD PROTECTION" display.
 2. Go to the "PASSWORD" device setting:
F2  or F3 
 3. Open edit mode of the "PASSWORD" device setting:
F4 
 4. The device opens the "ENTER PASSWORD" dialog box.
 5. Enter the password and confirm with
F4 
If you have entered the correct password, the password becomes visible in the PASSWORD field.
 6. Open edit mode of the device setting "PASSWORD" with:
F4 
 7. Change the password with:
F2  and F3 
 8. Accept the new password with:
F4 
- The password is permanently saved and becomes effective immediately.

The display returns to display mode.
The newly assigned password remains visible until you exit the dialog box with F1 **ESC**.

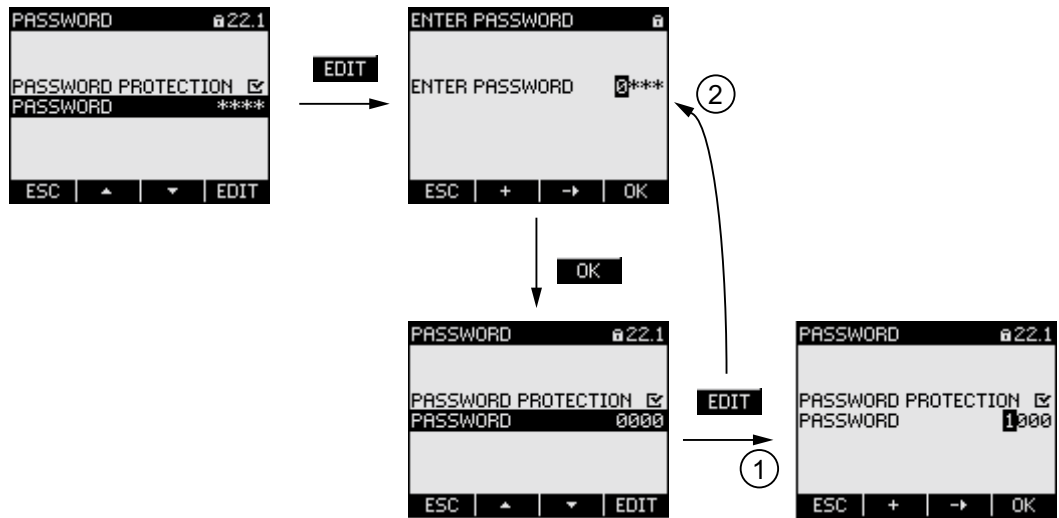

Figure 9-27 Change password - Password protection on

- (1) Password accepted
- (2) Password rejected

9.2.12.6 Password lost - what to do?

If you have forgotten the password, please contact Technical Support. You will receive a new password from them.

You can find the address of Technical Support under "Technical Support" in the Chapter "Introduction".

Requesting a new password

Please have the following information to hand when phoning or provide it in writing:

- MAC address of the device.
- You can find the MAC address under "SETTINGS > COMMUNICATION"

NOTICE
Change password immediately on receipt
As soon as you receive the new password, you must change it and inform the group of authorized users.

See also

Technical support (Page 13)

Maintenance and servicing

10.1 Cleaning

Description

The SENTRON PAC3200 is maintenance-free.

Calibration

The device has been calibrated by the manufacturer before shipping. Recalibration is not required provided the environmental conditions are maintained.

Cleaning

Clean the display and the keypad periodically. Use a dry cloth for this.

CAUTION
Damage due to detergents
Detergents can damage the device. Do not use detergents.

10.2 Repair

Procedure

NOTICE
Loss of warranty If you open the device, it loses its Siemens warranty. Only the manufacturer may carry out repairs to the device. Return faulty or damaged devices to Siemens for repair or replacement.

If the device is faulty or damaged, proceed as follows:

1. Deinstall the device.
2. Pack the device in a suitable manner to prevent it from being damaged during transport.
3. Return the device to Siemens. You can obtain the address from:
 - Your Siemens sales partner
 - Technical assistance
 - Technical support

10.3 Disposal

Disposal and recycling

Dispose of or recycle the module in accordance with the applicable laws and regulations in your country.

Technical data

11.1 Technical data

Device configuration

- 1 slot for optional expansion module
- 1 optically isolated digital input
- 1 optically isolated digital output
- 1 Ethernet interface, RJ45 socket for connecting to the PC or network

Measuring inputs

Only for connection to AC voltage systems			
Frequency of the relative fundamental		50/60 Hz Set automatically	
Measurement rate			
	Energy	Continuous (zero blind measuring)	
	Current, voltage	Continuous	
		Values on the display refreshed at least once per second	
	Waveform	Sine or distorted	
AC voltage input			
	Device with multi-range power supply		
	Phase-to-neutral voltage U_{L-N}	3~ 400 V AC (+ 20 %), max. 347 V for UL	
	Phase-to-phase voltage U_{L-L}	3~ 690 V AC (+ 20 %), max. 600 V for UL	
	Device with extra-low voltage power supply		
	Phase-to-neutral voltage U_{L-N}	3~ 289 V AC (+ 20 %)	
	Phase-to-phase voltage U_{L-L}	3~ 500 V AC (+ 20 %)	
	Minimum input voltage V_{ph-n}	3~ 40 V AC	
	Measuring category	(in accordance with IEC/UL 61010 Part 1)	
	Input voltage V_I		
		V_I to 230 V (V_{ph-n})	CAT III
		V_I to 400 V (V_{ph-ph})	CAT III
		V_I to 289 V (V_{ph-n})	CAT III
		V_I to 500 V (V_{ph-ph})	CAT III

Technical data

11.1 Technical data

		V_I to 400 V (V_{ph-n}), max. 347 V for UL (not for device with extra-low voltage power supply)	CAT III
		V_I to 690 V (V_{ph-n}), max. 600 V for UL (not for device with extra-low voltage power supply)	CAT III
		Higher voltages only if using voltage transformers	
	Input resistance (ph-n)	1.05 Mohms	
	Power consumption per phase	220 mW	
AC current input			
Only for connection to external current transformers			
	Input current I_I	3~ x AC / 1 A (+ 20%, max. 300 V) or 3~ x AC / 5 A (+ 20%, max. 300 V)	
	Surge withstand capability	100 A for 1 s	
	Power consumption per phase	4 mVA at 1 A 115 mVA at 5 A	

Measuring accuracy

Measured variable	Error limits
Voltage	$\pm 0,3 \%$
Current	$\pm 0,2 \%$
Power	$\pm 0,5 \%$
Frequency	$\pm 0,05 \%$
Power factor	$\pm 0,5 \%$
Active energy	Class 0.5S in accordance with IEC 62053-22:2003-01
Reactive energy	Class 2 in accordance with IEC 62053-23:2003-01

When measuring on external current transformers or voltage transformers, the accuracy of the measurement depends on the quality of the transformer.

Digital input

Number	1 input	
Input voltage		
	Rated value	24 V DC
	Maximum input voltage	30 V DC
	Switching threshold for signal "1"	> 11 V DC
Input current		
	For signal "1"	typ. 7 mA

Digital output

Number	1 output	
External power supply	12 to 24 V DC	
	Max. switched output voltage	30 V DC
Output current		
	For signal "1"	10 to 27 mA
	Continuous load	max. 100 mA
	Transient overload	max. 300 mA for a duration of 100 ms
	Resistive load	100 mA
	For signal "0"	max. 0.2 mA
Switch rate	17 Hz	
Short-circuit protection	Yes	

Power supply

Table 11-1 AC/DC multi-range power supply

Rated range	95 ... 240 V AC (50/60 Hz) or 110 ... 340 V DC
Work area	± 10% of AC rated range ± 10% of DC rated range
Power consumption	Typically 8 VA (with optional expansion module).
Overvoltage category	CAT III

Table 11-2 Extra-low voltage DC power supply:

Rated range	24 V, 48 V and 60 V DC or 22 to 65 V DC
Work area	± 10% of rated range DC
Power consumption	Typically 8 VA (with optional expansion module).
Overvoltage category	CAT III

Retention of data in the absence of the supply voltage

Measured values and counters are monitored for minimum and maximum values at specific intervals and only saved to the non-volatile memory in the event of a change. This means the age of the data before the power failure is as follows:

- Minimum and maximum values max. 5 s
- Counters max. 5 min

Connection elements

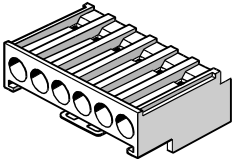
Measuring inputs and supply voltage			
	Screw-type terminals		
	Connection designations		IL1(° ↑k, ↓), IL2(° ↑k, ↓), IL3(° ↑k, ↓) V ₁ , V ₂ , V ₃ , V _N , L/+, N/- 1-wire or 2-wire connection possible
	Solid		1 x 0.5 ... 4.0 mm ² AWG 1 x 20 ... 12 2 x 0.5 ... 2.5 mm ² AWG 2 x 20 ... 14
	Finely stranded with end sleeve		1 x 0.5 ... 2.5 mm ² AWG 1 x 20 ... 14 2 x 0.5 ... 1.5 mm ² AWG 2 x 20 ... 16
	Stripping length		10 mm
	Connection screws		
		Tightening torque	0.8 ... 1.2 Nm 7 ... 10.3 lbf-in
		Tool	Screwdriver PZ2 cal. ISO 6789 Crimping tool in accordance with EN 60947-1

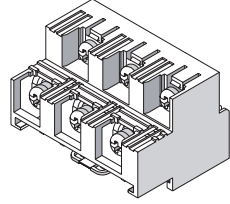
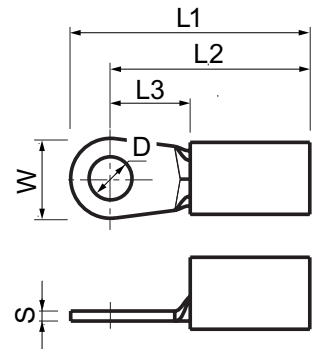
	Ring lug terminals		
	Connection designations	IL1(°↑k, I↓), IL2(°↑k, I↓), IL3(°↑k, I↓) V ₁ , V ₂ , V ₃ , V _N , L/+, N/-	
	Dimensions of the ring lug	Dimensions	[mm] [inch]
		D	3 ... 4 0.118 ... 0.157
		VA	0,75 ... 1,0 0.029 ... 0.039
		W	≤ 8 ≤ 0.314
		L1	≤ 24 ≤ 0.944
		L2	≤ 20 ≤ 0.787
		L3	≥ 8 ≥ 0.314
			
	Connection bolt	M3 to M4	#5 ... #8
	Conductor cross section depending on the ring lug used	1.0 to 6.0 mm ²).	AWG 18 to 10
		The national standards for ring lugs must be observed, e.g. UL listed under ZMVV /7, CSA, DIN 46237, IEC 60352-2 Please observe the information of the ring lug manufacturer as well as IEC 60352-2 with regard to the creation of suitable crimp connections The ring lugs must be mounted parallel to each other.	
	Connection screws		
		Tightening torque	0.8 ... 1.2 Nm 7 ... 10.3 lbf·in
		With vertical screwing force	30 N 6.75 lbf
		Tool	Screwdriver PZ2 cal. ISO 6789 Crimping or pressing tool according to manufacturer's information for ring lugs
Digital output, digital input			

Technical data

11.1 Technical data

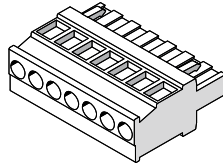
	Screw terminal		
	Connection designations		⚡, DI-, DI+, DO-, DO+
		Solid	1 x 0.2 ... 2.5 mm ² 2 x 0.2 ... 1.0 mm ²
		Finely stranded without end sleeve	1 x 0.2 ... 2.5 mm ² 2 x 0.2 ... 1.5 mm ²
		Single-core with end sleeve, without plastic sleeve	1 x 0,25 ... 2.5 mm ² 2 x 0,25 ... 1.0 mm ²
		Single-core with end sleeve, with plastic sleeve	1 x 0.25 ... 2.5 mm ²
		Single-core with TWIN end sleeve, with plastic sleeve	2 x 0,5 ... 1,5 mm ²
		AWG cables	1 x 24 ... 12
		Stripping length	7 mm
	Connection screws		
		Tightening torque	min. 0.5 Nm
		Tool	Screwdriver PZ1 cal. ISO 6789 Crimping tool in accordance with EN 60947-1
RJ45 connector			

Enclosure

Housing design		Switching panel housing to IEC 61554
Housing dimensions W x H x D		96 mm x 96 mm x 51 mm
Overall depth		51 mm
Permissible thickness of the switching panel for installation		max. 4 mm
Weight		
	Power Monitoring Device	Approximately 325 g
	includes packaging	Approximately 460 g
Mounting position		The mounting position is vertical
Protection Class		Protection class II when installed.
Degree of protection according to IEC 60529		
	Front	IP65
	Rear	Device with screw terminal IP20, NEMA 1A
		Device with ring lug terminal IP10 If higher degree of protection requirements are placed on the application engineering, the customer must take suitable measures

Display

Type	Monochrome, graphical LC display, light backlighting, dark text and digits
Resolution	128 x 96 pixels
Size W x H	72 mm x 54 mm

Keyboard

4 function keys F1 to F4 on the front, multiple assignments.

Electromagnetic compatibility

Emission	IEC 61000-6-4 Group 1 Class A or CISPR11 Group 1 Class A or FCC Part 15 Subpart B Class A.	
Immunity	IEC 61000-6-2 or IEC 61326-1:2005, Table 2.	
	Enclosure	
	Electrostatic discharge	IEC 61000-4-2:2001-04
	Electromagnetic fields	IEC 61000-4-3:2006-02
	Line-frequency magnetic fields	IEC 61000-4-8:2001-03
	Measuring voltage and supply voltage	
	Voltage dips	IEC 61000-4-11:2004-03
	Fast transients	EN 61000-4-4:2005-07
	Voltage surges	EN 61000-4-5:2001-12
	Cable-borne HF signals	EN 61000-4-6:2001-12
	Inputs and outputs, interfaces	
	Fast transients	IEC 61000-4-4:2004-07
	Voltage surges	IEC 61000-4-5:2005-11
	Cable-borne HF interference fields	EN 61000-4-6:2001-12

Environmental conditions

The device is suitable for switch panel mounting in accordance with IEC 61554. Operation is only permissible inside an enclosed dry room.

Temperature range		
	Operating temperature	- 10 °C to + 55 °C
	Storage and transport temperature	- 25 °C to + 70 °C
Relative humidity		95% at 25°C without condensation (normal conditions)
Operating altitude above sea level		Up to 2000 m
Degree of pollution		2

Mechanical dynamic stress

Environmental requirements Low-temperature test	In accordance with DIN EN 60068 Part 2-1:1995-03
Vibratory load Test Fc (conditions of use)	in accordance with IEC 60068 Part 2-6:1995-03 / EN 60068 Part 2-6:1996-05
Vibratory load Test Fc (transport conditions)	in accordance with IEC 60068 Part 2-6:1995-03 / EN 60068 Part 2-6:1996-05
Seismic conditioning Test Fe/(conditions of use)	in accordance with IEC 60068 Part 3-3:1991-02/ EN 60068 Part 3-3:1993-09
Shock load Test Ea (conditions of use)	in accordance with IEC 60068 Part 2-27:1987 / EN 60068 Part 2-27:1995-03
Shock test, withstand strength Test Ea/(conditions of use)	in accordance with IEC 60068 Part 2-27:1987 / EN 60068 Part 2-27:1995-03
Continuous shock Test Eb (transport conditions)	in accordance with IEC 60068-2-29:1987 / EN 60068 Part 2-29:1995-03
Mechanical stability against bump and impact/(conditions of use)	in accordance with IEC 60068-2-75:1997-08
Free fall of the unpacked device (transport conditions)	in accordance with IEC 60068-2-32:1975

Safety regulations

The device has been tested in accordance with the following standards:

	IEC / UL 61010-1:2001 (2nd Ed.) with Corr. 1 CAN / CSA C22.2 No. 61010-1, second Edition EN 61010-1-1:2001 (2nd Ed.) DIN EN 61010-1:2002 with Corr. 1
--	--

11.2 Labeling

Labels on the housing of the SENTRON PAC3200

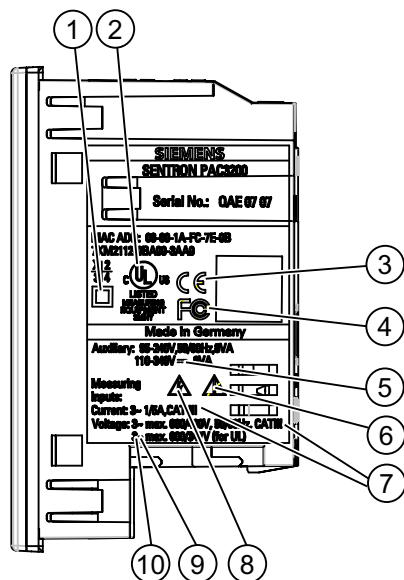



Figure 11-1 Device labeling

	Symbol, label	Explanation
(1)		Protective insulation, device of protection class II.
(2)		Products with this mark comply with both the Canadian (CSA) and the American (UL) requirements.
(3)		CE mark. Confirmation of conformity of the product with the applicable EU directives and compliance with the essential requirements contained in these directives.
(4)		FCC declaration.
(5)		DC current

	Symbol, label	Explanation
(6)		Caution! General hazard area.
(7)	CAT III	Overvoltage category CAT III for current and voltage inputs.
(8)		Danger of electric shock.
(9)	~	AC current
(10)	3~	Three-phase AC

Dimension drawings

12.1 Dimension drawings

Note: All dimensions in mm.

Panel cutout

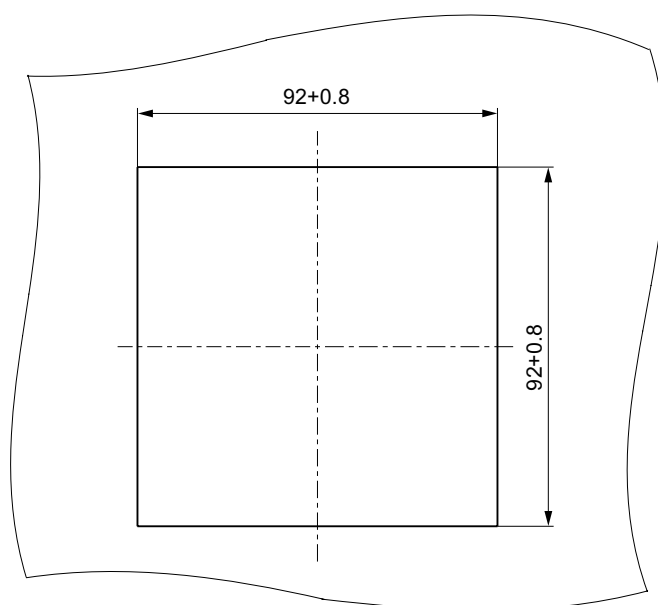

Figure 12-1 Panel cutout

Frame dimensions

Device with screw terminals

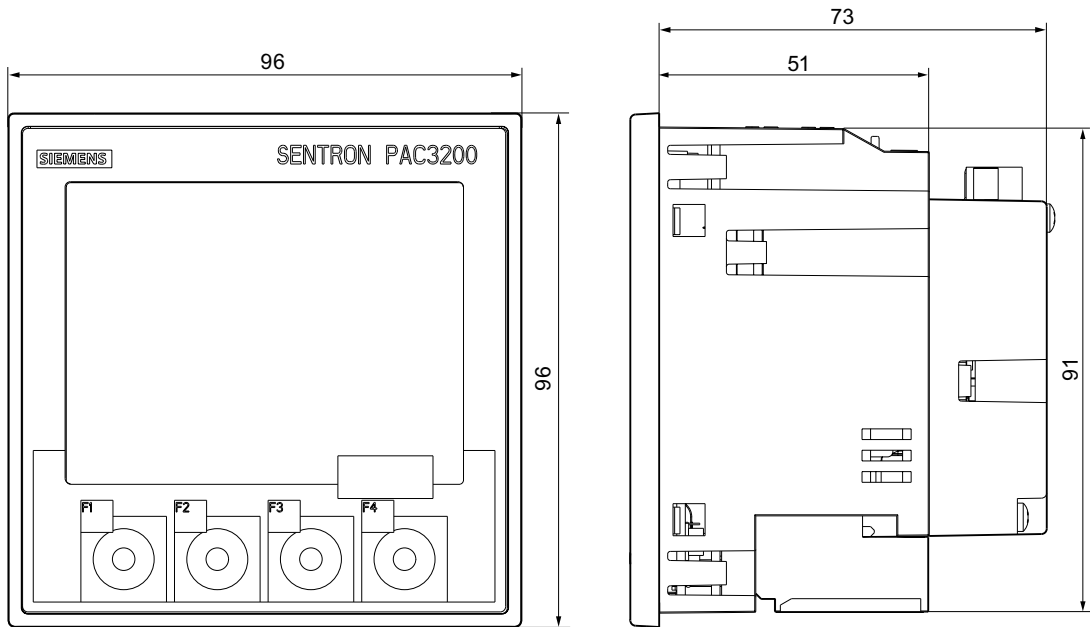

Figure 12-2 Frame dimensions with optional PAC PROFIBUS DP expansion module connected

Device with ring lug terminals

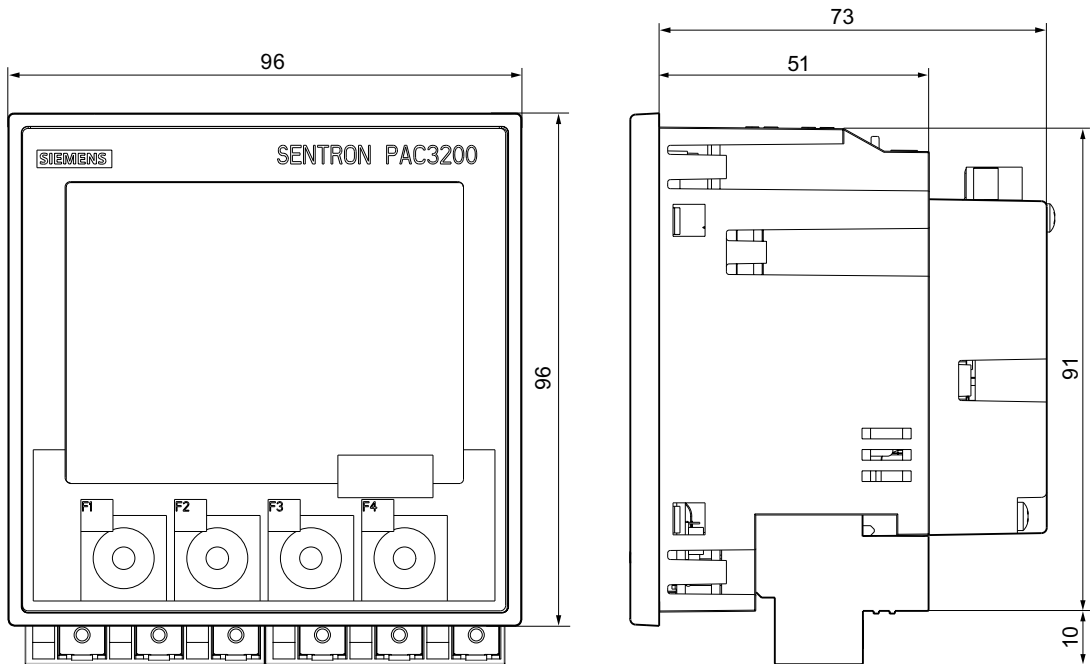

Figure 12-3 Frame dimensions with optional PAC PROFIBUS DP expansion module connected

Clearance measurements

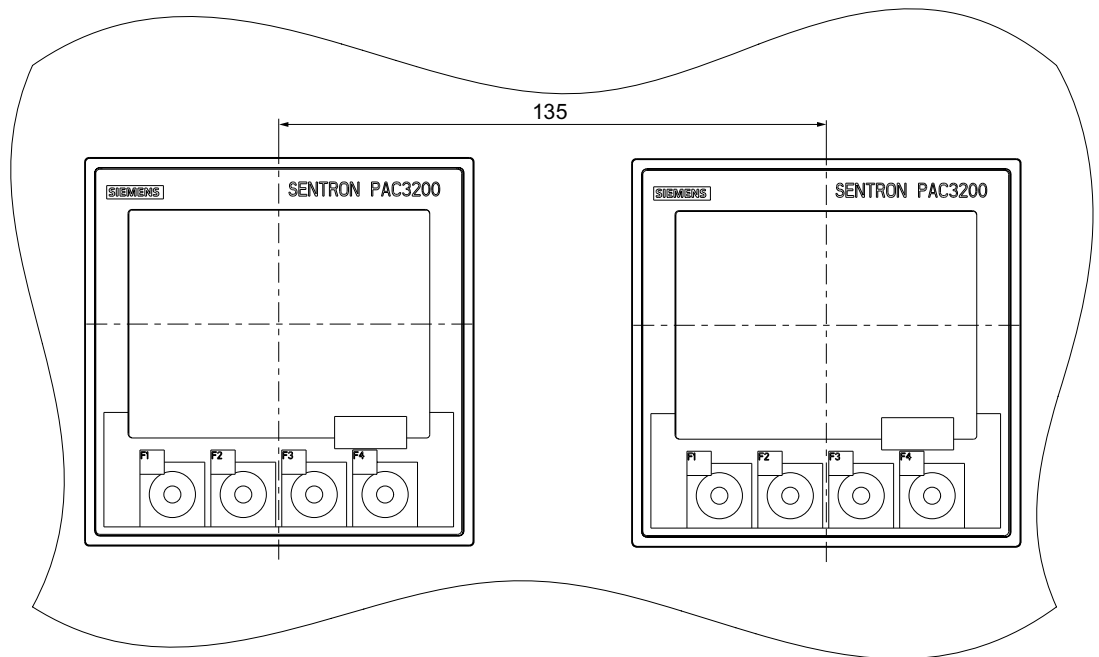

Figure 12-4 Side-by-side installation

Clearances

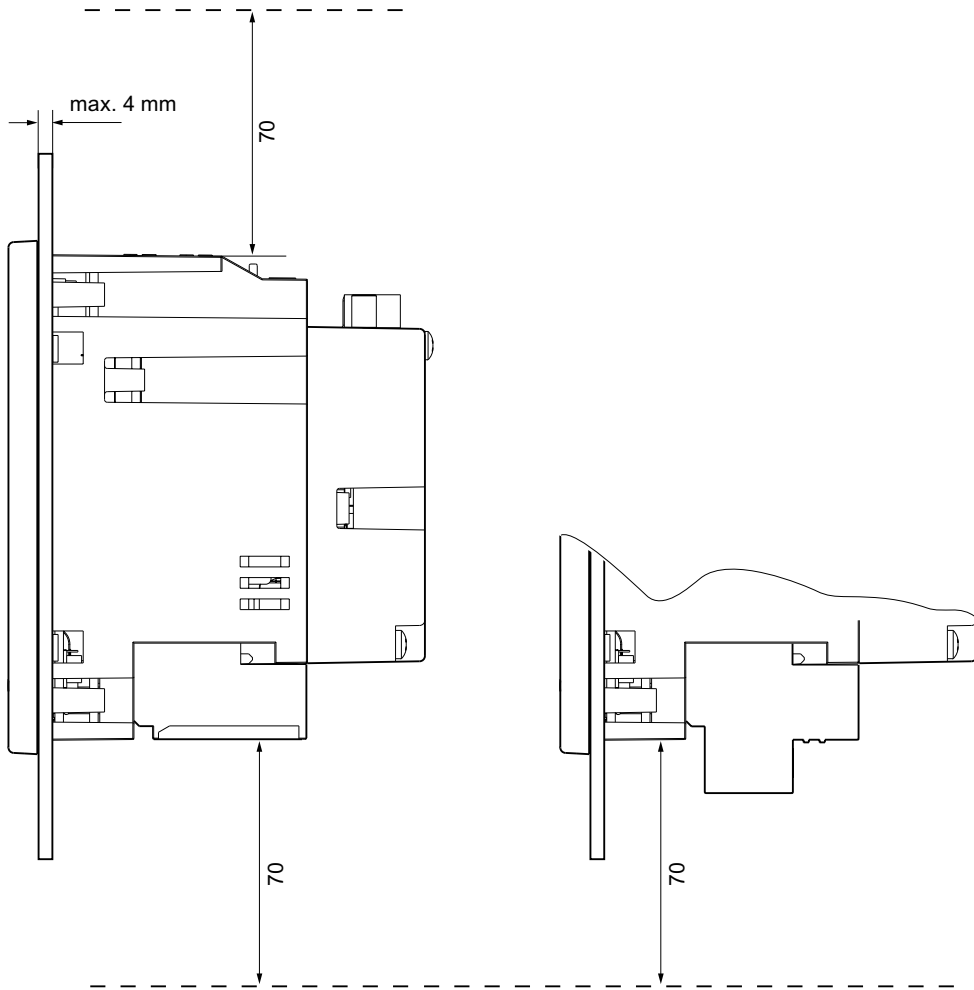

Figure 12-5 Clearances, device with screw terminal (on the left), device with ring lug terminal (on the right)

The clearances specified must be maintained for cable outlets and ventilation.

Appendix

A.1 Certification marks

CE mark



The SENTRON PAC3200 Power Monitoring Device meets the requirements and protection goals of the following EC directives:

- Low Voltage Directive 2006/95/EC
- EMC Directive 2004/108/EC

UL mark



Products with this symbol meet both UL and Canadian requirements.

A.2 Correction sheet

Correction sheet

Have you noticed any errors while reading this manual? If so, please use this form to tell us about them. We welcome comments and suggestions for improvement.

Fax response

To	From (please complete):
SIEMENS AG	Name
A&D CD MM3	Company/Department
P.O. Box 1954	Address
92220 Amberg / Germany	

Fax: +49 (0)96-21-80-33-37

Manual title:

Table A-1 Errors, comments, and suggestions for improvements

ESD Guidelines

B.1 Electrostatic sensitive devices (ESD)

ESD components are destroyed by voltage and energy far below the limits of human perception. Voltages of this kind occur as soon as a device or an assembly is touched by a person who is not electrostatically discharged. ESD components which have been subject to such voltage are usually not recognized immediately as being defective, because the malfunction does not occur until after a longer period of operation.

ESD Guidelines

 CAUTION
<p>Electrostatic sensitive devices</p> <p>Electronic modules contain components that can be destroyed by electrostatic discharge. These modules can be easily destroyed or damaged by improper handling.</p> <ul style="list-style-type: none"> • You must discharge your body electrostatically immediately before touching an electronic component. To do this, touch a conductive, grounded object, e.g., a bare metal part of a switch cabinet or the water pipe. • Always hold the component by the plastic enclosure. • Electronic modules should not be brought into contact with electrically insulating materials such as plastic film, plastic parts, insulating table supports or clothing made of synthetic fibers. • Always place electrostatic sensitive devices on conductive bases. • Always store and transport electronic modules or components in ESD-safe conductive packaging, e.g. metallized plastic or metal containers. Leave the component in its packaging until installation.

<p>CAUTION</p>
<p>Storage and transport</p> <p>If you have to store or transport the component in non-conductive packaging, you must first pack the component in ESD-safe, conductive material, e.g., conductive foam rubber, ESD bag.</p>

The diagrams below illustrate the required ESD protective measures for electrostatic sensitive devices.

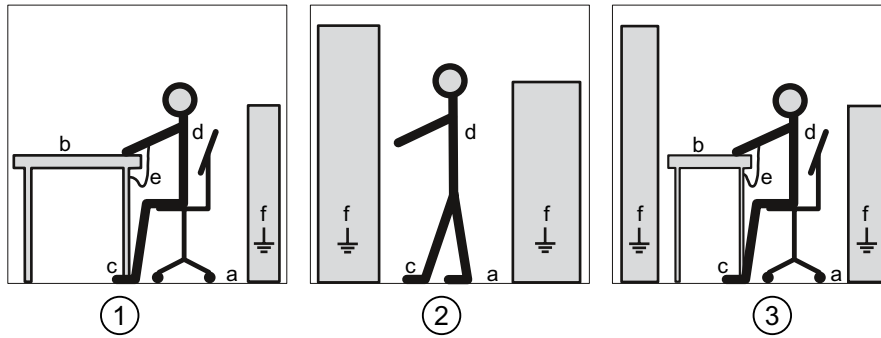

Figure B-1 ESD work center

- (1) ESD seat
- (2) ESD standing position
- (3) ESD seat and ESD standing position

Table B-1 Protective measures

- a Conductive floor
- b ESD table
- c ESD footwear
- d ESD smock
- e ESD bracelet
- f Cubicle ground connection

List of abbreviations

C.1 Abbreviations

Overview

Table C-1 Meaning of abbreviations

Abbreviation	Meaning
AWG	American Wire Gauge
CE	Communautés Européennes (French for "European Union")
CISPR	Comité international spécial des perturbations radioélectriques
CSA	Canadian Standards Association
DIN	Deutsches Institut für Normierung e. V.
DP	Distributed I/Os
EC	European Union
ESD	Electrostatic sensitive devices
EIA	Electronic Industries Alliance
EMC	Electromagnetic compatibility
EN	European Standard
EU	European Union
FCC	Federal Communications Commission
GSD	Device master data
High/Low tariff:	High tariff/low tariff
I&M	Information and Maintenance
ID	Identification number
IEC	International Electrotechnical Commission
IP	International Protection
ISM	Industrial, Scientific and Medical
ISO	International Standardization Organization
LCD	Liquid crystal display
MAC	Media Access Control
NAFTA	North American Free Trade Agreement
NEMA	National Electrical Manufacturers Association
PAC	Power Analysis & Control
RJ	Registered Jack
RS	Formerly: Radio Selector; now usually: Recommended Standard

List of abbreviations

C.1 Abbreviations

Abbreviation	Meaning
TCP/IP	Transmission Control Protocol/Internet Protocol
THD	Total Harmonic Distortion; German: Gesamte Harmonische Verzerrung
THD-R	Relative THD
UL	Underwriters Laboratories Inc.
VDE	Association of Electrical Engineering, Electronics and Information Technology (Germany)
RLO	Result of logic operation

Glossary

Bus

Shared transmission path over which all bus nodes are connected. It has two defined ends. In the case of PROFIBUS, the bus is a twisted pair or optical fiber cable.

Bus system

All nodes physically connected to a bus cable form a bus system.

Diagnosis

The detection, localization, visualization and further evaluation of errors, disturbances and messages.

Diagnostics offers monitoring functions that automatically run while the system is in operation. This reduces startup times and standstill times. Plant availability increases.

PROFIBUS

PROCESS FIELDBUS, a European process and fieldbus standard defined in the PROFIBUS standard EN 50170, Volume 2 PROFIBUS. Specifies the functional, electrical and mechanical characteristics of a serial bit stream fieldbus system.

PROFIBUS is a bus system that connects PROFIBUS-compatible automation systems and field devices together at the cell level and field level.

PROFIBUS address

Every bus node receives a unique PROFIBUS address. The bus node is identified on PROFIBUS with this address.

Index

A

- Apply the measuring current, 101
- Apply the measuring voltage, 100
- Apply the supply voltage, 92

B

- Bit mask, 44, 45

C

- Calibration, 155
- CD
 - Contents, 13
- Check the packaging, 67
- Cleaning, 155
- Clearance measurements, 68, 169
- Clearances, 170
- Command parameters, 61
- Commissioning
 - Setting the language, 94
- Communication interface, 63
- Communication parameters, 58
- Components of the product, 12
- Conductive floor, 174
- Connection examples, 82
- Connection type
 - Checking, 102
 - setting, 95
- Connection types, 23
- Connection Types
 - Dependency of the measured variables, 26
- Contact
 - Technical problems, 13
- Contacts
 - In your region, 14
- Contents
 - CD, 13
- Correction sheet, 172
- Counters, 20, 32
- Cubicle ground connection, 174
- Current direction, 25

- Current transformers

 - Set the conversion ratio, 99

D

- Default password, 150
- Deinstalling, 72
- Device diagnostics, 45
- Device identification parameters, 62
- Device status, 45
- Device versions, 20
- Digital input, 37
- Digital output, 36
- Dimensions, 167
 - Clearance measurements, 169
 - Clearances, 170
 - Frame dimensions, 168
 - Panel cutout, 167
 - Ring lug, 161
- Direction of current flow, 101
- Discharge, 173
- Display
 - Measured variables, 26
- Disposal, 156

E

- Electrostatic sensitive devices, 173
- Environmental conditions, 66
- Error code, 40, 59
- ESD bracelet, 174
- ESD footwear, 174
- ESD Guidelines, 173
- ESD protective measures, 173
- ESD seat, 174
- ESD smock, 174
- ESD standing position, 174
- ESD table, 174

F

- Features, 19
- Frame dimensions, 168
- Function code, 62

- G**
 - General safety notes, 17
 - GSD file, 13
- I**
 - Installation
 - Procedure, 68
 - Installation format, 21
 - Installation space
 - Ventilation, 66
 - Installation tools, 68
 - Interface, 21, 63
- L**
 - Language, 94
 - Limit value, 45
 - Definition, 34
 - Logic combination, 34
 - Limit values, 34
 - Limit violation, 35, 45
- M**
 - Measured variables, 28
 - Display, 26
 - Modbus
 - Digital inputs, status, 44
 - Digital outputs, status, 44
 - MODBUS function code, 40, 46, 47, 58, 61, 62
 - MODBUS measured variables, 40
 - Monitoring functions, 21
 - More information
 - SENTRON PAC3200, 15
 - Mounting dimensions, 68, 167
 - Mounting location, 65
 - Mounting position, 65
- O**
 - Object ID, 62
 - Offset, 40, 45, 46, 47, 48, 49, 50, 51, 52, 53, 55, 56, 58, 61
 - Online support, 14
 - Orientation aids, 12
 - Overload display, 25
- P**
 - Packaging, 67
 - Panel cutout
 - Dimensions, 167
 - Parameter
 - Command, 61
 - Communication, 58
 - Device information, 62
 - Status, 46
 - Parameterize
 - Device settings, 127
 - Startup, 93
 - Parameterizing the device, 93
 - Parameters
 - Settings parameters, 47
 - Password
 - Administration, 150
 - Default password, 150
 - lost, forgotten, 154
 - Power demand, 20, 32
 - Power failure, 36
 - Power supply, 21
 - Prerequisites
 - Startup, 91
 - Procedure
 - Installation, 68
 - Protection, 22
 - Pulse length, 37
- R**
 - Recycling, 156
 - Register, 40, 45, 46, 47, 48, 49, 50, 51, 52, 53, 55, 56, 58, 61
 - Repair, 156
 - Loss of warranty, 156
 - Required basic knowledge, 11
 - Ring lug
 - Dimensions, 161
 - Ring lug terminal
 - Terminal labeling, 78
 - Ring lug terminals
 - Technical data, 161
- S**
 - Screw terminal
 - Technical data, 162
 - Terminal labeling, 77
 - SENTRON PAC3200
 - More information, 15

- Setting the language, 94
- Setting the voltage input, 98
- Settings parameters, 47
- Startup, 91
 - Apply the supply voltage, 92
 - Parameterizing the device, 93
 - Prerequisites, 91
 - Set the connection type, 95
- Status parameters, 46
- Storage, 67, 173
- Support
 - Address, 14
 - Online, 14
 - Technical, 14
- Support address, 14

T

- Tariffs, 33
- Technical problems
 - Contact, 13
- Technical Support, 14
- Temperature compensation, 66
- Transport, 173
- Turn-off time, 37

V

- Validity range, 11
- Ventilation
 - Installation space, 66
- Voltage input, 98
- Voltage transformers
 - Measurement, 96
 - Set the conversion ratio, 97

