

The Siemens logo is displayed in a white rectangular box in the upper left corner of the page. The background of the entire page is a futuristic industrial scene with glowing blue and green digital overlays, including wireframe models of machinery, data flow diagrams, and a central control console with multiple monitors.

SIMATIC

Products for Totally Integrated Automation

Catalog
ST 70

Edition
2017

siemens.com/tia

Related catalogs

SIMATIC HMI / PC-based Automation ST 80/ST PC
Human Machine Interface Systems
PC-based Automation
E86060-K4680-A101-C4-7600



Industrial Communication IK PI
SIMATIC NET
E86060-K6710-A101-B8-7600



SIMATIC ST PCS 7
SIMATIC PCS 7
Process Control System
System components
E86060-K4678-A111-C3-7600



SITOP KT 10.1
Power supply
SITOP
E86060-K2410-A101-B2-7600

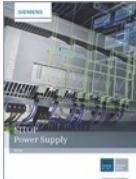

SIMATIC Ident ID 10
Industrial Identification Systems
E86060-K8310-A101-B1-7600



Motion Control System PM 21
SIMOTION
Equipment for Production Machines
E86060-K4921-A101-A4-7600



SITRAIN ITC
Training for Industry
Only available in German
E86060-K6850-A101-C5



Siemens TIA Selection Tool
for the selection, configuration and ordering of
TIA products and devices
www.siemens.com/tst



Products for Automation and Drives CA 01
Interactive Catalog
DVD
E86060-D4001-A510-D7-7600



Industry Mall
Information and Ordering Platform
on the Internet:
www.siemens.com/industrymall



Response email
Please send your comments and suggestions
for improvement to
catalogs.industry@siemens.com
(include the catalog name in the subject field)



Products for Totally Integrated Automation

SIMATIC



Catalog ST 70 · 2017

Supersedes:
Catalog ST 70 · 2015
Catalog News ST 70 N · 2016

Refer to the Industry Mall for current updates of this catalog:

www.siemens.com/industrymall

The products contained in this catalog can also be found in the Interactive Catalog CA 01.
Article No.: E86060-D4001-A510-D7-7600

Please contact your local Siemens branch.

© Siemens AG 2017



Printed on paper from sustainably managed forests and controlled sources.

www.pefc.org



The products and systems described in this catalog are manufactured/distributed under application of a certified quality management system in accordance with DIN EN ISO 9001 (Certified Registration No. 1323QM-08). The certificate is recognized by all IQNet countries.

Introduction	1
LOGO! logic modules	2
SIMATIC S7-1200 Basic Controllers	3
SIMATIC S7-1500 Advanced Controllers	4
SIMATIC S7-300 Advanced Controllers	5
SIMATIC S7-400 Advanced Controllers	6
Distributed Controllers	7
Software Controllers	8
I/O systems	9
SIMATIC control systems	10
Software for SIMATIC Controllers	11
SIMATIC programming devices	12
Products for specific requirements	13
Overviews	14
Supplementary components	15
Appendix	16

Introduction



1/2	LOGO! logic module
1/3	Overview of the SIMATIC Controllers
1/4	SIMATIC Basic Controllers
1/4	SIMATIC S7-1200
1/5	SIMATIC Advanced Controllers
1/5	SIMATIC S7-1500
1/8	SIMATIC Distributed Controllers
1/10	SIMATIC Software Controllers
1/11	SIMATIC programming devices
1/12	SIMATIC Industrial PCs
1/13	SIMATIC Software
1/14	SIMATIC I/O systems
1/15	SIMATIC Operator Panels

Brochures

For brochures serving as selection guides for SIMATIC products, refer to:
www.siemens.com/simatic/printmaterial

Introduction

LOGO!

LOGO! logic module

1

Overview

LOGO!:

Simply ingenious for small automation tasks

LOGO! 8 is the compact, easy-to-use and low-cost solution for simple control tasks. It is universally applicable in industry and in functional or residential buildings. Wiring is significantly reduced by internal linking of logic functions – similar to a programmable logic controller. Versions are available for LOGO! with display and integrated operating unit for displaying message texts and variables, or without display and keys.

Simple operation:

- Interconnection of functions by mouse click on the PC or at the press of a button on the device

Minimum time requirements:

- Wiring solely of the inputs and outputs

Reduced costs:

- Many integral functions of switching technology

High level of flexibility:

- Simple modification of functionality at the press of a button
- Versions for different operating voltages
- Modular design, therefore expandable at any time
- Ethernet interface for networking LOGO! basic units for connection to SIMATIC Controllers and SIMATIC Panels or for programming with a PC
- Networking of up to 16 devices
- Use of micro SD cards
- Data logging, user-defined functions (macro blocks), astronomical clock
- Integral web server in all LOGO! 8 devices



New as of Release FS:04:

- Integrated Modbus protocol (TCP/IP as client and server)
- Time synchronization via NTP (as client and server)
- LOGO! Access Tool for data access in RUN
- Extended temperature range -20 to +55 °C

For more information, refer to:

www.siemens.com/logo

LOGO! 8	24CE 24CEo	24RCE 24RCEo	12/24 RCE 12/24 RCEo	230 RCE 230 RCEo
Supply voltage	24 V DC	24 V AC/DC	12/24 V DC	115/230 V AC/DC
Inputs	8 (of which 4 for use in analog mode)	8	8 (of which 4 for use in analog mode)	8
Outputs	4, transistor	4, relay		
Continuous current	0.3 A	10 A (with resistive load), 3 A (with inductive load)		
Short-circuit protection	Electric (1 A)	External fuse required		
Integral time switches/ power reserve	Available Power reserve 480 h			
Ambient temperature	0 to +55 °C; FS:04 and higher: -20 to +55 °C			
Radio interference suppression	In accordance with EN 50 011 (limit class B)			
Degree of protection	IP20			
Certification	In accordance with VDE 0631, IEC 1131, FM, Class 1, Div 2, cULus, C-Tick, CSA, marine approvals			
Installation	On 35 mm DIN rail or wall mounting			
Dimensions (W x H x D)	72 x 90 x 55 mm (4 modular widths)			
Programming cable	Standard Ethernet			

Overview

Siemens offers the right controller for a wide range of automation requirements. The SIMATIC range of controllers comprises Basic, Advanced, Distributed and Software Controllers offering impressive scalability and integration of their functions.

Engineering in the Totally Integrated Automation Portal (TIA Portal) enables optimum automation solutions to be found for every application.

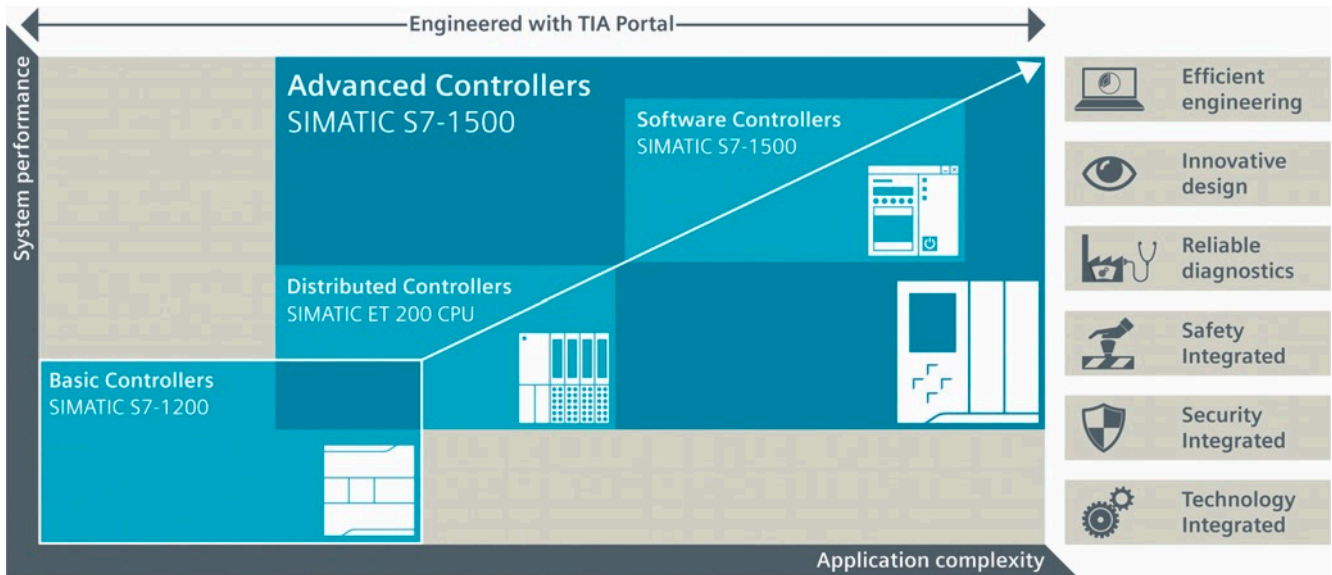

¹⁾ SIMATIC S7-300 will be available at least until 2020 as a mature, tried and proven controller. Afterwards, our 10-year replacement part guarantee goes into effect.

**Modernization with SIMATIC Controllers –
Higher productivity, efficiency and availability through retrofit or modernization**

To remain competitive in the long term, machines and plants must be continually adapted to the latest requirements. For this purpose, Siemens offers solutions using SIMATIC technologies tailored to your individual needs.

Benefit from the time-saving simulation of automation while production is in progress, optimized control options by means of I/O adapters and integrated system diagnostics, as well as global support for retrofitting or modernization. Regardless of whether you want to completely modernize your plant or just replace parts of it.

www.siemens.com/tia-migration

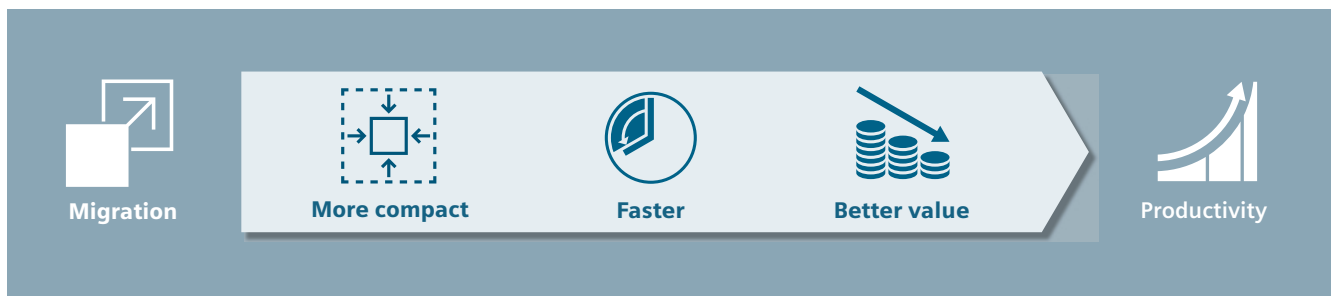

Introduction

SIMATIC Basic Controllers

SIMATIC S7-1200

1

Overview

SIMATIC S7-1200: Controllers in compact design for simple automation tasks

SIMATIC S7-1200 Basic Controllers offer persuasive, comprehensive technological features and integrated I/Os, as well as a compact, space-saving design. They are the intelligent choice for small to medium-sized projects.

The functionality of the SIMATIC S7-1200 controllers is seamlessly extended by the SIMATIC S7-1500 controllers that have been developed for more complex tasks. This means you benefit from uniform processes and the resulting maximum efficiency in engineering, operation, and maintenance, and when migrating systems.

- **Scalable and flexible design:**
The SIMATIC S7-1200 hardware is compact and modular, and it enables you to develop automation solutions that exactly meet your requirements. The innovative signal board concept lets you easily add digital and analog I/Os without changing the physical size of the controller.
- **Engineering in the TIA Portal:**
SIMATIC S7-1200 is perfectly integrated into the Totally Integrated Automation Portal (TIA Portal) for maximum engineering efficiency. All SIMATIC Controllers and SIMATIC Panels are based on a shared database, a standardized operator concept, and centralized services. You benefit from a significantly reduced engineering overhead.
- **Networking:**
The Industrial Ethernet/PROFINET interface integrated into SIMATIC S7-1200 offers seamless communication with distributed I/O, with SIMATIC HMI Panels for visualization and additional controllers for CPU-to-CPU communication. It can also be used with devices from third parties for extended integration possibilities as well as with the TIA Portal engineering framework for configuring and programming.
- **Integrated technology:**
Integrated technology features for metering and measuring tasks, closed-loop control and motion control make the SIMATIC S7-1200 a versatile system that is perfectly suited for numerous automation tasks.
- **Security Integrated:**
Protection from unauthorized code or process value changes means higher availability during operation. Know-how protection, copy protection and access protection prevent unauthorized third parties from opening and duplicating blocks and keep your algorithms and processes safe. The security features are integrated in the S7-1200 and the TIA Portal.
- **Diagnostics:**
SIMATIC S7-1200 offers a diagnostic functionality that is already integrated in the system, without the need for any further programming. A standardized display concept enables error messages to be identically visualized as plain text information in the TIA Portal, on the HMI and in the web server.
- **Safety Integrated:**
Safety-related applications are possible up to SIL 3 according to IEC 62061 and PL e according to ISO 13849 with fail-safe S7-1200 CPUs. The integrated PROFSafe functionality enables connection of additional fail-safe devices, such as frequency converters. The S7-1200 fail-safe CPUs can be used for standard and fail-safe applications in machine and plant automation.



For more information, refer to:

www.siemens.com/s7-1200

SIMATIC S7-1200	CPU 1211C	CPU 1212C	CPU 1214C	CPU 1215C	CPU 1217C	CPU 1212FC	CPU 1214FC	CPU 1215FC
CPU type	DC/DC/DC, DC/DC/RLY, AC/DC/RLY				DC/DC/DC	DC/DC/DC, DC/DC/RLY		
Ethernet interfaces	1	1	1	2	2	1	1	2
RAM	50 KB	75 KB	100 KB	125 KB	150 KB	100 KB	125 KB	150 KB
Integrated digital I/O	6/4	8/6	14/10	14/10	14 ¹⁾ /10	6/4	8/6	14/10
Integrated analog I/O	2/0	2/0	2/0	2/2	2/2	2/0	2/0	2/0
Number of signal modules	–	2	8	8	8	2	2	8
Number of communication modules	3	3	3	3	3	3	3	3
Width	90 mm	90 mm	110 mm	130 mm	150 mm	90 mm	90 mm	110 mm
Ambient conditions	-20 °C ...+60 °C (horizontal installation)							

¹⁾ In addition, the CPU 1217 has a line driver IO in order to control stepper motor positioners up to a frequency of 1 MHz.

Overview**SIMATIC S7-1500:
Maximum productivity and efficiency**

Thanks to a large variety of innovative features, the SIMATIC S7-1500 Advanced Controllers set new standards for the highest level of productivity and can be used extremely flexibly in machine building and automation of entire production plants. They are suitable as compact or distributed controllers in series machine building as well as central controllers in the control cabinet for medium and high-end machines, and they meet the high requirements regarding performance, communication, flexibility and technological function.

- **Maximum performance:**
For maximum productivity and product quality in your production process, SIMATIC S7-1500 supports you with the fast backplane bus with PROFINET performance and the shortest response times as well as a command processing time in the CPU as little as 1 ns. The PROFINET connection with deterministic time response ensures reproducibility and precision in the μ s range.
- **Integrated system diagnostics:**
The SIMATIC S7-1500 CPU offers a diagnostic function that is already integrated in the system and can be used without the need for any programming. Thanks to this system diagnostics function integrated in the firmware, faults are detected independent of the program and error messages are uniformly displayed as plain text information in TIA Portal engineering, in the web server, on the CPU display as well as on the connected HMI. With the real-time trace function, you can record up to 1 000 sporadic events, precisely diagnose them and ultimately optimize your automation.
- **Functional design and very easy handling:**
Very easy handling and the highest degree of user-friendliness in many interesting details are convincing properties of the SIMATIC S7-1500. This is demonstrated, for example, in the design of a SIMATIC S7-1500 station and in the easy wiring with channel-granular signaling. Without having to rely on engineering, the CPU display supports diagnostics and commissioning through functions such as station and module status, event display, tag status checking and IP address assignment.
- **Security Integrated:**
A security concept with authorization levels, authentication, copy and block protection is installed in the SIMATIC S7-1500; it helps you protect your know-how and maintain communication integrity. This concept protects your investment and helps you achieve greater plant availability.
- **Safety Integrated:**
SIMATIC S7-1500 controllers enable the highest degree of integration: one controller, one communication system and one engineering design for both standard and fail-safe automation. The multi-channel, fail-safe IO modules can be addressed directly during engineering. Any standard CPU is also available as fail-safe CPU.
- **Engineering in the TIA Portal:**
TIA Portal is the innovative engineering framework for all automation tasks, with data transfer from the product design, automatic project generation for the SIMATIC S7-1500 and HMI Panels and data transparency during operation to optimize productivity.
- **Scalable CPU types:**
Various CPU versions are available in several performance classes: standard and fail-safe CPUs, compact CPUs with integrated inputs and outputs as well as technology functions, technology CPUs with extended motion control functions and the ODK CPU with C/C++ block call from the control program.



For more information, refer to:

www.siemens.com/s7-1500

Introduction

SIMATIC Advanced Controllers

SIMATIC S7-1500

1

Overview (continued)

Standard CPUs	CPU 1511	CPU 1513	CPU 1515	CPU 1516	CPU 1517	CPU 1518	CPU 1518 ODK
C/C++ blocks	–	–	–	–	–	–	available
DP/PN interfaces/PN ports	0/1/2		0/2/3	1/2/3		1/3/4	
Program memory/data	150 KB/ 1 MB	300 KB/ 1.5 MB	500 KB/ 3 MB	1 MB/ 5 MB	2 MB/ 8 MB	4 MB/ 20 MB	4 MB/ 20 MB + 20 MB
Bit performance	60 ns	40 ns	30 ns	10 ns	2 ns	1 ns	
Maximum number of connections	96	128	192	156	320	384	
Positioning axes Typical (4 ms)/max.	5/10		7/30		70/128	128/128	
Width	35 mm		70 mm		175 mm		

Compact CPUs	CPU 1511C	CPU 1512C
DP/PN interfaces/PN ports	0/1/2	
Program memory/data	175 KB/ 1 MB	250 KB/ 1 MB
Bit performance	60 ns	40 ns
Inputs/outputs	16 DI/16 DO/5 AI/2 AO	32 DI/32DO/5 AI/2 AO
Maximum number of connections	96	128
Positioning axes Typical (4 ms)/max.	5/10	
Width	35 mm	

Fail-safe CPUs	CPU 1511F	CPU 1513F	CPU 1515F	CPU 1516F	CPU 1517F	CPU 1518F	CPU 1518F ODK
C/C++ blocks	–	–	–	–	–	–	available
DP/PN interfaces/PN ports	0/1/2		0/2/3	1/2/3		1/3/4	
Program memory/data	225 KB/ 1 MB	450 KB/ 1.5 MB	750 KB/ 3 MB	1.5 MB/ 5 MB	3 MB/ 8 MB	6 MB/ 20 MB	6 MB/ 20 MB + 20 MB
Bit performance	60 ns	40 ns	30 ns	10 ns	2 ns	1 ns	
Maximum number of connections	96	128	192	156	320	384	
Positioning axes Typical (4 ms)/max.	5/10		7/30		70/128	128/128	
Width	35 mm		70 mm		175 mm		

Overview (continued)**SIMATIC Technology CPUs**

In addition to standard and safety applications, the technology CPUs of the SIMATIC S7-1500 Advanced Controllers combine an expanded range of motion control functions in one controller in the familiar TIA Portal environment.

The benefits of the technology CPUs at a glance:

- Standard, safety and motion control functions in one CPU
- Extended motion control tasks such as gearing or camming
- A high degree of engineering efficiency due to graphic and tabular configuration and optimization of cams
- Adaption and calculation of cams in the user program during operation (e.g. when there is a product change)

The connection via PROFINET also allows easy, integrated diagnostics and detailed error detection, which allows machine downtimes to be kept to a minimum.

Integrated solution

In interaction with SINAMICS servo drive systems (e.g. SINAMICS S110, S120, V90), which are easily integrated via PROFINET, different and multi-faceted motion control tasks can thus be efficiently implemented in the SIMATIC environment with TIA Portal.

www.siemens.com/sinamics

The engineering of SIMATIC and SINAMICS is carried out in the Totally Integrated Automation Portal (TIA Portal). This engineering framework allows the parameterization of technology functions with technology objects. These objects allow a simple view of the Motion Control functions and can be configured and parameterized via user-friendly input masks. This not only simplifies the work of a machine builders, but also the work of their customers, who do not have to acquire specialist knowledge to maintain or re-configure their machines. Instead, they can use their already available PLC know-how.



Technology objects are already integrated for the following basic functions:

- Speed
- Positioning
- Measuring input
- Synchronous operation
- Cam disk
- Cam, cam track
- Flying shears
- Gripper feed
- Pressure mark correction
- Ejector

SIMATIC Technology CPUs are available with different configuration options and can address a maximum of 128 axes.

For more information, refer to:

www.siemens.com/t-cpu

Technology CPUs	CPU 1511T	CPU 1515T	CPU 1517T/TF
DP/PN interfaces/PN ports	0/1/2	0/2/3	1/2/3
Program memory/data	225 KB/ 1 MB	750 KB/ 3 MB	3 MB/ 8 MB
Bit performance	60 ns	30 ns	2 ns
Maximum number of connections	96	192	320
Positioning axes Typical (4 ms)/max.	5/10	7/30	128/128
Width	35 mm	70 mm	175 mm

Introduction

SIMATIC Distributed Controllers

Distributed Controllers – the central modules of the ET 200

1

Overview

The SIMATIC ET 200 CPU Distributed Controllers combine a compact design with versatility. Especially in the mid performance range for machines with distributed intelligence or series machines offering little space, the Distributed Controllers are the perfect solution for standard and fail-safe applications.

Regarding Distributed Controllers, not only the SIMATIC ET 200SP CPUs and the new SIMATIC ET 200SP open controller, but also the tried and tested controllers for SIMATIC ET 200S and ET 200pro systems are available.

Thanks to their compact design, Distributed Controllers are suitable for series machine construction. They can be mounted directly on the machine in small control boxes. In networked plants they are connected to the central control cabinet of a production line via PROFINET.

The relocation of the intelligence from the central control cabinet to Distributed Controllers at the individual stations has a positive effect on the availability of a plant. If a fault should occur at one station, this can be cleared without bringing the entire plant to a standstill.

SIMATIC ET 200SP – the new generation of distributed I/O



Interface modules with integrated CPU and PROFINET connections are available for SIMATIC ET 200SP. The functionality of the CPUs corresponds to that of the S7-1500. Various connection technologies can be implemented with the three integrated Ethernet ports. Thanks to the I-device functionality, the connection to a higher-level CPU can be made in just the same way as with a standard interface module. The CPUs support additional functions such as PROFlenergy, isochronous mode, configuration control (option handling) and DP master.

Standard CPUs:



- CPU 1510SP-1PN
- CPU 1512SP-1PN

The fail-safe ET 200SP CPUs allow the processing of standard and safety programs. They are certified in accordance with EN 61508 (2nd edition) for functional safety and are suitable for use in safety-relevant applications up to SIL 3 according to IEC 62061 and PL e according to ISO 13849.

Fail-safe CPUs:



- CPU 1510SP F-1 PN
- CPU 1512SP F-1 PN

Overview (continued)

SIMATIC ET 200SP Open Controller



The ET 200SP Open Controller combines the functions of a PC-based Software Controller with visualization, Windows applications and central I/Os (inputs/outputs) in a single compact device.

The functionality of the ET 200SP Open Controller corresponds to that of the S7-1500. It can be flexibly expanded with standard ET 200SP modules and optimized for machines with distributed architecture.

Highlights:

- "All-in-one"
 - Control with central I/Os
 - Visualization and Windows applications
 - PC interfaces for monitor, mouse and keyboard
 - Gigabit Ethernet
- High system availability
 - Software Controllers independent of Windows
 - Windows can be restarted while controller is running
- Compact and modular
 - Small footprint
 - Extensive range of I/O modules
 - Single-row expansion with up to 64 modules
- Ruggedness
 - Continuous operation at up to 60° C ambient temperature without loss of performance
 - Easy to maintain thanks to fanless design
 - High EMC
 - Resistant to vibration and shock loads
- User-friendly design
 - Externally accessible bulk memory, protected against unauthorized access
 - Integral Run/Stop switch for the controller
 - Additional memory capacity through SD card
 - PROFINET on board: replaceable BusAdapter for flexible connection
- Efficient engineering in the TIA Portal
 - No Windows settings necessary for the Software Controller
 - Reusability of S7 programs on other hardware platforms

SIMATIC ET 200SP Open Controller with Safety Integrated

The SIMATIC ET 200SP Open Controller with fail-safe is a PC-based controller with the design of the ET 200SP I/O system. The pre-installed SIMATIC S7-1500 Software Controller is used for control purposes, here in its fail-safe version with Safety Integrated. The integrated safety function makes the system especially compact and therefore saves space in the control cabinet. The additional safety controller that would otherwise be necessary is not required. Its compact design and modular expandability make it particularly well suited for series machine building.

SIMATIC ET 200pro CPU



The SIMATIC ET 200pro is a particularly small, very rugged and high-performance I/O system with IP65/67 degree of protection. Interface modules are available in both standard and fail-safe versions offering CPU functionality for connection to PROFINET. A comprehensive range of modules rounds off the offering.

The devices are ideal for use in harsh industrial environments, directly at the machine.

The time-saving installation enables highly flexible implementation of automation solutions.

The CPU supports both PROFINET IO (up to 128 IO devices can be connected) and PROFINET CBA, as well as PROFIBUS DP (as master for up to 124 slaves). The open Ethernet communication (TCP/IP, UDP, ISO-on-TCP) permits reliable and high-speed data exchange. The systems can be used at ambient temperatures of -25 to +55 °C and a relative humidity of 5 to 100 %. The SIMATIC ET 200pro Distributed Controllers have been upgraded with new CPUs with the latest SIMATIC S7-1500 technology for standard and fail-safe automation tasks.

For more information, refer to:

www.siemens.com/distributed-controller

Introduction

SIMATIC Software Controllers

SIMATIC S7-1500 Software Controller

1

Overview

SIMATIC S7-1500 Software Controller

PC-based automation is combined with the highest degree of system availability in the SIMATIC S7-1500 Software Controller: The Software Controller runs completely independent of the Windows system, which means it also continues to run during restart or even when Windows fails.

- Flexible control for special-purpose machines with high performance and function requirements:
 - Integrated system functions similar to the SIMATIC S7-1500 Advanced Controllers
 - Integration of user-specific functions via open interfaces (e.g. C/C++/MATLAB)
 - Flexible connection to any interfaces (e.g. IT) and fieldbus systems
- Use with industrial SIMATIC IPCs:
 - Free scalability across the entire IPC range
- Industry and customer-specific requirements are fulfilled:
 - Integration of PC software, for example for image processing
 - All on a single device, easier communication
 - High computing power and integration of complex algorithms into the control program
 - Integration of model-based software development (e.g. MATLAB/Simulink)
- Increased system availability:
 - Fast start-up of controller
 - Reboot of Windows during operation (e.g. updates)
 - The controller continues to run, even if Windows fails
- Engineering efficiency:
 - Complete engineering in the TIA Portal: No Windows settings required on controller
 - Simple integration of high-level languages into the user program
 - Easy implementation from interfaces to PC applications with ODK 1500S
 - Direct integration of Simulink models into the user program with Target 1500S
 - Full compatibility with SIMATIC S7-1500
- Security Integrated:
 - Know-how protection for machine manufacturer
 - Access protection for the end customer

SIMATIC S7-1500 Software Controller with Safety Integrated

The integrated safety functionality offers additional benefits in the form of savings in space and costs, because no additional safety controller is required. This has noticeable advantages in terms of engineering efficiency, safety and user-friendliness.

SIMATIC S7-1500 Software Controller ODK

SIMATIC ODK 1500S supports the development of Windows and real-time library functions for the SIMATIC S7-1500 Software Controller and enables integration of high-level language code, C++.



Application

Windows library applications:

- Interfacing to databases
- Communication with Windows programs, such as Office applications
- Connection to application-specific visualization software
- Implementation of industry-specific protocol converters such as PV02, IEC 61850, etc.
- Access to the Windows file system, e.g. with specific file formats

Real-time library applications:

- Integration of existing C/C++ algorithms into the control task
- Implementation of closed-loop controllers or algorithms

Function

SIMATIC ODK 1500S combines PLC programming with programming in complex higher-level languages, such as C++, in the simplest possible way.

- Integration of higher-level languages
- Simple integration of Windows applications, e.g. Enterprise software, databases
- Recording of production data
- Integration of PC applications
- Implementation of complex algorithms for real-time applications
- Know-how protection
- Re-use of existing programming codes and recipes

The scope of delivery includes:

- Eclipse
- Templates for Visual Studio

For more information, refer to:

www.siemens.com/software-controller

Overview***SIMATIC Field PG M5: The only industrial notebook with all programming interfaces onboard***

The SIMATIC Field PG has proved its worth for use in harsh industrial environments – not least because of the rugged enclosure in an attractive industrial design. Powerful processors and fast work memory offer high performance even for the most demanding engineering tasks with the pre-installed TIA Portal. Users also benefit from wireless technology, the high-luminance display, and a host of well-conceived details. No wish is left unfulfilled for use in the normal office environment, too.

The latest high-performance programming device notebook design

For mobile applications in industrial plants, the SIMATIC Field PG M5 offers both rugged hardware and pre-installed TIA Portal engineering software for fast and efficient configuring, commissioning, service and maintenance.

The Field PG also offers all the interfaces required for these tasks: For connecting to the automation process, the SIMATIC Field PG is equipped both with a PROFIBUS interface and two high-speed PROFINET interfaces. SIMATIC Memory Cards can be directly programmed via corresponding slots.

The SIMATIC Field PG is so rugged that it withstands not only impacts and vibrations but also electromagnetic radiation from machines in an industrial environment.

The SIMATIC Field PG is available in two versions that are perfectly optimized for engineering with the TIA Portal: Comfort and Advanced

Area of application

The industrial design predestines the SIMATIC Field PG for use in harsh industrial environments. Everything is possible: from engineering of the plant in an office environment and testing at the machine level, all the way to service and maintenance in the factory.

- Increased protection from electromagnetic influences for applications in an industrial environment through complete shielding (EMC/EMS tested)
- A rugged, light, magnesium enclosure and rubber-buffered corners provide protection against shocks and vibrations
- Dirt-resistant industrial design with dark colors and keyboard with abrasion-resistant laser inscription
- Lightweight, space-saving power supply and a stable handle enable easy transport when the location of use changes
- Option for connecting external monitors over DVI-I or DisplayPort as well as a USB docking station for normal office environments

Benefits

- High-end PC hardware for demanding applications in the automation environment
- Ready for immediate use and perfect TIA Portal engineering support through pre-installed, system-tested programming software
- The high-resolution display reduces eye strain and supports ergonomic working
- Complete package comprising hardware and software with an attractive price-performance ratio
- High availability thanks to top quality 'Made in Germany', exclusive development and production in Karlsruhe

***Prepared ready-to-run***

- With pre-installed TIA Portal engineering software and previous version, optional STEP 5 with S5 HW support
- Can be ordered with the following types of license: Trial, TIA Portal, or Combo (TIA Portal and previous version)
- With 64-bit Windows operating system from Microsoft
- Trusted Platform Module TPM 2.0 for increased data security
- Remote administration through Intel Active Management Technology (iAMT) and Wake on LAN (WoL)

Available interfaces

- 3 x USB 3.0 type A interfaces, one of which has a 1.5 A charging function when the device is powered off
- 1 USB 3.0 type C port
- Bluetooth and WLAN (based on the WLAN standard 802.11ac)
- 2 x Gigabit Ethernet, 1 x PROFIBUS DP/MPI
- Slots for SIMATIC Memory Cards
- Optional: S5 online functionality (TTY) and S5 EPROM adapter

High-performance hardware components

- Intel® Core™ i5/i7 processor for maximum performance (optimal for TIA Portal Engineering)
- Work memory with up to 32 GB DDR4 SDRAM (2400 MHz)
- Lithium ion battery with 8850 mAh
- 15.6"/39.6 cm widescreen full HD display in 16:9 format
- Integrated Intel HD530 graphic supports the current 4k resolution, 4096 x 2304 pixels are possible via the display port to give a screen working area that is over 400 percent larger than one with full HD
- Easily replaceable hard disk (1 TB HDD) or solid-state drive (512 GB or 1 TB SSD)

For more information, refer to:

www.siemens.com/simatic-pg

Introduction

SIMATIC Industrial PCs

1

Overview



SIMATIC IPC family

SIMATIC Industrial PCs

Our reliable and innovative Industrial PCs are the optimal PC hardware platform for PC-based Automation from Siemens.

Rack PC

Rack PCs are flexible, high-availability Industrial PC systems for powerful yet compact applications using 19" technology.

Box PC

SIMATIC Box PCs provide mechanical engineers, plant engineers and control cabinet makers with particularly rugged Industrial PC systems for use in powerful yet compact applications.

Panel PC

SIMATIC Panel PCs are suitable, thanks to their high industrial compatibility, for use in control cabinets, consoles and control panels, as well as directly at the machine. Typical areas of application can be found in both factory and process automation.

Tablet PC

The SIMATIC Tablet PC brings the performance of Industrial PCs to the tablet format. It is suitable for mobile computing in production, in the office, for service calls, for measuring and testing as well as operator control and monitoring.

Industrial monitors and thin clients

Flexible operator input concepts can be implemented via Flat Panel monitors or thin clients. These are industry-standard LCD monitors with high-contrast displays that can be located up to 30 m away from the PC, or low-cost, rugged thin clients that offer HMI functionality over the network in larger plants spread over wide areas.

Ruggedness and industrial compatibility for 24-hour continuous use in an industrial environment

- Compact, space-saving enclosure (Box PC and Panel PC)
- Suitable for installing in space-saving control cabinets, only 500 mm deep (Rack PC)
- All-metal enclosure with a high degree of electromagnetic compatibility for use in industrial areas and in domestic, business and commercial environments and for degrees of protection up to IP65/NEMA 4
- The mounting position of the devices can be varied by means of wall, portrait or control cabinet mounting (Box PC), rail mounting (SIMATIC IPC427D or IPC227D only) and horizontal or vertical mounting position in the 19" cabinet or with the appropriate kit as an industrial tower PC (Rack PC)
- High resistance to shock/vibration thanks to special hard disk mountings, locked connectors, and card retainers
- Maintenance-free due to design without hard disk or fans using SIMATIC CFast Memory Cards or solid-state drive (SIMATIC IPC427D/IPC477D and SIMATIC IPC227D/IPC277D)
- Service-friendly, modular device design for replacement of defective components
- Integral industrial power supplies (according to NAMUR) for safe power supplies protected against system disturbances
- Attractive product design with dirt-repelling fronts and coated surfaces
- Dust protection thanks to a pressurized cooling concept, front-mounted fans and dust filters (Rack PC)

For more information, refer to:

www.siemens.com/simatic-ipc

Overview**Efficient engineering for all SIMATIC Controllers**

SIMATIC Software is a core component of Totally Integrated Automation and provides the optimum tool for every automation task and every phase of a project. SIMATIC Software enables the potential in the engineering workflow to be fully exploited.

- Fewer interfaces thanks to integrated engineering environment for logic, HMI and motion control.
- Design and implementation times are shortened by structured, process-oriented programming methodology.
- The costs of subsequent projects are reduced because blocks are easy to reuse.
- Efficient process error diagnostics increase plant availability.

Totally Integrated Automation Portal (TIA Portal)

The engineering framework – Totally Integrated Automation Portal (TIA Portal) – is the basis for all engineering systems for configuring, programming and commissioning programmable controllers. As an integral component of the various engineering systems

- SIMATIC STEP 7 for S7 controllers (PLC)
- SIMATIC WinCC for machine-level operation (HMI)
- SIMATIC Startdrive for SINAMICS drives
- SCOUT for the SIMOTION Motion Control Systems

the engineering framework automatically ensures standardized and consistent system behavior by providing shared services and properties.

Engineering systems for SIMATIC Controllers – based on TIA Portal

- STEP 7 Basic V14 (incl. WinCC Basic), shared engineering for SIMATIC S7-1200 and SIMATIC HMI Basic Panels.
- STEP 7 Professional V14 (incl. WinCC Basic), the easy-to-use, uniform engineering system for all SIMATIC Controllers and SIMATIC HMI Panels.

Highlights:

- Powerful language innovations: Efficient program editors, integrated symbolic programming
- User-friendly online functionalities: Hardware detection, software upload, module expansion during operation, simulation (PLCSim) for S7-1500 and S7-1200, Download in RUN, Undo
- Integrated system diagnosis as a firmware function: Uniform display concept for STEP 7, CPU display, web server and HMI without any configuration overhead, up to 4 real-time traces
- Integrated technology: Technology objects for motion sequences (rotational speed and relative synchronous operation) and PID control functions with self-optimization
- Multi-level security concept: Integrated protection functions for project and plant protection:
 - Know-how protection for program blocks,
 - Copy protection for the program through coupling with hardware,
 - 4-level protection against unauthorized access to CPU, HMI, communication,
 - Manipulation protection by means of lead seals.

**New for TIA Portal V14:**

- Virtual commissioning: PLCSim Advanced with interfaces to simulation software, such as Plant Simulation and Process Simulate, shortens the time-to-market.
- Cloud interfaces: Cloud-based engineering offers the highest degree of flexibility: With the new TIA Portal Cloud Connector, users can access the plant controller from their private cloud. No installation on the engineering workstation is required.
- Engineering interface: The TIA Portal interacts with other systems through open interfaces. The Teamcenter gateway is a new interface for product data management in Teamcenter, the data collaboration platform for design, planning and engineering.
- Energy management: The SIMATIC Energy Suite facilitates easy parameter assignment and evaluation of numerous measuring components. The required control program is generated automatically. To increase transparency for energy savings according to ISO 50001, energy data is easily collected and integrated into the automation solution.
- Multiuser functionality: The multiuser function provides several operatives with efficient and simultaneous access to a server project, based on automatic synchronization.

For more information, refer to:

www.siemens.com/simatic-software

Introduction

SIMATIC I/O systems

1

Overview

The right solution for every application

With SIMATIC ET 200 a wide range of distributed I/O systems is available – for solutions in the control cabinet or without a control cabinet directly at the machine, as well as for applications in hazardous areas. SIMATIC ET 200 systems for cabinet-free configurations are installed in a rugged, fiber-glass-reinforced plastic enclosure, making them resistant to shock and dirt, as well as watertight. Furthermore, you need fewer additional components, save on cabling, and profit from extremely fast response times.

The modular design makes it possible to scale and expand the ET 200 systems simply and in small stages. Already integrated additional modules reduce costs and at the same time offer a widely diverse range of possible applications. You can choose from a wide range of possible combinations: digital and analog inputs/outputs, intelligent modules with CPU functionality, safety engineering, motor starters, pneumatic systems, frequency converters, and diverse technology modules.

Communication over PROFINET and PROFIBUS, uniform engineering, transparent diagnostics options as well as optimum interfacing to SIMATIC Controllers and HMI devices prove the unique integration of Totally Integrated Automation.

In addition to the fieldbus systems, the point-to-point connection I/O-Link is also available for intelligent connection of sensors and actuators.

For more information, refer to:

www.siemens.com/et200

In a control cabinet (IP20)

ET 200SP

A new generation of scalable I/O



ET 200MP

Multi-channel and multifunctional S7-1500 I/O system



ET 200M

Modular design with S7-300 modules



ET 200iSP

Intrinsically safe version for hazardous area

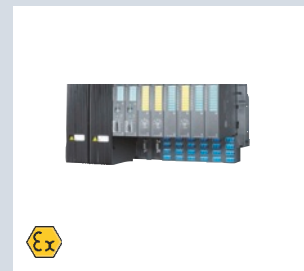

Without control cabinet (IP65/67)

ET 200AL

Digital and analog I/O is extremely easy to install

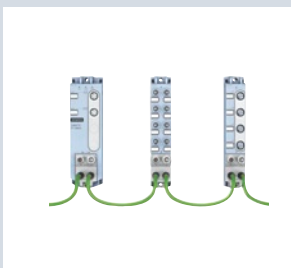

ET 200pro

Modular design and multifunctional

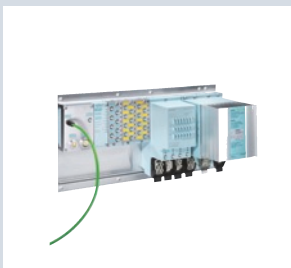

ET 200eco PN

Low-cost, space-saving block I/O



Overview

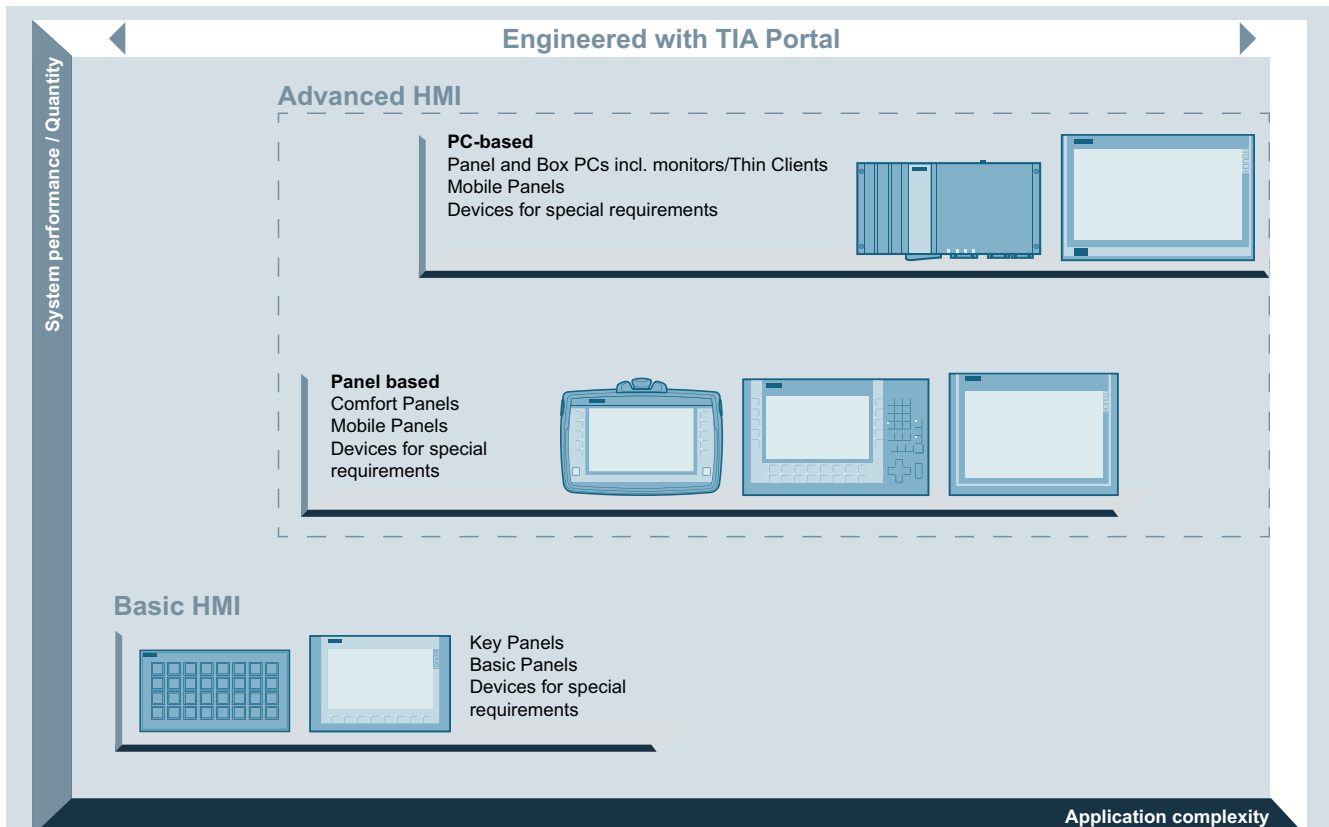

SIMATIC Panels Overview

**SIMATIC HMI Panels –
HMI devices for efficient machine-level interaction**

A complete range of powerful and innovative HMI devices is available for implementing efficient, machine-level HMI solutions in the most diverse applications and industries. One unique and highly efficient feature is the integrated configuring via SIMATIC WinCC in the TIA Portal, with which users can achieve significant savings with regard to engineering time, costs and effort.

<http://www.siemens.com/hmi-panels>

Basic HMI

- **Panel-based:**
HMI devices with excellent price-performance ratio for simple visualization tasks.
<http://www.siemens.com/basic-hmi>

Advanced HMI

- **Panel-based:**
Powerful HMI devices for demanding visualization tasks with a high level of convenience.
<http://www.siemens.com/advanced-hmi-panel>
- **PC-based:**
High-performance HMI devices for data-intensive and complex visualization tasks.
<http://www.siemens.com/advanced-hmi-pc>

Rugged and compact for use at machine level

With IP66/NEMA 4 degree of protection at the front, high EMC and extreme vibration resistance, the SIMATIC HMI Operator Panels are ideally suited for use at machine level in harsh industrial environments. Thanks to their compact design with a shallow mounting depth, the stationary HMI devices can be fitted anywhere, even where only restricted space is available. For distributed configurations, there are also devices available with all-round IP65/NEMA 4 protection.

The extremely rugged and shock-proof enclosure with IP65 degree of protection makes the Mobile Panels especially suitable for industrial applications. Their low weight and ergonomic design means that they are user-friendly and easy to operate.

One configuration software for everything

SIMATIC WinCC (TIA Portal) is a tool for the uniform configuration of all SIMATIC HMI Panels as well as PC-based systems. Graded variants are available for every task. The software permits simple and efficient configuration. Programming experience is not required.

Once created, configurations can be reused within the family. Key Panels only need to be configured, not programmed.

Introduction

SIMATIC Operator Panels

1

Overview (continued)

Component of Totally Integrated Automation

Siemens provides the complete modular system of matched components for automation solutions from one source and — with Totally Integrated Automation — one of the most globally successful automation concepts. SIMATIC WinCC (TIA Portal) is an integral component of this world. It offers crucial advantages. Thanks to the triple uniformity in configuration/programming, data management and communication, automation solution engineering costs are significantly reduced.

Open for a wide variety of automation systems

Despite being consistently incorporated into the SIMATIC world, the panels are nevertheless open for connection to PLCs from many different vendors. The standard delivery includes a comprehensive range of user-friendly drivers.

Innovative operator control and monitoring

The SIMATIC HMI Panels facilitate innovative operator control and monitoring combined with ruggedness, stability and simplicity. On the Comfort Panels in particular, standard hardware and software interfaces, e.g. the Multimedia Card/SD Card, USB, Ethernet, PROFINET, PROFIBUS DP and Visual Basic scripts, provide greater flexibility and openness as well as access to the office world.

Worldwide application

The SIMATIC HMI Panels are ideally equipped for global use. Online language switching permits selection of up to 32 languages during operation simply by pressing a button. The wide variety of languages available also includes, for example, Asian logographic languages (Chinese, Taiwanese, Korean, Japanese) and Russian. The configuration interface of WinCC (TIA Portal) including the online help and the complete documentation is also multilingual. Up to 32 languages can be used in one project. And all this is complemented by global service and support from Siemens.



LOGO! logic modules



2/2	Introduction
2/2	LOGO! logic modules
2/3	LOGO! modular
2/3	LOGO! modular basic variants
2/6	LOGO! modular pure variants
2/9	LOGO! modular expansion modules
2/15	SIPLUS LOGO! modular basic variants
2/19	SIPLUS LOGO! modular pure variants
2/22	SIPLUS LOGO! modular expansion modules
2/27	LOGO! modular communication modules
2/27	LOGO! modular communication modules
2/28	LOGO! CMK2000 communication modules
2/29	LOGO! CSM unmanaged
2/31	LOGO! CMR (wireless communication)
2/36	LOGO!Power
2/36	Introduction
2/37	1-phase, 5 V DC
2/40	1-phase, 12 V DC
2/44	1-phase, 15 V DC
2/47	1-phase, 24 V DC
2/51	SIPLUS LOGO!Power
2/52	LOGO!Contact
2/53	LOGO! Software
2/54	SIPLUS Add-Ons
2/54	LOGO! mounting kits

Brochures

For brochures serving as selection guides for SIMATIC products, refer to:

www.siemens.com/simatic/printmaterial

LOGO! logic modules

Introduction

LOGO! logic module

Overview



LOGO! logic module:

- The compact, easy-to-use and low-cost solution for simple control tasks
- Compact, easy to operate, universally applicable without accessories
- "All in one": Integrated display and operator panel
- 36 different functions can be connected at the press of a button or by means of PC software; up to 130 times over
- LOGO! 8: 38/43 different functions can be linked at the press of a button or using PC software; up to 200/400 times
- Functions are easily changed at the press of a button. No more time-consuming rewiring

SIPLUS LOGO!:

- The controller for use in the toughest environmental conditions
- With extended temperature range from -40/-25 °C to +70 °C
- Suitable for exposure to media (harmful gas atmosphere)
- Condensation permissible
- With the proven PLC technology of LOGO!
- Easy to handle, program, maintain, and service
- Ideal for use in automotive engineering, environmental engineering, mining, chemical plants, material handling, food industry, etc.

Accessories:

- The front panel mounting set also allows simple and reliable installation of the logic modules in front panels; IP65 protection is thus possible.
- In order to ensure dependable operation of SIPLUS devices supplied by the battery in conjunction with combustion engines, it is necessary to put in a SIPLUS upmiter upstream device between the battery and the SIPLUS LOGO!.

For more information, please go to:

<http://www.siemens.com/siplus-extreme>

General technical data of the SIPLUS LOGO!

Ambient temperature range	-40/-25 ... +70 °C
Conformal coating	Coating of the printed circuit boards and the electronic components
Technical data	The technical data of the standard product applies except for the ambient conditions.

Ambient conditions

Extended range of environmental conditions

<ul style="list-style-type: none"> • with reference to ambient temperature, air pressure and altitude 	Tmin ... Tmax at 1080 hPa ... 795 hPa (-1000 m ... +2000 m) // Tmin ... (Tmax - 10K) at 795 hPa ... 658 hPa (+2000 m ... +3500 m) // Tmin ... (Tmax - 20K) at 658 hPa ... 540 hPa (+3500 m ... +5000 m) 0° C
<ul style="list-style-type: none"> • At cold restart, min. 	
Relative humidity <ul style="list-style-type: none"> • with condensation, max. 	100 %; RH incl. bedewing/frost (no commissioning in bedewed state)
Resistance <ul style="list-style-type: none"> • to biologically active substances/ compliance with EN 60721-3-3 • to chemically active substances/ compliance with EN 60721-3-3 • to mechanically active substances, compliance with EN 60721-3-3 	Yes; Class 3B2 mold and fungal spores (except fauna); the supplied plug covers must remain in place on the unused interfaces during operation. Yes; Class 3C4 (RH < 75%) incl. salt spray in accordance with EN 60068-2-52 (severity 3); the supplied plug covers must remain in place on the unused interfaces during operation. Yes; Class 3S4 incl. sand, dust; the supplied plug covers must remain in place on unused interfaces during operation.

Overview



- The space-saving basic variants
- Interface for the connection of expansion modules, up to 24 digital inputs, 20 digital outputs, 8 analog inputs and 8 analog outputs can be addressed
- All basic units with integrated web server
- Enclosure width 72 mm (4 U)
- All basic units with Ethernet interface for communication with LOGO! 8, LOGO! TDE, SIMATIC Controllers, SIMATIC Panels and PCs
- Use of standard micro CF cards

2

Technical specifications

Article number	6ED1052-1CC01-0BA8	6ED1052-1MD00-0BA8	6ED1052-1HB00-0BA8	6ED1052-1FB00-0BA8
	LOGO! 24CE, 8DI(4AI)/4DO, 400 BLOCKS	LOGO!12/24RCE, 8DI(4AI)/4DO, 400 BLOCKS	LOGO! 24RCE, 8DI/4DO, 400 BLOCKS	LOGO!230RCE, 8DI/4DO, 400 BLOCKS
Display				
with display	Yes	Yes	Yes	Yes
Installation type/mounting				
Mounting	on 35 mm DIN rail, 4 spacing units wide	on 35 mm DIN rail, 4 spacing units wide	on 35 mm DIN rail, 4 spacing units wide	on 35 mm DIN rail, 4 spacing units wide
Supply voltage				
Rated value (DC)				
• 12 V DC		Yes		
• 24 V DC	Yes	Yes	Yes	
• 115 V DC				Yes
• 230 V DC				Yes
permissible range, lower limit (DC)	20.4 V	10.8 V	20.4 V	100 V
permissible range, upper limit (DC)	28.8 V	28.8 V	28.8 V	253 V
Rated value (AC)				
• 24 V AC			Yes	
• 115 V AC				Yes
• 230 V AC				Yes
Time of day				
Time switching clocks				
• Number	190	190	190	8
• Power reserve	480 h	480 h	480 h	480 h
Digital inputs				
Number of digital inputs	8; Of which 4 can be used in analog mode (0 to 10 V)	8; Of which 4 can be used in analog mode (0 to 10 V)	8	8
Digital outputs				
Number of digital outputs	4; Transistor	4; Relays	4; Relays	4; Relays
Short-circuit protection	Yes; electrical (1 A)	No; external fusing necessary	No; external fusing necessary	No; external fusing necessary
Output current				
• for signal "1" permissible range for 0 to 55 °C, max.	0.3 A	10 A		
Relay outputs				
Switching capacity of contacts				
- with inductive load, max.		3 A	3 A	3 A
- with resistive load, max.		10 A	10 A	10 A

LOGO! logic modules

LOGO! modular

LOGO! modular basic variants

Technical specifications (continued)

Article number	6ED1052-1CC01-0BA8	6ED1052-1MD00-0BA8	6ED1052-1HB00-0BA8	6ED1052-1FB00-0BA8
	LOGO! 24CE, 8DI(4AI)/4DO, 400 BLOCKS	LOGO!12/24RCE, 8DI(4AI)/4DO, 400 BLOCKS	LOGO! 24RCE, 8DI/4DO, 400 BLOCKS	LOGO!230RCE, 8DI/4DO, 400 BLOCKS
EMC				
Emission of radio interference acc. to EN 55 011				
• Limit class B, for use in residential areas	Yes; Radio interference suppression according to EN55011, Limit Value Class B	Yes	Yes	Yes
Degree and class of protection				
Degree of protection acc. to EN 60529				
• IP20	Yes	Yes	Yes	Yes
Standards, approvals, certificates				
CE mark	Yes	Yes	Yes	Yes
CSA approval	Yes	Yes	Yes	Yes
UL approval	Yes	Yes	Yes	Yes
FM approval	Yes	Yes	Yes	Yes
developed in accordance with IEC 61131	Yes	Yes	Yes	Yes
according to VDE 0631	Yes	Yes	Yes	Yes
Marine approval				
• Marine approval	Yes	Yes	Yes	Yes
Ambient conditions				
Ambient temperature during operation				
• min.	0 °C	0 °C	0 °C	0 °C
• max.	55 °C	55 °C	55 °C	55 °C
Dimensions				
Width	71.5 mm	71.5 mm	71.5 mm	71.5 mm
Height	90 mm	90 mm	90 mm	90 mm
Depth	60 mm	60 mm	60 mm	60 mm

Ordering data**Article No.****Article No.****LOGO! 8 logic module****LOGO! 24CE**

Supply voltage 24 V DC,
8 digital inputs 24 V DC, of which
4 can be used in analog mode
(0 to 10 V),
4 digital outputs 24 V DC, 0.3 A,
integrated time switch
Ethernet interface;
400 function blocks can be
interlinked, modular expansion
capability

6ED1052-1CC01-0BA8**LOGO! 12/24RCE**

Supply voltage 12...24 V DC,
8 digital inputs 12/24 V DC, of
which 4 can be used in analog
mode (0 to 10 V)
4 relay outputs 10 A,
integral time switch
Ethernet interface;
400 function blocks can be
interlinked, modular expansion
capability

6ED1052-1MD00-0BA8**LOGO! 24RCE**

Supply voltage 24 V AC/DC,
8 digital inputs 24 V AC/DC,
4 relay outputs 10 A,
integral time switch
Ethernet interface;
400 function blocks can be
interlinked, modular expansion
capability

6ED1052-1HB00-0BA8**LOGO! 230RCE**

Supply voltage 115...230 V AC/DC,
8 digital inputs 115...230 V AC/DC,
4 relay outputs 10 A,
integral time switch
Ethernet interface;
400 function blocks can be
interlinked, modular expansion
capability

6ED1052-1FB00-0BA8

Ordering data	Article No.		Article No.
Accessories		LOGO! 8 230V Starter Kit	6ED1057-3BA02-0AA8
LOGO! 8 text display HMI	6ED1055-4MH00-0BA1	With LOGO! 230RCE	
6-line text display, can be connected to all LOGO! 8 basic and pure variants, with 2 Ethernet interfaces; including installation accessories. Requires additional 12 V DC or 24 V AC/DC power supply		LOGO! 8 TDE Starter Kit	6ED1057-3BA10-0AA8
LOGO!Soft Comfort V8	6ED1058-0BA08-0YA1	With LOGO! 12/24RCE0, LOGO! Power 24 V, 1.3 A, LOGO! TDE	
For programming on the PC in LAD/FBD; executes on Windows 8, 7, XP, Linux and Mac OSX; on DVD		LOGO! 8 KP300 Basic Starter Kit	6AV2132-0HA00-0AA1
LOGO! 8 Starter Kits		With LOGO! 12/24RCE, LOGO! Power 24 V 1.3 A, KP300 Basic mono PN	
In TANOS Box, with LOGO! 8, LOGO! Soft Comfort V8, WinCC Basic V13, Ethernet cable,		LOGO! 8 KTP400 Basic Starter Kit	6AV2132-0KA00-0AA1
LOGO! 8 12/24 V Starter Kit	6ED1057-3BA00-0AA8	With LOGO! 12/24RCE, LOGO! Power 24 V 1.3 A, KTP400 Basic	
With LOGO! 12/24RCE, LOGO! Power 24 V 1.3 A		LOGO! 8 KTP700 Basic Starter Kit	6AV2132-3GB00-0AA1
		With LOGO! 12/24RCE, LOGO! Power 24 V 1.3 A, KTP700 Basic	
		Front panel mounting set	
		Width 4 U	6AG1057-1AA00-0AA0
		Width 4 U, with keys	6AG1057-1AA00-0AA3
		Width 8 U	6AG1057-1AA00-0AA1
		Width 8 U, with keys	6AG1057-1AA00-0AA2

LOGO! logic modules

LOGO! modular

LOGO! modular pure variants

Overview



- Basic variants optimized for costs
- Interface for the connection of expansion modules, up to 24 digital inputs, 20 digital outputs, 8 analog inputs and 8 analog outputs can be addressed
- With connection option for LOGO! TDE text display
- All basic units with integrated web server
- Enclosure width 72 mm (4 U)
- All basic units with Ethernet interface for communication with LOGO! 8, LOGO! TDE, SIMATIC Controllers, SIMATIC Panels and PCs
- Use of standard micro CF cards

Technical specifications

Article number	6ED1052-2CC01-0BA8	6ED1052-2MD00-0BA8	6ED1052-2HB00-0BA8	6ED1052-2FB00-0BA8
	LOGO! 24CEO, 8DI(4AI)/4DO, 400 BLOCKS	LOGO!12/24RCEO, 8DI(4AI)/4DO, 400 BLOCKS	LOGO! 24RCEO, 8DI/4DO, 400 BLOCKS	LOGO!230RCEO, 8DI/4DO, 400 BLOCKS
Installation type/mounting				
Mounting	on 35 mm DIN rail, 4 spacing units wide	on 35 mm DIN rail, 4 spacing units wide	on 35 mm DIN rail, 4 spacing units wide	on 35 mm DIN rail, 4 spacing units wide
Supply voltage				
Rated value (DC)		Yes		
• 12 V DC	Yes	Yes	Yes	
• 24 V DC				
• 115 V DC				Yes
• 230 V DC				Yes
permissible range, lower limit (DC)	20.4 V	10.8 V	20.4 V	100 V
permissible range, upper limit (DC)	28.8 V	28.8 V	28.8 V	253 V
Rated value (AC)				
• 24 V AC			Yes	
• 115 V AC				Yes
• 230 V AC				Yes
Time of day				
Time switching clocks				
• Number	190	190	190	8
• Power reserve	480 h	480 h	480 h	480 h
Digital inputs				
Number of digital inputs	8; Of which 4 can be used in analog mode (0 to 10 V)	8; Of which 4 can be used in analog mode (0 to 10 V)	8	8
Digital outputs				
Number of digital outputs	4; Transistor	4; Relays	4; Relays	4; Relays
Short-circuit protection	Yes; electrical (1 A)	No; external fusing necessary	No; external fusing necessary	No; external fusing necessary
Output current				
• for signal *1* permissible range for 0 to 55 °C, max.	0.3 A	10 A		
Relay outputs				
Switching capacity of contacts				
- with inductive load, max.		3 A	3 A	3 A
- with resistive load, max.		10 A	10 A	10 A

Technical specifications (continued)

Article number	6ED1052-2CC01-0BA8	6ED1052-2MD00-0BA8	6ED1052-2HB00-0BA8	6ED1052-2FB00-0BA8
	LOGO! 24CEO, 8DI(4AI)/4DO, 400 BLOCKS	LOGO!12/24RCEO, 8DI(4AI)/4DO, 400 BLOCKS	LOGO! 24RCEO, 8DI/4DO, 400 BLOCKS	LOGO!230RCEO, 8DI/4DO, 400 BLOCKS
EMC				
Emission of radio interference acc. to EN 55 011				
• Limit class B, for use in residential areas	Yes; Radio interference suppression according to EN55011, Limit Value Class B	Yes	Yes	Yes
Degree and class of protection				
Degree of protection acc. to EN 60529				
• IP20	Yes	Yes	Yes	Yes
Standards, approvals, certificates				
CE mark	Yes	Yes	Yes	Yes
CSA approval	Yes	Yes	Yes	Yes
UL approval	Yes	Yes	Yes	Yes
FM approval	Yes	Yes	Yes	Yes
developed in accordance with IEC 61131	Yes	Yes	Yes	Yes
according to VDE 0631	Yes	Yes	Yes	Yes
Marine approval				
• Marine approval	Yes	Yes	Yes	Yes
Ambient conditions				
Ambient temperature during operation				
• min.	0 °C	0 °C	0 °C	0 °C
• max.	55 °C	55 °C	55 °C	55 °C
Dimensions				
Width	71.5 mm	71.5 mm	71.5 mm	71.5 mm
Height	90 mm	90 mm	90 mm	90 mm
Depth	58 mm	58 mm	58 mm	58 mm

Ordering data

	Article No.		Article No.
LOGO! 8 logic module		LOGO! 24RCEo logic module	6ED1052-2HB00-0BA8
LOGO! 24CEo logic module	6ED1052-2CC01-0BA8	Supply voltage 24 V AC/DC, 8 digital inputs 24 V AC/DC, 4 relay outputs 10 A, integral time switch; Ethernet interface; without display or keyboard; 400 function blocks can be interlinked, modular expansion capability	
LOGO! 12/24RCEo logic module	6ED1052-2MD00-0BA8	LOGO! 230RCEo logic module	6ED1052-2FB00-0BA8
Supply voltage 12...24 V DC, 8 digital inputs 12...24 V DC, of which 4 can be used in analog mode (0 to 10 V), 4 relay outputs 10 A, integral time switch; Ethernet interface; without display or keyboard; 400 function blocks can be interlinked, modular expansion capability		Supply voltage 115...230 V AC/DC, 8 digital inputs 115...230 V AC/DC, 4 relay outputs 10 A, integral time switch; Ethernet interface; without display or keyboard; 400 function blocks can be interlinked, modular expansion capability	

LOGO! logic modules

LOGO! modular

LOGO! modular pure variants

2

Ordering data	Article No.		Article No.
Accessories		LOGO! 8 12/24 V Starter Kit	6ED1057-3BA00-0AA8
LOGO! TDE text display	6ED1055-4MH00-0BA1	With LOGO! 12/24RCE, LOGO! Power 24 V 1.3 A	
6-line text display, can be connected to all LOGO! 8 basic and pure variants, with 2 Ethernet interfaces; including installation accessories. Requires additional 12 V DC or 24 V AC/DC power supply		LOGO! 8 230V Starter Kit	6ED1057-3BA02-0AA8
		With LOGO! 230RCE	
		LOGO! 8 TDE Starter Kit	6ED1057-3BA10-0AA8
		With LOGO! 12/24RCEO, LOGO! Power 24 V, 1.3 A, LOGO! TDE	
LOGO!Soft Comfort V8	6ED1058-0BA08-0YA1	LOGO! 8 KP300 Basic Starter Kit	6AV2132-0HA00-0AA1
For programming on the PC in LAD/FBD; executes on Windows 8, 7, XP, Linux and Mac OSX; on DVD		With LOGO! 12/24RCE, LOGO! Power 24 V 1.3 A, KP300 Basic mono PN	
LOGO! 8 Starter Kits		LOGO! 8 KTP400 Basic Starter Kit	6AV2132-0KA00-0AA1
In TANOS Box, with LOGO! 8, LOGO! Soft Comfort V8, WinCC Basic V13, Ethernet cable,		With LOGO! 12/24RCE, LOGO! Power 24 V 1.3 A, KTP400 Basic	
		LOGO! 8 KTP700 Basic Starter Kit	6AV2132-3GB00-0AA1
		With LOGO! 12/24RCE, LOGO! Power 24 V 1.3 A, KTP700 Basic	

Overview

- Expansion modules for connection to LOGO! modular
- With digital inputs and outputs, analog inputs, or analog outputs

2

Technical specifications

Article number	6ED1055-1CB00-0BA2 LOGO! DM8 24 EXPANSION MODULE, 2MW, 4DI/4DQ	6ED1055-1HB00-0BA2 LOGO! DM8 24R EXPANSION MODULE, 2MW, 4DI/4DQ	6ED1055-1MB00-0BA2 LOGO! DM8 12/24R, EXPANSION MODULE, 2MW, 4DI/4DQ	6ED1055-1FB00-0BA2 LOGO! DM8 230R, EXPANSION MODULE, 2MW, 4DI/4DQ
Installation type/mounting				
Mounting	on 35 mm DIN rail, 2 spacing units wide	on 35 mm DIN rail, 2 spacing units wide	on 35 mm DIN rail, 2 spacing units wide	on 35 mm DIN rail, 2 spacing units wide
Supply voltage				
Rated value (DC)				
• 12 V DC			Yes	
• 24 V DC	Yes	Yes	Yes	
• 115 V DC				Yes
• 230 V DC				Yes
permissible range, lower limit (DC)	20.4 V	20.4 V	10.8 V	100 V
permissible range, upper limit (DC)	28.8 V	28.8 V	28.8 V	253 V
Rated value (AC)				
• 24 V AC		Yes		
• 115 V AC				Yes
• 230 V AC				Yes
Line frequency				
• permissible range, lower limit		47 Hz		47 Hz
• permissible range, upper limit		63 Hz		63 Hz
Digital inputs				
Number of digital inputs	4	4	4	4
Input voltage				
• Type of input voltage	DC	AC/DC	DC	AC/DC
• for signal "0"	< 5 V DC	< 5 V AC/DC	< 5 V DC	< 40 V AC, < 30 V DC
• for signal "1"	> 12 V DC	> 12 V AC/DC	> 8.5 V	> 79 V AC, > 79 V DC
Input current				
• for signal "0", max. (permissible quiescent current)	0.88 mA	1.1 mA	0.88 mA	0.06 mA; 0.05 mA with AC, 0.06 mA with DC
• for signal "1", typ.	2.1 mA	2.63 mA	1.5 mA	0.13 mA
Input delay (for rated value of input voltage) for standard inputs				
- at "0" to "1", max.	1.5 ms	1.5 ms	1.5 ms	40 ms
- at "1" to "0", max.	1.5 ms	15 ms	1.5 ms	75 ms

LOGO! logic modules

LOGO! modular

LOGO! modular expansion modules**Technical specifications (continued)**

Article number	6ED1055-1CB00-0BA2 LOGO! DM8 24 EXPANSION MODULE, 2MW, 4DI/4DQ	6ED1055-1HB00-0BA2 LOGO! DM8 24R EXPANSION MODULE, 2MW, 4DI/4DQ	6ED1055-1MB00-0BA2 LOGO! DM8 12/24R, EXPANSION MODULE, 2MW, 4DI/4DQ	6ED1055-1FB00-0BA2 LOGO! DM8 230R, EXPANSION MODULE, 2MW, 4DI/4DQ
Digital outputs				
Number of digital outputs	4	4; Relays	4; Relays	4; Relays
Short-circuit protection	Yes	No	No	No
Controlling a digital input		Yes	Yes	Yes
Switching capacity of the outputs				
• on lamp load, max.		1 000 W	1 000 W	1 000 W; 500 W at 115V AC
Parallel switching of two outputs				
• for uprating	No	No	No	No
Switching frequency				
• with resistive load, max.	10 Hz	2 Hz	2 Hz	2 Hz
• with inductive load, max.	0.5 Hz	0.5 Hz	0.5 Hz	0.5 Hz
• mechanical, max.		10 Hz	10 Hz	10 Hz
Relay outputs				
Switching capacity of contacts				
- with inductive load, max.		3 A	3 A	3 A
- with resistive load, max.		5 A	5 A	5 A
EMC				
Emission of radio interference acc. to EN 55 011				
• Limit class B, for use in residential areas	Yes	Yes	Yes	Yes
Degree and class of protection				
Degree of protection acc. to EN 60529				
• IP20	Yes	Yes	Yes	Yes
Standards, approvals, certificates				
CE mark	Yes	Yes	Yes	Yes
CSA approval	Yes	Yes	Yes	Yes
UL approval	Yes	Yes	Yes	Yes
FM approval	Yes	Yes	Yes	Yes
developed in accordance with IEC 61131	Yes	Yes	Yes	Yes
according to VDE 0631	Yes	Yes		Yes
Marine approval				
• Marine approval	Yes	Yes	Yes	Yes
Ambient conditions				
Ambient temperature during operation				
• min.	0 °C	0 °C	0 °C	0 °C
• max.	55 °C	55 °C	55 °C	55 °C
Dimensions				
Width	35.5 mm	35.5 mm	35.5 mm	35.5 mm
Height	90 mm	90 mm	90 mm	90 mm
Depth	58 mm	58 mm	58 mm	58 mm

Technical specifications (continued)

Article number	6ED1055-1CB10-0BA2 LOGO! DM16 24, EXP. MODULE, 4MW, 8DI/8DQ	6ED1055-1NB10-0BA2 LOGO! DM16 24R, EXP. MODULE, 4MW, 8DI/8DQ	6ED1055-1FB10-0BA2 LOGO! DM16 230R, EXP. MODULE, 4MW, 8DI/8DQ
Installation type/mounting			
Mounting	on 35 mm DIN rail, 4 spacing units wide	on 35 mm DIN rail, 4 spacing units wide	on 35 mm DIN rail, 4 spacing units wide
Supply voltage			
Rated value (DC)			
• 24 V DC	Yes	Yes	
• 115 V DC			Yes
• 230 V DC			Yes
permissible range, lower limit (DC)	20.4 V	20.4 V	100 V
permissible range, upper limit (DC)	28.8 V	28.8 V	253 V
Rated value (AC)			
• 24 V AC		No	
• 115 V AC			Yes
• 230 V AC			Yes
Line frequency			
• permissible range, lower limit			47 Hz
• permissible range, upper limit			63 Hz
Digital inputs			
Number of digital inputs	8	8	8
Input voltage			
• Type of input voltage	DC	DC	AC/DC
• for signal *0*	< 5 V DC	< 5 V DC	< 40 V AC, < 30 V DC
• for signal *1*	> 12 V DC	> 12 V DC	> 79 V AC, > 79 V DC
Input current			
• for signal *0*, max. (permissible quiescent current)	0.85 mA	0.85 mA	0.06 mA; 0.05 mA with AC, 0.06 mA with DC
• for signal *1*, typ.	3.5 mA	2 mA	0.13 mA
Input delay (for rated value of input voltage)			
for standard inputs			
- at *0* to *1*, max.	1.5 ms	1.5 ms	40 ms
- at *1* to *0*, max.	1.5 ms	1.5 ms	75 ms
Digital outputs			
Number of digital outputs	8	8; Relays	8; Relays
Short-circuit protection	Yes	No	No
Controlling a digital input	Yes	Yes	Yes
Switching capacity of the outputs			
• on lamp load, max.		1 000 W	1 000 W; 500 W at 115V AC
Parallel switching of two outputs			
• for uprating	No	No	No
Switching frequency			
• with resistive load, max.	10 Hz	2 Hz	2 Hz
• with inductive load, max.	0.5 Hz	0.5 Hz	0.5 Hz
• mechanical, max.		10 Hz	10 Hz
Relay outputs			
Switching capacity of contacts			
- with inductive load, max.		3 A	3 A
- with resistive load, max.		5 A	5 A

LOGO! logic modules

LOGO! modular

LOGO! modular expansion modules**Technical specifications (continued)**

Article number	6ED1055-1CB10-0BA2 LOGO! DM16 24, EXP. MODULE, 4MW, 8DI/8DQ	6ED1055-1NB10-0BA2 LOGO! DM16 24R, EXP. MODULE, 4MW, 8DI/8DQ	6ED1055-1FB10-0BA2 LOGO! DM16 230R, EXP. MODULE, 4MW, 8DI/8DQ
EMC			
Emission of radio interference acc. to EN 55 011			
• Limit class B, for use in residential areas	Yes	Yes	Yes
Degree and class of protection			
Degree of protection acc. to EN 60529			
• IP20	Yes	Yes	Yes
Standards, approvals, certificates			
CE mark	Yes	Yes	Yes
CSA approval	Yes	Yes	Yes
UL approval	Yes	Yes	Yes
FM approval	Yes	Yes	Yes
developed in accordance with IEC 61131	Yes	Yes	Yes
according to VDE 0631	Yes	Yes	Yes
Marine approval			
• Marine approval	Yes	Yes	Yes
Ambient conditions			
Ambient temperature during operation			
• min.	0 °C	0 °C	0 °C
• max.	55 °C	55 °C	55 °C
Dimensions			
Width	71.5 mm	71.5 mm	71.5 mm
Height	90 mm	90 mm	90 mm
Depth	58 mm	58 mm	58 mm

Article number	6ED1055-1MA00-0BA2 LOGO! AM2 EXPANSION MODULE, 12/24V, 2AI	6ED1055-1MD00-0BA2 LOGO! AM2 RDT, 2AI, -50..+200DECR/C
Installation type/mounting		
Mounting	on 35 mm DIN rail, 2 spacing units wide	on 35 mm DIN rail, 2 spacing units wide
Supply voltage		
Rated value (DC)		
• 12 V DC	Yes; 10.8 V DC to 28.8 V DC	Yes; 10.8 V DC to 28.8 V DC
• 24 V DC	Yes; 10.8 V DC to 28.8 V DC	Yes; 10.8 V DC to 28.8 V DC
Analog inputs		
Number of analog inputs	2	2; 2 or 3 wire connection
Input ranges		
• Voltage	Yes	No
• Current	Yes	No
• Resistance thermometer	No	Yes; For PT100/PT1000 sensors
Input ranges (rated values), voltages		
• 0 to +10 V	Yes	No
Input ranges (rated values), currents		
• 0 to 20 mA	Yes; 0 mA or 4 mA to 20 mA	No
Input ranges (rated values), resistance thermometer		
• Pt 100	No	Yes
EMC		
Emission of radio interference acc. to EN 55 011		
• Limit class B, for use in residential areas	Yes	Yes
Degree and class of protection		
Degree of protection acc. to EN 60529		
• IP20	Yes	Yes

Technical specifications (continued)

Article number	6ED1055-1MA00-0BA2 LOGO! AM2 EXPANSION MODULE, 12/24V, 2AI	6ED1055-1MD00-0BA2 LOGO! AM2 RDT, 2AI, -50...+200DECR/C
Standards, approvals, certificates		
CE mark	Yes	Yes
CSA approval	Yes	Yes
UL approval	Yes	Yes
FM approval	Yes	Yes
developed in accordance with IEC 61131	Yes	Yes
according to VDE 0631	Yes	
Marine approval		
• Marine approval	Yes	Yes
Ambient conditions		
Ambient temperature during operation		
• min.	0 °C	0 °C
• max.	55 °C	55 °C
Dimensions		
Width	35.5 mm	35.5 mm
Height	90 mm	90 mm
Depth	58 mm	58 mm

Article number	6ED1055-1MM00-0BA2 LOGO! AM2 AQ, 2AQ, 0-10V, 0/4-20MA
Installation type/mounting	
Mounting	on 35 mm DIN rail, 2 spacing units wide
Supply voltage	
Rated value (DC)	
• 12 V DC	No
• 24 V DC	Yes
Analog outputs	
Number of analog outputs	2
Output ranges, voltage	
• 0 to 10 V	Yes
Output ranges, current	
• 0 to 20 mA	Yes
• 4 mA to 20 mA	Yes
EMC	
Emission of radio interference acc. to EN 55 011	
• Limit class B, for use in residential areas	Yes
Degree and class of protection	
Degree of protection acc. to EN 60529	
• IP20	Yes

Article number	6ED1055-1MM00-0BA2 LOGO! AM2 AQ, 2AQ, 0-10V, 0/4-20MA
Standards, approvals, certificates	
CE mark	Yes
CSA approval	Yes
UL approval	Yes
FM approval	Yes
developed in accordance with IEC 61131	Yes
according to VDE 0631	Yes
Marine approval	
• Marine approval	Yes
Ambient conditions	
Ambient temperature during operation	
• min.	0 °C
• max.	55 °C
Dimensions	
Width	35.5 mm
Height	90 mm
Depth	58 mm

LOGO! logic modules

LOGO! modular

LOGO! modular expansion modules

2

Ordering data	Article No.	Ordering data	Article No.
LOGO! 8 expansion modules		Accessories for LOGO! 8	
LOGO! DM8 24 Supply voltage 24 V DC, 4 digital inputs 24 V DC, 4 digital outputs 24 V DC, 0.3 A	6ED1055-1CB00-0BA2	LOGO!Soft Comfort V8 For programming on the PC in LAD/FBD; executes on Windows 8, 7, XP, Linux and Mac OSX; on DVD	6ED1058-0BA08-0YA1
LOGO! DM16 24 Supply voltage 24 V DC, 8 digital inputs 24 V DC, 8 digital outputs 24 V DC, 0.3 A	6ED1055-1CB10-0BA2		
LOGO! DM8 12/24R Supply voltage 12...24 V DC, 4 digital inputs 12...24 V DC, 4 relay outputs 5 A	6ED1055-1MB00-0BA2		
LOGO! DM8 24R Supply voltage 24 V AC/DC, 4 digital inputs 24 V AC/DC, 4 relay outputs 5 A	6ED1055-1HB00-0BA2		
LOGO! DM16 24R Supply voltage 24 V DC, 8 digital inputs 24 V DC, 8 relay outputs 5 A	6ED1055-1NB10-0BA2		
LOGO! DM8 230R Supply voltage 115...230 V AC/DC, 4 digital inputs 115...230 V AC/DC, 4 relay outputs 5 A	6ED1055-1FB00-0BA2		
LOGO! DM16 230R Supply voltage 115...230 V AC/DC, 8 digital inputs 115...230 V AC/DC, 8 relay outputs 5 A	6ED1055-1FB10-0BA2		
LOGO! AM2 Supply voltage 12...24 V DC, 2 analog inputs 0 to 10 V or 0 to 20 mA, resolution 10 bits	6ED1055-1MA00-0BA2		
LOGO! AM2 PT 100 Supply voltage 12...24 V DC, 2 analog inputs Pt100, temperature range -50 °C to 200 °C	6ED1055-1MD00-0BA2		
LOGO! AM2 AQ Supply voltage 24 V DC, 2 analog outputs 0 to 10 V, 0/4 to 20 mA	6ED1055-1MM00-0BA2		

Overview

- The space-saving basic variants
- Interface for connecting expansion modules, up to 24 digital inputs, 20 (16) digital outputs, 8 analog inputs and 8 (2) analog outputs can be addressed
- With connection option for LOGO! TD text display (can be connected to all LOGO! 0BA6 and 0BA7 basic variants); LOGO! TDE can be connected to LOGO! 8 or higher

New for LOGO! 8

- All basic units with integrated web server
- Same enclosure width as LOGO! 0BA6 (4 U)
- All basic units with Ethernet interface for communication with LOGO!, SIMATIC Controllers, SIMATIC Panel and PC
- Use of standard micro CF cards

LOGO! 0BA7 versions:

- Ethernet interface for communication with SIMATIC Controllers, SIMATIC Panel and PC
- Networking of max. 8 LOGO! devices
- Use of standard SD card or SIMATIC Memory Card

Note:

SIPLUS LOGO! 6/7 versions are not compatible with SIPLUS LOGO! 8.

SIPLUS extreme products are based on SIMATIC standard products. The contents listed here were taken from the respective standard products. SIPLUS extreme-specific information was added.

Technical specifications

Article number	6AG1052-1CC01-7BA8	6AG1052-1MD00-7BA8	6AG1052-1HB00-7BA8	6AG1052-1FB00-7BA8
Based on	6ES7052-1CC01-0BA8 SIPLUS LOGO! 24CE	6ES7052-1MD00-0BA8 SIPLUS LOGO! 12/24RCE	6ES7052-1HB00-0BA8 SIPLUS LOGO! 24RCE	6ES7052-1FB00-0BA8 SIPLUS LOGO! 230RCE
Ambient conditions				
Ambient temperature during operation				
• min.	-10 °C; = Tmin; Startup @ 0 °C	-10 °C; = Tmin; Startup @ 0 °C	-10 °C; = Tmin; Startup @ 0 °C	-10 °C; = Tmin; Startup @ 0 °C
• max.	60 °C; Tmax; Tmax > +55 °C max. load 0.2 A per output	60 °C; Tmax; Tmax > +55 °C max. load 1 A per relay or max. load 3 A per relay and half the number of DIs (no adjacent points)	60 °C; Tmax; Tmax > +55 °C max. load 1 A per relay or max. load 3 A per relay and half the number of DIs (no adjacent points)	60 °C; Tmax; Tmax > +55 °C max. load 1 A per relay
Ambient temperature during storage/transportation				
• min.	-40 °C	-40 °C	-40 °C	-40 °C
• max.	70 °C	70 °C	70 °C	70 °C
Extended ambient conditions				
• relative to ambient temperature-atmospheric pressure-installation altitude	Tmin ... Tmax at 1080 hPa ... 795 hPa (-1000 m ... +2000 m) // Tmin ... (Tmax - 10K) at 795 hPa ... 658 hPa (+2000 m ... +3500 m) // Tmin ... (Tmax - 20K) at 658 hPa ... 540 hPa (+3500 m ... +5000 m)			
• At cold restart, min.	0 °C	0 °C	0 °C	0 °C
Relative humidity				
- With condensation, tested in accordance with IEC 60068-2-38, max.	100 %; RH incl. condensation / frost (no commissioning in bedewed state), horizontal installation	100 %; RH incl. condensation / frost (no commissioning in bedewed state), horizontal installation	100 %; RH incl. condensation / frost (no commissioning in bedewed state), horizontal installation	100 %; RH incl. condensation / frost (no commissioning in bedewed state), horizontal installation

LOGO! logic modules

LOGO! modular

SIPLUS LOGO! modular basic variants

Technical specifications (continued)

Article number	6AG1052-1CC01-7BA8	6AG1052-1MD00-7BA8	6AG1052-1HB00-7BA8	6AG1052-1FB00-7BA8
Based on	6ES7052-1CC01-0BA8 SIPLUS LOGO! 24CE	6ES7052-1MD00-0BA8 SIPLUS LOGO! 12/24RCE	6ES7052-1HB00-0BA8 SIPLUS LOGO! 24RCE	6ES7052-1FB00-0BA8 SIPLUS LOGO! 230RCE
Resistance				
- against biologically active substances / conformity with EN 60721-3-3	Yes; Class 3B2 mold, fungus and dry rot spores (with the exception of fauna). The supplied connector covers must remain on the unused interfaces during operation!	Yes; Class 3B2 mold, fungus and dry rot spores (with the exception of fauna). The supplied connector covers must remain on the unused interfaces during operation!	Yes; Class 3B2 mold, fungus and dry rot spores (with the exception of fauna). The supplied connector covers must remain on the unused interfaces during operation!	Yes; Class 3B2 mold, fungus and dry rot spores (with the exception of fauna). The supplied connector covers must remain on the unused interfaces during operation!
- against chemically active substances / conformity with EN 60721-3-3	Yes; Class 3C4 (RH < 75%) incl. salt spray according to EN 60068-2-52 (degree of severity 3). The supplied connector covers must remain on the unused interfaces during operation!	Yes; Class 3C4 (RH < 75%) incl. salt spray according to EN 60068-2-52 (degree of severity 3). The supplied connector covers must remain on the unused interfaces during operation!	Yes; Class 3C4 (RH < 75%) incl. salt spray according to EN 60068-2-52 (degree of severity 3). The supplied connector covers must remain on the unused interfaces during operation!	Yes; Class 3C4 (RH < 75%) incl. salt spray according to EN 60068-2-52 (degree of severity 3). The supplied connector covers must remain on the unused interfaces during operation!
- against mechanically active substances / conformity with EN 60721-3-3	Yes; Class 3S4 incl. sand, dust. The supplied connector covers must remain on the unused interfaces during operation!	Yes; Class 3S4 incl. sand, dust. The supplied connector covers must remain on the unused interfaces during operation!	Yes; Class 3S4 incl. sand, dust. The supplied connector covers must remain on the unused interfaces during operation!	Yes; Class 3S4 incl. sand, dust. The supplied connector covers must remain on the unused interfaces during operation!
Article number	6AG1052-1MD00-2BA7		6AG1052-1FB00-2BA7	
Based on	6ES7052-1MD00-0BA7 SIPLUS LOGO!12/24RCE		6ES7052-1FB00-0BA7 SIPLUS LOGO! 230RCE	
Ambient conditions				
Ambient temperature during operation				
• min.	-25 °C; = Tmin		-25 °C; = Tmin	
• max.	70 °C; = Tmax		70 °C; = Tmax	
Extended ambient conditions				
• relative to ambient temperature-atmospheric pressure-installation altitude	Tmin ... Tmax at 1080 hPa ... 795 hPa (-1000 m ... +2000 m) // Tmin ... (Tmax - 10K) at 795 hPa ... 658 hPa (+2000 m ... +3500 m) // Tmin ... (Tmax - 20K) at 658 hPa ... 540 hPa (+3500 m ... +5000 m)		Tmin ... Tmax at 1080 hPa ... 795 hPa (-1000 m ... +2000 m)	
Relative humidity				
- With condensation, tested in accordance with IEC 60068-2-38, max.	100 %; Relative humidity, incl. condensation / frost permitted (no commissioning under condensation conditions)		100 %; Relative humidity, incl. condensation / frost permitted (no commissioning under condensation conditions)	
Resistance				
- against biologically active substances / conformity with EN 60721-3-3	Yes; Class 3B2 mold, fungus and dry rot spores (with the exception of fauna). The supplied connector covers must remain on the unused interfaces during operation!		Yes; Class 3B2 mold, fungus and dry rot spores (with the exception of fauna). The supplied connector covers must remain on the unused interfaces during operation!	
- against chemically active substances / conformity with EN 60721-3-3	Yes; Class 3C4 incl. salt spray according to EN 60068-2-52 (degree of severity 3). The supplied connector covers must remain on the unused interfaces during operation!		Yes; Class 3C4 incl. salt spray according to EN 60068-2-52 (degree of severity 3). The supplied connector covers must remain on the unused interfaces during operation!	
- against mechanically active substances / conformity with EN 60721-3-3	Yes; Class 3S4 incl. sand, dust. The supplied connector covers must remain on the unused interfaces during operation!		Yes; Class 3S4 incl. sand, dust. The supplied connector covers must remain on the unused interfaces during operation!	

Technical specifications (continued)

Article number	6AG1052-1CC01-2BA6	6AG1052-1MD00-2BA6	6AG1052-1HB00-2BA6	6AG1052-1FB00-2BA6
Based on	6ES7052-1CC01-0BA6 SIPLUS LOGO! 24C	6ES7052-1MD00-0BA6 SIPLUS LOGO! 12/24RC	6ES7052-1HB00-0BA6 SIPLUS LOGO! 24RC	6ES7052-1FB00-0BA6 SIPLUS LOGO! 230RC
Ambient conditions				
Ambient temperature during operation				
• min.	-25 °C; = Tmin	-25 °C; = Tmin	-25 °C; = Tmin	-25 °C; = Tmin
• max.	70 °C; = Tmax; 55 °C @ UL/cUL use	70 °C; = Tmax; 55 °C @ UL/cUL use	70 °C; = Tmax; 55 °C @ UL/cUL use	70 °C; = Tmax; 55 °C @ UL/cUL use
Extended ambient conditions				
• relative to ambient temperature-atmospheric pressure-installation altitude	Tmin ... Tmax at 1080 hPa ... 795 hPa (-1000 m ... +2000 m) // Tmin ... (Tmax - 10K) at 795 hPa ... 658 hPa (+2000 m ... +3500 m) // Tmin ... (Tmax - 20K) at 658 hPa ... 540 hPa (+3500 m ... +5000 m)	Tmin ... Tmax at 1080 hPa ... 795 hPa (-1000 m ... +2000 m) // Tmin ... (Tmax - 10K) at 795 hPa ... 658 hPa (+2000 m ... +3500 m) // Tmin ... (Tmax - 20K) at 658 hPa ... 540 hPa (+3500 m ... +5000 m)	Tmin ... Tmax at 1080 hPa ... 795 hPa (-1000 m ... +2000 m) // Tmin ... (Tmax - 10K) at 795 hPa ... 658 hPa (+2000 m ... +3500 m) // Tmin ... (Tmax - 20K) at 658 hPa ... 540 hPa (+3500 m ... +5000 m)	Tmin ... Tmax at 1080 hPa ... 795 hPa (-1000 m ... +2000 m)
Relative humidity				
- With condensation, tested in accordance with IEC 60068-2-38, max.	100 %; Relative humidity, incl. condensation / frost permitted (no commissioning under condensation conditions)	100 %; Relative humidity, incl. condensation / frost permitted (no commissioning under condensation conditions)	100 %; Relative humidity, incl. condensation / frost permitted (no commissioning under condensation conditions)	100 %; Relative humidity, incl. condensation / frost permitted (no commissioning under condensation conditions)
Resistance				
- against biologically active substances / conformity with EN 60721-3-3	Yes; Class 3B2 mold, fungus and dry rot spores (with the exception of fauna). The supplied connector covers must remain on the unused interfaces during operation!	Yes; Class 3B2 mold, fungus and dry rot spores (with the exception of fauna). The supplied connector covers must remain on the unused interfaces during operation!	Yes; Class 3B2 mold, fungus and dry rot spores (with the exception of fauna). The supplied connector covers must remain on the unused interfaces during operation!	Yes; Class 3B2 mold, fungus and dry rot spores (with the exception of fauna). The supplied connector covers must remain on the unused interfaces during operation!
- against chemically active substances / conformity with EN 60721-3-3	Yes; Class 3C4 incl. salt spray. The supplied connector covers must remain on the unused interfaces during operation!	Yes; Class 3C4 incl. salt spray. The supplied connector covers must remain on the unused interfaces during operation!	Yes; Class 3C4 incl. salt spray. The supplied connector covers must remain on the unused interfaces during operation!	Yes; Class 3C4 incl. salt spray. The supplied connector covers must remain on the unused interfaces during operation!
- against mechanically active substances / conformity with EN 60721-3-3	Yes; Class 3S4 incl. sand, dust. The supplied connector covers must remain on the unused interfaces during operation!	Yes; Class 3S4 incl. sand, dust. The supplied connector covers must remain on the unused interfaces during operation!	Yes; Class 3S4 incl. sand, dust. The supplied connector covers must remain on the unused interfaces during operation!	Yes; Class 3S4 incl. sand, dust. The supplied connector covers must remain on the unused interfaces during operation!

LOGO! logic modules

LOGO! modular

SIPLUS LOGO! modular basic variants

2

Ordering data**Article No.****Article No.****SIPLUS LOGO! 8 logic module****SIPLUS LOGO! 24CE**

Supply voltage 24 V DC,
8 digital inputs 24 V DC, of which
4 can be used in analog mode
(0 to 10 V),
4 digital outputs 24 V DC, 0.3 A,
integrated time switch
Ethernet interface;
400 function blocks can be
interlinked, modular expansion
capability

Extended temperature range and
exposure to media

6AG1052-1CC01-7BA8**SIPLUS LOGO! 12/24RCE**

Supply voltage 12...24 V DC,
8 digital inputs 12/24 V DC, of
which 4 can be used in analog
mode (0 to 10 V),
4 relay outputs 10 A,
integral time switch,
Ethernet interface;
400 function blocks can be
interlinked, modular expansion
capability

Extended temperature range and
exposure to media

6AG1052-1MD00-7BA8**SIPLUS LOGO! 24RCE**

Supply voltage 24 V AC/DC,
8 digital inputs 24 V AC/DC,
4 relay outputs 10 A,
integral time switch,
Ethernet interface;
400 function blocks can be
interlinked, modular expansion
capability

Extended temperature range and
exposure to media

6AG1052-1HB00-7BA8**SIPLUS LOGO! 230RCE**

Supply voltage 115...230 V AC/DC,
8 digital inputs 115...230 V AC/DC,
4 relay outputs 10 A,
integral time switch,
Ethernet interface;
400 function blocks can be
interlinked, modular expansion
capability

Extended temperature range and
exposure to media

6AG1052-1FB00-7BA8**SIPLUS LOGO! 7 logic module****SIPLUS LOGO! 12/24RCE**

Supply voltage 12/24 V DC,
8 digital inputs 12/24 V DC, of
which 4 can be used in analog
mode (0 to 10 V),
4 relay outputs 10 A,
integral time switch;
400 function blocks can be
interlinked,
Ethernet interface,
modular expansion capability

Extended temperature range and
exposure to media

6AG1052-1MD00-2BA7**SIPLUS LOGO! 230RCE**

Supply voltage 115/230 V AC/DC,
8 digital inputs 115/230 V AC/DC,
4 relay outputs 10 A,
integral time switch;
400 function blocks can be
interlinked,
Ethernet interface,
modular expansion capability

Extended temperature range and
exposure to media

6AG1052-1FB00-2BA7**SIPLUS LOGO! 6 logic module****SIPLUS LOGO! 24**

Supply voltage 24 V DC,
8 digital inputs 24 V DC, of which
4 can be used in analog mode
(0 to 10 V),
4 digital outputs 24 V DC, 0.3 A,
integrated time switch;
200 function blocks can be
interlinked,
modular expansion capability

Extended temperature range and
exposure to media

6AG1052-1CC01-2BA6**SIPLUS LOGO! 12/24RC**

12/24 V DC power supply,
8 digital inputs 12/24 V DC, of
which 4 can be used in analog
mode (0 to 10 V)
4 relay outputs 10 A,
integral time switch;
200 function blocks can be
interlinked,
modular expansion capability

Extended temperature range and
exposure to media

6AG1052-1MD00-2BA6**SIPLUS LOGO! 24RC**

Supply voltage 24 V AC/DC,
8 digital inputs 24 V AC/DC,
4 relay outputs 10 A,
integral time switch;
200 function blocks can be
interlinked,
modular expansion capability

Extended temperature range and
exposure to media

6AG1052-1HB00-2BA6**SIPLUS LOGO! 230RC**

Control supply voltage
115/230 V AC/DC,
8 digital inputs 115/230 V AC/DC,
4 relay outputs 10 A,
integrated time switch;
200 function blocks can be
interlinked,
modular expansion capability

Extended temperature range and
exposure to media

6AG1052-1FB00-2BA6**SIPLUS LOGO! 6, 7, 8 accessories****LOGO!Soft Comfort V8**

For programming on the PC in
LAD/FBD; executes on Windows 8,
7, XP, Linux and Mac OSX; on DVD

6ED1058-0BA08-0YA1**Front panel mounting set**

Width 4 U

6AG1057-1AA00-0AA0

Width 8 U

6AG1057-1AA00-0AA1

Width 8 U, with keys

6AG1057-1AA00-0AA2**SIPLUS LOGO! 6, 7 accessories****SIPLUS LOGO! TD text display**

(Extended temperature range
-10 ... +60 °C and exposure to
media)

4-line text display, can be
connected to all LOGO! basic and
pure variants as of -0BA6, including
connecting cable

6AG1055-4MH00-2BA0

Overview

- Basic variants optimized for costs
- Interface for connecting expansion modules, up to 24 digital inputs, 16 (20) digital outputs, 8 analog inputs and 2 (8) analog outputs can be addressed
- With connection option for LOGO! TD text display (can be connected to all LOGO! 0BA6 basic variants)

New for SIPLUS LOGO! 8

- All basic units with integrated web server
- Same enclosure width as LOGO! 0BA6 (4 U)
- All basic units with Ethernet interface for communication with LOGO!, SIMATIC Controllers, SIMATIC Panel and PC
- Use of standard micro CF cards

Note:

SIPLUS LOGO! 6 versions are not compatible with SIPLUS LOGO! 8.

SIPLUS extreme products are based on SIMATIC standard products. The contents listed here were adopted from the respective standard products. SIPLUS extreme specific information was added.

Technical specifications

Article number	6AG1052-2CC01-7BA8	6AG1052-2MD00-7BA8	6AG1052-2HB00-7BA8	6AG1052-2FB00-7BA8
Based on	6ED1052-2CC01-0BA8 SIPLUS LOGO! 24CEO	6ED1052-2MD00-0BA8 SIPLUS LOGO! 12/24RCEO	6ED1052-2HB00-0BA8 SIPLUS LOGO! 24RCEO (AC)	6ED1052-2FB00-0BA8 SIPLUS LOGO! 230RCEO
Ambient conditions				
Ambient temperature during operation				
• min.	-40 °C; = Tmin; Startup @ -25 °C	-40 °C; = Tmin; Startup @ -25 °C	-40 °C; = Tmin; Startup @ -25 °C	-40 °C; = Tmin; Startup @ -25 °C
• max.	70 °C; Tmax; Tmax > +55 °C max. load 0,2 A per output	70 °C; Tmax; Tmax > +55 °C max. load 1 A per relay or max. load 3 A per relay and half the number of DIs (no adjacent points)	70 °C; Tmax; Tmax > +55 °C max. load 1 A per relay or max. load 3 A per relay and half the number of DIs (no adjacent points)	70 °C; Tmax; Tmax > +55 °C max. load 1 A per relay
Ambient temperature during storage/transportation				
• min.	-40 °C	-40 °C	-40 °C	-40 °C
• max.	70 °C	70 °C	70 °C	70 °C
Extended ambient conditions				
• relative to ambient temperature-atmospheric pressure-installation altitude	Tmin ... Tmax at 1080 hPa ... 795 hPa (-1000 m ... +2000 m) // Tmin ... (Tmax - 10K) at 795 hPa ... 658 hPa (+2000 m ... +3500 m) // Tmin ... (Tmax - 20K) at 658 hPa ... 540 hPa (+3500 m ... +5000 m)			
• At cold restart, min.	0 °C	0 °C	0 °C	0 °C

LOGO! logic modules

LOGO! modular

SIPLUS LOGO! modular pure variants

Technical specifications (continued)

Article number	6AG1052-2CC01-7BA8	6AG1052-2MD00-7BA8	6AG1052-2HB00-7BA8	6AG1052-2FB00-7BA8
Based on	6ED1052-2CC01-0BA8 SIPLUS LOGO! 24CEO	6ED1052-2MD00-0BA8 SIPLUS LOGO! 12/24RCEO	6ED1052-2HB00-0BA8 SIPLUS LOGO! 24RCEO (AC)	6ED1052-2FB00-0BA8 SIPLUS LOGO! 230RCEO
Relative humidity	100 %; RH incl. condensation / frost (no commissioning in bedewed state), horizontal installation	100 %; RH incl. condensation / frost (no commissioning in bedewed state), horizontal installation	100 %; RH incl. condensation / frost (no commissioning in bedewed state), horizontal installation	100 %; RH incl. condensation / frost (no commissioning in bedewed state), horizontal installation
Resistance				
- against biologically active substances / conformity with EN 60721-3-3	Yes; Class 3B2 mold, fungus and dry rot spores (with the exception of fauna). The supplied connector covers must remain on the unused interfaces during operation!	Yes; Class 3B2 mold, fungus and dry rot spores (with the exception of fauna). The supplied connector covers must remain on the unused interfaces during operation!	Yes; Class 3B2 mold, fungus and dry rot spores (with the exception of fauna). The supplied connector covers must remain on the unused interfaces during operation!	Yes; Class 3B2 mold, fungus and dry rot spores (with the exception of fauna). The supplied connector covers must remain on the unused interfaces during operation!
- against chemically active substances / conformity with EN 60721-3-3	Yes; Class 3C4 (RH < 75%) incl. salt spray according to EN 60068-2-52 (degree of severity 3). The supplied connector covers must remain on the unused interfaces during operation!	Yes; Class 3C4 (RH < 75%) incl. salt spray according to EN 60068-2-52 (degree of severity 3). The supplied connector covers must remain on the unused interfaces during operation!	Yes; Class 3C4 (RH < 75%) incl. salt spray according to EN 60068-2-52 (degree of severity 3). The supplied connector covers must remain on the unused interfaces during operation!	Yes; Class 3C4 (RH < 75%) incl. salt spray according to EN 60068-2-52 (degree of severity 3). The supplied connector covers must remain on the unused interfaces during operation!
- against mechanically active substances / conformity with EN 60721-3-3	Yes; Class 3S4 incl. sand, dust. The supplied connector covers must remain on the unused interfaces during operation!	Yes; Class 3S4 incl. sand, dust. The supplied connector covers must remain on the unused interfaces during operation!	Yes; Class 3S4 incl. sand, dust. The supplied connector covers must remain on the unused interfaces during operation!	Yes; Class 3S4 incl. sand, dust. The supplied connector covers must remain on the unused interfaces during operation!
Article number	6AG1052-2CC01-2BA6	6AG1052-2MD00-2BA6	6AG1052-2HB00-2BA6	6AG1052-2FB00-2BA6
Based on	6ED1052-2CC01-0BA6 SIPLUS LOGO! 24Co	6ED1052-2MD00-0BA6 SIPLUS LOGO! 12/24RCo	6ED1052-2HB00-0BA6 SIPLUS LOGO! 24RCo	6ED1052-2FB00-0BA6 SIPLUS LOGO! 230RCo
Ambient conditions				
Ambient temperature during operation				
• min.	-40 °C; = Tmin	-40 °C; = Tmin	-40 °C; = Tmin	-40 °C; = Tmin
• max.	70 °C; = Tmax; 55 °C @ UL/cUL use	70 °C; = Tmax; 55 °C @ UL/cUL use	70 °C; = Tmax; 55 °C @ UL/cUL use	70 °C; = Tmax; 55 °C @ UL/cUL use
Extended ambient conditions				
• relative to ambient temperature-atmospheric pressure-installation altitude	Tmin ... Tmax at 1080 hPa ... 795 hPa (-1000 m ... +2000 m) // Tmin ... (Tmax - 10K) at 795 hPa ... 658 hPa (+2000 m ... +3500 m) // Tmin ... (Tmax - 20K) at 658 hPa ... 540 hPa (+3500 m ... +5000 m)	Tmin ... Tmax at 1080 hPa ... 795 hPa (-1000 m ... +2000 m) // Tmin ... (Tmax - 10K) at 795 hPa ... 658 hPa (+2000 m ... +3500 m) // Tmin ... (Tmax - 20K) at 658 hPa ... 540 hPa (+3500 m ... +5000 m)	Tmin ... Tmax at 1080 hPa ... 795 hPa (-1000 m ... +2000 m) // Tmin ... (Tmax - 10K) at 795 hPa ... 658 hPa (+2000 m ... +3500 m) // Tmin ... (Tmax - 20K) at 658 hPa ... 540 hPa (+3500 m ... +5000 m)	Tmin ... Tmax at 1080 hPa ... 795 hPa (-1000 m ... +2000 m)
Relative humidity				
- With condensation, tested in accordance with IEC 60068-2-38, max.	100 %; Relative humidity, incl. condensation / frost permitted (no commissioning under condensation conditions)	100 %; Relative humidity, incl. condensation / frost permitted (no commissioning under condensation conditions)	100 %; Relative humidity, incl. condensation / frost permitted (no commissioning under condensation conditions)	100 %; Relative humidity, incl. condensation / frost permitted (no commissioning under condensation conditions)
Resistance				
- against biologically active substances / conformity with EN 60721-3-3	Yes; Class 3B2 mold, fungus and dry rot spores (with the exception of fauna). The supplied connector covers must remain on the unused interfaces during operation!	Yes; Class 3B2 mold, fungus and dry rot spores (with the exception of fauna). The supplied connector covers must remain on the unused interfaces during operation!	Yes; Class 3B2 mold, fungus and dry rot spores (with the exception of fauna). The supplied connector covers must remain on the unused interfaces during operation!	Yes; Class 3B2 mold, fungus and dry rot spores (with the exception of fauna). The supplied connector covers must remain on the unused interfaces during operation!
- against chemically active substances / conformity with EN 60721-3-3	Yes; Class 3C4 incl. salt spray. The supplied connector covers must remain on the unused interfaces during operation!	Yes; Class 3C4 incl. salt spray. The supplied connector covers must remain on the unused interfaces during operation!	Yes; Class 3C4 incl. salt spray. The supplied connector covers must remain on the unused interfaces during operation!	Yes; Class 3C4 incl. salt spray. The supplied connector covers must remain on the unused interfaces during operation!
- against mechanically active substances / conformity with EN 60721-3-3	Yes; Class 3S4 incl. sand, dust. The supplied connector covers must remain on the unused interfaces during operation!	Yes; Class 3S4 incl. sand, dust. The supplied connector covers must remain on the unused interfaces during operation!	Yes; Class 3S4 incl. sand, dust. The supplied connector covers must remain on the unused interfaces during operation!	Yes; Class 3S4 incl. sand, dust. The supplied connector covers must remain on the unused interfaces during operation!

Ordering data	Article No.	Article No.
SIPLUS LOGO! 8 logic module		
SIPLUS LOGO! 24CEo Supply voltage 24 V DC, 8 digital inputs 24 V DC, of which 4 can be used in analog mode (0 to 10 V), 4 digital outputs 24 V DC, 0.3 A, integral time switch Ethernet interface; without display and keyboard; 400 function blocks can be interlinked, modular expansion capability Extended temperature range and exposure to media	6AG1052-2CC01-7BA8	
SIPLUS LOGO! 230RCEo Supply voltage 115...230 V AC/DC, 8 digital inputs 115...230 V AC/DC, 4 relay outputs 10 A, integral time switch, Ethernet interface; without display or keyboard; 400 function blocks can be interlinked, modular expansion capability Extended temperature range and exposure to media	6AG1052-2FB00-7BA8	
SIPLUS LOGO! 24RCEo Supply voltage 24 V AC/DC, 8 digital inputs 24 V AC/DC, 4 relay outputs 10 A, integral time switch, Ethernet interface; without display or keyboard; 400 function blocks can be interlinked, modular expansion capability Extended temperature range and exposure to media	6AG1052-2HB00-7BA8	
SIPLUS LOGO! 12/24RCEo Supply voltage 12...24 V DC, 8 digital inputs 12...24 V DC, of which 4 can be used in analog mode (0 to 10 V), 4 relay outputs 10 A, integral time switch Ethernet interface; without display or keyboard; 400 function blocks can be interlinked, modular expansion capability Extended temperature range and exposure to media	6AG1052-2MD00-7BA8	
SIPLUS LOGO! 6 logic module		
SIPLUS LOGO! 24o Supply voltage 24 V DC, 8 digital inputs 24 V DC, of which 4 can be used in analog mode (0 to 10 V), 4 digital outputs 24 V DC, 0.3 A, integrated time switch; without display and keyboard; 200 function blocks can be interlinked, modular expansion capability Extended temperature range and exposure to media	6AG1052-2CC01-2BA6	
		SIPLUS LOGO! 230RCo Supply voltage 115/230 V AC/DC, 8 digital inputs 115/230 V AC/DC, 4 relay outputs 10 A, integral time switch; without display and keyboard; 200 function blocks can be interlinked, modular expansion capability Extended temperature range and exposure to media
		SIPLUS LOGO! 24RCo Supply voltage 24 V AC/DC, 8 digital inputs 24 V AC/DC, 4 relay outputs 10 A, integral time switch; without display and keyboard; 200 function blocks can be interlinked, modular expansion capability Extended temperature range and exposure to media
		SIPLUS LOGO! 12/24RCo Supply voltage 12/24 V DC, 8 digital inputs 12/24 V DC, of which 4 can be used in analog mode (0 to 10 V), 4 relay outputs 10 A, integral time switch; without display and keyboard; 200 function blocks can be interlinked, modular expansion capability Extended temperature range and exposure to media
		SIPLUS LOGO! 6, 8 accessories
		LOGO!Soft Comfort V8 For programming on the PC in LAD/FBD; executes on Windows 8, 7, XP, Linux and Mac OSX; on DVD
		Front panel mounting set Width 4 U Width 8 U Width 8 U, with keys
		SIPLUS LOGO! 6 accessories
		SIPLUS LOGO! TD text display (Extended temperature range -10 ... +60 °C and exposure to media) 4-line text display, can be connected to all LOGO! basic and pure variants as of -0BA6, including connecting cable
		6AG1052-2FB00-2BA6
		6AG1052-2HB00-2BA6
		6AG1052-2MD00-2BA6
		6ED1058-0BA08-0YA1
		6AG1057-1AA00-0AA0
		6AG1057-1AA00-0AA1
		6AG1057-1AA00-0AA2
		6AG1055-4MH00-2BA0

LOGO! logic modules

LOGO! modular

SIPLUS LOGO! modular expansion modules

Overview

2



- Expansion modules for connection to LOGO! modular
- With digital inputs and outputs, analog inputs, or analog outputs

Note:

SIPLUS LOGO! 6 versions are not compatible with SIPLUS LOGO! 8.

SIPLUS extreme products are based on SIMATIC standard products. The contents listed here were adopted from the respective standard products. SIPLUS extreme specific information was added.

Technical specifications

Article number	6AG1055-1CB00-7BA2	6AG1055-1HB00-7BA2	6AG1055-1MB00-7BA2
Based on	6ED1055-1CB00-0BA2 SIPLUS LOGO! DM8 24 V8	6ED1055-1HB00-0BA2 SIPLUS LOGO! DM8 24R V8	6ED1055-1MB00-0BA2 SIPLUS LOGO! DM8 12/24R V8
Ambient conditions			
Ambient temperature during operation			
• min.	-40 °C; = Tmin; Startup @ -25 °C	-40 °C; = Tmin; Startup @ -25 °C	-40 °C; = Tmin; Startup @ -25 °C
• max.	70 °C; Tmax; Tmax > +55 °C max. load 0.2 A per output	70 °C; = Tmax; Tmax > +55 °C max. load 3 A per relay or max. total current 10 A	70 °C; = Tmax; Tmax > +55 °C max. load 3 A per relay or max. total current 10 A
Ambient temperature during storage/transportation			
• min.	-40 °C	-40 °C	-40 °C
• max.	70 °C	70 °C	70 °C
Extended ambient conditions			
• relative to ambient temperature-atmospheric pressure-installation altitude	Tmin ... Tmax at 1080 hPa ... 795 hPa (-1000 m ... +2000 m) // Tmin ... (Tmax - 10K) at 795 hPa ... 658 hPa (+2000 m ... +3500 m) // Tmin ... (Tmax - 20K) at 658 hPa ... 540 hPa (+3500 m ... +5000 m)		
• At cold restart, min.	-25 °C	-25 °C	-25 °C
Relative humidity			
- With condensation, tested in accordance with IEC 60068-2-38, max.	100 %; RH incl. condensation / frost (no commissioning in bedewed state), horizontal installation	100 %; RH incl. condensation / frost (no commissioning in bedewed state), horizontal installation	100 %; RH incl. condensation / frost (no commissioning in bedewed state), horizontal installation
Resistance			
- against biologically active substances / conformity with EN 60721-3-3	Yes; Class 3B2 mold, fungus and dry rot spores (with the exception of fauna). The supplied connector covers must remain on the unused interfaces during operation!	Yes; Class 3B2 mold, fungus and dry rot spores (with the exception of fauna). The supplied connector covers must remain on the unused interfaces during operation!	Yes; Class 3B2 mold, fungus and dry rot spores (with the exception of fauna). The supplied connector covers must remain on the unused interfaces during operation!
- against chemically active substances / conformity with EN 60721-3-3	Yes; Class 3C4 (RH < 75%) incl. salt spray according to EN 60068-2-52 (degree of severity 3). The supplied connector covers must remain on the unused interfaces during operation!	Yes; Class 3C4 (RH < 75%) incl. salt spray according to EN 60068-2-52 (degree of severity 3). The supplied connector covers must remain on the unused interfaces during operation!	Yes; Class 3C4 (RH < 75%) incl. salt spray according to EN 60068-2-52 (degree of severity 3). The supplied connector covers must remain on the unused interfaces during operation!
- against mechanically active substances / conformity with EN 60721-3-3	Yes; Class 3S4 incl. sand, dust. The supplied connector covers must remain on the unused interfaces during operation!	Yes; Class 3S4 incl. sand, dust. The supplied connector covers must remain on the unused interfaces during operation!	Yes; Class 3S4 incl. sand, dust. The supplied connector covers must remain on the unused interfaces during operation!

Technical specifications (continued)

Article number	6AG1055-1FB00-7BA2	6AG1055-1NB10-7BA2
Based on	6ED1055-1FB00-0BA2 SIPLUS LOGO! DM8 230R V8	6ED1055-1NB10-0BA2 SIPLUS LOGO! DM16 24R V8
Ambient conditions		
Ambient temperature during operation		
• min.	-40 °C; = Tmin; Startup @ -25 °C	-40 °C; = Tmin; Startup @ -25 °C
• max.	70 °C; = Tmax; Tmax > +55 °C max. load 3 A per relay or max. total current 10 A	70 °C; = Tmax; Tmax > +55 °C max. load 3 A per relay
Ambient temperature during storage/transportation		
• min.	-40 °C	-40 °C
• max.	70 °C	70 °C
Extended ambient conditions		
• At cold restart, min.	-25 °C	-25 °C
Relative humidity		
- With condensation, tested in accordance with IEC 60068-2-38, max.	100 %; RH incl. condensation / frost (no commissioning in bedewed state), horizontal installation	100 %; RH incl. condensation / frost (no commissioning in bedewed state), horizontal installation
Resistance		
- against biologically active substances / conformity with EN 60721-3-3	Yes; Class 3B2 mold, fungus and dry rot spores (with the exception of fauna). The supplied connector covers must remain on the unused interfaces during operation!	Yes; Class 3B2 mold, fungus and dry rot spores (with the exception of fauna). The supplied connector covers must remain on the unused interfaces during operation!
- against chemically active substances / conformity with EN 60721-3-3	Yes; Class 3C4 (RH < 75%) incl. salt spray according to EN 60068-2-52 (degree of severity 3). The supplied connector covers must remain on the unused interfaces during operation!	Yes; Class 3C4 (RH < 75%) incl. salt spray according to EN 60068-2-52 (degree of severity 3). The supplied connector covers must remain on the unused interfaces during operation!
- against mechanically active substances / conformity with EN 60721-3-3	Yes; Class 3S4 incl. sand, dust. The supplied connector covers must remain on the unused interfaces during operation!	Yes; Class 3S4 incl. sand, dust. The supplied connector covers must remain on the unused interfaces during operation!

Article number	6AG1055-1MA00-7BA2
Based on	6ED1055-1MA00-0BA2 SIPLUS LOGO! AM2 V8
Ambient conditions	
Ambient temperature during operation	
• min.	-40 °C; = Tmin; Startup @ -25 °C
• max.	70 °C; = Tmax
Ambient temperature during storage/transportation	
• min.	-40 °C
• max.	70 °C
Extended ambient conditions	
• relative to ambient temperature-atmospheric pressure-installation altitude	Tmin ... Tmax at 1080 hPa ... 795 hPa (-1000 m ... +2000 m) // Tmin ... (Tmax - 10K) at 795 hPa ... 658 hPa (+2000 m ... +3500 m) // Tmin ... (Tmax - 20K) at 658 hPa ... 540 hPa (+3500 m ... +5000 m)
• At cold restart, min.	-25 °C
Relative humidity	
- With condensation, tested in accordance with IEC 60068-2-38, max.	100 %; RH incl. condensation / frost (no commissioning in bedewed state), horizontal installation

Article number	6AG1055-1MA00-7BA2
Based on	6ED1055-1MA00-0BA2 SIPLUS LOGO! AM2 V8
Resistance	
- against biologically active substances / conformity with EN 60721-3-3	Yes; Class 3B2 mold, fungus and dry rot spores (with the exception of fauna). The supplied connector covers must remain on the unused interfaces during operation!
- against chemically active substances / conformity with EN 60721-3-3	Yes; Class 3C4 (RH < 75%) incl. salt spray according to EN 60068-2-52 (degree of severity 3). The supplied connector covers must remain on the unused interfaces during operation!
- against mechanically active substances / conformity with EN 60721-3-3	Yes; Class 3S4 incl. sand, dust. The supplied connector covers must remain on the unused interfaces during operation!

LOGO! logic modules

LOGO! modular

SIPLUS LOGO! modular expansion modules

Technical specifications (continued)

Article number	6AG1055-1MM00-7BA2	Article number	6AG1055-1MM00-7BA2
Based on	6ED1055-1MM00-0BA2 SIPLUS LOGO! AM2 AQ V8	Based on	6ED1055-1MM00-0BA2 SIPLUS LOGO! AM2 AQ V8
Ambient conditions		Resistance	
Ambient temperature during operation		- against biologically active substances / conformity with EN 60721-3-3	Yes; Class 3B2 mold, fungus and dry rot spores (with the exception of fauna). The supplied connector covers must remain on the unused interfaces during operation!
• min.	-40 °C; = Tmin; Startup @ -25 °C	- against chemically active substances / conformity with EN 60721-3-3	Yes; Class 3C4 (RH < 75%) incl. salt spray according to EN 60068-2-52 (degree of severity 3). The supplied connector covers must remain on the unused interfaces during operation!
• max.	70 °C; = Tmax	- against mechanically active substances / conformity with EN 60721-3-3	Yes; Class 3S4 incl. sand, dust. The supplied connector covers must remain on the unused interfaces during operation!
Ambient temperature during storage/transportation			
• min.	-40 °C		
• max.	70 °C		
Extended ambient conditions			
• relative to ambient temperature-atmospheric pressure-installation altitude	Tmin ... Tmax at 1080 hPa ... 795 hPa (-1000 m ... +2000 m) // Tmin ... (Tmax - 10K) at 795 hPa ... 658 hPa (+2000 m ... +3500 m) // Tmin ... (Tmax - 20K) at 658 hPa ... 540 hPa (+3500 m ... +5000 m)		
• At cold restart, min.	-25 °C		
Relative humidity			
- With condensation, tested in accordance with IEC 60068-2-38, max.	100 %; RH incl. condensation / frost (no commissioning in bedewed state), horizontal installation		

Article number	6AG1055-1CB00-2BY0	6AG1055-1PB00-2BY0	6AG1055-1HB00-2BY0	6AG1055-1MB00-2BY1
Based on	6ED1055-1CB00-0BA0 SIPLUS LOGO! DM8 24	6ED1055-1CB00-0BA0 SIPLUS LOGO! DM8 12/24	6ED1055-1HB00-0BA0 SIPLUS LOGO! DM8 24R	6ED1055-1MB00-0BA1 SIPLUS LOGO! DM8 12/24R
Ambient conditions				
Ambient temperature during operation				
• min.	-40 °C; = Tmin	-40 °C; = Tmin	-40 °C; = Tmin	-40 °C; = Tmin
• max.	70 °C; = Tmax; 55 °C @ UL/cUL use	70 °C; = Tmax; 55 °C @ UL/cUL use	70 °C; = Tmax; 55 °C @ UL/cUL use	70 °C; = Tmax; 55 °C @ UL/cUL use
Extended ambient conditions				
• relative to ambient temperature-atmospheric pressure-installation altitude	Tmin ... Tmax at 1080 hPa ... 795 hPa (-1000 m ... +2000 m) // Tmin ... (Tmax - 10K) at 795 hPa ... 658 hPa (+2000 m ... +3500 m) // Tmin ... (Tmax - 20K) at 658 hPa ... 540 hPa (+3500 m ... +5000 m)	Tmin ... Tmax at 1080 hPa ... 795 hPa (-1000 m ... +2000 m) // Tmin ... (Tmax - 10K) at 795 hPa ... 658 hPa (+2000 m ... +3500 m) // Tmin ... (Tmax - 20K) at 658 hPa ... 540 hPa (+3500 m ... +5000 m)	Tmin ... Tmax at 1080 hPa ... 795 hPa (-1000 m ... +2000 m) // Tmin ... (Tmax - 10K) at 795 hPa ... 658 hPa (+2000 m ... +3500 m) // Tmin ... (Tmax - 20K) at 658 hPa ... 540 hPa (+3500 m ... +5000 m)	Tmin ... Tmax at 1080 hPa ... 795 hPa (-1000 m ... +2000 m) // Tmin ... (Tmax - 10K) at 795 hPa ... 658 hPa (+2000 m ... +3500 m) // Tmin ... (Tmax - 20K) at 658 hPa ... 540 hPa (+3500 m ... +5000 m)
Relative humidity				
- With condensation, tested in accordance with IEC 60068-2-38, max.	100 %; Relative humidity, incl. condensation / frost permitted (no commissioning under condensation conditions)	100 %; Relative humidity, incl. condensation / frost permitted (no commissioning under condensation conditions)	100 %; Relative humidity, incl. condensation / frost permitted (no commissioning under condensation conditions)	100 %; Relative humidity, incl. condensation / frost permitted (no commissioning under condensation conditions)
Resistance				
- against biologically active substances / conformity with EN 60721-3-3	Yes; Class 3B2 mold, fungus and dry rot spores (with the exception of fauna). The supplied connector covers must remain on the unused interfaces during operation!	Yes; Class 3B2 mold, fungus and dry rot spores (with the exception of fauna). The supplied connector covers must remain on the unused interfaces during operation!	Yes; Class 3B2 mold, fungus and dry rot spores (with the exception of fauna). The supplied connector covers must remain on the unused interfaces during operation!	Yes; Class 3B2 mold, fungus and dry rot spores (with the exception of fauna). The supplied connector covers must remain on the unused interfaces during operation!
- against chemically active substances / conformity with EN 60721-3-3	Yes; Class 3C4 incl. salt spray. The supplied connector covers must remain on the unused interfaces during operation!	Yes; Class 3C4 incl. salt spray. The supplied connector covers must remain on the unused interfaces during operation!	Yes; Class 3C4 incl. salt spray. The supplied connector covers must remain on the unused interfaces during operation!	Yes; Class 3C4 incl. salt spray. The supplied connector covers must remain on the unused interfaces during operation!
- against mechanically active substances / conformity with EN 60721-3-3	Yes; Class 3S4 incl. sand, dust. The supplied connector covers must remain on the unused interfaces during operation!	Yes; Class 3S4 incl. sand, dust. The supplied connector covers must remain on the unused interfaces during operation!	Yes; Class 3S4 incl. sand, dust. The supplied connector covers must remain on the unused interfaces during operation!	Yes; Class 3S4 incl. sand, dust. The supplied connector covers must remain on the unused interfaces during operation!

Technical specifications (continued)

Article number	6AG1055-1FB00-2BY1	6AG1055-1NB10-2BA0
Based on	6ED1055-1FB00-0BA1 SIPLUS LOGO! DM8 230R	6ED1055-1NB10-0BA0 SIPLUS LOGO! DM16 24R EXP. MODULE
Ambient conditions		
Ambient temperature during operation		
• min.	-40 °C; = Tmin	-25 °C; = Tmin
• max.	70 °C; = Tmax; 55 °C @ UL/cUL use	70 °C; = Tmax; 55 °C @ UL/cUL use
Extended ambient conditions		
• relative to ambient temperature-atmospheric pressure-installation altitude	Tmin ... Tmax at 1080 hPa ... 795 hPa (-1000 m ... +2000 m)	Tmin ... Tmax at 1080 hPa ... 795 hPa (-1000 m ... +2000 m) // Tmin ... (Tmax - 10K) at 795 hPa ... 658 hPa (+2000 m ... +3500 m) // Tmin ... (Tmax - 20K) at 658 hPa ... 540 hPa (+3500 m ... +5000 m)
Relative humidity		
- With condensation, tested in accordance with IEC 60068-2-38, max.	100 %; Relative humidity, incl. condensation / frost permitted (no commissioning under condensation conditions)	100 %; Relative humidity, incl. condensation / frost permitted (no commissioning under condensation conditions)
Resistance		
- against biologically active substances / conformity with EN 60721-3-3	Yes; Class 3B2 mold, fungus and dry rot spores (with the exception of fauna). The supplied connector covers must remain on the unused interfaces during operation!	Yes; Class 3B2 mold, fungus and dry rot spores (with the exception of fauna). The supplied connector covers must remain on the unused interfaces during operation!
- against chemically active substances / conformity with EN 60721-3-3	Yes; Class 3C4 incl. salt spray. The supplied connector covers must remain on the unused interfaces during operation!	Yes; Class 3C4 incl. salt spray. The supplied connector covers must remain on the unused interfaces during operation!
- against mechanically active substances / conformity with EN 60721-3-3	Yes; Class 3S4 incl. sand, dust. The supplied connector covers must remain on the unused interfaces during operation!	Yes; Class 3S4 incl. sand, dust. The supplied connector covers must remain on the unused interfaces during operation!

Article number	6AG1055-1MA00-2BY0
Based on	6ED1055-1MA00-0BA0 SIPLUS LOGO! AM2
Ambient conditions	
Ambient temperature during operation	
• min.	-40 °C; = Tmin
• max.	70 °C; = Tmax; 55 °C @ UL/cUL use
Extended ambient conditions	
• relative to ambient temperature-atmospheric pressure-installation altitude	Tmin ... Tmax at 1080 hPa ... 795 hPa (-1000 m ... +2000 m) // Tmin ... (Tmax - 10K) at 795 hPa ... 658 hPa (+2000 m ... +3500 m) // Tmin ... (Tmax - 20K) at 658 hPa ... 540 hPa (+3500 m ... +5000 m)
Relative humidity	
- With condensation, tested in accordance with IEC 60068-2-38, max.	100 %; Relative humidity, incl. condensation / frost permitted (no commissioning under condensation conditions)
Resistance	
- against biologically active substances / conformity with EN 60721-3-3	Yes; Class 3B2 mold, fungus and dry rot spores (with the exception of fauna). The supplied connector covers must remain on the unused interfaces during operation!
- against chemically active substances / conformity with EN 60721-3-3	Yes; Class 3C4 incl. salt spray. The supplied connector covers must remain on the unused interfaces during operation!
- against mechanically active substances / conformity with EN 60721-3-3	Yes; Class 3S4 incl. sand, dust. The supplied connector covers must remain on the unused interfaces during operation!

Article number	6AG1055-1MM00-2BY1
Based on	6ED1055-1MM00-0BA1 SIPLUS_LOGO!_AM2_AQ
Ambient conditions	
Ambient temperature during operation	
• min.	-40 °C; = Tmin
• max.	70 °C; = Tmax; 55 °C @ UL/cUL use
Extended ambient conditions	
• relative to ambient temperature-atmospheric pressure-installation altitude	Tmin ... Tmax at 1080 hPa ... 795 hPa (-1000 m ... +2000 m) // Tmin ... (Tmax - 10K) at 795 hPa ... 658 hPa (+2000 m ... +3500 m) // Tmin ... (Tmax - 20K) at 658 hPa ... 540 hPa (+3500 m ... +5000 m)
Relative humidity	
- With condensation, tested in accordance with IEC 60068-2-38, max.	100 %; Relative humidity, incl. condensation / frost permitted (no commissioning under condensation conditions)
Resistance	
- against biologically active substances / conformity with EN 60721-3-3	Yes; Class 3B2 mold, fungus and dry rot spores (with the exception of fauna). The supplied connector covers must remain on the unused interfaces during operation!
- against chemically active substances / conformity with EN 60721-3-3	Yes; Class 3C4 incl. salt spray. The supplied connector covers must remain on the unused interfaces during operation!
- against mechanically active substances / conformity with EN 60721-3-3	Yes; Class 3S4 incl. sand, dust. The supplied connector covers must remain on the unused interfaces during operation!

LOGO! logic modules

LOGO! modular

SIPLUS LOGO! modular expansion modules

2

Odering data	Article No.		Article No.
SIPLUS LOGO! 8 expansion modules			
SIPLUS LOGO! DM8 24 Supply voltage 24 V DC, 4 digital inputs 24 V DC, 4 digital outputs 24 V DC, 0.3 A Extended temperature range and exposure to media	6AG1055-1CB00-7BA2		
SIPLUS LOGO! DM8 230R Supply voltage 115...230 V AC/DC, 4 digital inputs 115...230 V AC/DC, 4 relay outputs 5 A Extended temperature range and exposure to media	6AG1055-1FB00-7BA2		
SIPLUS LOGO! DM8 24R Supply voltage 24 V AC/DC, 4 digital inputs 24 V AC/DC, 4 relay outputs 5 A Extended temperature range and exposure to media	6AG1055-1HB00-7BA2		
SIPLUS LOGO! AM2 Supply voltage 12...24 V DC, 2 analog inputs 0 to 10 V or 0 to 20 mA, resolution 10 bit Extended temperature range and exposure to media	6AG1055-1MA00-7BA2		
SIPLUS LOGO! DM8 12/24R Supply voltage 12...24 V DC, 4 digital inputs 12...24 V DC, 4 relay outputs 5 A Extended temperature range and exposure to media	6AG1055-1MB00-7BA2		
SIPLUS LOGO! AM2 AQ Supply voltage 24 V DC, 2 analog outputs 0 to 10 V, 0/4 to 20 mA Extended temperature range and exposure to media	6AG1055-1MM00-7BA2		
SIPLUS LOGO! DM16 24R Supply voltage 24 V DC, 8 digital inputs 24 V DC, 8 relay outputs 5 A Extended temperature range and exposure to media	6AG1055-1NB10-7BA2		
SIPLUS LOGO! 6 expansion modules			
SIPLUS LOGO! DM8 24 Supply voltage 24 V DC, 4 digital inputs 24 V DC, 4 digital outputs 24 V DC, 0.3 A Extended temperature range and exposure to media	6AG1055-1CB00-2BY0		
SIPLUS LOGO! DM8 230R Supply voltage 115/230 V AC/DC, 4 digital inputs 115/230 V AC/DC, 4 relay outputs 5 A Extended temperature range and exposure to media	6AG1055-1FB00-2BY1		
SIPLUS LOGO! DM8 24R Supply voltage 24 V AC/DC, 4 digital inputs 24 V AC/DC, 4 relay outputs 5 A Extended temperature range and exposure to media	6AG1055-1HB00-2BY0		
SIPLUS LOGO! AM2 Supply voltage 12/24 V DC, 2 analog inputs 0 ... 10 V or 0 ... 20 mA, 10-bit resolution Extended temperature range and exposure to media	6AG1055-1MA00-2BY0		
SIPLUS LOGO! DM8 12/24R Supply voltage 12/24 V DC, 4 digital inputs 12/24 V DC, 4 relay outputs 5 A Extended temperature range and exposure to media	6AG1055-1MB00-2BY1		
SIPLUS LOGO! AM2 AQ Supply voltage 24 V DC, 2 analog inputs 0 ... 10 V, 0/4 ... 20 mA, 10-bit resolution Extended temperature range and exposure to media	6AG1055-1MM00-2BY1		
SIPLUS LOGO! DM16 24R Supply voltage 24 V DC, 8 digital outputs 24 V DC, 8 relay outputs 5 A Extended temperature range and exposure to media	6AG1055-1NB10-2BA0		
SIPLUS LOGO! DM8 12/24 Supply voltage 12/24 V DC, 4 digital inputs 12/24 V DC, 4 digital outputs 24 V DC, 0.3 A Extended temperature range and exposure to media	6AG1055-1PB00-2BY0		
SIPLUS LOGO! 6, 8 accessories			
LOGO!Soft Comfort V8			6ED1058-0BA08-0YA1
For programming on the PC in LAD/FBD; executes on Windows 8, 7, XP, Linux and Mac OSX; on DVD			
Front panel mounting set			
Width 4 U			6AG1057-1AA00-0AA0
Width 8 U			6AG1057-1AA00-0AA1
Width 8 U, with keys			6AG1057-1AA00-0AA2
SIPLUS LOGO! 6 accessories			
SIPLUS LOGO! TD text display			6AG1055-4MH00-2BA0
(Extended temperature range -10 ... +60 °C and exposure to media)			
4-line text display, can be connected to all LOGO! basic and pure variants as of -0BA6, including connecting cable			

Overview



- Communication modules for connecting LOGO! Modular to different bus systems.

Note on compatibility:

Communication module	Can be used with:
LOGO! CM EIB/KNX communication module	LOGO! to ...0BA7
LOGO! CMK2000 communication module	LOGO! ...0BA8
LOGO! CSM 12/24	LOGO! ...0BA7/...0BA8
LOGO! CSM 230	LOGO! ...0BA7
LOGO! CMR2020	LOGO! ...0BA8
LOGO! CMR2040	LOGO! ...0BA8
AS-Interface connection for LOGO!	LOGO! to ...0BA7

LOGO! logic modules

LOGO! modular communication modules

LOGO! CMK2000 communication modules

Overview



- Expansion module for LOGO! 8 basic variants
- For integrating LOGO! 8 in KNX installations
- With 24 digital inputs, 20 digital outputs as well as 8 analog inputs and outputs for processing process signals via KNX.

Technical specifications

Article number	6BK1700-0BA20-0AA0 LOGO! CMK2000
General information	
Firmware version	
• FW update possible	Yes
Installation type/mounting	
Mounting	on 35 mm DIN rail, 4 spacing units wide
Supply voltage	
Rated value (DC)	24 V
• 12 V DC	No
• 24 V DC	Yes
permissible range, lower limit (DC)	19.2 V
permissible range, upper limit (DC)	28.8 V
Rated value (AC)	
• 24 V AC	No
Input current	
Current consumption, max.	0.04 A
Power loss	
Power loss, max.	1.1 W
Memory	
Flash	Yes
Time of day	
Clock synchronization	
• supported	Yes
Interfaces	
Number of industrial Ethernet interfaces	1; Ethernet, 1 port, RJ45
Number of other interfaces	1; EIB/KNX
Transmission rate, max.	100 Mbit/s over Ethernet, 9 600 bit/s over KNX
Protocols	
EIB/KNX	Yes

Article number	6BK1700-0BA20-0AA0 LOGO! CMK2000
Communication functions	
Web server	
• supported	Yes
Interrupts/diagnostics/status information	
Diagnostics indication LED	
• RUN/STOP LED	Yes
EMC	
Emission of radio interference acc. to EN 55 011	
• Limit class B, for use in residential areas	Yes; In accordance with EN 61000-6-3
Degree and class of protection	
Degree of protection acc. to EN 60529	
• IP20	Yes
Standards, approvals, certificates	
CE mark	Yes
CSA approval	Yes
UL approval	Yes
cULus	Yes
FM approval	No
RCM (formerly C-TICK)	No
KC approval	Yes
EAC (formerly Gost-R)	Yes
according to VDE 0631	No
Marine approval	
• Marine approval	No
Ambient conditions	
Ambient temperature during operation	
• min.	0 °C
• max.	55 °C
Ambient temperature during storage/transportation	
• min.	-40 °C
• max.	70 °C
Relative humidity	
• Operation, max.	95 %
Connection method	
Design of plug-in connection	KNX terminal 0.6 mm ² - 1.0 mm ²
Power supply	2 screw-type terminals: L+, M 0.5 mm ² - 2.5 mm ² Screw-type terminal: FE 0.5 mm ² ... 6.0 mm ²
Dimensions	
Width	71.5 mm; 4 WU
Height	90 mm
Depth	58.5 mm
Weights	
Weight, approx.	0.14 kg

Ordering data

Article No.

LOGO! CMK2000 communication module

6BK1700-0BA20-0AA0

For integrating LOGO! 8 in the KNX building system bus, max. 50 communication objects can be configured;
RJ45 port for Ethernet; supply voltage 24 V DC/40 mA

Overview



The module is used to connect a LOGO! and up to three other nodes to an Industrial Ethernet network with 10/100 Mbit/s in an electrical linear, tree or star topology.

The essential features of the LOGO! CSM are:

- Unmanaged 4-port switch, of which one port is on the front for easy diagnostics access
- Two versions for the voltage ranges 12/24 V DC or 230 V AC/DC
- Problem-free connection using four RJ45 standard connectors
- Space-saving, optimized for connection to LOGO!
- Low-cost solution for implementing small, local Ethernet networks
- Stand-alone use for networking any Ethernet devices

2

Technical specifications

Order number	6GK7177-1FA10-0AA0	6GK7177-1MA20-0AA0
Product type designation	LOGO! CSM 230	LOGO! CSM 12/24
Transmission rate		
Transfer rate	10 Mbit/s, 100 Mbit/s	10 Mbit/s, 100 Mbit/s
Interfaces for communication integrated		
Number of electrical connections • for network components or terminal equipment	4	4
Number of 100 Mbit/s SC ports • for multimode	0	0
Number of 1000 Mbit/s LC ports • for multimode • for single mode (LD)	0 0	0 0
Interfaces others		
Number of electrical connections • for power supply	1	1
Type of electrical connection • for power supply	3-pole terminal block	3-pole terminal block
Supply voltage, current consumption, power loss		
Type of voltage of the supply voltage	115...240 V AC/DC	12/24 V DC
Supply voltage • external	230 V	24 V
• external	100 ... 240 V	10.2 ... 30.2 V
Product component fusing at power supply input	Yes	Yes
Consumed current maximum	0.02 A	0.15 A
Power loss [W] • at DC at 24 V • at AC at 230 V	1.8 W	1.5 W
Permitted ambient conditions		
Ambient temperature • during operation • during storage • during transport	0 ... 55 °C -40 ... +70 °C -40 ... +70 °C	0 ... 55 °C -40 ... +70 °C -40 ... +70 °C
Relative humidity • at 25 °C without condensation during operation maximum	90 %	90 %
Protection class IP	IP20	IP20

LOGO! logic modules

LOGO! modular communication modules

LOGO ! CSM unmanaged**Technical specifications** (continued)

Order number	6GK7177-1FA10-0AA0	6GK7177-1MA20-0AA0
Product type designation	LOGO! CSM 230	LOGO! CSM 12/24
Design, dimensions and weight		
Design	LOGO! module	LOGO! module
Width	72 mm	71.5 mm
Height	90 mm	90 mm
Depth	55 mm	58.2 mm
Net weight	0.155 kg	0.15 kg
Mounting type		
• 35 mm DIN rail mounting	Yes	Yes
• wall mounting	Yes	Yes
• S7-300 rail mounting	No	No
• S7-1500 rail mounting	No	No
Product functions management, configuration		
Product function		
• multiport mirroring	No	No
• switch-managed	No	No
Standards, specifications, approvals		
Standard		
• for hazardous zone	no	ATEX: EN 60079-0 : 2009, EN 60079-15 :2010 (Directive 94/9/EC), IECEx: IEC 60079-0 :2011, IEC 60079-15 :2010
• for safety from CSA and UL	UL60079-0, UL60079-15, CSA C22.2	UL 508, CSA C22.2 No. 142
• for hazardous zone from CSA and UL		Haz-Loc ANSI/ISA 12.12.01: CL, I, Div2, Group A,B,C,D T4, CL I, Zone 2, Group IIC, T4, Ta=55°C
Certificate of suitability CE marking	Yes	Yes
Certificate of suitability		
• C-Tick	Yes	Yes
• KC approval	No	No
Marine classification association		
• American Bureau of Shipping Europe Ltd. (ABS)	No	No
• Bureau Veritas (BV)	No	No
• Det Norske Veritas (DNV)	No	No
• Germanische Lloyd (GL)	No	No
• Lloyds Register of Shipping (LRS)	No	No
• Nippon Kaiji Kyokai (NK)	No	No
• Polski Rejestr Statkow (PRS)	No	No

Ordering data**Article No.****Article No.****LOGO! CSM compact switch modules**

Unmanaged switch for connection of one LOGO! and up to three further nodes on Industrial Ethernet with 10/100 Mbps; 4 x RJ45 ports; LED diagnostics, LOGO! module

- **LOGO! CSM 12/24**
external 12 V DC or 24 V DC power supply, for LOGO! ... 0BA7/... 0BA8
- **LOGO! CSM 230**
external 115 ... 240 V AC power supply, for LOGO! ... 0BA7

6GK7177-1MA20-0AA0**6GK7177-1FA10-0AA0****Accessories****IE TP Cord RJ45/RJ45**

TP cable 4 x 2 with 2 RJ45 plugs

- 0.5 m
- 1 m
- 2 m
- 6 m
- 10 m

6XV1870-3QE50
6XV1870-3QH10
6XV1870-3QH20
6XV1870-3QH60
6XV1870-3QN10

IE FC outlet RJ45

For connection of Industrial Ethernet FC cables and TP Cords; graded prices from 10 and 50 units

6GK1901-1FC00-0AA0

Overview



LOGO! CMR in combination with the LOGO! logic module is a cost-efficient communication system suitable for monitoring and controlling distributed plants and systems via text message or email.

LOGO! CMR can send text messages or emails to predefined mobile network numbers as well as receive text messages from predefined mobile network numbers.

Sending a text message/email can be initiated by events in the LOGO! basic module as well as by the two digital alarm inputs of the LOGO! CMR. The values in the LOGO! logic module can be directly influenced by receiving a text message.

The LOGO! CMR offers comfortable Web Based Management commissioning and diagnostics via local and/or remote access.

The two digital outputs can also be switched remotely by incoming text messages/emails.

LOGO! CMR determines the current position of the module based on the GPS signal received by the GPS antenna. In addition, the LOGO! 8 logic module can be time-synchronized by means of the time included in the GPS signal. Determination of time by means of an NTP server or from the data of the mobile network provider offers more options for synchronization of the LOGO! BM with the current time of day.

Product version:

- LOGO! CMR2020 for use in GSM/GPRS mobile wireless networks
- LOGO! CMR2040 for use in in LTE mobile wireless networks

Warning! The country-specific mobile network approvals must be observed:

DE: <http://www.siemens.de/mobilfunkzulassungen>

EN: <http://www.siemens.com/mobilenetwork-approvals>

Technical specifications

Order number	6GK7142-7BX00-0AX0	6GK7142-7EX00-0AX0
Product type designation	LOGO! CMR2020	LOGO! CMR2040
Transmission rate		
Transfer rate		
• at the 1st interface	10 ... 100 Mbit/s	10 ... 100 Mbit/s
• for GPRS transmission		
- with downlink maximum	80 kbit/s	85.6 kbit/s
- with uplink maximum	40 kbit/s	85.6 kbit/s
• for LTE transmission		
- with downlink maximum		100 Mbit/s
- with uplink maximum		50 Mbit/s
Interfaces		
Number of interfaces acc. to Industrial Ethernet	1	1
Number of electrical connections		
• at the 1st interface acc. to Industrial Ethernet	1	1
• for external antenna(s)	2	2
• for power supply	1	1
Number of slots		
• for SIM cards	1	1
• for memory cards	1	1
Type of electrical connection		
• at the 1st interface acc. to Industrial Ethernet	RJ45 port	RJ45 port
• for external antenna(s)	SMA socket (50 ohms)	SMA socket (50 ohms)
• for power supply	3-pole terminal block	3-pole terminal block
Type of antenna		
• at port 1 connectable	GPS Antenna	GPS Antenna
• at port 2 connectable	Mobile radio antenna (GPRS/GSM)	Mobile radio antenna (GPRS/GSM, UMTS, LTE)
Wire length of antenna cable maximum	15 m	15 m

LOGO! logic modules

LOGO! modular communication modules

LOGO! CMR (wireless communication)**Technical specifications (continued)**

	6GK7142-7BX00-0AX0	6GK7142-7EX00-0AX0
Order number	LOGO! CMR2020	LOGO! CMR2040
Product type designation		
Slot version		
<ul style="list-style-type: none"> • for SIM card • of the memory card 	Standard microSD	Standard microSD
Storage capacity of the memory card maximum	32 Gbyte	32 Gbyte
Performance class of the memory card minimum necessary	Class 6	Class 6
Type of file system	FAT32	FAT32
Signal-Inputs/outputs		
Number of electrical connections for digital input signals	2	2
Type of electrical connection for digital input signals	3 pole terminal block	3 pole terminal block
Digital input version	not potential separated	not potential separated
Input voltage at digital input		
<ul style="list-style-type: none"> • with signal <0> at DC • for signal <1> at DC 	0 ... 5 V 8.5 ... 24 V	0 ... 5 V 8.5 ... 24 V
Input current at digital input for signal <1> maximum	5.5 mA	5.5 mA
Number of electrical connections for digital output signals	2	2
Type of electrical connection for digital output signals	3 pole terminal block	3 pole terminal block
Digital output version	transistor, not potential separated	transistor, not potential separated
Output voltage at digital output		
<ul style="list-style-type: none"> • for signal <1> • for signal <0> 	12 ... 24 V; Value of the actual supply voltage 0 ... 5 V	12 ... 24 V; Value of the actual supply voltage 0 ... 5 V
Output current at digital output for signal <1> maximum	0.3 A	0.3 A
Wireless technology		
Type of mobile wireless service		
<ul style="list-style-type: none"> • is supported SMS • is supported GPRS • Note 	Yes Yes GPRS (Multislot Class 10, Mobile Station Class B)	Yes Yes LTE
Type of mobile network is supported		
<ul style="list-style-type: none"> • GSM • UMTS • LTE 	Yes No No	Yes Yes Yes
Operating frequency		
<ul style="list-style-type: none"> • for GSM transmission 850 MHz • for GSM transmission 900 MHz • for GSM transmission 1800 MHz • for GSM transmission 1900 MHz • with UMTS transmission 850 MHz • with UMTS transmission 900 MHz • with UMTS transmission 2100 MHz • for LTE transmission 800 MHz • for LTE transmission 1800 MHz • for LTE transmission 2600 MHz 	Yes Yes Yes Yes No No No No No No No	No Yes Yes No Yes Yes Yes Yes Yes Yes Yes

Technical specifications (continued)

Order number	6GK7142-7BX00-0AX0	6GK7142-7EX00-0AX0
Product type designation	LOGO! CMR2020	LOGO! CMR2040
Supply voltage, current consumption, power loss		
Type of voltage of the supply voltage	DC	DC
Supply voltage external	12 ... 24 V	12 ... 24 V
Supply voltage external at DC Rated value	12 ... 24 V	12 ... 24 V
Supply voltage for GPS antenna maximum	3.8 V; at 5 mA: 3,575 V / at 10 mA: 3,35 V / at 15 mA: 3,125 V	3.8 V; at 5 mA: 3,575 V / at 10 mA: 3,35 V / at 15 mA: 3,125 V
Relative positive tolerance at DC at 24 V	20 %	20 %
Relative negative tolerance at DC at 12 V	10 %	10 %
Consumed current		
• from external supply voltage at DC at 12 V maximum	0.25 A	0.25 A
• from external supply voltage at DC at 24 V maximum	0.125 A	0.125 A
Output current for GPS antenna maximum	15 mA	15 mA
Power loss [W]	3 W	3 W
Permitted ambient conditions		
Ambient temperature		
• during operation	-20 ... +70 °C	-20 ... +70 °C
• during storage	-40 ... +85 °C	-40 ... +85 °C
• during transport	-40 ... +85 °C	-40 ... +85 °C
Relative humidity at 25 °C without condensation during operation maximum	95 %	95 %
Protection class IP	IP20	IP20
Design, dimensions and weight		
Module format	Compact module, for rail mounting	Compact module, for rail mounting
Width	71.5 mm	71.5 mm
Height	90 mm	90 mm
Depth	58.2 mm	58.2 mm
Net weight	0.16 kg	0.16 kg
Mounting type		
• 35 mm DIN rail mounting	Yes	Yes
• wall mounting	Yes	Yes
Product properties, functions, components general		
Product function		
• DynDNS client	Yes	Yes
• no-ip.com client	Yes	Yes
Performance data		
Number of possible connections to the LOGO! logic module	1	1
Number of user groups definable maximum	10	10
Number of signals for monitoring or device control definable maximum	32	32
Number of events for monitoring definable maximum	32	32
number of actions definable maximum	32	32
Number of relations definable maximum	32	32
Number of alias-SMS-command definable maximum	20	20
Number of constants definable maximum	32	32

LOGO! logic modules

LOGO! modular communication modules

LOGO! CMR (wireless communication)**Technical specifications** (continued)

Order number	6GK7142-7BX00-0AX0	6GK7142-7EX00-0AX0
Product type designation	LOGO! CMR2020	LOGO! CMR2040
Performance data IT functions		
Number of possible connections		
• as server by means of HTTP maximum	2	2
• as server by HTTPS maximum	2	2
• as e-mail client maximum	1	1
Number of free texts for e-mails definable by user	20; maximum of 160 characters per user defined text	20; maximum of 160 characters per user defined text
Performance data Teleservice		
Product function		
• Remote firmware update	Yes	Yes
Configuration software		
• required	No, configuration by using the integrated webserver	No, configuration by using the integrated webserver
Product functions Diagnosis		
Product function Web-based diagnostics	Yes	Yes
Product functions Security		
Suitability for operation Virtual Private Network	Yes	Yes
Type of authentication with Virtual Private Network PSK	Yes	Yes
Number of possible connections with VPN connection	1	1
Product function		
• password protection for Web applications	Yes	Yes
• password protection for VPN	Yes	Yes
• encrypted data transmission	Yes	Yes
• switch-off of non-required services	Yes	Yes
• log file for unauthorized access	Yes	Yes
Product functions Time		
Product function pass on time synchronization	Yes	Yes
Accuracy of the hardware real-time clock per day maximum	7.5 s	7.5 s
time synchronization		
• from NTP-server	Yes	Yes
• from GPS-signal	Yes	Yes
• from mobile network provider	Yes	Yes
• PC	Yes	Yes
Product functions Position recognition		
Product function position detection with GPS	Yes	Yes

Ordering data	Article No.	Article No.
Communication Module Radio LOGO! CMR Communication modules for connection of LOGO! 0BA8 to GSM/GPRS or LTE network; 1x RJ45 port for Industrial Ethernet connection; 2x digital input; 2x digital output; read/write access to LOGO! tags; possible to send/receive text messages; GPS position detection; time-of-day synchronization/forwarding with real time clock; configuration and diagnostics per web interface; Note country approvals: www.siemens.com/mobilenetwork-approvals		
LOGO! CMR2020 For connecting LOGO! 0BA8 to a GSM/GPRS network	6GK7142-7BX00-0AX0	
LOGO! CMR2040 For connecting LOGO! 0BA8 to an LTE network	6GK7142-7EX00-0AX0	
Accessories		
Mobile radio antennas		
ANT794-4MR For indoor and outdoor use; 5 m connecting cable permanently connected to antenna; SMA connector; incl. installation bracket, screws, wall plugs	6NH9860-1AA00	
ANT896-4MA Rod antenna for direct mounting on device; SMA male connector	6GK5896-4MA00-0AA3	
ANT896-4ME Cylinder-shaped antenna for remote installation, e.g. on a control cabinet; N-Connect female connector	6GK5896-4ME00-0AA0	
GPS antenna		
ANT895-6ML GPS/Glonass antenna for remote installation indoor and outdoor, magnet or screw mounting, 30 cm cable with N-Connect female connector	6GK5895-6ML00-0AA0	
Antenna adapter cable N-Connect/SMA male/male flexible connection cable, pre-assembled, connection cable; suitable for 0 ... 6 GHz, IP68 <ul style="list-style-type: none"> • 0.3 m • 1 m • 2 m • 5 m 	6XV1875-5LE30 6XV1875-5LH10 6XV1875-5LH20 6XV1875-5LH50	
		IWLAN RCoax/ antenna N-Connect male/male flexible connection cable Flexible connecting cable for connecting an RCoax cable or antenna to a SCALANCE W-700 access point with N-Connect connections; pre-assembled with two N-Connect male connections; suitable from 0 ... 6 GHz, IP68 <ul style="list-style-type: none"> • 1 m • 2 m • 5 m • 10 m
		Cabinet feed-through IWLAN RCOAX N-Connect/ N-Connect female/female panel feed-through; control cabinet feed-through for wall thickness max. 4.5 mm; 2.4 GHz and 5 GHz, suitable for 0 ... 6 GHz, IP67
		Lightning protector LP798-2N Lightning protector with N/N female/ female connection for ANT 790 antennas, IP67 (-40 to +85 °C), frequency range: 0 ... 6 GHz
		Patch cable IE TP Cord RJ45/RJ45 TP cable 4 x 2 with 2 RJ45 plugs <ul style="list-style-type: none"> • 0.5 m • 1 m • 2 m • 6 m • 10 m
		IE FC outlet RJ45 For connection of Industrial Ethernet FC cables and TP Cords; graduated prices for 10 and 50 units or more
		LOGO! CSM12/24 Compact switch module for connecting a LOGO! (...0BA7/ ...0BA8) and up to 3 further nodes to Industrial Ethernet; Power supply 12/24 V DC
		LOGO! CSM230 Compact switch module for connecting a LOGO! (...0BA7) and up to 3 further nodes to Industrial Ethernet; Power supply 115 ... 240 V AC/DC
		6XV1875-5AH10 6XV1875-5AH20 6XV1875-5AH50 6XV1875-5AN10
		6GK5798-2PP00-2AA6
		6GK5798-2LP00-2AA6
		6XV1870-3QE50 6XV1870-3QH10 6XV1870-3QH20 6XV1870-3QH60 6XV1870-3QN10
		6GK1901-1FC00-0AA0
		6GK7177-1MA20-0AA0
		6GK7177-1FA10-0AA0

LOGO! logic modules

LOGO!Power

Introduction

Overview

2



The flat power supply unit for distribution boards

Small. Clever. LOGO!Power

Thanks to its stepped profile design, the LOGO!Power product family in the LOGO! 8 design is ideally suited for installation in miniature distribution boards. The stabilized power supplies with a wide range input of 100 ... 240 V AC (85 ... 264 V) and 110 ... 300 V DC are available in two performance classes with an output voltage of 5 V and 15 V, in three performance classes with 12 V and in four performance classes with 24 V. The 12 V and 24 V versions are ideal for supplying LOGO! controllers with the corresponding voltage input. The high level of efficiency across the entire load range as well as the low no-load losses result in lower overall energy consumption. Greater convenience when commissioning and servicing thanks to the integrated current monitor. The extended temperature range from -25 °C to +70 °C enables a host of additional applications.

To further increase 24 V availability, the 24 V LOGO!Power power supply units can be combined with **DC UPS, redundancy and selectivity modules**.

LOGO!Power is the ideal choice when components need to be supplied with DC voltage. It can provide currents up to 4 A. This mini power pack can be used regardless of industry, e.g. in building technology applications for light and heating controllers or for access control systems. LOGO!Power is also well-suited for use in industrial automation, such as in packaging machine, machine tool, conveyor belt or sorting system applications.

Main product highlights

- Low width with minimum of 18 mm to maximum of 72 mm, thus requiring very little space in the control cabinet
- High energy efficiency with efficiency levels of up to 90% over the entire power range and ERP-compliant no-load losses of < 0.3 W
- Global use thanks to extended operating temperature range from -25 °C to +70 °C and international certifications
- Load monitoring thanks to real-time measurement of output current without disconnecting the cable, i.e. without interrupting the DC supply (new)
- Flexible mounting with standard rail or wall mounting in different installation positions
- Wide portfolio with 11 devices with 5 V, 12 V, 15 V and 24 V DC up to 100 watts (new: 12 V/0.9 A and 24 V/0.6 A)
- Flexible deployment on all standard 1-phase supply networks thanks to wide range input of 100-240 V AC without switchover and operation on DC networks with 110-300 V DC
- Reliable thanks to problem-free connection of loads with high inrush currents thanks to power reserve when starting up as well as constant current in the event of overload

Overall width	18 mm	36 mm	54 mm	72 mm
24 V	0.6 A	1.3 A	2.5 A	4.0 A
12 V	0.9 A	1.9 A	4.5 A	
5 V		3.0 A	6.3 A	
15 V		1.9 A	4.0 A	

Overview



Thanks to its stepped profile design, the LOGO!Power product family is ideally suited for installation in miniature distribution boards. The stabilized power supplies with a wide range input of 100 ... 240 V AC (85 ... 264 V) and 110 ... 300 V DC are available

with an output voltage of 5 V in two performance classes. The high level of efficiency across the entire load range as well as the low no-load losses result in lower overall energy consumption. Greater convenience when commissioning and servicing thanks to the integrated current monitor. The extended temperature range from -25 °C to +70 °C enables a host of additional applications.

Main product highlights

- 5 V DC/ 3.0 A and 6.3 A
- Narrow unit with 36 mm or 54 mm width and overall depth of 53 mm in LOGO! design
- Flexible mounting: standard rail or wall mounting in a range of installation positions
- Higher energy efficiency: high efficiency levels over the entire load range as well as no-load power losses of < 0.3 W
- Integrated current monitor: actual output current measurement directly at the power supply unit
- Global use: operating temperature range from -25 °C to +70 °C as well as international certifications such as UL, CSA, FM or ATEX

Technical specifications

Article number	6EP3310-6SB00-0AY0	6EP3311-6SB00-0AY0
Product	LOGO!Power	LOGO!Power
Power supply, type	5 V/3 A	5 V/6.3 A
Input		
Input	1-phase AC or DC	1-phase AC or DC
Rated voltage value $V_{in \text{ rated}}$	100 ... 240 V	100 ... 240 V
Voltage range AC	85 ... 264 V	85 ... 264 V
Input voltage		
• at DC	110 ... 300 V	110 ... 300 V
Wide-range input	Yes	Yes
Mains buffering at $I_{out \text{ rated, min.}}$	40 ms; at $V_{in} = 187 \text{ V}$	40 ms; at $V_{in} = 187 \text{ V}$
Rated line frequency 1	50 Hz	50 Hz
Rated line frequency 2	60 Hz	60 Hz
Rated line range	47 ... 63 Hz	47 ... 63 Hz
Input current		
• at rated input voltage 120 V	0.36 A	0.71 A
• at rated input voltage 230 V	0.22 A	0.37 A
Switch-on current limiting (+25 °C), max.	26 A	50 A
I^2t , max.	0.8 A ² ·s	3 A ² ·s
Built-in incoming fuse	internal	internal

LOGO! logic modules

LOGO!Power

1-phase, 5 V DC

Technical specifications (continued)

Article number	6EP3310-6SB00-0AY0	6EP3311-6SB00-0AY0
Product	LOGO!Power	LOGO!Power
Power supply, type	5 V/3 A	5 V/6.3 A
Output		
Output	Controlled, isolated DC voltage	Controlled, isolated DC voltage
Rated voltage V_{out} DC	5 V	5 V
Total tolerance, static \pm	3 %	3 %
Static mains compensation, approx.	0.1 %	0.1 %
Static load balancing, approx.	0.1 %	0.1 %
Residual ripple peak-peak, max.	100 mV	100 mV
Residual ripple peak-peak, typ.	30 mV	30 mV
Spikes peak-peak, max. (bandwidth: 20 MHz)	100 mV	100 mV
Spikes peak-peak, typ. (bandwidth: 20 MHz)	50 mV	50 mV
Adjustment range	4.6 ... 5.4 V	4.6 ... 5.4 V
Product function Output voltage adjustable	Yes	Yes
Output voltage setting	via potentiometer	via potentiometer
Status display	Green LED for output voltage OK	Green LED for output voltage OK
On/off behavior	No overshoot of V_{out} (soft start)	No overshoot of V_{out} (soft start)
Startup delay, max.	0.5 s	0.5 s
Voltage rise, typ.	100 ms	100 ms
Rated current value $I_{out\ rated}$	3 A	6.3 A
Current range	0 ... 3 A	0 ... 6.3 A
• Note	+55 ... +70 °C: Derating 2%/K	+55 ... +70 °C: Derating 2%/K
Supplied active power typical	15 W	31.5 W
Parallel switching for enhanced performance	Yes	Yes
Numbers of parallel switchable units for enhanced performance	2	2
Efficiency		
Efficiency at $V_{out\ rated}$, $I_{out\ rated}$, approx.	76 %	80 %
Power loss at $V_{out\ rated}$, $I_{out\ rated}$, approx.	5 W	8 W
Power loss [W] during no-load operation maximum	0.3 W	0.3 W
Closed-loop control		
Dynamic mains compensation ($V_{in\ rated} \pm 15\%$), max.	0.2 %	0.2 %
Dynamic load smoothing (I_{out} : 10/90/10 %), $U_{out} \pm$ typ.	5 %	7 %
Load step setting time 10 to 90%, typ.	1 ms	1 ms
Load step setting time 90 to 10%, typ.	1 ms	1 ms
Protection and monitoring		
Output overvoltage protection	Yes, according to EN 60950-1	Yes, according to EN 60950-1
Current limitation, typ.	3.8 A	8.2 A
Property of the output Short-circuit proof	Yes	Yes
Short-circuit protection	Constant current characteristic	Constant current characteristic
Enduring short circuit current RMS value		
• maximum	3.8 A	8.2 A
Overload/short-circuit indicator	-	-

Technical specifications (continued)

Article number	6EP3310-6SB00-0AY0	6EP3311-6SB00-0AY0
Product	LOGO!Power	LOGO!Power
Power supply, type	5 V/3 A	5 V/6.3 A
Safety		
Primary/secondary isolation	Yes	Yes
Galvanic isolation	Safety extra-low output voltage U_{out} acc. to EN 60950-1 and EN 50178	Safety extra-low output voltage U_{out} acc. to EN 60950-1 and EN 50178
Protection class	Class II (without protective conductor)	Class II (without protective conductor)
CE mark	Yes	Yes
UL/cUL (CSA) approval	cULus-Listed (UL 508, CSA C22.2 No. 107.1), File E197259; cURus-Recognized (UL 60950, CSA C22.2 No. 60950), File E151273, NEC class 2 (acc. to UL 1310)	cULus-listed (UL 508, CSA C22.2 No. 107.1), File E197259; cURus-recognized (UL 60950, CSA C22.2 No. 60950), File E151273
Explosion protection	ATEX (EX) II 3G Ex nA IIC T3; cCSAus (CSA C22.2 No. 213-M1987, ANSI/ISA-12.12.01-2007) Class I, Div. 2, Group ABCD, T4	ATEX (EX) II 3G Ex nA IIC T3; cCSAus (CSA C22.2 No. 213-M1987, ANSI/ISA-12.12.01-2007) Class I, Div. 2, Group ABCD, T4
FM approval	Class I, Div. 2, Group ABCD, T4	Class I, Div. 2, Group ABCD, T4
CB approval	Yes	Yes
Marine approval	GL, ABS	GL, ABS
Degree of protection (EN 60529)	IP20	IP20
EMC		
Emitted interference	EN 55022 Class B	EN 55022 Class B
Supply harmonics limitation	not applicable	not applicable
Noise immunity	EN 61000-6-2	EN 61000-6-2
Operating data		
Ambient temperature		
• during operation	-25 ... +70 °C	-25 ... +70 °C
- Note	with natural convection	with natural convection
• during transport	-40 ... +85 °C	-40 ... +85 °C
• during storage	-40 ... +85 °C	-40 ... +85 °C
Humidity class according to EN 60721	Climate class 3K3, no condensation	Climate class 3K3, no condensation
Mechanics		
Connection technology	screw-type terminals	screw-type terminals
Connections		
• Supply input	L, N: 1 screw terminal each for 0.5 ... 2.5 mm ² single-core/finely stranded	L, N: 1 screw terminal each for 0.5 ... 2.5 mm ² single-core/finely stranded
• Output	+, -: 2 screw terminals each for 0.5 ... 2.5 mm ²	+, -: 2 screw terminals each for 0.5 ... 2.5 mm ²
• Auxiliary	-	-
Width of the enclosure	36 mm	54 mm
Height of the enclosure	90 mm	90 mm
Depth of the enclosure	53 mm	53 mm
Required spacing		
• top	20 mm	20 mm
• bottom	20 mm	20 mm
• left	0 mm	0 mm
• right	0 mm	0 mm
Weight, approx.	0.12 kg	0.2 kg
Product feature of the enclosure housing for side-by-side mounting	Yes	Yes
Installation	Snaps onto DIN rail EN 60715 35x7.5/15	Snaps onto DIN rail EN 60715 35x7.5/15
MTBF at 40 °C	2 931 709 h	2 654 280 h
Other information	Specifications at rated input voltage and ambient temperature +25 °C (unless otherwise specified)	Specifications at rated input voltage and ambient temperature +25 °C (unless otherwise specified)

Ordering data**Article No.****Article No.****LOGO!Power 1-phase,
5 V DC/3 A**

Stabilized power supply
Input: 100 ... 240 V DC
(110 ... 300 V AC)
Output: 5 V DC/3 A

6EP3310-6SB00-0AY0**LOGO!Power 1-phase,
5 V DC/6.3 A**

Stabilized power supply
Input: 100 ... 240 V AC
(110 ... 300 V DC)
Output: 5 V DC/6.3 A

6EP3311-6SB00-0AY0

LOGO! logic modules

LOGO!Power

1-phase, 12 V DC

Overview

2



Thanks to its stepped profile design, the LOGO!Power product family is ideally suited for installation in miniature distribution boards. The stabilized power supplies with a wide range input of 100 ... 240 V AC (85 ... 264 V) and 110 ... 300 V DC are available with an output voltage of 12 V in three performance classes.

The 12 V versions are ideal for supplying LOGO! controllers with the corresponding voltage input. The high level of efficiency across the entire load range as well as the low no-load losses result in lower overall energy consumption. Greater convenience when commissioning and servicing thanks to integrated current monitor (for devices at least 36 mm wide) The extended temperature range from -25 °C to +70 °C enables a host of additional applications.

Main product highlights

- 12 V DC / 0.9 A, 1.9 A and 4.5 A
- Narrow unit with width of 18 mm, 36 mm or 54 mm and overall depth of 53 mm in LOGO! design
- Flexible mounting: standard rail or wall mounting in a range of installation positions
- Higher energy efficiency: high efficiency levels over the entire load range as well as no-load power losses of < 0.3 W
- Integrated current monitor: actual output current measurement directly at the power supply unit (for devices at least 36 mm wide)
- Global use: operating temperature range from -25 °C to +70 °C as well as international certifications such as UL, CSA, FM or ATEX

Technical specifications

Article number	6EP3320-6SB00-0AY0	6EP3321-6SB00-0AY0	6EP3322-6SB00-0AY0
Product	LOGO!Power	LOGO!Power	LOGO!Power
Power supply, type	12 V/0.9 A	12 V/1.9 A	12 V/4.5 A
Input			
Input	1-phase AC or DC	1-phase AC or DC	1-phase AC or DC
Rated voltage value $V_{in \text{ rated}}$	100 ... 240 V	100 ... 240 V	100 ... 240 V
Voltage range AC	85 ... 264 V	85 ... 264 V	85 ... 264 V
Input voltage			
• at DC	110 ... 300 V	110 ... 300 V	110 ... 300 V
Wide-range input	Yes	Yes	Yes
Mains buffering at $I_{out \text{ rated}}$, min.	40 ms; at $V_{in} = 187 \text{ V}$	40 ms; at $V_{in} = 187 \text{ V}$	40 ms; at $V_{in} = 187 \text{ V}$
Rated line frequency 1	50 Hz	50 Hz	50 Hz
Rated line frequency 2	60 Hz	60 Hz	60 Hz
Rated line range	47 ... 63 Hz	47 ... 63 Hz	47 ... 63 Hz
Input current			
• at rated input voltage 120 V	0.3 A	0.53 A	1.13 A
• at rated input voltage 230 V	0.2 A	0.3 A	0.61 A
Switch-on current limiting (+25 °C), max.	20 A	25 A	50 A
I^2t , max.	0.8 A ² ·s	0.8 A ² ·s	3 A ² ·s
Built-in incoming fuse	internal	internal	internal

Technical specifications (continued)

Article number	6EP3320-6SB00-0AY0	6EP3321-6SB00-0AY0	6EP3322-6SB00-0AY0
Product	LOGO!Power	LOGO!Power	LOGO!Power
Power supply, type	12 V/0.9 A	12 V/1.9 A	12 V/4.5 A
Output			
Output	Controlled, isolated DC voltage	Controlled, isolated DC voltage	Controlled, isolated DC voltage
Rated voltage V_{out} DC	12 V	12 V	12 V
Total tolerance, static \pm	3 %	3 %	3 %
Static mains compensation, approx.	0.1 %	0.1 %	0.1 %
Static load balancing, approx.	0.1 %	0.1 %	0.1 %
Residual ripple peak-peak, max.	200 mV	200 mV	200 mV
Residual ripple peak-peak, typ.	30 mV	30 mV	30 mV
Spikes peak-peak, max. (bandwidth: 20 MHz)	300 mV	300 mV	300 mV
Spikes peak-peak, typ. (bandwidth: 20 MHz)	50 mV	50 mV	50 mV
Adjustment range		10.5 ... 16.1 V	10.5 ... 16.1 V
Product function Output voltage adjustable	No	Yes	Yes
Output voltage setting		via potentiometer	via potentiometer
Status display	Green LED for output voltage OK	Green LED for output voltage OK	Green LED for output voltage OK
On/off behavior	No overshoot of V_{out} (soft start)	No overshoot of V_{out} (soft start)	No overshoot of V_{out} (soft start)
Startup delay, max.	0.5 s	0.5 s	0.5 s
Voltage rise, typ.	100 ms	100 ms	100 ms
Rated current value $I_{out rated}$	0.9 A	1.9 A	4.5 A
Current range	0 ... 0.9 A	0 ... 1.9 A	0 ... 4.5 A
• Note	+55 ... +70 °C: Derating 2%/K	+55 ... +70 °C: Derating 2%/K	+55 ... +70 °C: Derating 2%/K
Supplied active power typical	10.8 W	22.8 W	54 W
Parallel switching for enhanced performance	No	Yes	Yes
Numbers of parallel switchable units for enhanced performance	2	2	2
Efficiency			
Efficiency at $V_{out rated}$, $I_{out rated}$, approx.	78 %	81 %	87.1 %
Power loss at $V_{out rated}$, $I_{out rated}$, approx.	3 W	5 W	8 W
Power loss [W] during no-load operation maximum	0.3 W	0.3 W	0.3 W
Closed-loop control			
Dynamic mains compensation ($V_{in rated} \pm 15\%$), max.	0.2 %	0.2 %	0.2 %
Dynamic load smoothing ($I_{out}: 10/90/10\%$), $U_{out} \pm$ typ.	3 %	2 %	4 %
Load step setting time 10 to 90%, typ.	1 ms	1 ms	1 ms
Load step setting time 90 to 10%, typ.	1 ms	1 ms	1 ms
Protection and monitoring			
Output overvoltage protection	Yes, according to EN 60950-1	Yes, according to EN 60950-1	Yes, according to EN 60950-1
Current limitation, typ.	1.3 A	2.5 A	5 A
Property of the output Short-circuit proof	Yes	Yes	Yes
Short-circuit protection	Constant current characteristic	Constant current characteristic	Constant current characteristic
Enduring short circuit current RMS value			
• maximum	1.3 A	2.5 A	5 A
Overload/short-circuit indicator	-	-	-

LOGO! logic modules

LOGO!Power

1-phase, 12 V DC

Technical specifications (continued)

Article number	6EP3320-6SB00-0AY0	6EP3321-6SB00-0AY0	6EP3322-6SB00-0AY0
Product	LOGO!Power	LOGO!Power	LOGO!Power
Power supply, type	12 V/0.9 A	12 V/1.9 A	12 V/4.5 A
Safety			
Primary/secondary isolation	Yes	Yes	Yes
Galvanic isolation	Safety extra-low output voltage U_{out} acc. to EN 60950-1 and EN 50178	Safety extra-low output voltage U_{out} acc. to EN 60950-1 and EN 50178	Safety extra-low output voltage U_{out} acc. to EN 60950-1 and EN 50178
Protection class	Class II (without protective conductor)	Class II (without protective conductor)	Class II (without protective conductor)
CE mark	Yes	Yes	Yes
UL/cUL (CSA) approval	cULus-Listed (UL 508, CSA C22.2 No. 107.1), File E197259; cURus-Recognized (UL 60950, CSA C22.2 No. 60950), File E151273, NEC class 2 (acc. to UL 1310)	cULus-Listed (UL 508, CSA C22.2 No. 107.1), File E197259; cURus-Recognized (UL 60950, CSA C22.2 No. 60950), File E151273, NEC class 2 (acc. to UL 1310)	cULus-listed (UL 508, CSA C22.2 No. 107.1), File E197259; cURus-recognized (UL 60950, CSA C22.2 No. 60950), File E151273
Explosion protection	ATEX (EX) II 3G Ex nA IIC T3; cCSAus (CSA C22.2 No. 213-M1987, ANSI/ISA-12.12.01-2007) Class I, Div. 2, Group ABCD, T4	ATEX (EX) II 3G Ex nA IIC T3; cCSAus (CSA C22.2 No. 213-M1987, ANSI/ISA-12.12.01-2007) Class I, Div. 2, Group ABCD, T4	ATEX (EX) II 3G Ex nA IIC T3; cCSAus (CSA C22.2 No. 213-M1987, ANSI/ISA-12.12.01-2007) Class I, Div. 2, Group ABCD, T4
FM approval	Class I, Div. 2, Group ABCD, T4	Class I, Div. 2, Group ABCD, T4	Class I, Div. 2, Group ABCD, T4
CB approval	Yes	Yes	Yes
Marine approval	GL and ABS in process	GL and ABS in process	GL and ABS in process
Degree of protection (EN 60529)	IP20	IP20	IP20
EMC			
Emitted interference	EN 55022 Class B	EN 55022 Class B	EN 55022 Class B
Supply harmonics limitation	not applicable	not applicable	not applicable
Noise immunity	EN 61000-6-2	EN 61000-6-2	EN 61000-6-2
Operating data			
Ambient temperature			
• during operation	-25 ... +70 °C	-25 ... +70 °C	-25 ... +70 °C
- Note	with natural convection	with natural convection	with natural convection
• during transport	-40 ... +85 °C	-40 ... +85 °C	-40 ... +85 °C
• during storage	-40 ... +85 °C	-40 ... +85 °C	-40 ... +85 °C
Humidity class according to EN 60721	Climate class 3K3, no condensation	Climate class 3K3, no condensation	Climate class 3K3, no condensation
Mechanics			
Connection technology	screw-type terminals	screw-type terminals	screw-type terminals
Connections			
• Supply input	L, N: 1 screw terminal each for 0.5 ... 2.5 mm ² single-core/finely stranded	L, N: 1 screw terminal each for 0.5 ... 2.5 mm ² single-core/finely stranded	L, N: 1 screw terminal each for 0.5 ... 2.5 mm ² single-core/finely stranded
• Output	+, -: 2 screw terminals each for 0.5 ... 2.5 mm ²	+, -: 2 screw terminals each for 0.5 ... 2.5 mm ²	+, -: 2 screw terminals each for 0.5 ... 2.5 mm ²
• Auxiliary	-	-	-
Width of the enclosure	18 mm	36 mm	54 mm
Height of the enclosure	90 mm	90 mm	90 mm
Depth of the enclosure	53 mm	53 mm	53 mm
Required spacing			
• top	20 mm	20 mm	20 mm
• bottom	20 mm	20 mm	20 mm
• left	0 mm	0 mm	0 mm
• right	0 mm	0 mm	0 mm
Weight, approx.	0.07 kg	0.12 kg	0.2 kg
Product feature of the enclosure housing for side-by-side mounting	Yes	Yes	Yes
Installation	Snaps onto DIN rail EN 60715 35x15, various direct mounting positions	Snaps onto DIN rail EN 60715 35x15, various direct mounting positions	Snaps onto DIN rail EN 60715 35x15, various direct mounting positions
MTBF at 40 °C	3 793 080 h	2 938 542 h	2 566 680 h
Other information	Specifications at rated input voltage and ambient temperature +25 °C (unless otherwise specified)	Specifications at rated input voltage and ambient temperature +25 °C (unless otherwise specified)	Specifications at rated input voltage and ambient temperature +25 °C (unless otherwise specified)

Ordering data	Article No.		Article No.
LOGO!Power 1-phase, 12 V DC/0.9 A Stabilized power supply Input: 100 ... 240 V AC (110 ... 300 V DC) Output: 12 V DC/0.9 A	6EP3320-6SB00-0AY0	LOGO!Power 1-phase, 12 V DC/4.5 A Stabilized power supply Input: 100 ... 240 V AC (110 ... 300 V DC) Output: 12 V DC/4.5 A	6EP3322-6SB00-0AY0
LOGO!Power 1-phase, 12 V DC/1.9 A Stabilized power supply Input: 100 ... 240 V AC (110 ... 300 V DC) Output: 12 V DC/1.9 A	6EP3321-6SB00-0AY0		

LOGO! logic modules

LOGO!Power

1-phase, 15 V DC

Overview

2



Thanks to its stepped profile design, the LOGO!Power product family is ideally suited for installation in miniature distribution boards. The stabilized power supplies with a wide range input of 100 ... 240 V AC (85 ... 264 V) and 110 ... 300 V DC are available

with an output voltage of 15 V in two performance classes. The high level of efficiency across the entire load range as well as the low no-load losses result in lower overall energy consumption. Greater convenience when commissioning and servicing thanks to the integrated current monitor. The extended temperature range from -25 °C to +70 °C enables a host of additional applications.

Main product highlights

- 15 V DC/ 1.9 A and 4.0 A
- Narrow unit with 36 mm or 54 mm width and depth of 53 mm in LOGO! design
- Flexible mounting: standard rail or wall mounting in a range of installation positions
- Higher energy efficiency: high efficiency levels over the entire load range as well as no-load power losses of < 0.3 W
- Integrated current monitor: actual output current measurement directly at the power supply unit
- Global use: operating temperature range from -25 °C to +70 °C as well as international certifications such as UL, CSA, FM or ATEX

Technical specifications

Article number	6EP3321-6SB10-0AY0	6EP3322-6SB10-0AY0
Product	LOGO!Power	LOGO!Power
Power supply, type	15 V/1.9 A	15 V/4 A
Input		
Input	1-phase AC or DC	1-phase AC or DC
Rated voltage value $V_{in rated}$	100 ... 240 V	100 ... 240 V
Voltage range AC	85 ... 264 V	85 ... 264 V
Input voltage		
• at DC	110 ... 300 V	110 ... 300 V
Wide-range input	Yes	Yes
Mains buffering at $I_{out rated, min.}$	40 ms; at $V_{in} = 187 V$	40 ms; at $V_{in} = 187 V$
Rated line frequency 1	50 Hz	50 Hz
Rated line frequency 2	60 Hz	60 Hz
Rated line range	47 ... 63 Hz	47 ... 63 Hz
Input current		
• at rated input voltage 120 V	0.63 A	1.24 A
• at rated input voltage 230 V	0.33 A	0.68 A
Switch-on current limiting (+25 °C), max.	25 A	55 A
I^2t , max.	0.8 A ² ·s	3 A ² ·s
Built-in incoming fuse	internal	internal

Technical specifications (continued)

Article number	6EP3321-6SB10-0AY0	6EP3322-6SB10-0AY0
Product	LOGO!Power	LOGO!Power
Power supply, type	15 V/1.9 A	15 V/4 A
Output		
Output	Controlled, isolated DC voltage	Controlled, isolated DC voltage
Rated voltage V_{out} DC	15 V	15 V
Total tolerance, static \pm	3 %	3 %
Static mains compensation, approx.	0.1 %	0.1 %
Static load balancing, approx.	0.1 %	0.1 %
Residual ripple peak-peak, max.	200 mV	200 mV
Residual ripple peak-peak, typ.	30 mV	30 mV
Spikes peak-peak, max. (bandwidth: 20 MHz)	300 mV	300 mV
Spikes peak-peak, typ. (bandwidth: 20 MHz)	50 mV	50 mV
Adjustment range	10.5 ... 16.1 V	10.5 ... 16.1 V
Product function	Yes	Yes
Output voltage adjustable		
Output voltage setting	via potentiometer	via potentiometer
Status display	Green LED for output voltage OK	Green LED for output voltage OK
On/off behavior	No overshoot of V_{out} (soft start)	No overshoot of V_{out} (soft start)
Startup delay, max.	0.5 s	0.5 s
Voltage rise, typ.	100 ms	100 ms
Rated current value $I_{out\ rated}$	1.9 A	4 A
Current range	0 ... 1.9 A	0 ... 4 A
• Note	+55 ... +70 °C: Derating 2%/K	+55 ... +70 °C: Derating 2%/K
Supplied active power typical	28.5 W	60 W
Parallel switching for enhanced performance	Yes	Yes
Numbers of parallel switchable units for enhanced performance	2	2
Efficiency		
Efficiency at $V_{out\ rated}$, $I_{out\ rated}$, approx.	83 %	88.4 %
Power loss at $V_{out\ rated}$, $I_{out\ rated}$, approx.	6 W	8 W
Power loss [W] during no-load operation maximum	0.3 W	0.3 W
Closed-loop control		
Dynamic mains compensation ($V_{in\ rated} \pm 15\%$), max.	0.2 %	0.2 %
Dynamic load smoothing (I_{out} : 10/90/10 %), $U_{out} \pm$ typ.	2 %	3 %
Load step setting time 10 to 90%, typ.	1 ms	1 ms
Load step setting time 90 to 10%, typ.	1 ms	1 ms
Protection and monitoring		
Output overvoltage protection	Yes, according to EN 60950-1	Yes, according to EN 60950-1
Current limitation, typ.	2.5 A	5 A
Property of the output Short-circuit proof	Yes	Yes
Short-circuit protection	Constant current characteristic	Constant current characteristic
Enduring short circuit current RMS value		
• maximum	2.5 A	5 A
Overload/short-circuit indicator	-	-

LOGO! logic modules

LOGO!Power

1-phase, 15 V DC

Technical specifications (continued)

Article number	6EP3321-6SB10-0AY0	6EP3322-6SB10-0AY0
Product	LOGO!Power	LOGO!Power
Power supply, type	15 V/1.9 A	15 V/4 A
Safety		
Primary/secondary isolation	Yes	Yes
Galvanic isolation	Safety extra-low output voltage U_{out} acc. to EN 60950-1 and EN 50178	Safety extra-low output voltage U_{out} acc. to EN 60950-1 and EN 50178
Protection class	Class II (without protective conductor)	Class II (without protective conductor)
CE mark	Yes	Yes
UL/cUL (CSA) approval	cULus-Listed (UL 508, CSA C22.2 No. 107.1), File E197259; cURus-Recognized (UL 60950, CSA C22.2 No. 60950), File E151273, NEC class 2 (acc. to UL 1310)	cULus-Listed (UL 508, CSA C22.2 No. 107.1), File E197259; cURus-Recognized (UL 60950, CSA C22.2 No. 60950), File E151273, NEC class 2 (acc. to UL 1310)
Explosion protection	ATEX (EX) II 3G Ex nA IIC T3; cCSAus (CSA C22.2 No. 213-M1987, ANSI/ISA-12.12.01-2007) Class I, Div. 2, Group ABCD, T4	ATEX (EX) II 3G Ex nA IIC T3; cCSAus (CSA C22.2 No. 213-M1987, ANSI/ISA-12.12.01-2007) Class I, Div. 2, Group ABCD, T4
FM approval	Class I, Div. 2, Group ABCD, T4	Class I, Div. 2, Group ABCD, T4
CB approval	Yes	Yes
Marine approval	GL, ABS, BV, DNV, LRS	GL, ABS, BV, DNV, LRS
Degree of protection (EN 60529)	IP20	IP20
EMC		
Emitted interference	EN 55022 Class B	EN 55022 Class B
Supply harmonics limitation	not applicable	not applicable
Noise immunity	EN 61000-6-2	EN 61000-6-2
Operating data		
Ambient temperature		
• during operation	-25 ... +70 °C	-25 ... +70 °C
- Note	with natural convection	with natural convection
• during transport	-40 ... +85 °C	-40 ... +85 °C
• during storage	-40 ... +85 °C	-40 ... +85 °C
Humidity class according to EN 60721	Climate class 3K3, no condensation	Climate class 3K3, no condensation
Mechanics		
Connection technology	screw-type terminals	screw-type terminals
Connections		
• Supply input	L, N: 1 screw terminal each for 0.5 ... 2.5 mm ² single-core/finely stranded	L, N: 1 screw terminal each for 0.5 ... 2.5 mm ² single-core/finely stranded
• Output	+, -: 2 screw terminals each for 0.5 ... 2.5 mm ²	+, -: 2 screw terminals each for 0.5 ... 2.5 mm ²
• Auxiliary	-	-
Width of the enclosure	36 mm	54 mm
Height of the enclosure	90 mm	90 mm
Depth of the enclosure	53 mm	53 mm
Required spacing		
• top	20 mm	20 mm
• bottom	20 mm	20 mm
• left	0 mm	0 mm
• right	0 mm	0 mm
Weight, approx.	0.12 kg	0.2 kg
Product feature of the enclosure housing for side-by-side mounting	Yes	Yes
Installation	Snaps onto DIN rail EN 60715 35x7.5/15	Snaps onto DIN rail EN 60715 35x7.5/15
MTBF at 40 °C	2 938 542 h	2 566 680 h
Other information	Specifications at rated input voltage and ambient temperature +25 °C (unless otherwise specified)	Specifications at rated input voltage and ambient temperature +25 °C (unless otherwise specified)

Ordering data

LOGO!Power 1-phase, 15 V DC/1.9 A

Stabilized power supply
Input: 100 ... 240 V AC
(110 ... 300 V DC)
Output: 15 V DC/1.9 A

Article No.

6EP3321-6SB10-0AY0

Article No.

LOGO!Power 1-phase, 15 V DC/4 A

Stabilized power supply
Input: 100 ... 240 V AC
(110 ... 300 V DC)
Output: 15 V DC/4 A

6EP3322-6SB10-0AY0

Overview



Thanks to its stepped profile design, the LOGO!Power product family is ideally suited for installation in miniature distribution boards. The stabilized power supplies with a wide range input of 100 ... 240 V AC (85 ... 264 V) and 110 ... 300 V DC are available with an output voltage of 24 V in four performance classes. The 24 V versions are ideal for supplying LOGO! controllers with the corresponding voltage input. The high level of efficiency across the entire load range as well as the low no-load losses result in lower overall energy consumption. Greater convenience when

commissioning and servicing thanks to integrated current monitor (for devices at least 36 mm wide) The extended temperature range from -25 °C to +70 °C enables a host of additional applications.

To further increase the 24 V availability, the LOGO!Power power supplies can be combined with **DC UPS**, **redundancy** and **selectivity modules**.

Main product highlights

- 24 V DC / 0.6 A, 1.3 A, 2.5 A and 4.0 A
- Narrow unit with width of 18 mm, 36 mm, 54 mm or 72 mm and overall depth of 53 mm in LOGO! design
- Flexible mounting: standard rail or wall mounting in a range of installation positions
- Higher energy efficiency: high efficiency levels over the entire load range as well as no-load power losses of < 0.3 W
- Integrated current monitor: actual output current measurement directly at the power supply unit (for devices at least 36 mm wide)
- Global use: operating temperature range from -25 °C to +70 °C as well as international certifications such as UL, CSA, FM or ATEX

Technical specifications

Article number	6EP3330-6SB00-0AY0	6EP3331-6SB00-0AY0	6EP3332-6SB00-0AY0	6EP3333-6SB00-0AY0
Product	LOGO!Power	LOGO!Power	LOGO!Power	LOGO!Power
Power supply, type	24 V/0.6 A	24 V/1.3 A	24 V/2.5 A	24 V/4 A
Input				
Input	1-phase AC or DC	1-phase AC or DC	1-phase AC or DC	1-phase AC or DC
Rated voltage value $V_{in rated}$	100 ... 240 V	100 ... 240 V	100 ... 240 V	100 ... 240 V
Voltage range AC	85 ... 264 V	85 ... 264 V	85 ... 264 V	85 ... 264 V
Input voltage				
• at DC	110 ... 300 V	110 ... 300 V	110 ... 300 V	110 ... 300 V
Wide-range input	Yes	Yes	Yes	Yes
Mains buffering at $I_{out rated}$, min.	40 ms; at $V_{in} = 187 V$	40 ms; at $V_{in} = 187 V$	40 ms; at $V_{in} = 187 V$	40 ms; at $V_{in} = 187 V$
Rated line frequency 1	50 Hz	50 Hz	50 Hz	50 Hz
Rated line frequency 2	60 Hz	60 Hz	60 Hz	60 Hz
Rated line range	47 ... 63 Hz	47 ... 63 Hz	47 ... 63 Hz	47 ... 63 Hz
Input current				
• at rated input voltage 120 V	0.3 A	0.7 A	1.22 A	1.95 A
• at rated input voltage 230 V	0.2 A	0.35 A	0.66 A	0.97 A
Switch-on current limiting (+25 °C), max.	20 A	25 A	52 A	31 A
I^2t , max.	0.8 A ² ·s	0.8 A ² ·s	3 A ² ·s	2.5 A ² ·s
Built-in incoming fuse	internal	internal	internal	internal

LOGO! logic modules

LOGO!Power

1-phase, 24 V DC

Technical specifications (continued)

Article number	6EP3330-6SB00-0AY0	6EP3331-6SB00-0AY0	6EP3332-6SB00-0AY0	6EP3333-6SB00-0AY0
Product	LOGO!Power	LOGO!Power	LOGO!Power	LOGO!Power
Power supply, type	24 V/0.6 A	24 V/1.3 A	24 V/2.5 A	24 V/4 A
Output				
Output	Controlled, isolated DC voltage	Controlled, isolated DC voltage	Controlled, isolated DC voltage	Controlled, isolated DC voltage
Rated voltage V_{out} DC	24 V	24 V	24 V	24 V
Total tolerance, static \pm	3 %	3 %	3 %	3 %
Static mains compensation, approx.	0.1 %	0.1 %	0.1 %	0.1 %
Static load balancing, approx.	0.1 %	0.1 %	0.1 %	0.1 %
Residual ripple peak-peak, max.	200 mV	200 mV	200 mV	200 mV
Residual ripple peak-peak, typ.	30 mV	30 mV	30 mV	30 mV
Spikes peak-peak, max. (bandwidth: 20 MHz)	300 mV	300 mV	300 mV	300 mV
Spikes peak-peak, typ. (bandwidth: 20 MHz)	50 mV	50 mV	50 mV	50 mV
Adjustment range		22.2 ... 26.4 V	22.2 ... 26.4 V	22.2 ... 26.4 V
Product function	No	Yes	Yes	Yes
Output voltage adjustable		via potentiometer	via potentiometer	via potentiometer
Output voltage setting				
Status display	Green LED for output voltage OK	Green LED for output voltage OK	Green LED for output voltage OK	Green LED for output voltage OK
On/off behavior	No overshoot of V_{out} (soft start)	No overshoot of V_{out} (soft start)	No overshoot of V_{out} (soft start)	No overshoot of V_{out} (soft start)
Startup delay, max.	0.5 s	0.5 s	0.5 s	0.5 s
Voltage rise, typ.	100 ms	100 ms	100 ms	100 ms
Rated current value $I_{out rated}$	0.6 A	1.3 A	2.5 A	4 A
Current range	0 ... 0.6 A	0 ... 1.3 A	0 ... 2.5 A	0 ... 4 A
• Note	+55 ... +70 °C: Derating 2%/K	+55 ... +70 °C: Derating 2%/K	+55 ... +70 °C: Derating 2%/K	+55 ... +70 °C: Derating 2%/K
Supplied active power typical	14.4 W	31.2 W	60 W	96 W
Parallel switching for enhanced performance	No	Yes	Yes	Yes
Numbers of parallel switchable units for enhanced performance	2	2	2	2
Efficiency				
Efficiency at $V_{out rated}$, $I_{out rated}$, approx.	81 %	86 %	90 %	89 %
Power loss at $V_{out rated}$, $I_{out rated}$, approx.	3 W	5 W	7 W	12 W
Power loss [W] during no-load operation maximum	0.3 W	0.3 W	0.3 W	0.3 W
Closed-loop control				
Dynamic mains compensation ($V_{in rated} \pm 15$ %), max.	0.2 %	0.2 %	0.2 %	0.2 %
Dynamic load smoothing (I_{out} : 10/90/10 %), $U_{out} \pm$ typ.	2 %	1 %	2 %	2 %
Load step setting time 10 to 90%, typ.	1 ms	1 ms	1 ms	1 ms
Load step setting time 90 to 10%, typ.	1 ms	1 ms	1 ms	1 ms
Protection and monitoring				
Output overvoltage protection	Yes, according to EN 60950-1	Yes, according to EN 60950-1	Yes, according to EN 60950-1	Yes, according to EN 60950-1
Current limitation, typ.	0.8 A	1.7 A	3.2 A	5 A
Property of the output Short-circuit proof	Yes	Yes	Yes	Yes
Short-circuit protection	Constant current characteristic	Constant current characteristic	Constant current characteristic	Constant current characteristic
Enduring short circuit current RMS value				
• maximum	0.8 A	1.7 A	3.2 A	5 A
Overload/short-circuit indicator	-	-	-	-

Technical specifications (continued)

Article number	6EP3330-6SB00-0AY0	6EP3331-6SB00-0AY0	6EP3332-6SB00-0AY0	6EP3333-6SB00-0AY0
Product	LOGO!Power	LOGO!Power	LOGO!Power	LOGO!Power
Power supply, type	24 V/0.6 A	24 V/1.3 A	24 V/2.5 A	24 V/4 A
Safety				
Primary/secondary isolation	Yes	Yes	Yes	Yes
Galvanic isolation	Safety extra-low output voltage U_{out} acc. to EN 60950-1 and EN 50178	Safety extra-low output voltage U_{out} acc. to EN 60950-1 and EN 50178	Safety extra-low output voltage U_{out} acc. to EN 60950-1 and EN 50178	Safety extra-low output voltage U_{out} acc. to EN 60950-1 and EN 50178
Protection class	Class II (without protective conductor)	Class II (without protective conductor)	Class II (without protective conductor)	Class II (without protective conductor)
CE mark	Yes	Yes	Yes	Yes
UL/cUL (CSA) approval	cULus-Listed (UL 508, CSA C22.2 No. 107.1), File E197259; cURus-Recognized (UL 60950, CSA C22.2 No. 60950), File E151273, NEC class 2 (acc. to UL 1310)	cULus-Listed (UL 508, CSA C22.2 No. 107.1), File E197259; cURus-Recognized (UL 60950, CSA C22.2 No. 60950), File E151273, NEC class 2 (acc. to UL 1310)	cULus-Listed (UL 508, CSA C22.2 No. 107.1), File E197259; cURus-Recognized (UL 60950, CSA C22.2 No. 60950), File E151273, NEC class 2 (acc. to UL 1310)	cULus-listed (UL 508, CSA C22.2 No. 107.1), File E197259; cURus-recognized (UL 60950, CSA C22.2 No. 60950), File E151273
Explosion protection	ATEX (EX) II 3G Ex nA IIC T3; cCSAus (CSA C22.2 No. 213-M1987, ANSI/ISA-12.12.01-2007) Class I, Div. 2, Group ABCD, T4	ATEX (EX) II 3G Ex nA IIC T3; cCSAus (CSA C22.2 No. 213-M1987, ANSI/ISA-12.12.01-2007) Class I, Div. 2, Group ABCD, T4	ATEX (EX) II 3G Ex nA IIC T3; cCSAus (CSA C22.2 No. 213-M1987, ANSI/ISA-12.12.01-2007) Class I, Div. 2, Group ABCD, T4	ATEX (EX) II 3G Ex nA IIC T3; cCSAus (CSA C22.2 No. 213-M1987, ANSI/ISA-12.12.01-2007) Class I, Div. 2, Group ABCD, T4
FM approval	Class I, Div. 2, Group ABCD, T4	Class I, Div. 2, Group ABCD, T4	Class I, Div. 2, Group ABCD, T4	Class I, Div. 2, Group ABCD, T4
CB approval	Yes	Yes	Yes	Yes
Marine approval	available soon	available soon	available soon	available soon
Degree of protection (EN 60529)	IP20	IP20	IP20	IP20
EMC				
Emitted interference	EN 55022 Class B	EN 55022 Class B	EN 55022 Class B	EN 55022 Class B
Supply harmonics limitation	not applicable	not applicable	not applicable	EN 61000-3-2
Noise immunity	EN 61000-6-2	EN 61000-6-2	EN 61000-6-2	EN 61000-6-2
Operating data				
Ambient temperature				
• during operation	-25 ... +70 °C	-25 ... +70 °C	-25 ... +70 °C	-25 ... +70 °C
- Note	with natural convection	with natural convection	with natural convection	with natural convection
• during transport	-40 ... +85 °C	-40 ... +85 °C	-40 ... +85 °C	-40 ... +85 °C
• during storage	-40 ... +85 °C	-40 ... +85 °C	-40 ... +85 °C	-40 ... +85 °C
Humidity class according to EN 60721	Climate class 3K3, no condensation	Climate class 3K3, no condensation	Climate class 3K3, no condensation	Climate class 3K3, no condensation
Mechanics				
Connection technology	screw-type terminals	screw-type terminals	screw-type terminals	screw-type terminals
Connections				
• Supply input	L, N: 1 screw terminal each for 0.5 ... 2.5 mm ² single-core/finely stranded	L, N: 1 screw terminal each for 0.5 ... 2.5 mm ² single-core/finely stranded	L, N: 1 screw terminal each for 0.5 ... 2.5 mm ² single-core/finely stranded	L, N: 1 screw terminal each for 0.5 ... 2.5 mm ² single-core/finely stranded
• Output	+, -: 2 screw terminals each for 0.5 ... 2.5 mm ²	+, -: 2 screw terminals each for 0.5 ... 2.5 mm ²	+, -: 2 screw terminals each for 0.5 ... 2.5 mm ²	+, -: 2 screw terminals each for 0.5 ... 2.5 mm ²
• Auxiliary	-	-	-	-
Width of the enclosure	18 mm	36 mm	54 mm	72 mm
Height of the enclosure	90 mm	90 mm	90 mm	90 mm
Depth of the enclosure	53 mm	53 mm	53 mm	53 mm
Required spacing				
• top	20 mm	20 mm	20 mm	20 mm
• bottom	20 mm	20 mm	20 mm	20 mm
• left	0 mm	0 mm	0 mm	0 mm
• right	0 mm	0 mm	0 mm	0 mm
Weight, approx.	0.07 kg	0.12 kg	0.2 kg	0.29 kg
Product feature of the enclosure housing for side-by-side mounting	Yes	Yes	Yes	Yes
Installation	Snaps onto DIN rail EN 60715 35x15, various direct mounting positions	Snaps onto DIN rail EN 60715 35x15, various direct mounting positions	Snaps onto DIN rail EN 60715 35x15, various direct mounting positions	Snaps onto DIN rail EN 60715 35x15, various direct mounting positions
MTBF at 40 °C	4 415 040 h	3 094 996 h	2 864 520 h	2 391 480 h
Other information	Specifications at rated input voltage and ambient temperature +25 °C (unless otherwise specified)	Specifications at rated input voltage and ambient temperature +25 °C (unless otherwise specified)	Specifications at rated input voltage and ambient temperature +25 °C (unless otherwise specified)	Specifications at rated input voltage and ambient temperature +25 °C (unless otherwise specified)

LOGO! logic modules

LOGO!Power

1-phase, 24 V DC

2

Ordering data**Article No.****Article No.****LOGO!Power 1-phase,
24 V DC/0.6 A**

Stabilized power supply
 Input: 100 ... 240 V AC
 (110 ... 300 V DC)
 Output: 24 V DC/0.6 A

6EP3330-6SB00-0AY0**LOGO!Power 1-phase,
24 V DC/2.5 A**

Stabilized power supply
 Input: 100 ... 240 V AC
 (110 ... 300 V DC)
 Output: 24 V DC/2.5 A

6EP3332-6SB00-0AY0**LOGO!Power 1-phase,
24 V DC/1.3 A**

Stabilized power supply
 Input: 100 ... 240 V AC
 (110 ... 300 V DC)
 Output: 24 V DC/1.3 A

6EP3331-6SB00-0AY0**LOGO!Power 1-phase,
24 V DC/4 A**

Stabilized power supply
 Input: 100 ... 240 V AC
 (110 ... 300 V DC)
 Output: 24 V DC/4 A

6EP3333-6SB00-0AY0

Overview

Note:

SIPLUS extreme products are based on SIMATIC standard products. The contents listed here were adopted from the respective standard products. SIPLUS extreme specific information was added.

For technical documentation on SIPLUS, see:

<http://www.siemens.com/siplus-extreme>

2

Technical specifications

Article number	6AG1331-1SH03-7AA0	6AG1332-1SH43-7AA0	6AG1332-1SH52-7AA0
Based on	6EP1331-1SH03	6EP1332-1SH43	6EP1332-1SH52
Product	SIPLUS LOGO!Power	SIPLUS LOGO!Power	SIPLUS LOGO!Power
Power supply, type	24 V/1.3 A	24 V/2.5 A	24 V/4 A
Operating data			
Ambient temperature			
• during operation	-40 ... +70 °C	-40 ... +70 °C	-40 ... +70 °C
- Note	with natural convection	with natural convection	with natural convection
• during transport	-40 ... +85 °C	-40 ... +85 °C	-40 ... +85 °C
• during storage	-40 ... +85 °C	-40 ... +85 °C	-40 ... +85 °C
Ambient condition relating to ambient temperature - air pressure - installation altitude	Tmin ... Tmax at 1080 hPa ... 795 hPa (-1000 m ... +2000 m); Tmin ... (Tmax - 10K) at 795 hPa ... 658 hPa (+2000 m ... +3500 m); Tmin ... (Tmax - 20K) at 658 hPa ... 540 hPa (+3500 m ... +5000 m)	Tmin ... Tmax at 1080 hPa ... 795 hPa (-1000 m ... +2000 m); Tmin ... (Tmax - 10K) at 795 hPa ... 658 hPa (+2000 m ... +3500 m); Tmin ... (Tmax - 20K) at 658 hPa ... 540 hPa (+3500 m ... +5000 m)	Tmin ... Tmax at 1080 hPa ... 795 hPa (-1000 m ... +2000 m); Tmin ... (Tmax - 10K) at 795 hPa ... 658 hPa (+2000 m ... +3500 m); Tmin ... (Tmax - 20K) at 658 hPa ... 540 hPa (+3500 m ... +5000 m)
Relative humidity with condensation maximum	100 %; Relative humidity, incl. condensation/frost permitted (no commissioning under condensation conditions)	100 %; Relative humidity, incl. condensation/frost permitted (no commissioning under condensation conditions)	100 %; Relative humidity, incl. condensation/frost permitted (no commissioning under condensation conditions)
Resistance to biologically active substances conformity acc. to EN 60721-3-3	Yes; Conformity with EN 60721-3-3, Class 3B2 mold, fungus and dry rot spores (with the exception of fauna). The supplied connector covers must remain on the unused interfaces during operation!	Yes; Conformity with EN 60721-3-3, Class 3B2 mold, fungus and dry rot spores (with the exception of fauna). The supplied connector covers must remain on the unused interfaces during operation!	Yes; Conformity with EN 60721-3-3, Class 3B2 mold, fungus and dry rot spores (with the exception of fauna). The supplied connector covers must remain on the unused interfaces during operation!
Resistance to chemically active substances conformity acc. to EN 60721-3-3	Yes; Conformity with EN 60721-3-3, Class 3C4 incl. salt spray according to EN 60068-2-52 (degree of severity 3). The supplied connector covers must remain on the unused interfaces during operation!	Yes; Conformity with EN 60721-3-3, Class 3C4 incl. salt spray according to EN 60068-2-52 (degree of severity 3). The supplied connector covers must remain on the unused interfaces during operation!	Yes; Conformity with EN 60721-3-3, Class 3C4 incl. salt spray according to EN 60068-2-52 (degree of severity 3). The supplied connector covers must remain on the unused interfaces during operation!
Resistance to mechanically active substances conformity acc. to EN 60721-3-3	Yes; Conformity with EN 60721-3-3, Class 3S4 incl. Sand, dust. The supplied connector covers must remain on the unused interfaces during operation!	Yes; Conformity with EN 60721-3-3, Class 3S4 incl. Sand, dust. The supplied connector covers must remain on the unused interfaces during operation!	Yes; Conformity with EN 60721-3-3, Class 3S4 incl. Sand, dust. The supplied connector covers must remain on the unused interfaces during operation!

Ordering data

Ordering data	Article No.	Ordering data	Article No.
SIPLUS LOGO!Power 24 V 1.3 A		SIPLUS LOGO!Power 24 V 4 A	
Input 100 ... 240 V AC Output 24 V DC, 1.3 A		Input 100 ... 240 V AC Output 24 V DC, 4 A	
Extended temperature range and exposure to media	6AG1331-1SH03-7AA0	Extended temperature range and exposure to media	6AG1332-1SH52-7AA0
SIPLUS LOGO!Power 24 V 2.5 A			
Input 100 ... 240 V AC Output 24 V DC, 2.5 A			
Extended temperature range and exposure to media	6AG1332-1SH43-7AA0		

LOGO! logic modules

LOGO!Contact

LOGO!Contact

Overview

2

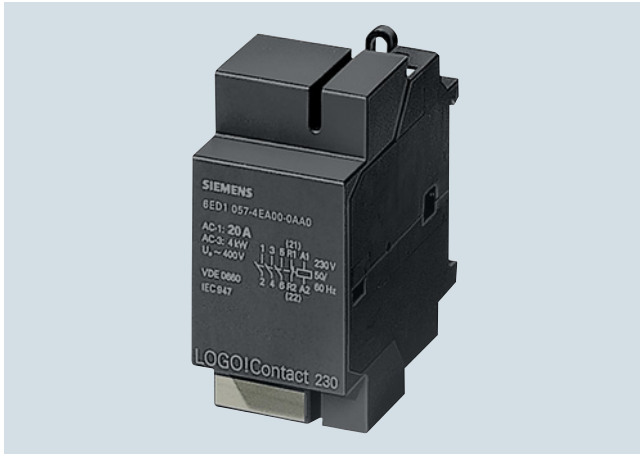

- Switching module for the direct switching of resistive loads and motors

Technical specifications

Article number	6ED1057-4CA00-0AA0 LOGO! CONTACT MOD., DC 24V, 3NO/1NC	6ED1057-4EA00-0AA0 LOGO! CONTACT MOD., AC 230V,3NO/1NC
Standards, approvals, certificates		
CE mark	Yes	Yes
Ambient conditions		
Ambient temperature during operation		
• min.	-25 °C	-25 °C
• max.	55 °C	55 °C
Weights		
Weight, approx.	160 g	160 g

Ordering data**Article No.****LOGO!Contact**

Switching module for direct switching of resistive loads up to 20 A and motors up to 4 kW

Switching voltage 24 V

Switching voltage 230 V

6ED1057-4CA00-0AA0

6ED1057-4EA00-0AA0

Overview

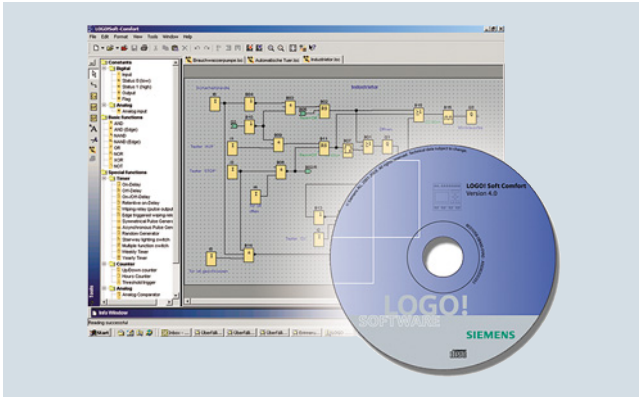

- The user-friendly software for generating switching programs on the PC for single-user mode and network mode
- Generation of switching programs in a function block diagram (FBD) or ladder logic (LAD)
- Furthermore, testing, simulation, online testing and archiving of the switching programs
- Professional documentation due to manifold comment and print functions

Minimum system requirements

Windows XP (32-bit), 7 (32/64-bit) or 8 (32/64-bit)

- PC Pentium IV.
- 150 MB free disk capacity.
- 256 MB RAM.
- SVGA graphics card with minimum resolution 800 x 600 (256 colors).
- DVD-ROM

Mac OS X

- Mac OS X 10.4

Linux

- Tested with SUSE Linux 11.3 SP2, kernel 3.0.76
- Runs on all Linux distributions on which Java 2 runs.
- Please refer to your relevant Linux distribution for the necessary hardware requirements.

Ordering data

LOGO!Soft Comfort V8

for programming on the PC in LAD/FBD; executes on Windows 8, 7, XP, Linux and Mac OSX; on DVD

Article No.

6ED1058-0BA08-0YA1

LOGO! logic modules

SIPLUS Add-Ons

LOGO! mounting kits

Overview



LOGO! and SIPLUS LOGO! are designed for quick and easy mounting on standard rails. With the mounting kit, these devices can also be easily and safely installed in front panels. If the supplied washer and seals are used, the devices are reliably protected against harsh environmental conditions up to the IP65 degree of protection.

Ordering data

Article No.

Front panel mounting kit

Width 4 U

6AG1057-1AA00-0AA0

Width 4 U, with keys

6AG1057-1AA00-0AA3

Width 8 U

6AG1057-1AA00-0AA1

Width 8 U, with keys

6AG1057-1AA00-0AA2

SIMATIC S7-1200 Basic Controllers

**3/2 Introduction**

3/2 S7-1200

3/4 Central processing unitsStandard CPUs

3/4 CPU 1211C

3/8 CPU 1212C

3/12 CPU 1214C

3/16 CPU 1215C

3/20 CPU 1217C

SIPLUS standard CPUs

3/23 SIPLUS CPU 1211C

3/27 SIPLUS CPU 1212C

3/31 SIPLUS CPU 1214C

3/36 SIPLUS CPU 1215C

Fail-safe CPUs

3/41 CPU 1212 FC, CPU 1214 FC, CPU 1215 FC

SIPLUS fail-safe CPUs

3/46 SIPLUS CPU 1214 FC

3/48 I/O modulesDigital modules

3/48 SM 1221 digital input modules

3/51 SB 1221 digital input modules

3/53 SM 1222 digital output modules

3/56 SB 1222 digital output modules

3/58 SM 1223 digital input/output modules

3/62 SB 1223 digital input/output modules

SIPLUS digital modules

3/65 SIPLUS SM 1221 digital input modules

3/67 SIPLUS SB 1221 digital input modules

3/68 SIPLUS SM 1222 digital output modules

3/71 SIPLUS SB 1222 digital output modules

3/72 SIPLUS SM 1223 digital input/output modules

3/75 SIPLUS SB 1223 digital input/output modules

Analog modules

3/77 SM 1231 analog input modules

3/80 SB 1231 analog input modules

3/82 SM 1232 analog output modules

3/85 SB 1232 analog output modules

3/87 SM 1234 analog input/output modules

3/89 SM 1231 thermocouple modules

3/92 SB 1231 thermocouple signal boards

3/94 SM 1231 RTD signal modules

3/97 SB 1231 RTD signal boards

3/99 SM 1238 Energy Meter 480 V AC analog input modules

SIPLUS analog modules

3/101 SIPLUS SM 1231 analog input modules

3/102 SIPLUS SM 1232 analog output modules

3/103 SIPLUS SB 1232 analog output modules

3/105 SIPLUS SM 1234 analog input/output modules

3/107 SIPLUS SM 1231 thermocouple modules

3/108 SIPLUS RTD SM 1231 signal modules

Special modules

3/110 SM 1278 4xIO-Link Master

3/111 SIPLUS CMS1200 SM 1281

Condition Monitoring

3/113 SIM 1274 simulators

3/114 Battery Board BB 1297

3/115 SIWAREX WP231

3/118 SIWAREX WP241

3/120 SIWAREX WP251

Communication

3/122 CM 1241 communication modules

3/124 CB 1241 RS 485 communication boards

3/125 CM 1242-5

3/127 CM 1243-2

3/129 CM 1243-5

3/131 CSM 1277 unmanaged

3/133 CP 1243-1

3/136 CP 1242-7 V2 GPRS

3/139 CP 1243-7 LTE

3/142 CP 1243-8 IRC

3/145 CP 1243-1 DNP3

3/147 CP 1243-1 IEC

3/149 SIMATIC RF120C

SIPLUS communication

3/151 SIPLUS CM 1241 communication modules

3/153 SIPLUS CB 1241 RS 485 communication board

3/154 SIPLUS CM 1242-5 communication modules

3/155 SIPLUS CM 1243-5 communication modules

3/156 SIPLUS NET CSM 1277

Fail-safe digital modules

3/157 SM 1226 fail-safe digital input modules

3/159 SM 1226 fail-safe digital output modules

3/161 SM 1226 fail-safe relay output modules

3/163 SIPLUS Fail-safe digital modules

3/166 Power supplies

3/166 Single phase, 24 V DC (for S7-1200)

3/168 Single phase, 24 V DC (for SIPLUS S7-1200)

3/170 Operator control and monitoringBasic Panels3/170 Standard devices 2nd Generation3/171 Standard devices 1st GenerationComfort Panels

3/172 Standard devices

3/174 SIPLUS operator control and monitoring3/174 SIPLUS Basic Panels (2nd Generation)3/176 SIPLUS Basic Panels (1st Generation)

3/178 SIPLUS Comfort Panels

3/182 Add-on products from third-party manufacturers

3/182 SIMATIC S7-1200 CM CANopen

Brochures

For brochures serving as selection guides for SIMATIC products, refer to:

www.siemens.com/simatic/printmaterial

SIMATIC S7-1200 Basic Controllers

Introduction

S7-1200

Overview



- Compact controllers for the low to mid-performance ranges
- Large-scale integration, space-saving, powerful
- With exceptional real-time performance and powerful communication options:
 - Controller with integrated PROFINET IO interface for communication between SIMATIC controllers, HMI, programming device or other automation components
- All CPUs can be used in stand-alone mode, in networks and within distributed structures
- Extremely simple installation, programming and operation
- Integrated web server with standard and user-specific web pages
- Data logging functionality for archiving of data at runtime from the user program
- Powerful, integrated technology functions such as counting, measuring, closed-loop control, and motion control
- Integrated digital and analog inputs/outputs
- Flexible expansion facilities
 - Signal boards for direct use in a controller
 - Signal modules for expansion of controllers with input/output channels; including an Energy Meter module for recording and preparing energy data
 - Accessories, e.g. power supply, switch module or SIMATIC Memory Card

Technical specifications

General technical specifications SIMATIC S7-1200	
Degree of protection	IP20 acc. to IEC 529
Ambient temperature	
• Operation (95% humidity)	
- Horizontal installation	-20 ... +60 °C
- Vertical installation	-20 ... +50 °C
• Transportation and storage	
- With 95% humidity	-40 ... +70 °C
	25 ... 55 °C
Insulation	
• 5/24 V DC circuits	500 V AC test voltage
• 115/230 V AC circuits to ground	1500 V AC test voltage
• 115/230 V AC circuits to 115/230 V AC circuits	1500 V AC test voltage
• 230 V AC circuits to 5/24 V DC circuits	1500 V AC test voltage
• 115 V AC circuits to 5/24 V DC circuits	1500 V AC test voltage
Electromagnetic compatibility	
• Noise immunity acc. to EN 50082-2	Requirements of the EMC directive Test acc. to: IEC 801-2, IEC 801-3, IEC 801-4, EN 50141, EN 50204, IEC 801-5, VDE 0160
• Emitted interference acc. to EN 50081-1 and EN 50081-2	Test according to EN 55011, Class A, Group 1
Mechanical strength	
• Vibrations, test acc. to / tested with	IEC 68, Part 2-6: 10 ... 57 Hz; constant amplitude 0.3 mm; 58 ... 150 Hz; constant acceleration 1 g (mounted on DIN rail) or 2 g (mounted in switchboard); mode of vibration: frequency sweeps with a sweep rate of 1 octave/minute; duration of vibration: 10 frequency sweeps per axis in each direction of the three mutually perpendicular axes
• Shocks, test acc. to / tested with	IEC 68, Part 2-27/half-sine: magnitude of shock 15 g (peak value), duration 11 ms, 6 shocks in each of the three mutually perpendicular axes

General technical specifications SIPLUS S7-1200	
Ambient temperature range	-40/-25/-20 ... +55/+60/+70 °C
Conformal coating	Coating of the printed circuit boards and the electronic components
Technical specifications	The technical specifications of the standard product apply except for the ambient conditions.

Ambient conditions

Extended range of environmental conditions	
• with reference to ambient temperature, air pressure and altitude	Tmin ... Tmax at 1080 hPa ... 795 hPa (-1000 m ... +2000 m) // Tmin ... (Tmax - 10K) at 795 hPa ... 658 hPa (+2000 m ... +3500 m) // Tmin ... (Tmax - 20K) at 658 hPa ... 540 hPa (+3500 m ... +5000 m)
• At cold restart, min.	0° C
Relative humidity	
• with condensation, max.	100%; RH incl. bedewing/frost (no commissioning in bedewed state)
Resistance	
• to biologically active substances/ compliance with EN 60721-3-3	Yes; Class 3B2 mold and fungal spores (except fauna); the supplied plug covers must remain in place on the unused interfaces during operation.
• to chemically active substances/ compliance with EN 60721-3-3	Yes; Class 3C4 (RH < 75%) incl. salt spray in accordance with EN 60068-2-52 (severity 3); the supplied plug covers must remain in place on the unused interfaces during operation.
• to mechanically active substances, compliance with EN 60721-3-3	Yes; Class 3S4 incl. sand, dust; the supplied plug covers must remain in place on unused interfaces during operation.

SIMATIC S7-1200 Basic Controllers

Central processing units
Standard CPUs

CPU 1211C

Overview



- Controller for intro to S7
- Expandable by:
 - 1 signal board (SB), battery board (BB) or communication board (CB)
 - Max. 3 communication modules (CM)

Technical specifications

Article number	6ES7211-1BE40-0XB0	6ES7211-1AE40-0XB0	6ES7211-1HE40-0XB0
	CPU 1211C, AC/DC/RELAY, 6DI/4DO/2AI	CPU 1211C, DC/DC/DC, 6DI/4DO/2AI	CPU 1211C, DC/DC/RELAY, 6DI/4DO/2AI
General information			
Product type designation	CPU 1211C AC/DC/Relay	CPU 1211C DC/DC/DC	CPU 1211C DC/DC/Relay
Engineering with			
• Programming package	STEP 7 V14 or higher	STEP 7 V14 or higher	STEP 7 V14 or higher
Supply voltage			
Rated value (DC)		Yes	Yes
• 24 V DC			
Rated value (AC)	Yes		
• 120 V AC	Yes		
• 230 V AC	Yes		
Encoder supply			
24 V encoder supply			
• 24 V	20.4 to 28.8V	L+ minus 4 V DC min.	L+ minus 4 V DC min.
Power loss			
Power loss, typ.	10 W	8 W	8 W
Memory			
Work memory			
• integrated	50 kbyte	50 kbyte	50 kbyte
Load memory			
• integrated	1 Mbyte	1 Mbyte	1 Mbyte
• Plug-in (SIMATIC Memory Card), max.	with SIMATIC memory card	with SIMATIC memory card	with SIMATIC memory card
Backup			
• without battery	Yes	Yes	Yes
CPU processing times			
for bit operations, typ.	0.085 µs; / instruction	0.085 µs; / instruction	0.085 µs; / instruction
for word operations, typ.	1.7 µs; / instruction	1.7 µs; / instruction	1.7 µs; / instruction
for floating point arithmetic, typ.	2.3 µs; / instruction	2.3 µs; / instruction	2.3 µs; / instruction
Data areas and their retentivity			
Flag			
• Number, max.	4 kbyte; Size of bit memory address area	4 kbyte; Size of bit memory address area	4 kbyte; Size of bit memory address area
Process image			
• Inputs, adjustable	1 kbyte	1 kbyte	1 kbyte
• Outputs, adjustable	1 kbyte	1 kbyte	1 kbyte
Time of day			
Clock			
• Hardware clock (real-time)	Yes	Yes	Yes

Technical specifications (continued)

Article number	6ES7211-1BE40-0XB0 CPU 1211C, AC/DC/RELAY, 6DI/4DO/2AI	6ES7211-1AE40-0XB0 CPU 1211C, DC/DC/DC, 6DI/4DO/2AI	6ES7211-1HE40-0XB0 CPU 1211C, DC/DC/RELAY, 6DI/4DO/2AI
Digital inputs			
Number of digital inputs	6; Integrated	6; Integrated	6; Integrated
• of which inputs usable for technological functions	3; HSC (High Speed Counting)	3; HSC (High Speed Counting)	3; HSC (High Speed Counting)
Digital outputs			
Number of digital outputs	4; Relays	4	4; Relays
• of which high-speed outputs		4; 100 kHz Pulse Train Output	
Analog inputs			
Number of analog inputs	2	2	2
Input ranges			
• Voltage	Yes	Yes	Yes
Analog outputs			
Number of analog outputs	0	0	0
1. Interface			
Interface type	PROFINET	PROFINET	PROFINET
Physics	Ethernet	Ethernet	Ethernet
Functionality			
• PROFINET IO Controller	Yes	Yes	Yes
• PROFINET IO Device	Yes	Yes	Yes
• SIMATIC communication	Yes	Yes	Yes
• Open IE communication	Yes	Yes	Yes
• Web server	Yes	Yes	Yes
• Media redundancy	No	No	No
Communication functions			
S7 communication			
• supported	Yes	Yes	Yes
Open IE communication			
• TCP/IP	Yes	Yes	Yes
• ISO-on-TCP (RFC1006)	Yes	Yes	Yes
• UDP	Yes	Yes	Yes
Web server			
• supported	Yes	Yes	Yes
Number of connections			
• overall	16; dynamically	16; dynamically	16; dynamically
Integrated Functions			
Number of counters	3	6	3
Counting frequency (counter) max.	100 kHz	100 kHz	100 kHz
Frequency meter	Yes	Yes	Yes
controlled positioning	Yes	Yes	Yes
Number of position-controlled positioning axes, max.	8	8	8
Number of positioning axes via pulse-direction interface	Up to 4 with SB 1222	4; With integrated outputs	Up to 4 with SB 1222
PID controller	Yes	Yes	Yes
Number of alarm inputs	4	4	4
Number of pulse outputs		4	
Limit frequency (pulse)		100 kHz	
Ambient conditions			
Ambient temperature during operation			
• min.	-20 °C	-20 °C	-20 °C
• max.	60 °C	60 °C	60 °C
Pollutant concentrations			
- SO ₂ at RH < 60% without condensation	SO ₂ : < 0.5 ppm; H ₂ S: < 0.1 ppm; RH < 60% condensation-free	SO ₂ : < 0.5 ppm; H ₂ S: < 0.1 ppm; RH < 60% condensation-free	SO ₂ : < 0.5 ppm; H ₂ S: < 0.1 ppm; RH < 60% condensation-free

SIMATIC S7-1200 Basic Controllers

Central processing units
Standard CPUs

CPU 1211C

Technical specifications (continued)

Article number	6ES7211-1BE40-0XB0	6ES7211-1AE40-0XB0	6ES7211-1HE40-0XB0
	CPU 1211C, AC/DC/RELAY, 6DI/4DO/2AI	CPU 1211C, DC/DC/DC, 6DI/4DO/2AI	CPU 1211C, DC/DC/RELAY, 6DI/4DO/2AI
Configuration			
Programming			
Programming language			
- LAD	Yes	Yes	Yes
- FBD	Yes	Yes	Yes
- SCL	Yes	Yes	Yes
Dimensions			
Width	90 mm	90 mm	90 mm
Height	100 mm	100 mm	100 mm
Depth	75 mm	75 mm	75 mm
Weights			
Weight, approx.	420 g	370 g	380 g

Ordering data

Article No.	Article No.
CPU 1211C	
Compact CPU, AC/DC/relay; Integrated program/data memory 50 KB, load memory 1 MB; Wide-range power supply 85 ... 264 V AC; Boolean execution times 0.1 µs per operation; 6 digital inputs, 4 digital outputs (relays), 2 analog inputs; Expandable by up to 3 communication modules and 1 signal board/communication board; Digital inputs can be used as HSC at 100 kHz	6ES7211-1BE40-0XB0
Compact CPU, DC/DC/DC; Integrated program/data memory 50 KB, load memory 1 MB; Power supply 24 V DC; Boolean execution times 0.1 µs per operation; 6 digital inputs, 4 digital outputs, 2 analog inputs; Expandable by up to 3 communication modules and 1 signal board/communication board; Digital inputs can be used as HSC at 100 kHz, 24 V DC digital outputs can be used as pulse outputs (PTO) or pulse-width modulated outputs (PWM) at 100 kHz	6ES7211-1AE40-0XB0
Compact CPU, DC/DC/relay; Integrated program/data memory 50 KB, load memory 1 MB; Power supply 24 V DC; Boolean execution times 0.1 µs per operation; 6 digital inputs, 4 digital outputs (relays), 2 analog inputs; Expandable by up to 3 communication modules and 1 signal board/communication board; Digital inputs can be used as HSC at 100 kHz	6ES7211-1HE40-0XB0
SB 1221 signal board 4 inputs, 5 V DC, 200 kHz 4 inputs, 24 V DC, 200 kHz	6ES7221-3AD30-0XB0 6ES7221-3BD30-0XB0
SB 1222 signal board 4 outputs, 5 V DC, 0.1 A, 200 kHz 4 outputs, 24 V DC, 0.1 A, 200 kHz	6ES7222-1AD30-0XB0 6ES7222-1BD30-0XB0
SB 1223 signal board 2 inputs, 24 V DC, IEC type 1 current sinking; 2 x 24 V DC transistor outputs, 0.5 A, 5 W; can be used as HSC at up to 30 kHz 2 inputs, 5 V DC, 200 kHz 2 outputs 5 V DC, 0.1 A, 200 kHz 2 inputs, 24 V DC, 200 kHz 2 outputs 24 V DC, 0.1 A, 200 kHz	6ES7223-0BD30-0XB0 6ES7223-3AD30-0XB0 6ES7223-3BD30-0XB0
SB 1231 signal board 1 analog input, ±10 V with 12 bits or 0 ... 20 mA with 11 bits	6ES7231-4HA30-0XB0
SB 1231 thermocouple signal board 1 input +/- 80 mV, resolution 15 bits + sign, thermocouples type J, K	6ES7231-5QA30-0XB0
RTD signal board SB 1231 1 input for resistance temperature sensors Pt 100, Pt 200, Pt 500, Pt 1000, resolution 15 bits + sign	6ES7231-5PA30-0XB0
SB 1232 signal board 1 analog output, ±10 V with 12 bits or 0 to 20 mA with 11 bits	6ES7232-4HA30-0XB0
CB 1241 RS 485 communication board For point-to-point connection, with 1 RS 485 interface	6ES7241-1CH30-1XB0

Ordering data	Article No.	Article No.
Battery board BB1297 For long-term backup of real-time clock, can be plugged into the signal board slot; battery (CR1025) is not included	6ES7297-0AX30-0XA0	STEP 7 Professional / Basic V14 SP1 Target system: SIMATIC S7-1200, S7-1500, S7-300, S7-400, WinAC Requirement: Windows 7 Professional SP1 (64-bit), Windows 7 Enterprise SP1 (64-bit), Windows 7 Ultimate SP1 (64-bit), Windows 8.1 Professional (64-bit), Windows 8.1 Enterprise (64-bit), Windows 10 Professional Version 1607, Windows 10 Enterprise Version 1607, Windows 10 Enterprise 2016 LTSB, Windows 10 Enterprise 2015 LTSB, Windows Server 2008 R2 StdE (full installation), Windows Server 2012 StdE (full installation), Windows Server 2016 Standard (full installation); STEP 7 Basic V14 SP1 in addition: Windows 7 Home Premium SP1 (64-bit), Windows 8.1 (64-bit), Windows 10 Home Version 1607 Type of delivery: German, English, Chinese, Italian, French, Spanish STEP 7 Professional V14 SP1, floating license STEP 7 Professional V14 SP1, floating license, software download incl. license key ¹⁾ Email address required for delivery STEP 7 Basic V14 SP1, floating license STEP 7 Basic V14 SP1, floating license, software download incl. license key ¹⁾ Email address required for delivery
Digital input simulator SIM 1274 simulator module (optional) 8 input switches, for CPU 1211C / CPU 1212C	6ES7274-1XF30-0XA0	
Analog input simulator SIM 1274 simulator module (optional) 2 potentiometers	6ES7274-1XA30-0XA0	
SIMATIC Memory Card (optional) 4 MB 12 MB 24 MB 256 MB 2 GB 32 GB	6ES7954-8LC02-0AA0 6ES7954-8LE02-0AA0 6ES7954-8LF02-0AA0 6ES7954-8LL02-0AA0 6ES7954-8LP02-0AA0 6ES7954-8LT03-0AA0	
Terminal block (spare part) For CPU 1211C AC/DC/relay • For DI, with 14 screws, tin-coated, coded; 4 units • For DO, with 8 screws, tin-coated, coded; 4 units • For AI, with 3 screws, gold-plated; 4 units For CPU 1211C DC/DC/DC • For DI, with 14 screws, tin-coated; 4 units • For DO, with 8 screws, tin-coated; 4 units • For AI, with 3 screws, gold-plated; 4 units For CPU 1211C DC/DC/relay • For DI, with 14 screws, tin-coated; 4 units • For DO, with 8 screws, tin-coated, coded; 4 units • For AI, with 3 screws, gold-plated; 4 units	6ES7292-1AP40-0XA0 6ES7292-1AH40-0XA0 6ES7292-1BC30-0XA0 6ES7292-1AP30-0XA0 6ES7292-1AH30-0XA0 6ES7292-1BC30-0XA0 6ES7292-1AP30-0XA0 6ES7292-1AH40-0XA0 6ES7292-1BC30-0XA0	
RJ45 cable grip 4 units per pack Single port	6ES7290-3AA30-0XA0	
Front flap set (spare part) For CPU 1211C/1212C	6ES7291-1AA30-0XA0	

¹⁾ For up-to-date information and download availability, see:
<http://www.siemens.com/tia-online-software-delivery>

SIMATIC S7-1200 Basic Controllers

Central processing units
Standard CPUs

CPU 1212C

Overview



- Controller for intro to S7 with basic expansion options
- Expandable by:
 - 1 signal board (SB), battery board (BB) or communication board (CB)
 - 2 signal modules (SM)
 - Max. 3 communication modules (CM)

Technical specifications

Article number	6ES7212-1BE40-0XB0	6ES7212-1AE40-0XB0	6ES7212-1HE40-0XB0
	CPU 1212C, AC/DC/RELAY, 8DI/6DO/2AI	CPU 1212C, DC/DC/DC, 8DI/6DO/2AI	CPU 1212C, DC/DC/RELAY, 8DI/6DO/2AI
General information			
Product type designation	CPU 1212C AC/DC/Relay	CPU 1212C DC/DC/DC	CPU 1212C DC/DC/Relay
Engineering with			
• Programming package	STEP 7 V14 or higher	STEP 7 V14 or higher	STEP 7 V14 or higher
Supply voltage			
Rated value (DC)		Yes	Yes
• 24 V DC			
Rated value (AC)	Yes		
• 120 V AC	Yes		
• 230 V AC	Yes		
Encoder supply			
24 V encoder supply			
• 24 V	20.4 to 28.8V	L+ minus 4 V DC min.	L+ minus 4 V DC min.
Power loss			
Power loss, typ.	11 W	9 W	9 W
Memory			
Work memory			
• integrated	75 kbyte	75 kbyte	75 kbyte
Load memory			
• integrated	2 Mbyte	2 Mbyte	2 Mbyte
• Plug-in (SIMATIC Memory Card), max.	with SIMATIC memory card	with SIMATIC memory card	with SIMATIC memory card
Backup			
• without battery	Yes	Yes	Yes
CPU processing times			
for bit operations, typ.	0.085 µs; / instruction	0.085 µs; / instruction	0.085 µs; / instruction
for word operations, typ.	1.7 µs; / instruction	1.7 µs; / instruction	1.7 µs; / instruction
for floating point arithmetic, typ.	2.3 µs; / instruction	2.3 µs; / instruction	2.3 µs; / instruction
Data areas and their retentivity			
Flag			
• Number, max.	4 kbyte; Size of bit memory address area	4 kbyte; Size of bit memory address area	4 kbyte; Size of bit memory address area
Process image			
• Inputs, adjustable	1 kbyte	1 kbyte	1 kbyte
• Outputs, adjustable	1 kbyte	1 kbyte	1 kbyte

Technical specifications (continued)

Article number	6ES7212-1BE40-0XB0 CPU 1212C, AC/DC/RELAY, 8DI/6DO/2AI	6ES7212-1AE40-0XB0 CPU 1212C ,DC/DC/DC, 8DI/6DO/2AI	6ES7212-1HE40-0XB0 CPU 1212C, DC/DC/RELAY, 8DI/6DO/2AI
Time of day			
Clock			
• Hardware clock (real-time)	Yes	Yes	Yes
Digital inputs			
Number of digital inputs	8; Integrated	8; Integrated	8; Integrated
• of which inputs usable for technological functions	4; HSC (High Speed Counting)	4; HSC (High Speed Counting)	4; HSC (High Speed Counting)
Digital outputs			
Number of digital outputs	6; Relays	6	6; Relays
• of which high-speed outputs		4; 100 kHz Pulse Train Output	
Analog inputs			
Number of analog inputs	2	2	2
Input ranges			
• Voltage	Yes	Yes	Yes
Analog outputs			
Number of analog outputs	0	0	0
1. Interface			
Interface type	PROFINET	PROFINET	PROFINET
Physics	Ethernet	Ethernet	Ethernet
Functionality			
• PROFINET IO Controller	Yes	Yes	Yes
• PROFINET IO Device	Yes	Yes	Yes
• SIMATIC communication	Yes	Yes	Yes
• Open IE communication	Yes	Yes	Yes
• Web server	Yes	Yes	Yes
• Media redundancy	No	No	No
Communication functions			
S7 communication			
• supported	Yes	Yes	Yes
Open IE communication			
• TCP/IP	Yes	Yes	Yes
• ISO-on-TCP (RFC1006)	Yes	Yes	Yes
• UDP	Yes	Yes	Yes
Web server			
• supported	Yes	Yes	Yes
Number of connections			
• overall	16; dynamically	16; dynamically	16; dynamically
Integrated Functions			
Number of counters	4	4	4
Counting frequency (counter) max.	100 kHz	100 kHz	100 kHz
Frequency meter	Yes	Yes	Yes
controlled positioning	Yes	Yes	Yes
Number of position-controlled positioning axes, max.	8	8	8
Number of positioning axes via pulse-direction interface	Up to 4 with SB 1222	4; With integrated outputs	Up to 4 with SB 1222
PID controller	Yes	Yes	Yes
Number of alarm inputs	4	4	4
Number of pulse outputs		4	
Limit frequency (pulse)		100 kHz	

SIMATIC S7-1200 Basic Controllers

Central processing units
Standard CPUs

CPU 1212C

Technical specifications (continued)

Article number	6ES7212-1BE40-0XB0	6ES7212-1AE40-0XB0	6ES7212-1HE40-0XB0
	CPU 1212C, AC/DC/RELAY, 8DI/6DO/2AI	CPU 1212C, DC/DC/DC, 8DI/6DO/2AI	CPU 1212C, DC/DC/RELAY, 8DI/6DO/2AI
Ambient conditions			
Ambient temperature during operation			
• min.	-20 °C	-20 °C	-20 °C
• max.	60 °C; Number of simultaneously activated inputs or outputs 4 or 3 (no adjacent points) at 60 °C horizontal or 50 °C vertical, 8 or 6 at 55 °C horizontal or 45 °C vertical	60 °C; Number of simultaneously activated inputs or outputs 4 or 3 (no adjacent points) at 60 °C horizontal or 50 °C vertical, 8 or 6 at 55 °C horizontal or 45 °C vertical	60 °C; Number of simultaneously activated inputs or outputs 4 or 3 (no adjacent points) at 60 °C horizontal or 50 °C vertical, 8 or 6 at 55 °C horizontal or 45 °C vertical
Pollutant concentrations			
- SO ₂ at RH < 60% without condensation	SO ₂ : < 0.5 ppm; H ₂ S: < 0.1 ppm; RH < 60% condensation-free	SO ₂ : < 0.5 ppm; H ₂ S: < 0.1 ppm; RH < 60% condensation-free	SO ₂ : < 0.5 ppm; H ₂ S: < 0.1 ppm; RH < 60% condensation-free
Configuration			
Programming			
Programming language			
- LAD	Yes	Yes	Yes
- FBD	Yes	Yes	Yes
- SCL	Yes	Yes	Yes
Dimensions			
Width	90 mm	90 mm	90 mm
Height	100 mm	100 mm	100 mm
Depth	75 mm	75 mm	75 mm
Weights			
Weight, approx.	425 g	370 g	385 g

Ordering data

Article No.	Article No.
CPU 1212C	
Compact CPU, AC/DC/relay; Integrated program/data memory 75 KB, load memory 2 MB; Wide-range power supply 85 ... 264 V AC; Boolean execution times 0.1 μs per operation; 8 digital inputs, 6 digital outputs (relays), 2 analog inputs; Expandable by up to 3 communication modules, 2 signal modules and 1 signal board/communication board; Digital inputs can be used as HSC at 100 kHz	6ES7212-1BE40-0XB0
Compact CPU, DC/DC/DC; Integrated program/data memory 75 KB, load memory 2 MB; Power supply 24 V DC; Boolean execution times 0.1 μs per operation; 8 digital inputs, 6 digital outputs, 2 analog inputs; Expandable by up to 3 communication modules, 2 signal modules, and 1 signal board/communication board; Digital inputs can be used as HSC at 100 kHz, 24 V DC digital outputs can be used as pulse outputs (PTO) or pulse-width modulated outputs (PWM) at 100 kHz	6ES7212-1AE40-0XB0
Compact CPU, DC/DC/relay; integrated program/data memory 75 KB, load memory 2 MB; power supply 24 V DC; Boolean execution times 0.1 μs per operation; 8 digital inputs, 6 digital outputs (relays), 2 analog inputs; expandable by up to 3 communication modules, 2 signal modules, and 1 signal board/communication board; digital inputs can be used as HSC at 100 kHz	6ES7212-1HE40-0XB0
SB 1221 signal board	
4 inputs, 5 V DC, 200 kHz	6ES7221-3AD30-0XB0
4 inputs, 24 V DC, 200 kHz	6ES7221-3BD30-0XB0
SB 1222 signal board	
4 outputs, 5 V DC, 0.1 A, 200 kHz	6ES7222-1AD30-0XB0
4 outputs, 24 V DC, 0.1 A, 200 kHz	6ES7222-1BD30-0XB0
SB 1223 signal board	
2 inputs, 24 V DC, IEC type 1 current sinking; 2 x 24 V DC transistor outputs, 0.5 A, 5 W; can be used as HSC at up to 30 kHz	6ES7223-0BD30-0XB0
2 inputs, 5 V DC, 200 kHz	6ES7223-3AD30-0XB0
2 outputs 5 V DC, 0.1 A, 200 kHz	6ES7223-3BD30-0XB0
2 inputs, 24 V DC, 200 kHz 2 outputs 24 V DC, 0.1 A, 200 kHz	6ES7231-4HA30-0XB0
SB 1231 signal board	
1 analog input, ±10 V with 12 bits or 0 ... 20 mA with 11 bits	

Ordering data	Article No.	Terminal block (spare part) (cont.)	Article No.
SB 1231 thermocouple signal board 1 input +/- 80 mV, resolution 15 bits + sign, thermocouples type J, K	6ES7231-5QA30-0XB0	For CPU 1212C DC/DC/DC	
RTD signal board SB 1231 1 input for resistance temperature sensors Pt 100, Pt 200, Pt 500, Pt 1000, resolution 15 bits + sign	6ES7231-5PA30-0XB0	• For DI, with 14 screws, tin-coated; 4 units	6ES7292-1AP30-0XA0
SB 1232 signal board 1 analog output, ±10 V with 12 bits or 0 to 20 mA with 11 bits	6ES7232-4HA30-0XB0	• For DO, with 8 screws, tin-coated; 4 units	6ES7292-1AH30-0XA0
CB 1241 RS 485 communication board For point-to-point connection, with 1 RS 485 interface	6ES7241-1CH30-1XB0	• For AI, with 3 screws, gold-plated; 4 units	6ES7292-1BC30-0XA0
BB1297 battery board For long-term backup of real-time clock, can be plugged into the signal board slot; battery (CR1025) is not included	6ES7297-0AX30-0XA0	For CPU 1212C DC/DC/relay	
Digital input simulator SIM 1274 simulator module (optional) 8 input switches, for CPU 1211C / CPU 1212C	6ES7274-1XF30-0XA0	• For DI, with 14 screws, tin-coated; 4 units	6ES7292-1AP30-0XA0
Analog input simulator SIM 1274 simulator module (optional) 2 potentiometers	6ES7274-1XA30-0XA0	• For DO, with 8 screws, tin-coated, coded; 4 units	6ES7292-1AH40-0XA0
SIMATIC Memory Card (optional) 4 MB	6ES7954-8LC02-0AA0	• For AI, with 3 screws, gold-plated; 4 units	6ES7292-1BC30-0XA0
12 MB	6ES7954-8LE02-0AA0	RJ45 cable grip	
24 MB	6ES7954-8LF02-0AA0	4 units per pack	
256 MB	6ES7954-8LL02-0AA0	Single port	6ES7290-3AA30-0XA0
2 GB	6ES7954-8LP02-0AA0	Front flap set (spare part)	
32 GB	6ES7954-8LT03-0AA0	For CPU 1211C/1212C	6ES7291-1AA30-0XA0
Extension cable for two-tier configuration For connecting digital/analog signal modules; length 2 m	6ES7290-6AA30-0XA0	STEP 7 Professional / Basic V14 SP1	
Starter box CPU 1212C AC/DC/relay Complete offer SIMATIC S7-1200, starter box, comprising: CPU 1212C AC/DC/relay, simulator, STEP 7 BASIC CD, manual CD, info material, in Systainer	6ES7212-1BD34-4YB0	Target system: SIMATIC S7-1200, S7-1500, S7-300, S7-400, WinAC	
Terminal block (spare part) For CPU 1212C AC/DC/relay		Requirement: Windows 7 Professional SP1 (64-bit), Windows 7 Enterprise SP1 (64-bit), Windows 7 Ultimate SP1 (64-bit), Windows 8.1 Professional (64-bit), Windows 8.1 Enterprise (64-bit), Windows 10 Professional Version 1607, Windows 10 Enterprise Version 1607, Windows 10 Enterprise 2016 LTSC, Windows 10 Enterprise 2015 LTSC, Windows Server 2008 R2 StdE (full installation), Windows Server 2012 StdE (full installation), Windows Server 2016 Standard (full installation);	
• For DI, with 14 screws, tin-coated, coded; 4 units	6ES7292-1AP40-0XA0	STEP 7 Basic V14 SP1 in addition: Windows 7 Home Premium SP1 (64-bit), Windows 8.1 (64-bit), Windows 10 Home Version 1607	
• For DO, with 8 screws, tin-coated, coded; 4 units	6ES7292-1AH40-0XA0	Type of delivery: German, English, Chinese, Italian, French, Spanish	
• For AI, with 3 screws, gold-plated; 4 units	6ES7292-1BC30-0XA0	STEP 7 Professional V14 SP1, floating license	6ES7822-1AA04-0YA5
		STEP 7 Professional V14 SP1, floating license, software download incl. license key ¹⁾	6ES7822-1AE04-0YA5
		Email address required for delivery	
		STEP 7 Basic V14 SP1, floating license	6ES7822-0AA04-0YA5
		STEP 7 Basic V14 SP1, floating license, software download incl. license key ¹⁾	6ES7822-0AE04-0YA5
		Email address required for delivery	

¹⁾ For up-to-date information and download availability, see:
<http://www.siemens.com/tia-online-software-delivery>

SIMATIC S7-1200 Basic Controllers

Central processing units
Standard CPUs

CPU 1214C

Overview



- Controller for intro to S7 with flexible expansion options
- Expandable by:
 - 1 signal board (SB), battery board (BB) or communication board (CB)
 - 8 signal modules (SM)
 - Max. 3 communication modules (CM)

Technical specifications

Article number	6ES7214-1BG40-0XB0	6ES7214-1AG40-0XB0	6ES7214-1HG40-0XB0
	CPU 1214C, AC/DC/RELAY, 14DI/10DO/2AI	CPU 1214C, DC/DC/DC, 14DI/10DO/2AI	CPU 1214C, DC/DC/RELAY, 14DI/10DO/2AI
General information			
Product type designation	CPU 1214C AC/DC/Relay	CPU 1214C DC/DC/DC	CPU 1214C DC/DC/Relay
Engineering with			
• Programming package	STEP 7 V14 or higher	STEP 7 V14 or higher	STEP 7 V14 or higher
Supply voltage			
Rated value (DC)		Yes	Yes
• 24 V DC			
Rated value (AC)	Yes		
• 120 V AC	Yes		
• 230 V AC	Yes		
Encoder supply			
24 V encoder supply			
• 24 V	20.4 to 28.8V	L+ minus 4 V DC min.	L+ minus 4 V DC min.
Power loss			
Power loss, typ.	14 W	12 W	12 W
Memory			
Work memory			
• integrated	100 kbyte	100 kbyte	100 kbyte
Load memory			
• integrated	4 Mbyte	4 Mbyte	4 Mbyte
• Plug-in (SIMATIC Memory Card), max.	with SIMATIC memory card	with SIMATIC memory card	with SIMATIC memory card
Backup			
• without battery	Yes	Yes	Yes
CPU processing times			
for bit operations, typ.	0.085 µs; / instruction	0.085 µs; / instruction	0.085 µs; / instruction
for word operations, typ.	1.7 µs; / instruction	1.7 µs; / instruction	1.7 µs; / instruction
for floating point arithmetic, typ.	2.3 µs; / instruction	2.3 µs; / instruction	2.3 µs; / instruction
Data areas and their retentivity			
Flag			
• Number, max.	8 kbyte; Size of bit memory address area	8 kbyte; Size of bit memory address area	8 kbyte; Size of bit memory address area
Process image			
• Inputs, adjustable	1 kbyte	1 kbyte	1 kbyte
• Outputs, adjustable	1 kbyte	1 kbyte	1 kbyte
Time of day			
Clock			
• Hardware clock (real-time)	Yes	Yes	Yes

Technical specifications (continued)

Article number	6ES7214-1BG40-0XB0 CPU 1214C, AC/DC/RELAY, 14DI/10DO/2AI	6ES7214-1AG40-0XB0 CPU 1214C, DC/DC/DC, 14DI/10DO/2AI	6ES7214-1HG40-0XB0 CPU 1214C, DC/DC/RELAY, 14DI/10DO/2AI
Digital inputs			
Number of digital inputs	14; Integrated	14; Integrated	14; Integrated
• of which inputs usable for technological functions	6; HSC (High Speed Counting)	6; HSC (High Speed Counting)	6; HSC (High Speed Counting)
Digital outputs			
Number of digital outputs	10; Relays	10	10; Relays
• of which high-speed outputs		4; 100 kHz Pulse Train Output	
Analog inputs			
Number of analog inputs	2	2	2
Input ranges			
• Voltage	Yes	Yes	Yes
Analog outputs			
Number of analog outputs	0	0	0
1. Interface			
Interface type	PROFINET	PROFINET	PROFINET
Physics	Ethernet	Ethernet	Ethernet
Functionality			
• PROFINET IO Controller	Yes	Yes	Yes
• PROFINET IO Device	Yes	Yes	Yes
• SIMATIC communication	Yes	Yes	Yes
• Open IE communication	Yes	Yes	Yes
• Web server	Yes	Yes	Yes
• Media redundancy	No	No	No
Communication functions			
S7 communication			
• supported	Yes	Yes	Yes
Open IE communication			
• TCP/IP	Yes	Yes	Yes
• ISO-on-TCP (RFC1006)	Yes	Yes	Yes
• UDP	Yes	Yes	Yes
Web server			
• supported	Yes	Yes	Yes
Number of connections			
• overall	16; dynamically	16; dynamically	16; dynamically
Integrated Functions			
Number of counters	6	6	6
Counting frequency (counter) max.	100 kHz	100 kHz	100 kHz
Frequency meter	Yes	Yes	Yes
controlled positioning	Yes	Yes	Yes
Number of position-controlled positioning axes, max.	8	8	8
Number of positioning axes via pulse-direction interface	Up to 4 with SB 1222	4; With integrated outputs	Up to 4 with SB 1222
PID controller	Yes	Yes	Yes
Number of alarm inputs	4	4	4
Number of pulse outputs		4	
Limit frequency (pulse)		100 kHz	
Ambient conditions			
Ambient temperature during operation			
• min.	-20 °C	-20 °C	-20 °C
• max.	60 °C; Number of simultaneously activated inputs or outputs 7 or 5 (no adjacent points) at 60 °C horizontal or 50 °C vertical, 14 or 10 at 55 °C horizontal or 45 °C vertical	60 °C; Number of simultaneously activated inputs or outputs 7 or 5 (no adjacent points) at 60 °C horizontal or 50 °C vertical, 14 or 10 at 55 °C horizontal or 45 °C vertical	60 °C; Number of simultaneously activated inputs or outputs 7 or 5 (no adjacent points) at 60 °C horizontal or 50 °C vertical, 14 or 10 at 55 °C horizontal or 45 °C vertical
Pollutant concentrations			
- SO ₂ at RH < 60% without condensation	SO ₂ : < 0.5 ppm; H ₂ S: < 0.1 ppm; RH < 60% condensation-free	SO ₂ : < 0.5 ppm; H ₂ S: < 0.1 ppm; RH < 60% condensation-free	SO ₂ : < 0.5 ppm; H ₂ S: < 0.1 ppm; RH < 60% condensation-free

SIMATIC S7-1200 Basic Controllers

Central processing units
Standard CPUs

CPU 1214C

Technical specifications (continued)

Article number	6ES7214-1BG40-0XB0	6ES7214-1AG40-0XB0	6ES7214-1HG40-0XB0
	CPU 1214C, AC/DC/RELAY, 14DI/10DO/2AI	CPU 1214C, DC/DC/DC, 14DI/10DO/2AI	CPU 1214C, DC/DC/RELAY, 14DI/10DO/2AI
Configuration			
Programming			
Programming language			
- LAD	Yes	Yes	Yes
- FBD	Yes	Yes	Yes
- SCL	Yes	Yes	Yes
Dimensions			
Width	110 mm	110 mm	110 mm
Height	100 mm	100 mm	100 mm
Depth	75 mm	75 mm	75 mm
Weights			
Weight, approx.	455 g	415 g	435 g

Ordering data

Article No.	Article No.
CPU 1214C	
Compact CPU, AC/DC/relay; Integrated program/data memory 100 KB, load memory 2 MB; Wide-range power supply 85 ... 264 V AC; Boolean execution times 0.1 μs per operation; 14 digital inputs, 10 digital outputs (relays), 2 analog inputs; Expandable by up to 3 communication modules, 8 signal modules and 1 signal board/communication board; Digital inputs can be used as HSC at 100 kHz	6ES7214-1BG40-0XB0
Compact CPU, DC/DC/DC; Integrated program/data memory 100 KB, load memory 2 MB; Power supply 24 V DC; Boolean execution times 0.1 μs per operation; 14 digital inputs, 10 digital outputs, 2 analog inputs; expandable by up to 3 communication modules, 8 signal modules, and 1 signal board/communication board; Digital inputs can be used as HSC at 100 kHz, 24 V DC digital outputs can be used as pulse outputs (PTO) or pulse-width modulated outputs (PWM) at 100 kHz	6ES7214-1AG40-0XB0
Compact CPU, DC/DC/relay; Integrated program/data memory 100 KB, load memory 2 MB; Power supply 24 V DC; Boolean execution times 0.1 μs per operation; 14 digital inputs, 10 digital outputs (relays), 2 analog inputs; Expandable by up to 3 communication modules, 8 signal modules, and 1 signal board/communication board; Digital inputs can be used as HSC at 100 kHz	6ES7214-1HG40-0XB0
SB 1221 signal board 4 inputs, 5 V DC, 200 kHz 4 inputs, 24 V DC, 200 kHz	6ES7221-3AD30-0XB0 6ES7221-3BD30-0XB0
SB 1222 signal board 4 outputs, 5 V DC, 0.1 A, 200 kHz 4 outputs, 24 V DC, 0.1 A, 200 kHz	6ES7222-1AD30-0XB0 6ES7222-1BD30-0XB0
SB 1223 signal board 2 inputs, 24 V DC, IEC type 1 current sinking; 2 x 24 V DC transistor outputs, 0.5 A, 5 W; can be used as HSC at up to 30 kHz 2 inputs, 5 V DC, 200 kHz 2 outputs 5 V DC, 0.1 A, 200 kHz 2 inputs, 24 V DC, 200 kHz 2 outputs 24 V DC, 0.1 A, 200 kHz	6ES7223-0BD30-0XB0 6ES7223-3AD30-0XB0 6ES7223-3BD30-0XB0
SB 1231 signal board 1 analog input, ±10 V with 12 bits or 0 ... 20 mA with 11 bits	6ES7231-4HA30-0XB0
SB 1231 thermocouple signal board 1 input +/- 80 mV, resolution 15 bits + sign, thermocouples type J, K	6ES7231-5QA30-0XB0
RTD signal board SB 1231 1 input for resistance temperature sensors Pt 100, Pt 200, Pt 500, Pt 1000, resolution 15 bits + sign	6ES7231-5PA30-0XB0
SB 1232 signal board 1 analog output, ±10 V with 12 bits or 0 to 20 mA with 11 bits	6ES7232-4HA30-0XB0
CB 1241 RS 485 communication board For point-to-point connection, with 1 RS 485 interface	6ES7241-1CH30-1XB0

Ordering data	Article No.	Ordering data	Article No.
Battery board BB1297 For long-term backup of real-time clock, can be plugged into the signal board slot; battery (CR1025) is not included	6ES7297-0AX30-0XA0	RJ45 cable grip 4 items per pack Single port	6ES7290-3AA30-0XA0
Digital input simulator SIM 1274 simulator module (optional) 14 input switches, for CPU 1214C/1215C	6ES7274-1XH30-0XA0	Front flap set (spare part) For CPU 1214C	6ES7291-1AB30-0XA0
Analog input simulator SIM 1274 simulator module (optional) 2 potentiometers	6ES7274-1XA30-0XA0	STEP 7 Professional / Basic V14 SP1 Target system: SIMATIC S7-1200, S7-1500, S7-300, S7-400, WinAC Requirement: Windows 7 Professional SP1 (64-bit), Windows 7 Enterprise SP1 (64-bit), Windows 7 Ultimate SP1 (64-bit), Windows 8.1 Professional (64-bit), Windows 8.1 Enterprise (64-bit), Windows 10 Professional Version 1607, Windows 10 Enterprise Version 1607, Windows 10 Enterprise 2016 LTSB, Windows 10 Enterprise 2015 LTSB, Windows Server 2008 R2 StdE (full installation), Windows Server 2012 StdE (full installation), Windows Server 2016 Standard (full installation); STEP 7 Basic V14 SP1 in addition: Windows 7 Home Premium SP1 (64-bit), Windows 8.1 (64-bit), Windows 10 Home Version 1607 Type of delivery: German, English, Chinese, Italian, French, Spanish	
SIMATIC Memory Card (optional) 4 MB 12 MB 24 MB 256 MB 2 GB 32 GB	6ES7954-8LC02-0AA0 6ES7954-8LE02-0AA0 6ES7954-8LF02-0AA0 6ES7954-8LL02-0AA0 6ES7954-8LP02-0AA0 6ES7954-8LT03-0AA0	STEP 7 Professional V14 SP1, floating license STEP 7 Professional V14 SP1, floating license, software download incl. license key ¹⁾ Email address required for delivery	6ES7822-1AA04-0YA5 6ES7822-1AE04-0YA5
Extension cable for two-tier configuration For connecting digital/analog signal modules; length 2 m	6ES7290-6AA30-0XA0	STEP 7 Basic V14 SP1, floating license STEP 7 Basic V14 SP1, floating license, software download incl. license key ¹⁾ Email address required for delivery	6ES7822-0AA04-0YA5 6ES7822-0AE04-0YA5
Terminal block (spare part) For CPU 1214C AC/DC/relay <ul style="list-style-type: none"> • For DI, with 20 screws, tin-coated, coded; 4 units • For DO, with 12 screws, tin-coated, coded; 4 units • For AI, with 3 screws, gold-plated; 4 units For CPU 1214C DC/DC/DC <ul style="list-style-type: none"> • For DI, with 20 screws, tin-coated; 4 units • For DO, with 12 screws, tin-coated; 4 units • For AI, with 3 screws, gold-plated; 4 units For CPU 1214C DC/DC/relay <ul style="list-style-type: none"> • For DI, with 20 screws, tin-coated; 4 units • For DO, with 12 screws, tin-coated, coded; 4 units • For AI, with 3 screws, gold-plated; 4 units 	6ES7292-1AV40-0XA0 6ES7292-1AM40-0XA0 6ES7292-1BC30-0XA0 6ES7292-1AV30-0XA0 6ES7292-1AM30-0XA0 6ES7292-1BC30-0XA0 6ES7292-1AV30-0XA0 6ES7292-1AM40-0XA0 6ES7292-1BC30-0XA0		

¹⁾ For up-to-date information and download availability, see: <http://www.siemens.com/tia-online-software-delivery>

SIMATIC S7-1200 Basic Controllers

Central processing units
Standard CPUs

CPU 1215C

Overview



- Powerful controller with enhanced networking option
- Expandable by:
 - 1 signal board (SB), battery board (BB) or communication board (CB)
 - 8 signal modules (SM)
 - Max. 3 communication modules (CM)

Technical specifications

Article number	6ES7215-1BG40-0XB0	6ES7215-1AG40-0XB0	6ES7215-1HG40-0XB0
	CPU 1215C, AC/DC/RLY, 14DI/10DO/2AI/2AO	CPU 1215C, DC/DC/DC, 14DI/10DO/2AI/2AO	CPU 1215C, DC/DC/RLY, 14DI/10DO/2AI/2AO
General information			
Product type designation	CPU 1215C AC/DC/Relay	CPU 1215C DC/DC/DC	CPU 1215C DC/DC/Relay
Engineering with			
• Programming package	STEP 7 V14 or higher	STEP 7 V14 or higher	STEP 7 V14 or higher
Supply voltage			
Rated value (DC)		Yes	Yes
• 24 V DC			
Rated value (AC)	Yes		
• 120 V AC			
• 230 V AC	Yes		
Encoder supply			
24 V encoder supply			
• 24 V	20.4 to 28.8V	L+ minus 4 V DC min.	L+ minus 4 V DC min.
Power loss			
Power loss, typ.	14 W	12 W	12 W
Memory			
Work memory			
• integrated	125 kbyte	125 kbyte	125 kbyte
Load memory			
• integrated	4 Mbyte	4 Mbyte	4 Mbyte
• Plug-in (SIMATIC Memory Card), max.	with SIMATIC memory card	with SIMATIC memory card	with SIMATIC memory card
Backup			
• without battery	Yes	Yes	Yes
CPU processing times			
for bit operations, typ.	0.085 µs; / instruction	0.085 µs; / instruction	0.085 µs; / instruction
for word operations, typ.	1.7 µs; / instruction	1.7 µs; / instruction	1.7 µs; / instruction
for floating point arithmetic, typ.	2.3 µs; / instruction	2.3 µs; / instruction	2.3 µs; / instruction
Data areas and their retentivity			
Flag			
• Number, max.	8 kbyte; Size of bit memory address area	8 kbyte; Size of bit memory address area	8 kbyte; Size of bit memory address area
Process image			
• Inputs, adjustable	1 kbyte	1 kbyte	1 kbyte
• Outputs, adjustable	1 kbyte	1 kbyte	1 kbyte
Time of day			
Clock			
• Hardware clock (real-time)	Yes	Yes	Yes

Technical specifications (continued)

Article number	6ES7215-1BG40-0XB0 CPU 1215C, AC/DC/RLY, 14DI/10DO/2AI/2AO	6ES7215-1AG40-0XB0 CPU 1215C, DC/DC/DC, 14DI/10DO/2AI/2AO	6ES7215-1HG40-0XB0 CPU 1215C, DC/DC/RLY, 14DI/10DO/2AI/2AO
Digital inputs			
Number of digital inputs	14; Integrated	14; Integrated	14; Integrated
• of which inputs usable for technological functions	6; HSC (High Speed Counting)	6; HSC (High Speed Counting)	6; HSC (High Speed Counting)
Digital outputs			
Number of digital outputs	10; Relays	10	10; Relays
• of which high-speed outputs		4; 100 kHz Pulse Train Output	
Analog inputs			
Number of analog inputs	2	2	2
Input ranges			
• Voltage	Yes	Yes	Yes
Analog outputs			
Number of analog outputs	2	2	2
Output ranges, current			
• 0 to 20 mA	Yes	Yes	Yes
1. Interface			
Interface type	PROFINET	PROFINET	PROFINET
Physics	Ethernet	Ethernet	Ethernet
Functionality			
• PROFINET IO Controller	Yes	Yes	Yes
• PROFINET IO Device	Yes	Yes	Yes
• SIMATIC communication	Yes	Yes	Yes
• Open IE communication	Yes	Yes	Yes
• Web server	Yes	Yes	Yes
• Media redundancy	Yes; as MRP client	Yes; as MRP client	Yes; as MRP client
Communication functions			
S7 communication			
• supported	Yes	Yes	Yes
Open IE communication			
• TCP/IP	Yes	Yes	Yes
• ISO-on-TCP (RFC1006)	Yes	Yes	Yes
• UDP	Yes	Yes	Yes
Web server			
• supported	Yes	Yes	Yes
Number of connections			
• overall	16; dynamically	16; dynamically	16; dynamically
Integrated Functions			
Number of counters	6	6	6
Counting frequency (counter) max.	100 kHz	100 kHz	100 kHz
Frequency meter	Yes	Yes	Yes
controlled positioning	Yes	Yes	Yes
Number of position-controlled positioning axes, max.	8	8	8
Number of positioning axes via pulse-direction interface	Up to 4 with SB 1222	4; With integrated outputs	Up to 4 with SB 1222
PID controller	Yes	Yes	Yes
Number of alarm inputs	4	4	4
Number of pulse outputs		4	
Limit frequency (pulse)		100 kHz	
Ambient conditions			
Ambient temperature during operation			
• min.	-20 °C	-20 °C	-20 °C
• max.	60 °C; Number of simultaneously activated inputs or outputs 7 or 5 (no adjacent points) at 60 °C horizontal or 50 °C vertical, 14 or 10 at 55 °C horizontal or 45 °C vertical	60 °C; Number of simultaneously activated inputs or outputs 7 or 5 (no adjacent points) at 60 °C horizontal or 50 °C vertical, 14 or 10 at 55 °C horizontal or 45 °C vertical	60 °C; Number of simultaneously activated inputs or outputs 7 or 5 (no adjacent points) at 60 °C horizontal or 50 °C vertical, 14 or 10 at 55 °C horizontal or 45 °C vertical
Pollutant concentrations			
- SO2 at RH < 60% without condensation	SO2: < 0.5 ppm; H2S: < 0.1 ppm; RH < 60% condensation-free	SO2: < 0.5 ppm; H2S: < 0.1 ppm; RH < 60% condensation-free	SO2: < 0.5 ppm; H2S: < 0.1 ppm; RH < 60% condensation-free

SIMATIC S7-1200 Basic Controllers

Central processing units
Standard CPUs

CPU 1215C

Technical specifications (continued)

Article number	6ES7215-1BG40-0XB0	6ES7215-1AG40-0XB0	6ES7215-1HG40-0XB0
	CPU 1215C, AC/DC/RLY, 14DI/10DO/2AI/2AO	CPU 1215C, DC/DC/DC, 14DI/10DO/2AI/2AO	CPU 1215C, DC/DC/RLY, 14DI/10DO/2AI/2AO
Configuration			
Programming			
Programming language			
- LAD	Yes	Yes	Yes
- FBD	Yes	Yes	Yes
- SCL	Yes	Yes	Yes
Dimensions			
Width	130 mm	130 mm	130 mm
Height	100 mm	100 mm	100 mm
Depth	75 mm	75 mm	75 mm
Weights			
Weight, approx.	550 g	500 g	585 g

Ordering data

Article No.	Article No.
CPU 1215C	
Compact CPU, AC/DC/relay; Integrated program/data memory 125 KB, load memory 4 MB; Wide-range power supply 85 ... 264 V AC; Boolean execution times 0.085 µs per operation; 14 digital inputs, 10 digital outputs (relays), 2 analog inputs, 2 analog outputs; Expandable by up to 3 communication modules, 8 signal modules and 1 signal board/communication board; Digital inputs can be used as HSC at 100 kHz	6ES7215-1BG40-0XB0
Compact CPU, DC/DC/DC; Integrated program/data memory 125 KB, load memory 4 MB; Power supply 24 V DC; Boolean execution times 0.085 µs per operation; 14 digital inputs, 10 digital outputs, 2 analog inputs, 2 analog outputs; Expandable by up to 3 communication modules, 8 signal modules, and 1 signal board/communication board; Digital inputs can be used as HSC at 100 kHz, 24 V DC digital outputs can be used as pulse outputs (PTO) or pulse-width modulated outputs (PWM) at 100 kHz	6ES7215-1AG40-0XB0
Compact CPU, DC/DC/relay; Integrated program/data memory 125 KB, load memory 4 MB; Power supply 24 V DC; Boolean execution times 0.085 µs per operation; 14 digital inputs, 10 digital outputs (relays), 2 analog inputs, 2 analog outputs; Expandable by up to 3 communication modules, 8 signal modules, and 1 signal board/communication board; Digital inputs can be used as HSC at 100 kHz	6ES7215-1HG40-0XB0
SB 1221 signal board 4 inputs, 5 V DC, 200 kHz 4 inputs, 24 V DC, 200 kHz	6ES7221-3AD30-0XB0 6ES7221-3BD30-0XB0
SB 1222 signal board 4 outputs, 5 V DC, 0.1 A, 200 kHz 4 outputs, 24 V DC, 0.1 A, 200 kHz	6ES7222-1AD30-0XB0 6ES7222-1BD30-0XB0
SB 1223 signal board 2 inputs, 24 V DC, IEC type 1 current sinking; 2 x 24 V DC transistor outputs, 0.5 A, 5 W; can be used as HSC at up to 30 kHz 2 inputs, 5 V DC, 200 kHz 2 outputs 5 V DC, 0.1 A, 200 kHz	6ES7223-0BD30-0XB0 6ES7223-3AD30-0XB0 6ES7223-3BD30-0XB0
SB 1231 signal board 1 analog input, ±10 V with 12 bits or 0 ... 20 mA with 11 bits	6ES7231-4HA30-0XB0
SB 1231 thermocouple signal board 1 input +/- 80 mV, resolution 15 bits + sign, thermocouples type J, K	6ES7231-5QA30-0XB0
RTD signal board SB 1231 1 input for resistance temperature sensors Pt 100, Pt 200, Pt 500, Pt 1000, resolution 15 bits + sign	6ES7231-5PA30-0XB0
SB 1232 signal board 1 analog output, ±10 V with 12 bits or 0 to 20 mA with 11 bits	6ES7232-4HA30-0XB0
CB 1241 RS 485 communication board For point-to-point connection, with 1 RS 485 interface	6ES7241-1CH30-1XB0
BB 1297 battery board For long-term backup of real-time clock; can be plugged into the sig- nal board slot; battery (CR 1025) is not included	6ES7297-0AX30-0XA0

Ordering data	Article No.	Ordering data	Article No.
Digital input simulator SIM 1274 simulator module (optional) 14 input switches, for CPU 1214C/1215C	6ES7274-1XH30-0XA0	Front flap set (spare part) For CPU 1215C	6ES7291-1AC30-0XA0
Analog input simulator SIM 1274 simulator module (optional) 2 potentiometers	6ES7274-1XA30-0XA0	RJ45 cable grip 4 items per pack Dual port	6ES7290-3AB30-0XA0
SIMATIC Memory Card (optional) 4 MB 12 MB 24 MB 256 MB 2 GB 32 GB	6ES7954-8LC02-0AA0 6ES7954-8LE02-0AA0 6ES7954-8LF02-0AA0 6ES7954-8LL02-0AA0 6ES7954-8LP02-0AA0 6ES7954-8LT03-0AA0	STEP 7 Professional / Basic V14 SP1 Target system: SIMATIC S7-1200, S7-1500, S7-300, S7-400, WinAC Requirement: Windows 7 Professional SP1 (64-bit), Windows 7 Enterprise SP1 (64-bit), Windows 7 Ultimate SP1 (64-bit), Windows 8.1 Professional (64-bit), Windows 8.1 Enterprise (64-bit), Windows 10 Professional Version 1607, Windows 10 Enterprise Version 1607, Windows 10 Enterprise 2016 LTSB, Windows 10 Enterprise 2015 LTSB, Windows Server 2008 R2 StdE (full installation), Windows Server 2012 StdE (full installation), Windows Server 2016 Standard (full installation); STEP 7 Basic V14 SP1 in addition: Windows 7 Home Premium SP1 (64-bit), Windows 8.1 (64-bit), Windows 10 Home Version 1607 Type of delivery: German, English, Chinese, Italian, French, Spanish STEP 7 Professional V14 SP1, floating license STEP 7 Professional V14 SP1, floating license, software download incl. license key ¹⁾ Email address required for delivery STEP 7 Basic V14 SP1, floating license STEP 7 Basic V14 SP1, floating license, software download incl. license key ¹⁾ Email address required for delivery	6ES7822-1AA04-0YA5 6ES7822-1AE04-0YA5 6ES7822-0AA04-0YA5 6ES7822-0AE04-0YA5
Extension cable for two-tier configuration For connecting digital/analog signal modules; length 2 m	6ES7290-6AA30-0XA0		
Terminal block (spare part) For CPU 1215C AC/DC/relay • For DI, with 20 screws, tin-coated, coded; 4 units • For DO, with 12 screws, tin-coated, coded; 4 units • For analog units, with 6 screws, gold-plated; 4 units For CPU 1215C DC/DC/DC • For DI, with 20 screws, tin-coated; 4 units • For DO, with 12 screws, tin-coated; 4 units • For analog units, with 6 screws, gold-plated; 4 units For CPU 1215C DC/DC/relay • For DI, with 20 screws, tin-coated; 4 units • For DO, with 12 screws, tin-coated, coded; 4 units • For analog units, with 6 screws, gold-plated; 4 units	6ES7292-1AV40-0XA0 6ES7292-1AM40-0XA0 6ES7292-1BF30-0XB0 6ES7292-1AV30-0XA0 6ES7292-1AM30-0XA0 6ES7292-1BF30-0XB0 6ES7292-1AV30-0XA0 6ES7292-1AM40-0XA0 6ES7292-1BF30-0XB0		

¹⁾ For up-to-date information and download availability, see:
<http://www.siemens.com/tia-online-software-delivery>

SIMATIC S7-1200 Basic Controllers

Central processing units
Standard CPUs

CPU 1217C

Overview



- Powerful controller for extremely fast signal processing
- Expandable by:
 - 1 signal board (SB), battery board (BB) or communication board (CB)
 - 8 signal modules (SM)
 - Max. 3 communication modules (CM)

3

Technical specifications

Article number	6ES7217-1AG40-0XB0 CPU 1217C, DC/DC/DC, 14DI/10DQ/2AI/2AQ
General information	
Product type designation	CPU 1217C DC/DC/DC
Engineering with	
• Programming package	STEP 7 V14 or higher
Supply voltage	
Rated value (DC)	
• 24 V DC	Yes
Encoder supply	
24 V encoder supply	
• 24 V	L+ minus 4 V DC min.
Power loss	
Power loss, typ.	12 W
Memory	
Work memory	
• integrated	150 kbyte
Load memory	
• integrated	4 Mbyte
• Plug-in (SIMATIC Memory Card), max.	with SIMATIC memory card
Backup	
• without battery	Yes
CPU processing times	
for bit operations, typ.	0.085 µs; / instruction
for word operations, typ.	1.7 µs; / instruction
for floating point arithmetic, typ.	2.3 µs; / Operation
Data areas and their retentivity	
Flag	
• Number, max.	8 kbyte; Size of bit memory address area
Process image	
• Inputs, adjustable	1 kbyte
• Outputs, adjustable	1 kbyte

Article number	6ES7217-1AG40-0XB0 CPU 1217C, DC/DC/DC, 14DI/10DQ/2AI/2AQ
Time of day	
Clock	
• Hardware clock (real-time)	Yes
Digital inputs	
Number of digital inputs	14; Integrated
• of which inputs usable for technological functions	6; HSC (High Speed Counting)
Digital outputs	
Number of digital outputs	10
• of which high-speed outputs	4; 100 kHz Pulse Train Output
Analog inputs	
Number of analog inputs	2
Input ranges	
• Voltage	Yes
Analog outputs	
Number of analog outputs	2
Output ranges, current	
• 0 to 20 mA	Yes
1. Interface	
Interface type	PROFINET
Physics	Ethernet
Functionality	
• PROFINET IO Controller	Yes
• PROFINET IO Device	Yes
• SIMATIC communication	Yes
• Open IE communication	Yes
• Web server	Yes
• Media redundancy	Yes; as MRP client

Technical specifications (continued)

Article number	6ES7217-1AG40-0XB0 CPU 1217C, DC/DC/DC, 14DI/10DQ/2AI/2AQ
Communication functions	
S7 communication	
• supported	Yes
Open IE communication	
• TCP/IP	Yes
• ISO-on-TCP (RFC1006)	Yes
• UDP	Yes
Web server	
• supported	Yes
Number of connections	
• overall	16; dynamically
Integrated Functions	
Number of counters	6
Counting frequency (counter) max.	1 MHz
Frequency meter	Yes
controlled positioning	Yes
Number of position-controlled positioning axes, max.	8
Number of positioning axes via pulse-direction interface	4; With integrated outputs
PID controller	Yes
Number of alarm inputs	4
Number of pulse outputs	4
Limit frequency (pulse)	1 MHz
Ambient conditions	
Ambient temperature during operation	
• min.	-20 °C
• max.	60 °C; Number of simultaneously activated inputs or outputs 7 or 5 (no adjacent points) at 60 °C horizontal or 50 °C vertical, 14 or 10 at 55 °C horizontal or 45 °C vertical
Pollutant concentrations	
- SO ₂ at RH < 60% without condensation	SO ₂ : < 0.5 ppm; H ₂ S: < 0.1 ppm; RH < 60% condensation-free
Configuration	
Programming	
Programming language	
- LAD	Yes
- FBD	Yes
- SCL	Yes
Dimensions	
Width	150 mm
Height	100 mm
Depth	75 mm
Weights	
Weight, approx.	530 g

Ordering data

Article No.

CPU 1217C

Compact CPU, DC/DC/DC;

Integrated program/data memory 150 KB, load memory 4 MB; Power supply 24 V DC; Boolean execution times 0.085 µs per operation; 14 digital inputs (10 digital 24 V DC inputs, 4 digital 1.5 V DC differential inputs), 10 digital outputs (6 digital 24 V DC outputs, 4 digital 1.5 V DC differential outputs), 2 analog inputs, 2 analog outputs; Expandable by up to 3 communication modules, 8 signal modules, and 1 signal board/communication board; Digital inputs can be used as HSC at 1 MHz, 24 V DC digital outputs can be used as pulse outputs (PTO) or pulse-width modulated outputs (PWM) at 100 kHz

6ES7217-1AG40-0XB0**SB 1221 signal board**

4 inputs, 5 V DC, 200 kHz

6ES7221-3AD30-0XB0

4 inputs, 24 V DC, 200 kHz

6ES7221-3BD30-0XB0**SB 1222 signal board**

4 outputs, 5 V DC, 0.1 A, 200 kHz

6ES7222-1AD30-0XB0

4 outputs, 24 V DC, 0.1 A, 200 kHz

6ES7222-1BD30-0XB0**SB 1223 signal board**

2 inputs, 24 V DC, IEC type 1 current sinking; 2 x 24 V DC transistor outputs, 0.5 A, 5 W; can be used as HSC at up to 30 kHz

6ES7223-0BD30-0XB0

2 inputs, 5 V DC, 200 kHz
2 outputs 5 V DC, 0.1 A, 200 kHz

6ES7223-3AD30-0XB0

2 inputs, 24 V DC, 200 kHz
2 outputs 24 V DC, 0.1 A, 200 kHz

6ES7223-3BD30-0XB0**SB 1231 signal board**

1 analog input, ±10 V with 12 bits or 0... 20 mA with 11 bits

6ES7231-4HA30-0XB0**SB 1231 thermocouple signal board**

1 input +/- 80 mV, resolution 15 bits + sign, thermocouples type J, K

6ES7231-5QA30-0XB0**RTD signal board SB 1231**

1 input for resistance temperature sensors Pt 100, Pt 200, Pt 500, Pt 1000, resolution 15 bits + sign

6ES7231-5PA30-0XB0**SB 1232 signal board**

1 analog output, ±10 V with 12 bits or 0 to 20 mA with 11 bits

6ES7232-4HA30-0XB0

SIMATIC S7-1200 Basic Controllers

Central processing units
Standard CPUs

CPU 1217C

Ordering data

Ordering data	Article No.
CB 1241 RS 485 communication board For point-to-point connection, with 1 RS 485 interface	6ES7241-1CH30-1XB0
BB 1297 battery board For long-term backup of real-time clock; can be plugged into the signal board slot; battery (CR 1025) is not included	6ES7297-0AX30-0XA0
Digital input simulator SIM 1274 simulator module (optional) 14 input switches, for CPU 1217C	6ES7274-1XK30-0XA0
Analog input simulator SIM 1274 simulator module (optional) 2 potentiometers	6ES7274-1XA30-0XA0
SIMATIC Memory Card (optional) 4 MB 12 MB 24 MB 256 MB 2 GB 32 GB	6ES7954-8LC02-0AA0 6ES7954-8LE02-0AA0 6ES7954-8LF02-0AA0 6ES7954-8LL02-0AA0 6ES7954-8LP02-0AA0 6ES7954-8LT03-0AA0
Extension cable for two-tier configuration For connecting digital/analog signal modules; length 2 m	6ES7290-6AA30-0XA0
Terminal block (spare part) For CPU 1217C • For DI, with 10 screws, tin-coated; 4 units • For DI, with 10 screws, tin-coated; 4 units • For DO, with 18 screws, tin-coated; 4 units • For analog units, with 6 screws, gold-plated; 4 units	6ES7292-1AK30-0XA0 6ES7292-1AR30-0XA0 6ES7292-1AT30-0XA0 6ES7292-1BF30-0XB0
Front flap set (spare part) For CPU 1217C	6ES7291-1AD30-0XA0

Article No.

RJ45 cable grip 4 items per pack Dual port	6ES7290-3AB30-0XA0
STEP 7 Professional / Basic V14 SP1 Target system: SIMATIC S7-1200, S7-1500, S7-300, S7-400, WinAC Requirement: Windows 7 Professional SP1 (64-bit), Windows 7 Enterprise SP1 (64-bit), Windows 7 Ultimate SP1 (64-bit), Windows 8.1 Professional (64-bit), Windows 8.1 Enterprise (64-bit), Windows 10 Professional Version 1607, Windows 10 Enterprise Version 1607, Windows 10 Enterprise 2016 LTSB, Windows 10 Enterprise 2015 LTSB, Windows Server 2008 R2 StdE (full installation), Windows Server 2012 StdE (full installation), Windows Server 2016 Standard (full installation); STEP 7 Basic V14 SP1 in addition: Windows 7 Home Premium SP1 (64-bit), Windows 8.1 (64-bit), Windows 10 Home Version 1607 Type of delivery: German, English, Chinese, Italian, French, Spanish	
STEP 7 Professional V14 SP1, floating license	6ES7822-1AA04-0YA5
STEP 7 Professional V14 SP1, floating license, software download incl. license key ¹⁾ Email address required for delivery	6ES7822-1AE04-0YA5
STEP 7 Basic V14 SP1, floating license	6ES7822-0AA04-0YA5
STEP 7 Basic V14 SP1, floating license, software download incl. license key ¹⁾ Email address required for delivery	6ES7822-0AE04-0YA5

¹⁾ For up-to-date information and download availability, see: <http://www.siemens.com/tia-online-software-delivery>

Overview

- The clever compact solution
- With 10 integrated I/Os
- Expandable with:
 - 1 signal board (SB) or communication board (CB); not possible with: 6AG1211-1AE31-2XB0, 6AG1211-1BE31-2XB0, 6AG1211-1HE31-2XB0
 - Max. 3 communication modules (CM)

Note:

SIPLUS extreme products are based on SIMATIC standard products. The contents listed here were taken from the respective standard products. SIPLUS extreme-specific information was added.

3

Technical specifications

Article number	6AG1211-1AE31-4XB0	6AG1211-1AE31-2XB0
Based on	6ES7211-1AE31-0XB0 SIPLUS S7-1200 CPU1211 DC/DC/DC	6ES7211-1AE31-0XB0 SIPLUS S7-1200 CPU1211 DC/DC/DC
Ambient conditions		
Ambient temperature during operation		
<ul style="list-style-type: none"> • min. • max. 	-20 °C; = Tmin; Startup @ 0 °C 60 °C; = Tmax	-40 °C; = Tmin; Startup @ -25 °C 70 °C; = Tmax; > +60 °C Number of simultaneously controllable inputs and outputs max. 50%; no signal board can be used
Extended ambient conditions		
<ul style="list-style-type: none"> • relative to ambient temperature-atmospheric pressure-installation altitude • At cold restart, min. 	Tmin ... Tmax at 1080 hPa ... 795 hPa (-1000 m ... +2000 m) // Tmin ... (Tmax - 10K) at 795 hPa ... 658 hPa (+2000 m ... +3500 m) // Tmin ... (Tmax - 20K) at 658 hPa ... 540 hPa (+3500 m ... +5000 m) 0 °C	Tmin ... Tmax at 1080 hPa ... 795 hPa (-1000 m ... +2000 m) // Tmin ... (Tmax - 10K) at 795 hPa ... 658 hPa (+2000 m ... +3500 m) // Tmin ... (Tmax - 20K) at 658 hPa ... 540 hPa (+3500 m ... +5000 m) -25 °C
Relative humidity		
- With condensation, tested in accordance with IEC 60068-2-38, max.	100%; RH incl. condensation/frost (no commissioning under condensation conditions)	100%; RH incl. condensation/frost (no commissioning under condensation conditions)
Resistance		
- against biologically active substances / conformity with EN 60721-3-3	Yes; Class 3B2 mold, fungus and dry rot spores (with the exception of fauna). The supplied connector covers must remain on the unused interfaces during operation!	Yes; Class 3B2 mold, fungus and dry rot spores (with the exception of fauna). The supplied connector covers must remain on the unused interfaces during operation!
- against chemically active substances / conformity with EN 60721-3-3	Yes; Class 3C4 (RH < 75%) incl. salt spray according to EN 60068-2-52 (degree of severity 3). The supplied connector covers must remain on the unused interfaces during operation!	Yes; Class 3C4 (RH < 75%) incl. salt spray according to EN 60068-2-52 (degree of severity 3). The supplied connector covers must remain on the unused interfaces during operation!
- against mechanically active substances / conformity with EN 60721-3-3	Yes; Class 3S4 incl. sand, dust. The supplied connector covers must remain on the unused interfaces during operation!	Yes; Class 3S4 incl. sand, dust. The supplied connector covers must remain on the unused interfaces during operation!

SIMATIC S7-1200 Basic Controllers

Central processing units
SIPLUS standard CPUs

SIPLUS CPU 1211C

Technical specifications (continued)

Article number	6AG1211-1BE31-4XB0	6AG1211-1BE31-2XB0
Based on	6ES7211-1BE31-0XB0 SIPLUS S7-1200 CPU1211 AC/DC/RLY	6ES7211-1BE31-0XB0 SIPLUS S7-1200 CPU1211 AC/DC/RLY
Ambient conditions		
Ambient temperature during operation		
• min.	-20 °C; = Tmin; Startup @ 0 °C	-40 °C; = Tmin; Startup @ -25 °C
• max.	60 °C; = Tmax	70 °C; = Tmax; > +60 °C Number of simultaneously controllable inputs and outputs max. 50%; no signal board can be used
Extended ambient conditions		
• relative to ambient temperature-atmospheric pressure-installation altitude	Tmin ... Tmax at 1080 hPa ... 795 hPa (-1000 m ... +2000 m) // Tmin ... (Tmax - 10K) at 795 hPa ... 658 hPa (+2000 m ... +3500 m) // Tmin ... (Tmax - 20K) at 658 hPa ... 540 hPa (+3500 m ... +5000 m)	Tmin ... Tmax at 1080 hPa ... 795 hPa (-1000 m ... +2000 m) // Tmin ... (Tmax - 10K) at 795 hPa ... 658 hPa (+2000 m ... +3500 m) // Tmin ... (Tmax - 20K) at 658 hPa ... 540 hPa (+3500 m ... +5000 m)
• At cold restart, min.	0 °C	-25 °C
Relative humidity		
- With condensation, tested in accordance with IEC 60068-2-38, max.	100%; RH incl. condensation/frost (no commissioning under condensation conditions)	100%; RH incl. condensation/frost (no commissioning under condensation conditions)
Resistance		
- against biologically active substances / conformity with EN 60721-3-3	Yes; Class 3B2 mold, fungus and dry rot spores (with the exception of fauna). The supplied connector covers must remain on the unused interfaces during operation!	Yes; Class 3B2 mold, fungus and dry rot spores (with the exception of fauna). The supplied connector covers must remain on the unused interfaces during operation!
- against chemically active substances / conformity with EN 60721-3-3	Yes; Class 3C4 (RH < 75%) incl. salt spray according to EN 60068-2-52 (degree of severity 3). The supplied connector covers must remain on the unused interfaces during operation!	Yes; Class 3C4 (RH < 75%) incl. salt spray according to EN 60068-2-52 (degree of severity 3). The supplied connector covers must remain on the unused interfaces during operation!
<hr/>		
Article number	6AG1211-1HE31-4XB0	6AG1211-1HE31-2XB0
Based on	6ES7211-1HE31-0XB0 SIPLUS S7-1200 CPU1211 DC/DC/RLY	6ES7211-1HE31-0XB0 SIPLUS S7-1200 CPU1211 DC/DC/RLY
Ambient conditions		
Ambient temperature during operation		
• min.	-20 °C; = Tmin; Startup @ 0 °C	-40 °C; = Tmin; Startup @ -25 °C
• max.	60 °C; = Tmax	70 °C; = Tmax; > +60 °C Number of simultaneously controllable inputs and outputs max. 50%; no signal board can be used
Extended ambient conditions		
• relative to ambient temperature-atmospheric pressure-installation altitude	Tmin ... Tmax at 1080 hPa ... 795 hPa (-1000 m ... +2000 m) // Tmin ... (Tmax - 10K) at 795 hPa ... 658 hPa (+2000 m ... +3500 m) // Tmin ... (Tmax - 20K) at 658 hPa ... 540 hPa (+3500 m ... +5000 m)	Tmin ... Tmax at 1080 hPa ... 795 hPa (-1000 m ... +2000 m) // Tmin ... (Tmax - 10K) at 795 hPa ... 658 hPa (+2000 m ... +3500 m) // Tmin ... (Tmax - 20K) at 658 hPa ... 540 hPa (+3500 m ... +5000 m)
• At cold restart, min.	0 °C	-25 °C
Relative humidity		
- With condensation, tested in accordance with IEC 60068-2-38, max.	100%; RH incl. condensation/frost (no commissioning under condensation conditions)	100%; RH incl. condensation/frost (no commissioning under condensation conditions)
Resistance		
- against biologically active substances / conformity with EN 60721-3-3	Yes; Class 3B2 mold, fungus and dry rot spores (with the exception of fauna). The supplied connector covers must remain on the unused interfaces during operation!	Yes; Class 3B2 mold, fungus and dry rot spores (with the exception of fauna). The supplied connector covers must remain on the unused interfaces during operation!
- against chemically active substances / conformity with EN 60721-3-3	Yes; Class 3C4 (RH < 75%) incl. salt spray according to EN 60068-2-52 (degree of severity 3). The supplied connector covers must remain on the unused interfaces during operation!	Yes; Class 3C4 (RH < 75%) incl. salt spray according to EN 60068-2-52 (degree of severity 3). The supplied connector covers must remain on the unused interfaces during operation!
- against mechanically active substances / conformity with EN 60721-3-3	Yes; Class 3S4 incl. sand, dust. The supplied connector covers must remain on the unused interfaces during operation!	Yes; Class 3S4 incl. sand, dust. The supplied connector covers must remain on the unused interfaces during operation!

Ordering data	Article No.	Article No.
<p>SIPLUS CPU 1211C compact CPU, AC/DC/relay</p> <p>(Extended temperature range and exposure to media)</p> <p>Integrated program and data memory of 25 KB, load memory of 1 MB; wide-range alternating voltage supply 85 ... 264 V AC; Boolean execution times of 0.1 ms per operation; 6 digital inputs, 4 digital outputs (relay), 2 analog inputs; expandable with up to 3 communication modules and 1 signal board/communication board; digital inputs usable as HSC with 100 kHz</p> <ul style="list-style-type: none"> • For areas with extreme medial exposure (conformal coating); ambient temperature -20 ... +60 °C • For areas with extreme medial exposure (conformal coating); ambient temperature -40 ... +70 °C 	<p>6AG1211-1BE31-4XB0</p> <p>6AG1211-1BE31-2XB0</p>	<p>SIPLUS CPU 1211C compact CPU, DC/DC/relay</p> <p>(Extended temperature range and exposure to media)</p> <p>Integrated program and data memory of 25 KB, load memory of 1 MB; power supply 24 V DC; Boolean execution times of 0.1 ms per operation; 6 digital inputs, 4 digital outputs (relay), 2 analog inputs; expandable with up to 3 communication modules and 1 signal board/communication board; digital inputs usable as HSC with 100 kHz</p> <ul style="list-style-type: none"> • For areas with extreme medial exposure (conformal coating); ambient temperature -20 ... +60 °C • For areas with extreme medial exposure (conformal coating); ambient temperature -40 ... +70 °C
<p>SIPLUS CPU 1211C compact CPU, DC/DC/DC</p> <p>(Extended temperature range and exposure to media)</p> <p>Integrated program and data memory of 25 KB, load memory of 1 MB; power supply 24 V DC; Boolean execution times of 0.1 ms per operation; 6 digital inputs, 4 digital outputs, 2 analog inputs; expandable with up to 3 communication modules and 1 signal board/communication board; digital inputs usable as HSC with 100 kHz, 24 V DC digital outputs usable as pulse outputs (PTO) or pulse-width-modulated outputs (PWM) with 100 kHz</p> <ul style="list-style-type: none"> • For areas with extreme medial exposure (conformal coating); ambient temperature -20 ... +60 °C • For areas with extreme medial exposure (conformal coating); ambient temperature -40 ... +70 °C 	<p>6AG1211-1AE31-4XB0</p> <p>6AG1211-1AE31-2XB0</p>	<p>Accessories</p> <p>SIPLUS SB 1221 digital input signal board</p> <p>(Extended temperature range and exposure to media; cannot be used with 6AG1211-1.....-2XB0)</p> <p>4 inputs, 5 V DC, 200 kHz, sourcing 6AG1221-3AD30-5XB0</p> <p>4 inputs, 24 V DC, 200 kHz, sourcing 6AG1221-3BD30-5XB0</p> <p>SIPLUS SB 1222 digital output signal board</p> <p>(Extended temperature range and exposure to media; cannot be used with 6AG1211-1.....-2XB0)</p> <p>4 outputs, 5 V DC, 0.1 A, 200 kHz 6AG1222-1AD30-5XB0</p> <p>4 outputs, 24 V DC, 0.1 A, 200 kHz 6AG1222-1BD30-5XB0</p>

SIMATIC S7-1200 Basic Controllers

Central processing units
SIPLUS standard CPUs

SIPLUS CPU 1211C**Ordering data****Article No.****Article No.****SIPLUS SB 1223 digital input/
output signal board**

(Extended temperature range and exposure to media; cannot be used with 6AG1211-1.....-2XB0)

2 inputs, 24 V DC,
IEC type 1 current sinking;
2 transistor outputs 24 V DC,
0.5 A, 5 W;
can be used as HSC at up to
30 kHz

- Suitable for areas with extreme medial exposure (conformal coating)
- Ambient temperature -25 ... +55 °C

2 inputs, 5 V DC, 200 kHz
2 outputs 5 V DC, 0.1 A, 200 kHz

2 inputs, 24 V DC, 200 kHz
2 outputs 24 V DC, 0.1 A, 200 kHz

6AG1223-0BD30-4XB0**6AG1223-0BD30-5XB0****6AG1223-3AD30-5XB0****6AG1223-3BD30-5XB0****SIPLUS SB 1232 analog output
signal board**

(Extended temperature range and exposure to media; cannot be used with 6AG1211-1.....-2XB0)

Ambient temperature range
-25 ... +55 °C

1 analog output, ±10 V with 12 bits
or 0 ... 20 mA with 11 bits

Ambient temperature range
0 ... +55 °C

1 analog output, ±10 V with 12 bits
or 0 ... 20 mA with 11 bits

**SIPLUS CB 1241 RS 485
communication board**

(Extended temperature range and exposure to media; cannot be used with 6AG1211-1.....-2XB0)

For point-to-point connection,
with 1 RS 485 interface

Additional accessories**6AG1232-4HA30-5XB0****6AG1232-4HA30-4XB0****6AG1241-1CH30-5XB1**See SIMATIC S7-1200
CPU 1211C, page 3/6

Overview

- The superior compact solution
- With 14 integral input/outputs
- Expandable by:
 - 1 signal board (SB) or communication board (CB); not possible with: 6AG1212-1AE31-2XB0, 6AG1212-1BE31-2XB0, 6AG1212-1HE31-2XB0
 - 2 signal modules (SM)
 - Max. 3 communication modules (CM)

Note:

SIPLUS extreme products are based on SIMATIC standard products. The contents listed here were taken from the respective standard products. SIPLUS extreme-specific information was added.

Technical specifications

Article number	6AG1212-1AE40-4XB0	6AG1212-1AE40-2XB0
Based on	6ES7212-1AE40-0XB0 SIPLUS S7-1200 CPU 1212C DC/DC/DC	6ES7212-1AE40-0XB0 SIPLUS S7-1200 CPU 1212C DC/DC/DC
Ambient conditions		
Ambient temperature during operation		
<ul style="list-style-type: none"> • min. • max. 	-20 °C; = Tmin; Startup @ 0 °C 60 °C; Number of simultaneously activated inputs or outputs 4 or 3 (no adjacent points) at 60 °C horizontal or 50 °C vertical, 8 or 6 at 55 °C horizontal or 45 °C vertical	-40 °C; = Tmin; Startup @ -25 °C 70 °C; = Tmax; Tmax > +55 °C number of simultaneously switched-on digital inputs 4, digital outputs 3, analog inputs 2 (no adjacent points) with horizontal mounting position; Tmax > +60 °C number of simultaneously switched-on digital inputs 3, digital outputs 2, analog inputs 0 (no adjacent points) with horizontal mounting position
Extended ambient conditions		
<ul style="list-style-type: none"> • relative to ambient temperature-atmospheric pressure-installation altitude 	Tmin ... Tmax at 1080 hPa ... 795 hPa (-1000 m ... +2000 m) // Tmin ... (Tmax - 10K) at 795 hPa ... 658 hPa (+2000 m ... +3500 m) // Tmin ... (Tmax - 20K) at 658 hPa ... 540 hPa (+3500 m ... +5000 m)	Tmin ... Tmax at 1080 hPa ... 795 hPa (-1000 m ... +2000 m) // Tmin ... (Tmax - 10K) at 795 hPa ... 658 hPa (+2000 m ... +3500 m) // Tmin ... (Tmax - 20K) at 658 hPa ... 540 hPa (+3500 m ... +5000 m)
Relative humidity		
<ul style="list-style-type: none"> - With condensation, tested in accordance with IEC 60068-2-38, max. 	100%; RH incl. condensation/frost (no commissioning under condensation conditions)	100%; RH incl. condensation/frost (no commissioning under condensation conditions)
Resistance		
<ul style="list-style-type: none"> - against biologically active substances / conformity with EN 60721-3-3 - against chemically active substances / conformity with EN 60721-3-3 - against mechanically active substances / conformity with EN 60721-3-3 	Yes; Class 3B2 mold, fungus and dry rot spores (with the exception of fauna). The supplied connector covers must remain on the unused interfaces during operation! Yes; Class 3C4 (RH < 75%) incl. salt spray according to EN 60068-2-52 (degree of severity 3). The supplied connector covers must remain on the unused interfaces during operation! Yes; Class 3S4 incl. sand, dust. The supplied connector covers must remain on the unused interfaces during operation!	Yes; Class 3B2 mold, fungus and dry rot spores (with the exception of fauna). The supplied connector covers must remain on the unused interfaces during operation! Yes; Class 3C4 (RH < 75%) incl. salt spray according to EN 60068-2-52 (degree of severity 3). The supplied connector covers must remain on the unused interfaces during operation! Yes; Class 3S4 incl. sand, dust. The supplied connector covers must remain on the unused interfaces during operation!

SIMATIC S7-1200 Basic Controllers

Central processing units
SIPLUS standard CPUs

SIPLUS CPU 1212C

Technical specifications (continued)

Article number	6AG1212-1BE40-4XB0	6AG1212-1BE40-2XB0
Based on	6ES7212-1BE40-0XB0 SIPLUS S7-1200 CPU 1212C AC/DC/RLY	6ES7212-1BE40-0XB0 SIPLUS S7-1200 CPU 1212C AC/DC/RLY
Ambient conditions		
Ambient temperature during operation		
• min.	-20 °C; = Tmin; Startup @ 0 °C	-40 °C; = Tmin; Startup @ -25 °C
• max.	60 °C; Number of simultaneously activated inputs or outputs 4 or 3 (no adjacent points) at 60 °C horizontal or 50 °C vertical, 8 or 6 at 55 °C horizontal or 45 °C vertical	70 °C; = Tmax; Tmax > +55 °C number of simultaneously switched-on digital inputs 4, digital outputs 3, analog inputs 2 (no adjacent points) with horizontal mounting position; Tmax > +60 °C number of simultaneously switched-on digital inputs 3, digital outputs 2, analog inputs 0 (no adjacent points) with horizontal mounting position
Extended ambient conditions		
• relative to ambient temperature-atmospheric pressure-installation altitude	Tmin ... Tmax at 1 080 hPa ... 795 hPa (-1 000 m ... +2 000 m) // Tmin ... (Tmax - 10 K) at 795 hPa ... 658 hPa (+2 000 m ... +3 500 m) // Tmin ... (Tmax - 20 K) at 658 hPa ... 540 hPa (+3 500 m ... +5 000 m); from 2 000 m max. 132 V AC	Tmin ... Tmax at 1 080 hPa ... 795 hPa (-1 000 m ... +2 000 m) // Tmin ... (Tmax - 10 K) at 795 hPa ... 658 hPa (+2 000 m ... +3 500 m) // Tmin ... (Tmax - 20 K) at 658 hPa ... 540 hPa (+3 500 m ... +5 000 m); from 2 000 m max. 132 V AC
Relative humidity		
- With condensation, tested in accordance with IEC 60068-2-38, max.	100%; RH incl. condensation/frost (no commissioning under condensation conditions)	100%; RH incl. condensation/frost (no commissioning under condensation conditions)
Resistance		
- against biologically active substances / conformity with EN 60721-3-3	Yes; Class 3B2 mold, fungus and dry rot spores (with the exception of fauna). The supplied connector covers must remain on the unused interfaces during operation!	Yes; Class 3B2 mold, fungus and dry rot spores (with the exception of fauna). The supplied connector covers must remain on the unused interfaces during operation!
- against chemically active substances / conformity with EN 60721-3-3	Yes; Class 3C4 (RH < 75%) incl. salt spray according to EN 60068-2-52 (degree of severity 3). The supplied connector covers must remain on the unused interfaces during operation!	Yes; Class 3C4 (RH < 75%) incl. salt spray according to EN 60068-2-52 (degree of severity 3). The supplied connector covers must remain on the unused interfaces during operation!
- against mechanically active substances / conformity with EN 60721-3-3	Yes; Class 3S4 incl. sand, dust. The supplied connector covers must remain on the unused interfaces during operation!	Yes; Class 3S4 incl. sand, dust. The supplied connector covers must remain on the unused interfaces during operation!
Article number	6AG1212-1HE40-4XB0	6AG1212-1HE40-2XB0
Based on	6ES7212-1HE40-0XB0 SIPLUS S7-1200 CPU 1212C DC/DC/RLY	6ES7212-1HE40-0XB0 SIPLUS S7-1200 CPU 1212C DC/DC/RLY
Ambient conditions		
Ambient temperature during operation		
• min.	-20 °C; = Tmin; Startup @ 0 °C	-40 °C; = Tmin; Startup @ -25 °C
• max.	60 °C; Number of simultaneously activated inputs or outputs 4 or 3 (no adjacent points) at 60 °C horizontal or 50 °C vertical, 8 or 6 at 55 °C horizontal or 45 °C vertical	70 °C; = Tmax; Tmax > +55 °C number of simultaneously switched-on digital inputs 4, digital outputs 3, analog inputs 2 (no adjacent points) with horizontal mounting position; Tmax > +60 °C number of simultaneously switched-on digital inputs 3, digital outputs 2, analog inputs 0 (no adjacent points) with horizontal mounting position
Extended ambient conditions		
• relative to ambient temperature-atmospheric pressure-installation altitude	Tmin ... Tmax at 1 080 hPa ... 795 hPa (-1 000 m ... +2 000 m) // Tmin ... (Tmax - 10 K) at 795 hPa ... 658 hPa (+2 000 m ... +3 500 m) // Tmin ... (Tmax - 20 K) at 658 hPa ... 540 hPa (+3 500 m ... +5 000 m); from 2 000 m max. 132 V AC	Tmin ... Tmax at 1 080 hPa ... 795 hPa (-1 000 m ... +2 000 m) // Tmin ... (Tmax - 10 K) at 795 hPa ... 658 hPa (+2 000 m ... +3 500 m) // Tmin ... (Tmax - 20 K) at 658 hPa ... 540 hPa (+3 500 m ... +5 000 m); from 2 000 m max. 132 V AC
Relative humidity		
- With condensation, tested in accordance with IEC 60068-2-38, max.	100%; RH incl. condensation/frost (no commissioning under condensation conditions)	100%; RH incl. condensation/frost (no commissioning under condensation conditions)
Resistance		
- against biologically active substances / conformity with EN 60721-3-3	Yes; Class 3B2 mold, fungus and dry rot spores (with the exception of fauna). The supplied connector covers must remain on the unused interfaces during operation!	Yes; Class 3B2 mold, fungus and dry rot spores (with the exception of fauna). The supplied connector covers must remain on the unused interfaces during operation!
- against chemically active substances / conformity with EN 60721-3-3	Yes; Class 3C4 (RH < 75%) incl. salt spray according to EN 60068-2-52 (degree of severity 3). The supplied connector covers must remain on the unused interfaces during operation!	Yes; Class 3C4 (RH < 75%) incl. salt spray according to EN 60068-2-52 (degree of severity 3). The supplied connector covers must remain on the unused interfaces during operation!
- against mechanically active substances / conformity with EN 60721-3-3	Yes; Class 3S4 incl. sand, dust. The supplied connector covers must remain on the unused interfaces during operation!	Yes; Class 3S4 incl. sand, dust. The supplied connector covers must remain on the unused interfaces during operation!

Ordering data	Article No.	Ordering data	Article No.
<p>SIPLUS CPU 1212C compact CPU, AC/DC/relay</p> <p>(Extended temperature range and exposure to media)</p> <p>Integrated program/data memory 75 KB, load memory 1 MB; Wide-range power supply 85 ... 264 V AC; Boolean execution times 0.1 µs per operation; 8 digital inputs, 6 digital outputs (relays), 2 analog inputs; Expandable by up to 3 communication modules, 2 signal modules and 1 signal board/communication board; Digital inputs can be used as HSC at 100 kHz</p> <ul style="list-style-type: none"> For areas with extreme medial exposure (conformal coating); ambient temperature -20 ... +60 °C For areas with extreme medial exposure (conformal coating); ambient temperature -40 ... +70 °C 	<p>6AG1212-1BE40-4XB0</p> <p>6AG1212-1BE40-2XB0</p>	<p>SIPLUS CPU 1212C compact CPU, DC/DC/relay</p> <p>(Extended temperature range and exposure to media)</p> <p>Integrated program/data memory 75 KB, load memory 1 MB; Power supply 24 V DC; Boolean execution times 0.1 µs per operation; 8 digital inputs, 6 digital outputs (relays), 2 analog inputs; Expandable by up to 3 communication modules, 2 signal modules, and 1 signal board/communication board; Digital inputs can be used as HSC at 100 kHz</p> <ul style="list-style-type: none"> For areas with extreme medial exposure (conformal coating); ambient temperature -20 ... +60 °C For areas with extreme medial exposure (conformal coating); ambient temperature -40 ... +70 °C 	<p>6AG1212-1HE40-4XB0</p> <p>6AG1212-1HE40-2XB0</p>
<p>SIPLUS CPU 1212C compact CPU, DC/DC/DC</p> <p>(Extended temperature range and exposure to media)</p> <p>Integrated program/data memory 75 KB, load memory 1 MB; Power supply 24 V DC; Boolean execution times 0.1 µs per operation; 8 digital inputs, 6 digital outputs, 2 analog inputs; Expandable by up to 3 communication modules, 2 signal modules, and 1 signal board/communication board; Digital inputs can be used as HSC at 100 kHz, 24 V DC digital outputs can be used as pulse outputs (PTO) or pulse-width modulated outputs (PWM) at 100 kHz</p> <ul style="list-style-type: none"> For areas with extreme medial exposure (conformal coating); ambient temperature -20 ... +60 °C For areas with extreme medial exposure (conformal coating); ambient temperature -40 ... +70 °C 	<p>6AG1212-1AE40-4XB0</p> <p>6AG1212-1AE40-2XB0</p>	<p>Accessories</p> <p>SIPLUS SB 1221 digital input signal board</p> <p>(Extended temperature range and exposure to media; cannot be used with 6AG1212-1.....-2XB0)</p> <p>4 inputs, 5 V DC, 200 kHz, sourcing</p> <p>4 inputs, 24 V DC, 200 kHz, sourcing</p> <p>SIPLUS SB 1222 digital output signal board</p> <p>(Extended temperature range and exposure to media; cannot be used with 6AG1212-1.....-2XB0)</p> <p>4 outputs, 5 V DC, 0.1 A, 200 kHz</p> <p>4 outputs, 24 V DC, 0.1 A, 200 kHz</p>	<p>6AG1221-3AD30-5XB0</p> <p>6AG1221-3BD30-5XB0</p> <p>6AG1222-1AD30-5XB0</p> <p>6AG1222-1BD30-5XB0</p>

SIMATIC S7-1200 Basic Controllers

Central processing units
SIPLUS standard CPUs

SIPLUS CPU 1212C

Ordering data

Article No.

Article No.

Digital input/output

SIPLUS signal board SB 1223

(Extended temperature range and exposure to media; cannot be used with 6AG1212-1.....-2XB0)

2 inputs, 24 V DC, IEC type 1 current sinking; 2 transistor outputs 24 V DC, 0.5 A, 5 W; can be used as HSC at up to 30 kHz

- Suitable for areas with extreme medial exposure (conformal coating)
- Ambient temperature -25 ... +55 °C

2 inputs, 5 V DC, 200 kHz
2 outputs 5 V DC, 0.1 A, 200 kHz

2 inputs, 24 V DC, 200 kHz
2 outputs 24 V DC, 0.1 A, 200 kHz

6AG1223-0BD30-4XB0

6AG1223-0BD30-5XB0

6AG1223-3AD30-5XB0

6AG1223-3BD30-5XB0

SIPLUS SB 1232 analog output signal board

(Extended temperature range and exposure to media; cannot be used with 6AG1212-1.....-2XB0)

Ambient temperature range
-25 ... +55 °C

1 analog output, ±10 V with 12 bits or 0 ... 20 mA with 11 bits

Ambient temperature range
0 ... +55 °C

1 analog output, ±10 V with 12 bits or 0 ... 20 mA with 11 bits

6AG1232-4HA30-5XB0

6AG1232-4HA30-4XB0

SIPLUS CB 1241 RS 485 communication board

(Extended temperature range and exposure to media; cannot be used with 6AG1212-1.....-2XB0)

For point-to-point connection, with 1 RS 485 interface

6AG1241-1CH30-5XB1

Additional accessories

See SIMATIC S7-1200 CPU 1212C, page 3/10

Overview

- The compact high-performance CPU
- With 24 integrated I/Os
- Expandable with:
 - 1 signal board (SB) or communication board (CB); not possible with: 6AG1214-1AG40-2XB0, 6AG1214-1BG40-2XB0, 6AG1214-1HG40-2XB0
 - 8 signal modules (SM)
 - Max. 3 communication modules (CM)

Note:

SIPLUS extreme products are based on SIMATIC standard products. The contents listed here were taken from the respective standard products. SIPLUS extreme-specific information was added.

3

Technical specifications

Article number	6AG1214-1AG40-4XB0	6AG1214-1AG40-5XB0	6AG1214-1AG40-2XB0
Based on	6ES7214-1AG40-0XB0 SIPLUS S7-1200 CPU 1214C DC/DC/DC	6ES7214-1AG40-0XB0 SIPLUS S7-1200 CPU 1214C DC/DC/DC	6ES7214-1AG40-0XB0 SIPLUS S7-1200 CPU 1214C DC/DC/DC
Ambient conditions			
Ambient temperature during operation			
• min.	-20 °C; = Tmin; Startup @ 0 °C	-40 °C; = Tmin; Startup @ -25 °C	-40 °C; = Tmin; Startup @ -25 °C
• max.	60 °C; Number of simultaneously activated inputs or outputs 7 or 5 (no adjacent points) at 60 °C horizontal or 50 °C vertical, 14 or 10 at 55 °C horizontal or 45 °C vertical	60 °C; = Tmax; Tmax > +55 °C number of simultaneously switched-on digital inputs 7, digital outputs 5, analog inputs 2 (no adjacent points) with horizontal mounting position	70 °C; = Tmax; Tmax > +55 °C number of simultaneously switched-on digital inputs 7, digital outputs 5, analog inputs 2 (no adjacent points) with horizontal mounting position; Tmax > +60 °C number of simultaneously switched-on digital inputs 7, digital outputs 5, analog inputs 1 (no adjacent points) with horizontal mounting position
Extended ambient conditions			
• relative to ambient temperature-atmospheric pressure-installation altitude	Tmin ... Tmax at 1080 hPa ... 795 hPa (-1000 m ... +2000 m) // Tmin ... (Tmax - 10K) at 795 hPa ... 658 hPa (+2000 m ... +3500 m) // Tmin ... (Tmax - 20K) at 658 hPa ... 540 hPa (+3500 m ... +5000 m)	Tmin ... Tmax at 1080 hPa ... 795 hPa (-1000 m ... +2000 m) // Tmin ... (Tmax - 10K) at 795 hPa ... 658 hPa (+2000 m ... +3500 m) // Tmin ... (Tmax - 20K) at 658 hPa ... 540 hPa (+3500 m ... +5000 m)	Tmin ... Tmax at 1080 hPa ... 795 hPa (-1000 m ... +2000 m) // Tmin ... (Tmax - 10K) at 795 hPa ... 658 hPa (+2000 m ... +3500 m) // Tmin ... (Tmax - 20K) at 658 hPa ... 540 hPa (+3500 m ... +5000 m)
Relative humidity			
- With condensation, tested in accordance with IEC 60068-2-38, max.	100%; RH incl. condensation/frost (no commissioning under condensation conditions)	100%; RH incl. condensation/frost (no commissioning under condensation conditions)	100%; RH incl. condensation/frost (no commissioning under condensation conditions)
Resistance			
- against biologically active substances / conformity with EN 60721-3-3	Yes; Class 3B2 mold, fungus and dry rot spores (with the exception of fauna). The supplied connector covers must remain on the unused interfaces during operation!	Yes; Class 3B2 mold, fungus and dry rot spores (with the exception of fauna). The supplied connector covers must remain on the unused interfaces during operation!	Yes; Class 3B2 mold, fungus and dry rot spores (with the exception of fauna). The supplied connector covers must remain on the unused interfaces during operation!
- against chemically active substances / conformity with EN 60721-3-3	Yes; Class 3C4 (RH < 75%) incl. salt spray according to EN 60068-2-52 (degree of severity 3). The supplied connector covers must remain on the unused interfaces during operation!	Yes; Class 3C4 (RH < 75%) incl. salt spray according to EN 60068-2-52 (degree of severity 3). The supplied connector covers must remain on the unused interfaces during operation!	Yes; Class 3C4 (RH < 75%) incl. salt spray according to EN 60068-2-52 (degree of severity 3). The supplied connector covers must remain on the unused interfaces during operation!
- against mechanically active substances / conformity with EN 60721-3-3	Yes; Class 3S4 incl. sand, dust. The supplied connector covers must remain on the unused interfaces during operation!	Yes; Class 3S4 incl. sand, dust. The supplied connector covers must remain on the unused interfaces during operation!	Yes; Class 3S4 incl. sand, dust. The supplied connector covers must remain on the unused interfaces during operation!

SIMATIC S7-1200 Basic Controllers

Central processing units
SIPLUS standard CPUs

SIPLUS CPU 1214C

Technical specifications (continued)

Article number	6AG1214-1BG40-4XB0	6AG1214-1BG40-5XB0	6AG1214-1BG40-2XB0
Based on	6ES7214-1BG40-0XB0 SIPLUS S7-1200 CPU 1214C AC/DC/RLY	6ES7214-1BG40-0XB0 SIPLUS S7-1200 CPU 1214C AC/DC/RLY	6ES7214-1BG40-0XB0 SIPLUS S7-1200 CPU 1214C AC/DC/RLY
Ambient conditions			
Ambient temperature during operation			
<ul style="list-style-type: none"> min. max. 	-20 °C; = Tmin; Startup @ 0 °C 60 °C; = Tmax	-40 °C; = Tmin; Startup @ -25 °C 60 °C; = Tmax; Tmax > +55 °C number of simultaneously switched-on digital inputs 7, digital outputs 5, analog inputs 2 (no adjacent points) with horizontal mounting position	-40 °C; = Tmin; Startup @ -25 °C 70 °C; = Tmax; Tmax > +55 °C number of simultaneously switched-on digital inputs 7, digital outputs 5, analog inputs 2 (no adjacent points) with horizontal mounting position; Tmax > +60 °C number of simultaneously switched-on digital inputs 7, digital outputs 5, analog inputs 1 (no adjacent points) with horizontal mounting position
Extended ambient conditions			
<ul style="list-style-type: none"> relative to ambient temperature-atmospheric pressure-installation altitude 	Tmin ... Tmax at 1 080 hPa ... 795 hPa (-1 000 m ... +2 000 m) // Tmin ... (Tmax - 10 K) at 795 hPa ... 658 hPa (+2 000 m ... +3 500 m) // Tmin ... (Tmax - 20 K) at 658 hPa ... 540 hPa (+3 500 m ... +5 000 m); from 2 000 m max. 132 V AC	Tmin ... Tmax at 1 080 hPa ... 795 hPa (-1 000 m ... +2 000 m) // Tmin ... (Tmax - 10 K) at 795 hPa ... 658 hPa (+2 000 m ... +3 500 m) // Tmin ... (Tmax - 20 K) at 658 hPa ... 540 hPa (+3 500 m ... +5 000 m); from 2 000 m max. 132 V AC	Tmin ... Tmax at 1 080 hPa ... 795 hPa (-1 000 m ... +2 000 m) // Tmin ... (Tmax - 10 K) at 795 hPa ... 658 hPa (+2 000 m ... +3 500 m) // Tmin ... (Tmax - 20 K) at 658 hPa ... 540 hPa (+3 500 m ... +5 000 m); from 2 000 m max. 132 V AC
Relative humidity			
<ul style="list-style-type: none"> With condensation, tested in accordance with IEC 60068-2-38, max. 	100%; RH incl. condensation/frost (no commissioning under condensation conditions)	100%; RH incl. condensation/frost (no commissioning under condensation conditions)	100%; RH incl. condensation/frost (no commissioning under condensation conditions)
Resistance			
<ul style="list-style-type: none"> against biologically active substances / conformity with EN 60721-3-3 against chemically active substances / conformity with EN 60721-3-3 against mechanically active substances / conformity with EN 60721-3-3 	Yes; Class 3B2 mold, fungus and dry rot spores (with the exception of fauna). The supplied connector covers must remain on the unused interfaces during operation! Yes; Class 3C4 (RH < 75%) incl. salt spray according to EN 60068-2-52 (degree of severity 3). The supplied connector covers must remain on the unused interfaces during operation! Yes; Class 3S4 incl. sand, dust. The supplied connector covers must remain on the unused interfaces during operation!	Yes; Class 3B2 mold, fungus and dry rot spores (with the exception of fauna). The supplied connector covers must remain on the unused interfaces during operation! Yes; Class 3C4 (RH < 75%) incl. salt spray according to EN 60068-2-52 (degree of severity 3). The supplied connector covers must remain on the unused interfaces during operation! Yes; Class 3S4 incl. sand, dust. The supplied connector covers must remain on the unused interfaces during operation!	Yes; Class 3B2 mold, fungus and dry rot spores (with the exception of fauna). The supplied connector covers must remain on the unused interfaces during operation! Yes; Class 3C4 (RH < 75%) incl. salt spray according to EN 60068-2-52 (degree of severity 3). The supplied connector covers must remain on the unused interfaces during operation! Yes; Class 3S4 incl. sand, dust. The supplied connector covers must remain on the unused interfaces during operation!

Technical specifications (continued)

Article number	6AG1214-1HG40-4XB0	6AG1214-1HG40-5XB0	6AG1214-1HG40-2XB0
Based on	6ES7214-1HG40-0XB0 SIPLUS S7-1200 CPU 1214C DC/DC/RLY	6ES7214-1HG40-0XB0 SIPLUS S7-1200 CPU 1214C DC/DC/RLY	6ES7214-1HG40-0XB0 SIPLUS S7-1200 CPU 1214C DC/DC/RLY
Ambient conditions			
Ambient temperature during operation			
<ul style="list-style-type: none"> • min. • max. 	-20 °C; = Tmin; Startup @ 0 °C 60 °C; Number of simultaneously activated inputs or outputs 7 or 5 (no adjacent points) at 60 °C horizontal or 50 °C vertical, 14 or 10 at 55 °C horizontal or 45 °C vertical	-40 °C; = Tmin; Startup @ -25 °C 60 °C; = Tmax; Tmax > +55 °C number of simultaneously switched-on digital inputs 7, digital outputs 5, analog inputs 2 (no adjacent points) with horizontal mounting position	-40 °C; = Tmin; Startup @ -25 °C 70 °C; = Tmax; Tmax > +55 °C number of simultaneously switched-on digital inputs 7, digital outputs 5, analog inputs 2 (no adjacent points) with horizontal mounting position; Tmax > +60 °C number of simultaneously switched-on digital inputs 7, digital outputs 5, analog inputs 1 (no adjacent points) with horizontal mounting position
Extended ambient conditions			
<ul style="list-style-type: none"> • relative to ambient temperature-atmospheric pressure-installation altitude 	Tmin ... Tmax at 1 080 hPa ... 795 hPa (-1 000 m ... +2 000 m) // Tmin ... (Tmax - 10 K) at 795 hPa ... 658 hPa (+2 000 m ... +3 500 m) // Tmin ... (Tmax - 20 K) at 658 hPa ... 540 hPa (+3 500 m ... +5 000 m); from 2 000 m max. 132 V AC	Tmin ... Tmax at 1 080 hPa ... 795 hPa (-1 000 m ... +2 000 m) // Tmin ... (Tmax - 10 K) at 795 hPa ... 658 hPa (+2 000 m ... +3 500 m) // Tmin ... (Tmax - 20 K) at 658 hPa ... 540 hPa (+3 500 m ... +5 000 m); from 2 000 m max. 132 V AC	Tmin ... Tmax at 1 080 hPa ... 795 hPa (-1 000 m ... +2 000 m) // Tmin ... (Tmax - 10 K) at 795 hPa ... 658 hPa (+2 000 m ... +3 500 m) // Tmin ... (Tmax - 20 K) at 658 hPa ... 540 hPa (+3 500 m ... +5 000 m); from 2 000 m max. 132 V AC
Relative humidity			
- With condensation, tested in accordance with IEC 60068-2-38, max.	100%; RH incl. condensation/frost (no commissioning under condensation conditions)	100%; RH incl. condensation/frost (no commissioning under condensation conditions)	100%; RH incl. condensation/frost (no commissioning under condensation conditions)
Resistance			
- against biologically active substances / conformity with EN 60721-3-3	Yes; Class 3B2 mold, fungus and dry rot spores (with the exception of fauna). The supplied connector covers must remain on the unused interfaces during operation!	Yes; Class 3B2 mold, fungus and dry rot spores (with the exception of fauna). The supplied connector covers must remain on the unused interfaces during operation!	Yes; Class 3B2 mold, fungus and dry rot spores (with the exception of fauna). The supplied connector covers must remain on the unused interfaces during operation!
- against chemically active substances / conformity with EN 60721-3-3	Yes; Class 3C4 (RH < 75%) incl. salt spray according to EN 60068-2-52 (degree of severity 3). The supplied connector covers must remain on the unused interfaces during operation!	Yes; Class 3C4 (RH < 75%) incl. salt spray according to EN 60068-2-52 (degree of severity 3). The supplied connector covers must remain on the unused interfaces during operation!	Yes; Class 3C4 (RH < 75%) incl. salt spray according to EN 60068-2-52 (degree of severity 3). The supplied connector covers must remain on the unused interfaces during operation!
- against mechanically active substances / conformity with EN 60721-3-3	Yes; Class 3S4 incl. sand, dust. The supplied connector covers must remain on the unused interfaces during operation!	Yes; Class 3S4 incl. sand, dust. The supplied connector covers must remain on the unused interfaces during operation!	Yes; Class 3S4 incl. sand, dust. The supplied connector covers must remain on the unused interfaces during operation!

SIMATIC S7-1200 Basic Controllers

Central processing units
SIPLUS standard CPUs

SIPLUS CPU 1214C

Ordering data

Article No.

Article No.

SIPLUS CPU 1214C compact CPU, AC/DC/relay

(Extended temperature range and exposure to media)

Integrated program/data memory 100 KB, load memory 2 MB;
Wide-range power supply 85 ... 264 V AC;
Boolean execution times 0.1 µs per operation;
14 digital inputs, 10 digital outputs (relays), 2 analog inputs;
Expandable by up to 3 communication modules, 8 signal modules and 1 signal board/communication board;
Digital inputs can be used as HSC at 100 kHz

- For areas with extreme medial exposure (conformal coating); ambient temperature -20 ... +60 °C
- For areas with extreme medial exposure (conformal coating); ambient temperature -40 ... +60 °C
- For areas with extreme medial exposure (conformal coating); ambient temperature -40 ... +70 °C

6AG1214-1BG40-4XB0

6AG1214-1BG40-5XB0

6AG1214-1BG40-2XB0

SIPLUS CPU 1214C compact CPU, DC/DC/DC

(Extended temperature range and exposure to media)

Integrated program/data memory 100 KB, load memory 2 MB;
Power supply 24 V DC;
Boolean execution times 0.1 µs per operation;
14 digital inputs, 10 digital outputs, 2 analog inputs;
expandable by up to 3 communication modules, 8 signal modules, and 1 signal board/communication board;
Digital inputs can be used as HSC at 100 kHz,
24 V DC digital outputs can be used as pulse outputs (PTO) or pulse-width modulated outputs (PWM) at 100 kHz

- For areas with extreme medial exposure (conformal coating); ambient temperature -20 ... +60 °C
- For areas with extreme medial exposure (conformal coating); ambient temperature -40 ... +60 °C
- For areas with extreme medial exposure (conformal coating); ambient temperature -40 ... +70 °C

6AG1214-1AG40-4XB0

6AG1214-1AG40-5XB0

6AG1214-1AG40-2XB0

SIPLUS CPU 1214C compact CPU, DC/DC/relay

(Extended temperature range and exposure to media)

Integrated program/data memory 100 KB, load memory 2 MB;
Power supply 24 V DC;
Boolean execution times 0.1 µs per operation;
14 digital inputs, 10 digital outputs (relays), 2 analog inputs;
Expandable by up to 3 communication modules, 8 signal modules, and 1 signal board/communication board;
Digital inputs can be used as HSC at 100 kHz

- For areas with extreme medial exposure (conformal coating); ambient temperature -20 ... +60 °C
- For areas with extreme medial exposure (conformal coating); ambient temperature -40 ... +60 °C
- For areas with extreme medial exposure (conformal coating); ambient temperature -40 ... +70 °C

6AG1214-1HG40-4XB0

6AG1214-1HG40-5XB0

6AG1214-1HG40-2XB0

Accessories

SIPLUS SB 1221 digital input signal board

(Extended temperature range and exposure to media; cannot be used with 6AG1214-1.....-2XB0)

4 inputs, 5 V DC, 200 kHz, sourcing
4 inputs, 24 V DC, 200 kHz, sourcing

6AG1221-3AD30-5XB0

6AG1221-3BD30-5XB0

SIPLUS SB 1222 digital output signal board

(Extended temperature range and exposure to media; cannot be used with 6AG1214-1.....-2XB0)

4 outputs, 5 V DC, 0.1 A, 200 kHz
4 outputs, 24 V DC, 0.1 A, 200 kHz

6AG1222-1AD30-5XB0

6AG1222-1BD30-5XB0

Ordering data	Article No.	Article No.	
<p>SIPLUS SB 1223 digital input/output signal board (Extended temperature range and exposure to media; cannot be used with 6AG1214-1.....-2XB0)</p> <p>2 inputs, 24 V DC, IEC type 1 current sinking; 2 transistor outputs 24 V DC, 0.5 A, 5 W; can be used as HSC at up to 30 kHz</p> <ul style="list-style-type: none"> • Suitable for areas with extreme medial exposure (conformal coating) • Ambient temperature -25 ... +55 °C <p>2 inputs, 5 V DC, 200 kHz 2 outputs 5 V DC, 0.1 A, 200 kHz</p> <p>2 inputs, 24 V DC, 200 kHz 2 outputs 24 V DC, 0.1 A, 200 kHz</p>	<p>6AG1223-0BD30-4XB0</p> <p>6AG1223-0BD30-5XB0</p> <p>6AG1223-3AD30-5XB0</p> <p>6AG1223-3BD30-5XB0</p>	<p>SIPLUS SB 1232 analog output signal board (Extended temperature range and exposure to media; cannot be used with 6AG1214-1.....-2XB0)</p> <p><u>Ambient temperature range</u> -25 ... +55 °C</p> <p>1 analog output, ±10 V with 12 bits or 0 ... 20 mA with 11 bits</p> <p><u>Ambient temperature range</u> 0 ... +55 °C</p> <p>1 analog output, ±10 V with 12 bits or 0 ... 20 mA with 11 bits</p> <p>SIPLUS CB 1241 RS 485 communication board (Extended temperature range and exposure to media; cannot be used with 6AG1214-1.....-2XB0)</p> <p>For point-to-point connection, with 1 RS 485 interface</p> <p>Additional accessories</p>	<p>6AG1232-4HA30-5XB0</p> <p>6AG1232-4HA30-4XB0</p> <p>6AG1241-1CH30-5XB1</p> <p>See SIMATIC S7-1200 CPU 1214C, page 3/14</p>

SIMATIC S7-1200 Basic Controllers

Central processing units
SIPLUS standard CPUs

SIPLUS CPU 1215C

Overview



- The compact high-performance CPU
- With 24 integrated I/Os
- Expandable with:
 - 1 signal board (SB) or communication board (CB); not possible with: 6AG1215-1AG40-2XB0, 6AG1215-1BG40-2XB0, 6AG1215-1HG40-2XB0
 - 8 signal modules (SM)
 - Max. 3 communication modules (CM)

Note:

SIPLUS extreme products are based on SIMATIC standard products. The contents listed here were taken from the respective standard products. SIPLUS extreme-specific information was added.

Technical specifications

Article number	6AG1215-1AG40-4XB0	6AG1215-1AG40-5XB0	6AG1215-1AG40-2XB0
Based on	6ES7215-1AG40-0XB0 SIPLUS S7-1200 CPU 1215C DC/DC/DC	6ES7215-1AG40-0XB0 SIPLUS S7-1200 CPU 1215C DC/DC/DC	6ES7215-1AG40-0XB0 SIPLUS S7-1200 CPU 1215C DC/DC/DC
Ambient conditions			
Ambient temperature during operation			
• min.	-20 °C; = Tmin; Startup @ 0 °C	-40 °C; = Tmin; Startup @ -25 °C	-40 °C; = Tmin; Startup @ -25 °C
• max.	60 °C; Number of simultaneously activated inputs or outputs 7 or 5 (no adjacent points) at 60 °C horizontal or 50 °C vertical, 14 or 10 at 55 °C horizontal or 45 °C vertical	60 °C; = Tmax; Tmax > +55 °C number of simultaneously switched-on digital inputs 7, digital outputs 5, analog inputs 2, analog outputs 2 (no adjacent points) with horizontal mounting position	70 °C; = Tmax; Tmax > +55 °C number of simultaneously switched-on digital inputs 7, digital outputs 5, analog inputs 2, analog outputs 2 (no adjacent points) with horizontal mounting position; Tmax > +60 °C number of simultaneously switched-on digital inputs 7, digital outputs 5, analog inputs 1, analog outputs 1 (no adjacent points) with horizontal mounting position
Extended ambient conditions			
• relative to ambient temperature-atmospheric pressure-installation altitude	Tmin ... Tmax at 1080 hPa ... 795 hPa (-1000 m ... +2000 m) // Tmin ... (Tmax - 10K) at 795 hPa ... 658 hPa (+2000 m ... +3500 m) // Tmin ... (Tmax - 20K) at 658 hPa ... 540 hPa (+3500 m ... +5000 m)	Tmin ... Tmax at 1080 hPa ... 795 hPa (-1000 m ... +2000 m) // Tmin ... (Tmax - 10K) at 795 hPa ... 658 hPa (+2000 m ... +3500 m) // Tmin ... (Tmax - 20K) at 658 hPa ... 540 hPa (+3500 m ... +5000 m)	Tmin ... Tmax at 1080 hPa ... 795 hPa (-1000 m ... +2000 m) // Tmin ... (Tmax - 10K) at 795 hPa ... 658 hPa (+2000 m ... +3500 m) // Tmin ... (Tmax - 20K) at 658 hPa ... 540 hPa (+3500 m ... +5000 m)
Relative humidity			
- With condensation, tested in accordance with IEC 60068-2-38, max.	100%; RH incl. condensation/frost (no commissioning under condensation conditions)	100%; RH incl. condensation/frost (no commissioning under condensation conditions)	100%; RH incl. condensation/frost (no commissioning under condensation conditions)
Resistance			
- against biologically active substances / conformity with EN 60721-3-3	Yes; Class 3B2 mold, fungus and dry rot spores (with the exception of fauna). The supplied connector covers must remain on the unused interfaces during operation!	Yes; Class 3B2 mold, fungus and dry rot spores (with the exception of fauna). The supplied connector covers must remain on the unused interfaces during operation!	Yes; Class 3B2 mold, fungus and dry rot spores (with the exception of fauna). The supplied connector covers must remain on the unused interfaces during operation!
- against chemically active substances / conformity with EN 60721-3-3	Yes; Class 3C4 (RH < 75%) incl. salt spray according to EN 60068-2-52 (degree of severity 3). The supplied connector covers must remain on the unused interfaces during operation!	Yes; Class 3C4 (RH < 75%) incl. salt spray according to EN 60068-2-52 (degree of severity 3). The supplied connector covers must remain on the unused interfaces during operation!	Yes; Class 3C4 (RH < 75%) incl. salt spray according to EN 60068-2-52 (degree of severity 3). The supplied connector covers must remain on the unused interfaces during operation!
- against mechanically active substances / conformity with EN 60721-3-3	Yes; Class 3S4 incl. sand, dust. The supplied connector covers must remain on the unused interfaces during operation!	Yes; Class 3S4 incl. sand, dust. The supplied connector covers must remain on the unused interfaces during operation!	Yes; Class 3S4 incl. sand, dust. The supplied connector covers must remain on the unused interfaces during operation!

Technical specifications (continued)

Article number	6AG1215-1BG40-4XB0	6AG1215-1BG40-5XB0	6AG1215-1BG40-2XB0
Based on	6ES7215-1BG40-0XB0 SIPLUS S7-1200 CPU 1215C AC/DC/RLY	6ES7215-1BG40-0XB0 SIPLUS S7-1200 CPU 1215C AC/DC/RLY	6ES7215-1BG40-0XB0 SIPLUS S7-1200 CPU 1215C AC/DC/RLY
Ambient conditions			
Ambient temperature during operation			
<ul style="list-style-type: none"> min. max. 	-20 °C; = Tmin; Startup @ 0 °C 60 °C; Number of simultaneously activated inputs or outputs 7 or 5 (no adjacent points) at 60 °C horizontal or 50 °C vertical, 14 or 10 at 55 °C horizontal or 45 °C vertical	-40 °C; = Tmin; Startup @ -25 °C 60 °C; = Tmax; Tmax > +55 °C number of simultaneously switched-on digital inputs 7, digital outputs 5, analog inputs 2, analog outputs 2 (no adjacent points) with horizontal mounting position	-40 °C; = Tmin; Startup @ -25 °C 70 °C; = Tmax; Tmax > +55 °C number of simultaneously switched-on digital inputs 7, digital outputs 5, analog inputs 2, analog outputs 2 (no adjacent points) with horizontal mounting position; Tmax > +60 °C number of simultaneously switched-on digital inputs 7, digital outputs 5, analog inputs 1, analog outputs 1 (no adjacent points) with horizontal mounting position
Extended ambient conditions			
<ul style="list-style-type: none"> relative to ambient temperature-atmospheric pressure-installation altitude 	Tmin ... Tmax at 1 080 hPa ... 795 hPa (-1 000 m ... +2 000 m) // Tmin ... (Tmax - 10 K) at 795 hPa ... 658 hPa (+2 000 m ... +3 500 m) // Tmin ... (Tmax - 20 K) at 658 hPa ... 540 hPa (+3 500 m ... +5 000 m); from 2 000 m max. 132 V AC	Tmin ... Tmax at 1 080 hPa ... 795 hPa (-1 000 m ... +2 000 m) // Tmin ... (Tmax - 10 K) at 795 hPa ... 658 hPa (+2 000 m ... +3 500 m) // Tmin ... (Tmax - 20 K) at 658 hPa ... 540 hPa (+3 500 m ... +5 000 m); from 2 000 m max. 132 V AC	Tmin ... Tmax at 1 080 hPa ... 795 hPa (-1 000 m ... +2 000 m) // Tmin ... (Tmax - 10 K) at 795 hPa ... 658 hPa (+2 000 m ... +3 500 m) // Tmin ... (Tmax - 20 K) at 658 hPa ... 540 hPa (+3 500 m ... +5 000 m); from 2 000 m max. 132 V AC
Relative humidity			
<ul style="list-style-type: none"> With condensation, tested in accordance with IEC 60068-2-38, max. 	100%; RH incl. condensation/frost (no commissioning under condensation conditions)	100%; RH incl. condensation/frost (no commissioning under condensation conditions)	100%; RH incl. condensation/frost (no commissioning under condensation conditions)
Resistance			
<ul style="list-style-type: none"> against biologically active substances / conformity with EN 60721-3-3 against chemically active substances / conformity with EN 60721-3-3 against mechanically active substances / conformity with EN 60721-3-3 	Yes; Class 3B2 mold, fungus and dry rot spores (with the exception of fauna). The supplied connector covers must remain on the unused interfaces during operation! Yes; Class 3C4 (RH < 75%) incl. salt spray according to EN 60068-2-52 (degree of severity 3). The supplied connector covers must remain on the unused interfaces during operation! Yes; Class 3S4 incl. sand, dust. The supplied connector covers must remain on the unused interfaces during operation!	Yes; Class 3B2 mold, fungus and dry rot spores (with the exception of fauna). The supplied connector covers must remain on the unused interfaces during operation! Yes; Class 3C4 (RH < 75%) incl. salt spray according to EN 60068-2-52 (degree of severity 3). The supplied connector covers must remain on the unused interfaces during operation! Yes; Class 3S4 incl. sand, dust. The supplied connector covers must remain on the unused interfaces during operation!	Yes; Class 3B2 mold, fungus and dry rot spores (with the exception of fauna). The supplied connector covers must remain on the unused interfaces during operation! Yes; Class 3C4 (RH < 75%) incl. salt spray according to EN 60068-2-52 (degree of severity 3). The supplied connector covers must remain on the unused interfaces during operation! Yes; Class 3S4 incl. sand, dust. The supplied connector covers must remain on the unused interfaces during operation!

SIMATIC S7-1200 Basic Controllers

Central processing units
SIPLUS standard CPUs

SIPLUS CPU 1215C

Technical specifications (continued)

Article number	6AG1215-1HG40-4XB0	6AG1215-1HG40-5XB0	6AG1215-1HG40-2XB0
Based on	6ES7215-1HG40-0XB0 SIPLUS S7-1200 CPU 1215C DC/DC/RLY	6ES7215-1HG40-0XB0 SIPLUS S7-1200 CPU 1215C DC/DC/RLY	6ES7215-1HG40-0XB0 SIPLUS S7-1200 CPU 1215C DC/DC/RLY
Ambient conditions			
Ambient temperature during operation			
<ul style="list-style-type: none"> min. max. 	-20 °C; = Tmin; Startup @ 0 °C 60 °C; Number of simultaneously activated inputs or outputs 7 or 5 (no adjacent points) at 60 °C horizontal or 50 °C vertical, 14 or 10 at 55 °C horizontal or 45 °C vertical	-40 °C; = Tmin; Startup @ -25 °C 60 °C; = Tmax; Tmax > +55 °C number of simultaneously switched-on digital inputs 7, digital outputs 5, analog inputs 2, analog outputs 2 (no adjacent points) with horizontal mounting position	-40 °C; = Tmin; Startup @ -25 °C 70 °C; = Tmax; Tmax > +55 °C number of simultaneously switched-on digital inputs 7, digital outputs 5, analog inputs 2, analog outputs 2 (no adjacent points) with horizontal mounting position; Tmax > +60 °C number of simultaneously switched-on digital inputs 7, digital outputs 5, analog inputs 1, analog outputs 1 (no adjacent points) with horizontal mounting position
Extended ambient conditions			
<ul style="list-style-type: none"> relative to ambient temperature-atmospheric pressure-installation altitude 	Tmin ... Tmax at 1 080 hPa ... 795 hPa (-1 000 m ... +2 000 m) // Tmin ... (Tmax - 10 K) at 795 hPa ... 658 hPa (+2 000 m ... +3 500 m) // Tmin ... (Tmax - 20 K) at 658 hPa ... 540 hPa (+3 500 m ... +5 000 m); from 2 000 m max. 132 V AC	Tmin ... Tmax at 1080 hPa ... 795 hPa (-1000 m ... +2000 m) // Tmin ... (Tmax - 10K) at 795 hPa ... 658 hPa (+2000 m ... +3500 m) // Tmin ... (Tmax - 20K) at 658 hPa ... 540 hPa (+3500 m ... +5000 m)	Tmin ... Tmax at 1 080 hPa ... 795 hPa (-1 000 m ... +2 000 m) // Tmin ... (Tmax - 10 K) at 795 hPa ... 658 hPa (+2 000 m ... +3 500 m) // Tmin ... (Tmax - 20 K) at 658 hPa ... 540 hPa (+3 500 m ... +5 000 m); from 2 000 m max. 132 V AC
Relative humidity			
<ul style="list-style-type: none"> With condensation, tested in accordance with IEC 60068-2-38, max. 	100%; RH incl. condensation/frost (no commissioning under condensation conditions)	100%; RH incl. condensation/frost (no commissioning under condensation conditions)	100%; RH incl. condensation/frost (no commissioning under condensation conditions)
Resistance			
<ul style="list-style-type: none"> against biologically active substances / conformity with EN 60721-3-3 against chemically active substances / conformity with EN 60721-3-3 against mechanically active substances / conformity with EN 60721-3-3 	Yes; Class 3B2 mold, fungus and dry rot spores (with the exception of fauna). The supplied connector covers must remain on the unused interfaces during operation! Yes; Class 3C4 (RH < 75%) incl. salt spray according to EN 60068-2-52 (degree of severity 3). The supplied connector covers must remain on the unused interfaces during operation! Yes; Class 3S4 incl. sand, dust. The supplied connector covers must remain on the unused interfaces during operation!	Yes; Class 3B2 mold, fungus and dry rot spores (with the exception of fauna). The supplied connector covers must remain on the unused interfaces during operation! Yes; Class 3C4 (RH < 75%) incl. salt spray according to EN 60068-2-52 (degree of severity 3). The supplied connector covers must remain on the unused interfaces during operation! Yes; Class 3S4 incl. sand, dust. The supplied connector covers must remain on the unused interfaces during operation!	Yes; Class 3B2 mold, fungus and dry rot spores (with the exception of fauna). The supplied connector covers must remain on the unused interfaces during operation! Yes; Class 3C4 (RH < 75%) incl. salt spray according to EN 60068-2-52 (degree of severity 3). The supplied connector covers must remain on the unused interfaces during operation! Yes; Class 3S4 incl. sand, dust. The supplied connector covers must remain on the unused interfaces during operation!

Ordering data	Article No.	Article No.	Article No.
<p>SIPLUS CPU 1215C compact CPU, AC/DC/relay</p> <p>(Extended temperature range and exposure to media)</p> <p>Integrated program and data memory 125 KB, load memory 4 MB; wide-range power supply 85 ... 264 V AC; Boolean execution times 0.085 µs per operation; 14 digital inputs, 10 digital outputs (relay), 2 analog inputs, 2 analog outputs; expandable by up to 3 communication modules, 8 signal modules and 1 signal board/communication board; digital inputs usable as HSC with 100 kHz</p> <ul style="list-style-type: none"> For areas with extreme medial exposure (conformal coating); ambient temperature -20 ... +60 °C For areas with extreme medial exposure (conformal coating); ambient temperature -40 ... +60 °C For areas with extreme medial exposure (conformal coating); ambient temperature -40 ... +70 °C 	<p>6AG1215-1BG40-4XB0</p> <p>6AG1215-1BG40-5XB0</p> <p>6AG1215-1BG40-2XB0</p>	<p>SIPLUS CPU 1215C compact CPU, DC/DC/relay</p> <p>(Extended temperature range and exposure to media)</p> <p>Integrated program and data memory 125 KB, load memory 4 MB; power supply 24 V DC; Boolean execution times 0.085 µs per operation; 14 digital inputs, 10 digital outputs (relay), 2 analog inputs, 2 analog outputs; expandable by up to 3 communication modules, 8 signal modules and 1 signal board/communication board; digital inputs usable as HSC with 100 kHz</p> <ul style="list-style-type: none"> For areas with extreme medial exposure (conformal coating); ambient temperature -20 ... +60 °C For areas with extreme medial exposure (conformal coating); ambient temperature -40 ... +60 °C For areas with extreme medial exposure (conformal coating); ambient temperature -40 ... +70 °C 	<p>6AG1215-1HG40-4XB0</p> <p>6AG1215-1HG40-5XB0</p> <p>6AG1215-1HG40-2XB0</p>
<p>SIPLUS CPU 1215C compact CPU, DC/DC/DC</p> <p>(Extended temperature range and exposure to media)</p> <p>Integrated program and data memory 125 KB, load memory 4 MB; power supply 24 V DC; Boolean execution times 0.085 µs per operation; 14 digital inputs, 10 digital outputs, 2 analog inputs, 2 analog outputs; expandable by up to 3 communication modules, 8 signal modules and 1 signal board/communication board; digital inputs usable as HSC with 100 kHz; 24 V DC digital outputs usable as pulse outputs (PTO) or pulse-width-modulated outputs (PWM) with 100 kHz</p> <ul style="list-style-type: none"> For areas with extreme medial exposure (conformal coating); ambient temperature -20 ... +60 °C For areas with extreme medial exposure (conformal coating); ambient temperature -40 ... +60 °C For areas with extreme medial exposure (conformal coating); ambient temperature -40 ... +70 °C 	<p>6AG1215-1AG40-4XB0</p> <p>6AG1215-1AG40-5XB0</p> <p>6AG1215-1AG40-2XB0</p>	<p>Accessories</p> <p>SIPLUS SB 1221 digital input signal board</p> <p>(Extended temperature range and exposure to media; cannot be used with 6AG1215-1.....-2XB0)</p> <p>4 inputs, 5 V DC, 200 kHz, sourcing</p> <p>4 inputs, 24 V DC, 200 kHz, sourcing</p> <p>SIPLUS SB 1222 digital output signal board</p> <p>(Extended temperature range and exposure to media; cannot be used with 6AG1215-1.....-2XB0)</p> <p>4 outputs, 5 V DC, 0.1 A, 200 kHz</p> <p>4 outputs, 24 V DC, 0.1 A, 200 kHz</p>	<p>6AG1221-3AD30-5XB0</p> <p>6AG1221-3BD30-5XB0</p> <p>6AG1222-1AD30-5XB0</p> <p>6AG1222-1BD30-5XB0</p>

SIMATIC S7-1200 Basic Controllers

Central processing units
SIPLUS standard CPUs

SIPLUS CPU 1215C**Ordering data****Article No.****Article No.****Digital input/output
SIPLUS signal board SB 1223**

(Extended temperature range and exposure to media; cannot be used with 6AG1215-1.....-2XB0)

2 inputs, 24 V DC,
IEC type 1 current sinking;
2 transistor outputs 24 V DC,
0.5 A, 5 W;
can be used as HSC at up to
30 kHz

- Suitable for areas with extreme medial exposure (conformal coating)
- Ambient temperature -25 ... +55 °C

2 inputs, 5 V DC, 200 kHz
2 outputs 5 V DC, 0.1 A, 200 kHz

2 inputs, 24 V DC, 200 kHz
2 outputs 24 V DC, 0.1 A, 200 kHz

6AG1223-0BD30-4XB0**6AG1223-0BD30-5XB0****6AG1223-3AD30-5XB0****6AG1223-3BD30-5XB0****SIPLUS SB 1232 analog output
signal board**

(Extended temperature range and exposure to media; cannot be used with 6AG1215-1.....-2XB0)

Ambient temperature range
-25 ... +55 °C

1 analog output, ±10 V with 12 bits
or 0 ... 20 mA with 11 bits

Ambient temperature range
0 ... +55 °C

1 analog output, ±10 V with 12 bits
or 0 ... 20 mA with 11 bits

**SIPLUS CB 1241 RS 485
communication board**

(Extended temperature range and exposure to media; cannot be used with 6AG1215-1.....-2XB0)

For point-to-point connection,
with 1 RS 485 interface

Additional accessories**6AG1232-4HA30-5XB0****6AG1232-4HA30-4XB0****6AG1241-1CH30-5XB1**

See SIMATIC S7-1200
CPU 1215C, page 3/18

Overview

The fail-safe SIMATIC S7-1200 Controllers are based on the S7-1200 standard CPUs and offer additional safety-related functions.

They can be used for safety-oriented tasks according to IEC 61508 up to SIL 3 and ISO 13849-1 up to PL e.

Safety-related programs are created in the TIA Portal. The STEP 7 Safety engineering tool offers commands, operations and blocks for safety-related programs in the LAD and FBD languages. To this end, there is a library with pre-configured, TÜV-approved blocks for safety-related functions.

- Standard controller with integrated safety functions:
 - Standardized and convenient diagnostic functions for standard and safety
 - Uniform symbols, data consistency, ...
- Modular system with scalable range of CPUs and expandable I/O quantity structure:
 - One engineering for standard and fail-safe automation
 - Use of the standard I/O modules together with the fail-safe I/O modules in the central system
 - Integrated standard PROFINET functionalities for PROFINET controllers and PROFINET iDevice services
 - Connection of distributed standard I/O via field bus such as PROFINET or PROFIBUS
 - F-library certified by the German Technical Inspectorate (TÜV) for all common safety functions
 - Free programming of the safety logic using FBD and LAD
 - Standard-compliant printout of the F-program
- One integrated engineering for both standard and safety from S7-1200 to S7-300/400/1500 and WinAC RTX F:
 - STEP 7 Safety Basic for easy engineering of the CPU 1200 FC
 - STEP 7 Safety Advanced for the entire fail-safe SIMATIC S7 portfolio
- Integrated system diagnosis of the CPUs, for standard and safety:
 - Consistent plain text display of system diagnostic information in the TIA Portal, HMI and web server
 - Messages are updated even if the CPU is in STOP state
 - System diagnostics integrated in the CPU firmware. Configuration by user not required
 - The diagnostics is automatically updated on configuration changes.
- 2 fail-safe compact controllers with graded performances in the versions DC/DC/DC and DC/DC/relay

Characteristics	CPU 1212 FC	CPU 1214 FC	CPU 1215 FC
Variants	DC/DC/DC, DC/DC/relay	DC/DC/DC, DC/DC/relay	DC/DC/DC, DC/DC/relay
Main memory, integrated	100 KB	125 KB	150 KB
Load memory, integrated	2 MB	4 MB	4 MB
Memory card	SIMATIC Memory Card (optional)	SIMATIC Memory Card (optional)	SIMATIC Memory Card (optional)
Standard digital inputs/outputs, integrated	8/6	14/10	14/10
Standard analog inputs, integrated	2	2	2
Standard analog outputs, integrated	-	-	2
Process image	1024 bytes for inputs, 1024 bytes for outputs	1024 bytes for inputs, 1024 bytes for outputs	1024 bytes for inputs, 1024 bytes for outputs
Expansion by signal board	Max. 1	Max. 1	Max. 1
Expansion by signal modules	Max. 2	Max. 8	Max. 8
Expansion by communication modules	Max. 3	Max. 3	Max. 3

SIMATIC S7-1200 Basic Controllers

Central processing units
Fail-safe CPUs

CPU 1212 FC, CPU 1214 FC, CPU 1215 FC

Technical specifications

Article number	6ES7212-1AF40-0XB0	6ES7212-1HF40-0XB0	6ES7214-1AF40-0XB0	6ES7214-1HF40-0XB0	6ES7215-1AF40-0XB0	6ES7215-1HF40-0XB0
	CPU 1212FC, DC/DC/DC, 8DI/6DO/2AI	CPU 1212FC, DC/DC/RELAY, 8DI/6DO/2AI	CPU 1214 FC, DC/DC/DC, 14DI/10DO/2AI	CPU 1214 FC, DC/DC/RELAY, 14DI/10DO/2AI	CPU 1215 FC, DC/DC/DC, 14DI/10DO/2AI/2AO	CPU 1215 FC, DC/DC/RLY, 14DI/10DO/2AI/2AO
General information						
Product type designation	CPU 1212FC DC/DC/DC	CPU 1212FC DC/DC/relay	CPU 1214FC DC/DC	CPU 1214FC DC/DC/Relay	CPU 1215FC DC/DC/DC	CPU 1215C DC/DC/Relay
Engineering with						
• Programming package	STEP 7 V14 or higher	STEP 7 V14 or higher	STEP 7 V14 or higher	STEP 7 V14 or higher	STEP 7 V14 or higher	STEP 7 V14 or higher
Supply voltage						
Rated value (DC)						
• 24 V DC	Yes	Yes	Yes	Yes	Yes	Yes
Encoder supply						
24 V encoder supply						
• 24 V	Permissible range: 20.4V to 28.8V	Permissible range: 20.4V to 28.8V	L+ minus 4 V DC min.	L+ minus 4 V DC min.	L+ minus 4 V DC min.	L+ minus 4 V DC min.
Power loss						
Power loss, typ.	9 W	9 W	12 W	12 W	12 W	12 W
Memory						
Work memory						
• integrated	100 kbyte	100 kbyte	125 kbyte	125 kbyte	150 kbyte	150 kbyte
Load memory						
• integrated	2 Mbyte	2 Mbyte	4 Mbyte	4 Mbyte	4 Mbyte	4 Mbyte
• Plug-in (SIMATIC Memory Card), max.	with SIMATIC memory card	with SIMATIC memory card	with SIMATIC memory card	with SIMATIC memory card	with SIMATIC memory card	with SIMATIC memory card
Backup						
• without battery	Yes	Yes	Yes	Yes	Yes	Yes
CPU processing times						
for bit operations, typ.	0.085 µs; / instruction	0.085 µs; / instruction	0.085 µs; / instruction	0.085 µs; / instruction	0.085 µs; / instruction	0.085 µs; / instruction
for word operations, typ.	1.7 µs; / instruction	1.7 µs; / instruction	1.7 µs; / instruction	1.7 µs; / instruction	1.7 µs; / instruction	1.7 µs; / instruction
for floating point arithmetic, typ.	2.5 µs; / instruction	2.5 µs; / instruction	2.3 µs; / instruction	2.3 µs; / instruction	2.3 µs; / instruction	2.3 µs; / instruction
Data areas and their retentivity						
Flag						
• Number, max.	4 kbyte; Size of bit memory address area	4 kbyte; Size of bit memory address area	8 kbyte; Size of bit memory address area	8 kbyte; Size of bit memory address area	8 kbyte; Size of bit memory address area	8 kbyte; Size of bit memory address area
Address area						
I/O address area						
• Inputs	1 024 byte	1 024 byte	1 024 byte			
• Outputs	1 024 byte	1 024 byte	1 024 byte			
Process image						
• Inputs, adjustable	1 kbyte	1 kbyte	1 kbyte	1 kbyte	1 kbyte	1 kbyte
• Outputs, adjustable	1 kbyte	1 kbyte	1 kbyte	1 kbyte	1 kbyte	1 kbyte
Time of day						
Clock						
• Hardware clock (real-time)	Yes	Yes	Yes		Yes	Yes
Digital inputs						
Number of digital inputs	8; Integrated	8; Integrated	14		14; Integrated	14; Integrated
• of which inputs usable for technological functions	4; HSC (High Speed Counting)	4; HSC (High Speed Counting)	6; HSC (High Speed Counting)		6; HSC (High Speed Counting)	6; HSC (High Speed Counting)
Digital outputs						
Number of digital outputs	6	6	10		10; Relays	10; Relays
• of which high-speed outputs	4; 100 kHz Pulse Train Output		4; 100 kHz Pulse Train Output			
Analog inputs						
Number of analog inputs	2	2	2	2	2	2
Input ranges						
• Voltage	Yes	Yes	Yes	Yes	Yes	Yes
Analog outputs						
Number of analog outputs		0	0	0	2	2
Output ranges, current						
• 0 to 20 mA				Yes	Yes	Yes

Technical specifications (continued)

Article number	6ES7212-1AF40-0XB0	6ES7212-1HF40-0XB0	6ES7214-1AF40-0XB0	6ES7214-1HF40-0XB0	6ES7215-1AF40-0XB0	6ES7215-1HF40-0XB0
	CPU 1212FC , DC/DC/DC, 8DI/6DO/2AI	CPU 1212FC, DC/DC/RELAY, 8DI/6DO/2AI	CPU 1214 FC, DC/DC/DC, 14DI/10DO/2AI	CPU 1214 FC, DC/DC/RELAY, 14DI/10DO/2AI	CPU 1215 FC, DC/DC/DC, 14DI/ 10DO/2AI/2AO	CPU 1215 FC, DC/DC/RLY, 14DI/ 10DO/2AI/2AO
1. Interface						
Interface type	PROFINET	PROFINET	PROFINET	PROFINET	PROFINET	PROFINET
Physics	Ethernet	Ethernet	Ethernet	Ethernet	Ethernet	Ethernet
Functionality						
• PROFINET IO Controller	Yes	Yes	Yes	Yes	Yes	Yes
• PROFINET IO Device	Yes	Yes	Yes	Yes	Yes	Yes
• SIMATIC communication	Yes	Yes	Yes	Yes	Yes	Yes
• Open IE communication	Yes	Yes	Yes	Yes	Yes	Yes
• Web server	Yes	Yes	Yes	Yes	Yes	Yes
• Media redundancy			Yes; as MRP client	Yes; as MRP client	Yes; as MRP client	Yes; as MRP client
Communication functions						
S7 communication						
• supported	Yes	Yes	Yes	Yes	Yes	Yes
Open IE communication						
• TCP/IP	Yes	Yes	Yes	Yes	Yes	Yes
• ISO-on-TCP (RFC1006)	Yes	Yes	Yes	Yes	Yes	Yes
• UDP	Yes	Yes	Yes	Yes	Yes	Yes
Web server						
• supported	Yes	Yes	Yes	Yes	Yes	Yes
Number of connections						
• overall			16; dynamically	16; dynamically	16; dynamically	16; dynamically
Integrated Functions						
Number of counters	4	4	6	6	6	6
Counting frequency (counter) max.	100 kHz	100 kHz	100 kHz	100 kHz	100 kHz	100 kHz
Frequency meter	Yes	Yes	Yes	Yes	Yes	Yes
controlled positioning	Yes	Yes	Yes	Yes	Yes	Yes
Number of position-controlled positioning axes, max.	8	8	8	8	8	8
Number of positioning axes via pulse-direction interface	Up to 4 with SB 1222	Up to 4 with SB 1222	Up to 4 with SB 1222	Up to 4 with SB 1222	Up to 4 with SB 1222	Up to 4 with SB 1222
PID controller	Yes	Yes	Yes	Yes	Yes	Yes
Number of alarm inputs	4		4	4	4	4
Number of pulse outputs	4	4				
Limit frequency (pulse)	100 kHz					
Ambient conditions						
Ambient temperature during operation						
• min.	-20 °C	-20 °C	-20 °C	-20 °C	-20 °C	-20 °C
• max.	60 °C; Number of simultaneously activated inputs or outputs 7 or 5 (no adjacent points) at 60 °C horizontal or 50 °C vertical, 14 or 10 at 55 °C horizontal or 45 °C vertical	60 °C; Number of simultaneously activated inputs or outputs 7 or 5 (no adjacent points) at 60 °C horizontal or 50 °C vertical, 14 or 10 at 55 °C horizontal or 45 °C vertical	60 °C; Number of simultaneously activated inputs or outputs 7 or 5 (no adjacent points) at 60 °C horizontal or 50 °C vertical, 14 or 10 at 55 °C horizontal or 45 °C vertical	60 °C; Number of simultaneously activated inputs or outputs 7 or 5 (no adjacent points) at 60 °C horizontal or 50 °C vertical, 14 or 10 at 55 °C horizontal or 45 °C vertical	60 °C; Number of simultaneously activated inputs or outputs 7 or 5 (no adjacent points) at 60 °C horizontal or 50 °C vertical, 14 or 10 at 55 °C horizontal or 45 °C vertical	60 °C; Number of simultaneously activated inputs or outputs 7 or 5 (no adjacent points) at 60 °C horizontal or 50 °C vertical, 14 or 10 at 55 °C horizontal or 45 °C vertical
Pollutant concentrations						
- SO2 at RH < 60% without condensation	SO2: < 0.5 ppm; H2S: < 0.1 ppm; RH < 60% condensation-free	SO2: < 0.5 ppm; H2S: < 0.1 ppm; RH < 60% condensation-free	SO2: < 0.5 ppm; H2S: < 0.1 ppm; RH < 60% condensation-free	SO2: < 0.5 ppm; H2S: < 0.1 ppm; RH < 60% condensation-free	SO2: < 0.5 ppm; H2S: < 0.1 ppm; RH < 60% condensation-free	SO2: < 0.5 ppm; H2S: < 0.1 ppm; RH < 60% condensation-free

SIMATIC S7-1200 Basic Controllers

Central processing units

Fail-safe CPUs

CPU 1212 FC, CPU 1214 FC, CPU 1215 FC

Technical specifications (continued)

Article number	6ES7212-1AF40-0XB0	6ES7212-1HF40-0XB0	6ES7214-1AF40-0XB0	6ES7214-1HF40-0XB0	6ES7215-1AF40-0XB0	6ES7215-1HF40-0XB0
	CPU 1212FC , DC/DC/DC, 8DI/6DO/2AI	CPU 1212FC, DC/DC/RELAY, 8DI/6DO/2AI	CPU 1214 FC, DC/DC/DC, 14DI/10DO/2AI	CPU 1214 FC, DC/DC/RELAY, 14DI/10DO/2AI	CPU 1215 FC, DC/DC/DC, 14DI/ 10DO/2AI/2AO	CPU 1215 FC, DC/DC/RLY, 14DI/ 10DO/2AI/2AO
Configuration						
Programming						
Programming language						
- LAD	Yes; incl. failsafe	Yes; incl. failsafe	Yes; incl. failsafe	Yes; incl. failsafe	Yes; incl. failsafe	Yes; incl. failsafe
- FBD	Yes; incl. failsafe	Yes; incl. failsafe	Yes; incl. failsafe	Yes; incl. failsafe	Yes; incl. failsafe	Yes; incl. failsafe
- SCL	Yes	Yes	Yes	Yes	Yes	Yes
Dimensions						
Width	90 mm	90 mm	110 mm	110 mm	130 mm	130 mm
Height	100 mm	100 mm	100 mm	100 mm	100 mm	100 mm
Depth	75 mm	75 mm	75 mm	75 mm	75 mm	75 mm
Weights						
Weight, approx.	370 g	385 g	435 g	435 g	585 g	585 g

Ordering data

Article No.

Article No.

CPU 1212 FC

Fail-safe compact CPU, DC/DC/DC;
integrated program/data memory 100 KB, load memory 2 MB;
power supply 24 V DC;
Boolean execution times 0.085 µs per operation;
8 digital inputs,
6 digital outputs,
2 analog inputs;
expandable by up to
3 communication modules,
2 signal modules, and 1 signal board/communication board;
digital inputs can be used as HSC at 100 kHz,
24 V DC digital outputs can be used as pulse outputs (PTO) or pulse-width modulated outputs (PWM) at 100 kHz

6ES7212-1AF40-0XB0

Fail-safe compact CPU, DC/DC/relay;
integrated program/data memory 125 KB, load memory 2 MB;
power supply 24 V DC;
Boolean execution times 0.085 µs per operation;
8 digital inputs, 6 digital outputs (relays),
2 analog inputs;
expandable by up to
3 communication modules, 2 signal modules, and 1 signal board/communication board;
digital inputs can be used as HSC at 100 kHz

6ES7212-1HF40-0XB0

CPU 1214 FC

Fail-safe compact CPU, DC/DC/DC;
integrated program/data memory 125 KB, load memory 4 MB;
power supply 24 V DC;
Boolean execution times 0.085 µs per operation;
14 digital inputs,
10 digital outputs,
2 analog inputs;
expandable by up to
3 communication modules,
8 signal modules, and 1 signal board/communication board;
digital inputs can be used as HSC at 100 kHz,
24 V DC digital outputs can be used as pulse outputs (PTO) or pulse-width modulated outputs (PWM) at 100 kHz

6ES7214-1AF40-0XB0

Fail-safe compact CPU, DC/DC/relay;
integrated program/data memory 125 KB, load memory 4 MB;
power supply 24 V DC;
Boolean execution times 0.085 µs per operation;
14 digital inputs,
10 digital outputs (relays),
2 analog inputs;
expandable by up to
3 communication modules,
8 signal modules, and 1 signal board/communication board;
digital inputs can be used as HSC at 100 kHz

6ES7214-1HF40-0XB0

Ordering data	Article No.	Article No.
CPU 1215 FC		
Fail-safe compact CPU, DC/DC/DC; integrated program/data memory 150 KB, load memory 4 MB; power supply 24 V DC; Boolean execution times 0.085 µs per operation; 14 digital inputs, 10 digital outputs, 2 analog inputs; 2 analog outputs; expandable by up to 3 communication modules, 8 signal modules, and 1 signal board/communication board; digital inputs can be used as HSC at 100 kHz, 24 V DC digital outputs can be used as pulse outputs (PTO) or pulse-width modulated outputs (PWM) at 100 kHz	6ES7215-1AF40-0XB0	
Fail-safe compact CPU, DC/DC/relay; integrated program/data memory 150 KB, load memory 4 MB; power supply 24 V DC; Boolean execution times 0.085 µs per operation; 14 digital inputs, 10 digital outputs (relays), 2 analog inputs; 2 analog outputs; expandable by up to 3 communication modules, 8 signal modules, and 1 signal board/communication board; digital inputs can be used as HSC at 100 kHz	6ES7215-1HF40-0XB0	
Accessories		
SIMATIC S7-1200 Fail-Safe Starter Kit Consisting of: CPU 1212FC DC/DC relay, F digital input SM 1226 16 x 24 V DC, F digital output SM 1226 4 x 24 V DC, input simulator, STEP 7 Basic and STEP 7 Safety Basic on CD, manual on CD, info material; in Systainer	6ES7212-1HF41-4YB0	
Simulator (optional) 14 incoming circuit breakers	6ES7274-1XH30-0XA0	
SIMATIC Memory Card (optional) 4 MB 12 MB 24 MB 256 MB 2 GB 32 GB	6ES7954-8LC02-0AA0 6ES7954-8LE02-0AA0 6ES7954-8LF02-0AA0 6ES7954-8LL02-0AA0 6ES7954-8LP02-0AA0 6ES7954-8LT03-0AA0	
Extension cable for two-tier configuration For connecting digital/analog signal modules; length 2 m	6ES7290-6AA30-0XA0	
Terminal block (spare part) For CPU 1214FC, DC/DC/DC • For DI, with 20 screws, tin-coated; 4 units • For DO, with 12 screws, tin-coated; 4 units • For AI, with 3 screws, gold-plated; 4 units	6ES7292-1AV30-0XA0 6ES7292-1AM30-0XA0 6ES7292-1BC30-0XA0	
Terminal block (spare part) (cont.) For CPU 1214FC, DC/DC/relay • For DI, with 20 screws, tin-coated; 4 units • For DO, with 12 screws, tin-coated, coded; 4 units • For AI, with 3 screws, gold-plated; 4 units For CPU 1215FC, DC/DC/DC • For DI, with 20 screws, tin-coated; 4 units • For DO, with 12 screws, tin-coated; 4 units • For AI, with 6 screws, gold-plated; 4 units For CPU 1215FC, DC/DC/relay • For DI, with 20 screws, tin-coated; 4 units • For DO, with 12 screws, tin-coated, coded; 4 units • For AI, with 6 screws, gold-plated; 4 units	6ES7292-1AV30-0XA0 6ES7292-1AM40-0XA0 6ES7292-1BC30-0XA0 6ES7292-1AV30-0XA0 6ES7292-1AM30-0XA0 6ES7292-1BF30-0XA0 6ES7292-1AV30-0XA0 6ES7292-1AM40-0XA0 6ES7292-1BF30-0XA0	
Front flap set (spare part) For CPU 1214 FC For CPU 1215 FC	6ES7291-1AB30-0XA0 6ES7291-1AC30-0XA0	
RJ45 cable grip 4 items per pack Single port Dual port	6ES7290-3AA30-0XA0 6ES7290-3AB30-0XA0	
STEP 7 Safety Advanced V14 SP1 Task: Engineering tool for configuring and programming fail-safe user programs for SIMATIC S7-1200 FC, S7-1500F, S7-1500F Software Controller, S7-300F, S7-400F, WinAC RTX F, ET 200SP F Controller and the fail-safe ET 200SP, ET 200S, ET 200M, ET 200iSP, ET 200pro and ET 200eco I/O Requirement: STEP 7 Professional V14 SP1 Floating license for 1 user, software and documentation on DVD, license key on USB flash drive Floating license for 1 user, software, documentation and license key for download ¹⁾ ; email address required for delivery	6ES7833-1FA14-0YA5 6ES7833-1FA14-0YH5	
STEP 7 Safety Basic V14 SP1 Task: Engineering tool for configuring fail-safe user programs for SIMATIC S7-1200 FC Requirement: STEP 7 Basic V14 SP1 and higher Floating license for 1 user; software and documentation on DVD, license key on USB flash drive Floating license for 1 user, software, documentation and license key for download ¹⁾ ; email address required for delivery	6ES7833-1FB14-0YA5 6ES7833-1FB14-0YH5	

¹⁾ For up-to-date information and download availability, see:
<http://www.siemens.com/tia-online-software-delivery>

SIMATIC S7-1200 Basic Controllers

Central processing units

SIPLUS fail-safe CPUs

Overview



The fail-safe SIPLUS S7-1200 Controllers are based on the S7-1200 standard CPUs and offer additional safety-related functions.

They can be used for safety-oriented tasks according to IEC 61508 up to SIL 3 and ISO 13849-1 up to PL e.

Safety-related programs are created in the TIA Portal. The STEP 7 Safety engineering tool offers commands, operations and blocks for safety-related programs in the LAD and FBD languages. To this end, there is a library with pre-configured, TÜV-approved blocks for safety-related functions.

- Standard controller with integrated safety functions:
 - Standardized and convenient diagnostic functions for standard and safety
 - Uniform symbols, data consistency, ...
- Modular system with scalable range of CPUs and expandable I/O quantity structure:
 - One engineering for standard and fail-safe automation
 - Use of the standard I/O modules together with the fail-safe I/O modules in the central system
 - Integrated standard PROFINET functionalities for PROFINET controllers and PROFINET iDevice services
 - Connection of distributed standard I/O via field bus such as PROFINET or PROFIBUS
 - F-library certified by the German Technical Inspectorate (TÜV) for all common safety functions
 - Free programming of the safety logic using FBD and LAD
 - Standard-compliant printout of the F-program
- One integrated engineering for both standard and safety from S7-1200 to S7-300/400/1500 and WinAC RTX F:
 - STEP 7 Safety Basic for easy engineering of the CPU 1200 FC
 - STEP 7 Safety Advanced for the entire fail-safe SIMATIC S7 portfolio
- Integrated system diagnosis of the CPUs, for standard and safety:
 - Consistent plain text display of system diagnostic information in the TIA Portal, HMI and web server
 - Messages are updated even if the CPU is in STOP state
 - System diagnostics integrated in the CPU firmware. Configuration by user not required
 - The diagnostics is automatically updated on configuration changes.
- 2 fail-safe compact controllers with graded performances in the versions DC/DC/DC and DC/DC/relay

Characteristics	SIPLUS CPU 1214 FC
Variants	DC/DC/DC, DC/DC/relay
Main memory, integrated	125 KB
Load memory, integrated	4 MB
Memory card	SIMATIC memory card (optional)
Standard digital inputs/outputs, integrated	14/10
Standard analog inputs, integrated	2
Standard analog outputs, integrated	-
Process image	1024 bytes for inputs, 1024 bytes for outputs
Expansion by signal board	Max. 1
Expansion by signal modules	Max. 8
Expansion by communication modules	Max. 3

Note:

SIPLUS extreme products are based on SIMATIC standard products. The contents listed here were taken from the corresponding standard products. SIPLUS extreme-specific information was added.

Technical specifications

Article number	6AG1214-1AF40-5XB0	6AG1214-1HF40-5XB0
Based on	6ES7214-1AF40-0XB0 SIPPLUS S7-1200 CPU 1214FC DC/DC/DC	6ES7214-1HF40-0XB0 SIPPLUS S7-1200 CPU 1214FC DC/DC/RLY
Ambient conditions		
Ambient temperature during operation		
• min.	-25 °C; = Tmin	-25 °C; = Tmin
• max.	55 °C; = Tmax	55 °C; = Tmax
Extended ambient conditions		
• relative to ambient temperature-atmospheric pressure-installation altitude	Tmin ... Tmax at 1080 hPa ... 795 hPa (-1000 m ... +2000 m)	Tmin ... Tmax at 1080 hPa ... 795 hPa (-1000 m ... +2000 m)
Relative humidity		
- With condensation, tested in accordance with IEC 60068-2-38, max.	100%; RH incl. condensation/frost (no commissioning under condensation conditions)	100%; RH incl. condensation/frost (no commissioning under condensation conditions)
Pollutant concentrations		
- SO ₂ at RH < 60% without condensation	SO ₂ : < 0.5 ppm; H ₂ S: < 0.1 ppm; RH < 60% condensation-free	SO ₂ : < 0.5 ppm; H ₂ S: < 0.1 ppm; RH < 60% condensation-free
Resistance		
- against biologically active substances / conformity with EN 60721-3-3	Yes; Class 3B2 mold, fungus and dry rot spores (with the exception of fauna). The supplied connector covers must remain on the unused interfaces during operation!	Yes; Class 3B2 mold, fungus and dry rot spores (with the exception of fauna). The supplied connector covers must remain on the unused interfaces during operation!
- against chemically active substances / conformity with EN 60721-3-3	Yes; Class 3C4 (RH < 75%) incl. salt spray according to EN 60068-2-52 (degree of severity 3). The supplied connector covers must remain on the unused interfaces during operation!	Yes; Class 3C4 (RH < 75%) incl. salt spray according to EN 60068-2-52 (degree of severity 3). The supplied connector covers must remain on the unused interfaces during operation!
- against mechanically active substances / conformity with EN 60721-3-3	Yes; Class 3S4 incl. sand, dust. The supplied connector covers must remain on the unused interfaces during operation!	Yes; Class 3S4 incl. sand, dust. The supplied connector covers must remain on the unused interfaces during operation!

Ordering data

	Article No.	Article No.
CPU 1214 FC (Extended temperature range and environmental stress) Fail-safe compact CPU, DC/DC/DC; integrated program/data memory 125 KB, load memory 4 MB; power supply 24 V DC; Boolean execution times 0.085 µs per operation; 14 digital inputs, 10 digital outputs, 2 analog inputs; expandable by up to 3 communication modules, 8 signal modules, and 1 signal board/communication board; digital inputs can be used as HSC at 100 kHz, 24 V DC digital outputs can be used as pulse outputs (PTO) or pulse-width modulated outputs (PWM) at 100 kHz	6AG1214-1AF40-5XB0	Fail-safe compact CPU, DC/DC/relay; integrated program/data memory 125 KB, load memory 4 MB; power supply 24 V DC; Boolean execution times 0.085 µs per operation; 14 digital inputs, 10 digital outputs (relays), 2 analog inputs; expandable by up to 3 communication modules, 8 signal modules, and 1 signal board/communication board; digital inputs can be used as HSC at 100 kHz Accessories
		6AG1214-1HF40-5XB0 See SIMATIC CPU 1214 FC, page 3/45

SIMATIC S7-1200 Basic Controllers

I/O modules

Digital modules

SM 1221 digital input modules

Overview



- Digital inputs as supplement to the integral I/O of the CPUs
- For flexible adaptation of the controller to the relevant task
- For subsequent expansion of the system with additional inputs

3

Technical specifications

Article number	6ES7221-1BF32-0XB0 DIGITAL INPUT SM 1221, 8DI, 24V DC	6ES7221-1BH32-0XB0 DIGITAL INPUT SM 1221, 16DI, 24V DC
General information		
Product type designation	SM 1221 DI 8x24 VDC	SM 1221 DI 16x24 VDC
Supply voltage		
Rated value (DC)		
• 24 V DC	Yes	Yes
Input current		
from backplane bus 5 V DC, max.	105 mA	130 mA
Digital inputs		
• from load voltage L+ (without load), max.	4 mA; per channel	4 mA; per channel
Output voltage		
Power supply to the transmitters		
• present	Yes	Yes
Power loss		
Power loss, typ.	1.5 W	2.5 W
Digital inputs		
Number of digital inputs	8	16
• in groups of	2	4
Input characteristic curve in accordance with IEC 61131, type 1	Yes	Yes
Number of simultaneously controllable inputs		
all mounting positions		
- up to 40 °C, max.	8	16
horizontal installation		
- up to 40 °C, max.	8	16
- up to 50 °C, max.	8	16
vertical installation		
- up to 40 °C, max.	8	16

Technical specifications (continued)

Article number	6ES7221-1BF32-0XB0 DIGITAL INPUT SM 1221, 8DI, 24V DC	6ES7221-1BH32-0XB0 DIGITAL INPUT SM 1221, 16DI, 24V DC
Input voltage		
• Type of input voltage	DC	DC
• Rated value (DC)	24 V	24 V
• for signal "0"	5 V DC at 1 mA	5 V DC at 1 mA
• for signal "1"	15 V DC at 2.5 mA	15 V DC at 2.5 mA
Input current		
• for signal "0", max. (permissible quiescent current)	1 mA	1 mA
• for signal "1", min.	2.5 mA	2.5 mA
• for signal "1", typ.	4 mA	4 mA
Input delay (for rated value of input voltage)		
for standard inputs		
- parameterizable	Yes; 0.2 ms, 0.4 ms, 0.8 ms, 1.6 ms, 3.2 ms, 6.4 ms and 12.8 ms, selectable in groups of four	Yes; 0.2 ms, 0.4 ms, 0.8 ms, 1.6 ms, 3.2 ms, 6.4 ms and 12.8 ms, selectable in groups of four
for interrupt inputs		
- parameterizable	Yes	Yes
Cable length		
• shielded, max.	500 m	500 m
• unshielded, max.	300 m	300 m
Interrupts/diagnostics/status information		
Alarms		
• Diagnostic alarm	Yes	Yes
Diagnostics indication LED		
• for status of the inputs	Yes	Yes
Potential separation		
Potential separation digital inputs		
• between the channels, in groups of	2	4
Degree and class of protection		
Degree of protection acc. to EN 60529		
• IP20	Yes	Yes
Standards, approvals, certificates		
CE mark	Yes	Yes
CSA approval	Yes	Yes
cULus	Yes	Yes
FM approval	Yes	Yes
RCM (formerly C-TICK)	Yes	Yes
Marine approval		
• Marine approval		Yes
Ambient conditions		
Free fall		
• Fall height, max.	0.3 m; five times, in product package	0.3 m; five times, in product package
Ambient temperature during operation		
• permissible temperature range	-20 °C to +60 °C horizontal mounting, -20 °C to 50 °C vertical mounting, 95% humidity, non-condensing	
• min.	-20 °C	-20 °C
• max.	60 °C	60 °C
Connection method		
required front connector	Yes	Yes
Mechanics/material		
Enclosure material (front)		
• Plastic	Yes	Yes
Dimensions		
Width	45 mm	45 mm
Height	100 mm	100 mm
Depth	75 mm	75 mm
Weights		
Weight, approx.	170 g	210 g

SIMATIC S7-1200 Basic Controllers

I/O modules

Digital modules

SM 1221 digital input modules**Ordering data****Article No.****Article No.****SM 1221 digital input signal module**

8 inputs, 24 V DC, isolated, current sourcing/sinking

6ES7221-1BF32-0XB0

16 inputs, 24 V DC, isolated, current sourcing/sinking

6ES7221-1BH32-0XB0**Extension cable for two-tier configuration**

For connecting digital/analog signal modules; length 2 m

6ES7290-6AA30-0XA0**Terminal block (spare part)**

For 6ES7221-1BF32-0XB0, 6ES7221-1BH32-0XB0

With 7 screws, zinc-plated; 4 pcs.

6ES7292-1AG30-0XA0**Front flap set (spare part)**

For modules with a width of 45 mm

6ES7291-1BA30-0XA0

3

Overview



- Digital inputs as a supplement to the integral I/O of SIMATIC S7-1200 CPUs
- Can be plugged directly into the CPU

Technical specifications

Article number	6ES7221-3AD30-0XB0	6ES7221-3BD30-0XB0
	SIGNAL BOARD SB 1221, 4 DI 5VDC 200KHZ	SIGNAL BOARD SB 1221, 4 DI 24VDC 200KHZ
General information		
Product type designation	SB 1221 4xDI 5VDC 200kHz	SB 1221 4xDI 24VDC 200kHz
Input current		
from backplane bus 5 V DC, typ.	40 mA	40 mA
Power loss		
Power loss, typ.	1 W	1 W
Digital inputs		
Number of digital inputs	4; Current-sourcing	4; Current-sourcing
• in groups of	4	4
Input voltage		
• Type of input voltage	DC	DC
• Rated value (DC)	5 V	24 V
• for signal "0"	(L+ minus 1.0 V DC) ... L+ (2.2 ... 0 mA)	(L+ minus 5.0 V DC) ... L+ (1.4 ... 0 mA)
• for signal "1"	0 V ... (L+ minus 2.0 V DC (20 ... 5.1 mA))	0 V ... (L+ minus 10 V DC (10 ... 2.9 mA))
Input current		
• for signal "0", max. (permissible quiescent current)	2.2 mA	1.4 mA
• for signal "1", min.	5.1 mA	2.9 mA
• for signal "1", typ.		7 mA
Input delay (for rated value of input voltage)		
for standard inputs		
- parameterizable	Yes; 0.1 / 0.2 / 0.4 / 0.8 / 1.6 / 3.2 / 6.4 / 10.0 / 12.8 / 20.0 μs; 0.05 / 0.1 / 0.2 / 0.4 / 0.8 / 1.6 / 3.2 / 6.4 / 10.0 / 12.8 / 20.0 ms	Yes; 0.1 / 0.2 / 0.4 / 0.8 / 1.6 / 3.2 / 6.4 / 10.0 / 12.8 / 20.0 μs; 0.05 / 0.1 / 0.2 / 0.4 / 0.8 / 1.6 / 3.2 / 6.4 / 10.0 / 12.8 / 20.0 ms
for interrupt inputs		
- parameterizable	Yes	Yes
for counter/technological functions		
- parameterizable	Yes	Yes
Cable length		
• shielded, max.	50 m; shielded, twisted pair	50 m; shielded, twisted pair
Diagnostics indication LED		
• for status of the inputs	Yes	Yes
Degree and class of protection		
Degree of protection acc. to EN 60529		
• IP20	Yes	Yes

SIMATIC S7-1200 Basic Controllers

I/O modules

Digital modules

SB 1221 digital input modules**Technical specifications** (continued)

Article number	6ES7221-3AD30-0XB0 SIGNAL BOARD SB 1221, 4 DI 5VDC 200KHZ	6ES7221-3BD30-0XB0 SIGNAL BOARD SB 1221, 4 DI 24VDC 200KHZ
Ambient conditions		
Free fall		
• Fall height, max.	0.3 m; five times, in product package	0.3 m; five times, in product package
Ambient temperature during operation		
• permissible temperature range	-20 °C to +60 °C horizontal mounting, -20 °C to 50 °C vertical mounting	-20 °C to +60 °C horizontal mounting, -20 °C to 50 °C vertical mounting with 2 simultaneously activated, non-adjacent inputs; otherwise up to 55 °C with horizontal mounting or 45 °C with vertical mounting
• min.	-20 °C	-20 °C
• max.	60 °C	60 °C
Mechanics/material		
Enclosure material (front)		
• Plastic	Yes	Yes
Dimensions		
Width	38 mm	38 mm
Height	62 mm	62 mm
Depth	21 mm	21 mm
Weights		
Weight, approx.	35 g	35 g

Ordering data**SB 1221 signal board digital input modules**

4 inputs, 5 V DC, 200 kHz, sourcing

6ES7221-3AD30-0XB0

4 inputs, 24 V DC, 200 kHz, sourcing

6ES7221-3BD30-0XB0**Article No.****Terminal block (spare part)**

For signal board

With 6 screws, gold-plated; 4 pcs.

6ES7292-1BF30-0XA0

Overview



- Digital outputs as supplement to the integral I/O of the CPUs
- For flexible adaptation of the controller to the relevant task
- For subsequent expansion of the system with additional outputs

Technical specifications

Article number	6ES7222-1BF32-0XB0	6ES7222-1BH32-0XB0	6ES7222-1HF32-0XB0	6ES7222-1HH32-0XB0	6ES7222-1XF32-0XB0
	DIGITAL OUTPUT SM1222, 8 DO, 24V DC	DIGITAL OUTPUT SM1222, 16 DO, 24V DC	DIGITAL OUTPUT SM 1222, 8 DO, RELAY	DIGITAL OUTPUT SM1222, 16 DO, RELAY	DIGITAL OUTPUT SM 1222, 8 DO, CHANGEOVER
General information					
Product type designation	SM 1222 DQ 8x24VDC	SM 1222 DQ 16x24VDC	SM 1222 DQ 8xRelay	SM 1222 DQ 16xRelay	SM 1222 DQ 8x relay changeover contact
Input current					
from backplane bus 5 V DC, max.	120 mA	140 mA	120 mA	135 mA	140 mA
Digital outputs					
• from load voltage L+, max.			11 mA/relay coil	11 mA/relay coil	16.7 mA/relay coil
Power loss					
Power loss, typ.	1.5 W	2.5 W	4.5 W	8.5 W	5 W
Digital outputs					
Number of digital outputs	8	16	8	16	8
• in groups of	1	1	2	1	1
Short-circuit protection	No; to be provided externally	No; to be provided externally	No; to be provided externally	No; to be provided externally	No; to be provided externally
Limitation of inductive shutdown voltage to	typ. (L+) -48 V	typ. (L+) -48 V			
Switching capacity of the outputs					
• with resistive load, max.	0.5 A	0.5 A	2 A	2 A	2 A
• on lamp load, max.	5 W	5 W	30 W with DC, 200 W with AC	30 W with DC, 200 W with AC	30 W with DC, 200 W with AC
Output voltage					
• Rated value (DC)	24 V	24 V	5 V DC to 30 V DC	5 V DC to 30 V DC	5 V DC to 30 V DC
• Rated value (AC)			5 V AC to 250 V AC	5 V AC to 250 V AC	5 V AC to 250 V AC
• for signal "0", max.	0.1 V; with 10 kOhm load	0.1 V; with 10 kOhm load			
• for signal "1", min.	20 V DC	20 V DC			
Output current					
• for signal "1" rated value	0.5 A	0.5 A			
• for signal "1" permissible range, max.			2 A	2 A	2 A
• for signal "0" residual current, max.	10 µA	10 µA			
Output delay with resistive load					
• "0" to "1", max.	50 µs	50 µs	10 ms	10 ms	10 ms
• "1" to "0", max.	200 µs	200 µs	10 ms	10 ms	10 ms
Total current of the outputs (per group)					
horizontal installation					
- up to 50 °C, max.	4 A; Current per mass	8 A; Current per mass	10 A; Current per mass	10 A; Current per mass	2 A; Current per mass

SIMATIC S7-1200 Basic Controllers

I/O modules

Digital modules

SM 1222 digital output modules

Technical specifications (continued)

Article number	6ES7222-1BF32-0XB0 DIGITAL OUTPUT SM1222, 8 DO, 24V DC	6ES7222-1BH32-0XB0 DIGITAL OUTPUT SM1222, 16 DO, 24V DC	6ES7222-1HF32-0XB0 DIGITAL OUTPUT SM 1222, 8 DO, RELAY	6ES7222-1HH32-0XB0 DIGITAL OUTPUT SM1222, 16 DO, RELAY	6ES7222-1XF32-0XB0 DIGITAL OUTPUT SM 1222, 8 DO, CHANGEOVER
Relay outputs					
• Number of relay outputs			8	16	8
• Rated supply voltage of relay coil L+ (DC)			24 V	24 V	24 V
• Number of operating cycles, max.			mechanically 10 million, at rated load voltage 100 000	mechanically 10 million, at rated load voltage 100 000	mechanically 10 million, at rated load voltage 100 000
Switching capacity of contacts					
- with inductive load, max.	0.5 A	0.5 A	2 A	2 A	2 A
- on lamp load, max.	5 W	5 W	30 W with DC, 200 W with AC	30 W with DC, 200 W with AC	30 W with DC, 200 W with AC
- with resistive load, max.	0.5 A	0.5 A	2 A	2 A	2 A
Cable length					
• shielded, max.	500 m	500 m	500 m	500 m	500 m
• unshielded, max.	150 m	150 m	150 m	150 m	150 m
Interrupts/diagnostics/ status information					
Alarms					
• Diagnostic alarm	Yes	Yes	Yes	Yes	Yes
Diagnostics indication LED					
• for status of the outputs	Yes	Yes	Yes	Yes	Yes
Potential separation					
Potential separation digital outputs					
• between the channels			Relays	Relays	Relays
• between the channels, in groups of	1	1	2	4	1
• between the channels and backplane bus	500 V AC	500 V AC	1500 V AC for 1 minute	1500 V AC for 1 minute	1500 V AC for 1 minute
Permissible potential difference					
between different circuits			750 V AC for 1 minute	750 V AC for 1 minute	750 V AC for 1 minute
Degree and class of protection					
Degree of protection acc. to EN 60529					
• IP20	Yes	Yes	Yes	Yes	Yes
Standards, approvals, certificates					
CE mark	Yes	Yes	Yes	Yes	Yes
CSA approval	Yes	Yes	Yes	Yes	Yes
cULus	Yes	Yes	Yes	Yes	Yes
FM approval	Yes	Yes	Yes	Yes	Yes
RCM (formerly C-TICK)	Yes	Yes	Yes	Yes	Yes
Marine approval					
• Marine approval	Yes	Yes	Yes	Yes	Yes
Ambient conditions					
Free fall					
• Fall height, max.	0.3 m; five times, in product package	0.3 m; five times, in product package	0.3 m; five times, in product package	0.3 m; five times, in product package	0.3 m; five times, in product package
Ambient temperature during operation					
• permissible temperature range	-20 °C to +60 °C horizontal mounting, -20 °C to 50 °C vertical mounting, 95% humidity, non-condensing	-20 °C to +60 °C horizontal mounting, -20 °C to 50 °C vertical mounting, 95% humidity, non-condensing	-20 °C to +60 °C horizontal mounting, -20 °C to 50 °C vertical mounting, 95% humidity, non-condensing	-20 °C to +60 °C horizontal mounting, -20 °C to 50 °C vertical mounting, 95% humidity, non-condensing	-20 °C to +60 °C horizontal mounting, -20 °C to 50 °C vertical mounting, 95% humidity, non-condensing
• min.	-20 °C	-20 °C	-20 °C	-20 °C	-20 °C
• max.	60 °C	60 °C	60 °C	60 °C; Number of simultaneously activated outputs: 8 (no adjacent points) at 60 °C horizontal or 50 °C vertical, 16 at 55 °C horizontal or 45 °C vertical	60 °C; Number of simultaneously activated outputs: 4 (no adjacent points) at 60 °C horizontal or 50 °C vertical, 8 at 55 °C horizontal or 45 °C vertical

Technical specifications (continued)

Article number	6ES7222-1BF32-0XB0	6ES7222-1BH32-0XB0	6ES7222-1HF32-0XB0	6ES7222-1HH32-0XB0	6ES7222-1XF32-0XB0
	DIGITAL OUTPUT SM1222, 8 DO, 24V DC	DIGITAL OUTPUT SM1222, 16 DO, 24V DC	DIGITAL OUTPUT SM 1222, 8 DO, RELAY	DIGITAL OUTPUT SM1222, 16 DO, RELAY	DIGITAL OUTPUT SM 1222, 8 DO, CHANGEOVER
Connection method					
required front connector	Yes	Yes	Yes	Yes	Yes
Mechanics/material					
Enclosure material (front)					
• Plastic	Yes	Yes	Yes	Yes	Yes
Dimensions					
Width	45 mm	45 mm	45 mm	45 mm	70 mm
Height	100 mm	100 mm	100 mm	100 mm	100 mm
Depth	75 mm	75 mm	75 mm	75 mm	75 mm
Weights					
Weight, approx.	180 g	220 g	190 g	260 g	310 g

Ordering data

SM 1222 digital output signal module

8 outputs, 24 V DC;
0.5 A, 5 W, isolated

16 outputs, 24 V DC;
0.5 A, 5 W, isolated

8 relay outputs,
5 ... 30 V DC / 5 ... 250 V AC, 2 A,
30 W DC / 200 W AC

8 relay outputs,
change-over contact,
5 ... 30 V DC / 5 ... 250 V AC, 2 A,
30 W DC / 200 W AC

16 relay outputs,
5 ... 30 V DC / 5 ... 250 V AC, 2 A,
30 W DC / 200 W AC

Extension cable for two-tier configuration

For connecting digital/analog
signal modules;
length 2 m

Article No.

6ES7222-1BF32-0XB0

6ES7222-1BH32-0XB0

6ES7222-1HF32-0XB0

6ES7222-1XF32-0XB0

6ES7222-1HH32-0XB0

6ES7290-6AA30-0XA0

Article No.

Terminal block (spare part)

For 6ES7222-1BF32-0XB0,
6ES7222-1BH32-0XB0

- With 7 screws, zinc-plated; 4 pcs.

For 6ES7222-1HF32-0XB0

- With 7 screws, tin-coated,
left coded; 4 units

For 6ES7222-1HH32-0XB0

- With 7 screws, tin-coated,
right coded; 4 units

For 6ES7222-1XF32-0XB0

- With 11 screws, tin-coated; 4 units

Front flap set (spare part)

For modules with a width of 45 mm

For modules with a width of 70 mm

6ES7292-1AG30-0XA0

6ES7292-1AG40-0XA1

6ES7292-1AG40-0XA0

6ES7292-1AL30-0XA0

6ES7291-1BA30-0XA0

6ES7291-1BB30-0XA0

SIMATIC S7-1200 Basic Controllers

I/O modules

Digital modules

SB 1222 digital output modules

Overview



- Digital outputs as a supplement to the integral I/O of SIMATIC S7-1200 CPUs
- Can be plugged directly into the CPU

Technical specifications

Article number	6ES7222-1AD30-0XB0	6ES7222-1BD30-0XB0
	SIGNAL BOARD SB1222, 4 DQ 5VDC 200KHZ	SIGNAL BOARD SB1222, 4 DQ 24VDC 200KHZ
General information		
Product type designation	SB 1222 4xDQ 5VDC 200kHz	SB 1222 4xDQ 24VDC 200kHz
Input current		
from backplane bus 5 V DC, typ.	35 mA	35 mA
Power loss		
Power loss, typ.	0.5 W	0.5 W
Digital outputs		
Number of digital outputs	4; MOSFET, solid-state (current-sinking/current-sourcing)	4; MOSFET, solid-state (current-sinking/current-sourcing)
• in groups of	4	4
Short-circuit protection	No	No
Switching capacity of the outputs		
• with resistive load, max.	0.1 A	0.1 A
Load resistance range		
• upper limit	7 Ω	11 Ω
Output voltage		
• Rated value (DC)	5 V	24 V
• for signal "0", max.	0.2 V	1 V; with 10 kOhm load
• for signal "1", min.	L+ minus 0.7 V DC	L+ (-1.5 V)
• for signal "1", max.	6 V	
Output current		
• for signal "1" rated value	0.1 A	0.1 A
• for signal "1" permissible range, max.	0.1 A	
Cable length		
• shielded, max.	50 m	50 m
Diagnostics indication LED		
• for status of the outputs	Yes	Yes
Degree and class of protection		
Degree of protection acc. to EN 60529		
• IP20	Yes	Yes

Technical specifications (continued)

Article number	6ES7222-1AD30-0XB0 SIGNAL BOARD SB1222, 4 DQ 5VDC 200KHZ	6ES7222-1BD30-0XB0 SIGNAL BOARD SB1222, 4 DQ 24VDC 200KHZ
Ambient conditions		
Free fall		
• Fall height, max.	0.3 m; five times, in product package	0.3 m; five times, in product package
Ambient temperature during operation		
• permissible temperature range	-20 °C to +60 °C horizontal mounting, -20 °C to 50 °C vertical mounting with 2 simultaneously activated, non-adjacent inputs; otherwise up to 55 °C with horizontal mounting or 45 °C with vertical mounting	-20 °C to +60 °C horizontal mounting, -20 °C to 50 °C vertical mounting
• min.	-20 °C	-20 °C
• max.	60 °C	60 °C
Mechanics/material		
Enclosure material (front)		
• Plastic	Yes	Yes
Dimensions		
Width	38 mm	38 mm
Height	62 mm	62 mm
Depth	21 mm	21 mm
Weights		
Weight, approx.	35 g	35 g

Ordering data**SB 1222 signal board
digital output modules**

4 outputs, 5 V DC, 0.1 A, 200 kHz
4 outputs, 24 V DC, 0.1 A, 200 kHz

Article No.

6ES7222-1AD30-0XB0
6ES7222-1BD30-0XB0

Article No.**Terminal block (spare part)**

For signal board
With 6 screws, gold-plated; 4 pcs.

6ES7292-1BF30-0XA0

SIMATIC S7-1200 Basic Controllers

I/O modules

Digital modules

SM 1223 digital input/output modules

Overview



- Digital inputs and outputs as supplement to the integral I/O of the CPUs
- For flexible adaptation of the controller to the relevant task
- For subsequent expansion of the system with additional inputs and outputs

Technical specifications

Article number	6ES7223-1BH32-0XB0	6ES7223-1BL32-0XB0	6ES7223-1PH32-0XB0	6ES7223-1PL32-0XB0	6ES7223-1QH32-0XB0
	DIGITAL I/O SM 1223, 8 DI / 8 DO	DIGITAL I/O SM 1223, 16DI/16DO	DIGITAL I/O SM 1223, 8DI/8DO	DIGITAL I/O SM 1223, 16DI/16DO	DIGITAL I/O SM 1223, 8DI AC/ 8DO RLY
General information					
Product type designation	SM 1223 DI 8x24 VDC, DQ 8x24 VDC	SM 1223 DI 16x24 VDC, DQ 16x24 VDC	SM 1223 DI 8x24 VDC, DQ 8xRelay	SM 1223 DI 16x24 VDC, DQ 16xRelay	120/230 V AC SM223 DIx8/DQx8 RLY
Supply voltage					
Rated value (DC)					
• 24 V DC	Yes	Yes	Yes	Yes	Yes
Input current					
from backplane bus 5 V DC, max.	145 mA	185 mA	145 mA	180 mA	120 mA
Digital inputs					
• from load voltage L+ (without load), max.	4 mA; per channel	4 mA; per channel	4 mA/input 11 mA/relay	4 mA/input 11 mA/relay	
Output voltage					
Power supply to the transmitters					
• present	Yes	Yes	Yes	Yes	Yes
Power loss					
Power loss, typ.	2.5 W	4.5 W	5.5 W	10 W	7.5 W
Digital inputs					
Number of digital inputs	8	16	8	16	8
• in groups of	2	2	2	2	4
Input characteristic curve in accordance with IEC 61131, type 1	Yes	Yes	Yes	Yes	Yes
Number of simultaneously controllable inputs					
all mounting positions					
- up to 40 °C, max.	8	16	8	16	8
horizontal installation					
- up to 40 °C, max.	8	16	8	16	8
- up to 50 °C, max.	8	16	8	16	8
vertical installation					
- up to 40 °C, max.	8	16	8	16	8
Input voltage					
• Type of input voltage	DC	DC	DC	DC	AC
• Rated value (DC)	24 V	24 V	24 V	24 V	
• Rated value (AC)					120/230V AC
• for signal *0*	5 V DC at 1 mA	5 V DC at 1 mA	5 V DC at 1 mA	5 V DC at 1 mA	20 V AC at 1 mA
• for signal *1*	15 V DC at 2.5 mA	15 V DC at 2.5 mA	15 V DC at 2.5 mA	15 V DC at 2.5 mA	79 V AC at 2.5 mA
Input current					
• for signal *0*, max. (permissible quiescent current)	1 mA	1 mA	1 mA	1 mA	1 mA
• for signal *1*, min.	2.5 mA	2.5 mA	2.5 mA	2.5 mA	2.5 mA
• for signal *1*, typ.	4 mA	4 mA	4 mA	4 mA	9 mA

Technical specifications (continued)

Article number	6ES7223-1BH32-0XB0 DIGITAL I/O SM 1223, 8 DI / 8 DO	6ES7223-1BL32-0XB0 DIGITAL I/O SM 1223, 16DI/16DO	6ES7223-1PH32-0XB0 DIGITAL I/O SM 1223, 8DI/8DO	6ES7223-1PL32-0XB0 DIGITAL I/O SM 1223, 16DI/16DO	6ES7223-1QH32-0XB0 DIGITAL I/O SM 1223, 8DI AC/ 8DO RLY
Input delay (for rated value of input voltage)					
for standard inputs					
- parameterizable	Yes; 0.2 ms, 0.4 ms, 0.8 ms, 1.6 ms, 3.2 ms, 6.4 ms and 12.8 ms, selectable in groups of four	Yes; 0.2 ms, 0.4 ms, 0.8 ms, 1.6 ms, 3.2 ms, 6.4 ms and 12.8 ms, selectable in groups of four	Yes; 0.2 ms, 0.4 ms, 0.8 ms, 1.6 ms, 3.2 ms, 6.4 ms and 12.8 ms, selectable in groups of four	Yes; 0.2 ms, 0.4 ms, 0.8 ms, 1.6 ms, 3.2 ms, 6.4 ms and 12.8 ms, selectable in groups of four	Yes; 0.2 ms, 0.4 ms, 0.8 ms, 1.6 ms, 3.2 ms, 6.4 ms and 12.8 ms, selectable in groups of four
for interrupt inputs					
- parameterizable	Yes	Yes	Yes	Yes	Yes
Cable length					
• shielded, max.	500 m	500 m	500 m	500 m	500 m
• unshielded, max.	300 m	300 m	300 m	300 m	300 m
Digital outputs					
Number of digital outputs	8	16	8	16	8
• in groups of	1	1	2	4	4
Short-circuit protection	No; to be provided externally	No; to be provided externally	No; to be provided externally	No; to be provided externally	No; to be provided externally
Limitation of inductive shutdown voltage to	L+ (-48 V)	L+ (-48 V)			
Switching capacity of the outputs					
• with resistive load, max.	0.5 A	0.5 A	2 A	2 A	2 A
• on lamp load, max.	5 W	5 W	30 W with DC, 200 W with AC	30 W with DC, 200 W with AC	30 W with DC, 200 W with AC
Output voltage					
• Rated value (DC)	24 V	24 V	5 V DC to 30 V DC	5 V DC to 30 V DC	5 V DC to 30 V DC
• Rated value (AC)			5 V AC to 250 V AC	5 V AC to 250 V AC	5 V AC to 250 V AC
• for signal "0", max.	0.1 V; with 10 kOhm load	0.1 V; with 10 kOhm load			
• for signal "1", min.	20 V DC	20 V DC			
Output current					
• for signal "1" rated value	0.5 A	0.5 A			
• for signal "1" permissible range, max.	0.5 A	0.5 A	2 A	2 A	2 A
• for signal "0" residual current, max.	10 µA	10 µA			
Output delay with resistive load					
• "0" to "1", max.	50 µs	50 µs	10 ms	10 ms	10 ms
• "1" to "0", max.	200 µs	200 µs	10 ms	10 ms	10 ms
Total current of the outputs (per group)					
horizontal installation					
- up to 50 °C, max.	4 A; Current per mass	8 A; Current per mass	10 A; Current per mass	8 A; Current per mass	8 A; Current per mass
Relay outputs					
• Number of relay outputs			8	16	8
• Rated supply voltage of relay coil L+ (DC)			24 V	24 V	24 V
• Number of operating cycles, max.			mechanically 10 million, at rated load voltage 100 000	mechanically 10 million, at rated load voltage 100 000	mechanically 10 million, at rated load voltage 100 000
Switching capacity of contacts					
- with inductive load, max.		0.5 A	2 A	2 A	2 A
- on lamp load, max.		5 W	30 W with DC, 200 W with AC	30 W with DC, 200 W with AC	30 W with DC, 200 W with AC
- with resistive load, max.		0.5 A	2 A	2 A	2 A
Cable length					
• shielded, max.	500 m	500 m	500 m	500 m	500 m
• unshielded, max.	150 m	150 m	150 m	150 m	150 m

SIMATIC S7-1200 Basic Controllers

I/O modules

Digital modules

SM 1223 digital input/output modules

Technical specifications (continued)

Article number	6ES7223-1BH32-0XB0 DIGITAL I/O SM 1223, 8 DI / 8 DO	6ES7223-1BL32-0XB0 DIGITAL I/O SM 1223, 16DI/16DO	6ES7223-1PH32-0XB0 DIGITAL I/O SM 1223, 8DI/8DO	6ES7223-1PL32-0XB0 DIGITAL I/O SM 1223, 16DI/16DO	6ES7223-1QH32-0XB0 DIGITAL I/O SM 1223, 8DI AC/ 8DO RLY
Interrupts/diagnostics/ status information					
Alarms					
• Diagnostic alarm	Yes	Yes	Yes	Yes	Yes
Diagnostics indication LED					
• for status of the inputs	Yes	Yes	Yes	Yes	Yes
• for status of the outputs	Yes	Yes	Yes	Yes	Yes
Potential separation					
Potential separation digital inputs					
• between the channels, in groups of	2	2	2	2	2
Potential separation digital outputs					
• between the channels			Relays	Relays	Relays
• between the channels, in groups of	1	1	2	4	2
• between the channels and backplane bus	500 V AC	500 V AC	1500 V AC for 1 minute	1500 V AC for 1 minute	1500 V AC for 1 minute
Permissible potential difference					
between different circuits			750 V AC for 1 minute	750 V AC for 1 minute	750 V AC for 1 minute
Degree and class of protection					
Degree of protection acc. to EN 60529					
• IP20	Yes	Yes	Yes	Yes	Yes
Standards, approvals, certificates					
CE mark	Yes	Yes	Yes	Yes	Yes
CSA approval	Yes	Yes	Yes	Yes	Yes
cULus	Yes	Yes	Yes	Yes	Yes
FM approval	Yes	Yes	Yes	Yes	Yes
RCM (formerly C-TICK)	Yes	Yes	Yes	Yes	Yes
Marine approval					
• Marine approval	Yes		Yes	Yes	Yes
Ambient conditions					
Free fall					
• Fall height, max.	0.3 m; five times, in product package	0.3 m; five times, in product package	0.3 m; five times, in product package	0.3 m; five times, in product package	0.3 m; five times, in product package
Ambient temperature during operation					
• permissible temperature range	-20 °C to +60 °C horizontal mounting, -20 °C to 50 °C vertical mounting, 95% humidity, non-condensing	-20 °C to +60 °C horizontal mounting, -20 °C to 50 °C vertical mounting, 95% humidity, non-condensing	-20 °C to +60 °C horizontal mounting, -20 °C to 50 °C vertical mounting, 95% humidity, non-condensing	-20 °C to +60 °C horizontal mounting, -20 °C to 50 °C vertical mounting, 95% humidity, non-condensing	-20 °C to +60 °C horizontal mounting, -20 °C to 50 °C vertical mounting, 95% humidity, non-condensing
• min.	-20 °C	-20 °C	-20 °C	-20 °C	-20 °C
• max.	60 °C	60 °C	60 °C	60 °C; Number of simultaneously activated outputs: 8 (no adjacent points) at 60 °C horizontal or 50 °C vertical, 16 at 55 °C horizontal or 45 °C vertical	60 °C; Number of simultaneously activated outputs: 4 (no adjacent points) at 60 °C horizontal or 50 °C vertical, 8 at 55 °C horizontal or 45 °C vertical
Connection method					
required front connector	Yes	Yes	Yes	Yes	Yes
Mechanics/material					
Enclosure material (front)					
• Plastic	Yes	Yes	Yes	Yes	Yes
Dimensions					
Width	45 mm	70 mm	45 mm	70 mm	45 mm
Height	100 mm	100 mm	100 mm	100 mm	100 mm
Depth	75 mm	75 mm	75 mm	75 mm	75 mm
Weights					
Weight, approx.	210 g	310 g	230 g	350 g	230 g

Ordering data	Article No.	Ordering data	Article No.
SM 1223 digital input/output signal module 8 inputs, 24 V DC, IEC type 1 current sinking; 8 24 V DC transistor outputs, 0.5 A, 5 W 16 inputs, 24 V DC, IEC type 1 current sinking; 16 24 V DC transistor outputs, 0.5 A, 5 W 8 inputs, 24 V DC, IEC type 1 current sinking; 8 relay outputs, 5 ... 30 V DC/5 ... 250 V AC, 2 A, 30 W DC/200 W AC 16 inputs, 24 V DC, IEC type 1 current sinking; 16 relay outputs, 5 ... 30 V DC/5 ... 250 V AC, 2 A, 30 W DC/200 W AC 8 inputs, 120/230 V AC; 8 relay outputs, 5 ... 30 V DC/5 ... 250 V AC, 2 A, 30 W DC/200 W AC	6ES7223-1BH32-0XB0 6ES7223-1BL32-0XB0 6ES7223-1PH32-0XB0 6ES7223-1PL32-0XB0 6ES7223-1QH32-0XB0	Terminal block (spare part) For 6ES7223-1BH32-0XB0 • With 7 screws, tin-coated; 4 units For 6ES7223-1BL32-0XB0 • With 11 screws, tin-coated; 4 units For 6ES7223-1PH32-0XB0 • With 7 screws, zinc-plated; 4 pcs. • With 7 screws, tin-coated, right coded; 4 units For 6ES7223-1PL32-0XB0 • With 11 screws, tin-coated; 4 units • With 11 screws, tin-coated, coded; 4 units For 6ES7223-1PL32-0XB0 • With 7 screws, tin-coated, right coded; 4 units Front flap set (spare part) For modules with a width of 45 mm For modules with a width of 70 mm	6ES7292-1AG30-0XA0 6ES7292-1AL30-0XA0 6ES7292-1AG30-0XA0 6ES7292-1AG40-0XA0 6ES7292-1AL30-0XA0 6ES7292-1AL40-0XA0 6ES7292-1AG40-0XA0 6ES7291-1BA30-0XA0 6ES7291-1BB30-0XA0
Extension cable for two-tier configuration For connecting digital/analog signal modules; length 2 m	6ES7290-6AA30-0XA0		

SIMATIC S7-1200 Basic Controllers

I/O modules

Digital modules

SB 1223 digital input/output modules

Overview



- Digital inputs and outputs as supplement to the integral I/O of the SIMATIC S7-1200 CPUs
- Can be plugged direct into the CPU

Technical specifications

Article number	6ES7223-0BD30-0XB0	6ES7223-3AD30-0XB0	6ES7223-3BD30-0XB0
	SIGNAL BOARD SB1223, 2 DI/2 DO	SIGNAL BOARD SB 1223, 2DI/2DQ 5V 200KHZ	SIGNAL BOARD SB 1223, 2DI/2DQ 24V 200KHZ
General information			
Product type designation	SB 1223 DI/2x24 VDC, DQ 2x24 VDC	SB 1223 2xDI / 2xDQ 5VDC 200kHz	SB 1223 2xDI / 2xDQ 24VDC 200kHz
Input current			
from backplane bus 5 V DC, typ.	50 mA	35 mA	35 mA
Output voltage			
Power supply to the transmitters			
• Supply current, max.	4 mA; per channel		
Power loss			
Power loss, typ.	1 W	0.5 W	0.5 W
Digital inputs			
Number of digital inputs	2; Current-sinking	2; Current-sourcing	2; Current-sourcing
• in groups of	1	2	2
Input characteristic curve in accordance with IEC 61131, type 1	Yes		
Number of simultaneously controllable inputs all mounting positions			
- up to 40 °C, max.	2		2
Input voltage			
• Type of input voltage	DC	DC	DC
• Rated value (DC)	24 V	5 V	24 V
• for signal "0"	0 to 5 V	(L+ minus 1.0 V DC) ... L+	(L+ minus 5.0 V DC) ... L+
• for signal "1"	+15 to +30V	0 V ... (L+ minus 2.0 V DC)	0 V ... (L+ minus 10 V DC)
Input current			
• for signal "0", max. (permissible quiescent current)	1 mA	2.2 mA	1.4 mA
• for signal "1", min.		5.1 mA	2.9 mA
• for signal "1", typ.	0.5 A		7 mA

Technical specifications (continued)

Article number	6ES7223-0BD30-0XB0 SIGNAL BOARD SB1223, 2 DI/2 DO	6ES7223-3AD30-0XB0 SIGNAL BOARD SB 1223, 2DI/2DQ 5V 200KHZ	6ES7223-3BD30-0XB0 SIGNAL BOARD SB 1223, 2DI/2DQ 24V 200KHZ
Input delay (for rated value of input voltage)			
for standard inputs			
- parameterizable	Yes; 0.2 ms, 0.4 ms, 0.8 ms, 1.6 ms, 3.2 ms, 6.4 ms and 12.8 ms, selectable in groups of four	Yes; 0.1 / 0.2 / 0.4 / 0.8 / 1.6 / 3.2 / 6.4 / 10.0 / 12.8 / 20.0 μ s; 0.05 / 0.1 / 0.2 / 0.4 / 0.8 / 1.6 / 3.2 / 6.4 / 10.0 / 12.8 / 20.0 ms	Yes; 0.1 / 0.2 / 0.4 / 0.8 / 1.6 / 3.2 / 6.4 / 10.0 / 12.8 / 20.0 μ s; 0.05 / 0.1 / 0.2 / 0.4 / 0.8 / 1.6 / 3.2 / 6.4 / 10.0 / 12.8 / 20.0 ms
- at "0" to "1", max.	2 μ s		
- at "1" to "0", max.	10 μ s		
for interrupt inputs			
- parameterizable	Yes	Yes	Yes
for counter/technological functions			
- parameterizable	Yes	Yes	Yes
Cable length			
• shielded, max.	500 m	50 m; shielded, twisted pair	50 m; shielded, twisted pair
• unshielded, max.	300 m		
Digital outputs			
Number of digital outputs	2; MOSFET, solid-state (current-sinking/current-sourcing)	2; MOSFET, solid-state (current-sinking/current-sourcing)	2; MOSFET, solid-state (current-sinking/current-sourcing)
• in groups of	1	2	2
Short-circuit protection	No	No	No
Switching capacity of the outputs			
• with resistive load, max.	0.5 A	0.1 A	0.1 A
• on lamp load, max.	5 W		
Load resistance range			
• upper limit	0.6 Ω	7 Ω	
Output voltage			
• Rated value (DC)	24 V	5 V	24 V
• for signal "0", max.	0.1 V; with 10 kOhm load	0.2 V	1 V
• for signal "1", min.	20 V	L+ minus 0.7 V DC	L+ (-1.5 V)
• for signal "1", max.		6 V	
Output current			
• for signal "1" rated value	0.5 A	0.1 A	0.1 A
• for signal "1" permissible range, max.		0.1 A	
• for signal "0" residual current, max.	10 μ A		
Cable length			
• shielded, max.	500 m	50 m	50 m
• unshielded, max.	150 m		
Interrupts/diagnostics/ status information			
Alarms	Yes		
Diagnostic functions	Yes		
Diagnostics indication LED			
• for status of the inputs	Yes	Yes	Yes
• for status of the outputs	Yes	Yes	Yes
Degree and class of protection			
Degree of protection acc. to EN 60529			
• IP20	Yes	Yes	Yes

SIMATIC S7-1200 Basic Controllers

I/O modules

Digital modules

SB 1223 digital input/output modules**Technical specifications** (continued)

Article number	6ES7223-0BD30-0XB0 SIGNAL BOARD SB1223, 2 DI/2 DO	6ES7223-3AD30-0XB0 SIGNAL BOARD SB 1223, 2DI/2DQ 5V 200KHZ	6ES7223-3BD30-0XB0 SIGNAL BOARD SB 1223, 2DI/2DQ 24V 200KHZ
Ambient conditions			
Free fall			
• Fall height, max.	0.3 m; five times, in product package	0.3 m; five times, in product package	0.3 m; five times, in product package
Ambient temperature during operation			
• permissible temperature range	-20 °C to +60 °C horizontal mounting, -20 °C to 50 °C vertical mounting	-20 °C to +60 °C horizontal mounting, -20 °C to 50 °C vertical mounting	-20 °C to +60 °C horizontal mounting, -20 °C to 50 °C vertical mounting
• min.	0 °C	-20 °C	-20 °C
• max.	55 °C	60 °C	60 °C
Mechanics/material			
Enclosure material (front)			
• Plastic	Yes	Yes	Yes
Dimensions			
Width	38 mm	38 mm	38 mm
Height	62 mm	62 mm	62 mm
Depth	21 mm	21 mm	21 mm
Weights			
Weight, approx.	40 g	35 g	35 g

Ordering data**SB 1223 digital input/output signal board**

2 inputs, 24 V DC,
IEC type 1 current sinking;
2 24 V DC transistor outputs,
0.5 A, 5 W; can be used as HSC at
up to 30 kHz

6ES7223-0BD30-0XB0

2 inputs, 5 V DC, 200 kHz
2 outputs 5 V DC, 0.1 A, 200 kHz

6ES7223-3AD30-0XB0

2 inputs, 24 V DC, 200 kHz
2 outputs 24 V DC, 0.1 A, 200 kHz

6ES7223-3BD30-0XB0**Article No.****Terminal block (spare part)**

For signal board
With 6 screws, gold-plated; 4 pcs.

6ES7292-1BF30-0XA0

Overview



- Digital inputs as supplement to the integral I/O of the CPUs
- For flexible adaptation of the controller to the corresponding task
- For subsequent expansion of the system with additional inputs
- From +60 °C to +70 °C, max. 50% of the inputs can be controlled simultaneously

Note:

SIPLUS extreme products are based on SIMATIC standard products. The contents listed here were taken from the respective standard products. SIPLUS extreme-specific information was added.

3

Technical specifications

Article number	6AG1221-1BF32-2XB0	6AG1221-1BF32-4XB0	6AG1221-1BH32-2XB0	6AG1221-1BH32-4XB0
Based on	6ES7221-1BF32-0XB0 SIPLUS S7-1200 SM 1221 8DI	6ES7221-1BF32-0XB0 SIPLUS S7-1200 SM 1221 8DI	6ES7221-1BH32-0XB0 SIPLUS S7-1200 SM 1221 16DI	6ES7221-1BH32-0XB0 SIPLUS S7-1200 SM 1221 16DI
Ambient conditions				
Free fall				
• Fall height, max.	0.3 m; five times, in product package	0.3 m; five times, in product package	0.3 m; five times, in product package	0.3 m; five times, in product package
Ambient temperature during operation				
• min.	-40 °C; = Tmin; Startup @ -25 °C	-20 °C; = Tmin; Startup @ 0 °C	-40 °C; = Tmin; Startup @ -25 °C	-20 °C; = Tmin; Startup @ 0 °C
• max.	70 °C; = Tmax; Tmax > +60 °C number of simultaneously activated inputs 4 (no adjacent points) for horizontal mounting position	60 °C; = Tmax	70 °C; = Tmax; Tmax > +60 °C number of simultaneously activated inputs 8 (no adjacent points) for horizontal mounting position	60 °C; = Tmax
Extended ambient conditions				
• relative to ambient temperature-atmospheric pressure-installation altitude	Tmin ... Tmax at 1080 hPa ... 795 hPa (-1000 m ... +2000 m) // Tmin ... (Tmax - 10K) at 795 hPa ... 658 hPa (+2000 m ... +3500 m) // Tmin ... (Tmax - 20K) at 658 hPa ... 540 hPa (+3500 m ... +5000 m)	Tmin ... Tmax at 1080 hPa ... 795 hPa (-1000 m ... +2000 m) // Tmin ... (Tmax - 10K) at 795 hPa ... 658 hPa (+2000 m ... +3500 m) // Tmin ... (Tmax - 20K) at 658 hPa ... 540 hPa (+3500 m ... +5000 m)	Tmin ... Tmax at 1080 hPa ... 795 hPa (-1000 m ... +2000 m) // Tmin ... (Tmax - 10K) at 795 hPa ... 658 hPa (+2000 m ... +3500 m) // Tmin ... (Tmax - 20K) at 658 hPa ... 540 hPa (+3500 m ... +5000 m)	Tmin ... Tmax at 1080 hPa ... 795 hPa (-1000 m ... +2000 m) // Tmin ... (Tmax - 10K) at 795 hPa ... 658 hPa (+2000 m ... +3500 m) // Tmin ... (Tmax - 20K) at 658 hPa ... 540 hPa (+3500 m ... +5000 m)
Relative humidity				
- With condensation, tested in accordance with IEC 60068-2-38, max.	100%; RH incl. condensation/frost (no commissioning under condensation conditions)	100%; RH incl. condensation/frost (no commissioning under condensation conditions)	100%; RH incl. condensation/frost (no commissioning under condensation conditions)	100%; RH incl. condensation/frost (no commissioning under condensation conditions)
Resistance				
- against biologically active substances / conformity with EN 60721-3-3	Yes; Class 3B2 mold, fungus and dry rot spores (with the exception of fauna). The supplied connector covers must remain on the unused interfaces during operation!	Yes; Class 3B2 mold, fungus and dry rot spores (with the exception of fauna). The supplied connector covers must remain on the unused interfaces during operation!	Yes; Class 3B2 mold, fungus and dry rot spores (with the exception of fauna). The supplied connector covers must remain on the unused interfaces during operation!	Yes; Class 3B2 mold, fungus and dry rot spores (with the exception of fauna). The supplied connector covers must remain on the unused interfaces during operation!
- against chemically active substances / conformity with EN 60721-3-3	Yes; Class 3C4 (RH < 75%) incl. salt spray according to EN 60068-2-52 (degree of severity 3). The supplied connector covers must remain on the unused interfaces during operation!	Yes; Class 3C4 (RH < 75%) incl. salt spray according to EN 60068-2-52 (degree of severity 3). The supplied connector covers must remain on the unused interfaces during operation!	Yes; Class 3C4 (RH < 75%) incl. salt spray according to EN 60068-2-52 (degree of severity 3). The supplied connector covers must remain on the unused interfaces during operation!	Yes; Class 3C4 (RH < 75%) incl. salt spray according to EN 60068-2-52 (degree of severity 3). The supplied connector covers must remain on the unused interfaces during operation!
- against mechanically active substances / conformity with EN 60721-3-3	Yes; Class 3S4 incl. sand, dust. The supplied connector covers must remain on the unused interfaces during operation!	Yes; Class 3S4 incl. sand, dust. The supplied connector covers must remain on the unused interfaces during operation!	Yes; Class 3S4 incl. sand, dust. The supplied connector covers must remain on the unused interfaces during operation!	Yes; Class 3S4 incl. sand, dust. The supplied connector covers must remain on the unused interfaces during operation!

SIMATIC S7-1200 Basic Controllers

I/O modules

SIPLUS digital modules

SIPLUS SM 1221 digital input modules**Ordering data****Article No.****Digital input SIPLUS
signal module SM 1221**

(Extended temperature range and exposure to media)

8 inputs, 24 V DC, isolated, current sourcing/sinking

- Suitable for areas with extraordinary medial exposure (conformal coating)
- -25 ... +70 °C, from +60 ... +70 °C number of simultaneously controllable inputs and outputs max. 50%

16 inputs, 24 V DC, isolated, current sourcing/sinking

- Suitable for areas with extraordinary medial exposure (conformal coating)
- -25 ... +70 °C, from +60 ... +70 °C number of simultaneously controllable inputs and outputs max. 50%

6AG1221-1BF32-4XB0**6AG1221-1BF32-2XB0****6AG1221-1BH32-4XB0****6AG1221-1BH32-2XB0****Article No.****Accessories**

See SIMATIC S7-1200 digital input SM 1221, page 3/50

3

Overview



- Digital inputs as a supplement to the integral I/O of SIMATIC S7-1200 CPUs
- Can be plugged directly into the CPU

Note:

SIPLUS extreme products are based on SIMATIC standard products. The contents listed here were adopted from the respective standard products. SIPLUS extreme specific information was added.

3

Technical specifications

Article number	6AG1221-3AD30-5XB0	6AG1221-3BD30-5XB0
Based on	6ES7221-3AD30-0XB0 SIPLUS S7-1200 SB 1221 4DI 5VDC	6ES7221-3BD30-0XB0 SIPLUS S7-1200 SB 1221 4DI 24VDC
Ambient conditions		
Ambient temperature during operation		
• min.	-40 °C; = Tmin; Startup @ -25 °C	-40 °C; = Tmin; Startup @ -25 °C
• max.	60 °C; = Tmax; Tmax > 55 °C number of simultaneously activated inputs 2 (no adjacent points) for horizontal mounting position	60 °C; = Tmax; Tmax > 55 °C number of simultaneously activated inputs 2 (no adjacent points) for horizontal mounting position
Extended ambient conditions		
• relative to ambient temperature-atmospheric pressure-installation altitude	Tmin ... Tmax at 1080 hPa ... 795 hPa (-1000 m ... +2000 m) // Tmin ... (Tmax - 10K) at 795 hPa ... 658 hPa (+2000 m ... +3500 m) // Tmin ... (Tmax - 20K) at 658 hPa ... 540 hPa (+3500 m ... +5000 m)	Tmin ... Tmax at 1080 hPa ... 795 hPa (-1000 m ... +2000 m) // Tmin ... (Tmax - 10K) at 795 hPa ... 658 hPa (+2000 m ... +3500 m) // Tmin ... (Tmax - 20K) at 658 hPa ... 540 hPa (+3500 m ... +5000 m)
Relative humidity		
- With condensation, tested in accordance with IEC 60068-2-38, max.	100%; RH incl. condensation / frost (no commissioning in bedewed state), horizontal installation	100%; RH incl. condensation / frost (no commissioning in bedewed state), horizontal installation
Resistance		
- against biologically active substances / conformity with EN 60721-3-3	Yes; Class 3B2 mold, fungus and dry rot spores (with the exception of fauna). The supplied connector covers must remain on the unused interfaces during operation!	Yes; Class 3B2 mold, fungus and dry rot spores (with the exception of fauna). The supplied connector covers must remain on the unused interfaces during operation!
- against chemically active substances / conformity with EN 60721-3-3	Yes; Class 3C4 (RH < 75%) incl. salt spray according to EN 60068-2-52 (degree of severity 3). The supplied connector covers must remain on the unused interfaces during operation!	Yes; Class 3C4 (RH < 75%) incl. salt spray according to EN 60068-2-52 (degree of severity 3). The supplied connector covers must remain on the unused interfaces during operation!
- against mechanically active substances / conformity with EN 60721-3-3	Yes; Class 3S4 incl. sand, dust. The supplied connector covers must remain on the unused interfaces during operation!	Yes; Class 3S4 incl. sand, dust. The supplied connector covers must remain on the unused interfaces during operation!

Ordering data

SIPLUS SB 1221 digital input signal board

(Extended temperature range and exposure to media)

4 inputs, 5 V DC, 200 kHz, sourcing

4 inputs, 24 V DC, 200 kHz, sourcing

Article No.

6AG1221-3AD30-5XB0

6AG1221-3BD30-5XB0

Article No.

Accessories

See SIMATIC S7-1200 digital input SB 1221, page 3/52

SIMATIC S7-1200 Basic Controllers

I/O modules

SIPLUS digital modules

SIPLUS SM 1222 digital output modules

Overview



- Digital outputs as a supplement to the integral I/O of the CPUs
- For flexible adaptation of the controller to the corresponding task
- For subsequent expansion of the system with additional outputs
- From +60 °C to +70 °C, max. 50% of the inputs can be controlled simultaneously

Note:

SIPLUS extreme products are based on SIMATIC standard products. The contents listed here were taken from the respective standard products. SIPLUS extreme-specific information was added.

Technical specifications

Article number	6AG1222-1BF32-2XB0	6AG1222-1BF32-4XB0	6AG1222-1BH32-2XB0	6AG1222-1BH32-4XB0
Based on	6ES7222-1BF32-0XB0 SIPLUS S7-1200 SM 1222 8DQ	6ES7222-1BF32-0XB0 SIPLUS S7-1200 SM 1222 8DQ	6ES7222-1BH32-0XB0 SIPLUS S7-1200 SM 1222 16DQ	6ES7222-1BH32-0XB0 SIPLUS S7-1200 SM 1222 16DQ
Ambient conditions				
Free fall				
• Fall height, max.	0.3 m; five times, in product package	0.3 m; five times, in product package	0.3 m; five times, in product package	0.3 m; five times, in product package
Ambient temperature during operation				
• min.	-40 °C; = Tmin; Startup @ -25 °C	-20 °C; = Tmin; Startup @ 0 °C	-40 °C; = Tmin; Startup @ -25 °C	-20 °C; = Tmin; Startup @ 0 °C
• max.	70 °C; = Tmax; Tmax > +60 °C number of simultaneously activated outputs 4 (no adjacent points) for horizontal mounting position	60 °C; = Tmax	70 °C; = Tmax; Tmax > +60 °C number of simultaneously activated outputs 8 (no adjacent points) for horizontal mounting position	60 °C; = Tmax
Extended ambient conditions				
• relative to ambient temperature-atmospheric pressure-installation altitude	Tmin ... Tmax at 1080 hPa ... 795 hPa (-1000 m ... +2000 m) // Tmin ... (Tmax - 10K) at 795 hPa ... 658 hPa (+2000 m ... +3500 m) // Tmin ... (Tmax - 20K) at 658 hPa ... 540 hPa (+3500 m ... +5000 m)	Tmin ... Tmax at 1080 hPa ... 795 hPa (-1000 m ... +2000 m) // Tmin ... (Tmax - 10K) at 795 hPa ... 658 hPa (+2000 m ... +3500 m) // Tmin ... (Tmax - 20K) at 658 hPa ... 540 hPa (+3500 m ... +5000 m)	Tmin ... Tmax at 1080 hPa ... 795 hPa (-1000 m ... +2000 m) // Tmin ... (Tmax - 10K) at 795 hPa ... 658 hPa (+2000 m ... +3500 m) // Tmin ... (Tmax - 20K) at 658 hPa ... 540 hPa (+3500 m ... +5000 m)	Tmin ... Tmax at 1080 hPa ... 795 hPa (-1000 m ... +2000 m) // Tmin ... (Tmax - 10K) at 795 hPa ... 658 hPa (+2000 m ... +3500 m) // Tmin ... (Tmax - 20K) at 658 hPa ... 540 hPa (+3500 m ... +5000 m)
Relative humidity				
- With condensation, tested in accordance with IEC 60068-2-38, max.	100%; RH incl. condensation/frost (no commissioning under condensation conditions)	100%; RH incl. condensation/frost (no commissioning under condensation conditions)	100%; RH incl. condensation/frost (no commissioning under condensation conditions)	100%; RH incl. condensation/frost (no commissioning under condensation conditions)
Resistance				
- against biologically active substances / conformity with EN 60721-3-3	Yes; Class 3B2 mold, fungus and dry rot spores (with the exception of fauna). The supplied connector covers must remain on the unused interfaces during operation!	Yes; Class 3B2 mold, fungus and dry rot spores (with the exception of fauna). The supplied connector covers must remain on the unused interfaces during operation!	Yes; Class 3B2 mold, fungus and dry rot spores (with the exception of fauna). The supplied connector covers must remain on the unused interfaces during operation!	Yes; Class 3B2 mold, fungus and dry rot spores (with the exception of fauna). The supplied connector covers must remain on the unused interfaces during operation!
- against chemically active substances / conformity with EN 60721-3-3	Yes; Class 3C4 (RH < 75%) incl. salt spray according to EN 60068-2-52 (degree of severity 3). The supplied connector covers must remain on the unused interfaces during operation!	Yes; Class 3C4 (RH < 75%) incl. salt spray according to EN 60068-2-52 (degree of severity 3). The supplied connector covers must remain on the unused interfaces during operation!	Yes; Class 3C4 (RH < 75%) incl. salt spray according to EN 60068-2-52 (degree of severity 3). The supplied connector covers must remain on the unused interfaces during operation!	Yes; Class 3C4 (RH < 75%) incl. salt spray according to EN 60068-2-52 (degree of severity 3). The supplied connector covers must remain on the unused interfaces during operation!
- against mechanically active substances / conformity with EN 60721-3-3	Yes; Class 3S4 incl. sand, dust. The supplied connector covers must remain on the unused interfaces during operation!	Yes; Class 3S4 incl. sand, dust. The supplied connector covers must remain on the unused interfaces during operation!	Yes; Class 3S4 incl. sand, dust. The supplied connector covers must remain on the unused interfaces during operation!	Yes; Class 3S4 incl. sand, dust. The supplied connector covers must remain on the unused interfaces during operation!

Technical specifications (continued)

Article number	6AG1222-1HF32-2XB0	6AG1222-1HF32-4XB0	6AG1222-1HH32-2XB0	6AG1222-1HH32-4XB0
Based on	6ES7222-1HF32-0XB0 SIPLUS S7-1200 SM 1222 8DQ RLY	6ES7222-1HF32-0XB0 SIPLUS S7-1200 SM 1222 8DQ RLY	6ES7222-1HH32-0XB0 SIPLUS S7-1200 SM 1222 16DQ RLY	6ES7222-1HH32-0XB0 SIPLUS S7-1200 SM 1222 16DQ RLY
Ambient conditions				
Free fall				
• Fall height, max.	0.3 m; five times, in product package	0.3 m; five times, in product package	0.3 m; five times, in product package	0.3 m; five times, in product package
Ambient temperature during operation				
• min.	-40 °C; = Tmin; Startup @ -25 °C	-20 °C; = Tmin; Startup @ 0 °C	-40 °C; = Tmin; Startup @ -25 °C	-20 °C; = Tmin; Startup @ 0 °C
• max.	70 °C; = Tmax; Tmax > +60 °C number of simultaneously activated outputs 4 (no adjacent points) for horizontal mounting position	60 °C; = Tmax	70 °C; = Tmax; Tmax > +60 °C number of simultaneously activated outputs 8 (no adjacent points) for horizontal mounting position	60 °C; = Tmax
Extended ambient conditions				
• relative to ambient temperature-atmospheric pressure-installation altitude	Tmin ... Tmax at 1 080 hPa ... 795 hPa (-1 000 m ... +2 000 m) // Tmin ... (Tmax - 10 K) at 795 hPa ... 658 hPa (+2 000 m ... +3 500 m) // Tmin ... (Tmax - 20 K) at 658 hPa ... 540 hPa (+3 500 m ... +5 000 m); from 2 000 m max. 132 V AC	Tmin ... Tmax at 1 080 hPa ... 795 hPa (-1 000 m ... +2 000 m) // Tmin ... (Tmax - 10 K) at 795 hPa ... 658 hPa (+2 000 m ... +3 500 m) // Tmin ... (Tmax - 20 K) at 658 hPa ... 540 hPa (+3 500 m ... +5 000 m); from 2 000 m max. 132 V AC	Tmin ... Tmax at 1080 hPa ... 795 hPa (-1000 m ... +2000 m) // Tmin ... (Tmax - 10K) at 795 hPa ... 658 hPa (+2000 m ... +3500 m) // Tmin ... (Tmax - 20K) at 658 hPa ... 540 hPa (+3500 m ... +5000 m)	Tmin ... Tmax at 1080 hPa ... 795 hPa (-1000 m ... +2000 m) // Tmin ... (Tmax - 10K) at 795 hPa ... 658 hPa (+2000 m ... +3500 m) // Tmin ... (Tmax - 20K) at 658 hPa ... 540 hPa (+3500 m ... +5000 m)
• At cold restart, min.	-25 °C			
Relative humidity				
- With condensation, tested in accordance with IEC 60068-2-38, max.	100%; RH incl. condensation/frost (no commissioning under condensation conditions)	100%; RH incl. condensation/frost (no commissioning under condensation conditions)	100%; RH incl. condensation/frost (no commissioning under condensation conditions)	100%; RH incl. condensation/frost (no commissioning under condensation conditions)
Resistance				
- against biologically active substances / conformity with EN 60721-3-3	Yes; Class 3B2 mold, fungus and dry rot spores (with the exception of fauna). The supplied connector covers must remain on the unused interfaces during operation!	Yes; Class 3B2 mold, fungus and dry rot spores (with the exception of fauna). The supplied connector covers must remain on the unused interfaces during operation!	Yes; Class 3B2 mold, fungus and dry rot spores (with the exception of fauna). The supplied connector covers must remain on the unused interfaces during operation!	Yes; Class 3B2 mold, fungus and dry rot spores (with the exception of fauna). The supplied connector covers must remain on the unused interfaces during operation!
- against chemically active substances / conformity with EN 60721-3-3	Yes; Class 3C4 (RH < 75%) incl. salt spray according to EN 60068-2-52 (degree of severity 3). The supplied connector covers must remain on the unused interfaces during operation!	Yes; Class 3C4 (RH < 75%) incl. salt spray according to EN 60068-2-52 (degree of severity 3). The supplied connector covers must remain on the unused interfaces during operation!	Yes; Class 3C4 (RH < 75%) incl. salt spray according to EN 60068-2-52 (degree of severity 3). The supplied connector covers must remain on the unused interfaces during operation!	Yes; Class 3C4 (RH < 75%) incl. salt spray according to EN 60068-2-52 (degree of severity 3). The supplied connector covers must remain on the unused interfaces during operation!
- against mechanically active substances / conformity with EN 60721-3-3	Yes; Class 3S4 incl. sand, dust. The supplied connector covers must remain on the unused interfaces during operation!	Yes; Class 3S4 incl. sand, dust. The supplied connector covers must remain on the unused interfaces during operation!	Yes; Class 3S4 incl. sand, dust. The supplied connector covers must remain on the unused interfaces during operation!	Yes; Class 3S4 incl. sand, dust. The supplied connector covers must remain on the unused interfaces during operation!

SIMATIC S7-1200 Basic Controllers

I/O modules

SIPLUS digital modules

SIPLUS SM 1222 digital output modules**Ordering data****Article No.****Article No.****Digital output SIPLUS
signal module SM 1222**

(Extended temperature range and exposure to media)

8 outputs, 24 V DC;
0.5 A, 5 W, isolated

- Suitable for areas with extraordinary medial exposure (conformal coating)
- -25 ... +70 °C, from +60 ... +70 °C number of simultaneously controllable inputs and outputs max. 50%

16 outputs, 24 V DC;
0.5 A, 5 W, isolated

- Suitable for areas with extraordinary medial exposure (conformal coating)
- -25 ... +70 °C, from +60 ... +70 °C number of simultaneously controllable inputs and outputs max. 50%

8 outputs,
5 ... 30 V DC/5 ... 250 V AC,
relay 2 A, 30 W DC/200 W AC

- Suitable for areas with extraordinary medial exposure (conformal coating)
- -25 ... +70 °C, from +60 ... +70 °C number of simultaneously controllable inputs and outputs max. 50%

16 outputs,
5 ... 30 V DC/5 ... 250 V AC,
relay 2 A, 30 W DC/200 W AC

- Suitable for areas with extraordinary medial exposure (conformal coating)
- -25 ... +70 °C, from +60 ... +70 °C number of simultaneously controllable inputs and outputs max. 50%

6AG1222-1BF32-4XB0**6AG1222-1BF32-2XB0****6AG1222-1BH32-4XB0****6AG1222-1BH32-2XB0****6AG1222-1HF32-4XB0****6AG1222-1HF32-2XB0****6AG1222-1HH32-4XB0****6AG1222-1HH32-2XB0****Accessories**

See SIMATIC S7-1200 digital output SM 1222, page 3/55

Overview



- Digital outputs as a supplement to the integral I/O of the CPUs
- For flexible adaptation of the controller to the respective task
- For subsequent expansion of the system with additional outputs
- Can be plugged directly into the CPU
- From +60 °C to +70 °C, max. 50% of the inputs can be controlled simultaneously

Note:

SIPLUS extreme products are based on SIMATIC standard products. The contents listed here were taken from the respective standard products. SIPLUS extreme specific information was added.

3

Technical specifications

Article number	6AG1222-1AD30-5XB0	6AG1222-1BD30-5XB0
Based on	6ES7222-1AD30-0XB0 SIPLUS S7-1200 SB 1222 4DQ 5VDC	6ES7222-1BD30-0XB0 SIPLUS S7-1200 SB 1222 4DQ 24VDC
Ambient temperature during operation		
• min.	-40 °C; = Tmin; Startup @ -25 °C	-40 °C; = Tmin; Startup @ -25 °C
• max.	60 °C; = Tmax; Tmax > 55 °C number of simultaneously activated outputs 2 (no adjacent points) for horizontal mounting position	60 °C; = Tmax; Tmax > 55 °C number of simultaneously activated outputs 2 (no adjacent points) for horizontal mounting position
Extended ambient conditions		
• relative to ambient temperature-atmospheric pressure-installation altitude	Tmin ... Tmax at 1080 hPa ... 795 hPa (-1000 m ... +2000 m) // Tmin ... (Tmax - 10K) at 795 hPa ... 658 hPa (+2000 m ... +3500 m) // Tmin ... (Tmax - 20K) at 658 hPa ... 540 hPa (+3500 m ... +5000 m)	Tmin ... Tmax at 1080 hPa ... 795 hPa (-1000 m ... +2000 m) // Tmin ... (Tmax - 10K) at 795 hPa ... 658 hPa (+2000 m ... +3500 m) // Tmin ... (Tmax - 20K) at 658 hPa ... 540 hPa (+3500 m ... +5000 m)
Relative humidity		
- With condensation, tested in accordance with IEC 60068-2-38, max.	100%; RH incl. condensation / frost (no commissioning in bedewed state), horizontal installation	100%; RH incl. condensation / frost (no commissioning in bedewed state), horizontal installation
Resistance		
- against biologically active substances / conformity with EN 60721-3-3	Yes; Class 3B2 mold, fungus and dry rot spores (with the exception of fauna). The supplied connector covers must remain on the unused interfaces during operation!	Yes; Class 3B2 mold, fungus and dry rot spores (with the exception of fauna). The supplied connector covers must remain on the unused interfaces during operation!
- against chemically active substances / conformity with EN 60721-3-3	Yes; Class 3C4 (RH < 75%) incl. salt spray according to EN 60068-2-52 (degree of severity 3). The supplied connector covers must remain on the unused interfaces during operation!	Yes; Class 3C4 (RH < 75%) incl. salt spray according to EN 60068-2-52 (degree of severity 3). The supplied connector covers must remain on the unused interfaces during operation!
- against mechanically active substances / conformity with EN 60721-3-3	Yes; Class 3S4 incl. sand, dust. The supplied connector covers must remain on the unused interfaces during operation!	Yes; Class 3S4 incl. sand, dust. The supplied connector covers must remain on the unused interfaces during operation!

Ordering data

SIPLUS SB 1222 digital output signal board

(Extended temperature range and exposure to media)

- 4 outputs, 5 V DC, 0.1 A, 200 kHz
4 outputs, 24 V DC, 0.1 A, 200 kHz

Article No.

6AG1222-1AD30-5XB0

6AG1222-1BD30-5XB0

Article No.

Accessories

See SIMATIC S7-1200 digital output module SB 1222, page 3/57

SIMATIC S7-1200 Basic Controllers

I/O modules

SIPLUS digital modules

SIPLUS SM 1223 digital input/output modules

Overview



- Digital inputs and outputs as supplement to the integral I/O of the CPUs
- For flexible adaptation of the controller to the corresponding task
- For subsequent expansion of the system with additional inputs and outputs
- From +60 °C to +70 °C, max. 50% of the inputs can be controlled simultaneously

Note:

SIPLUS extreme products are based on SIMATIC standard products. The contents listed here were taken from the respective standard products. SIPLUS extreme-specific information was added.

Technical specifications

Article number	6AG1223-1BH32-2XB0	6AG1223-1BH32-4XB0	6AG1223-1PH32-2XB0	6AG1223-1PH32-4XB0
Based on	6ES7223-1BH32-0XB0 SIPLUS S7-1200 SM 1223 8DI/8DQ	6ES7223-1BH32-0XB0 SIPLUS S7-1200 SM 1223 8DI/8DQ	6ES7223-1PH32-0XB0 SIPLUS S7-1200 SM 1223 8DI/8DQ RLY	6ES7223-1PH32-0XB0 SIPLUS S7-1200 SM 1223 8DI/8DQ RLY
Ambient conditions				
Free fall				
• Fall height, max.	0.3 m; five times, in product package	0.3 m; five times, in product package	0.3 m; five times, in product package	0.3 m; five times, in product package
Ambient temperature during operation				
• min.	-40 °C; = Tmin; Startup @ -25 °C	-20 °C; = Tmin; Startup @ 0 °C	-40 °C; = Tmin; Startup @ -25 °C	-20 °C; = Tmin; Startup @ 0 °C
• max.	70 °C; = Tmax; Tmax > +60 °C number of simultaneously activated outputs 4, inputs 4 (no adjacent points) for horizontal mounting position	60 °C; = Tmax	70 °C; = Tmax; Tmax > +60 °C number of simultaneously activated outputs 4, inputs 4 (no adjacent points) for horizontal mounting position	60 °C; = Tmax
Extended ambient conditions				
• relative to ambient temperature-atmospheric pressure-installation altitude	Tmin ... Tmax at 1080 hPa ... 795 hPa (-1000 m ... +2000 m) // Tmin ... (Tmax - 10K) at 795 hPa ... 658 hPa (+2000 m ... +3500 m) // Tmin ... (Tmax - 20K) at 658 hPa ... 540 hPa (+3500 m ... +5000 m)	Tmin ... Tmax at 1080 hPa ... 795 hPa (-1000 m ... +2000 m) // Tmin ... (Tmax - 10K) at 795 hPa ... 658 hPa (+2000 m ... +3500 m) // Tmin ... (Tmax - 20K) at 658 hPa ... 540 hPa (+3500 m ... +5000 m)	Tmin ... Tmax at 1080 hPa ... 795 hPa (-1000 m ... +2000 m) // Tmin ... (Tmax - 10K) at 795 hPa ... 658 hPa (+2000 m ... +3500 m) // Tmin ... (Tmax - 20K) at 658 hPa ... 540 hPa (+3500 m ... +5000 m)	Tmin ... Tmax at 1080 hPa ... 795 hPa (-1000 m ... +2000 m) // Tmin ... (Tmax - 10K) at 795 hPa ... 658 hPa (+2000 m ... +3500 m) // Tmin ... (Tmax - 20K) at 658 hPa ... 540 hPa (+3500 m ... +5000 m)
• At cold restart, min.	-25 °C			
Relative humidity				
- With condensation, tested in accordance with IEC 60068-2-38, max.	100%; RH incl. condensation/frost (no commissioning under condensation conditions)	100%; RH incl. condensation/frost (no commissioning under condensation conditions)	100%; RH incl. condensation/frost (no commissioning under condensation conditions)	100%; RH incl. condensation/frost (no commissioning under condensation conditions)
Resistance				
- against biologically active substances / conformity with EN 60721-3-3	Yes; Class 3B2 mold, fungus and dry rot spores (with the exception of fauna). The supplied connector covers must remain on the unused interfaces during operation!	Yes; Class 3B2 mold, fungus and dry rot spores (with the exception of fauna). The supplied connector covers must remain on the unused interfaces during operation!	Yes; Class 3B2 mold, fungus and dry rot spores (with the exception of fauna). The supplied connector covers must remain on the unused interfaces during operation!	Yes; Class 3B2 mold, fungus and dry rot spores (with the exception of fauna). The supplied connector covers must remain on the unused interfaces during operation!
- against chemically active substances / conformity with EN 60721-3-3	Yes; Class 3C4 (RH < 75%) incl. salt spray according to EN 60068-2-52 (degree of severity 3). The supplied connector covers must remain on the unused interfaces during operation!	Yes; Class 3C4 (RH < 75%) incl. salt spray according to EN 60068-2-52 (degree of severity 3). The supplied connector covers must remain on the unused interfaces during operation!	Yes; Class 3C4 (RH < 75%) incl. salt spray according to EN 60068-2-52 (degree of severity 3). The supplied connector covers must remain on the unused interfaces during operation!	Yes; Class 3C4 (RH < 75%) incl. salt spray according to EN 60068-2-52 (degree of severity 3). The supplied connector covers must remain on the unused interfaces during operation!
- against mechanically active substances / conformity with EN 60721-3-3	Yes; Class 3S4 incl. sand, dust. The supplied connector covers must remain on the unused interfaces during operation!	Yes; Class 3S4 incl. sand, dust. The supplied connector covers must remain on the unused interfaces during operation!	Yes; Class 3S4 incl. sand, dust. The supplied connector covers must remain on the unused interfaces during operation!	Yes; Class 3S4 incl. sand, dust. The supplied connector covers must remain on the unused interfaces during operation!

Technical specifications (continued)

Article number	6AG1223-1PL32-2XB0	6AG1223-1PL32-4XB0	6AG1223-1BL32-2XB0	6AG1223-1BL32-4XB0
Based on	6ES7223-1PL32-0XB0 SIPLUS S7-1200 SM 1223 16DI/16DQ RLY	6ES7223-1PL32-0XB0 SIPLUS S7-1200 SM 1223 16DI/16DQ RLY	6ES7223-1BL32-0XB0 SIPLUS S7-1200 SM 1223 16DI/16DQ	6ES7223-1BL32-0XB0 SIPLUS S7-1200 SM 1223 16DI/16DQ
Ambient conditions				
Free fall				
• Fall height, max.	0.3 m; five times, in product package	0.3 m; five times, in product package	0.3 m; five times, in product package	0.3 m; five times, in product package
Ambient temperature during operation				
• min.	-40 °C; = Tmin; Startup @ -25 °C	-20 °C; = Tmin; Startup @ 0 °C	-40 °C; = Tmin; Startup @ -25 °C	-20 °C; = Tmin; Startup @ 0 °C
• max.	70 °C; = Tmax; Tmax > +60 °C number of simultaneously activated outputs 8, inputs 8 (no adjacent points) for horizontal mounting position	60 °C; = Tmax	70 °C; = Tmax; Tmax > +60 °C number of simultaneously activated outputs 8, inputs 8 (no adjacent points) for horizontal mounting position	60 °C; = Tmax
Extended ambient conditions				
• relative to ambient temperature-atmospheric pressure-installation altitude	Tmin ... Tmax at 1080 hPa ... 795 hPa (-1000 m ... +2000 m) // Tmin ... (Tmax - 10K) at 795 hPa ... 658 hPa (+2000 m ... +3500 m) // Tmin ... (Tmax - 20K) at 658 hPa ... 540 hPa (+3500 m ... +5000 m)	Tmin ... Tmax at 1080 hPa ... 795 hPa (-1000 m ... +2000 m) // Tmin ... (Tmax - 10K) at 795 hPa ... 658 hPa (+2000 m ... +3500 m) // Tmin ... (Tmax - 20K) at 658 hPa ... 540 hPa (+3500 m ... +5000 m)	Tmin ... Tmax at 1080 hPa ... 795 hPa (-1000 m ... +2000 m) // Tmin ... (Tmax - 10K) at 795 hPa ... 658 hPa (+2000 m ... +3500 m) // Tmin ... (Tmax - 20K) at 658 hPa ... 540 hPa (+3500 m ... +5000 m)	Tmin ... Tmax at 1080 hPa ... 795 hPa (-1000 m ... +2000 m) // Tmin ... (Tmax - 10K) at 795 hPa ... 658 hPa (+2000 m ... +3500 m) // Tmin ... (Tmax - 20K) at 658 hPa ... 540 hPa (+3500 m ... +5000 m)
Relative humidity				
- With condensation, tested in accordance with IEC 60068-2-38, max.	100%; RH incl. condensation/frost (no commissioning under condensation conditions)	100%; RH incl. condensation/frost (no commissioning under condensation conditions)	100%; RH incl. condensation/frost (no commissioning under condensation conditions)	100%; RH incl. condensation/frost (no commissioning under condensation conditions)
Resistance				
- against biologically active substances / conformity with EN 60721-3-3	Yes; Class 3B2 mold, fungus and dry rot spores (with the exception of fauna). The supplied connector covers must remain on the unused interfaces during operation!	Yes; Class 3B2 mold, fungus and dry rot spores (with the exception of fauna). The supplied connector covers must remain on the unused interfaces during operation!	Yes; Class 3B2 mold, fungus and dry rot spores (with the exception of fauna). The supplied connector covers must remain on the unused interfaces during operation!	Yes; Class 3B2 mold, fungus and dry rot spores (with the exception of fauna). The supplied connector covers must remain on the unused interfaces during operation!
- against chemically active substances / conformity with EN 60721-3-3	Yes; Class 3C4 (RH < 75%) incl. salt spray according to EN 60068-2-52 (degree of severity 3). The supplied connector covers must remain on the unused interfaces during operation!	Yes; Class 3C4 (RH < 75%) incl. salt spray according to EN 60068-2-52 (degree of severity 3). The supplied connector covers must remain on the unused interfaces during operation!	Yes; Class 3C4 (RH < 75%) incl. salt spray according to EN 60068-2-52 (degree of severity 3). The supplied connector covers must remain on the unused interfaces during operation!	Yes; Class 3C4 (RH < 75%) incl. salt spray according to EN 60068-2-52 (degree of severity 3). The supplied connector covers must remain on the unused interfaces during operation!
- against mechanically active substances / conformity with EN 60721-3-3	Yes; Class 3S4 incl. sand, dust. The supplied connector covers must remain on the unused interfaces during operation!	Yes; Class 3S4 incl. sand, dust. The supplied connector covers must remain on the unused interfaces during operation!	Yes; Class 3S4 incl. sand, dust. The supplied connector covers must remain on the unused interfaces during operation!	Yes; Class 3S4 incl. sand, dust. The supplied connector covers must remain on the unused interfaces during operation!

SIMATIC S7-1200 Basic Controllers

I/O modules

SIPLUS digital modules

SIPLUS SM 1223 digital input/output modules**Ordering data****Article No.****Article No.****Digital input/output
SIPLUS signal module SM 1223**

(Extended temperature range and exposure to media)

8 inputs, 24 V DC,
IEC type 1 current sinking
8 transistor outputs,
24 V DC, 0.5 A, 5 W

- Suitable for areas with extraordinary medial exposure (conformal coating)
- -25 ... +70 °C, from +60 ... +70 °C number of simultaneously controllable inputs and outputs max. 50%

6AG1223-1BH32-4XB0**6AG1223-1BH32-2XB0**16 inputs, 24 V DC,
IEC type 1 current sinking
16 transistor outputs,
24 V DC, 0.5 A, 5 W

- Suitable for areas with extraordinary medial exposure (conformal coating)
- -25 ... +70 °C, from +60 ... +70 °C number of simultaneously controllable inputs and outputs max. 50%

6AG1223-1BL32-4XB0**6AG1223-1BL32-2XB0**8 inputs, 24 V DC,
IEC type 1 current sinking
8 relay outputs,
5 ... 30 V DC / 5 ... 250 V AC, 2 A,
30 W DC / 200 W AC

- Suitable for areas with extraordinary medial exposure (conformal coating)
- -25 ... +70 °C, from +60 ... +70 °C number of simultaneously controllable inputs and outputs max. 50%

6AG1223-1PH32-4XB0**6AG1223-1PH32-2XB0**16 inputs, 24 V DC,
IEC type 1 current sinking
16 relay outputs,
5 ... 30 V DC / 5 ... 250 V AC, 2 A,
30 W DC / 200 W AC

- Suitable for areas with extraordinary medial exposure (conformal coating)
- -25 ... +70 °C, from +60 ... +70 °C number of simultaneously controllable inputs and outputs max. 50%

6AG1223-1PL32-4XB0**6AG1223-1PL32-2XB0****Accessories**

See SIMATIC S7-1200 digital input/output SM 1223, page 3/61

Overview



- Digital inputs and outputs as supplement to the integral I/O of the SIPLUS S7-1200-CPU's
- Can be plugged directly into the CPU (cannot be used for +70 °C version)

Note:

SIPLUS extreme products are based on SIMATIC standard products. The contents listed here were taken from the respective standard products. SIPLUS extreme-specific information was added.

3

Technical specifications

Article number	6AG1223-0BD30-4XB0	6AG1223-0BD30-5XB0	6AG1223-3AD30-5XB0	6AG1223-3BD30-5XB0
Based on	6ES7223-0BD30-0XB0 SIPLUS S7-1200 SB 1223 2DI/2DQ 24VDC	6ES7223-0BD30-0XB0 SIPLUS S7-1200 SB 1223 2DI/2DQ 24VDC	6ES7223-3AD30-0XB0 SIPLUS S7-1200 SB 1223 2DI/2DQ 5VDC	6ES7223-3BD30-0XB0 SIPLUS S7-1200 SB 1223 2DI/2DQ, 24VDC
Ambient conditions				
Free fall				
• Fall height, max.	0.3 m; five times, in product package			
Ambient temperature during operation				
• min.	0 °C; = Tmin	-40 °C; = Tmin; Startup @ -25 °C	-40 °C; = Tmin; Startup @ -25 °C	-40 °C; = Tmin; Startup @ -25 °C
• max.	55 °C; = Tmax	60 °C; = Tmax	60 °C; = Tmax	60 °C; = Tmax
Extended ambient conditions				
• relative to ambient temperature-atmospheric pressure-installation altitude	Tmin ... Tmax at 1080 hPa ... 795 hPa (-1000 m ... +2000 m) // Tmin ... (Tmax - 10K) at 795 hPa ... 658 hPa (+2000 m ... +3500 m) // Tmin ... (Tmax - 20K) at 658 hPa ... 540 hPa (+3500 m ... +5000 m)	Tmin ... Tmax at 1080 hPa ... 795 hPa (-1000 m ... +2000 m) // Tmin ... (Tmax - 10K) at 795 hPa ... 658 hPa (+2000 m ... +3500 m) // Tmin ... (Tmax - 20K) at 658 hPa ... 540 hPa (+3500 m ... +5000 m)	Tmin ... Tmax at 1080 hPa ... 795 hPa (-1000 m ... +2000 m) // Tmin ... (Tmax - 10K) at 795 hPa ... 658 hPa (+2000 m ... +3500 m) // Tmin ... (Tmax - 20K) at 658 hPa ... 540 hPa (+3500 m ... +5000 m)	Tmin ... Tmax at 1080 hPa ... 795 hPa (-1000 m ... +2000 m) // Tmin ... (Tmax - 10K) at 795 hPa ... 658 hPa (+2000 m ... +3500 m) // Tmin ... (Tmax - 20K) at 658 hPa ... 540 hPa (+3500 m ... +5000 m)
Relative humidity				
- With condensation, tested in accordance with IEC 60068-2-38, max.	100%; Relative humidity, incl. condensation / frost permitted (no commissioning under condensation conditions)	100%; RH incl. condensation / frost (no commissioning in bedewed state), horizontal installation	100%; RH incl. condensation / frost (no commissioning in bedewed state), horizontal installation	100%; RH incl. condensation / frost (no commissioning in bedewed state), horizontal installation
Resistance				
- against biologically active substances / conformity with EN 60721-3-3	Yes; Class 3B2 mold, fungus and dry rot spores (with the exception of fauna). The supplied connector covers must remain on the unused interfaces during operation!	Yes; Class 3B2 mold, fungus and dry rot spores (with the exception of fauna). The supplied connector covers must remain on the unused interfaces during operation!	Yes; Class 3B2 mold, fungus and dry rot spores (with the exception of fauna). The supplied connector covers must remain on the unused interfaces during operation!	Yes; Class 3B2 mold, fungus and dry rot spores (with the exception of fauna). The supplied connector covers must remain on the unused interfaces during operation!
- against chemically active substances / conformity with EN 60721-3-3	Yes; Class 3C4 incl. salt spray according to EN 60068-2-52 (degree of severity 3). The supplied connector covers must remain on the unused interfaces during operation!	Yes; Class 3C4 (RH < 75%) incl. salt spray according to EN 60068-2-52 (degree of severity 3). The supplied connector covers must remain on the unused interfaces during operation!	Yes; Class 3C4 (RH < 75%) incl. salt spray according to EN 60068-2-52 (degree of severity 3). The supplied connector covers must remain on the unused interfaces during operation!	Yes; Class 3C4 (RH < 75%) incl. salt spray according to EN 60068-2-52 (degree of severity 3). The supplied connector covers must remain on the unused interfaces during operation!
- against mechanically active substances / conformity with EN 60721-3-3	Yes; Class 3S4 incl. sand, dust. The supplied connector covers must remain on the unused interfaces during operation!	Yes; Class 3S4 incl. sand, dust. The supplied connector covers must remain on the unused interfaces during operation!	Yes; Class 3S4 incl. sand, dust. The supplied connector covers must remain on the unused interfaces during operation!	Yes; Class 3S4 incl. sand, dust. The supplied connector covers must remain on the unused interfaces during operation!

SIMATIC S7-1200 Basic Controllers

I/O modules

SIPLUS digital modules

SIPLUS SB 1223 digital input/output modules**Ordering data****Article No.****Digital input/output
SIPLUS signal board SB 1223**

(Extended temperature range and exposure to media)

2 inputs, 24 V DC,
IEC type 1 current sinking;
2 transistor outputs
24 V DC, 0.5 A, 5 W;
can be used as HSC at up to
30 kHz

- Suitable for areas with extreme medial exposure (conformal coating)
- Ambient temperature -25 ... +55 °C

2 inputs, 5 V DC, 200 kHz
2 outputs 5 V DC, 0.1 A, 200 kHz

2 inputs, 24 V DC, 200 kHz
2 outputs 24 V DC, 0.1 A, 200 kHz

6AG1223-0BD30-4XB0**6AG1223-0BD30-5XB0****6AG1223-3AD30-5XB0****6AG1223-3BD30-5XB0****Accessories****Article No.**

See SIMATIC S7-1200
digital input/output SB 1223,
page 3/64

Overview



- Analog inputs for SIMATIC S7-1200
- With extremely short conversion times
- For connecting analog sensors without additional amplifiers
- For solving even more complex automation tasks

Technical specifications

Article number	6ES7231-4HD32-0XB0 ANALOG INPUT SM 1231, 4AI	6ES7231-4HF32-0XB0 ANALOG INPUT SM 1231, 8AI	6ES7231-5ND32-0XB0 ANALOG INPUT SM 1231, 4AI 16BIT
General information			
Product type designation	SM 1231 AI 4x13 bit	SM 1231 AI 8 x 13 bit	SM 1231 AI 4 x 16 bit
Supply voltage			
Rated value (DC)			
• 24 V DC	Yes	Yes	Yes
Input current			
Current consumption, typ.	45 mA	45 mA	65 mA
from backplane bus 5 V DC, typ.	80 mA	90 mA	80 mA
Power loss			
Power loss, typ.	1.5 W	1.5 W	1.8 W
Analog inputs			
Number of analog inputs	4; Current or voltage differential inputs	8; Current or voltage differential inputs	4; Current or voltage differential inputs
permissible input voltage for current input (destruction limit), max.	±35 V	±35 V	±15 V
permissible input voltage for voltage input (destruction limit), max.	35 V	35 V	±35 V
permissible input current for voltage input (destruction limit), max.	40 mA	40 mA	40 mA; limited by input resistance 1 MOhm
permissible input current for current input (destruction limit), max.	40 mA	40 mA	40 mA
Cycle time (all channels) max.	625 µs	625 µs	100 µs
Input ranges			
• Voltage	Yes; ±10V, ±5V, ±2.5V	Yes; ±10V, ±5V, ±2.5V	Yes; ±10V, ±5V, ±2.5V or ±1.25V
• Current	Yes; 4 to 20 mA, 0 to 20 mA	Yes; 4 to 20 mA, 0 to 20 mA	Yes; 4 to 20 mA, 0 to 20 mA
• Thermocouple	No	No	No
• Resistance thermometer	No	No	No
• Resistance	No	Yes	No
Input ranges (rated values), voltages			
• -1.25 V to +1.25 V			Yes
• -10 V to +10 V	Yes	Yes	Yes
• -2.5 V to +2.5 V	Yes	Yes	Yes
• -5 V to +5 V	Yes	Yes	Yes
Input ranges (rated values), currents			
• 0 to 20 mA	Yes	Yes	Yes
• 4 mA to 20 mA	Yes	Yes	Yes
Thermocouple (TC)			
Temperature compensation			
- parameterizable		No	

SIMATIC S7-1200 Basic Controllers

I/O modules

Analog modules

SM 1231 analog input modules

Technical specifications (continued)

Article number	6ES7231-4HD32-0XB0 ANALOG INPUT SM 1231, 4AI	6ES7231-4HF32-0XB0 ANALOG INPUT SM 1231, 8AI	6ES7231-5ND32-0XB0 ANALOG INPUT SM 1231, 4AI 16BIT
Analog value generation for the inputs			
Integration and conversion time/ resolution per channel			
• Resolution with overrange (bit including sign), max.	12 bit; + sign	12 bit; + sign	15 bit; + sign
• Integration time, parameterizable	Yes	Yes	Yes
• Interference voltage suppression for interference frequency f_1 in Hz	40 dB, DC to 60 V for interference frequency 50 / 60 Hz	40 dB, DC to 60 V for interference frequency 50 / 60 Hz	40 dB, DC to 60 V for interference frequency 50 / 60 Hz
Smoothing of measured values			
• parameterizable	Yes	Yes	Yes
• Step: None	Yes	Yes	Yes
• Step: low	Yes	Yes	Yes
• Step: Medium	Yes	Yes	Yes
• Step: High	Yes	Yes	Yes
Errors/accuracies			
Temperature error (relative to input range), (+/-)	25 °C ±0.1%, to 55 °C ±0.2% total measurement range	25 °C ±0.1%, to 55 °C ±0.2% total measurement range	25 °C ±0.1% / ±0.3% total measurement range
Basic error limit (operational limit at 25 °C)			
• Voltage, relative to input range, (+/-)	0.1%	0.1%	0.1%
• Current, relative to input range, (+/-)	0.1%	0.1%	0.1%
Interference voltage suppression for $f = n \times (f_1 \pm 1\%)$, $f_1 =$ interference frequency			
• Common mode voltage, max.	12 V	12 V	12 V
Interrupts/diagnostics/ status information			
Alarms	Yes	Yes	Yes
Diagnostic functions	Yes	Yes	Yes
Alarms			
• Diagnostic alarm	Yes	Yes	Yes
Diagnostic messages			
• Monitoring the supply voltage	Yes	Yes	Yes
• Wire-break	Yes	Yes	Yes
Diagnostics indication LED			
• for status of the inputs	Yes	Yes	Yes
• for maintenance	Yes	Yes	Yes
Degree and class of protection			
Degree of protection acc. to EN 60529			
• IP20	Yes	Yes	Yes
Standards, approvals, certificates			
CE mark	Yes	Yes	Yes
CSA approval	Yes	Yes	Yes
FM approval	Yes	Yes	Yes
RCM (formerly C-TICK)	Yes	Yes	Yes
Marine approval			
• Marine approval	Yes	Yes	Yes

Technical specifications (continued)

Article number	6ES7231-4HD32-0XB0	6ES7231-4HF32-0XB0	6ES7231-5ND32-0XB0
	ANALOG INPUT SM 1231, 4AI	ANALOG INPUT SM 1231, 8AI	ANALOG INPUT SM 1231, 4AI 16BIT
Ambient conditions			
Free fall			
• Fall height, max.	0.3 m; five times, in product package	0.3 m; five times, in product package	0.3 m; five times, in product package
Ambient temperature during operation			
• permissible temperature range	-20 °C to +60 °C horizontal mounting, -20 °C to 50 °C vertical mounting, 95% humidity, non-condensing	-20 °C to +60 °C horizontal mounting, -20 °C to 50 °C vertical mounting, 95% humidity, non-condensing	-20 °C to +60 °C horizontal mounting, -20 °C to 50 °C vertical mounting, 95% humidity, non-condensing
• min.	-20 °C	-20 °C	-20 °C
• max.	60 °C	60 °C	60 °C
Pollutant concentrations			
- SO ₂ at RH < 60% without condensation	SO ₂ : < 0.5 ppm; H ₂ S: < 0.1 ppm; RH < 60% condensation-free	SO ₂ : < 0.5 ppm; H ₂ S: < 0.1 ppm; RH < 60% condensation-free	SO ₂ : < 0.5 ppm; H ₂ S: < 0.1 ppm; RH < 60% condensation-free
Connection method			
required front connector	Yes	Yes	Yes
Mechanics/material			
Enclosure material (front)			
• Plastic	Yes	Yes	Yes
Dimensions			
Width	45 mm	45 mm	45 mm
Height	100 mm	100 mm	100 mm
Depth	75 mm	75 mm	75 mm
Weights			
Weight, approx.	180 g	180 g	180 g

Ordering data

SM 1231 analog input signal module

4 analog inputs,
±10V, ±5V, ±2.5V, or
0 ... 20 mA, 16 bits

4 analog inputs,
±10V, ±5V, ±2.5V, or
0 ... 20 mA, 12 bits + sign

8 analog inputs,
±10V, ±5V, ±2.5V, or
0 ... 20 mA, 12 bits + sign

Article No.

6ES7231-5ND32-0XB0

6ES7231-4HD32-0XB0

6ES7231-4HF32-0XB0

Article No.

Extension cable for two-tier configuration

For connecting digital/analog
signal modules;
length 2 m

Terminal block (spare part)

For 6ES7231-5ND32-0XB0,
6ES7231-4HD32-0XB0,
6ES7231-4HF32-0XB0

- With 7 screws, gold-plated; 4 pcs.

Front flap set (spare part)

For modules with a width of 45 mm

6ES7290-6AA30-0XA0

6ES7292-1BG30-0XA0

6ES7291-1BA30-0XA0

SIMATIC S7-1200 Basic Controllers

I/O modules

Analog modules

SB 1231 analog input modules

Overview

- Analog input module for the SIMATIC S7-1200
- With extremely short conversion times
- For the connection of analog sensors without additional amplifiers
- For the solution of more complex automation tasks as well
- Can be plugged directly into the CPU

Technical specifications

Article number	6ES7231-4HA30-0XB0 SIGNAL BOARD SB 1231, 1 AI
General information	
Product type designation	SB1231 AI 1x12 BIT
Supply voltage	
Rated value (DC)	
• 24 V DC	Yes
Input current	
from backplane bus 5 V DC, typ.	55 mA
Power loss	
Power loss, typ.	0.4 W
Analog inputs	
Number of analog inputs	1; Current or voltage differential inputs
permissible input voltage for current input (destruction limit), max.	±35 V
permissible input voltage for voltage input (destruction limit), max.	35 V
permissible input current for voltage input (destruction limit), max.	40 mA
permissible input current for current input (destruction limit), max.	40 mA
Cycle time (all channels) max.	156.25 µs; 400 Hz suppression
Input ranges	
• Voltage	Yes; ±10V, ±5V, ±2.5V
• Current	Yes; 0 to 20 mA
• Thermocouple	No
• Resistance thermometer	No
• Resistance	No
Input ranges (rated values), voltages	
• -10 V to +10 V	Yes
• -2.5 V to +2.5 V	Yes
• -5 V to +5 V	Yes
Input ranges (rated values), currents	
• 0 to 20 mA	Yes
Analog outputs	
Number of analog outputs	0

Article number	6ES7231-4HA30-0XB0 SIGNAL BOARD SB 1231, 1 AI
Analog value generation for the inputs	
Measurement principle	integrating
Integration and conversion time/ resolution per channel	
• Resolution with overrange (bit including sign), max.	11 bit; + sign
• Integration time, parameterizable	Yes
• Interference voltage suppression for interference frequency f1 in Hz	40 dB, DC to 60 Hz
Smoothing of measured values	
• parameterizable	Yes
• Step: None	Yes
• Step: low	Yes
• Step: Medium	Yes
• Step: High	Yes
Errors/accuracies	
Temperature error (relative to input range), (+/-)	25 °C ±0.3%, to 55 °C ±0.6% total measurement range
Interrupts/diagnostics/ status information	
Alarms	Yes
Diagnostic functions	Yes
Alarms	
• Diagnostic alarm	Yes
Diagnostic messages	
• Wire-break	No
Diagnostics indication LED	
• for status of the inputs	Yes
• for maintenance	Yes
Degree and class of protection	
Degree of protection acc. to EN 60529	
• IP20	Yes
Standards, approvals, certificates	
CE mark	Yes
CSA approval	Yes
FM approval	Yes
RCM (formerly C-TICK)	Yes

Technical specifications (continued)

Article number	6ES7231-4HA30-0XB0 SIGNAL BOARD SB 1231, 1 AI
Ambient conditions	
Free fall	
• Fall height, max.	0.3 m; five times, in product package
Ambient temperature during operation	
• permissible temperature range	-20 °C to +60 °C horizontal mounting, -20 °C to 50 °C vertical mounting, 95% humidity, non-condensing
• min.	-20 °C
• max.	60 °C
Pollutant concentrations	
- SO ₂ at RH < 60% without condensation	SO ₂ : < 0.5 ppm; H ₂ S: < 0.1 ppm; RH < 60% condensation-free
Connection method	
required front connector	Yes
Mechanics/material	
Enclosure material (front)	
• Plastic	Yes
Dimensions	
Width	38 mm
Height	62 mm
Depth	21 mm
Weights	
Weight, approx.	35 g

Ordering data**Article No.****SB 1231 signal board analog input module**

1 analog input,
±10 V with 12 bits or
0 ... 20 mA with 11 bits

6ES7231-4HA30-0XB0**Terminal block (spare part)**

For signal board
With 6 screws, gold-plated; 4 pcs.

6ES7292-1BF30-0XA0

SIMATIC S7-1200 Basic Controllers

I/O modules

Analog modules

SM 1232 analog output modules

Overview



- Analog outputs for SIMATIC S7-1200
- With extremely short conversion times
- For connecting analog actuators without additional amplifiers
- For solving even more complex automation tasks

3

Technical specifications

Article number	6ES7232-4HB32-0XB0 ANALOG OUTPUT SM 1232, 2AO	6ES7232-4HD32-0XB0 ANALOG OUTPUT SM 1232, 4AO
General information		
Product type designation	SM 1232 AQ 2x14 bit	SM 1232 AQ 4 x 14bit
Supply voltage		
Rated value (DC)		
• 24 V DC	Yes	Yes
Input current		
Current consumption, typ.	45 mA	45 mA
from backplane bus 5 V DC, typ.	80 mA	80 mA
Power loss		
Power loss, typ.	1.5 W	1.5 W
Analog outputs		
Number of analog outputs	2; Current or voltage	4; Current or voltage
Output ranges, voltage		
• -10 V to +10 V	Yes	Yes
Output ranges, current		
• 0 to 20 mA	Yes	Yes
Load impedance (in rated range of output)		
• with voltage outputs, min.	1 000 Ω	1 000 Ω
• with current outputs, max.	600 Ω	600 Ω
Analog value generation for the outputs		
Integration and conversion time/ resolution per channel		
• Resolution (incl. overrange)	Voltage: 14 bits; Current : 13 bits	Voltage: 14 bits; Current : 13 bits
Errors/accuracies		
Temperature error (relative to output range), (+/-)	25 °C ±0.3%, to 55 °C ±0.6% total measurement range	25 °C ±0.3%, to 55 °C ±0.6% total measurement range
Basic error limit (operational limit at 25 °C)		
• Voltage, relative to output range, (+/-)	0.3%	0.3%
• Current, relative to output range, (+/-)	0.3%	0.3%
Interference voltage suppression for f = n x (f1 +/- 1%), f1 = interference frequency		
• Common mode voltage, max.	12 V	12 V

Technical specifications (continued)

Article number	6ES7232-4HB32-0XB0 ANALOG OUTPUT SM 1232, 2AO	6ES7232-4HD32-0XB0 ANALOG OUTPUT SM 1232, 4AO
Interrupts/diagnostics/ status information		
Alarms	Yes	Yes
Diagnostic functions	Yes	Yes
Alarms		
• Diagnostic alarm	Yes	Yes
Diagnostic messages		
• Monitoring the supply voltage	Yes	Yes
• Wire-break	Yes	Yes
• Short-circuit	Yes	Yes
Diagnostics indication LED		
• for status of the outputs	Yes	Yes
• for maintenance	Yes	Yes
Degree and class of protection		
Degree of protection acc. to EN 60529		
• IP20	Yes	Yes
Standards, approvals, certificates		
CE mark	Yes	Yes
CSA approval	Yes	Yes
FM approval	Yes	Yes
RCM (formerly C-TICK)	Yes	Yes
Ambient conditions		
Free fall		
• Fall height, max.	0.3 m; five times, in product package	0.3 m; five times, in product package
Ambient temperature during operation		
• permissible temperature range	-20 °C to +60 °C horizontal mounting, -20 °C to 50 °C vertical mounting, 95% humidity, non-condensing	-20 °C to +60 °C horizontal mounting, -20 °C to 50 °C vertical mounting, 95% humidity, non-condensing
• min.	-20 °C	-20 °C
• max.	60 °C	60 °C
Pollutant concentrations		
- SO ₂ at RH < 60% without condensation	SO ₂ : < 0.5 ppm; H ₂ S: < 0.1 ppm; RH < 60% condensation-free	SO ₂ : < 0.5 ppm; H ₂ S: < 0.1 ppm; RH < 60% condensation-free
Connection method		
required front connector	Yes	Yes
Mechanics/material		
Enclosure material (front)		
• Plastic	Yes	Yes
Dimensions		
Width	45 mm	45 mm
Height	100 mm	100 mm
Depth	75 mm	75 mm
Weights		
Weight, approx.	180 g	180 g

SIMATIC S7-1200 Basic Controllers

I/O modules

Analog modules

SM 1232 analog output modules**Ordering data****Article No.****Article No.****SM 1232 analog output signal module**2 analog outputs,
±10 V with 14 bits or
0 ... 20 mA with 13 bits**6ES7232-4HB32-0XB0**4 analog outputs,
±10 V with 14 bits or
0 ... 20 mA with 13 bits**6ES7232-4HD32-0XB0****Terminal block (spare part)**For 6ES7232-4HB32-0XB0,
6ES7232-4HD32-0XB0

With 7 screws, gold-plated; 4 units

6ES7292-1BG30-0XA0**Extension cable for two-tier configuration**For connecting digital/analog
signal modules;
length 2 m**6ES7290-6AA30-0XA0****Front flap set (spare part)**

For modules with a width of 45 mm

6ES7291-1BA30-0XA0

3

Overview



- Analog output for the SIMATIC S7-1200
- Can be plugged direct into the CPU

Technical specifications

Article number	6ES7232-4HA30-0XB0 SIGNAL BOARD SB 1232, 1 AO
General information	
Product type designation	SB 1232 1x AO
Input current	
from backplane bus 5 V DC, typ.	15 mA
Output voltage	
Power supply to the transmitters	
• Supply current, max.	25 mA
Power loss	
Power loss, typ.	1.5 W
Analog inputs	
Number of analog inputs	0
Analog outputs	
Number of analog outputs	1
Cycle time (all channels) max.	Voltage: 300 μ S (R), 750 μ S (1 μ F) Current: 600 ms (1 mH); 2 ms (10 mH)
Output ranges, voltage	
• -10 V to +10 V	Yes
Output ranges, current	
• 0 to 20 mA	Yes
Load impedance (in rated range of output)	
• with voltage outputs, min.	1 000 Ω
• with current outputs, max.	600 Ω
Cable length	
• shielded, max.	10 m; shielded, twisted pair

Article number	6ES7232-4HA30-0XB0 SIGNAL BOARD SB 1232, 1 AO
Errors/accuracies	
Temperature error (relative to output range), (+/-)	25 °C \pm 0.5%, to 55 °C \pm 1%
Interrupts/diagnostics/status information	
Alarms	Yes
Diagnostic functions	Yes
Diagnostics indication LED	
• for status of the outputs	Yes
Degree and class of protection	
Degree of protection acc. to EN 60529	
• IP20	Yes
Standards, approvals, certificates	
CE mark	Yes
CSA approval	Yes
FM approval	Yes
RCM (formerly C-TICK)	Yes

SIMATIC S7-1200 Basic Controllers

I/O modules

Analog modules

SB 1232 analog output modules**Technical specifications** (continued)

Article number	6ES7232-4HA30-0XB0 SIGNAL BOARD SB 1232, 1 AO
Ambient conditions	
Free fall	
• Fall height, max.	0.3 m; five times, in product package
Ambient temperature during operation	
• permissible temperature range	0 °C to 55 °C horizontal installation, 0 °C to 45 °C vertical installation
• min.	0 °C
• max.	55 °C
Pollutant concentrations	
- SO ₂ at RH < 60% without condensation	SO ₂ : < 0.5 ppm; H ₂ S: < 0.1 ppm; RH < 60% condensation-free
Mechanics/material	
Enclosure material (front)	
• Plastic	Yes
Dimensions	
Width	38 mm
Height	62 mm
Depth	21 mm
Weights	
Weight, approx.	40 g

Ordering data**Article No.****SB 1232 analog output signal board**

1 analog output,
±10 V with 12 bits or
0 ... 20 mA with 11 bits

6ES7232-4HA30-0XB0**Terminal block (spare part)**

For signal board
With 6 screws, gold-plated; 4 pcs.

6ES7292-1BF30-0XA0

3

Overview



- Analog inputs and outputs for the SIMATIC S7-1200
- With extremely short conversion times
- For connecting analog actuators and sensors without additional amplifiers
- For solving even more complex automation tasks

3

Technical specifications

Article number	6ES7234-4HE32-0XB0 ANALOG I/O SM 1234, 4AI/2AO
General information	
Product type designation	SM 1234 A I4x13 bit AQ 2x14 bit
Supply voltage	
Rated value (DC)	
• 24 V DC	Yes
Input current	
Current consumption, typ.	60 mA
from backplane bus 5 V DC, typ.	80 mA
Power loss	
Power loss, typ.	2 W
Analog inputs	
Number of analog inputs	4; Current or voltage differential inputs
permissible input voltage for current input (destruction limit), max.	±35 V
permissible input voltage for voltage input (destruction limit), max.	35 V
permissible input current for voltage input (destruction limit), max.	40 mA
permissible input current for current input (destruction limit), max.	40 mA
Cycle time (all channels) max.	625 µs
Input ranges	
• Voltage	Yes; ±10V, ±5V, ±2.5V
• Current	Yes; 4 to 20 mA, 0 to 20 mA
Input ranges (rated values), voltages	
• -10 V to +10 V	Yes
• -2.5 V to +2.5 V	Yes
• -5 V to +5 V	Yes
Input ranges (rated values), currents	
• 0 to 20 mA	Yes
• 4 mA to 20 mA	Yes

Article number	6ES7234-4HE32-0XB0 ANALOG I/O SM 1234, 4AI/2AO
Analog outputs	
Number of analog outputs	2; Current or voltage
Output ranges, voltage	
• -10 V to +10 V	Yes
Output ranges, current	
• 0 to 20 mA	Yes
• 4 mA to 20 mA	Yes
Load impedance (in rated range of output)	
• with voltage outputs, min.	1 000 Ω
• with current outputs, max.	600 Ω
Analog value generation for the inputs	
Measurement principle	Differential
Integration and conversion time/ resolution per channel	
• Resolution with overrange (bit including sign), max.	12 bit; + sign
• Integration time, parameterizable	Yes
• Interference voltage suppression for interference frequency f1 in Hz	40 dB, DC to 60 V for interference frequency 50 / 60 Hz
Smoothing of measured values	
• parameterizable	Yes
• Step: None	Yes
• Step: low	Yes
• Step: Medium	Yes
• Step: High	Yes
Analog value generation for the outputs	
Integration and conversion time/ resolution per channel	
• Resolution (incl. overrange)	Voltage: 14 bits; Current : 13 bits

SIMATIC S7-1200 Basic Controllers

I/O modules

Analog modules

SM 1234 analog input/output modules

Technical specifications (continued)

Article number	6ES7234-4HE32-0XB0 ANALOG I/O SM 1234, 4AI/2AO
Errors/accuracies	
Temperature error (relative to input range), (+/-)	25 °C ±0.1%, to 55 °C ±0.2% total measurement range
Temperature error (relative to output range), (+/-)	25 °C ±0.3%, to 55 °C ±0.6% total measurement range
Basic error limit (operational limit at 25 °C)	
• Voltage, relative to input range, (+/-)	0.1%
• Current, relative to input range, (+/-)	0.1%
• Voltage, relative to output range, (+/-)	0.3%
• Current, relative to output range, (+/-)	0.3%
Interference voltage suppression for $f = n \times (f1 \pm 1\%)$, $f1 =$ interference frequency	
• Common mode voltage, max.	12 V
Interrupts/diagnostics/status information	
Alarms	Yes
Diagnostic functions	Yes
Alarms	
• Diagnostic alarm	Yes
Diagnostic messages	
• Monitoring the supply voltage	Yes
• Wire-break	Yes
• Short-circuit	Yes
Diagnostics indication LED	
• for status of the inputs	Yes
• for status of the outputs	Yes
• for maintenance	Yes
Potential separation analog outputs	
• between the channels and the power supply of the electronics	No
Degree and class of protection	
Degree of protection acc. to EN 60529	
• IP20	Yes

Article number	6ES7234-4HE32-0XB0 ANALOG I/O SM 1234, 4AI/2AO
Standards, approvals, certificates	
CE mark	Yes
CSA approval	Yes
FM approval	Yes
RCM (formerly C-TICK)	Yes
Marine approval	
• Marine approval	Yes
Ambient conditions	
Free fall	
• Fall height, max.	0.3 m; five times, in product package
Ambient temperature during operation	
• permissible temperature range	-20 °C to +60 °C horizontal mounting, -20 °C to 50 °C vertical mounting, 95% humidity, non-condensing
• min.	-20 °C
• max.	60 °C
Pollutant concentrations	
- SO2 at RH < 60% without condensation	SO2: < 0.5 ppm; H2S: < 0.1 ppm; RH < 60% condensation-free
Connection method	
required front connector	Yes
Mechanics/material	
Enclosure material (front)	
• Plastic	Yes
Dimensions	
Width	45 mm
Height	100 mm
Depth	75 mm
Weights	
Weight, approx.	220 g

Ordering data

SM 1234 analog input/output signal module

4 analog inputs, ±10 V, ±5 V, ±2.5 V, or 0 ... 20 mA, 12 bits + sign;
2 analog outputs, ±10 V with 14 bits or 0 ... 20 mA with 13 bits

6ES7234-4HE32-0XB0

Terminal block (spare part)

For 6ES7234-4HE32-0XB0
With 7 screws, gold-plated; 4 pcs.

6ES7292-1BG30-0XA0

Extension cable for two-tier configuration

For connecting digital/analog signal modules; length 2 m

6ES7290-6AA30-0XA0

Front flap set (spare part)

For modules with a width of 45 mm

6ES7291-1BA30-0XA0

Overview

- For the convenient recording of temperatures with great accuracy
- 7 common thermocouple types can be used
- Also for the measurement of analog signals with a low level (± 80 mV)
- Can easily be retrofitted to existing plant

Technical specifications

Article number	6ES7231-5QD32-0XB0	6ES7231-5QF32-0XB0
	S7-1200, ANALOG INPUT SM 1231 TC, 4 AI	S7-1200, ANALOG INPUT SM 1231 TC, 8 AI
General information		
Product type designation	SM 1231 TC 4x16 bit	SM 1231 TC 8x16bit
Supply voltage		
Rated value (DC)		
• 24 V DC	Yes	Yes
Input current		
Current consumption, typ.	40 mA	40 mA
from backplane bus 5 V DC, typ.	80 mA	80 mA
Power loss		
Power loss, typ.	1.5 W	1.5 W
Analog inputs		
Number of analog inputs	4; Thermocouples	8; Thermocouples
permissible input voltage for current input (destruction limit), max.	± 35 V	± 35 V
permissible input voltage for voltage input (destruction limit), max.	± 35 V	± 35 V
Technical unit for temperature measurement adjustable	Degrees Celsius/degrees Fahrenheit	Degrees Celsius/degrees Fahrenheit
Input ranges		
• Voltage	Yes	Yes
• Current	No	No
• Thermocouple	Yes; J, K, T, E, R, S, N, C, TXK/XK(L); voltage range: ± 80 mV	Yes; J, K, T, E, R & S, B, N, C, TXK/XK(L); voltage range: ± 80 mV
• Resistance thermometer	No	No
• Resistance	No	No
Input ranges (rated values), voltages		
• -80 mV to +80 mV	Yes	Yes
Input ranges (rated values), thermocouples		
• Type B	Yes	Yes
• Type C	Yes	Yes
• Type E	Yes	Yes
• Type J	Yes	Yes
• Type K	Yes	Yes
• Type N	Yes	Yes
• Type R	Yes	Yes
• Type S	Yes	Yes
• Type T	Yes	Yes
• Type TXK/TXK(L) to GOST	Yes	Yes
Thermocouple (TC)		
Temperature compensation		
- parameterizable	No	No

SIMATIC S7-1200 Basic Controllers

I/O modules

Analog modules

SM 1231 thermocouple modules

Technical specifications (continued)

Article number	6ES7231-5QD32-0XB0 S7-1200, ANALOG INPUT SM 1231 TC, 4 AI	6ES7231-5QF32-0XB0 S7-1200, ANALOG INPUT SM 1231 TC, 8 AI
Analog value generation for the inputs		
Measurement principle	integrating	integrating
Integration and conversion time/resolution per channel		
• Resolution with overrange (bit including sign), max.	15 bit; + sign	15 bit; + sign
• Integration time, parameterizable	No	No
• Interference voltage suppression for interference frequency f1 in Hz	85 dB at 50 / 60 / 400 Hz	85 dB at 50 / 60 / 400 Hz
Smoothing of measured values		
• parameterizable	Yes	Yes
Errors/accuracies		
Temperature error (relative to input range), (+/-)	25 °C ±0.1%, to 55 °C ±0.2% total measurement range	25 °C ±0.1%, to 55 °C ±0.2% total measurement range
Repeat accuracy in steady state at 25 °C (relative to output range), (+/-)	0.5%	0.5%
Interference voltage suppression for f = n x (f1 +/- 1%), f1 = interference frequency		
• Common mode interference, min.	120 dB	120 dB
Interrupts/diagnostics/status information		
Alarms	Yes	Yes
Diagnostic functions	Yes; Can be read out	Yes; Can be read out
Alarms		
• Diagnostic alarm	Yes	Yes
Diagnostic messages		
• Monitoring the supply voltage	Yes	Yes
• Wire-break	Yes	Yes
Diagnostics indication LED		
• for status of the inputs	Yes	Yes
• for maintenance	Yes	Yes
Degree and class of protection		
Degree of protection acc. to EN 60529		
• IP20	Yes	Yes
Standards, approvals, certificates		
CE mark	Yes	Yes
CSA approval	Yes	Yes
FM approval	Yes	Yes
RCM (formerly C-TICK)	Yes	Yes
Ambient conditions		
Free fall		
• Fall height, max.	0.3 m; five times, in product package	0.3 m; five times, in product package
Ambient temperature during operation		
• permissible temperature range	-20 °C to +60 °C horizontal mounting, -20 °C to 50 °C vertical mounting, 95% humidity, non-condensing	-20 °C to +60 °C horizontal mounting, -20 °C to 50 °C vertical mounting, 95% humidity, non-condensing
• min.	-20 °C	-20 °C
• max.	60 °C	60 °C
Pollutant concentrations		
- SO2 at RH < 60% without condensation	SO2: < 0.5 ppm; H2S: < 0.1 ppm; RH < 60% condensation-free	SO2: < 0.5 ppm; H2S: < 0.1 ppm; RH < 60% condensation-free

Technical specifications (continued)

Article number	6ES7231-5QD32-0XB0 S7-1200, ANALOG INPUT SM 1231 TC, 4 AI	6ES7231-5QF32-0XB0 S7-1200, ANALOG INPUT SM 1231 TC, 8 AI
Connection method		
required front connector	Yes	Yes
Mechanics/material		
Enclosure material (front)		
• Plastic	Yes	Yes
Dimensions		
Width	45 mm	45 mm
Height	100 mm	100 mm
Depth	75 mm	75 mm
Weights		
Weight, approx.	180 g	220 g

Ordering data**SM 1231 thermocouple module**

4 inputs +/- 80 mV,
resolution 15 bits + sign,
thermocouple types
J, K, S, T, R, E, N

8 inputs +/- 80 mV,
resolution 15 bits + sign,
thermocouple types
J, K, T, E, R, S, N, C, TXK/XK(L)

Article No.**6ES7231-5QD32-0XB0****6ES7231-5QF32-0XB0****Article No.****Accessories****Terminal block (spare part)**

For 6ES7231-5QD32-0XB0,
6ES7231-5QF32-0XB0

With 7 screws, gold-plated; 4 units

6ES7292-1BG30-0XA0**Extension cable for two-tier configuration**

For connecting digital/analog
signal modules;
length 2 m

6ES7290-6AA30-0XA0**Front flap set (spare part)**

For modules with a width of 45 mm

6ES7291-1BA30-0XA0

SIMATIC S7-1200 Basic Controllers

I/O modules

Analog modules

SB 1231 thermocouple signal boards

Overview

- For the convenient recording of temperatures with great accuracy
- 1 input with 16-bit resolution
- Common thermocouple types can be used
- Also for the measurement of analog signals with a low level (± 80 mV)
- Can easily be retrofitted to existing plant
- Can be plugged directly into the CPU

Technical specifications

Article number	6ES7231-5QA30-0XB0 SIGNAL BOARD SB 1231 TC, 1 AI
General information	
Product type designation	SB1231 AI 1xTC
Supply voltage	
Rated value (DC)	
• 24 V DC	Yes
Input current	
Current consumption, typ.	5 mA
from backplane bus 5 V DC, typ.	20 mA
Power loss	
Power loss, typ.	0.5 W
Analog inputs	
Number of analog inputs	1; Thermocouples
permissible input voltage for current input (destruction limit), max.	± 35 V
permissible input voltage for voltage input (destruction limit), max.	± 35 V
Technical unit for temperature measurement adjustable	Degrees Celsius/degrees Fahrenheit
Input ranges	
• Voltage	Yes
• Current	No
• Thermocouple	Yes; J, K; voltage range ± 80 mV
• Resistance thermometer	No
• Resistance	No
Input ranges (rated values), voltages	
• -80 mV to +80 mV	Yes
Input ranges (rated values), thermocouples	
• Type J	Yes
• Type K	Yes
Thermocouple (TC)	
Temperature compensation	
- parameterizable	No
Analog outputs	
Number of analog outputs	0

Article number	6ES7231-5QA30-0XB0 SIGNAL BOARD SB 1231 TC, 1 AI
Analog value generation for the inputs	
Measurement principle	integrating
Integration and conversion time/resolution per channel	
• Resolution with overrange (bit including sign), max.	15 bit; + sign
• Integration time, parameterizable	No
• Interference voltage suppression for interference frequency f_1 in Hz	85 dB at 10 / 50 / 60 / 400 Hz
Smoothing of measured values	
• parameterizable	Yes
Errors/accuracies	
Temperature error (relative to input range), (+/-)	25 °C $\pm 0.1\%$, to 55 °C $\pm 0.2\%$ total measurement range
Repeat accuracy in steady state at 25 °C (relative to output range), (+/-)	0.5%
Interference voltage suppression for $f = n \times (f_1 \pm 1\%)$, $f_1 =$ interference frequency	
• Common mode interference, min.	120 dB
Interrupts/diagnostics/status information	
Alarms	Yes
Diagnostic functions	Yes; Can be read out
Alarms	
• Diagnostic alarm	Yes
Diagnostic messages	
• Wire-break	Yes
Diagnostics indication LED	
• for status of the inputs	Yes
• for maintenance	Yes
Degree and class of protection	
Degree of protection acc. to EN 60529	
• IP20	Yes
Standards, approvals, certificates	
CE mark	Yes
CSA approval	Yes
FM approval	Yes
RCM (formerly C-TICK)	Yes

Technical specifications (continued)

Article number	6ES7231-5QA30-0XB0 SIGNAL BOARD SB 1231 TC, 1 AI
Ambient conditions	
Free fall	
• Fall height, max.	0.3 m; five times, in product package
Ambient temperature during operation	
• permissible temperature range	-20 °C to +60 °C horizontal mounting, -20 °C to 50 °C vertical mounting, 95% humidity, non-condensing
• min.	-20 °C
• max.	60 °C
Pollutant concentrations	
- SO ₂ at RH < 60% without condensation	SO ₂ : < 0.5 ppm; H ₂ S: < 0.1 ppm; RH < 60% condensation-free
Connection method	
required front connector	Yes
Mechanics/material	
Enclosure material (front)	
• Plastic	Yes
Dimensions	
Width	38 mm
Height	62 mm
Depth	21 mm
Weights	
Weight, approx.	35 g

Ordering data**Article No.****SB 1231 thermocouple signal board****6ES7231-5QA30-0XB0**

1 input +/- 80 mV, resolution 15 bits + sign, thermocouples type J, K

Accessories**Terminal block (spare part)**

For signal board

With 6 screws, gold-plated; 4 pcs.

6ES7292-1BF30-0XA0

SIMATIC S7-1200 Basic Controllers

I/O modules

Analog modules

SM 1231 RTD signal modules

Overview

- For the convenient recording of temperatures with great accuracy
- 4 inputs
- Most popular resistance temperature detectors can be used
- Can easily be retrofitted to existing installation

Technical specifications

Article number	6ES7231-5PD32-0XB0 S7-1200, ANALOG INPUT SM 1231 RTD, 4 AI	6ES7231-5PF32-0XB0 S7-1200, ANALOG INPUT SM 1231 RTD, 8 AI
General information		
Product type designation	SM 1231 RTD 4x16bit	SM 1231 RTD 8x16bit
Supply voltage		
Rated value (DC)		
• 24 V DC	Yes	Yes
Input current		
Current consumption, typ.	40 mA	40 mA
from backplane bus 5 V DC, typ.	80 mA	80 mA
Power loss		
Power loss, typ.	1.5 W	1.5 W
Analog inputs		
Number of analog inputs	4; Resistance thermometer	8; Resistance thermometer
permissible input voltage for current input (destruction limit), max.	±35 V	±35 V
Technical unit for temperature measurement adjustable	Degrees Celsius/degrees Fahrenheit	Degrees Celsius/degrees Fahrenheit
Input ranges		
• Voltage	No	No
• Current	No	No
• Thermocouple	No	No
• Resistance thermometer	Yes; Resistance-type transmitter: Pt10, Pt50, Pt100, Pt200, Pt500, Pt1000, Ni100, Ni120, Ni200, Ni500, Ni1000, Cu10, Cu50, Cu100, LG-Ni1000	Yes; Resistance-type transmitter: Pt10, Pt50, Pt100, Pt200, Pt500, Pt1000, Ni100, Ni120, Ni200, Ni500, Ni1000, Cu10, Cu50, Cu100, LG-Ni1000
• Resistance	Yes; 150 Ω, 300 Ω, 600 Ω	Yes; 150 Ω, 300 Ω, 600 Ω
Input ranges (rated values), resistance thermometer		
• Cu 10	Yes	Yes
• Ni 100	Yes	Yes
• Ni 1000	Yes	Yes
• LG-Ni 1000	Yes	Yes
• Ni 120	Yes	Yes
• Ni 200	Yes	Yes
• Ni 500	Yes	Yes
• Pt 100	Yes	Yes
• Pt 1000	Yes	Yes
• Pt 200	Yes	Yes
• Pt 500	Yes	Yes
Input ranges (rated values), resistors		
• 0 to 150 ohms	Yes	Yes
• 0 to 300 ohms	Yes	Yes
• 0 to 600 ohms	Yes	Yes
Thermocouple (TC)		
Temperature compensation		
- parameterizable	No	No

Technical specifications (continued)

Article number	6ES7231-5PD32-0XB0	6ES7231-5PF32-0XB0
	S7-1200, ANALOG INPUT SM 1231 RTD, 4 AI	S7-1200, ANALOG INPUT SM 1231 RTD, 8 AI
Analog value generation for the inputs		
Measurement principle	integrating	integrating
Integration and conversion time/resolution per channel		
• Resolution with overrange (bit including sign), max.	15 bit; + sign	15 bit; + sign
• Integration time, parameterizable	No	No
• Interference voltage suppression for interference frequency f1 in Hz	85 dB at 50 / 60 / 400 Hz	85 dB at 50 / 60 / 400 Hz
Errors/accuracies		
Temperature error (relative to input range), (+/-)	25 °C ±0.1%, to 55 °C ±0.2% total measurement range	25 °C ±0.1%, to 55 °C ±0.2% total measurement range
Repeat accuracy in steady state at 25 °C (relative to output range), (+/-)	0.05%	0.05%
Interference voltage suppression for f = n x (f1 +/- 1%), f1 = interference frequency		
• Common mode interference, min.	120 dB	120 dB
Interrupts/diagnostics/status information		
Alarms	Yes	Yes
Diagnostic functions	Yes; Can be read out	Yes; Can be read out
Alarms		
• Diagnostic alarm	Yes	Yes
Diagnostic messages		
• Monitoring the supply voltage	Yes	Yes
• Wire-break	Yes	Yes
Diagnostics indication LED		
• for status of the inputs	Yes	Yes
• for maintenance	Yes	Yes
Degree and class of protection		
Degree of protection acc. to EN 60529		
• IP20	Yes	Yes
Standards, approvals, certificates		
CE mark	Yes	Yes
CSA approval	Yes	Yes
FM approval	Yes	Yes
RCM (formerly C-TICK)	Yes	Yes
Ambient conditions		
Free fall		
• Fall height, max.	0.3 m; five times, in product package	0.3 m; five times, in product package
Ambient temperature during operation		
• permissible temperature range	-20 °C to +60 °C horizontal mounting, -20 °C to 50 °C vertical mounting, 95% humidity, non-condensing	-20 °C to +60 °C horizontal mounting, -20 °C to 50 °C vertical mounting, 95% humidity, non-condensing
• min.	-20 °C	-20 °C
• max.	60 °C	60 °C
Pollutant concentrations		
- SO2 at RH < 60% without condensation	SO2: < 0.5 ppm; H2S: < 0.1 ppm; RH < 60% condensation-free	SO2: < 0.5 ppm; H2S: < 0.1 ppm; RH < 60% condensation-free
Connection method		
required front connector	Yes	Yes
Mechanics/material		
Enclosure material (front)		
• Plastic	Yes	Yes
Dimensions		
Width	45 mm	70 mm
Height	100 mm	100 mm
Depth	75 mm	75 mm
Weights		
Weight, approx.	220 g	220 g

SIMATIC S7-1200 Basic Controllers

I/O modules

Analog modules

SM 1231 RTD signal modules**Ordering data****Article No.****Article No.****SM 1231 RTD signal module**

4 inputs for resistance temperature detectors Pt10/50/100/200/500/1000, Ni100/120/200/500/1000, Cu10/50/100, LG-Ni1000; resistance 150/300/600 Ohm, resolution 15 bits + sign

6ES7231-5PD32-0XB0

8 inputs for resistance temperature detectors Pt10/50/100/200/500/1000, Ni100/120/200/500/1000, Cu10/50/100, LG-Ni1000; resistance 150/300/600 Ohm, resolution 15 bits + sign

6ES7231-5PF32-0XB0**Accessories****Terminal block (spare part)**

For 6ES7231-5PD32-0XB0

- With 7 screws, gold-plated; 4 units

6ES7292-1BG30-0XA0

For 6ES7231-5PF32-0XB0

- With 11 screws, gold-plated; 4 units

6ES7292-1BL30-0XA0**Extension cable for two-tier configuration****6ES7290-6AA30-0XA0**

For connecting digital/analog signal modules; length 2 m

Front flap set (spare part)

For modules with a width of 45 mm

6ES7291-1BA30-0XA0

For modules with a width of 70 mm

6ES7291-1BB30-0XA0

Overview

- For the convenient recording of temperatures with great accuracy
- 1 input with 16-bit resolution
- Common resistance-type temperature detectors can be used
- Can easily be retrofitted to existing plant
- Can be plugged directly into the CPU

Technical specifications

Article number	6ES7231-5PA30-0XB0 SIGNAL BOARD SB 1231 RTD
General information	
Product type designation	SB1231 AI 1xRTD
Supply voltage	
Rated value (DC)	
• 24 V DC	Yes
Input current	
Current consumption, typ.	5 mA
from backplane bus 5 V DC, typ.	20 mA
Power loss	
Power loss, typ.	0.5 W
Analog inputs	
Number of analog inputs	1; Resistance thermometer
permissible input voltage for current input (destruction limit), max.	±35 V
Technical unit for temperature measurement adjustable	Degrees Celsius/degrees Fahrenheit
Input ranges	
• Voltage	Yes
• Current	No
• Thermocouple	No
• Resistance thermometer	Yes; Platinum (Pt)
• Resistance	Yes; 150 Ω, 300 Ω, 600 Ω
Input ranges (rated values), resistance thermometer	
• Pt 100	Yes
• Pt 1000	Yes
• Pt 200	Yes
• Pt 500	Yes
Input ranges (rated values), resistors	
• 0 to 150 ohms	Yes
• 0 to 300 ohms	Yes
• 0 to 600 ohms	Yes
Thermocouple (TC)	
Temperature compensation	
- parameterizable	No
Analog outputs	
Number of analog outputs	0

Article number	6ES7231-5PA30-0XB0 SIGNAL BOARD SB 1231 RTD
Analog value generation for the inputs	
Measurement principle	integrating
Integration and conversion time/resolution per channel	
• Resolution with overrange (bit including sign), max.	15 bit; + sign
• Integration time, parameterizable	No
• Interference voltage suppression for interference frequency f1 in Hz	85 dB at 10 / 50 / 60 / 400 Hz
Errors/accuracies	
Temperature error (relative to input range), (+/-)	25 °C ±0.1%, to 55 °C ±0.2% total measurement range
Repeat accuracy in steady state at 25 °C (relative to output range), (+/-)	0.05%
Interference voltage suppression for f = n x (f1 +/- 1%), f1 = interference frequency	
• Common mode interference, min.	120 dB
Interrupts/diagnostics/status information	
Alarms	Yes
Diagnostic functions	Yes; Can be read out
Alarms	
• Diagnostic alarm	Yes
Diagnostic messages	
• Wire-break	Yes
Diagnostics indication LED	
• for status of the inputs	Yes
• for maintenance	Yes
Degree and class of protection	
Degree of protection acc. to EN 60529	
• IP20	Yes
Standards, approvals, certificates	
CE mark	Yes
CSA approval	Yes
FM approval	Yes
RCM (formerly C-TICK)	Yes

SIMATIC S7-1200 Basic Controllers

I/O modules

Analog modules

SB 1231 RTD signal boards**Technical specifications** (continued)

Article number	6ES7231-5PA30-0XB0 SIGNAL BOARD SB 1231 RTD
Ambient conditions	
Free fall	
• Fall height, max.	0.3 m; five times, in product package
Ambient temperature during operation	
• permissible temperature range	-20 °C to +60 °C horizontal mounting, -20 °C to 50 °C vertical mounting, 95% humidity, non-condensing
• min.	-20 °C
• max.	60 °C
Pollutant concentrations	
- SO ₂ at RH < 60% without condensation	SO ₂ : < 0.5 ppm; H ₂ S: < 0.1 ppm; RH < 60% condensation-free
Connection method	
required front connector	Yes
Mechanics/material	
Enclosure material (front)	
• Plastic	Yes
Dimensions	
Width	38 mm
Height	62 mm
Depth	21 mm
Weights	
Weight, approx.	35 g

Ordering data**Article No.****RTD signal board SB 1231**

1 input for resistance temperature sensors Pt 100, Pt 200, Pt 500, Pt 1000, resolution 15 bits + sign

6ES7231-5PA30-0XB0**Accessories****Terminal block (spare part)**

For signal board
With 6 screws, gold-plated; 4 pcs.

6ES7292-1BF30-0XA0

3

Overview

- Energy management based on SIMATIC S7-1200
- Data acquisition of electrical characteristics in 1 and 3-phase networks up to 480 V AC
- Direct connection of voltage inputs
- Current measurement performed by 1 A and 5 A current transformers
- Can be used in TN and TT networks
- Data backup of measurement data in the event of a power failure

Technical specifications

Article number	6ES7238-5XA32-0XB0 SM 1238 Energy Meter 480V AC
General information	
Product type designation	SM 1238 AI Energy Meter 480 VAC
Product function	
• Voltage measurement	Yes
• Voltage measurement with voltage transformers	Yes
• Current measurement	Yes
• Phase current measurement without current transformers	No
• Phase current measurement with current transformers	Yes
• Energy measurement	Yes
• Frequency measurement	Yes
• Power measurement	Yes
• Active power measurement	Yes
• Reactive power measurement	Yes
• I&M data	Yes; I&M 0
• Isochronous mode	No
Engineering with	
• STEP 7 TIA Portal configurable/integrated as of version	V13 SP1
Operating mode	
• cyclic measurement	Yes
• acyclic measurement	Yes
• Acyclic measured value access	Yes
• Fixed measured value sets	Yes
• Freely definable measured value sets	Yes
CiR – Configuration in RUN	
Reparameterization possible in RUN	Yes
Calibration possible in RUN	Yes
Installation type/mounting	
Mounting position	Horizontal, vertical
Supply voltage	
Design of the power supply	Supply via voltage measurement channel L1
Type of supply voltage	AC 100 - 277 V
permissible range, lower limit (AC)	90 V
permissible range, upper limit (AC)	293 V
Line frequency	
• permissible range, lower limit	47 Hz
• permissible range, upper limit	63 Hz

Article number	6ES7238-5XA32-0XB0 SM 1238 Energy Meter 480V AC
Power loss	
Power loss, typ.	0.6 W
Address area	
Address space per module	
• Address space per module, max.	124 byte; 112 byte input / 12 byte output
Analog inputs	
Cycle time (all channels), typ.	50 ms; Time for consistent update of all measured and calculated values (cyclic und acyclic data)
Interrupts/diagnostics/status information	
Alarms	
• Diagnostic alarm	Yes
• Limit value alarm	Yes
• Hardware interrupt	No
Diagnostics indication LED	
• Monitoring of the supply voltage (PWR-LED)	Yes
• Channel status display	Yes; Green LED
• for channel diagnostics	Yes; red Fn LED
• for module diagnostics	Yes; green/red DIAG LED
Integrated Functions	
Measuring functions	
• Measuring procedure for voltage measurement	TRMS
• Measuring procedure for current measurement	TRMS
• Type of measured value acquisition	seamless
• Curve shape of voltage	Sinusoidal or distorted
• Buffering of measured variables	Yes
• Parameter length	74 byte
• Bandwidth of measured value acquisition	2 kHz; Harmonics: 39 / 50 Hz, 32 / 60 Hz
Operating mode for measured value acquisition	
- automatic detection of line frequency	No; Parameterizable
Measuring range	
- Frequency measurement, min.	45 Hz
- Frequency measurement, max.	65 Hz

SIMATIC S7-1200 Basic Controllers

I/O modules

Analog modules

SM 1238 Energy Meter 480 V AC analog input modules

Technical specifications (continued)

Article number	6ES7238-5XA32-0XB0
	SM 1238 Energy Meter 480V AC
Measuring inputs for voltage	
- Measurable line voltage between phase and neutral conductor	277 V
- Measurable line voltage between the line conductors	480 V
- Measurable line voltage between phase and neutral conductor, min.	90 V
- Measurable line voltage between phase and neutral conductor, max.	293 V
- Measurable line voltage between the line conductors, min.	155 V
- Measurable line voltage between the line conductors, max.	508 V
- Measurement category for voltage measurement in accordance with IEC 61010-2-030	CAT II; CAT III in case of guaranteed protection level of 1.5 kV
- Internal resistance line conductor and neutral conductor	3.4 MΩ
- Power consumption per phase	20 mW
- Impulse voltage resistance 1,2/50μs	1 kV
Measuring inputs for current	
- measurable relative current (AC), min.	1%; Relative to the secondary rated current 5 A
- measurable relative current (AC), max.	100%; Relative to the secondary rated current 5 A
- Continuous current with AC, maximum permissible	5 A
- Apparent power consumption per phase for measuring range 5 A	0.6 V·A
- Rated value short-time withstand current restricted to 1 s	100 A
- Input resistance measuring range 0 to 5 A	25 mΩ; At the terminal
- Zero point suppression	Parameterizable: 2 - 250 mA, default 50 mA
- Surge strength	10 A; for 1 minute

Article number	6ES7238-5XA32-0XB0
	SM 1238 Energy Meter 480V AC
Accuracy class according to IEC 61557-12	
- Measured variable voltage	0,2
- Measured variable current	0,2
- Measured variable apparent power	0.5
- Measured variable active power	0.5
- Measured variable reactive power	1
- Measured variable power factor	0.5
- Measured variable active energy	0.5
- Measured variable reactive energy	1
- Measured variable neutral current	0.5; calculated
- Measured variable phase angle	± 1 °; not covered by IEC 61557-12
- Measured variable frequency	0.05
Potential separation	
Potential separation channels	
• between the channels and backplane bus	Yes; 3 700V AC (type test) CAT III
Isolation	
Isolation tested with	2 300V AC for 1 min. (type test)
Ambient conditions	
Ambient temperature during operation	
• horizontal installation, min.	-20 °C
• horizontal installation, max.	60 °C
• vertical installation, min.	-20 °C
• vertical installation, max.	50 °C
Dimensions	
Width	45 mm
Height	100 mm
Depth	75 mm
Weights	
Weight (without packaging)	165 g
Data for selecting a current transformer	
• Burden power current transformer x/1A, min.	As a function of cable length and cross section, see device manual
• Burden power current transformer x/5A, min.	As a function of cable length and cross section, see device manual

Ordering data

SM 1238 Energy Meter 480 V AC analog input

Energy measurement module for data acquisition in 1 and 3-phase networks (TN, TT) up to 480 V AC; current range: 1 A, 5 A; recording of voltage, current, phase angles, power ratings, energy values, frequencies; with channel diagnostics

Article No.

6ES7238-5XA32-0XB0

Extension cable for two-tier configuration

For connecting digital/analog signal modules; length 2 m

6ES7290-6AA30-0XA0

Article No.

Terminal block (spare part)

For voltage input (top), 7-pole, tinned, coded in middle

6ES7292-1AG40-0XA2

For current input (bottom), 7-pole, tinned

6ES7292-1AG30-0XA0

Front flap set (spare part)

For modules with a width of 45 mm

6ES7291-1BA30-0XA0

Overview

- Analog inputs for SIPLUS S7-1200
- With extremely short conversion times
- For connecting analog actuators and sensors without additional amplifiers
- Even solves more complex automation tasks
- From +60 °C to +70 °C, max. 50% of the inputs can be controlled simultaneously

Note:

SIPLUS extreme products are based on SIMATIC standard products. The contents listed here were taken from the respective standard products. SIPLUS extreme-specific information was added.

Technical specifications

Article number	6AG1231-4HD32-4XB0
Based on	6ES7231-4HD32-0XB0 SIPLUS S7-1200 SM 1231 4AI 13Bit
Ambient conditions	
Free fall	
• Fall height, max.	0.3 m; five times, in product package
Ambient temperature during operation	
• min.	-20 °C; = Tmin; Startup @ 0 °C
• max.	60 °C; = Tmax
Extended ambient conditions	
• relative to ambient temperature-atmospheric pressure-installation altitude	Tmin ... Tmax at 1080 hPa ... 795 hPa (-1000 m ... +2000 m) // Tmin ... (Tmax - 10K) at 795 hPa ... 658 hPa (+2000 m ... +3500 m) // Tmin ... (Tmax - 20K) at 658 hPa ... 540 hPa (+3500 m ... +5000 m)

Article number	6AG1231-4HD32-4XB0
Based on	6ES7231-4HD32-0XB0 SIPLUS S7-1200 SM 1231 4AI 13Bit
Relative humidity	
- With condensation, tested in accordance with IEC 60068-2-38, max.	100%; RH incl. condensation/frost (no commissioning under condensation conditions)
Resistance	
- against biologically active substances / conformity with EN 60721-3-3	Yes; Class 3B2 mold, fungus and dry rot spores (with the exception of fauna). The supplied connector covers must remain on the unused interfaces during operation!
- against chemically active substances / conformity with EN 60721-3-3	Yes; Class 3C4 (RH < 75%) incl. salt spray according to EN 60068-2-52 (degree of severity 3). The supplied connector covers must remain on the unused interfaces during operation!
- against mechanically active substances / conformity with EN 60721-3-3	Yes; Class 3S4 incl. sand, dust. The supplied connector covers must remain on the unused interfaces during operation!

Ordering data**Analog input
SIPLUS signal module SM 1231**

(Extended temperature range and exposure to media)

Ambient temperature range
0 ... +55 °C

4 analog inputs
±10 V, ±5 V, ±2.5 V, or
0 ... 20 mA; 12 bits + sign

Article No.**6AG1231-4HD32-4XB0****Accessories**

See SIMATIC S7-1200
analog input SM 1231,
page 3/79

SIMATIC S7-1200 Basic Controllers

I/O modules

SIPLUS analog modules

SIPLUS SM 1232 analog output modules**Overview**

- Analog outputs for SIPLUS S7-1200
- With extremely short conversion times
- For connecting analog actuators without additional amplifiers
- Even solves more complex automation tasks
- From +60 °C to +70 °C, max. 50% of the outputs can be controlled simultaneously

Note:

SIPLUS extreme products are based on SIMATIC standard products. The contents listed here were taken from the respective standard products. SIPLUS extreme-specific information was added.

Technical specifications

Article number	6AG1232-4HB32-4XB0
Based on	6ES7232-4HB32-0XB0 SIPLUS S7-1200 SM 1232 2AQ 13Bit
Ambient conditions	
Free fall	
• Fall height, max.	0.3 m; five times, in product package
Ambient temperature during operation	
• min.	-20 °C; = Tmin; Startup @ 0 °C
• max.	60 °C; = Tmax
Extended ambient conditions	
• relative to ambient temperature-atmospheric pressure-installation altitude	Tmin ... Tmax at 1080 hPa ... 795 hPa (-1000 m ... +2000 m) // Tmin ... (Tmax - 10K) at 795 hPa ... 658 hPa (+2000 m ... +3500 m) // Tmin ... (Tmax - 20K) at 658 hPa ... 540 hPa (+3500 m ... +5000 m)

Article number	6AG1232-4HB32-4XB0
Based on	6ES7232-4HB32-0XB0 SIPLUS S7-1200 SM 1232 2AQ 13Bit
Relative humidity	
- With condensation, tested in accordance with IEC 60068-2-38, max.	100%; RH incl. condensation/frost (no commissioning under condensation conditions)
Resistance	
- against biologically active substances / conformity with EN 60721-3-3	Yes; Class 3B2 mold, fungus and dry rot spores (with the exception of fauna). The supplied connector covers must remain on the unused interfaces during operation!
- against chemically active substances / conformity with EN 60721-3-3	Yes; Class 3C4 (RH < 75%) incl. salt spray according to EN 60068-2-52 (degree of severity 3). The supplied connector covers must remain on the unused interfaces during operation!
- against mechanically active substances / conformity with EN 60721-3-3	Yes; Class 3S4 incl. sand, dust. The supplied connector covers must remain on the unused interfaces during operation!

Ordering data

Analog output SIPLUS signal module SM 1232
(Extended temperature range and exposure to media)
Ambient temperature range
-20 ... +60 °C
2 analog outputs,
±10 V with 14 bits or
0 ... 20 mA with 13 bits

Article No.**6AG1232-4HB32-4XB0****Article No.****Accessories**

See SIMATIC S7-1200 analog output SM 1232, page 3/84

Overview

- Analog output for SIPLUS S7-1200
- Can be plugged directly into the CPU (cannot be used for +70 °C version)

Note:

SIPLUS extreme products are based on SIMATIC standard products. The contents listed here were taken from the respective standard products. SIPLUS extreme-specific information was added.

3

Technical specifications

Article number	6AG1232-4HA30-4XB0	6AG1232-4HA30-5XB0
Based on	6ES7232-4HA30-0XB0 SIPLUS S7-1200 SB 1232 1AQ	6ES7232-4HA30-0XB0 SIPLUS S7-1200 SB 1232 1AQ
Ambient conditions		
Free fall		
• Fall height, max.	0.3 m; five times, in product package	0.3 m; five times, in product package
Ambient temperature during operation		
• min.	0 °C; = Tmin	-40 °C; = Tmin; Startup @ -25 °C
• max.	55 °C; = Tmax	55 °C; = Tmax
Extended ambient conditions		
• relative to ambient temperature-atmospheric pressure-installation altitude	Tmin ... Tmax at 1080 hPa ... 795 hPa (-1000 m ... +2000 m) // Tmin ... (Tmax - 10K) at 795 hPa ... 658 hPa (+2000 m ... +3500 m) // Tmin ... (Tmax - 20K) at 658 hPa ... 540 hPa (+3500 m ... +5000 m)	Tmin ... Tmax at 1080 hPa ... 795 hPa (-1000 m ... +2000 m) // Tmin ... (Tmax - 10K) at 795 hPa ... 658 hPa (+2000 m ... +3500 m) // Tmin ... (Tmax - 20K) at 658 hPa ... 540 hPa (+3500 m ... +5000 m)
Relative humidity		
- With condensation, tested in accordance with IEC 60068-2-38, max.	100%; RH incl. condensation/frost (no commissioning under condensation conditions)	100%; RH incl. condensation/frost (no commissioning under condensation conditions)
Resistance		
- against biologically active substances / conformity with EN 60721-3-3	Yes; Class 3B2 mold, fungus and dry rot spores (with the exception of fauna). The supplied connector covers must remain on the unused interfaces during operation!	Yes; Class 3B2 mold, fungus and dry rot spores (with the exception of fauna). The supplied connector covers must remain on the unused interfaces during operation!
- against chemically active substances / conformity with EN 60721-3-3	Yes; Class 3C4 (RH < 75%) incl. salt spray according to EN 60068-2-52 (degree of severity 3). The supplied connector covers must remain on the unused interfaces during operation!	Yes; Class 3C4 (RH < 75%) incl. salt spray according to EN 60068-2-52 (degree of severity 3). The supplied connector covers must remain on the unused interfaces during operation!
- against mechanically active substances / conformity with EN 60721-3-3	Yes; Class 3S4 incl. sand, dust. The supplied connector covers must remain on the unused interfaces during operation!	Yes; Class 3S4 incl. sand, dust. The supplied connector covers must remain on the unused interfaces during operation!

SIMATIC S7-1200 Basic Controllers

I/O modules

SIPLUS analog modules

SIPLUS SB 1232 analog output modules**Ordering data****Article No.****SIPLUS SB 1232 analog output signal board**

(Extended temperature range and exposure to media)

Ambient temperature range-25 ... +55 °C

1 analog output, ±10 V with 12 bits or 0 ... 20 mA with 11 bits

6AG1232-4HA30-5XB0Ambient temperature range0 ... +55 °C

1 analog output, ±10 V with 12 bits or 0 ... 20 mA with 11 bits

6AG1232-4HA30-4XB0**Accessories****Article No.**

See SIMATIC S7-1200 analog output SB 1232, page 3/86

3

Overview

- Analog inputs and outputs for SIPLUS S7-1200
- With extremely short conversion times
- For connecting analog actuators and sensors without additional amplifiers
- Even solves more complex automation tasks
- From +60 °C to +70 °C, max. 50% of the inputs and outputs can be controlled simultaneously

Note:

SIPLUS extreme products are based on SIMATIC standard products. The contents listed here were taken from the respective standard products. SIPLUS extreme-specific information was added.

Technical specifications

Article number	6AG1234-4HE32-2XB0	6AG1234-4HE32-4XB0
Based on	6ES7234-4HE32-0XB0 SIPLUS S7-1200 SM 1234 4AI/2AQ 13Bit	6ES7234-4HE32-0XB0 SIPLUS S7-1200 SM 1234 4AI/2AQ 13Bit
Ambient conditions		
Free fall		
• Fall height, max.	0.3 m; five times, in product package	0.3 m; five times, in product package
Ambient temperature during operation		
• min.	-40 °C; = Tmin; Startup @ -25 °C	-20 °C; = Tmin; Startup @ 0 °C
• max.	70 °C; = Tmax; Tmax > +60 °C number of simultaneously used outputs 1, inputs 2 (no adjacent points) for horizontal mounting position	60 °C; = Tmax
Extended ambient conditions		
• relative to ambient temperature-atmospheric pressure-installation altitude	Tmin ... Tmax at 1080 hPa ... 795 hPa (-1000 m ... +2000 m) // Tmin ... (Tmax - 10K) at 795 hPa ... 658 hPa (+2000 m ... +3500 m) // Tmin ... (Tmax - 20K) at 658 hPa ... 540 hPa (+3500 m ... +5000 m)	Tmin ... Tmax at 1080 hPa ... 795 hPa (-1000 m ... +2000 m) // Tmin ... (Tmax - 10K) at 795 hPa ... 658 hPa (+2000 m ... +3500 m) // Tmin ... (Tmax - 20K) at 658 hPa ... 540 hPa (+3500 m ... +5000 m)
Relative humidity		
- With condensation, tested in accordance with IEC 60068-2-38, max.	100%; RH incl. condensation/frost (no commissioning under condensation conditions)	100%; RH incl. condensation/frost (no commissioning under condensation conditions)
Resistance		
- against biologically active substances / conformity with EN 60721-3-3	Yes; Class 3B2 mold, fungus and dry rot spores (with the exception of fauna). The supplied connector covers must remain on the unused interfaces during operation!	Yes; Class 3B2 mold, fungus and dry rot spores (with the exception of fauna). The supplied connector covers must remain on the unused interfaces during operation!
- against chemically active substances / conformity with EN 60721-3-3	Yes; Class 3C4 (RH < 75%) incl. salt spray according to EN 60068-2-52 (degree of severity 3). The supplied connector covers must remain on the unused interfaces during operation!	Yes; Class 3C4 (RH < 75%) incl. salt spray according to EN 60068-2-52 (degree of severity 3). The supplied connector covers must remain on the unused interfaces during operation!
- against mechanically active substances / conformity with EN 60721-3-3	Yes; Class 3S4 incl. sand, dust. The supplied connector covers must remain on the unused interfaces during operation!	Yes; Class 3S4 incl. sand, dust. The supplied connector covers must remain on the unused interfaces during operation!

SIMATIC S7-1200 Basic Controllers

I/O modules

SIPLUS analog modules

SIPLUS SM 1234 analog input/output modules**Ordering data****Article No.****Article No.****Analog input/output SIPLUS signal module SM 1234**

(Extended temperature range and exposure to media)

Ambient temperature range-25 ... +70 °C,

from +60 ... +70 °C number of simultaneously controllable inputs and outputs max. 50%

4 analog inputs,
±10 V, ±5 V, ±2.5 V, or 0 ... 20 mA,
12 bits + sign;
2 analog outputs,
±10 V with 14 bits or 0 ... 20 mA
with 13 bits**6AG1234-4HE32-2XB0**Ambient temperature range0 ... +55 °C4 analog inputs,
±10 V, ±5 V, ±2.5 V, or
0 ... 20 mA, 12 bits + sign;
2 analog outputs,
±10 V with 14 bits or
0 ... 20 mA with 13 bits**6AG1234-4HE32-4XB0****Accessories**See SIMATIC S7-1200
analog input/output SM 1234,
page 3/88

3

Overview

- For the convenient recording of temperatures with great accuracy
- 7 common thermocouple types can be used
- Also for the measurement of analog signals with a low level (± 80 mV)
- Can easily be retrofitted to existing plant

Note:

SIPLUS extreme products are based on SIMATIC standard products. The contents listed here were taken from the respective standard products. SIPLUS extreme specific information was added.

Technical specifications

Article number	6AG1231-5QF32-4XB0	6AG1231-5QD32-4XB0
Based on	6ES7231-5QF32-0XB0 SIPLUS S7-1200 SM 1231 8AI TC 16Bit	6ES7231-5QD32-0XB0 SIPLUS S7-1200 SM 1231 4AI TC 16Bit
Ambient conditions		
Free fall		
• Fall height, max.	0.3 m; five times, in product package	0.3 m; five times, in product package
Ambient temperature during operation		
• min.	-20 °C; = Tmin; Startup @ 0 °C	-20 °C; = Tmin; Startup @ 0 °C
• max.	60 °C; = Tmax	60 °C; = Tmax
Extended ambient conditions		
• relative to ambient temperature-atmospheric pressure-installation altitude	Tmin ... Tmax at 1080 hPa ... 795 hPa (-1000 m ... +2000 m) // Tmin ... (Tmax - 10K) at 795 hPa ... 658 hPa (+2000 m ... +3500 m) // Tmin ... (Tmax - 20K) at 658 hPa ... 540 hPa (+3500 m ... +5000 m)	Tmin ... Tmax at 1080 hPa ... 795 hPa (-1000 m ... +2000 m) // Tmin ... (Tmax - 10K) at 795 hPa ... 658 hPa (+2000 m ... +3500 m) // Tmin ... (Tmax - 20K) at 658 hPa ... 540 hPa (+3500 m ... +5000 m)
Relative humidity		
- With condensation, tested in accordance with IEC 60068-2-38, max.	100%; RH incl. condensation/frost (no commissioning under condensation conditions)	100%; RH incl. condensation/frost (no commissioning under condensation conditions)
Resistance		
- against biologically active substances / conformity with EN 60721-3-3	Yes; Class 3B2 mold, fungus and dry rot spores (with the exception of fauna). The supplied connector covers must remain on the unused interfaces during operation!	Yes; Class 3B2 mold, fungus and dry rot spores (with the exception of fauna). The supplied connector covers must remain on the unused interfaces during operation!
- against chemically active substances / conformity with EN 60721-3-3	Yes; Class 3C4 (RH < 75%) incl. salt spray according to EN 60068-2-52 (degree of severity 3). The supplied connector covers must remain on the unused interfaces during operation!	Yes; Class 3C4 (RH < 75%) incl. salt spray according to EN 60068-2-52 (degree of severity 3). The supplied connector covers must remain on the unused interfaces during operation!
- against mechanically active substances / conformity with EN 60721-3-3	Yes; Class 3S4 incl. sand, dust. The supplied connector covers must remain on the unused interfaces during operation!	Yes; Class 3S4 incl. sand, dust. The supplied connector covers must remain on the unused interfaces during operation!

Ordering data**SM 1231 thermocouple module**

(Extended temperature range and exposure to media)

Ambient temperature range
-40 ... +70 °C

8 inputs +/- 80 mV, resolution 15 bits + sign, thermocouple types J, K, T, E, R, S, N, C, TXK/XK(L)

4 inputs +/- 80 mV, resolution 15 bits + sign, thermocouple types J, K, T, E, R, S, N, C, TXK/XK(L)

Article No.

6AG1231-5QF32-4XB0

6AG1231-5QD32-4XB0

Article No.**Accessories**

See SIMATIC S7-1200 thermocouple module SM 1231, page 3/91

SIMATIC S7-1200 Basic Controllers

I/O modules

SIPLUS analog modules

SIPLUS RTD SM 1231 signal modules

Overview

- For the convenient recording of temperatures with great accuracy
- 4 inputs
- Most popular resistance temperature detectors can be used
- Can easily be retrofitted to existing plant

Note:

SIPLUS extreme products are based on SIMATIC standard products. The contents listed here were taken from the respective standard products. SIPLUS extreme specific information was added.

Technical specifications

Article number	6AG1231-5PD32-4XB0	6AG1231-5PD32-2XB0	6AG1231-5PF32-4XB0	6AG1231-5PF32-2XB0
Based on	6ES7231-5PD32-0XB0 SIPLUS S7-1200 SM 1231 4AI RTD 16Bit	6ES7231-5PD32-0XB0 SIPLUS S7-1200 SM 1231 4AI RTD 16Bit	6ES7231-5PF32-0XB0 SIPLUS S7-1200 SM 1231 8AI RTD 16Bit	6ES7231-5PF32-0XB0 SIPLUS S7-1200 SM 1231 8AI RTD 16Bit
Ambient conditions				
Free fall				
• Fall height, max.	0.3 m; five times, in product package	0.3 m; five times, in product package	0.3 m; five times, in product package	0.3 m; five times, in product package
Ambient temperature during operation				
• min.	-20 °C; = Tmin; Startup @ 0 °C	-40 °C; = Tmin; Startup @ -25 °C	-20 °C; = Tmin; Startup @ 0 °C	-40 °C; = Tmin; Startup @ -25 °C
• max.	60 °C; = Tmax	70 °C; = Tmax	60 °C; = Tmax	70 °C; = Tmax
Extended ambient conditions				
• relative to ambient temperature-atmospheric pressure-installation altitude	Tmin ... Tmax at 1080 hPa ... 795 hPa (-1000 m ... +2000 m) // Tmin ... (Tmax - 10K) at 795 hPa ... 658 hPa (+2000 m ... +3500 m) // Tmin ... (Tmax - 20K) at 658 hPa ... 540 hPa (+3500 m ... +5000 m)	Tmin ... Tmax at 1080 hPa ... 795 hPa (-1000 m ... +2000 m) // Tmin ... (Tmax - 10K) at 795 hPa ... 658 hPa (+2000 m ... +3500 m) // Tmin ... (Tmax - 20K) at 658 hPa ... 540 hPa (+3500 m ... +5000 m)	Tmin ... Tmax at 1080 hPa ... 795 hPa (-1000 m ... +2000 m) // Tmin ... (Tmax - 10K) at 795 hPa ... 658 hPa (+2000 m ... +3500 m) // Tmin ... (Tmax - 20K) at 658 hPa ... 540 hPa (+3500 m ... +5000 m)	Tmin ... Tmax at 1080 hPa ... 795 hPa (-1000 m ... +2000 m) // Tmin ... (Tmax - 10K) at 795 hPa ... 658 hPa (+2000 m ... +3500 m) // Tmin ... (Tmax - 20K) at 658 hPa ... 540 hPa (+3500 m ... +5000 m)
Relative humidity				
- With condensation, tested in accordance with IEC 60068-2-38, max.	100%; RH incl. condensation/frost (no commissioning under condensation conditions)	100%; RH incl. condensation/frost (no commissioning under condensation conditions)	100%; RH incl. condensation/frost (no commissioning under condensation conditions)	100%; RH incl. condensation/frost (no commissioning under condensation conditions)
Resistance				
- against biologically active substances / conformity with EN 60721-3-3	Yes; Class 3B2 mold, fungus and dry rot spores (with the exception of fauna). The supplied connector covers must remain on the unused interfaces during operation!	Yes; Class 3B2 mold, fungus and dry rot spores (with the exception of fauna). The supplied connector covers must remain on the unused interfaces during operation!	Yes; Class 3B2 mold, fungus and dry rot spores (with the exception of fauna). The supplied connector covers must remain on the unused interfaces during operation!	Yes; Class 3B2 mold, fungus and dry rot spores (with the exception of fauna). The supplied connector covers must remain on the unused interfaces during operation!
- against chemically active substances / conformity with EN 60721-3-3	Yes; Class 3C4 (RH < 75%) incl. salt spray according to EN 60068-2-52 (degree of severity 3). The supplied connector covers must remain on the unused interfaces during operation!	Yes; Class 3C4 (RH < 75%) incl. salt spray according to EN 60068-2-52 (degree of severity 3). The supplied connector covers must remain on the unused interfaces during operation!	Yes; Class 3C4 (RH < 75%) incl. salt spray according to EN 60068-2-52 (degree of severity 3). The supplied connector covers must remain on the unused interfaces during operation!	Yes; Class 3C4 (RH < 75%) incl. salt spray according to EN 60068-2-52 (degree of severity 3). The supplied connector covers must remain on the unused interfaces during operation!
- against mechanically active substances / conformity with EN 60721-3-3	Yes; Class 3S4 incl. sand, dust. The supplied connector covers must remain on the unused interfaces during operation!	Yes; Class 3S4 incl. sand, dust. The supplied connector covers must remain on the unused interfaces during operation!	Yes; Class 3S4 incl. sand, dust. The supplied connector covers must remain on the unused interfaces during operation!	Yes; Class 3S4 incl. sand, dust. The supplied connector covers must remain on the unused interfaces during operation!

Ordering data	Article No.	Accessories	Article No.
<p>SIPLUS RTD signal module SM 1231</p> <p>(Extended temperature range and exposure to media)</p> <p>4 inputs for resistance temperature detectors Pt10/50/100/200/500/1000, Ni100/120/200/500/1000, Cu10/50/100, LG-Ni1000; resistance 150/300/600 Ohm, resolution 15 bits + sign</p> <ul style="list-style-type: none"> • For areas with extreme medial exposure (conformal coating); ambient temperature -20 ... +60 °C • For areas with extreme medial exposure (conformal coating); ambient temperature -40 ... +70 °C <p>8 inputs for resistance temperature detectors Pt10/50/100/200/500/1000, Ni100/120/200/500/1000, Cu10/50/100, LG-Ni1000; resistance 150/300/600 Ohm, resolution 15 bits + sign</p> <ul style="list-style-type: none"> • For areas with extreme medial exposure (conformal coating); ambient temperature -20 ... +60 °C • For areas with extreme medial exposure (conformal coating); ambient temperature -40 ... +70 °C 	<p>6AG1231-5PD32-4XB0</p> <p>6AG1231-5PD32-2XB0</p> <p>6AG1231-5PF32-4XB0</p> <p>6AG1231-5PF32-2XB0</p>	<p>Accessories</p>	<p>See SIMATIC S7-1200 RTD signal module SM 1231, page 3/93</p>

SIMATIC S7-1200 Basic Controllers

I/O modules

Special modules

SM 1278 4xIO-Link Master

Overview



- Module for connecting up to 4 IO-Link devices according to IO Link Specification V1.1. The IO-Link parameters are configured using the Port Configuration Tool (PCT), version V3.2 and higher.

Technical specifications

Article number	6ES7278-4BD32-0XB0 S7-1200, SM1278, 4 X IO-LINK MASTER
General information	
Product type designation	SM 1278, IO-Link Master
Supply voltage	
Rated value (DC)	
• 24 V DC	Yes
Power loss	
Power loss, typ.	1 W
Interrupts/diagnostics/ status information	
Diagnostic functions	Yes
Degree and class of protection	
Degree of protection acc. to EN 60529	
• IP20	Yes
Standards, approvals, certificates	
FM approval	Yes
RCM (formerly C-TICK)	Yes
Ambient conditions	
Free fall	
• Fall height, max.	0.3 m; five times, in product package
Ambient temperature during operation	
• permissible temperature range	-20 °C to +60 °C horizontal mounting, -20 °C to 50 °C vertical mounting, 95% humidity, non-condensing
Connection method	
required front connector	Yes
Mechanics/material	
Enclosure material (front)	
• Plastic	Yes
Dimensions	
Width	45 mm
Height	100 mm
Depth	75 mm
Weights	
Weight, approx.	150 g

Ordering data

Article No.

**SM 1278 signal module
4xIO-Link master** **6ES7278-4BD32-0XB0**

For the connection of up to 4 IO-Link devices according to IO Link Specification V1.1

Terminal block (spare part)

With 7 screws, tin-coated; 4 units

6ES7292-1AG30-0XA0

Overview



SIPLUS CMS1200 SM 1281 Condition Monitoring forms part of SIMATIC S7-1200 and is used for the:

- Monitoring of motors, generators, pumps, fans, or other mechanical components
- Recording and analysis of vibrations
- Expansion capability of up to 7 modules

3

Technical specifications

Article number	6AT8007-1AA10-0AA0 SM1281_Condition_Monitoring
General information	
Product brand name	SIPLUS
Product category	Condition Monitoring IEPE
Product designation	CMS1200 SM 1281 Condition Monitoring
Product description	S7-1200 module for the monitoring of vibrations on mechanical components based on parameters and frequency-selective analysis functions
Physical measuring principle	Vibration acceleration
Measurement range vibration frequency, min.	0.1 Hz
Measurement range vibration frequency, max.	10 000 Hz
Installation type/mounting	
Mounting type	Rail or wall mounting
Mounting position	Horizontal, vertical
Recommended mounting position	Horizontal
Supply voltage	
Type of supply voltage	DC
Rated value (DC)	
• 24 V DC	Yes
permissible range, lower limit (DC)	20.4 V
permissible range, upper limit (DC)	28.8 V
Input current	
Current consumption, typ.	200 mA
Current consumption, max.	250 mA
from backplane bus 5 V DC, typ.	80 mA
from backplane bus 5 V DC, max.	85 mA
Memory	
Total memory capacity	1 Gbyte
Hardware configuration	
Design of hardware configuration	Modular, up to 7 modules per CPU

Article number	6AT8007-1AA10-0AA0 SM1281_Condition_Monitoring
Speed input	
Number of speed inputs	1
Protocols	
• 24 V DC digital	Yes
Sensor input	
Number of IEPE sensor inputs	4
Sampling frequency, max.	46 875 Hz
Interfaces	
Type of data transmission	Exporting of raw data as WAV file for further analyses (e.g. using CMS X-Tools) can be downloaded via browser
Ethernet interface	Yes
Protocols	
Bus communication	Yes
Web server	
• HTTP	Yes
Interrupts/diagnostics/status information	
Alarms	
• Diagnostic alarm	Yes
Diagnostics indication LED	
• Status indicator digital input (green)	No
• for status of the inputs	Yes
• for maintenance	Yes
Integrated Functions	
Monitoring functions	
• Monitoring of the sensor inputs	Yes; Cable break and short-circuit
• Vibration characteristic monitoring via RMS value of the vibration speed	Yes
• Vibration characteristic monitoring via RMS value of the vibration acceleration	Yes
• Frequency-selective monitoring via vibration speed spectrum	Yes
• Frequency-selective monitoring via vibration acceleration spectrum	Yes
• Frequency-selective monitoring via envelope curve analysis	Yes

SIMATIC S7-1200 Basic Controllers

I/O modules

Special modules

SIPLUS CMS1200 SM 1281 Condition Monitoring

Technical specifications (continued)

Article number	6AT8007-1AA10-0AA0 SM1281_Condition_Monitoring
Degree and class of protection	
Degree of protection acc. to EN 60529	
• IP20	Yes
Standards, approvals, certificates	
Certificate of suitability	CE
CE mark	Yes
UL approval	Yes
EAC (formerly Gost-R)	Yes
China RoHS compliance	Yes
Device tag according to DIN EN 81346-2	P
Ambient conditions	
Free fall	
• Fall height, max.	0.3 m; five times, in product package
Ambient temperature during operation	
• horizontal installation, min.	-20 °C
• horizontal installation, max.	60 °C
• vertical installation, min.	-20 °C
• vertical installation, max.	45 °C
Ambient temperature during storage/transportation	
• min.	-40 °C
• max.	70 °C
Air pressure acc. to IEC 60068-2-13	
• Operation, min.	795 hPa
• Operation, max.	1 080 hPa
• Storage/transport, min.	660 hPa
• Storage/transport, max.	1 080 hPa
Relative humidity	
• Operation without condensation, min.	5%
• Operation without condensation, max.	95%
Software	
Browser software required	Web browser Mozilla Firefox (ESR31) or Microsoft Internet Explorer (10/11)
Connection method	
required front connector	Yes
Design of electrical connection	Screw connection
Mechanics/material	
Material of housing	Plastic: polycarbonate, abbreviation: PC- GF 10 FR
Enclosure material (front)	
• Plastic	Yes
Dimensions	
Width	70 mm
Height	112 mm
Depth	75 mm
Weights	
Weight	260 g

Ordering data

SIPLUS CMS1200 SM 1281 Condition Monitoring

Module for SIMATIC S7-1200 for monitoring vibrations in mechanical components based on characteristic values and frequency-selective analysis functions.

Article No.

6AT8007-1AA10-0AA0

Overview

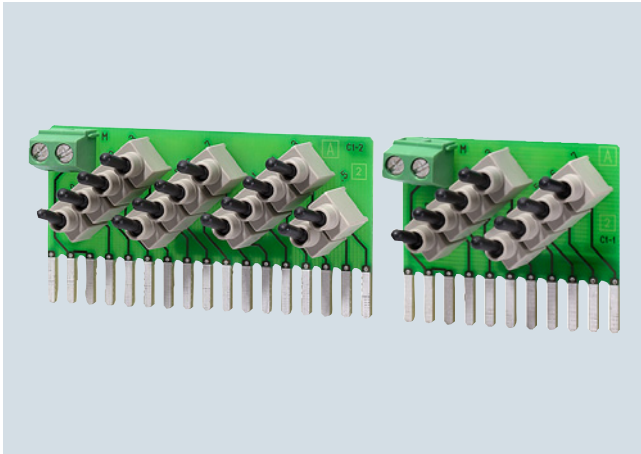

- Simulator module for program testing during commissioning and ongoing operation
- Simulation of 8 or 14 inputs

Technical specifications

Article number	6ES7274-1XF30-0XA0	6ES7274-1XH30-0XA0
	S7-1200 SIMULATOR MODULE SIM1274, 8 INP	S7-1200 SIMULATOR MODULE SIM1274, 14 INP
General information		
Product type designation	SIM 1274 8Ch DI Simulator	SIM 1274 14Ch DI Simulator
Supply voltage		
Rated value (DC)	24 V	24 V
Digital inputs		
Number of digital inputs	8	14
Digital outputs		
Number of digital outputs	0	0
Degree and class of protection		
Degree of protection acc. to EN 60529		
• IP20	Yes	Yes
Dimensions		
Width	43 mm	67 mm
Height	35 mm	35 mm
Depth	23 mm	23 mm

Ordering data

Article No.

Digital input simulator SIM 1274 simulator module	
With 8 input switches, for CPU 1211C/1212C	6ES7274-1XF30-0XA0
With 14 input switches, for CPU 1214C/1215C	6ES7274-1XH30-0XA0
With 14 input switches, for CPU 1217C	6ES7274-1XK30-0XA0
Analog input simulator SIM 1274 simulator module	
2 potentiometers	6ES7274-1XA30-0XA0

SIMATIC S7-1200 Basic Controllers

I/O modules

Special modules

Battery Board BB 1297

Overview

- Battery board for extending the power reserve for the S7-1200 real-time clock

Technical specifications

Article number	6ES7297-0AX30-0XA0 BATTERY BOARD BB 1297 F. CPU 12XX
General information	
Product type designation	BB 1297 battery board
Interrupts/diagnostics/ status information	
Alarms	Yes
Diagnostic functions	Yes
Diagnostics indication LED	
• for maintenance	Yes; The maintenance LED (MAINT) of the PLC signals that the battery needs to be replaced.
Degree and class of protection	
Degree of protection acc. to EN 60529	
• IP20	Yes
Standards, approvals, certificates	
CE mark	Yes
CSA approval	Yes
FM approval	Yes
RCM (formerly C-TICK)	Yes
Marine approval	
• Marine approval	Yes
Ambient conditions	
Free fall	
• Fall height, max.	0.3 m; five times, in product package
Ambient temperature during operation	
• min.	-20 °C
• max.	60 °C
Ambient temperature during storage/transportation	
• min.	-40 °C
• max.	70 °C
Air pressure acc. to IEC 60068-2-13	
• Operation, min.	795 hPa
• Operation, max.	1 080 hPa
• Storage/transport, min.	660 hPa
• Storage/transport, max.	1 080 hPa
Relative humidity	
• permissible range (without condensation) at 25 °C	95%
Mechanics/material	
Enclosure material (front)	
• Plastic	Yes
Dimensions	
Width	38 mm
Height	62 mm
Depth	21 mm
Weights	
Weight, approx.	40 g

Ordering data

Article No.

BB 1297 battery board

For long-term backup of real-time clock; can be plugged into the signal board slot of an S7-1200 CPU in FW version 3.0 or higher; battery (CR 1025) is not included

6ES7297-0AX30-0XA0

Terminal block (spare part)

For signal board
With 6 screws, gold-plated; 4 units

6ES7292-1BF30-0XA0

Overview



SIWAREX WP231 is a versatile, legal for trade weighing module for all simple weighing and force measuring tasks. The compact module is easy to install in the SIMATIC S7-1200 automation system. It can also be operated without a SIMATIC CPU.

Technical specifications

SIWAREX WP231	
Integration in automation systems	
S7-1200	SIMATIC S7-1200 system bus
Operator panel and/or automation systems from other vendors	Via Ethernet (Modbus TCP/IP) or RS 485 (Modbus RTU)
Communication interfaces	
	<ul style="list-style-type: none"> • SIMATIC S7-1200 backplane bus • RS 485 (Modbus RTU, Siebert remote display) • Ethernet (SIWATOOL V7, Modbus TCP/IP) • Analog output 0/4 - 20 mA • 4 x digital outputs, 24 V DC floating, short-circuit proof • 4 x digital outputs, 24 V DC, floating
Commissioning options	
	<ul style="list-style-type: none"> • Using SIWATOOL V7 • Using function block in SIMATIC S7-1200 CPU / Touch Panel • Using Modbus TCP/IP • Using Modbus RTU
Measuring accuracy	
EU type approval as non-automatic weighing instrument, trade class III	$3000 d \geq 0.5 \mu\text{V/e}$
Error limit according to DIN 1319-1 of full-scale value at $20^\circ\text{C} \pm 10\text{K}$ ($68^\circ\text{F} \pm 10\text{K}$)	0.05%
Internal resolution	up to ± 4 million parts
Measuring frequency	100 / 120 Hz
Digital filter	
	Variable adjustable low-pass and average filter
Typical applications	
	<ul style="list-style-type: none"> • Non-automatic weighing instruments • Force measurements • Fill-level monitoring • Belt tension monitors
Weighing functions	
Weight values	<ul style="list-style-type: none"> • Gross • Net • Tare
Limit values	<ul style="list-style-type: none"> • 2 x min/max • Empty
Zeroing	Per command
Tare	Per command
Tare specification	Per command
Load cells	
	Full-bridge strain gauges in 4-wire or 6-wire system

SIWAREX WP231	
Load cell powering	
Supply voltage (regulated via feedback)	4.85 V DC
Permissible load resistance	
• R_{Lmin}	$> 40 \Omega$
• R_{Lmax}	$< 4\ 100 \Omega$
With SIWAREX IS Ex interface	
• R_{Lmin}	$> 50 \Omega$
• R_{Lmax}	$< 4\ 100 \Omega$
Load cell characteristic	1 ... 4 mV/V
Permissible range of the measurement signal (with 4 mV/V sensors)	-21.3 ... +21.3 mV
Max. distance of load cells	500 m (229.66 ft)
Connection to load cells in Ex zone 1	Optionally via SIWAREX IS Ex interface (compatibility of the load cells must be checked)
Approvals/certificates	
	<ul style="list-style-type: none"> • ATEX Zone 2 • UL • EAC • KCC • RCM • OIML R76 • Design approval 2009/23/EC (NAWI)
Calibration approval	EU type approval OIML R76
Auxiliary power supply	
Rated voltage	24 V DC
Max. power consumption	200 mA
Max. power consumption SIMATIC Bus	3 mA
IP degree of protection according to DIN EN 60529; IEC 60529	IP20
Climatic requirements	
$T_{min} (IND) \dots T_{max} (IND)$ (operating temperature)	
• Vertical installation	-10 ... +40 °C (14 ... 104 °F)
• Horizontal installation	-10 ... +55 °C (14 ... 131 °F)
EMC requirements	
	according to EN 45501
Dimensions	
	70 x 75 x 100 mm (2.76 x 2.95 x 3.94 in)

SIMATIC S7-1200 Basic Controllers

I/O modules

Special modules

SIWAREX WP231

Ordering data	Article No.	Article No.	
SIWAREX WP231 weighing module Single-channel, legal-for-trade, for NAWI non-automatic weighing instruments (e.g. platform or hopper scales) with analog load cells / full-bridge strain gauges (1 - 4 mV/V), 1 x LC, 4 x DQ, 4 x DI, 1 x AQ, 1 x RS 485, Ethernet port.	7MH4960-2AA01	Ethernet cable patch cord 2 m (7 ft) For connecting SIWAREX WP231 to a PC (SIWATOOL), SIMATIC CPU, panel, etc.	6XV1850-2GH20
SIWAREX S7-1200 device manual Available in a range of languages Free download from the Internet at: http://www.siemens.com/weighing-technology		Remote display (optional) The digital remote displays can be connected directly to the SIWAREX WP231 via the RS 485 interface. Suitable remote display: S102 Siebert Industrieelektronik GmbH Postfach 1180 D-66565 Eppelborn, Germany Tel.: +49 6806/980-0 Fax: +49 6806/980-999 Internet: http://www.siebert.de Detailed information is available from the manufacturer.	
SIWAREX WP231 "Ready for Use" Complete software package for non-automatic weighing instrument (for S7-1200 and a directly connected operator panel). Free download from the Internet at: http://www.siemens.com/weighing-technology		Accessories	
SIWAREX WP231 "Ready for Use - legal-for-trade" Software package for legal for trade non-automatic weighing instruments for S7-1200. Free download from the Internet at: http://www.siemens.com/weighing-technology		SIWAREX JB junction box, aluminum housing For connecting up to 4 load cells in parallel, and for connecting several junction boxes	7MH4710-1BA
Software SecureDisplay Software for a legal trade display on Windows CE-based Panel. SIMATIC Basic and Key Panels are excluded. Free download from the Internet at: http://www.siemens.com/weighing-technology		SIWAREX JB junction box, stainless steel housing For connecting up to 4 load cells in parallel.	7MH4710-1EA
Configuration package SIWAREX WP231 for TIA Portal <ul style="list-style-type: none"> • "Ready for use" software for operating a scale with SIWAREX WP231 and a touch panel (in a variety of languages) • SIWATOOL V7.0 • Device manuals (PDF files in a variety of languages) 	7MH4960-2AK01	SIWAREX JB junction box, stainless steel housing (ATEX) For connecting up to 4 load cells in parallel. (For zone allocation, see manual or type examination certificate).	7MH4710-1EA01
Calibration set for SIWAREX WP2xx For verification of up to 3 scales comprising: <ul style="list-style-type: none"> • 3 x inscription foil for labeling • 1 x protection foil • Guidelines for verification, certificates and approvals, adaptable label, SIWAREX WP 	7MH4960-0AY10	Ex interface SIWAREX IS For intrinsically-safe connection of load cells. With ATEX approval (not UL/FM). Suitable for SIWAREX electronic weighing system. Compatibility of load cells must be checked. <ul style="list-style-type: none"> • Short-circuit current < 199 mA DC • Short-circuit current < 137 mA DC 	7MH4710-5BA 7MH4710-5CA

3

Ordering data	Article No.		Article No.
<p>Cable (optional)</p> <p>Cable Li2Y 1 x 2 x 0.75 ST + 2 x (2 x 0.34 ST) – CY</p> <p>For connecting SIWAREX electronic weighing systems to junction box (JB), extension box (EB) and Ex interface or between two JB's. For permanent installation. Occasional bending is possible.</p> <p>External diameter: approx. 10.8 mm (0.43 in)</p> <p>Permissible ambient temperature -40 ... +80 °C (-40 ... +176 °F).</p> <p>Sold by the meter.</p> <ul style="list-style-type: none"> • Sheath color: orange • For potentially explosive atmospheres. Sheath color: blue 	<p>7MH4702-8AG 7MH4702-8AF</p>	<p>Ground terminal for connecting the load cell cable shield to the grounded DIN rail</p>	<p>6ES5728-8MA11</p>

SIMATIC S7-1200 Basic Controllers

I/O modules

Special modules

SIWAREX WP241

Overview



SIWAREX WP241

SIWAREX WP241 is a flexible weighing module for belt scales. The compact module is easy to install in the SIMATIC S7-1200 automation system. It can also be operated as a stand-alone module, i.e. without a SIMATIC CPU.

Technical specifications

SIWAREX WP241	
Integration in automation systems	
S7-1200	SIMATIC S7-1200 system bus
Operator panel and/or automation systems from other vendors	Via Ethernet (Modbus TCP/IP) or RS 485 (Modbus RTU)
Communication interfaces	<ul style="list-style-type: none"> • SIMATIC S7-1200 backplane bus • RS 485 (Modbus RTU) • Ethernet (SIWATOOL V7, Modbus TCP/IP) • Analog output 0/4 - 20 mA • 4 x digital outputs, 24 V DC floating, short-circuit proof • 4 x digital outputs, 24 V DC, floating
Commissioning options	<ul style="list-style-type: none"> • Using SIWATOOL V7 • Using function block in SIMATIC S7-1200 CPU / Touch Panel • Using Modbus TCP/IP • Using Modbus RTU
Measuring accuracy	
Error limit according to DIN 1319-1 of full-scale value at 20 °C ± 10 K (68 °F ± 10 K)	0.05%
Internal resolution	up to ±4 million parts
Measuring frequency	100 / 120 Hz
Digital filter	Separate, variable adjustable low-pass and average filter for loading and speed
Filter for conveyor load	Low-pass filter (limit frequency 0.05 ... 50 Hz)
Filter for belt speed	Low-pass filter (limit frequency 0.05 ... 50 Hz)
Weighing functions	
Readout data	<ul style="list-style-type: none"> • Weight • Belt load • Material flow rate • Accumulated total • Main total • Free totals 1 ... 4 • Belt speed
Limits (min/max)	<ul style="list-style-type: none"> • Belt load • Material flow rate • Belt speed

SIWAREX WP241	
Load cells	Full-bridge strain gauges in 4-wire or 6-wire system
Load cell excitation	
Supply voltage (regulated via feedback)	4.85 V DC
Permissible load resistance	
• R_{Lmin}	> 40 Ω
• R_{Lmax}	< 4100 Ω
With SIWAREX IS Ex interface	
• R_{Lmin}	> 50 Ω
• R_{Lmax}	< 4100 Ω
Load cell characteristic	1 ... 4 mV/V
Permissible measurement signal range	-21.3 ... +21.3 mV
Max. distance of load cells	500 m (229.66 ft)
Connection to load cells in Ex zone 1	Optionally via SIWAREX IS Ex interface (compatibility of the load cells must be checked)
Approvals/certificates	<ul style="list-style-type: none"> • ATEX Zone 2 • UL • EAC • KCC • RCM
Calibration approvals	<ul style="list-style-type: none"> • EU-type examination certificate 2014/31/EU (NAWI) acc. to OIML R76 • EU-type examination certificates 2014/32/EU (MID) acc. to OIML R61 and OIML R51
Auxiliary power supply	
Rated voltage	24 V DC
Max. power consumption	200 mA
Max. power consumption SIMATIC Bus	3 mA
IP degree of protection to DIN EN 60529; IEC 60529	IP20
Climatic requirements	
T_{min} (IND) ... T_{max} (IND) (operating temperature)	
• Vertical installation	-10 ... +40 °C (14 ... 104 °F)
• Horizontal installation	-10 ... +55 °C (14 ... 131 °F)
EMC requirements	according to EN 45501
Dimensions	70 x 75 x 100 mm (2.76 x 2.95 x 3.94 in)

Ordering data	Article No.	Ordering data	Article No.
SIWAREX WP241 weighing module Single-channel, for conveyor scales with analog load cells / full-bridge strain gauges (1 - 4 mV/V), 1 x LC, 4 x DQ, 4 x DI, 1 x AQ, 1 x RS 485, Ethernet port.	7MH4960-4AA01	Accessories SIWAREX JB junction box, aluminum housing For connecting up to 4 load cells in parallel, and for connecting several junction boxes	7MH4710-1BA
SIWAREX S7-1200 device manual Available in a range of languages Free-of-charge download from the Internet at: http://www.siemens.com/weighing-technology		SIWAREX JB junction box, stainless steel housing For connecting up to 4 load cells in parallel.	7MH4710-1EA
SIWAREX WP241 "Ready for Use" Complete software package for belt scales (for S7-1200 and a directly connected operator panel) Free download on the Internet at: http://www.siemens.com/weighing-technology		SIWAREX JB junction box, stainless steel housing (ATEX) For parallel connection of up to 4 load cells (for zone allocation, see manual or type examination certificate).	7MH4710-1EA01
SIWAREX WP241 configuration package for TIA Portal <ul style="list-style-type: none"> • "Ready for Use" software for operating a scale with SIWAREX WP241 and a touch panel (in a variety of languages) • SIWATOOL V7.0 • Device manuals (PDF files in a variety of languages) 	7MH4960-4AK01	Ex interface SIWAREX IS For intrinsically-safe connection of load cells. With ATEX approval (not UL/FM). Suitable for SIWAREX electronic weighing system. Compatibility of load cells must be checked. <ul style="list-style-type: none"> • Short-circuit current < 199 mA DC • Short-circuit current < 137 mA DC 	7MH4710-5BA 7MH4710-5CA
Ethernet cable patch cord 2 m (7 ft) For connecting SIWAREX WP241 to a PC (SIWATOOL), SIMATIC CPU, panel, etc.	6XV1850-2GH20	Cable (optional) Cable Li2Y 1 x 2 x 0.75 ST + 2 x (2 x 0.34 ST) – CY For connecting SIWAREX electronic weighing systems to junction box (JB), extension box (EB) and Ex interface or between two JB's. For permanent installation. Occasional bending is possible. External diameter: approx. 10.8 mm (0.43 inch) Permissible ambient temperature -40 ... +80 °C (-40 ... +176 °F). Sold by the meter. <ul style="list-style-type: none"> • Sheath color: orange • For potentially explosive atmospheres. Sheath color: blue 	7MH4702-8AG 7MH4702-8AF
		Ground terminal for connecting the load cell cable shield to the grounded DIN rail	6ES5728-8MA11

SIMATIC S7-1200 Basic Controllers

I/O modules

Special modules

SIWAREX WP251

Overview



SIWAREX WP251 electronic weighing module

SIWAREX WP251 is a flexible weighing module for dosing and filling processes. The compact module can be installed seamlessly in the SIMATIC S7-1200 automation system. It can also be used without a SIMATIC CPU in stand-alone mode.

Technical specifications

SIWAREX WP251	
Weighing modes	<ul style="list-style-type: none"> • Non-automatic scales (filling + removal) (in accordance with OIML R-76) • Automatic scales for single weighing (filling + removal) (in accordance with OIML R-51) • Automatic scales for batching (in accordance with OIML R-61)
Integration in automation systems	
S7-1200	SIMATIC S7-1200 system bus
Operator panel and/or automation systems from other vendors	Via Ethernet (Modbus TCP/IP) or RS 485 (Modbus RTU)
Ports	<ul style="list-style-type: none"> • 1 x SIMATIC S7-1200 system bus • 1 x Ethernet (SIWATOOL and Modbus TCP/IP) • 1 x RS 485 (Modbus RTU or remote display) • 1 x analog output (0/4 ... 20 mA) • 4 x digital inputs (24 V DC, floating) • 4 x digital outputs (24 V DC, floating, short-circuit proof)
Functions	<ul style="list-style-type: none"> • 3 limits • Tare • Tare specification • Set to zero • Zero adjustment • Statistics • Automatic correction of the shut-off points • Internal protocol memory for 550 000 entries • Trace function for signal analysis • Internal restore point • Stand-alone mode or SIMATIC S7-1200 integrated

SIWAREX WP251	
Parameter assignment	<ul style="list-style-type: none"> • Full access using function block in SIMATIC S7-1200 • Full access using Modbus TCP/IP • Full access using Modbus RTU
Remote display	
Connection	via RS 485
Setting the scales	PC software SIWATOOL (Ethernet), S7-1200 function block and touch panel or directly connected operator panel (Modbus)
Measuring accuracy	
Error limit according to DIN 1319-1 of full-scale value at 20 °C ± 10 K (68 °F ± 10 K)	0.05%
Internal resolution	Up to ±4 million parts
Number of measurements/second	100 or 120 (selectable)
Filter	<ul style="list-style-type: none"> • Low-pass filter 0.1 ... 50 Hz • Average value filter
Load cells	Full-bridge strain gauges in 4-wire or 6-wire system
Load cell powering	
Supply voltage (regulated via feedback)	4.85 V DC
Permissible load resistance	
• R_{Lmin}	> 40 Ω
• R_{Lmax}	< 4 100 Ω
With SIWAREX IS Ex interface	
• R_{Lmin}	> 50 Ω
• R_{Lmax}	< 4 100 Ω
Load cell characteristic	1 ... 4 mV/V
Permissible range of the measurement signal (with 4 mV/V sensors)	-21.3 ... +21.3 mV
Max. distance of load cells	500 m (229.66 ft)
Connection to load cells in Ex zone 1	Optionally via SIWAREX IS Ex interface
Certificates	<ul style="list-style-type: none"> • ATEX Zone 2 • UL • KCC • EAC • RCM
Auxiliary power supply	
Rated voltage	24 V DC
Max. power consumption	200 mA
Max. power consumption SIMATIC Bus	3 mA
IP degree of protection according to DIN EN 60529; IEC 60529	IP20
Climatic requirements	
$T_{min(IND)}$... $T_{max(IND)}$ (operating temperature)	
• Vertical installation	-10 ... +40 °C (14 ... 104 °F)
• Horizontal installation	-10 ... +55 °C (14 ... 131 °F)
EMC requirements	according to EN 45501
Dimensions	70 x 75 x 100 mm (2.76 x 2.95 x 3.94 in)

Ordering data	Article No.	Ordering data	Article No.
SIWAREX WP251 weighing module Single-channel, legal-for-trade, for automatic dosing and batching scales (GFI, ACI, NAWI) with analog load cells / full-bridge strain gauges (1 - 4 mV/V), 1 x LC, 4 x DQ, 4 x DI, 1 x AQ, 1 x RS 485, Ethernet port.	7MH4960-6AA01	Accessories SIWAREX JB junction box, aluminum housing For connecting up to 4 load cells in parallel, and for connecting several junction boxes	7MH4710-1BA
SIWAREX WP251 device manual Available in a range of languages Free download from the Internet at: http://www.siemens.com/weighing-technology		SIWAREX JB junction box, stainless steel housing For connecting up to 4 load cells in parallel	7MH4710-1EA
SIWAREX WP251 "Ready for Use" Free download from the Internet at: http://www.siemens.com/weighing-technology		SIWAREX JB junction box, stainless steel housing (ATEX) For parallel connection of up to 4 load cells (for zone allocation, see manual or type examination certificate).	7MH4710-1EA01
Configuration package SIWAREX WP251 on CD-ROM for TIA Portal V12 <ul style="list-style-type: none"> • "Ready for use" software for operating a scale with SIWAREX WP251 and a touch panel (in a variety of languages) • SIWATOOL V7.0 • Device manuals (PDF files in a variety of languages) 	7MH4960-6AK01	Ex interface SIWAREX IS For intrinsically-safe connection of load cells. With ATEX approval (not UL/FM). Suitable for SIWAREX electronic weighing system. Compatibility of load cells must be checked.	
		<ul style="list-style-type: none"> • Short-circuit current < 199 mA DC • Short-circuit current < 137 mA DC 	7MH4710-5BA 7MH4710-5CA
Calibration set for SIWAREX WP2xx For verification of up to 3 scales comprising: <ul style="list-style-type: none"> • 3 x inscription foil for labeling • 1 x protection foil • 10 x EU verification marks (black M on green background) • Guidelines for verification, certificates and approvals, adaptable label, SIWAREX WP 	7MH4960-0AY10	Cable (optional) Cable Li2Y 1 x 2 x 0.75 ST + 2 x (2 x 0.34 ST) – CY For connecting SIWAREX electronic weighing systems to junction box (JB), extension box (EB) and Ex interface or between two JB's. For permanent installation. Occasional bending is possible. External diameter: approx. 10.8 mm (0.43 in) Permissible ambient temperature -40 ... +80 °C (-40 ... +176 °F). Sold by the meter.	
Ethernet cable patch cord 2 m (7 ft) For connecting SIWAREX WP251 to a PC (SIWATOOL), SIMATIC CPU, panel, etc.	6XV1850-2GH20	<ul style="list-style-type: none"> • Sheath color: orange • For potentially explosive atmospheres. Sheath color: blue 	7MH4702-8AG 7MH4702-8AF
Remote display (optional) The digital remote displays can be connected directly to the SIWAREX WP251 via the RS 485 interface. Suitable remote display: S102 Siebert Industrieelektronik GmbH Postfach 1180 D-66565 Eppelborn, Germany Tel.: +49 6806/980-0 Fax: +49 6806/980-999 Internet: http://www.siebert.de Detailed information is available from the manufacturer.		Ground terminal for connecting the load cell cable shield to the grounded DIN rail	6ES5728-8MA11

SIMATIC S7-1200 Basic Controllers

I/O modules

Communication

CM 1241 communication modules

Overview

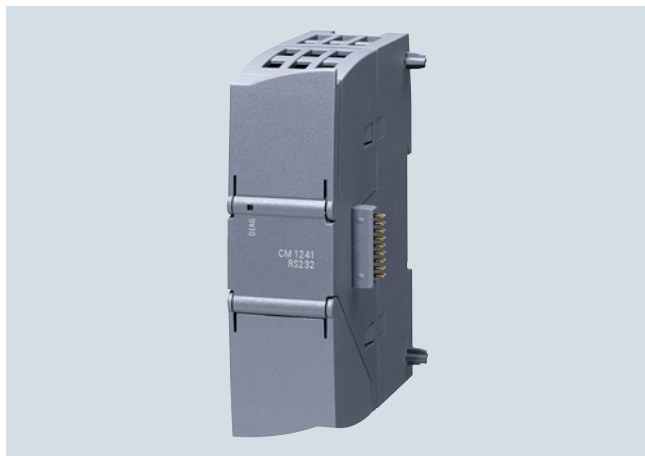

- For quick, high-performance serial data exchange via point-to-point connection
- Implemented protocols: ASCII, USS drive protocol, Modbus RTU, 3964(R)
- Additional protocols can also be loaded
- Simple parameterization with STEP 7 Basic

Technical specifications

Article number	6ES7241-1CH32-0XB0	6ES7241-1AH32-0XB0
	COMMUNICATION MODULE CM 1241, RS 422/485	COMMUNICATION MODULE CM 1241, RS 232
General information		
Product type designation	CM 1241 RS 422/485	CM 1241 RS 232
Supply voltage		
Rated value (DC)		
• 24 V DC	Yes	Yes
Input current		
Current consumption, max.	220 mA; From backplane bus 5 V DC	200 mA; From backplane bus 5 V DC
Power loss		
Power loss, typ.	1.1 W	1.1 W
Interfaces		
Number of interfaces	1	1
Interface physics, RS 232C (V.24)		Yes
Interface (physical) RS 422/485 (X.27)	Yes	
Point-to-point		
• Cable length, max.	1 000 m	10 m
Integrated protocol driver		
- Freeport	Yes	Yes
- ASCII	Yes; Available as library function	Yes; Available as library function
- Modbus	Yes	Yes
- Modbus RTU master	Yes	Yes
- MODBUS RTU slave	Yes	Yes
- USS	Yes; Available as library function	
Protocols		
Integrated protocols		
Freeport		
- Telegram length, max.	1 kbyte	1 kbyte
- Bits per character	7 or 8	7 or 8
- Number of stop bits	1 (Standard), 2	1 (Standard), 2
- Parity	No parity (standard); even, uneven, mark (parity bit always 1); space (parity bit always 0)	No parity (standard); even, uneven, mark (parity bit always 1); space (parity bit always 0)
3964 (R)		
- Telegram length, max.	1 kbyte	1 kbyte
- Bits per character	7 or 8	7 or 8
- Number of stop bits	1 (Standard), 2	1 (Standard), 2
- Parity	No parity (standard); even, uneven, mark (parity bit always 1); space (parity bit always 0)	No parity (standard); even, uneven, mark (parity bit always 1); space (parity bit always 0)

Technical specifications (continued)

Article number	6ES7241-1CH32-0XB0 COMMUNICATION MODULE CM 1241, RS 422/485	6ES7241-1AH32-0XB0 COMMUNICATION MODULE CM 1241, RS 232
Modbus RTU master		
- Address area	1 through 49 999 (Standard Modbus addressing)	1 through 49 999 (Standard Modbus addressing)
- Number of slaves, max.	247; slave numbers 1 through 247, per MODBUS network segment maximum 32 devices, additional repeaters needed to expand the network to maximum configuration	247; slave numbers 1 through 247, per MODBUS network segment maximum 32 devices, additional repeaters needed to expand the network to maximum configuration
MODBUS RTU slave		
- Address area	1 through 49 999 (Standard Modbus addressing)	1 through 49 999 (Standard Modbus addressing)
Interrupts/diagnostics/status information		
Diagnostic functions	Yes	Yes
Diagnostics indication LED		
• for status of the outputs	Yes	Yes
Degree and class of protection		
Degree of protection acc. to EN 60529		
• IP20	Yes	Yes
Standards, approvals, certificates		
CE mark	Yes	Yes
cULus	Yes	Yes
FM approval	Yes	Yes
RCM (formerly C-TICK)	Yes	Yes
KC approval	Yes	Yes
Ambient conditions		
Free fall		
• Fall height, max.	0.3 m; five times, in product package	0.3 m; five times, in product package
Ambient temperature during operation		
• permissible temperature range	-20 °C to +60 °C horizontal mounting, -20 °C to 50 °C vertical mounting, 95% humidity, non-condensing	-20 °C to +60 °C horizontal mounting, -20 °C to 50 °C vertical mounting, 95% humidity, non-condensing
Dimensions		
Width	30 mm	30 mm
Height	100 mm	100 mm
Depth	75 mm	75 mm
Weights		
Weight, approx.	155 g	150 g

Ordering data**CM 1241 communication module**

Communication module for point-to-point connection, with one RS 422/485 interface

Article No.**6ES7241-1CH32-0XB0**

Communication module for point-to-point connection, with one RS 232 interface

6ES7241-1AH32-0XB0**Article No.****Accessories****Front flap set (spare part)**

For communication modules

6ES7291-1CC30-0XA0

SIMATIC S7-1200 Basic Controllers

I/O modules

Communication

CB 1241 RS 485 communication boards

Overview

- For fast, high-performance serial data exchange via point-to-point connection
- Implemented protocols: ASCII, USS drive protocol, Modbus RTU
- Additional protocols can be loaded later
- Simple parameterization with STEP 7 Basic
- Can be plugged directly into the CPU

Technical specifications

Article number	6ES7241-1CH30-1XB0 COMMUNICATION BOARD CB 1241, RS 485
General information	
Product type designation	CB 1241 RS 485
Input current	
from backplane bus 5 V DC, typ.	50 mA
Power loss	
Power loss, typ.	1.5 W
Interfaces	
Point-to-point	
• Cable length, max.	1 000 m
Integrated protocol driver	
- Freeport	Yes
- ASCII	Yes; Available as library function
- Modbus	Yes
- Modbus RTU master	Yes
- MODBUS RTU slave	Yes
- USS	Yes; Available as library function
Protocols	
Integrated protocols	
Freeport	
- Telegram length, max.	1 kbyte
- Bits per character	7 or 8
- Number of stop bits	1 (Standard), 2
- Parity	No parity (standard); even, uneven, mark (parity bit always 1); space (parity bit always 0)
3964 (R)	
- Telegram length, max.	1 kbyte
- Bits per character	7 or 8
- Number of stop bits	1 (Standard), 2
- Parity	No parity (standard); even, uneven, mark (parity bit always 1); space (parity bit always 0)
Modbus RTU master	
- Address area	1 through 49 999 (Standard Modbus addressing)
- Number of slaves, max.	247; slave numbers 1 through 247, per MODBUS network segment maximum 32 devices, additional repeaters needed to expand the network to maximum configuration
MODBUS RTU slave	
- Address area	1 through 49 999 (Standard Modbus addressing)

Article number	6ES7241-1CH30-1XB0 COMMUNICATION BOARD CB 1241, RS 485
Interrupts/diagnostics/ status information	
Diagnostic functions	Yes
Degree and class of protection	
Degree of protection acc. to EN 60529	
• IP20	Yes
Standards, approvals, certificates	
CE mark	Yes
cULus	Yes
FM approval	Yes
RCM (formerly C-TICK)	Yes
KC approval	Yes
Ambient conditions	
Free fall	
• Fall height, max.	0.3 m; five times, in product package
Ambient temperature during operation	
• permissible temperature range	-20 °C to +60 °C horizontal mounting, -20 °C to 50 °C vertical mounting, 95% humidity, non- condensing
Mechanics/material	
Enclosure material (front)	
• Plastic	Yes
Dimensions	
Width	38 mm
Height	62 mm
Depth	21 mm
Weights	
Weight, approx.	40 g

Ordering data

CB 1241 RS 485 communication board

For point-to-point connection,
with 1 RS 485 interface

Article No.

6ES7241-1CH30-1XB0

Article No.

Accessories

Terminal block (spare part)

For signal board
With 6 screws, gold-plated; 4 pcs.**6ES7292-1BF30-0XA0**

Overview



DP-M	DP-S	FMS	PG/OP	S7
	●			

The CM 1242-5 communication module is used to connect a SIMATIC S7-1200 to PROFIBUS as a DP slave and has the following characteristics:

- PROFIBUS DPV1 slave in accordance with IEC 61158
- Module replacement without PG supported
- Power is supplied via the backplane bus so that no extra cabling is required
- Support of all standard baud rates from 9.6 Kbit/s to 12 Mbit/s
- Compact industry-standard enclosure in S7-1200 design for mounting on a standard mounting rail
- Fast commissioning thanks to easy configuration using STEP 7 without additional programming overhead

The CM 1242-5 is intended for use in factory automation. Low-cost PROFIBUS-based automation solutions can be created on the basis of the S7-1200 for optimal production.

Technical specifications

Article number	6GK7242-5DX30-0XE0
Product type designation	CM 1242-5
Transmission rate	
Transfer rate	
• at the 1st interface acc. to PROFIBUS	9.6 kbit/s ... 12 Mbit/s
Interfaces	
Number of interfaces acc. to Industrial Ethernet	0
Number of electrical connections	
• at the 1st interface acc. to PROFIBUS	1
• for power supply	0
Type of electrical connection	
• at the 1st interface acc. to PROFIBUS	9-pin Sub-D socket (RS 485)
Supply voltage, current consumption, power loss	
Type of voltage of the supply voltage	DC
Supply voltage 1 from backplane bus	5 V
Consumed current	
• from backplane bus at DC at 5 V typical	0.15 A
Power loss [W]	0.75 W

Article number	6GK7242-5DX30-0XE0
Product type designation	CM 1242-5
Permitted ambient conditions	
Ambient temperature	
• for vertical installation during operation	0 ... 45 °C
• for horizontally arranged busbars during operation	0 ... 55 °C
• during storage	-40 ... +70 °C
• during transport	-40 ... +70 °C
Relative humidity at 25 °C without condensation during operation maximum	95 %
Protection class IP	IP20
Design, dimensions and weight	
Module format	Compact module S7-1200 single width
Width	30 mm
Height	100 mm
Depth	75 mm
Net weight	0.115 kg
Mounting type	
• 35 mm DIN rail mounting	Yes
• S7-300 rail mounting	No
• wall mounting	Yes

SIMATIC S7-1200 Basic Controllers

I/O modules

Communication

CM 1242-5**Technical specifications** (continued)

Article number	6GK7242-5DX30-0XE0
Product type designation	CM 1242-5
Product properties, functions, components general	
Number of units	
• per CPU maximum	3
Performance data PROFIBUS DP	
Service as DP slave	
• DPV0	Yes
• DPV1	Yes
Amount of data	
• of the address area of the inputs as DP slave total	240 byte
• of the address area of the outputs as DP slave total	240 byte
Performance data telecontrol	
Protocol is supported	
• TCP/IP	No
Configuration software	
• required	STEP 7 Basic/Professional V11 (TIA Portal) or higher

Ordering data**Article No.****CM 1242-5 communication module**

Communication module for electrical connection of SIMATIC S7-1200 to PROFIBUS as a DP slave module

6GK7242-5DX30-0XE0**Accessories****PROFIBUS FastConnect connection plug RS 485**

With 90° cable outlet; insulation displacement technology, max. transmission rate 12 Mbit/s

- Without PG interface
- With PG interface

6ES7972-0BA52-0XA0
6ES7972-0BB52-0XA0**PROFIBUS FC Standard Cable**

2-core bus cable, shielded, special design for fast mounting, sold by the meter; delivery unit: max. 1000 m, minimum order 20 m

6XV1830-0EH10**PROFIBUS FastConnect Stripping Tool**

Stripping tool for fast stripping of the PROFIBUS FastConnect bus cable

6GK1905-6AA00**PROFIBUS bus terminal 12M**

Bus terminal for connection of PROFIBUS nodes at up to 12 Mbit/s with connecting cable

6GK1500-0AA10Note:

You can find order information for software in the Catalog IK PI or in the Industry Mall.

3

Overview

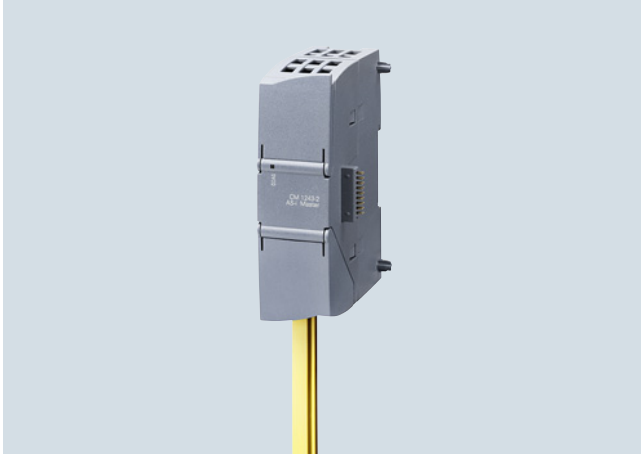

CM 1243-2 communication module for S7-1200

The CM 1243-2 communication module is the AS-Interface master for the SIMATIC S7-1200 and has the following features:

- As many as 62 AS-Interface slaves can be connected
- Integrated analog value transmission
- Supports all AS-Interface master functions in accordance with the AS-Interface specification V3.0
- Indication of the operating state on the front of the device displayed via LED
- Display of operating mode, AS-Interface voltage faults, configuration faults and peripheral faults via LED behind the front panel
- Compact enclosure in the design of the SIMATIC S7-1200
- Suitable for AS-i Power24V: In combination with the optional DCM 1271 data decoupling module, a standard 24 V power supply unit can be used
- Configuration and diagnostics via the TIA portal

Design

The CM 1243-2 communication module is positioned to the left of the S7-1200 CPU and linked to the S7-1200 via lateral contacts.

It has:

- Terminals for two AS-i cables (internally jumpered) via two screw terminals each
- One terminal for connection to the functional ground
- LEDs for indication of the operating state and fault statuses of the connected slaves

The screw terminals (included in scope of supply) can be removed to facilitate installation.

Function

The CM 1243-2 supports all specified functions of the AS-Interface Specification V3.0.

The values of the digital AS-i slaves can be activated via the process image of the S7-1200. During configuration of the slaves in the TIA Portal, the values of the analog AS-i slaves can also be accessed directly in the process image.

It is also possible to exchange all data of the AS-i master and the connected AS-i slaves with the S7-1200 via the data record interface.

Changeover of the operating mode, automatic application of the slave configuration and the re-addressing of a connected AS-i slave can be implemented via the control panel of the CM 1243-2 in the TIA Portal.

The optional DCM 1271 data decoupling module (see "Accessories" and Catalog IC 10) has an integrated detection unit for detecting ground faults on the AS-Interface cable. The integrated overload protection also disconnects the AS-Interface cable if the drive current required exceeds 4 A.

Notes on safety

In order to protect plants, systems, machines and networks against cyber threats, it is necessary to implement – and continuously maintain – a holistic, state-of-the-art industrial security concept. Siemens products and solutions only represent one component of such a concept.

For more information on the topic of Industrial Security, see <http://www.siemens.com/industrialsecurity>.

Configuration

To configure CM 1243-2, you require STEP 7 V11 + SP2 or higher.

For STEP 7 V11 + SP2 or higher, the additional Hardware Support Package for CM 1243-2 is required. This is available from the Industry Online Support Portal. See <https://support.industry.siemens.com/cs/ww/en/view/54164095>.

The software enables user-friendly configuration and diagnostics of the AS-i master and any connected slaves.

Alternatively, you can also apply the AS-Interface ACTUAL configuration at the "touch of a button" via the control panel integrated in the TIA portal/STEP7.

When operated on a S7-1200 CPU with firmware version V4.0 or higher, the firmware version V1.1 (or higher) is required for the CM 1243-2.

SIMATIC S7-1200 Basic Controllers

I/O modules

Communication

CM 1243-2

Ordering data

CM 1243-2 communication module

- AS-Interface master for SIMATIC S7-1200
- Corresponds to AS-Interface Specification V3.0
- With screw terminals, removable terminals (included in the scope of supply)
- Dimensions (W × H × D / mm): 30 × 100 × 75

Accessories

DCM 1271 data decoupling module

- With screw terminals, removable terminals (included in the scope of supply)
- Dimensions (W × H × D / mm): 30 × 100 × 75

Screw terminals (replacement)

- 5-pole for AS-i master CM 1243-2 and AS-i DCM 1271 data decoupling unit
- With screw terminals
- 3-pole for AS-i DCM 1271 data decoupling unit for connecting the power supply unit
- With screw terminals

Article No.

3RK7243-2AA30-0XB0

3RK7271-1AA30-0AA0

3RK1901-3MA00

3RK1901-3MB00

Article No.

AS-interface addressing unit V3.0

- For AS-Interface modules and sensors and actuators with integrated AS-Interface according to AS-i Specification V3.0
- For setting the AS-i address of standard slaves, and slaves with extended addressing mode (A/B slaves)
- With input/output test function and many other commissioning functions
- Battery operation with four type AA batteries (IEC LR6, NEDA 15)
- Degree of protection IP40
- Dimensions (W × H × D / mm): 84 × 195 × 35
- Scope of supply:
 - Addressing unit with 4 batteries
 - Addressing cable, with M12 plug to addressing plug (hollow plug), length 1.5 m

More information

For manuals, see <https://support.industry.siemens.com/cs/ww/en/ps/15750/man>.

3RK1904-2AB02

3

Overview



DP-M	DP-S	FMS	PG/OP	S7
●			●	●

The CM 1243-5 communication module is used to connect a SIMATIC S7-1200 to PROFIBUS as a DP master and has the following characteristics:

- PROFIBUS DPV1 master in accordance with IEC 61158
- Support of up to 16 PROFIBUS DP slaves
- Communication with other S7 controllers based on S7 communication
- Allows the connection of programming devices and operator panels with a PROFIBUS interface to the S7-1200
- Module replacement without PG supported
- Support of all standard baud rates from 9.6 Kbit/s to 12 Mbit/s
- Compact industry-standard enclosure in S7-1200 design for mounting on a standard mounting rail
- Fast commissioning thanks to easy configuration using STEP 7 without additional programming overhead

The CM 1243-5 is intended for use in factory automation. Low-cost PROFIBUS-based automation solutions can be created on the basis of the S7-1200 for optimal production.

Technical specifications

Article number	6GK7243-5DX30-0XE0
Product type designation	CM 1243-5
Transmission rate	
Transfer rate	
• at the 1st interface acc. to PROFIBUS	9.6 kbit/s ... 12 Mbit/s
Interfaces	
Number of interfaces acc. to Industrial Ethernet	0
Number of electrical connections	
• at the 1st interface acc. to PROFIBUS	1
• for power supply	1
Type of electrical connection	
• at the 1st interface acc. to PROFIBUS	9-pin Sub-D socket (RS 485)
• for power supply	3-pole terminal block
Supply voltage, current consumption, power loss	
Type of voltage of the supply voltage	DC
Supply voltage external	24 V
Supply voltage external at DC Rated value	24 V
Relative positive tolerance at DC at 24 V	20%
Relative negative tolerance at DC at 24 V	20%
Consumed current	
• from external supply voltage at DC at 24 V typical	0.1 A
Power loss [W]	2.4 W

Article number	6GK7243-5DX30-0XE0
Product type designation	CM 1243-5
Permitted ambient conditions	
Ambient temperature	
• for vertical installation during operation	0 ... 45 °C
• for horizontally arranged busbars during operation	0 ... 55 °C
• during storage	-40 ... +70 °C
• during transport	-40 ... +70 °C
Relative humidity at 25 °C without condensation during operation maximum	95%
Protection class IP	IP20
Design, dimensions and weight	
Module format	Compact module S7-1200 single width
Width	30 mm
Height	100 mm
Depth	75 mm
Net weight	0.134 kg
Mounting type	
• 35 mm DIN rail mounting	Yes
• S7-300 rail mounting	No
• wall mounting	Yes
Product properties, functions, components general	
Number of units	
• per CPU maximum	3

SIMATIC S7-1200 Basic Controllers

I/O modules

Communication

CM 1243-5

Technical specifications (continued)

Article number	6GK7243-5DX30-0XE0
Product type designation	CM 1243-5
Performance data PROFIBUS DP	
Service as DP master	
• DPV1	Yes
Number of DP slaves on DP master usable	16
Amount of data	
• of the address area of the inputs as DP master total	512 byte
• of the address area of the outputs as DP master total	512 byte
• of the address area of the inputs per DP slave	244 byte
• of the address area of the outputs per DP slave	244 byte
• of the address area of the diagnostic data per DP slave	240 byte
Service as DP slave	
• DPV0	No
• DPV1	No
Performance data S7 communication	
Number of possible connections for S7 communication	
• maximum	8
• with PG connections maximum	1
• with PG/OP connections maximum	3
• Note	max. 4 connections to other S7 stations
Performance data multi-protocol mode	
Number of active connections with multi-protocol mode	
• without DP maximum	8
• with DP maximum	8
Performance data telecontrol	
Protocol is supported	
• TCP/IP	No
Configuration software	
• required	STEP 7 Basic/Professional V11 (TIA Portal) or higher

Ordering data

Article No.

CM 1243-5 communication module

Communication module for electrical connection of SIMATIC S7-1200 to PROFIBUS as a DPV1 master

6GK7243-5DX30-0XE0

Accessories

PROFIBUS FastConnect connection plug RS 485

With 90° cable outlet; insulation displacement technology, max. transmission rate 12 Mbit/s

- Without PG interface
- With PG interface

6ES7972-0BA52-0XA0
6ES7972-0BB52-0XA0

PROFIBUS FC Standard Cable

2-core bus cable, shielded, special design for fast mounting, delivery unit: max. 1000 m, minimum order 20 m, sold by the meter

6XV1830-0EH10

PROFIBUS FastConnect Stripping Tool

Stripping tool for fast stripping of the PROFIBUS FastConnect bus cable

6GK1905-6AA00

PROFIBUS bus terminal 12M

Bus terminal for connection of PROFIBUS nodes up to 12 Mbps with connecting cable

6GK1500-0AA10

Note:

You can find order information for software in the Catalog IK PI or in the Industry Mall.

Overview



- Unmanaged switch for connecting a SIMATIC S7-1200 to an Industrial Ethernet network with a line, tree or star topology
- Multiplication of Ethernet interfaces on a SIMATIC S7-1200 for additional connection of up to three programming devices, operator controls, and further Ethernet nodes
- Simple, space-saving mounting on the SIMATIC S7-1200 mounting rail
- Low-cost solution for implementing small, local Ethernet networks
- Connection without any problems using RJ45 plugs
- Simple and fast status display via LEDs on the device
- Integral autocrossover function permits use of uncrossed connecting cables

3

Technical specifications

Article number	6GK7277-1AA10-0AA0
Product type designation	CSM 1277
Transmission rate	
Transfer rate	10 Mbit/s, 100 Mbit/s
Interfaces for communication integrated	
Number of electrical connections	4
• for network components or terminal equipment	
Number of 100 Mbit/s SC ports	0
• for multimode	
Number of 1000 Mbit/s LC ports	0
• for multimode	
• for single mode (LD)	0
Interfaces others	
Number of electrical connections	1
• for power supply	
Type of electrical connection	3-pole terminal block
• for power supply	
Supply voltage, current consumption, power loss	
Type of voltage of the supply voltage	DC
Supply voltage	24 V
• external	
• external	19.2 ... 28.8 V
Product component fusing at power supply input	Yes
Fuse protection type at input for supply voltage	0.5 A / 60 V
Consumed current maximum	0.07 A
Power loss [W]	1.6 W
• at DC at 24 V	

Article number	6GK7277-1AA10-0AA0
Product type designation	CSM 1277
Permitted ambient conditions	
Ambient temperature	0 ... 60 °C
• during operation	
• during storage	-40 ... +70 °C
• during transport	-40 ... +70 °C
Relative humidity	95%
• at 25 °C without condensation during operation maximum	
Protection class IP	IP20
Design, dimensions and weight	
Design	SIMATIC S7-1200 device design
Width	45 mm
Height	100 mm
Depth	75 mm
Net weight	0.15 kg
Mounting type	
• 35 mm DIN rail mounting	Yes
• wall mounting	Yes
• S7-300 rail mounting	No
• S7-1500 rail mounting	No
Product functions management, configuration	
Product function	
• multiport mirroring	No
• switch-managed	No
Product functions Redundancy	
Product function	
• Parallel Redundancy Protocol (PRP)/ operation in the PRP-network	Yes
• Parallel Redundancy Protocol (PRP)/ Redundant Network Access (RNA)	No

SIMATIC S7-1200 Basic Controllers

I/O modules

Communication

CSM 1277 unmanaged

Technical specifications (continued)

Article number	6GK7277-1AA10-0AA0
Product type designation	CSM 1277
Standards, specifications, approvals	
Standard	
• for FM	FM3611: Class 1, Division 2, Group A, B, C, D / T.., CL.1, Zone 2, GP, IIC, T.. Ta
• for hazardous zone	EN 600079-15:2005, EN 600079-0:2006, II 3 G Ex nA II T4, KEMA 08 ATEX 0003 X
• for safety from CSA and UL	UL 508, CSA C22.2 No. 142
• for emitted interference	EN 61000-6-4 (Class A)
• for interference immunity	EN 61000-6-2
Certificate of suitability CE marking	Yes
Certificate of suitability	EN 61000-6-2, EN 61000-6-4
• C-Tick	Yes
• KC approval	No
Marine classification association	
• American Bureau of Shipping Europe Ltd. (ABS)	Yes
• Bureau Veritas (BV)	Yes
• Det Norske Veritas (DNV)	Yes
• Germanische Lloyd (GL)	No
• Lloyds Register of Shipping (LRS)	Yes
• Nippon Kaiji Kyokai (NK)	Yes
• Polski Rejestr Statkow (PRS)	No
• Royal Institution of Naval Architects (RINA)	No
MTBF at 40 °C	273 y

Ordering data

Article No.

CSM 1277 compact switch module

Unmanaged switch for connecting a SIMATIC S7-1200 and up to three further nodes to Industrial Ethernet with 10/100 Mbit/s; 4 x RJ45 ports; external 24 V DC power supply, diagnostics on LEDs, S7-1200 module including electronic manual on CD-ROM

6GK7277-1AA10-0AA0

Accessories

IE FC TP Trailing Cable 2 x 2 (Type C)

4-core, shielded TP installation cable for connection to IE FC outlet RJ45/ IE FC RJ45 Plug 180/90 for use as trailing cable; PROFINET-compatible; with UL approval; sold by the meter; max. delivery unit 1000 m, minimum order quantity 20 m

6XV1840-3AH10

IE FC RJ45 Plug 180 2 x 2

RJ45 plug connector for Industrial Ethernet with a rugged metal housing and integrated insulation displacement contacts for connecting Industrial Ethernet FC installation cables; 180° cable outlet; for network components and CPUs/CPUs with Industrial Ethernet interface

- 1 pack = 1 unit
- 1 pack = 10 units
- 1 pack = 50 units

6GK1901-1BB10-2AA0
6GK1901-1BB10-2AB0
6GK1901-1BB10-2AE0

IE FC outlet RJ45

For connecting Industrial Ethernet FC cables and TP cords; graduated prices for 10 and 50 units or more

6GK1901-1FC00-0AA0

IE TP Cord RJ45/RJ45

- TP cord pre-assembled with 2 RJ45 connectors; length: 0.5 m
- TP cable 4 x 2 with 2 RJ45 connectors; length: 0.5 m

6XV1850-2GE50

6XV1870-3QE50

Overview

The CP 1243-1 communications processor is used for connecting a SIMATIC S7-1200 to the TeleControl Server Basic control center software via Ethernet, and for safe communication via IP-based networks.

The CP has the following features:

- Ethernet-based connection to TeleControl Server Basic, e.g. via Internet
- Data transfer of measured values, control variables, or alarms optimized for telecontrol systems
- Automatic sending of alert emails
- Data buffering of up to 64,000 values ensures a secure database even with temporary connection failures
- Secure communication via VPN connections based on IPsec
- Access protection via Stateful Inspection Firewall
- Clearly laid out LED signaling for fast and easy diagnostics
- Compact industrial enclosure in S7-1200 design for mounting on a standard mounting rail
- Fast commissioning thanks to easy configuration using STEP 7

3

Technical specifications

Article number	6GK7243-1BX30-0XE0
Product type designation	CP 1243-1
Transmission rate	
Transfer rate	
• at the 1st interface	10 ... 100 Mbit/s
Interfaces	
Number of interfaces acc. to Industrial Ethernet	1
Number of electrical connections	
• at the 1st interface acc. to Industrial Ethernet	1
• for power supply	0
Type of electrical connection	
• at the 1st interface acc. to Industrial Ethernet	RJ45 port
Supply voltage, current consumption, power loss	
Type of voltage of the supply voltage	DC
Supply voltage 1 from backplane bus	5 V
Consumed current	
• from backplane bus at DC at 5 V typical	0.25 A
Power loss [W]	1.25 W

Article number	6GK7243-1BX30-0XE0
Product type designation	CP 1243-1
Permitted ambient conditions	
Ambient temperature	
• for vertical installation during operation	-20 ... +60 °C
• for horizontally arranged busbars during operation	-20 ... +70 °C
• during storage	-40 ... +70 °C
• during transport	-40 ... +70 °C
Relative humidity at 25 °C without condensation during operation maximum	95%
Protection class IP	IP20
Design, dimensions and weight	
Module format	Compact module S7-1200 single width
Width	30 mm
Height	110 mm
Depth	75 mm
Net weight	0.122 kg
Mounting type	
• 35 mm DIN rail mounting	Yes
• wall mounting	Yes

SIMATIC S7-1200 Basic Controllers

I/O modules

Communication

CP 1243-1

Technical specifications (continued)

Article number	6GK7243-1BX30-0XE0
Product type designation	CP 1243-1
Product properties, functions, components general	
Number of units	
• per CPU maximum	3
Performance data S7 communication	
Number of possible connections for S7 communication	
• Note	like CPU
Performance data telecontrol	
Suitability for use	
• Node station	No
• substation	Yes
• TIM control center	No
Control center connection	to be used with Telecontrol Server Basic
• by means of a permanent connection	supported
• Note	Connection to SCADA system via Telecontrol Server Basic
Protocol is supported	
• DNP3	No
• IEC 60870-5	No
Product function data buffering if connection is aborted	Yes; 64,000 values
Number of data points per station maximum	200
Performance data Teleservice	
Diagnostics function online diagnostics with SIMATIC STEP 7	Yes
Product function	
• program download with SIMATIC STEP 7	Yes
• Remote firmware update	Yes
Configuration software	
• required	STEP 7 Basic/Professional V13 Update 2 + HSP (TIA Portal) or higher

Article number	6GK7243-1BX30-0XE0
Product type designation	CP 1243-1
Product functions Security	
Firewall version	stateful inspection
Product function with VPN connection	IPSec
Type of encryption algorithms with VPN connection	AES-256, AES-192, AES-128, 3DES-168
Type of authentication procedure with VPN connection	Preshared key (PSK), X.509v3 certificates
Type of hashing algorithms with VPN connection	MD5, SHA-1
Number of possible connections with VPN connection	8
Product function	
• password protection for Web applications	No
• password protection for teleservice access	No
• encrypted data transmission	Yes
• ACL - IP-based	No
• ACL - IP-based for PLC/routing	No
• switch-off of non-required services	Yes
• Blocking of communication via physical ports	No
• log file for unauthorized access	No
Product functions Time	
Protocol is supported	
• NTP	Yes
time synchronization	
• from control center	Yes

Ordering data	Article No.	Ordering data	Article No.
Communications processor CP 1243-1 Communications processor for connection of SIMATIC S7-1200 to TeleControl Server Basic or for secure connection via IP-based networks	6GK7243-1BX30-0XE0	Compact switch module CSM 1277 Unmanaged switch for connecting a SIMATIC S7-1200 and up to three further nodes to Industrial Ethernet with 10/100 Mbps; 4 x RJ45 ports; external 24 V DC power supply, LED diagnostics, S7-1200 module including electronic device manual on CD-ROM	6GK7277-1AA10-0AA0
Accessories TeleControl Server Basic V3.0 Software for 8 to 5000 stations; single license for one installation; OPC (UA) server for GPRS and Ethernet/Internet communication with SIMATIC S7-1200 and SIMATIC S7-200 (GPRS only); connection management to remote stations; routing for connections between S7 stations; German and English operator interface; for Windows 7 Professional 32/64-bit + Service Pack 1 Windows 7 Enterprise 32/64-bit + Service Pack 1 Windows 7 Ultimate 32/64-bit + Service Pack 1 Windows Server 2008 32-bit + Service Pack 2 Windows Server 2008 R2 Standard 64-bit Service Pack 1 <ul style="list-style-type: none"> • TeleControl Server Basic 8 V3 Connection management for 8 SIMATIC S7-1200 or S7-200 stations • TeleControl Server Basic 32 V3 Connection management for 32 SIMATIC S7-1200 or S7-200 stations • TeleControl Server Basic 64 V3 Connection management for 64 SIMATIC S7-1200 or S7-200 stations • TeleControl Server Basic 256 V3 Connection management for 256 SIMATIC S7-1200 or S7-200 stations • TeleControl Server Basic 1000 V3 Connection management for 1000 SIMATIC S7-1200 or S7-200 stations • TeleControl Server Basic 5000 V3 Connection management for 5000 SIMATIC S7-1200 or S7-200 stations • TeleControl Server Basic UPGR V3 Upgrade package from Version V2.x to V3 for all license sizes 	6NH9910-0AA21-0AA0 6NH9910-0AA21-0AF0 6NH9910-0AA21-0AB0 6NH9910-0AA21-0AC0 6NH9910-0AA21-0AD0 6NH9910-0AA21-0AE0 6NH9910-0AA21-0GA0	IE FC RJ45 plugs RJ45 plug connector for Industrial Ethernet with a rugged metal enclosure and integrated insulation displacement contacts for connecting Industrial Ethernet FC installation cables IE FC RJ45 Plug 180 180° cable outlet; for network components and CPs/CPU with Industrial Ethernet interface <ul style="list-style-type: none"> • 1 pack = 1 unit • 1 pack = 10 units • 1 pack = 50 units 	6GK1901-1BB10-2AA0 6GK1901-1BB10-2AB0 6GK1901-1BB10-2AE0
		IE FC TP Standard Cable GP 2 x 2 (Type A) 4-core, shielded TP installation cable for connection to IE FC outlet RJ45/IE F RJ45 plug; PROFINET-compatible; with UL approval; sold by the meter max. length 1000 m, minimum order quantity 20 m	6XV1840-2AH10
		IE FC Stripping Tool Pre-adjusted stripping tool for fast stripping of Industrial Ethernet FC cables	6GK1901-1GA00
		STEP 7 Basic Engineering Software (TIA Portal)	See catalog section 11

SIMATIC S7-1200 Basic Controllers

I/O modules

Communication

CP 1242-7 V2 GPRS

Overview



The CP 1242-7 GPRS V2 communications processor is used to connect a SIMATIC S7-1200 to the globally available GSM/GPRS mobile radio network and has the following characteristics:

- Worldwide wireless exchange of data between S7-1200 controllers and/or between S7-1200 controllers and control centers with an Internet connection
- Communication based on the GPRS (**G**eneral **P**acket **R**adio **S**ervice) mobile wireless service with data transmission speeds of up to 86 Kbit/s in the downlink and 43 Kbit/s in the uplink
- GPRS mode with fixed IP addresses and dynamic IP addresses with standard mobile phone contract
- Time synchronization on the basis of NTP (**N**etwork **T**ime **P**rotocol)
- Sending and receiving of text messages
- LED signaling for fast diagnostics
- Compact industrial enclosure in S7-1200 design for mounting on a standard mounting rail
- Fast commissioning thanks to easy configuration using STEP 7

In conjunction with the TeleControl Server Basic software, the CP 1242-7 forms a telecontrol system with additional properties:

- Connection of up to 5000 telecontrol stations to the control center via an OPC interface
- Data buffering in the substations in the event of connection failures
- Central status monitoring of the substations
- No special provider services required for fixed IP addresses
- Teleservice access with STEP 7 to the substations via the Internet

The CP 1242-7 V2 is a new product version of the CP 1242-7. The concept for process data transmission has been expanded with a simple data point configuration, which enables substantially easier commissioning without high programming overhead and minimizes susceptibility to errors during the projects implementation phase. CP 1242-7 has also been equipped with new functions, such as access to the internal Web server of the S7-1200. This opens up numerous new application areas.

Technical specifications

Article number	6GK7242-7KX31-0XE0
Product type designation	CP 1242-7 V2
Transmission rate	
Transfer rate	
• for GPRS transmission	
- with downlink maximum	86 kbit/s
- with uplink maximum	43 kbit/s
Interfaces	
Number of interfaces acc. to Industrial Ethernet	0
Number of electrical connections	
• for external antenna(s)	1
• for power supply	1
Number of slots	
• for SIM cards	1
Type of electrical connection	
• for external antenna(s)	SMA socket (50 ohms)
• for power supply	3-pole terminal block
Slot version	
• for SIM card	Standard

Article number	6GK7242-7KX31-0XE0
Product type designation	CP 1242-7 V2
Wireless technology	
Type of mobile wireless service	
• is supported SMS	Yes
• is supported GPRS	Yes
• Note	GPRS (Multislot Class 10)
Type of mobile network is supported	
• GSM	Yes
• UMTS	No
• LTE	No
Operating frequency	
• 850 MHz	Yes
• 900 MHz	Yes
• 1800 MHz	Yes
• 1900 MHz	Yes
Transmit power	
• at operating frequency 900 MHz	2 W
• at operating frequency 1800 MHz	1 W
• at operating frequency 1900 MHz	1 W

Technical specifications (continued)

Article number	6GK7242-7KX31-0XE0
Product type designation	CP 1242-7 V2
Supply voltage, current consumption, power loss	
Type of voltage of the supply voltage	DC
Supply voltage external	24 V
Supply voltage external at DC Rated value	24 V
Relative positive tolerance at DC at 24 V	20%
Relative negative tolerance at DC at 24 V	20%
Consumed current	
• from external supply voltage at DC at 24 V typical	0.1 A
• from external supply voltage at DC at 24 V maximum	0.22 A
Power loss [W]	2.4 W
Permitted ambient conditions	
Ambient temperature	
• for vertical installation during operation	-20 ... +60 °C
• for horizontally arranged busbars during operation	-20 ... +70 °C
• during storage	-40 ... +70 °C
• during transport	-40 ... +70 °C
Relative humidity at 25 °C without condensation during operation maximum	95%
Protection class IP	IP20
Design, dimensions and weight	
Module format	Compact module S7-1200 single width
Width	30 mm
Height	100 mm
Depth	75 mm
Net weight	0.133 kg
Mounting type	
• 35 mm DIN rail mounting	Yes
• S7-300 rail mounting	No
• wall mounting	Yes
Product properties, functions, components general	
Number of units	
• per CPU maximum	3
Performance data	
Number of users/telephone numbers definable maximum	10

Article number	6GK7242-7KX31-0XE0
Product type designation	CP 1242-7 V2
Performance data open communication	
Number of possible connections for open communication	
• by means of T blocks maximum	like CPU
Performance data IT functions	
Number of possible connections	
• as e-mail client maximum	1
Performance data telecontrol	
Control center connection	Telecontrol Server Basic supported
• by means of a permanent connection	supported
• by means of demand-oriented connection	supported
• Note	Connection to SCADA system using OPC interface
Protocol is supported	
• DNP3	No
• IEC 60870-5	No
Product function data buffering if connection is aborted	Yes; 64,000 values
Performance data Teleservice	
Diagnostics function online diagnostics with SIMATIC STEP 7	Yes
Product function	
• program download with SIMATIC STEP 7	Yes
• Remote firmware update	Yes
Configuration software	
• required	STEP 7 Basic/Professional V13 SP1 or higher
Product functions Diagnosis	
Product function Web-based diagnostics	Yes
Product functions Security	
Product function	
• password protection for teleservice access	Yes
• encrypted data transmission	Yes
Product functions Time	
Protocol is supported	
• NTP	Yes
time synchronization	
• from control center	Yes

SIMATIC S7-1200 Basic Controllers

I/O modules

Communication

CP 1242-7 V2 GPRS

Ordering data

Communications processor CP 1242-7 V2¹⁾

Communications processor
CP 1242-7 GPRS V2 for connecting
SIMATIC S7-1200 to TeleControl
Server Basic via GSM/GPRS mobile
radio network

Article No.

6GK7242-7KX31-0XE0

Accessories

TeleControl Server Basic V3.0

Software for 8 to 5000 stations;
single license for one installation;
OPC (UA) server for GPRS and
Ethernet/Internet communication
with SIMATIC S7-1200 and
SIMATIC S7-200 (GPRS only);
connection management to remote
stations; routing for connections
between S7 stations; German and
English operator interface;
for Windows 7 Professional
32/64-bit + Service Pack 1
Windows 7 Enterprise 32/64-bit +
Service Pack 1
Windows 7 Ultimate 32/64-bit +
Service Pack 1
Windows Server 2008 32-bit +
Service Pack 2
Windows Server 2008 R2 Standard
64-bit Service Pack 1

- **TeleControl Server Basic 8 V3** 6NH9910-0AA21-0AA0
Connection management for
8 SIMATIC S7-1200 or
S7-200 stations
- **TeleControl Server Basic 32 V3** 6NH9910-0AA21-0AF0
Connection management for
32 SIMATIC S7-1200 or
S7-200 stations
- **TeleControl Server Basic 64 V3** 6NH9910-0AA21-0AB0
Connection management for
64 SIMATIC S7-1200 or
S7-200 stations
- **TeleControl Server Basic 256 V3** 6NH9910-0AA21-0AC0
Connection management for
256 SIMATIC S7-1200 or
S7-200 stations
- **TeleControl Server Basic 1000
V3** 6NH9910-0AA21-0AD0
Connection management for
1000 SIMATIC S7-1200 or
S7-200 stations
- **TeleControl Server Basic 5000
V3** 6NH9910-0AA21-0AE0
Connection management for
5000 SIMATIC S7-1200 or
S7-200 stations
- **TeleControl Server Basic UPGR
V3** 6NH9910-0AA21-0GA0
Upgrade package from Version
V2.x to V3 for all license sizes

Article No.

ANT794-4MR antenna

Omnidirectional antenna for
GSM (2G), UMTS (3G) and
LTE (4G) networks;
weather-resistant for indoor and
outdoor use; 5 m connecting cable
with fixed connection to antenna;
SMA connector; including mounting
bracket, screws, wall plugs

6NH9860-1AA00

ANT794-3M antenna

Flat panel antenna for GSM (2G)
networks, for triband with
900/1800/1900 MHz;
weather-resistant for indoor/
outdoor use, 1.2 m connecting
cable with fixed connection to
antenna;
SMA connector, incl. assembly
adhesive tape

6NH9870-1AA00

STEP 7 Basic Engineering Software V13 SP1 (TIA Portal)

See catalog section 11

¹⁾ Note national approvals under
<http://www.siemens.com/mobilenetwork-approvals>

Overview



CP 1243-7 LTE is used to connect the S7-1200 to a mobile wireless network of the 4th Generation LTE (Long Term Evolution). The increased data rates compared to GPRS and widespread introduction of LTE open up new areas of application. The CP1243-7 is characterized by the following properties:

- 1 connection to LTE (4G) mobile wireless network (various versions for EU and North America)
- Data transfer of measured values, control variables, or alarms optimized for telecontrol systems
- Operation with fixed IP addresses and dynamic IP addresses with standard cellular phone contract
- Time synchronization based on NTP (Network Time Protocol)
- On-demand connection buildup via voice call or text message
- Sending and receiving of text messages
- TeleService access with STEP 7 to substations via mobile wireless networks
- Compact industrial enclosure in S7-1200 design for mounting on a standard mounting rail
- Temperature range in operation: -20 °C to +70 °C
- Installation on standard mounting rails
- Diagnostics LEDs (overall status and details)
- Integrated security functions (VPN and firewall)
- Access to the CPU Web server
- Fast commissioning due to simplified configuration with STEP 7
- Data buffering of up to 64,000 values ensures a secure database even with temporary connection failures

3

Technical specifications

Article number	6GK7243-7KX30-0XE0	6GK7243-7SX30-0XE0
Product type designation	CP 1243-7 LTE EU	CP 1243-7 LTE US
Transmission rate		
Transfer rate		
• for LTE transmission		
- with downlink maximum	42 Mbit/s	42 Mbit/s
- with uplink maximum	5.76 Mbit/s	5.76 Mbit/s
Interfaces		
Number of interfaces acc. to Industrial Ethernet	0	0
Number of electrical connections		
• for external antenna(s)	1	1
• for power supply	1	1
Number of slots		
• for SIM cards	1	1
Type of electrical connection		
• for external antenna(s)	SMA socket (50 ohms)	SMA socket (50 ohms)
• for power supply	3-pole terminal block	3-pole terminal block
Slot version		
• for SIM card	Standard	Standard

Article number	6GK7243-7KX30-0XE0	6GK7243-7SX30-0XE0
Product type designation	CP 1243-7 LTE EU	CP 1243-7 LTE US
Wireless technology		
Type of mobile wireless service		
• is supported SMS	Yes	Yes
• is supported GPRS	Yes	Yes
• Note	GPRS (Multislot Class 10)	GPRS (Multislot Class 10)
Type of mobile network is supported		
• GSM	Yes	Yes
• UMTS	Yes	Yes
• LTE	Yes	Yes
Operating frequency		
• 850 MHz		Yes
• 1900 MHz		Yes
Operating frequency		
• for GSM transmission 900 MHz	Yes	
• for GSM transmission 1800 MHz	Yes	
• with UMTS transmission 900 MHz	Yes	
• with UMTS transmission 2100 MHz	Yes	
• for LTE transmission 700 MHz		Yes
• for LTE transmission 800 MHz	Yes	
• for LTE transmission 1700 MHz		Yes
• for LTE transmission 1800 MHz	Yes	
• for LTE transmission 2600 MHz	Yes	

SIMATIC S7-1200 Basic Controllers

I/O modules

Communication

CP 1243-7 LTE

Technical specifications (continued)

Article number	6GK7243-7KX30-0XE0	6GK7243-7SX30-0XE0
Product type designation	CP 1243-7 LTE EU	CP 1243-7 LTE US
Supply voltage, current consumption, power loss		
Type of voltage of the supply voltage	DC	DC
Supply voltage external	24 V	24 V
Supply voltage external at DC Rated value	24 V	24 V
Relative positive tolerance at DC at 24 V	20%	20%
Relative negative tolerance at DC at 24 V	20%	20%
Consumed current		
• from external supply voltage at DC at 24 V typical	0.1 A	0.1 A
• from external supply voltage at DC at 24 V maximum	0.22 A	0.22 A
Permitted ambient conditions		
Ambient temperature		
• for vertical installation during operation	-20 ... +60 °C	-20 ... +60 °C
• for horizontally arranged busbars during operation	-20 ... +70 °C	-20 ... +70 °C
• during storage	-40 ... +70 °C	-40 ... +70 °C
• during transport	-40 ... +70 °C	-40 ... +70 °C
Relative humidity at 25 °C without condensation during operation maximum	95%	95%
Protection class IP	IP20	IP20
Design, dimensions and weight		
Module format	Compact module S7-1200 single width	Compact module S7-1200 single width
Width	30 mm	30 mm
Height	100 mm	100 mm
Depth	75 mm	75 mm
Net weight	0.133 kg	0.133 kg
Mounting type		
• 35 mm DIN rail mounting	Yes	Yes
• S7-300 rail mounting	No	No
• wall mounting	Yes	Yes
Product properties, functions, components general		
Number of units		
• per CPU maximum	3	3
Performance data		
Number of users/telephone numbers definable maximum	10	10
Performance data open communication		
Number of possible connections for open communication		
• by means of T blocks maximum	like CPU	like CPU
Performance data IT functions		
Number of possible connections		
• as e-mail client maximum	1	1

Article number	6GK7243-7KX30-0XE0	6GK7243-7SX30-0XE0
Product type designation	CP 1243-7 LTE EU	CP 1243-7 LTE US
Performance data telecontrol		
Suitability for use		
• substation	Yes	Yes
Control center connection	Telecontrol Server Basic	Telecontrol Server Basic
• by means of a permanent connection	supported	supported
• by means of demand-oriented connection	supported	supported
• Note	Connection to SCADA system using OPC interface	Connection to SCADA system using OPC interface
Protocol is supported		
• DNP3	No	No
• IEC 60870-5	No	No
Product function data buffering if connection is aborted	Yes; 64,000 values	Yes; 64,000 values
Performance data Teleservice		
Diagnostics function online diagnostics with SIMATIC STEP 7	Yes	Yes
Product function		
• program download with SIMATIC STEP 7	Yes	Yes
• Remote firmware update	Yes	Yes
Configuration software		
• required	STEP 7 Basic/ Professional V13 SP1 or higher	STEP 7 Basic/ Professional V13 SP1 + HSP or higher
Product functions Diagnosis		
Product function Web-based diagnostics	Yes	Yes
Product functions Security		
Firewall version	stateful inspection	stateful inspection
Product function with VPN connection	IPSec	IPSec
Type of encryption algorithms with VPN connection	AES-256, AES-192, AES-128, 3DES-168, DES-56	AES-256, AES-192, AES-128, 3DES-168, DES-56
Type of authentication procedure with VPN connection	Preshared key (PSK), X.509v3 certificates	Preshared key (PSK), X.509v3 certificates
Type of hashing algorithms with VPN connection	MD5, SHA-1	MD5, SHA-1
Number of possible connections with VPN connection	1	1
Product function		
• password protection for teleservice access	Yes	Yes
• encrypted data transmission	Yes	Yes
Product functions Time		
Protocol is supported		
• NTP	Yes	Yes
time synchronization		
• from control center	Yes	Yes

Ordering data	Article No.	Article No.
Communications processor CP 1243-7 LTE Communications processor for connecting SIMATIC S7-1200 to the TeleControl Server Basic via the LTE mobile wireless network <ul style="list-style-type: none"> • CP 1243-7 LTE EU Frequencies in European band: 700, 1700 MHz • CP 1243-7 LTE US Frequencies in North American band: 800, 1800, 2600 MHz 	6GK7243-7KX30-0XE0 6GK7243-7SX30-0XE0	ANT794-4MR antenna Omnidirectional antenna for GSM (2G), UMTS (3G) and LTE (4G) networks; weather-resistant for indoor and outdoor use; 5 m cable with fixed connection to antenna; SMA connector; including mounting bracket, screws, wall plugs STEP 7 Basic Engineering Software (TIA Portal)
Accessories TeleControl Server Basic V3.0 Software for 8 to 5000 stations; single license for one installation; OPC (UA) server for GPRS and Ethernet/Internet communication with SIMATIC S7-1200 and SIMATIC S7-200 (GPRS only); connection management to remote stations; routing for connections between S7 stations; German and English operator interface; for Windows 7 Professional 32/64-bit + Service Pack 1 Windows 7 Enterprise 32/64-bit + Service Pack 1 Windows 7 Ultimate 32/64-bit + Service Pack 1 Windows Server 2008 32-bit + Service Pack 2 Windows Server 2008 R2 Standard 64-bit Service Pack 1 <ul style="list-style-type: none"> • TeleControl Server Basic 8 V3 Connection management for 8 SIMATIC S7-1200 or S7-200 stations • TeleControl Server Basic 32 V3 Connection management for 32 SIMATIC S7-1200 or S7-200 stations • TeleControl Server Basic 64 V3 Connection management for 64 SIMATIC S7-1200 or S7-200 stations • TeleControl Server Basic 256 V3 Connection management for 256 SIMATIC S7-1200 or S7-200 stations • TeleControl Server Basic 1000 V3 Connection management for 1000 SIMATIC S7-1200 or S7-200 stations • TeleControl Server Basic 5000 V3 Connection management for 5000 SIMATIC S7-1200 or S7-200 stations • TeleControl Server Basic UPGR V3 Upgrade package from Version V2.x to V3 for all license sizes 	6NH9910-0AA21-0AA0 6NH9910-0AA21-0AF0 6NH9910-0AA21-0AB0 6NH9910-0AA21-0AC0 6NH9910-0AA21-0AD0 6NH9910-0AA21-0AE0 6NH9910-0AA21-0GA0	6NH9860-1AA00 See catalog section 11

SIMATIC S7-1200 Basic Controllers

I/O modules

Communication

CP 1243-8 IRC

Overview



The CP 1243-8 IRC communications processor (Industrial Remote Communication) is used for connecting a SIMATIC S7-1200 in the TeleControl Professional system via the SINAUT ST7 telecontrol protocol to higher-level ST7 stations or to an ST7 control center.

The CP has the following features:

- SINAUT ST7 telecontrol protocol supported
- Two WAN connections for selecting the communication paths:
 - Ethernet-based connection: RJ45 port on the module for connecting external routers, e.g. SCALANCE M
 - Additional connection configurable via plug-in TS modules

- Both WAN interfaces can also be operated simultaneously: Route redundancy
- Data transfer optimized for telecontrol systems on the basis of SINAUT ST7
- Automatic transmission of alarms per email or SMS
- Time synchronization based on NTP (Network Time Protocol) or via the SINAUT system
- Data buffering of up to 16,000 data messages prevents data loss in the event of temporary connection failures
- Secure communication via VPN connections based on IPsec
- Access protection via Stateful Inspection Firewall
- Fast and simple diagnostics via clear LED indicators, STEP 7 and web browser
- Compact industrial enclosure in S7-1200 design for mounting on a standard mounting rail

The integrated Ethernet interface and the option of using the TS modules provide flexible connection options for the CP. The following TS modules are available:

- TS module RS 232
- TS module MODEM
- TS module ISDN and
- TS module GSM.

Technical specifications

Article number	6GK7243-8RX30-0XE0
Product type designation	CP 1243-8 IRC
Transmission rate	
Transfer rate	
• at the 1st interface	10 ... 100 Mbit/s
• at the 2nd interface	0.3 ... 115.2 kbit/s
Interfaces	
Number of interfaces acc. to Industrial Ethernet	1
Number of electrical connections	
• at the 1st interface acc. to Industrial Ethernet	1
• for power supply	1
Type of electrical connection	
• at the 1st interface acc. to Industrial Ethernet	RJ45 port
• at interface 2 for external data transmission	Interface to the TS Module
• for power supply	3-pole terminal block
Supply voltage, current consumption, power loss	
Type of voltage of the supply voltage	DC
Supply voltage 1 from backplane bus	5 V
Supply voltage external	24 V
Supply voltage external	19.2 ... 28.8 V
Supply voltage external at DC Rated value	24 V
Supply voltage external at DC rated value	19.2 ... 28.8 V

Article number	6GK7243-8RX30-0XE0
Product type designation	CP 1243-8 IRC
Consumed current	
• from backplane bus at DC at 5 V typical	0.25 A
• from external supply voltage at DC at 24 V typical	0.1 A
Power loss [W] Note	1.25 W from S7-1200 backplane without TS module. 2.4 W from 24 V DC external with TS module
Power loss [W]	2.4 W
Permitted ambient conditions	
Ambient temperature	
• for vertical installation during operation	-20 ... +60 °C
• for horizontally arranged busbars during operation	-20 ... +70 °C
• during storage	-40 ... -70 °C
• during transport	-40 ... +70 °C
Relative humidity at 25 °C without condensation during operation maximum	95%
Protection class IP	IP20

Technical specifications (continued)

Article number	6GK7243-8RX30-0XE0	Article number	6GK7243-8RX30-0XE0
Product type designation	CP 1243-8 IRC	Product type designation	CP 1243-8 IRC
Design, dimensions and weight		Performance data Teleservice	
Module format	Compact module S7-1200 single width	Diagnostics function online diagnostics with SIMATIC STEP 7	Yes
Width	30 mm	Product function	
Height	110 mm	• program download with SIMATIC STEP 7	Yes
Depth	75 mm	• Remote firmware update	Yes
Net weight	0.122 kg	Protocol is supported	
Mounting type		• SNMP v3	Yes
• 35 mm DIN rail mounting	Yes	• DCP	Yes
• S7-300 rail mounting	No	Configuration software	
• wall mounting	Yes	• required	SINAUT ES V5.5 and STEP7 V13 SP1 or higher
Product properties, functions, components general		• for PG configuring required SINAUT ST7 configuration software for PG	Yes
Number of units	1	Product functions Diagnosis	
• per CPU maximum	1	Product function Web-based diagnostics	Yes
• Note	One CP pluggable on left side of CPU, one TS Module pluggable left side of CP.	Product functions Security	
Performance data open communication		Firewall version	stateful inspection
Number of possible connections for open communication		Suitability for operation Virtual Private Network	Yes
• by means of T blocks maximum	like CPU	Product function with VPN connection	IPSec
Performance data S7 communication		Type of encryption algorithms with VPN connection	AES-256, AES-192, AES-128, 3DES-168, DES-56
Number of possible connections for S7 communication		Type of authentication procedure with VPN connection	Preshared key (PSK), X.509v3 certificates
• with PG connections maximum	2	Type of hashing algorithms with VPN connection	MD5, SHA-1
• with OP connections maximum	1	Number of possible connections with VPN connection	8
• Note	Configured S7-Connection for S7-Communication	Product function	
Service		• password protection for teleservice access	No
• SINAUT ST7 via S7 communication	Yes	• encrypted data transmission	Yes
Performance data IT functions		• MSC client via GPRS modem with MSC capability	Yes
Number of possible connections		Protocol	
• as e-mail client maximum	1	• is supported MSC protocol	Yes
Performance data telecontrol		• with Virtual Private Network MSC is supported	TCP/IP
Suitability for use		Key length for MSC with Virtual Private Network	128 bit
• Node station	No	Number of possible connections	
• substation	Yes	• as MSC client with VPN connection	1
• TIM control center	No	• as MSC server with VPN connection	0
• Note	Ethernet and TS Module can be operated in parallel	Product functions Time	
Control center connection	control center with ST7 function supported	Protocol is supported	
• by means of a permanent connection	supported	• NTP	Yes
Protocol is supported		time synchronization	
• SINAUT ST7 protocol	Yes	• from NTP-server	Yes
Product function data buffering if connection is aborted	Yes; 16,000 data messages	• from control center	Yes
Number of data points per station maximum	200	Accessories	
Transmission format		accessories	TS Module RS 232 or TS Module MODEM or TS Module ISDN or TS Module GSM pluggable
• for SINAUT ST7 protocol with multi-master polling 10-bit	Yes		
• for SINAUT ST7 protocol with polling or spontaneous 10-bit or 11-bit	Yes		
Operating mode for scanning of data transmission			
• with dedicated line/radio link with SINAUT ST7 protocol	Polling		
• with dial-up network with SINAUT ST7 protocol	spontaneous		
Hamming distance			
• for SINAUT ST7 protocol	4		

SIMATIC S7-1200 Basic Controllers

I/O modules

Communication

CP 1243-8 IRC**Ordering data****Article No.****CP 1243-8 IRC communications processor**

Communications processor for connecting a SIMATIC S7-1200 in the TeleControl Professional system via the SINAUT ST7 telecontrol protocol to higher-level ST7 stations or to an ST7 control center.

6GK7243-8RX30-0XE0**Accessories****STEP 7 Professional 2010 SR4/V14, Floating Combo License;**

on DVD

6ES7810-5CC11-0YA5**SINAUT Engineering Software V5.5**

- On CD-ROM, comprising:
- SINAUT ST7/DNP3 configuration and diagnostic software for STEP 7 V5.5 incl. SP4;
 - SINAUT TD7 block library
 - Electronic manual in German and English

6NH7997-0CA55-0AA0**Article No.****SINAUT Engineering Software V5.5 Upgrade from V5.0, V5.1, V5.2, V5.3 or V5.4**

For upgrading functional expansions; on CD ROM / DVD

6NH7997-0CA55-0GA0**TeleService module**

Connection to TS Adapter IE Basic/Advanced or CP 1243-8 IRC. Power supply via TS Adapter IE Basic/Advanced or CP 1243-8 IRC.

TS module RS 232**6ES7972-0MS00-0XA0****TS module modem****6ES7972-0MM00-0XA0****TS module ISDN****6ES7972-0MD00-0XA0****TS module GSM**

GSM/GPRS modem for SIMATIC Teleservice ¹⁾

6GK7972-0MG00-0XA0

¹⁾ Note national approvals under <http://www.siemens.com/mobilenetwork-approvals>

Overview



The CP 1243-1 DNP3 communications processor is used to connect a SIMATIC S7-1200 to a control center system via the DNP3 protocol and has the following characteristics:

- Support for the established DNP3 telecontrol protocol for standardized linking of the SIMATIC S7-1200 to WinCC, PCS 7, or other commercially available control center systems
- Data transfer of measured values, control variables, or alarms optimized for telecontrol systems
- Automatic sending of alert emails
- Clearly laid out LED signaling for fast and easy diagnostics
- Compact industrial enclosure in S7-1200 design for mounting on a standard mounting rail
- Fast commissioning thanks to easy configuration using STEP 7
- Data buffering of up to 64,000 values ensures a secure database even with temporary connection failures

3

Technical specifications

Article number	6GK7243-1JX30-0XE0
Product type designation	CP 1243-1 DNP3
Transmission rate	
Transfer rate	
• at the 1st interface	10 ... 100 Mbit/s
Interfaces	
Number of interfaces acc. to Industrial Ethernet	1
Number of electrical connections	
• at the 1st interface acc. to Industrial Ethernet	1
• for power supply	0
Type of electrical connection	
• at the 1st interface acc. to Industrial Ethernet	RJ45 port
Supply voltage, current consumption, power loss	
Type of voltage of the supply voltage	DC
Supply voltage 1 from backplane bus	5 V
Consumed current	
• from backplane bus at DC at 5 V typical	0.25 A
Power loss [W]	1.25 W
Permitted ambient conditions	
Ambient temperature	
• for vertical installation during operation	-20 ... +60 °C
• for horizontally arranged busbars during operation	-20 ... +70 °C
• during storage	-40 ... +70 °C
• during transport	-40 ... +70 °C
Relative humidity at 25 °C without condensation during operation maximum	95%
Protection class IP	IP20

Article number	6GK7243-1JX30-0XE0
Product type designation	CP 1243-1 DNP3
Design, dimensions and weight	
Module format	Compact module S7-1200 single width
Width	30 mm
Height	110 mm
Depth	75 mm
Net weight	0.122 kg
Mounting type	
• 35 mm DIN rail mounting	Yes
• wall mounting	Yes
Product properties, functions, components general	
Number of units	
• per CPU maximum	3
Performance data S7 communication	
Number of possible connections for S7 communication	
• Note	like CPU
Performance data IT functions	
Number of possible connections	
• as e-mail client maximum	1

SIMATIC S7-1200 Basic Controllers

I/O modules

Communication

CP 1243-1 DNP3

Technical specifications (continued)

Article number	6GK7243-1JX30-0XE0
Product type designation	CP 1243-1 DNP3
Performance data telecontrol	
Suitability for use	
• Node station	No
• substation	Yes
• TIM control center	No
Control center connection	control center with DNP3 function supported
• by means of a permanent connection	
• Note	Connection to SCADA system using DNP3 services
Protocol is supported	
• DNP3	Yes
• IEC 60870-5	No
Product function data buffering if connection is aborted	Yes; 64,000 values
Number of data points per station maximum	200

Article number	6GK7243-1JX30-0XE0
Product type designation	CP 1243-1 DNP3
Performance data Teleservice	
Diagnostics function online diagnostics with SIMATIC STEP 7	Yes
Product function	
• program download with SIMATIC STEP 7	Yes
• Remote firmware update	Yes
Configuration software	
• required	STEP 7 Basic/Professional V12 SP1 (TIA Portal) or higher
Product functions Time	
Protocol is supported	
• NTP	No
time synchronization	
• from control center	Yes

Ordering data

Ordering data	Article No.
CP 1243-1 DNP3 communications processor	
Communications processor for connecting SIMATIC S7-1200 to a control center via the DNP3 protocol	6GK7243-1JX30-0XE0
Accessories	
Compact switch module CSM 1277	
Unmanaged switch for connecting a SIMATIC S7-1200 and up to three further nodes to Industrial Ethernet with 10/100 Mbit/s; 4 x RJ45 ports; external 24 V DC power supply, diagnostics LEDs, S7-1200 module including electronic manual on CD-ROM	6GK7277-1AA10-0AA0
IE FC RJ45 plugs	
RJ45 plug connector for Industrial Ethernet with a rugged metal enclosure and integrated insulation displacement contacts for connecting Industrial Ethernet FC installation cables	

Article No.

IE FC RJ45 Plug 180	
180° cable outlet; for network components and CPs/CPU with Industrial Ethernet interface	
• 1 pack = 1 unit	6GK1901-1BB10-2AA0
• 1 pack = 10 units	6GK1901-1BB10-2AB0
• 1 pack = 50 units	6GK1901-1BB10-2AE0
IE FC TP Standard Cable GP 2 x 2 (Type A)	
4-core, shielded TP installation cable for connection to IE FC outlet RJ45/IE F RJ45 Plug; PROFINET-compatible; with UL approval; sold by the meter; max. length 1 000 m, minimum order quantity 20 m	6XV1840-2AH10
IE FC Stripping Tool	
Preadjusted tool for fast stripping of Industrial Ethernet FC cables	6GK1901-1GA00
Engineering Software STEP7 Basic (TIA Portal)	See catalog section 11

Overview



The CP 1243-1 IEC communications processor is used to connect a SIMATIC S7-1200 to a control center system via the IEC 60870 protocol and has the following characteristics:

- Support for the established communication standard in accordance with IEC 60870-5-104 for standardized linking of the SIMATIC S7-1200 to WinCC, PCS 7, or other commercially available control center systems
- Data transfer of measured values, control variables, or alarms optimized for telecontrol systems
- Automatic sending of alert emails
- Clearly laid out LED signaling for fast and easy diagnostics
- Compact industrial enclosure in S7-1200 design for mounting on a standard mounting rail
- Fast commissioning thanks to easy configuration using STEP 7
- Data buffering of up to 64,000 values ensures a secure database even with temporary connection failures

3

Technical specifications

Article number	6GK7243-1PX30-0XE0
Product type designation	CP 1243-1 IEC
Transmission rate	
Transfer rate	
• at the 1st interface	10 ... 100 Mbit/s
Interfaces	
Number of interfaces acc. to Industrial Ethernet	1
Number of electrical connections	
• at the 1st interface acc. to Industrial Ethernet	1
• for power supply	0
Type of electrical connection	
• at the 1st interface acc. to Industrial Ethernet	RJ45 port
Supply voltage, current consumption, power loss	
Type of voltage of the supply voltage	DC
Supply voltage 1 from backplane bus	5 V
Consumed current	
• from backplane bus at DC at 5 V typical	0.25 A
Power loss [W]	1.25 W
Permitted ambient conditions	
Ambient temperature	
• for vertical installation during operation	-20 ... +60 °C
• for horizontally arranged busbars during operation	-20 ... +70 °C
• during storage	-40 ... +70 °C
• during transport	-40 ... +70 °C
Relative humidity at 25 °C without condensation during operation maximum	95%
Protection class IP	IP20

Article number	6GK7243-1PX30-0XE0
Product type designation	CP 1243-1 IEC
Design, dimensions and weight	
Module format	Compact module S7-1200 single width
Width	30 mm
Height	110 mm
Depth	75 mm
Net weight	0.122 kg
Mounting type	
• 35 mm DIN rail mounting	Yes
• wall mounting	Yes
Product properties, functions, components general	
Number of units	
• per CPU maximum	3
Performance data S7 communication	
Number of possible connections for S7 communication	
• Note	like CPU
Performance data IT functions	
Number of possible connections	
• as e-mail client maximum	1

SIMATIC S7-1200 Basic Controllers

I/O modules

Communication

CP 1243-1 IEC

Technical specifications (continued)

Article number	6GK7243-1PX30-0XE0
Product type designation	CP 1243-1 IEC
Performance data telecontrol	
Suitability for use	
• Node station	No
• substation	Yes
• TIM control center	No
Control center connection	control center with IEC 60870-5 function
• by means of a permanent connection	supported
• Note	Connection to SCADA system using IEC 60870-5
Protocol is supported	
• DNP3	No
• IEC 60870-5	Yes
Product function data buffering if connection is aborted	Yes; 64,000 values
Number of data points per station maximum	200

Article number	6GK7243-1PX30-0XE0
Product type designation	CP 1243-1 IEC
Performance data Teleservice	
Diagnostics function online diagnostics with SIMATIC STEP 7	Yes
Product function	
• program download with SIMATIC STEP 7	Yes
• Remote firmware update	Yes
Configuration software	
• required	STEP 7 Basic/Professional V13 (TIA Portal) or higher
Product functions Time	
Protocol is supported	
• NTP	No
time synchronization	
• from control center	Yes

Ordering data

Article No.

CP 1243-1 IEC communications processor

Communications processor for connecting SIMATIC S7-1200 to a control center via the IEC 60870-5-104 protocol

6GK7243-1PX30-0XE0

Accessories

CSM 1277 compact switch module

Unmanaged switch for connecting one SIMATIC S7-1200 and up to three further nodes to Industrial Ethernet with 10/100 Mbps; 4 x RJ45 ports; external 24 V DC power supply, diagnostics LEDs, S7-1200 module including electronic manual on CD-ROM

6GK7277-1AA10-0AA0

IE FC RJ45 plugs

RJ45 plug connector for Industrial Ethernet with a rugged metal housing and integrated insulation displacement contacts for connecting Industrial Ethernet FC installation cables; 180° cable outlet; for network components and CPs/CPUs with Industrial Ethernet interface

- 1 pack = 1 unit
- 1 pack = 10 units
- 1 pack = 50 units

6GK1901-1BB10-2AA0
6GK1901-1BB10-2AB0
6GK1901-1BB10-2AE0

Article No.

IE FC TP Standard Cable GP 2 x 2 (Type A)

4-core, shielded TP installation cable for connection to IE FC outlet RJ45/IE F RJ45 plug; PROFINET-compatible; with UL approval; sold by the meter; max. length 1 000 m, minimum order quantity 20 m

6XV1840-2AH10

IE FC Stripping Tool

Pre-adjusted stripping tool for fast stripping of the Industrial Ethernet FC cables

6GK1901-1GA00

STEP 7 Basic Engineering Software (TIA Portal)

See catalog section 11

Overview



The SIMATIC RF120C is a communication module for connecting the SIMATIC identification systems directly to the SIMATIC S7-1200. The readers of all RFID systems as well as the MV400 optical readers can be operated on the SIMATIC RF120C.

Integration into the TIA Portal and the uniform plug-in connection systems permit fast and simple commissioning.

3

Technical specifications

Article number	6GT2002-0LA00
Product type designation	RF120C communication module
Suitability for operation	SIMATIC S7-1200 together with RF200/300/600, MV400, MOBY D/U
Transmission rate	
Transfer rate at the point-to-point connection serial maximum	115.2 kbit/s
Interfaces	
Design of the interface for point-to-point connection	RS 422
Number of readers connectable	1
Type of electrical connection	
• of the backplane bus	S7-1200 backplane bus
• for supply voltage	Screw terminals
Design of the interface to the reader for communication	D-sub, 9-pin, socket
Mechanical data	
Material	Xantar MX 1094
Color	Ti-grey 24L01
Tightening torque of the screw for securing the equipment maximum	0.45 N·m
Supply voltage, current consumption, power loss	
Supply voltage	
• at DC Rated value	24 V
• at DC	20 ... 30 V
Consumed current at DC at 24 V	
• without connected devices typical	0.03 A
• with connected devices maximum	1 A

Article number	6GT2002-0LA00
Product type designation	RF120C communication module
Permitted ambient conditions	
Ambient temperature	
• during operation	0 ... 55 °C
• during storage	-40 ... +70 °C
• during transport	-40 ... +70 °C
Protection class IP	IP20
Shock resistance	According to IEC 61131-2
Shock acceleration	300 m/s ²
Vibrational acceleration	100 m/s ²
Design, dimensions and weight	
Width	30 mm
Height	100 mm
Depth	75 mm
Net weight	0.15 kg
Mounting type	S7-1200 rack
Cable length for RS 422 interface maximum	1 000 m
Product properties, functions, components general	
Display version	4 LEDs for reader connection, 1 LED for device status
Product function transponder file handler can be addressed	No
Protocol is supported	
• S7 communication	Yes
Type of parameterization	HSP
Type of programming	Library with functions
Type of computer-mediated communication	acyclic communication
Standards, specifications, approvals	
Certificate of suitability	CE, FCC, cULus, KCC, C-Tick, FM, Ex: II 3G Ex nAA IIC T4 Gc
MTBF	196 y

SIMATIC S7-1200 Basic Controllers

I/O modules

Communication

SIMATIC RF120C**Ordering data****Article No.**

SIMATIC RF120C communication module
Integrated in the S7-1200 controller for connection of a reader

6GT2002-0LA00**Accessories for all readers****Reader cable for SIMATIC RF200 / RF300 / RF600 / MV400**

PUR material, CMG approval, suitable for cable carriers, straight reader connector

2 m

6GT2091-4LH20

5 m

6GT2091-4LH50

10 m

6GT2091-4LN10**Article No.****Accessories for extended use****Extension cable for all readers**

PUR material, CMG approval, suitable for cable carriers

2 m, straight connector

6GT2891-4FH20

5 m, straight connector

6GT2891-4FH50

10 m, straight connector

6GT2891-4FN10

20 m, straight connector

6GT2891-4FN20

50 m, straight connector

6GT2891-4FN50

2 m, plug angled at reader

6GT2891-4JH20

5 m, plug angled at reader

6GT2891-4JH50

10 m, plug angled at reader

6GT2891-4JN10**Reader adapter cable for MOBY D**

Material PUR, CMG approval, suitable for cable carriers, 2 m. A cable of the type 6GT2091-4L... is also required.

6GT2691-4FH20**DVD "RFID Systems Software & Documentation"****6GT2080-2AA20**

3

Overview

- For fast, high-performance serial data exchange via point-to-point coupling
- Implemented protocols: ASCII, USS drive protocol, Modbus RTU
- Additional protocols can also be loaded
- Simple parameterization with STEP 7 Basic

Note:

SIPLUS extreme products are based on SIMATIC standard products. The contents listed here were taken from the respective standard products. SIPLUS extreme-specific information was added.

Technical specifications

Article number	6AG1241-1AH32-4XB0	6AG1241-1AH32-2XB0	6AG1241-1CH32-4XB0	6AG1241-1CH32-2XB0
Based on	6ES7241-1AH32-0XB0 SIPLUS S7-1200 CM 1241 RS 232	6ES7241-1AH32-0XB0 SIPLUS S7-1200 CM1241 RS 232	6ES7241-1CH32-0XB0 SIPLUS S7-1200 CM 1241 RS 422/485	6ES7241-1CH32-0XB0 SIPLUS S7-1200 CM 1241 RS 422/485
Ambient conditions				
Free fall				
• Fall height, max.	0.3 m; five times, in product package	0.3 m; five times, in product package	0.3 m; five times, in product package	0.3 m; five times, in product package
Ambient temperature during operation				
• min.	-20 °C; = Tmin; Startup @ 0 °C	-40 °C; = Tmin; Startup @ -25 °C	-20 °C; = Tmin; Startup @ 0 °C	-40 °C; = Tmin; Startup @ -25 °C
• max.	60 °C	70 °C; = Tmax	60 °C; = Tmax	70 °C; Tmax > 60 °C, derating: Max. one module may be configured; this module must be the last module on the CM bus; minimum clearance on the left side of at least 45 mm

SIMATIC S7-1200 Basic Controllers

I/O modules

SIPLUS communication

SIPLUS CM 1241 communication modules

Technical specifications (continued)

Article number	6AG1241-1AH32-4XB0	6AG1241-1AH32-2XB0	6AG1241-1CH32-4XB0	6AG1241-1CH32-2XB0
Based on	6ES7241-1AH32-0XB0 SIPLUS S7-1200 CM 1241 RS 232	6ES7241-1AH32-0XB0 SIPLUS S7-1200 CM1241 RS 232	6ES7241-1CH32-0XB0 SIPLUS S7-1200 CM 1241 RS 422/485	6ES7241-1CH32-0XB0 SIPLUS S7-1200 CM 1241 RS 422/485
Extended ambient conditions				
<ul style="list-style-type: none"> relative to ambient temperature-atmospheric pressure-installation altitude 	Tmin ... Tmax at 1080 hPa ... 795 hPa (-1000 m ... +2000 m) // Tmin ... (Tmax - 10K) at 795 hPa ... 658 hPa (+2000 m ... +3500 m) // Tmin ... (Tmax - 20K) at 658 hPa ... 540 hPa (+3500 m ... +5000 m)	Tmin ... Tmax at 1080 hPa ... 795 hPa (-1000 m ... +2000 m) // Tmin ... (Tmax - 10K) at 795 hPa ... 658 hPa (+2000 m ... +3500 m) // Tmin ... (Tmax - 20K) at 658 hPa ... 540 hPa (+3500 m ... +5000 m)	Tmin ... Tmax at 1080 hPa ... 795 hPa (-1000 m ... +2000 m) // Tmin ... (Tmax - 10K) at 795 hPa ... 658 hPa (+2000 m ... +3500 m) // Tmin ... (Tmax - 20K) at 658 hPa ... 540 hPa (+3500 m ... +5000 m)	Tmin ... Tmax at 1080 hPa ... 795 hPa (-1000 m ... +2000 m) // Tmin ... (Tmax - 10K) at 795 hPa ... 658 hPa (+2000 m ... +3500 m) // Tmin ... (Tmax - 20K) at 658 hPa ... 540 hPa (+3500 m ... +5000 m)
Relative humidity				
- With condensation, tested in accordance with IEC 60068-2-38, max.	100%; RH incl. condensation/frost (no commissioning under condensation conditions)	100%; RH incl. condensation/frost (no commissioning under condensation conditions)	100%; RH incl. condensation/frost (no commissioning under condensation conditions)	100%; RH incl. condensation/frost (no commissioning under condensation conditions)
Resistance				
- against biologically active substances / conformity with EN 60721-3-3	Yes; Class 3B2 mold, fungus and dry rot spores (with the exception of fauna). The supplied connector covers must remain on the unused interfaces during operation!	Yes; Class 3B2 mold, fungus and dry rot spores (with the exception of fauna). The supplied connector covers must remain on the unused interfaces during operation!	Yes; Class 3B2 mold, fungus and dry rot spores (with the exception of fauna). The supplied connector covers must remain on the unused interfaces during operation!	Yes; Class 3B2 mold, fungus and dry rot spores (with the exception of fauna). The supplied connector covers must remain on the unused interfaces during operation!
- against chemically active substances / conformity with EN 60721-3-3	Yes; Class 3C4 (RH < 75%) incl. salt spray according to EN 60068-2-52 (degree of severity 3). The supplied connector covers must remain on the unused interfaces during operation!	Yes; Class 3C4 (RH < 75%) incl. salt spray according to EN 60068-2-52 (degree of severity 3). The supplied connector covers must remain on the unused interfaces during operation!	Yes; Class 3C4 (RH < 75%) incl. salt spray according to EN 60068-2-52 (degree of severity 3). The supplied connector covers must remain on the unused interfaces during operation!	Yes; Class 3C4 (RH < 75%) incl. salt spray according to EN 60068-2-52 (degree of severity 3). The supplied connector covers must remain on the unused interfaces during operation!
- against mechanically active substances / conformity with EN 60721-3-3	Yes; Class 3S4 incl. sand, dust. The supplied connector covers must remain on the unused interfaces during operation!	Yes; Class 3S4 incl. sand, dust. The supplied connector covers must remain on the unused interfaces during operation!	Yes; Class 3S4 incl. sand, dust. The supplied connector covers must remain on the unused interfaces during operation!	Yes; Class 3S4 incl. sand, dust. The supplied connector covers must remain on the unused interfaces during operation!

Ordering data

SIPLUS CM 1241 communication module

(Extended temperature range and exposure to media)

Ambient temperature
-40 ... +70° C

Communication module for point-to-point connection, with one RS 232 interface

6AG1241-1AH32-2XB0

Communication module for point-to-point connection, with one RS 485 interface

6AG1241-1CH32-2XB0

Suitable for areas with extreme medial exposure (conformal coating)

Communication module for point-to-point connection, with one RS 232 interface

6AG1241-1AH32-4XB0

Communication module for point-to-point connection, with one RS 485 interface

6AG1241-1CH32-4XB0

Article No.

Accessories

See SIMATIC S7-1200 CM 1241 communication modules, page 3/123

Overview

- For fast, high-performance serial data exchange via point-to-point connection
- Implemented protocols: ASCII, USS drive protocol, Modbus RTU
- Additional protocols can be loaded later
- Simple parameterization with STEP 7 Basic
- Can be plugged directly into the CPU

Note:

SIPLUS extreme products are based on SIMATIC standard products. The contents listed here were taken from the respective standard products. SIPLUS extreme-specific information was added.

Technical specifications

Article number	6AG1241-1CH30-5XB1
Based on	6ES7241-1CH30-1XB0 SIPLUS S7-1200 CB 1241 RS 485
General information	
Product type designation	CB 1241 RS 485
Input current	
from backplane bus 5 V DC, typ.	50 mA
Power loss	
Power loss, typ.	1.5 W
Interrupts/diagnostics/ status information	
Diagnostic functions	Yes
Diagnostics indication LED	
• for status of the outputs	Yes
Degree and class of protection	
Degree of protection acc. to EN 60529	
• IP20	Yes
Standards, approvals, certificates	
CE mark	Yes
RCM (formerly C-TICK)	Yes
KC approval	Yes
Ambient conditions	
Free fall	
• Fall height, max.	0.3 m; five times, in product package
Ambient temperature during operation	
• min.	-40 °C; = Tmin; Startup @ -25 °C
• max.	55 °C

Article number	6AG1241-1CH30-5XB1
Based on	6ES7241-1CH30-1XB0 SIPLUS S7-1200 CB 1241 RS 485
Extended ambient conditions	
• relative to ambient temperature-atmospheric pressure-installation altitude	Tmin ... Tmax at 1080 hPa ... 795 hPa (-1000 m ... +2000 m) // Tmin ... (Tmax - 10K) at 795 hPa ... 658 hPa (+2000 m ... +3500 m) // Tmin ... (Tmax - 20K) at 658 hPa ... 540 hPa (+3500 m ... +5000 m)
• At cold restart, min.	-25 °C
Relative humidity	
- With condensation, tested in accordance with IEC 60068-2-38, max.	100%; RH incl. condensation/frost (no commissioning under condensation conditions)
Pollutant concentrations	
- SO2 at RH < 60% without condensation	SO2: < 0.5 ppm; H2S: < 0.1 ppm; RH < 60 % condensation-free
Resistance	
- against biologically active substances / conformity with EN 60721-3-3	Yes; Class 3B2 mold, fungus and dry rot spores (with the exception of fauna). The supplied connector covers must remain on the unused interfaces during operation!
- against chemically active substances / conformity with EN 60721-3-3	Yes; Class 3C4 (RH < 75%) incl. salt spray according to EN 60068-2-52 (degree of severity 3). The supplied connector covers must remain on the unused interfaces during operation!
- against mechanically active substances / conformity with EN 60721-3-3	Yes; Class 3S4 incl. sand, dust. The supplied connector covers must remain on the unused interfaces during operation!

Ordering data

SIPLUS CB 1241 RS 485 communication board

For point-to-point connection, with 1 RS 485 interface

Article No.

6AG1241-1CH30-5XB1

Article No.

Accessories

See SIMATIC CB 1241 RS 485 communication board, page 3/124

SIMATIC S7-1200 Basic Controllers

I/O modules

SIPLUS communication

SIPLUS CM 1242-5 communication modules

Overview



DP-M	DP-S	FMS	PG/OP	S7
	●			

The SIPLUS CM 1242-5 communication module is used to connect a SIMATIC S7-1200 to PROFIBUS as a DP slave and has the following characteristics:

- PROFIBUS DPV1 slave in accordance with IEC 61158
- Module replacement without PG supported
- Power is supplied via the backplane bus so that no extra cabling is required
- Support of all standard baud rates from 9.6 Kbit/s to 12 Mbit/s
- Compact industry-standard enclosure in S7-1200 design for mounting on a standard mounting rail
- Fast commissioning thanks to easy configuration using STEP 7 without additional programming overhead

The CM 1242-5 is intended for use in factory automation. Low-cost PROFIBUS-based automation solutions can be created on the basis of the S7-1200 for optimal production.

Note:

SIPLUS extreme products are based on SIMATIC standard products. The contents listed here were taken from the respective standard products. SIPLUS extreme specific information was added.

SIPLUS S7-1200 CM 1242-5

Article number	6AG1 242-5DX30-2XE0
Article number based on	6GK7 242-5DX30-0XE0
Ambient temperature range	-25 ... +55 °C
Ambient conditions	Suitable for exceptional exposure to media (e.g. sulfur chlorine atmosphere).
Technical data	The technical data of the standard product applies except for the ambient conditions.
Ambient conditions	
Relative humidity	100%, condensation/frost permitted. No commissioning in bedewed state.
Biologically active substances, compliance with EN 60721-3-3	Class 3B2 mold and fungal spores (excluding fauna). The supplied plug covers must remain in place over the unused interfaces during operation!
Chemically active substances, compliance with EN 60721-3-3	Class 3C4 incl. salt spray in accordance with EN60068-2-52 (degree of severity 3). The supplied plug covers must remain in place over the unused interfaces during operation!
Mechanically active substances, compliance with EN 60721-3-3	Class 3S4 incl. sand, dust. The supplied plug covers must remain in place over the unused interfaces during operation!
Air pressure (depending on the highest positive temperature range specified)	1 080 ... 795 hPa (-1 000 ... +2 000 m) 795 ... 658 hPa (+2 000 ... +3 500 m) derating 10 K 658 ... 540 hPa (+3 500 ... +5 000 m) derating 20 K

Technical documentation on SIPLUS can be found here:
<http://www.siemens.de/siplus-extreme>

Ordering data

Article No.

SIPLUS communication module CM 1242-5

(Extended temperature range and exposure to media)

Communication module for electrical connection of SIMATIC S7-1200 to PROFIBUS as a DPV1 slave

6AG1242-5DX30-2XE0

Accessories

See SIMATIC S7-1200 CM 1242-5 communication module, page 3/126

Overview



DP-M	DP-S	FMS	PG/OP	S7
●			●	●

The CM 1243-5 communication module is used to connect a SIMATIC S7-1200 to PROFIBUS as a DP master and has the following characteristics:

- PROFIBUS DPV1 master in accordance with IEC 61158
- Support of up to 16 PROFIBUS DP slaves
- Communication with other S7 controllers based on S7 communication
- Allows the connection of programming devices and operator panels with a PROFIBUS interface to the S7-1200
- Module replacement without PG supported
- Support of all standard baud rates from 9.6 Kbit/s to 12 Mbit/s
- Compact industry-standard enclosure in S7-1200 design for mounting on a standard mounting rail
- Fast commissioning thanks to easy configuration using STEP 7 without additional programming overhead

The CM 1243-5 is intended for use in factory automation. Low-cost PROFIBUS-based automation solutions can be created on the basis of the S7-1200 for optimal production.

Note:

SIPLUS extreme products are based on SIMATIC standard products. The contents listed here were taken from the respective standard products. SIPLUS extreme specific information was added.

SIPLUS S7-1200 CM 1243-5

Article number	6AG1 243-5DX30-2XE0
Article number based on	6GK7 243-5DX30-0XE0
Ambient temperature range	-25 ... +70 °C
Ambient conditions	Suitable for exceptional exposure to media (e.g. sulfur chlorine atmosphere).
Technical data	The technical data of the standard product applies except for the ambient conditions.
Ambient conditions	
Relative humidity	100%, condensation/frost permitted. No commissioning in bedewed state.
Biologically active substances, compliance with EN 60721-3-3	Class 3B2 mold and fungal spores (excluding fauna). The supplied plug covers must remain in place over the unused interfaces during operation!
Chemically active substances, compliance with EN 60721-3-3	Class 3C4 incl. salt spray in accordance with EN60068-2-52 (degree of severity 3). The supplied plug covers must remain in place over the unused interfaces during operation!
Mechanically active substances, compliance with EN 60721-3-3	Class 3S4 incl. sand, dust. The supplied plug covers must remain in place over the unused interfaces during operation!
Air pressure (depending on the highest positive temperature range specified)	1 080 ... 795 hPa (-1 000 ... +2 000 m) 795 ... 658 hPa (+2 000 ... +3 500 m) derating 10 K 658 ... 540 hPa (+3 500 ... +5 000 m) derating 20 K

Technical documentation on SIPLUS can be found here:
<http://www.siemens.com/siplus-extreme>

Ordering data

Article No.

SIPLUS CM 1243-5 communication module

(Extended temperature range and exposure to media)

Communication module for electrical connection of SIMATIC S7-1200 to PROFIBUS as a DPV1 master

6AG1243-5DX30-2XE0

Accessories

See SIMATIC S7-1200 CM 1243-5 communication module, page 3/130

SIMATIC S7-1200 Basic Controllers

I/O modules

SIPLUS communication

SIPLUS NET CSM 1277**Overview**

- Unmanaged switch for connection of SIPLUS S7-1200 to an Industrial Ethernet network with a line, tree or star topology
- Multiplication of Ethernet interfaces on a SIPLUS S7-1200 for additional connection of up to three programming devices, operator controls, and further Ethernet nodes
- Simple, space-saving mounting on the SIPLUS S7-1200 rail
- Low-cost solution for implementing small, local Ethernet networks
- Problem-free connection using RJ45 plugs
- Simple and fast status display via LEDs on the device
- Integral autocrossover function permits use of uncrossed connecting cables

Note:

SIPLUS extreme products are based on SIMATIC standard products. The contents listed here were taken from the respective standard products. SIPLUS extreme-specific information was added.

SIPLUS NET CSM 1277	
Article number	6AG1 277-1AA10-4AA0
Article number based on	6GK7 277-1AA10-0AA0
Ambient temperature range	0 ... +60 °C

Ordering data**Article No.****SIPLUS NET CSM 1277 compact switch module**

(Extended temperature range and exposure to media)

Unmanaged switch for connection of SIPLUS S7-1200 and up to three further nodes to Industrial Ethernet with 10/100 Mbit/s; 4 x RJ45 ports; external 24 V DC power supply, LED diagnostics, S7-1200 module including electronic Manual on CD-ROM

6AG1 277-1AA10-4AA0**Accessories**

See CSM 1277 unmanaged, page 3/132

Overview



- Digital inputs as supplement to the integral I/O of the CPUs
- Integrated into the overall automation for the implementation of safety-related requirements
- With integrated safety functions
- Communication with fail-safe CPUs via PROFIsafe mechanisms
- For flexible adaptation of the controller to the corresponding task
- For subsequent expansion of the system with additional inputs
- Operable exclusively in the central system

3

Technical specifications

Article number	6ES7226-6BA32-0XB0 DIGITAL INPUT SM 1226, F-DI 16X 24VDC
General information	
Product type designation	SM 1226 F-DI 16x24VDC
Supply voltage	
Rated value (DC)	
• 24 V DC	Yes
Input current	
from backplane bus 5 V DC, max.	155 mA; Current consumption (SM Bus, 5 V DC): 155 mA
Digital inputs	
• from load voltage L+ (without load), max.	130 mA; 130 mA + 6 mA / input used + any Vs1/Vs2 current used
Power loss	
Power loss, typ.	7 W
Digital inputs	
Number of digital inputs	16; 16 (1oo1) or 8 (1oo2); Note: You can individually assign each pair of inputs "a.x" and "b.x" as a single (1oo2)-channel or as 2 separate (1oo1)-channels
horizontal installation	
- up to 50 °C, max.	16; 16 inputs at 55 °C horizontal
vertical installation	
- up to 40 °C, max.	16; 16 inputs at 45 °C vertical
Input voltage	
• Type of input voltage	DC
• for signal "0"	-30 V DC to +5 V DC
• for signal "1"	15 V DC to 30 V DC
Input current	
• for signal "0", max. (permissible quiescent current)	0.5 mA
Input delay (for rated value of input voltage) for standard inputs	
- parameterizable	Yes; 0.8 / 1.6 / 3.2 / 6.4 / 12.8 ms

Article number	6ES7226-6BA32-0XB0 DIGITAL INPUT SM 1226, F-DI 16X 24VDC
Cable length	
• shielded, max.	200 m; Unshielded with input filter time of 1.6 ms to 12.6 ms (With an input delay of 0.8 ms, shielded cables must be used for the digital inputs and the sensor supply)
• unshielded, max.	200 m; Shielded with input filter time of 0.8 ms to 12.6 s (With an input delay of 0.8 ms, shielded cables must be used for the digital inputs and the sensor supply)
Diagnostics indication LED	
• for status of the inputs	Yes
Standards, approvals, certificates	
CE mark	Yes
cULus	Yes
FM approval	Yes
Highest safety class achievable in safety mode	
• SIL acc. to IEC 61508	SIL 2 (single-channel), SIL 3 (two-channel)
Ambient conditions	
Free fall	
• Fall height, max.	0.3 m; five times, in product package
Ambient temperature during operation	
• min.	0 °C
• max.	55 °C
Mechanics/material	
Enclosure material (front)	
• Plastic	Yes
Dimensions	
Width	70 mm
Height	100 mm
Depth	75 mm
Weights	
Weight, approx.	250 g

SIMATIC S7-1200 Basic Controllers

I/O modules

Fail-safe digital modules

SM 1226 fail-safe digital input modules**Ordering data****Article No.****SM 1226 fail-safe digital input signal module**

16 inputs, 24 V DC
(SIL 2/category 3/PL d) or
8 inputs 24 V DC
(SIL 3/category 3 or
category 4/PL e)
or a combination of both

6ES7 226-6BA32-0XB0**Accessories****Terminal block (spare part)**

With 11 screws, tin-coated; 4 units

6ES7292-1AL30-0XA0**Front flap set (spare part)**

For modules with a width of 70 mm

6ES7291-1BB30-0XA0**STEP 7 Safety Advanced V14 SP1****Task:**

Engineering tool for configuring and programming fail-safe user programs for SIMATIC S7-1200 FC, S7-1500F, S7-1500F Software Controller, S7-300F, S7-400F, WinAC RTX F, ET 200SP F Controller and the fail-safe ET 200SP, ET 200S, ET 200M, ET 200iSP, ET 200pro and ET 200eco I/O

Requirement:

STEP 7 Professional V14 SP1

Floating license for 1 user, software and documentation on DVD; license key on USB flash drive

6ES7833-1FA14-0YA5

Floating license for 1 user, software, documentation and license key for download¹⁾; email address required for delivery

6ES7833-1FA14-0YH5**Article No.****STEP 7 Safety Basic V14 SP1****Task:**

Engineering tool for configuring fail-safe user programs for SIMATIC S7-1200 FC

Requirement:

STEP 7 Basic V14 SP1 and higher

Floating license for 1 user; software and documentation on DVD; license key on USB flash drive

6ES7833-1FB14-0YA5

Floating license for 1 user; software, documentation and license key for download¹⁾; email address required for delivery

6ES7833-1FB14-0YH5

¹⁾ For up-to-date information and download availability, see: <http://www.siemens.com/tia-online-software-delivery>

Overview

- Digital outputs as a supplement to the integral I/O of the CPUs
- Integrated into the overall automation for the implementation of safety-related requirements
- With integrated safety functions
- Communication with fail-safe CPUs via PROFIsafe mechanisms
- For flexible adaptation of the controller to the corresponding task
- For subsequent expansion of the system with additional outputs
- Operable exclusively in the central system

3

Technical specifications

Article number	6ES7226-6DA32-0XB0 DIGITAL OUTPUT SM 1226, F-DQ 4X 24VDC
General information	
Product type designation	SM 1226 F-DQ 4 x 24 V DC
Supply voltage	
Rated value (DC)	
• 24 V DC	Yes
Input current	
from backplane bus 5 V DC, max.	125 mA
Digital outputs	
• from load voltage L+, max.	170 mA
Power loss	
Power loss, typ.	8 W
Digital outputs	
Number of digital outputs	4
• in groups of	1
Short-circuit protection	Yes
Switching capacity of the outputs	
• with resistive load, max.	30 Hz
• on lamp load, max.	10 Hz
Output voltage	
• Rated value (DC)	24 V
Output current	
• for signal "1" rated value	2 A
• for signal "1" permissible range, max.	10 mA to 2.4 A
• for signal "0" residual current, max.	P-switch: 0.5 mA, maximum; M-switch: 0.5 mA, maximum
Cable length	
• shielded, max.	200 m
• unshielded, max.	200 m
Diagnostics indication LED	
• for status of the outputs	Yes

Article number	6ES7226-6DA32-0XB0 DIGITAL OUTPUT SM 1226, F-DQ 4X 24VDC
Standards, approvals, certificates	
CE mark	Yes
cULus	Yes
FM approval	Yes
Highest safety class achievable in safety mode	
• SIL acc. to IEC 61508	SIL 3
Ambient conditions	
Free fall	
• Fall height, max.	0.3 m; five times, in product package
Ambient temperature during operation	
• min.	0 °C
• max.	55 °C
Mechanics/material	
Enclosure material (front)	
• Plastic	Yes
Dimensions	
Width	70 mm
Height	100 mm
Depth	75 mm
Weights	
Weight, approx.	270 g

SIMATIC S7-1200 Basic Controllers

I/O modules

Fail-safe digital modules

SM 1226 fail-safe digital output modules

Ordering data	Article No.	Ordering data	Article No.
SM 1226 fail-safe digital output signal module 4 outputs; 24 V DC, current sourcing/sinking	6ES7226-6DA32-0XB0	STEP 7 Safety Basic V14 SP1 Task: Engineering tool for configuring fail-safe user programs for SIMATIC S7-1200 FC Requirement: STEP 7 Basic V14 SP1 and higher	
Accessories			
Terminal block (spare part) With 11 screws, tin-coated; 4 units	6ES7292-1AL30-0XA0	Floating license for 1 user; software and documentation on DVD; license key on USB flash drive	6ES7833-1FB14-0YA5
Front flap set (spare part) For modules with a width of 70 mm	6ES7291-1BB30-0XA0	Floating license for 1 user; software, documentation and license key for download ¹⁾ ; email address required for delivery	6ES7833-1FB14-0YH5
STEP 7 Safety Advanced V14 SP1 Task: Engineering tool for configuring and programming fail-safe user programs for SIMATIC S7-1200 FC, S7-1500F, S7-1500F Software Controller, S7-300F, S7-400F, WinAC RTX F, ET 200SP F Controller and the fail-safe ET 200SP, ET 200S, ET 200M, ET 200iSP, ET 200pro and ET 200eco I/O Requirement: STEP 7 Professional V14 SP1 Floating license for 1 user, software and documentation on DVD; license key on USB flash drive Floating license for 1 user, software, documentation and license key for download ¹⁾ ; email address required for delivery	6ES7833-1FA14-0YA5 6ES7833-1FA14-0YH5		

¹⁾ For up-to-date information and download availability, see: <http://www.siemens.com/tia-online-software-delivery>

Overview



- Relay outputs as a supplement to the integral I/O of the CPUs
- Integrated into the overall automation for the implementation of safety-related requirements
- With integrated safety functions
- Communication with fail-safe CPUs via PROFIsafe mechanisms
- For flexible adaptation of the controller to the corresponding task
- For subsequent expansion of the system with additional outputs
- Operable exclusively in the central system

3

Technical specifications

Article number	6ES7226-6RA32-0XB0 DIGITAL OUTPUT SM 1226, F-DQ 2X RELAY
General information	
Product type designation	SM 1226 F-DQ 2 x Relay
Supply voltage	
Rated value (DC)	
• 24 V DC	Yes
Input current	
from backplane bus 5 V DC, max.	120 mA
Digital outputs	
• from load voltage L+, max.	300 mA
Power loss	
Power loss, typ.	10 W
Digital outputs	
Number of digital outputs	2
Short-circuit protection	No
Output voltage	
• Rated value (DC)	5 V DC to 30 V DC
• Rated value (AC)	5 V AC to 250 V AC
Output current	
• for signal "1" permissible range, max.	5 A maximum per circuit and 10 A maximum of all circuits per module
Relay outputs	
• Number of relay outputs	2; 2 circuits per output
Switching capacity of contacts	
- with inductive load, max.	0.1 Hz, accordance with IEC 60947-5-1, DC-13; 2 Hz, accordance with IEC 60947-5-1, AC-15
- with resistive load, max.	2 Hz
Cable length	
• shielded, max.	200 m
• unshielded, max.	200 m
Diagnostics indication LED	
• for status of the outputs	Yes

Article number	6ES7226-6RA32-0XB0 DIGITAL OUTPUT SM 1226, F-DQ 2X RELAY
Standards, approvals, certificates	
CE mark	Yes
cULus	Yes
FM approval	Yes
Highest safety class achievable in safety mode	
• SIL acc. to IEC 61508	SIL 3
Ambient conditions	
Free fall	
• Fall height, max.	0.3 m; five times, in product package
Ambient temperature during operation	
• min.	0 °C
• max.	55 °C
Mechanics/material	
Enclosure material (front)	
• Plastic	Yes
Dimensions	
Width	70 mm
Height	100 mm
Depth	75 mm
Weights	
Weight, approx.	300 g

SIMATIC S7-1200 Basic Controllers

I/O modules

Fail-safe digital modules

SM 1226 fail-safe relay output modules**Ordering data****Article No.****SM 1226 fail-safe relay output signal module****6ES7226-6RA32-0XB0**

2 relay outputs

Accessories**Terminal block (spare part)**

With 11 screws, tin-coated, coded; 4 units

6ES7292-1AL40-0XA0**Front flap set (spare part)**

For modules with a width of 70 mm

6ES7291-1BB30-0XA0**STEP 7 Safety Advanced V14 SP1****Task:**

Engineering tool for configuring and programming fail-safe user programs for SIMATIC S7-1200 FC, S7-1500F, S7-1500F Software Controller, S7-300F, S7-400F, WinAC RTX F, ET 200SP F Controller and the fail-safe ET 200SP, ET 200S, ET 200M, ET 200iSP, ET 200pro and ET 200eco I/O

Requirement:

STEP 7 Professional V14 SP1

Floating license for 1 user, software and documentation on DVD; license key on USB flash drive

6ES7833-1FA14-0YA5

Floating license for 1 user, software, documentation and license key for download¹⁾; email address required for delivery

6ES7833-1FA14-0YH5**Article No.****STEP 7 Safety Basic V14 SP1****Task:**

Engineering tool for configuring fail-safe user programs for SIMATIC S7-1200 FC

Requirement:

STEP 7 Basic V14 SP1 and higher

Floating license for 1 user; software and documentation on DVD; license key on USB flash drive

6ES7833-1FB14-0YA5

Floating license for 1 user; software, documentation and license key for download¹⁾; email address required for delivery

6ES7833-1FB14-0YH5

¹⁾ For up-to-date information and download availability, see: <http://www.siemens.com/tia-online-software-delivery>

Overview



- Digital inputs as supplement to the integral I/O of the CPUs
- Integrated into the overall automation for the implementation of safety-related requirements
- With integrated safety functions
- Communication with fail-safe CPUs via PROFIsafe mechanisms
- For flexible adaptation of the controller to the corresponding task
- For subsequent expansion of the system with additional inputs
- Operable exclusively in the central system

Note

SIPLUS extreme products are based on SIMATIC standard products. The contents listed here were taken from the corresponding standard products. SIPLUS extreme-specific information was added.

Technical specifications

Article number	6AG1226-6BA32-5XB0
Based on	6ES7226-6BA32-0XB0 SIPLUS S7-1200 SM 1226 F-DI 16x24VDC
Ambient conditions	
Free fall	
• Fall height, max.	0.3 m; five times, in product package
Ambient temperature during operation	
• min.	-25 °C; = Tmin
• max.	55 °C; = Tmax
Extended ambient conditions	
• relative to ambient temperature-atmospheric pressure-installation altitude	Tmin ... Tmax at 1080 hPa ... 795 hPa (-1000 m ... +2000 m)
Relative humidity	
- With condensation, tested in accordance with IEC 60068-2-38, max.	100%; RH incl. condensation/frost (no commissioning under condensation conditions)
Resistance	
- against biologically active substances / conformity with EN 60721-3-3	Yes; Class 3B2 mold, fungus and dry rot spores (with the exception of fauna). The supplied connector covers must remain on the unused interfaces during operation!
- against chemically active substances / conformity with EN 60721-3-3	Yes; Class 3C4 (RH < 75%) incl. salt spray according to EN 60068-2-52 (degree of severity 3). The supplied connector covers must remain on the unused interfaces during operation!
- against mechanically active substances / conformity with EN 60721-3-3	Yes; Class 3S4 incl. sand, dust. The supplied connector covers must remain on the unused interfaces during operation!

Ordering data

SIPLUS SM 1226 fail-safe digital input signal module
(Extended temperature range and environmental stress)
16 inputs, 24 V DC (SIL 2/category 3/PL d) or
8 inputs 24 V DC (SIL 3/category 3 or category 4/PL e)
or a combination of both

Article No.

6AG1226-6BA32-5XB0

Accessories

See SIMATIC SM 1226 fail-safe digital input signal module, page 3/158

SIMATIC S7-1200 Basic Controllers

I/O modules

SIPLUS Fail-safe

SIPLUS SM 1226 fail-safe digital output modules**Overview**

- Digital outputs as a supplement to the integral I/O of the CPUs
- Integrated into the overall automation for the implementation of safety-related requirements
- With integrated safety functions
- Communication with fail-safe CPUs via PROFIsafe mechanisms
- For flexible adaptation of the controller to the corresponding task
- For subsequent expansion of the system with additional outputs
- Operable exclusively in the central system

Note

SIPLUS extreme products are based on SIMATIC standard products. The contents listed here were taken from the corresponding standard products. SIPLUS extreme-specific information was added.

Technical specifications

Article number	6AG1226-6DA32-5XB0
Based on	6ES7226-6DA32-0XB0 SIPLUS S7-1200 SM 1226 F-DQ 4x24VDC
Ambient conditions	
Free fall	
• Fall height, max.	0.3 m; five times, in product package
Ambient temperature during operation	
• min.	-25 °C; = Tmin
• max.	55 °C; = Tmax
Extended ambient conditions	
• relative to ambient temperature-atmospheric pressure-installation altitude	Tmin ... Tmax at 1080 hPa ... 795 hPa (-1000 m ... +2000 m)
Relative humidity	
- With condensation, tested in accordance with IEC 60068-2-38, max.	100%; RH incl. condensation/frost (no commissioning under condensation conditions)
Resistance	
- against biologically active substances / conformity with EN 60721-3-3	Yes; Class 3B2 mold, fungus and dry rot spores (with the exception of fauna). The supplied connector covers must remain on the unused interfaces during operation!
- against chemically active substances / conformity with EN 60721-3-3	Yes; Class 3C4 (RH < 75%) incl. salt spray according to EN 60068-2-52 (degree of severity 3). The supplied connector covers must remain on the unused interfaces during operation!
- against mechanically active substances / conformity with EN 60721-3-3	Yes; Class 3S4 incl. sand, dust. The supplied connector covers must remain on the unused interfaces during operation!

Ordering data**Article No.**

SIPLUS SM 1226 fail-safe digital output module	6AG1226-6DA32-5XB0
4 outputs; 24 V DC, current sourcing/sinking	
Accessories	See SIMATIC SM 1226 fail-safe digital output signal module, page 3/160

Overview



- Relay outputs as a supplement to the integral I/O of the CPUs
- Integrated into the overall automation for the implementation of safety-related requirements
- With integrated safety functions
- Communication with fail-safe CPUs via PROFIsafe mechanisms
- For flexible adaptation of the controller to the corresponding task
- For subsequent expansion of the system with additional outputs
- Operable exclusively in the central system

Note

SIPLUS extreme products are based on SIMATIC standard products. The contents listed here were taken from the corresponding standard products. SIPLUS extreme-specific information was added.

Technical specifications

Article number	6AG1226-6RA32-5XB0
Based on	6ES7226-6RA32-0XB0 SIPLUS S7-1200 SM 1226 F-DQ 2xRelay
Ambient conditions	
Free fall	
• Fall height, max.	0.3 m; five times, in product package
Ambient temperature during operation	
• min.	-25 °C; = Tmin
• max.	55 °C; = Tmax
Extended ambient conditions	
• relative to ambient temperature-atmospheric pressure-installation altitude	Tmin ... Tmax at 1080 hPa ... 795 hPa (-1000 m ... +2000 m)
Relative humidity	
- With condensation, tested in accordance with IEC 60068-2-38, max.	100%; RH incl. condensation/frost (no commissioning under condensation conditions)
Resistance	
- against biologically active substances / conformity with EN 60721-3-3	Yes; Class 3B2 mold, fungus and dry rot spores (with the exception of fauna). The supplied connector covers must remain on the unused interfaces during operation!
- against chemically active substances / conformity with EN 60721-3-3	Yes; Class 3C4 (RH < 75%) incl. salt spray according to EN 60068-2-52 (degree of severity 3). The supplied connector covers must remain on the unused interfaces during operation!
- against mechanically active substances / conformity with EN 60721-3-3	Yes; Class 3S4 incl. sand, dust. The supplied connector covers must remain on the unused interfaces during operation!

Ordering data

Ordering data	Article No.
SIPLUS SM 1226 fail-safe relay output signal module	6AG1226-6RA32-5XB0
2 relay outputs	
Accessories	See SIMATIC SM 1226 fail-safe relay output signal module, page 3/162

SIMATIC S7-1200 Basic Controllers

Power supplies

Single phase, 24 V DC (for S7-1200)

Overview



In terms of design and functionality, the SIMATIC PM 1207 single-phase load power supply (PM = power module) with automatic range selection of the input voltage is an optimal match to the SIMATIC S7-1200 PLC. It provides the supply to CPUs with 24 V input as well as to signal modules, and to 24 V loads connected to the modules. Comprehensive certifications, such as UL, ATEX and GL facilitate universal use.

Technical specifications

Article number	6EP1332-1SH71
Product	S7-1200 PM1207
Power supply, type	24 V/2.5 A
Input	
Input	1-phase AC
Supply voltage	
• 1 at AC Rated value	120 V
• 2 at AC Rated value	230 V
• Note	Automatic range selection
Input voltage	
• 1 at AC	85 ... 132 V
• 2 at AC	176 ... 264 V
Wide-range input	No
Overvoltage resistance	$2.3 \times V_{in \text{ rated}}$, 1.3 ms
Mains buffering at $I_{out \text{ rated}}$, min.	20 ms; at $V_{in} = 93/187 \text{ V}$
Rated line frequency 1	50 Hz
Rated line frequency 2	60 Hz
Rated line range	47 ... 63 Hz
Input current	
• at rated input voltage 120 V	1.2 A
• at rated input voltage 230 V	0.67 A
Switch-on current limiting (+25 °C), max.	13 A
Duration of inrush current limiting at 25 °C	
• maximum	3 ms
I^2t , max.	0.5 A ² ·s
Built-in incoming fuse	T 3, 15 A/250 V (not accessible)
Protection in the mains power input (IEC 898)	Recommended miniature circuit breaker: 16 A characteristic B or 10 A characteristic C

Article number	6EP1332-1SH71
Product	S7-1200 PM1207
Power supply, type	24 V/2.5 A
Output	
Output	Controlled, isolated DC voltage
Rated voltage $V_{out \text{ DC}}$	24 V
Total tolerance, static \pm	3%
Static mains compensation, approx.	0.1%
Static load balancing, approx.	0.2%
Residual ripple peak-peak, max.	150 mV
Spikes peak-peak, max. (bandwidth: 20 MHz)	240 mV
Product function Output voltage adjustable	No
Output voltage setting	-
Status display	Green LED for 24 V OK
On/off behavior	No overshoot of V_{out} (soft start)
Startup delay, max.	6 s; 2 s at 230 V, 6 s at 120 V
Voltage rise, typ.	10 ms
Rated current value $I_{out \text{ rated}}$	2.5 A
Current range	0 ... 2.5 A
Supplied active power typical	60 W
Short-term overload current	
• on short-circuiting during the start-up typical	6 A
• at short-circuit during operation typical	6 A
Duration of overloading capability for excess current	
• on short-circuiting during the start-up	100 ms
• at short-circuit during operation	100 ms
Parallel switching for enhanced performance	Yes
Numbers of parallel switchable units for enhanced performance	2

Technical specifications (continued)

Article number	6EP1332-1SH71
Product	S7-1200 PM1207
Power supply, type	24 V/2.5 A
Efficiency	
Efficiency at $V_{out rated}$, $I_{out rated}$, approx.	83%
Power loss at $V_{out rated}$, $I_{out rated}$, approx.	12 W
Closed-loop control	
Dynamic mains compensation ($V_{in rated} \pm 15\%$), max.	0.3%
Dynamic load smoothing (I _{out} : 50/100/50%), $U_{out} \pm$ typ.	3%
Load step setting time 50 to 100%, typ.	5 ms
Load step setting time 100 to 50%, typ.	5 ms
Setting time maximum	5 ms
Protection and monitoring	
Output overvoltage protection	< 33 V
Current limitation, typ.	2.65 A
Property of the output Short-circuit proof	Yes
Short-circuit protection	Constant current characteristic
Enduring short circuit current RMS value	
• typical	2.7 A
Overload/short-circuit indicator	-
Safety	
Primary/secondary isolation	Yes
Galvanic isolation	Safety extra-low output voltage U_{out} acc. to EN 60950-1 and EN 50178
Protection class	Class I
Leakage current	
• maximum	3.5 mA
CE mark	Yes
UL/cUL (CSA) approval	cULus-Listed (UL 508, CSA C22.2 No. 107.1), File E197259; cURus-Recognized (UL 60950-1, CSA C22.2 No. 60950-1) File E151273
Explosion protection	ATEX (EX) II 3G Ex nA II T4; cULus (ISA 12.12.01, CSA C22.2 No.213) Class I, Div. 2, Group ABCD, T4, File E330455
FM approval	Class I, Div. 2, Group ABCD, T4
CB approval	Yes
Marine approval	GL, ABS, BV, DNV, LRS, NK
Degree of protection (EN 60529)	IP20

Article number	6EP1332-1SH71
Product	S7-1200 PM1207
Power supply, type	24 V/2.5 A
EMC	
Emitted interference	EN 55022 Class B
Supply harmonics limitation	not applicable
Noise immunity	EN 61000-6-2
Operating data	
Ambient temperature	
• during operation	0 ... 60 °C
- Note	with natural convection
• during transport	-40 ... +85 °C
• during storage	-40 ... +85 °C
Humidity class according to EN 60721	Climate class 3K3, no condensation
Mechanics	
Connection technology	screw-type terminals
Connections	
• Supply input	L, N, PE: 1 screw terminal each for 0.5 ... 2.5 mm ²
• Output	L+, M: 2 screw terminals each for 0.5 ... 2.5 mm ²
• Auxiliary	-
Width of the enclosure	70 mm
Height of the enclosure	100 mm
Depth of the enclosure	75 mm
Required spacing	
• top	20 mm
• bottom	20 mm
• left	0 mm
• right	0 mm
Weight, approx.	0.3 kg
Product feature of the enclosure housing for side-by-side mounting	Yes
Installation	Snaps onto DIN rail EN 60715 35x7.5/15, wall mounting
MTBF at 40 °C	1 492 537 h
Other information	Specifications at rated input voltage and ambient temperature +25 °C (unless otherwise specified)

Ordering data

Article No.

SIMATIC S7-1200 PM 1207

 Input: 120/230 V AC
 Output: 24 V DC/2.5 A

6EP1332-1SH71

SIMATIC S7-1200 Basic Controllers

SIPLUS power supplies

Single phase, 24 V DC (for SIPLUS S7-1200)

Overview



- Stabilized power supply for SIPLUS S7-1200
- In the S7-1200 design
- Input 120/230 V AC, output 24 V DC, 2.5 A (derating: 1.5 A above 60 °C)

Note:

SIPLUS extreme products are based on SIMATIC standard products. The contents listed here were adopted from the respective standard products. SIPLUS extreme specific information was added.

SIPLUS power supply PM 1207

Article number	6AG1332-1SH71-4AA0	6AG1332-1SH71-7AA0
Article number based on	6EP1332-1SH71	
Ambient temperature range	0 ... +60° C	-25 ... +70° C
Conformal coating	Coating of the printed circuit boards and the electronic components	
Technical specifications	The technical data of the standard product applies except for the ambient conditions.	
Ambient conditions		
Relative humidity	100%, condensation/frost permitted. No commissioning in bedewed state.	
Biologically active substances, compliance with EN 60721-3-3	Class 3B2 mold and fungal spores (excluding fauna). The supplied plug covers must remain in place over the unused interfaces during operation!	
Chemically active substances, compliance with EN 60721-3-3	Class 3C4 incl. salt spray in accordance with EN60068-2-52 (degree of severity 3). The supplied plug covers must remain in place over the unused interfaces during operation!	
Mechanically active substances, compliance with EN 60721-3-3	Class 3S4 incl. sand, dust. The supplied plug covers must remain in place over the unused interfaces during operation!	
Air pressure (depending on the highest positive temperature range specified)	1 080 ... 795 hPa (-1 000 ... +2 000 m) see ambient temperature range 795 ... 658 hPa (+2000 ... +3500 m) derating 10 K 658 ... 540 hPa (+3500 ... +5000 m) derating 20 K	

Technical documentation on SIPLUS can be found here:

<http://www.siemens.com/siplus-extreme>

Technical specifications

Article number	SIPLUS PM 1207 6AG1332-1SH71-7AA0 6AG1332-1SH71-4AA0
Article number based on	6EP1332-1SH71
Input voltage, nominal value	120/230 V AC (auto-switching)
• Range	85...132 V / 176...264 V AC
Mains buffering	> 20 ms (at 93/187 V)
Line frequency, nominal	50/60 Hz
• Range	47 ... 63 Hz
Input current, nominal value	1.2/0.67 A
• Inrush current (25 °C)	<13 A
• Recommended circuit-breaker	16 A Charact. B, 10 A Charact. C
Output voltage, nominal value	24 V DC
• Tolerance	±3%
• Residual ripple	< 150 mVpp
• Adjustment	No
Output current, nominal value	2.5 A (derating: 1.5 A from 60 °C)
Efficiency at nominal values, approx.	83%
Parallel operation	Yes, 2 units
Electronic short-circuit protection	Yes, automatic restart
Radio interference suppression (EN 55022)	Class B
Operating display	Green LED for "24 V o.k."
Supply-harmonics limitation (EN 61000-3-2)	Not applicable
Degree of protection (EN 60529)	IP20
Protection class	Class 1
Electric isolation	SELV acc. to EN 60950 and EN 50178
Ambient temperature	0 ... +60 °C -25 ... 70 °C
Transport and storage temperature	-25 ... +85 °C
Installation	Standard rail EN 60715 35x7.5/15
Dimensions (W x H x D) in mm	70 x 100 x 75
Weight, approx.	0.3 kg
Certifications	CE

Ordering data

SIPLUS S7-1200 PM 1207 power supply

(Extended temperature range and exposure to media)

Input 120/230 V AC, output 24 V DC, 2.5 A; derating from + 55 °C to + 70 °C to 1.2 A output current

Ambient temperature
-25 ... +70 °C

Ambient temperature 0 ... +60 °C

Article No.

6AG1332-1SH71-7AA0

6AG1332-1SH71-4AA0

SIMATIC S7-1200 Basic Controllers

Operator control and monitoring
Basic HMI – Basic Panels

Standard devices 2nd Generation

Overview



SIMATIC HMI Basic Panels 2nd Generation

Basic Panels 2nd Generation

SIMATIC HMI Basic Panels 2nd Generation with their fully developed HMI basic functions are the ideal entry level series for simple HMI applications.

The device family offers panels with 4", 7", 9" and 12" widescreen displays, as well as combined key and touch operation.

The innovative high-resolution widescreen displays with 64 000 colors are also suitable for upright installation, and they can be dimmed down to 100%. The innovative operator interface with improved usability opens up a diverse range of options thanks to new controls and graphics. The new USB interface enables the connection of keyboard, mouse or barcode scanner, and supports the simple archiving of data on a USB flash drive as well as the manual backup and restoring of the complete panel.

The integrated Ethernet or RS 485/422 interface (version-specific) enables simple connection to the controller.

Ordering data

SIMATIC HMI Basic Panels (2nd Generation)

Key and Touch devices

SIMATIC HMI KTP400 Basic

Key/touch-screen operation;
4" TFT widescreen display,
65 536 colors, PROFINET interface

Article No.

6AV2123-2DB03-0AX0

SIMATIC HMI KTP700 Basic

Key/touch-screen operation;
7" TFT widescreen display,
65 536 colors, PROFINET interface

6AV2123-2GB03-0AX0

SIMATIC HMI KTP700 Basic DP

Key/touch-screen operation;
7" TFT widescreen display,
65 536 colors, PROFIBUS interface

6AV2123-2GA03-0AX0

SIMATIC HMI KTP900 Basic

Key/touch-screen operation;
9" TFT widescreen display,
65 536 colors, PROFINET interface

6AV2123-2JB03-0AX0

SIMATIC HMI KTP1200 Basic

Key/touch-screen operation;
12" TFT widescreen display,
65 536 colors, PROFINET interface

6AV2123-2MB03-0AX0

SIMATIC HMI KTP1200 Basic DP

Key/touch-screen operation;
12" TFT widescreen display,
65 536 colors, PROFIBUS interface

6AV2123-2MA03-0AX0

Article No.

Starter kits

Starter kit SIMATIC S7-1200 + KP300 Basic mono PN

6AV6651-7HA01-3AA4

Starter Kit SIMATIC S7-1200 + KTP400 Basic

6AV6651-7KA01-3AA4

Starter Kit SIMATIC S7-1200 + KTP700 Basic

6AV6651-7DA01-3AA4

Starter kits with an S7-1200 consist of:

- The respective SIMATIC HMI Basic Panel
- SIMATIC HMI KP300 Basic mono PN
- SIMATIC HMI KTP400 Basic
- SIMATIC HMI KTP700 Basic
- SIMATIC S7-1200 CPU 1212C AC/DC/Rly
- SIMATIC S7-1200 Simulator Module SIM 12
- SIMATIC STEP 7 BASIC CD
- SIMATIC S7-1200 HMI Manual Collection CD
- Ethernet CAT5 cable, 2 m

Starter kit LOGO! + KP300 Basic mono PN

6AV2132-0HA00-0AA1

Starter kit LOGO! + KTP400 Basic

6AV2132-0KA00-0AA1

Starter kit LOGO! + KTP700 Basic

6AV2132-3GB00-0AA1

Starter kits with a LOGO! consist of:

- The respective SIMATIC HMI Basic Panel
- SIMATIC HMI KP300 Basic mono PN
- SIMATIC HMI KTP400 Basic
- SIMATIC HMI KTP700 Basic
- LOGO! 12/24 RCE
- LOGO! POWER 24 V 1.3 A
- LOGO! SOFT COMFORT V7
- WINCC BASIC (TIA Portal)
- Ethernet CAT5 cable, 2 m

Documentation

You can find the manual for the Basic Panels on the Internet at:

<http://support.automation.siemens.com>

Accessories

See catalog ST 80 / ST PC or Industry Mall

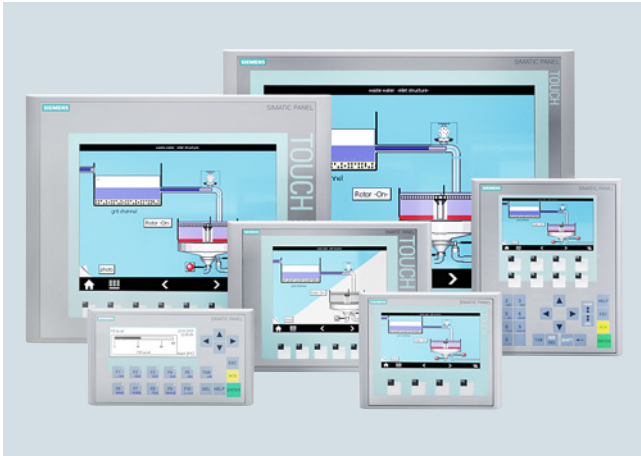
Overview**Basic Panels 1st Generation**

- Ideal entry-level series from 3" to 15" for operating and monitoring compact machines and systems
- Clear process representation thanks to use of pixel-graphics displays
- Intuitive operation using Touch and tactile function keys
- Equipped with all the necessary basic functions such as alarm logging, recipe management, plots, vector graphics, and language switching
- Simple connection to the controller via integral Ethernet interface or separate version with RS 485/422
- Faster commissioning thanks to integrated diagnostics viewer and IP setting for SIMATIC S7-1200 and S7-1500 PLCs

Ordering data**Article No.****SIMATIC HMI Basic Panels
(1st Generation)****Key and Touch devices****SIMATIC HMI KTP400 Basic
mono PN**

Key/touch-screen operation;
4" STN display; 4 gray levels;
PROFINET interface

6AV6647-0AA11-3AX0

**SIMATIC HMI KTP400 Basic
color PN**

Key/touch-screen operation;
4" widescreen TFT display,
256 colors, PROFINET interface

6AV6647-0AK11-3AX0

**SIMATIC HMI KTP600 Basic
mono PN**

Key/touch-screen operation;
6" STN display, 4 gray levels,
PROFINET interface

6AV6647-0AB11-3AX0

**SIMATIC HMI KTP600 Basic
color DP**

Key/touch-screen operation;
6" TFT display, 256 colors,
MPI/PROFIBUS DP interface

6AV6647-0AC11-3AX0

**SIMATIC HMI KTP600 Basic
color PN**

Key/touch-screen operation;
6" TFT display, 256 colors,
PROFINET interface

6AV6647-0AD11-3AX0

**SIMATIC HMI KTP1000 Basic
color DP**

Key/touch-screen operation;
10" TFT display, 256 colors,
MPI/PROFIBUS DP interface

6AV6647-0AE11-3AX0

**SIMATIC HMI KTP1000 Basic
color PN**

Key/touch-screen operation;
10" TFT display, 256 colors,
PROFINET interface

6AV6647-0AF11-3AX0

Article No.**Key devices****SIMATIC HMI KP300 Basic
mono PN**

Key operation;
3" FSTN LCD display, black and
white, PROFINET interface

6AV6647-0AH11-3AX0

**SIMATIC HMI KP400 Basic
color PN**

Key operation;
4" widescreen TFT display,
256 colors, PROFINET interface

6AV6647-0AJ11-3AX0

Touch devices**SIMATIC HMI TP1500 Basic
color PN**

Touch-screen operation;
15" TFT display, 256 colors,
PROFINET interface

6AV6647-0AG11-3AX0

Documentation

You can find the manual for the
Basic Panels on the Internet at:

<http://support.automation.siemens.com>

Accessories

See catalog ST 80 / ST PC
or Industry Mall

SIMATIC S7-1200 Basic Controllers

Operator control and monitoring
Comfort Panels

Standard devices

Overview



Comfort Panel family, KP, TP, KTP

SIMATIC HMI Comfort Panels - Standard devices

- Excellent HMI functionality for demanding applications
- Widescreen TFT displays with 4", 7", 9", 12", 15", 19" and 22" diagonals (all 16 million colors) with up to 40% more visualization area as compared to the predecessor devices
- Integrated high-end functionality with archives, scripts, PDF/Word/Excel viewer, Internet Explorer, Media Player and Web Server
- Dimmable displays from 0 to 100% via PROFlenergy, via the HMI project or via a controller
- Modern industrial design, cast aluminum fronts for 7" upwards
- Upright installation for all touch devices
- Optimal selection option: seven touch and five key versions are available
- Data security in the event of a power failure for the device and for the SIMATIC HMI Memory Card
- Innovative service and commissioning concept through second SD card (automatic backup)
- Maximum performance with short screen refresh times
- Suitable for extremely harsh industrial environments thanks to extended approvals such as ATEX 2/22 and marine approvals
- Wide range of communication options: PROFIBUS and PROFINET onboard; 2 x PROFINET with integrated switch for 7" models or larger; plus 1 x PROFINET with Gigabit support for 15" models or larger
- All versions can be used as an OPC UA client or as an OPC DA server
- Key-operated devices with LED in every function key and new text input mechanism, similar to the keypads of mobile phones
- All keys have a service life of 2 million operations
- Configuring with the WinCC engineering software of the TIA Portal

Note:

A 7" and 15" Comfort Outdoor version will be available soon.
For further information, please go to:

<http://www.siemens.com/hmi>

Ordering data	Article No.	Article No.
SIMATIC HMI Comfort Panels		
Key and touch devices		
SIMATIC HMI KTP400 Comfort Key/touch-screen operation; 4" widescreen display	6AV2124-2DC01-0AX0	
Touch devices		
SIMATIC HMI TP700 Comfort Touch-screen operation; 7" widescreen display	6AV2124-0GC01-0AX0	
SIMATIC HMI TP900 Comfort Touch-screen operation; 9" widescreen display	6AV2124-0JC01-0AX0	
SIMATIC HMI TP1200 Comfort Touch-screen operation; 12" widescreen display	6AV2124-0MC01-0AX0	
SIMATIC HMI TP1500 Comfort Touch-screen operation; 15" widescreen display	6AV2124-0QC02-0AX0	
SIMATIC HMI TP1900 Comfort Touch-screen operation; 19" widescreen display	6AV2124-0UC02-0AX0	
SIMATIC HMI TP2200 Comfort Touch-screen operation; 22" widescreen display	6AV2124-0XC02-0AX0	
Key devices		
SIMATIC HMI KP400 Comfort Key operation; 4" widescreen display	6AV2124-1DC01-0AX0	
SIMATIC HMI KP700 Comfort Key operation; 7" widescreen display	6AV2124-1GC01-0AX0	
SIMATIC HMI KP900 Comfort Key operation; 9" widescreen display	6AV2124-1JC01-0AX0	
SIMATIC HMI KP1200 Comfort Key operation; 12" widescreen display	6AV2124-1MC01-0AX0	
SIMATIC HMI KP1500 Comfort Key operation; 15" widescreen display	6AV2124-1QC02-0AX0	
Starter kits for SIMATIC HMI Comfort Panels Consisting of: the respective SIMATIC HMI Comfort Panel, SIMATIC WinCC Comfort, Ethernet cable, 2 m SIMATIC HMI memory card 2 GB 10 protective films for touch screen devices		
Starter kit for SIMATIC HMI KTP400 Comfort, Key and Touch	6AV2181-4DB20-0AX0	
Starter kit for SIMATIC HMI TP700 Comfort, Touch	6AV2181-4GB00-0AX0	
Starter kit for SIMATIC HMI TP900 Comfort, Touch	6AV2181-4JB00-0AX0	
Starter kit for SIMATIC HMI TP1200 Comfort, Touch	6AV2181-4MB00-0AX0	
Starter kit for SIMATIC HMI TP1500 Comfort, Touch	6AV2181-4QB00-0AX0	
Starter kit for SIMATIC HMI TP1900 Comfort, Touch	6AV2181-4UB00-0AX0	
Starter kit for SIMATIC HMI TP2200 Comfort, Touch	6AV2181-4XB00-0AX0	
Starter kit for SIMATIC HMI KP400 Comfort, Key	6AV2181-4DB10-0AX0	
Starter kit for SIMATIC HMI KP700 Comfort, Key	6AV2181-4GB10-0AX0	
Starter kit for SIMATIC HMI KP900 Comfort, Key	6AV2181-4JB10-0AX0	
Starter kit for SIMATIC HMI KP1200 Comfort, Key	6AV2181-4MB10-0AX0	
Starter kit for SIMATIC HMI KP1500 Comfort, Key	6AV2181-4QB10-0AX0	
Accessories	See catalog ST 80 / ST PC or Industry Mall	

SIMATIC S7-1200 Basic Controllers

SIPLUS operator control and monitoring

SIPLUS Basic Panels (2nd Generation)

Overview



With their fully developed HMI basic functions, 2nd generation SIPLUS Basic Panels are the ideal entry level series for simple HMI applications.

The device family offers panels with 4", 7", 9" and 12" displays, as well as combined key and touch operation.

The innovative high-resolution widescreen displays with 64 000 colors are also suitable for upright installation, and they can be dimmed down to 100%. The innovative operator interface with improved usability opens up a diverse range of options thanks to new controls and graphics. The new USB interface enables the connection of keyboard, mouse or barcode scanner, and supports the simple archiving of data on a USB stick.

The integrated Ethernet or RS 485/422 interface (version-specific) enables simple connection to the controller.

Note

SIPLUS extreme products are based on SIMATIC standard products. The contents listed here were taken from the respective standard products. SIPLUS extreme specific information was added.

Technical documentation on SIPLUS can be found here: <http://www.siemens.com/siplus-extreme>

Technical specifications

Article number	6AG1123-2DB03-2AX0	6AG1123-2GB03-2AX0	6AG1123-2GA03-2AX0
Based on	6AV2123-2DB03-0AX0 SIPLUS HMI KTP400 BASIC	6AV2123-2GB03-0AX0 SIPLUS HMI KTP700 BASIC	6AV2123-2GA03-0AX0 SIPLUS HMI KTP700 BASIC DP
Ambient conditions			
Suited for indoor use	Yes	Yes	Yes
Suited for outdoor use	No	No	No
Ambient temperature during operation			
• Operation (vertical installation)			
- For vertical installation, min.	-20 °C	-20 °C	-20 °C; = Tmin
- For vertical installation, max.	50 °C	50 °C	50 °C
Extended ambient conditions			
• relative to ambient temperature-atmospheric pressure-installation altitude	Tmin ... Tmax at 1080 hPa ... 795 hPa (-1000 m ... +2000 m) // Tmin ... (Tmax - 10K) at 795 hPa ... 658 hPa (+2000 m ... +3500 m) // Tmin ... (Tmax - 20K) at 658 hPa ... 540 hPa (+3500 m ... +5000 m)	Tmin ... Tmax at 1080 hPa ... 795 hPa (-1000 m ... +2000 m) // Tmin ... (Tmax - 10K) at 795 hPa ... 658 hPa (+2000 m ... +3500 m) // Tmin ... (Tmax - 20K) at 658 hPa ... 540 hPa (+3500 m ... +5000 m)	Tmin ... Tmax at 1080 hPa ... 795 hPa (-1000 m ... +2000 m) // Tmin ... (Tmax - 10K) at 795 hPa ... 658 hPa (+2000 m ... +3500 m) // Tmin ... (Tmax - 20K) at 658 hPa ... 540 hPa (+3500 m ... +5000 m)
Relative humidity			
- With condensation, tested in accordance with IEC 60068-2-38, max.	100%; RH incl. condensation/frost (no commissioning under condensation conditions)	100%; RH incl. condensation/frost (no commissioning under condensation conditions)	100%; RH incl. condensation/frost (no commissioning when condensation present), vertical mounting position
Resistance			
- against biologically active substances / conformity with EN 60721-3-3	Yes; Class 3B2 mold, fungus and dry rot spores (with the exception of fauna). The supplied connector covers must remain on the unused interfaces during operation!	Yes; Class 3B2 mold, fungus and dry rot spores (with the exception of fauna). The supplied connector covers must remain on the unused interfaces during operation!	Yes; Class 3B2 mold, fungus and dry rot spores (with the exception of fauna). The supplied connector covers must remain on the unused interfaces during operation!
- against chemically active substances / conformity with EN 60721-3-3	Yes; Class 3C4 (RH < 75%) incl. salt spray according to EN 60068-2-52 (degree of severity 3). The supplied connector covers must remain on the unused interfaces during operation!	Yes; Class 3C4 (RH < 75%) incl. salt spray according to EN 60068-2-52 (degree of severity 3). The supplied connector covers must remain on the unused interfaces during operation!	Yes; Class 3C4 (RH < 75%) incl. salt spray according to EN 60068-2-52 (degree of severity 3). The supplied connector covers must remain on the unused interfaces during operation!
- against mechanically active substances / conformity with EN 60721-3-3	Yes; Class 3S4 incl. sand, dust. The supplied connector covers must remain on the unused interfaces during operation!	Yes; Class 3S4 incl. sand, dust. The supplied connector covers must remain on the unused interfaces during operation!	Yes; Class 3S4 incl. sand, dust. The supplied connector covers must remain on the unused interfaces during operation!

SIMATIC S7-1200 Basic Controllers

SIPLUS operator control and monitoring

SIPLUS Basic Panels (2nd Generation)

3

Technical specifications (continued)

Article number	6AG1123-2JB03-2AX0	6AG1123-2MB03-2AX0	6AG1123-2MA03-2AX0
Based on	6AV2123-2JB03-0AX0 SIPLUS HMI KTP900 BASIC	6AV2123-2MB03-0AX0 SIPLUS HMI KTP1200 BASIC	6AV2123-2MA03-0AX0 SIPLUS HMI KTP1200 BASIC DP
Ambient conditions			
Suited for indoor use	Yes	Yes	Yes
Suited for outdoor use	No	No	No
Ambient temperature during operation			
• Operation (vertical installation)			
- For vertical installation, min.	-20 °C	-10 °C; = Tmin	-10 °C; = Tmin
- For vertical installation, max.	50 °C	50 °C	50 °C
Extended ambient conditions			
• relative to ambient temperature-atmospheric pressure-installation altitude	Tmin ... Tmax at 1080 hPa ... 795 hPa (-1000 m ... +2000 m) // Tmin ... (Tmax - 10K) at 795 hPa ... 658 hPa (+2000 m ... +3500 m) // Tmin ... (Tmax - 20K) at 658 hPa ... 540 hPa (+3500 m ... +5000 m)	Tmin ... Tmax at 1080 hPa ... 795 hPa (-1000 m ... +2000 m) // Tmin ... (Tmax - 10K) at 795 hPa ... 658 hPa (+2000 m ... +3500 m) // Tmin ... (Tmax - 20K) at 658 hPa ... 540 hPa (+3500 m ... +5000 m)	Tmin ... Tmax at 1080 hPa ... 795 hPa (-1000 m ... +2000 m) // Tmin ... (Tmax - 10K) at 795 hPa ... 658 hPa (+2000 m ... +3500 m) // Tmin ... (Tmax - 20K) at 658 hPa ... 540 hPa (+3500 m ... +5000 m)
Relative humidity			
- With condensation, tested in accordance with IEC 60068-2-38, max.	100%; RH incl. condensation/frost (no commissioning under condensation conditions)	100%; RH incl. condensation / frost (no commissioning in bedewed state), horizontal installation	100%; RH incl. condensation/frost (no commissioning when condensation present), vertical mounting position
Resistance			
- against biologically active substances / conformity with EN 60721-3-3	Yes; Class 3B2 mold, fungus and dry rot spores (with the exception of fauna). The supplied connector covers must remain on the unused interfaces during operation!	Yes; Class 3B2 mold, fungus and dry rot spores (with the exception of fauna). The supplied connector covers must remain on the unused interfaces during operation!	Yes; Class 3B2 mold, fungus and dry rot spores (with the exception of fauna). The supplied connector covers must remain on the unused interfaces during operation!
- against chemically active substances / conformity with EN 60721-3-3	Yes; Class 3C4 (RH < 75%) incl. salt spray according to EN 60068-2-52 (degree of severity 3). The supplied connector covers must remain on the unused interfaces during operation!	Yes; Class 3C4 (RH < 75%) incl. salt spray according to EN 60068-2-52 (degree of severity 3). The supplied connector covers must remain on the unused interfaces during operation!	Yes; Class 3C4 (RH < 75%) incl. salt spray according to EN 60068-2-52 (degree of severity 3). The supplied connector covers must remain on the unused interfaces during operation!
- against mechanically active substances / conformity with EN 60721-3-3	Yes; Class 3S4 incl. sand, dust. The supplied connector covers must remain on the unused interfaces during operation!	Yes; Class 3S4 incl. sand, dust. The supplied connector covers must remain on the unused interfaces during operation!	Yes; Class 3S4 incl. sand, dust. The supplied connector covers must remain on the unused interfaces during operation!

Ordering data

Ordering data	Article No.	Ordering data	Article No.
SIPLUS HMI Basic Panels, Key and Touch		SIPLUS HMI KTP900 Basic	6AG1123-2JB03-2AX0
SIPLUS HMI KTP400 Basic	6AG1123-2DB03-2AX0	For areas with extreme medial exposure (conformal coating); ambient temperature -20 ... +50 °C	
For areas with extreme medial exposure (conformal coating); ambient temperature -20 ... +50 °C		SIPLUS HMI KTP1200 Basic	6AG1123-2MB03-2AX0
SIPLUS HMI KTP700 Basic	6AG1123-2GB03-2AX0	For areas with extreme medial exposure (conformal coating); ambient temperature -10 ... +50 °C	
For areas with extreme medial exposure (conformal coating); ambient temperature -20 ... +50 °C		SIPLUS HMI KTP1200 Basic DP	6AG1123-2MA03-2AX0
SIPLUS HMI KTP700 Basic DP	6AG1123-2GA03-2AX0	For areas with extreme medial exposure (conformal coating); ambient temperature -10 ... +50 °C	
For areas with extreme medial exposure (conformal coating); ambient temperature -20 ... +50 °C		Accessories	See catalog ST 80 / ST PC or Industry Mall

SIMATIC S7-1200 Basic Controllers

SIPLUS operator control and monitoring

SIPLUS Basic Panels (1st Generation)

Overview

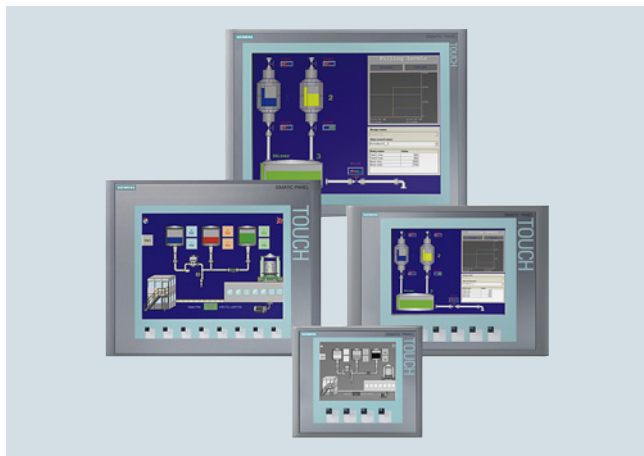

- Ideal entry-level series of 3.8 inches to 15 inches for operating and monitoring compact machines and systems
- Clear process representation through the use of full-graphic displays
- Intuitive operation via touch and tactile function keys
- Equipped with all the necessary basic functions such as reporting, recipe management, curve representation, vector graphics, and language selection
- Easy connection to the controller via integrated Ethernet interface or a separate version with RS 485/422

Note:

SIPLUS extreme products are based on SIMATIC standard products. The contents listed here were taken from the respective standard products. SIPLUS extreme specific information was added.

Technical documentation on SIPLUS can be found here:
<http://www.siemens.com/siplus-extreme>

Technical specifications

Article number	6AG1647-0AH11-2AX0	6AG1647-0AA11-2AX0	6AG1647-0AD11-2AX0
Based on	6AV6647-0AH11-3AX0	6AV6647-0AA11-3AX0	6AV6647-0AD11-3AX0
	SIPLUS HMI KP300 BASIC MONO PN 3,6"	SIPLUS KTP400 BASIC MONO PN 3,8"	SIPLUS KTP600 BASIC COLOR PN
Ambient conditions			
Suited for indoor use	Yes	Yes	Yes
Suited for outdoor use	No	No	No
Ambient temperature during operation			
• Operation (vertical installation)			
- For vertical installation, min.	-25 °C	-10 °C	-25 °C
- For vertical installation, max.	60 °C	60 °C	60 °C
Extended ambient conditions			
• relative to ambient temperature-atmospheric pressure-installation altitude	Tmin ... Tmax at 1080 hPa ... 795 hPa (-1000 m ... +2000 m) // Tmin ... (Tmax - 10K) at 795 hPa ... 658 hPa (+2000 m ... +3500 m) // Tmin ... (Tmax - 20K) at 658 hPa ... 540 hPa (+3500 m ... +5000 m)	Tmin ... Tmax at 1080 hPa ... 795 hPa (-1000 m ... +2000 m) // Tmin ... (Tmax - 10K) at 795 hPa ... 658 hPa (+2000 m ... +3500 m) // Tmin ... (Tmax - 20K) at 658 hPa ... 540 hPa (+3500 m ... +5000 m)	Tmin ... Tmax at 1080 hPa ... 795 hPa (-1000 m ... +2000 m) // Tmin ... (Tmax - 10K) at 795 hPa ... 658 hPa (+2000 m ... +3500 m) // Tmin ... (Tmax - 20K) at 658 hPa ... 540 hPa (+3500 m ... +5000 m)
Relative humidity			
- With condensation, tested in accordance with IEC 60068-2-38, max.	100%; RH incl. condensation/frost (no commissioning under condensation conditions)	100%; RH incl. condensation/frost (no commissioning under condensation conditions)	100%; RH incl. condensation/frost (no commissioning under condensation conditions)
Resistance			
- against biologically active substances / conformity with EN 60721-3-3	Yes; Class 3B2 mold, fungus and dry rot spores (with the exception of fauna). The supplied connector covers must remain on the unused interfaces during operation!	Yes; Class 3B2 mold, fungus and dry rot spores (with the exception of fauna). The supplied connector covers must remain on the unused interfaces during operation!	Yes; Class 3B2 mold, fungus and dry rot spores (with the exception of fauna). The supplied connector covers must remain on the unused interfaces during operation!
- against chemically active substances / conformity with EN 60721-3-3	Yes; Class 3C4 (RH < 75%) incl. salt spray according to EN 60068-2-52 (degree of severity 3). The supplied connector covers must remain on the unused interfaces during operation!	Yes; Class 3C4 (RH < 75%) incl. salt spray according to EN 60068-2-52 (degree of severity 3). The supplied connector covers must remain on the unused interfaces during operation!	Yes; Class 3C4 (RH < 75%) incl. salt spray according to EN 60068-2-52 (degree of severity 3). The supplied connector covers must remain on the unused interfaces during operation!
- against mechanically active substances / conformity with EN 60721-3-3	Yes; Class 3S4 incl. sand, dust. The supplied connector covers must remain on the unused interfaces during operation!	Yes; Class 3S4 incl. sand, dust. The supplied connector covers must remain on the unused interfaces during operation!	Yes; Class 3S4 incl. sand, dust. The supplied connector covers must remain on the unused interfaces during operation!

SIMATIC S7-1200 Basic Controllers

SIPLUS operator control and monitoring

SIPLUS Basic Panels (1st Generation)

3

Technical specifications (continued)

Article number	6AG1647-0AE11-4AX0 6AV6647-0AE11-3AX0 SIPLUS KTP1000 BASIC COLOR DP 10,4"	6AG1647-0AF11-4AX0 6AV6647-0AF11-3AX0 SIPLUS KTP1000 BASIC COLOR PN 10,4"	6AG1647-0AG11-4AX0 6AV6647-0AG11-3AX0 SIPLUS TP1500 BASIC COLOR PN 15" 10,4"
Ambient conditions			
Suited for indoor use	Yes	Yes	Yes
Suited for outdoor use	No	No	No
Ambient temperature during operation			
• Operation (vertical installation)	0 to +50 °C	0 to +50 °C	0 to +50 °C
- For vertical installation, min.	0 °C	0 °C	0 °C
- For vertical installation, max.	50 °C	50 °C	50 °C
Extended ambient conditions			
• relative to ambient temperature-atmospheric pressure-installation altitude	Tmin ... Tmax at 1080 hPa ... 795 hPa (-1000 m ... +2000 m) // Tmin ... (Tmax - 10K) at 795 hPa ... 658 hPa (+2000 m ... +3500 m) // Tmin ... (Tmax - 20K) at 658 hPa ... 540 hPa (+3500 m ... +5000 m)	Tmin ... Tmax at 1080 hPa ... 795 hPa (-1000 m ... +2000 m) // Tmin ... (Tmax - 10K) at 795 hPa ... 658 hPa (+2000 m ... +3500 m) // Tmin ... (Tmax - 20K) at 658 hPa ... 540 hPa (+3500 m ... +5000 m)	Tmin ... Tmax at 1080 hPa ... 795 hPa (-1000 m ... +2000 m) // Tmin ... (Tmax - 10K) at 795 hPa ... 658 hPa (+2000 m ... +3500 m) // Tmin ... (Tmax - 20K) at 658 hPa ... 540 hPa (+3500 m ... +5000 m)
Relative humidity			
- With condensation, tested in accordance with IEC 60068-2-38, max.	100%; RH incl. condensation/frost (no commissioning under condensation conditions)	100%; RH incl. condensation/frost (no commissioning under condensation conditions)	100%; RH incl. condensation/frost (no commissioning under condensation conditions)
Resistance			
- against biologically active substances / conformity with EN 60721-3-3	Yes; Class 3B2 mold, fungus and dry rot spores (with the exception of fauna). The supplied connector covers must remain on the unused interfaces during operation!	Yes; Class 3B2 mold, fungus and dry rot spores (with the exception of fauna). The supplied connector covers must remain on the unused interfaces during operation!	Yes; Class 3B2 mold, fungus and dry rot spores (with the exception of fauna). The supplied connector covers must remain on the unused interfaces during operation!
- against chemically active substances / conformity with EN 60721-3-3	Yes; Class 3C4 incl. salt spray. The supplied connector covers must remain on the unused interfaces during operation!	Yes; Class 3C4 incl. salt spray. The supplied connector covers must remain on the unused interfaces during operation!	Yes; Class 3C4 incl. salt spray. The supplied connector covers must remain on the unused interfaces during operation!
- against mechanically active substances / conformity with EN 60721-3-3	Yes; Class 3S4 incl. sand, dust. The supplied connector covers must remain on the unused interfaces during operation!	Yes; Class 3S4 incl. sand, dust. The supplied connector covers must remain on the unused interfaces during operation!	Yes; Class 3S4 incl. sand, dust. The supplied connector covers must remain on the unused interfaces during operation!

Ordering data

	Article No.		Article No.
SIPLUS HMI KP300 Basic mono PN For areas with extreme medial exposure (conformal coating); ambient temperature -25 ... +60 °C	6AG1647-0AH11-2AX0	SIPLUS HMI KTP1000 Basic color DP For areas with extreme medial exposure (conformal coating); ambient temperature 0 ... +50 °C	6AG1647-0AE11-4AX0
SIPLUS HMI KTP400 Basic mono PN For areas with extreme medial exposure (conformal coating); ambient temperature -10 ... +60 °C	6AG1647-0AA11-2AX0	SIPLUS HMI KTP1000 Basic color PN For areas with extreme medial exposure (conformal coating); ambient temperature 0 ... +50 °C	6AG1647-0AF11-4AX0
SIPLUS HMI KTP600 Basic color PN For areas with extreme medial exposure (conformal coating); ambient temperature -25 ... +60 °C	6AG1647-0AD11-2AX0	SIPLUS HMI TP1500 Basic color PN For areas with extreme medial exposure (conformal coating); ambient temperature 0 ... +50 °C	6AG1647-0AG11-4AX0
		Accessories	See catalog ST 80 / ST PC or Industry Mall

SIMATIC S7-1200 Basic Controllers

SIPLUS operator control and monitoring

SIPLUS Comfort Panels

Overview



- Excellent HMI functionality for demanding applications
- Widescreen TFT displays with 4", 7", 9", 12", 15", 19" and 22" diagonals (all 16 million colors) with up to 40% more visualization area as compared to the predecessor devices
- Integrated high-end functionality with archives, scripts, PDF/Word/Excel viewer, Internet Explorer, Media Player
- Dimmable displays from 0 to 100% via PROFIenergy, via the HMI project or via a controller
- Modern industrial design, cast aluminum fronts for 7" upwards
- Upright installation for all touch devices
- Optimal selection option: seven touch and five key versions are available
- Data security in the event of a power failure for the device and for the SIMATIC HMI Memory Card
- Innovative service and commissioning concept through second SD card (automatic backup)

- Easy project transfer via standard cable (standard Ethernet cable, standard USB cable)
- Maximum performance with short screen refresh times
- Suitable for extremely harsh industrial environments thanks to extended approvals such as ATEX 2/22
- Wide range of communication options: PROFIBUS and PROFINET onboard; 2x PROFINET with integrated switch for 7" models or larger; plus 1 additional PROFINET with Gigabit support for 15" models or larger
- All variants can be used as an OPC UA client or as an OPC DA server
- Key-operated devices with LED in every function key and new text input mechanism, similar to the keypads of mobile phones
- Key-operated devices with stamped keys for optimum tactile feedback
- All keys have a service life of 2 million operations
- Configuring with the WinCC engineering software of the TIA Portal

Note:

SIPLUS extreme products are based on SIMATIC standard products. The contents listed here were taken from the respective standard products. SIPLUS extreme-specific information was added.

Technical specifications

Article number	6AG1124-2DC01-4AX0	6AG1124-0GC01-4AX0	6AG1124-0JC01-4AX0	6AG1124-0MC01-4AX0
Based on	6AV2124-2DC01-0AX0 SIPLUS HMI KTP400 COMFORT	6AV2124-0GC01-0AX0 SIPLUS HMI TP700 COMFORT	6AV2124-0JC01-0AX0 SIPLUS HMI TP900 COMFORT	6AV2124-0MC01-0AX0 SIPLUS HMI TP1200 COMFORT
Ambient conditions				
Suited for indoor use	Yes	Yes	Yes	Yes
Suited for outdoor use	No	No	No	No
Ambient temperature during operation				
• Operation (vertical installation)				
- For vertical installation, min.	0 °C; = Tmin	0 °C; = Tmin	0 °C; = Tmin	0 °C; = Tmin
- For vertical installation, max.	50 °C; = Tmax	50 °C; = Tmax	50 °C; = Tmax	50 °C; = Tmax
Extended ambient conditions				
• relative to ambient temperature-atmospheric pressure-installation altitude	Tmin ... Tmax at 1080 hPa ... 795 hPa (-1000 m ... +2000 m) // Tmin ... (Tmax - 10K) at 795 hPa ... 658 hPa (+2000 m ... +3500 m) // Tmin ... (Tmax - 20K) at 658 hPa ... 540 hPa (+3500 m ... +5000 m)	Tmin ... Tmax at 1080 hPa ... 795 hPa (-1000 m ... +2000 m) // Tmin ... (Tmax - 10K) at 795 hPa ... 658 hPa (+2000 m ... +3500 m) // Tmin ... (Tmax - 20K) at 658 hPa ... 540 hPa (+3500 m ... +5000 m)	Tmin ... Tmax at 1080 hPa ... 795 hPa (-1000 m ... +2000 m) // Tmin ... (Tmax - 10K) at 795 hPa ... 658 hPa (+2000 m ... +3500 m) // Tmin ... (Tmax - 20K) at 658 hPa ... 540 hPa (+3500 m ... +5000 m)	Tmin ... Tmax at 1080 hPa ... 795 hPa (-1000 m ... +2000 m) // Tmin ... (Tmax - 10K) at 795 hPa ... 658 hPa (+2000 m ... +3500 m) // Tmin ... (Tmax - 20K) at 658 hPa ... 540 hPa (+3500 m ... +5000 m)
Relative humidity				
- With condensation, tested in accordance with IEC 60068-2-38, max.	100%; RH incl. condensation/frost (no commissioning under condensation conditions)	100%; RH incl. condensation/frost (no commissioning under condensation conditions)	100%; RH incl. condensation/frost (no commissioning under condensation conditions)	100%; RH incl. condensation/frost (no commissioning under condensation conditions)
Resistance				
- against biologically active substances / conformity with EN 60721-3-3	Yes; Class 3B2 mold, fungus and dry rot spores (with the exception of fauna). The supplied connector covers must remain on the unused interfaces during operation!	Yes; Class 3B2 mold, fungus and dry rot spores (with the exception of fauna). The supplied connector covers must remain on the unused interfaces during operation!	Yes; Class 3B2 mold, fungus and dry rot spores (with the exception of fauna). The supplied connector covers must remain on the unused interfaces during operation!	Yes; Class 3B2 mold, fungus and dry rot spores (with the exception of fauna). The supplied connector covers must remain on the unused interfaces during operation!
- against chemically active substances / conformity with EN 60721-3-3	Yes; Class 3C4 (RH < 75%) incl. salt spray according to EN 60068-2-52 (degree of severity 3). The supplied connector covers must remain on the unused interfaces during operation!	Yes; Class 3C4 (RH < 75%) incl. salt spray according to EN 60068-2-52 (degree of severity 3). The supplied connector covers must remain on the unused interfaces during operation!	Yes; Class 3C4 (RH < 75%) incl. salt spray according to EN 60068-2-52 (degree of severity 3). The supplied connector covers must remain on the unused interfaces during operation!	Yes; Class 3C4 (RH < 75%) incl. salt spray according to EN 60068-2-52 (degree of severity 3). The supplied connector covers must remain on the unused interfaces during operation!
- against mechanically active substances / conformity with EN 60721-3-3	Yes; Class 3S4 incl. sand, dust. The supplied connector covers must remain on the unused interfaces during operation!	Yes; Class 3S4 incl. sand, dust. The supplied connector covers must remain on the unused interfaces during operation!	Yes; Class 3S4 incl. sand, dust. The supplied connector covers must remain on the unused interfaces during operation!	Yes; Class 3S4 incl. sand, dust. The supplied connector covers must remain on the unused interfaces during operation!

SIMATIC S7-1200 Basic Controllers

SIPLUS operator control and monitoring

SIPLUS Comfort Panels

Technical specifications (continued)

Article number	6AG1124-1DC01-4AX0	6AG1124-1GC01-4AX0	6AG1124-1JC01-4AX0	6AG1124-1MC01-4AX0	6AG1124-1QC02-4AX0
Based on	6AV2124-1DC01-0AX0 SIPLUS HMI KP400 COMFORT	6AV2124-1GC01-0AX0 SIPLUS HMI KP700 COMFORT	6AV2124-1JC01-0AX0 SIPLUS HMI KP900 COMFORT	6AV2124-1MC01-0AX0 SIPLUS HMI KP1200 COMFORT	6AV2124-1QC02-0AX0 SIPLUS HMI KP1500 COMFORT
Ambient conditions					
Suited for indoor use	Yes	Yes	Yes	Yes	Yes
Suited for outdoor use	No	No	No	No	No
Ambient temperature during operation					
• Operation (vertical installation)					
- For vertical installation, min.	0 °C; = Tmin	0 °C; = Tmin	0 °C; = Tmin	0 °C; = Tmin	0 °C; = Tmin
- For vertical installation, max.	50 °C; = Tmax	50 °C; = Tmax	50 °C; = Tmax	50 °C; = Tmax	50 °C; = Tmax
Extended ambient conditions					
• relative to ambient temperature-atmospheric pressure-installation altitude	Tmin ... Tmax at 1080 hPa ... 795 hPa (-1000 m ... +2000 m) // Tmin ... (Tmax - 10K) at 795 hPa ... 658 hPa (+2000 m ... +3500 m) // Tmin ... (Tmax - 20K) at 658 hPa ... 540 hPa (+3500 m ... +5000 m)	Tmin ... Tmax at 1080 hPa ... 795 hPa (-1000 m ... +2000 m) // Tmin ... (Tmax - 10K) at 795 hPa ... 658 hPa (+2000 m ... +3500 m) // Tmin ... (Tmax - 20K) at 658 hPa ... 540 hPa (+3500 m ... +5000 m)	Tmin ... Tmax at 1080 hPa ... 795 hPa (-1000 m ... +2000 m) // Tmin ... (Tmax - 10K) at 795 hPa ... 658 hPa (+2000 m ... +3500 m) // Tmin ... (Tmax - 20K) at 658 hPa ... 540 hPa (+3500 m ... +5000 m)	Tmin ... Tmax at 1080 hPa ... 795 hPa (-1000 m ... +2000 m) // Tmin ... (Tmax - 10K) at 795 hPa ... 658 hPa (+2000 m ... +3500 m) // Tmin ... (Tmax - 20K) at 658 hPa ... 540 hPa (+3500 m ... +5000 m)	Tmin ... Tmax at 1080 hPa ... 795 hPa (-1000 m ... +2000 m) // Tmin ... (Tmax - 10K) at 795 hPa ... 658 hPa (+2000 m ... +3500 m) // Tmin ... (Tmax - 20K) at 658 hPa ... 540 hPa (+3500 m ... +5000 m)
Relative humidity					
- With condensation, tested in accordance with IEC 60068-2-38, max.	100%; RH incl. condensation/frost (no commissioning under condensation conditions)	100%; RH incl. condensation/frost (no commissioning under condensation conditions)	100%; RH incl. condensation/frost (no commissioning under condensation conditions)	100%; RH incl. condensation/frost (no commissioning under condensation conditions)	100%; RH incl. condensation/frost (no commissioning under condensation conditions)
Resistance					
- against biologically active substances / conformity with EN 60721-3-3	Yes; Class 3B2 mold, fungus and dry rot spores (with the exception of fauna). The supplied connector covers must remain on the unused interfaces during operation!	Yes; Class 3B2 mold, fungus and dry rot spores (with the exception of fauna). The supplied connector covers must remain on the unused interfaces during operation!	Yes; Class 3B2 mold, fungus and dry rot spores (with the exception of fauna). The supplied connector covers must remain on the unused interfaces during operation!	Yes; Class 3B2 mold, fungus and dry rot spores (with the exception of fauna). The supplied connector covers must remain on the unused interfaces during operation!	Yes; Class 3B2 mold, fungus and dry rot spores (with the exception of fauna). The supplied connector covers must remain on the unused interfaces during operation!
- against chemically active substances / conformity with EN 60721-3-3	Yes; Class 3C4 (RH < 75%) incl. salt spray according to EN 60068-2-52 (degree of severity 3). The supplied connector covers must remain on the unused interfaces during operation!	Yes; Class 3C4 (RH < 75%) incl. salt spray according to EN 60068-2-52 (degree of severity 3). The supplied connector covers must remain on the unused interfaces during operation!	Yes; Class 3C4 (RH < 75%) incl. salt spray according to EN 60068-2-52 (degree of severity 3). The supplied connector covers must remain on the unused interfaces during operation!	Yes; Class 3C4 (RH < 75%) incl. salt spray according to EN 60068-2-52 (degree of severity 3). The supplied connector covers must remain on the unused interfaces during operation!	Yes; Class 3C4 (RH < 75%) incl. salt spray according to EN 60068-2-52 (degree of severity 3). The supplied connector covers must remain on the unused interfaces during operation!
- against mechanically active substances / conformity with EN 60721-3-3	Yes; Class 3S4 incl. sand, dust. The supplied connector covers must remain on the unused interfaces during operation!	Yes; Class 3S4 incl. sand, dust. The supplied connector covers must remain on the unused interfaces during operation!	Yes; Class 3S4 incl. sand, dust. The supplied connector covers must remain on the unused interfaces during operation!	Yes; Class 3S4 incl. sand, dust. The supplied connector covers must remain on the unused interfaces during operation!	Yes; Class 3S4 incl. sand, dust. The supplied connector covers must remain on the unused interfaces during operation!

SIMATIC S7-1200 Basic Controllers

SIPLUS operator control and monitoring

SIPLUS Comfort Panels

3

Technical specifications (continued)

Article number	6AG1124-0QC02-4AX0	6AG1124-0UC02-4AX0	6AG1124-0XC02-4AX0
Based on	6AV2124-0QC02-0AX0 SIPLUS HMI TP1500 COMFORT	6AV2124-0UC02-0AX0 SIPLUS HMI TP1900 COMFORT	6AV2124-0XC02-0AX0 SIPLUS HMI TP2200 COMFORT
Ambient conditions			
Suited for indoor use	Yes	Yes	Yes
Suited for outdoor use	No	No	No
Ambient temperature during operation			
• Operation (vertical installation)			
- For vertical installation, min.	0 °C; = Tmin	0 °C; = Tmin	0 °C; = Tmin
- For vertical installation, max.	50 °C; = Tmax	45 °C; = Tmax	45 °C; = Tmax
Extended ambient conditions			
• relative to ambient temperature-atmospheric pressure-installation altitude	Tmin ... Tmax at 1080 hPa ... 795 hPa (-1000 m ... +2000 m) // Tmin ... (Tmax - 10K) at 795 hPa ... 658 hPa (+2000 m ... +3500 m) // Tmin ... (Tmax - 20K) at 658 hPa ... 540 hPa (+3500 m ... +5000 m)	Tmin ... Tmax at 1080 hPa ... 795 hPa (-1000 m ... +2000 m) // Tmin ... (Tmax - 10K) at 795 hPa ... 658 hPa (+2000 m ... +3500 m) // Tmin ... (Tmax - 20K) at 658 hPa ... 540 hPa (+3500 m ... +5000 m)	Tmin ... Tmax at 1080 hPa ... 795 hPa (-1000 m ... +2000 m) // Tmin ... (Tmax - 10K) at 795 hPa ... 658 hPa (+2000 m ... +3500 m) // Tmin ... (Tmax - 20K) at 658 hPa ... 540 hPa (+3500 m ... +5000 m)
Relative humidity			
- With condensation, tested in accordance with IEC 60068-2-38, max.	100%; RH incl. condensation/frost (no commissioning under condensation conditions)	100%; RH incl. condensation/frost (no commissioning under condensation conditions)	100%; RH incl. condensation/frost (no commissioning under condensation conditions)
Resistance			
- against biologically active substances / conformity with EN 60721-3-3	Yes; Class 3B2 mold, fungus and dry rot spores (with the exception of fauna). The supplied connector covers must remain on the unused interfaces during operation!	Yes; Class 3B2 mold, fungus and dry rot spores (with the exception of fauna). The supplied connector covers must remain on the unused interfaces during operation!	Yes; Class 3B2 mold, fungus and dry rot spores (with the exception of fauna). The supplied connector covers must remain on the unused interfaces during operation!
- against chemically active substances / conformity with EN 60721-3-3	Yes; Class 3C4 (RH < 75%) incl. salt spray according to EN 60068-2-52 (degree of severity 3). The supplied connector covers must remain on the unused interfaces during operation!	Yes; Class 3C4 (RH < 75%) incl. salt spray according to EN 60068-2-52 (degree of severity 3). The supplied connector covers must remain on the unused interfaces during operation!	Yes; Class 3C4 (RH < 75%) incl. salt spray according to EN 60068-2-52 (degree of severity 3). The supplied connector covers must remain on the unused interfaces during operation!
- against mechanically active substances / conformity with EN 60721-3-3	Yes; Class 3S4 incl. sand, dust. The supplied connector covers must remain on the unused interfaces during operation!	Yes; Class 3S4 incl. sand, dust. The supplied connector covers must remain on the unused interfaces during operation!	Yes; Class 3S4 incl. sand, dust. The supplied connector covers must remain on the unused interfaces during operation!

Ordering data

Ordering data	Article No.
SIPLUS HMI Comfort Panels, Keys and Touch	
SIPLUS HMI KP400 Comfort	6AG1124-2DC01-4AX0
SIPLUS HMI Comfort Panels, Touch	
SIPLUS HMI TP700 Comfort	6AG1124-0GC01-4AX0
SIPLUS HMI TP900 Comfort	6AG1124-0JC01-4AX0
SIPLUS HMI TP1200 Comfort	6AG1124-0MC01-4AX0
SIPLUS HMI TP1500 Comfort	6AG1124-0QC02-4AX0
SIPLUS HMI TP1900 Comfort	6AG1124-0UC02-4AX0
SIPLUS HMI TP2200 Comfort	6AG1124-0XC02-4AX0

Article No.

Ordering data	Article No.
SIPLUS HMI Comfort Panels, Keys	
SIPLUS HMI KP400 Comfort	6AG1124-1DC01-4AX0
SIPLUS HMI KP700 Comfort	6AG1124-1GC01-4AX0
SIPLUS HMI KP900 Comfort	6AG1124-1JC01-4AX0
SIPLUS HMI KP1200 Comfort	6AG1124-1MC01-4AX0
SIPLUS HMI KP1500 Comfort	6AG1124-1QC02-4AX0
Accessories	See catalog ST 80 / ST PC or Industry Mall

SIMATIC S7-1200 Basic Controllers

Add-on products from third-party manufacturers

SIMATIC S7-1200 CM CANopen

Overview



Note

The CM CANopen module is an HMS product and can only be obtained through HMS.

The following description contains information on supplementary products that are manufactured and marketed, not by Siemens, but by third-parties outside the Siemens group ("external companies"). These external companies organize the manufacture, sale and delivery of their products independently. Their own terms and conditions of business and delivery apply.

Responsibility for these supplementary products and for the associated information presented here rests exclusively with the respective external company. Unless compulsory by law, Siemens assumes no liability and makes no guarantee for supplemental products of external companies. Please refer also to the note on "Exemption from liability/Use of hyperlinks" (see "More information").

Overview

An interface module is available for operating the S7-1200 on CANopen. It can be used together with system and IO components of the S7-1200 automation system.

CiA and CANopen are registered Community Trademarks of CAN in Automation e.V.

Application

CANopen is a widely used industrial bus system and can be used for a variety of different applications. The module allows simple and cost-effective connection of CANopen applications to SIMATIC.

- Control of hydraulic valves/axes in vehicles
- Control of motors in packaging machines or conveyors
- Capturing of angular encoder positions in wind turbines
- Capturing of control devices on machines, e.g. joysticks
- Capturing the measured data of path encoders, inclinometers or angular encoders, e.g. for tower cranes and gantry cranes

The CM CANopen module has the following properties:

- Interface module for CANopen (master/slave) for SIMATIC S7-1200
- Connection of up to 16 CANopen slave stations in the master mode
- 256 bytes of input data and 256 bytes of output data per module
- Connection of up to 3 modules per CPU
- 3 LEDs for module, network and I/O status diagnostics
- Possible integration of the module into the hardware catalog of the TIA Portal configuration suite
- Supports Transparent CAN 2.0A for processing customer-specific protocols
- CANopen implementation according to communication profiles CiA 301 Rev. 4.2 and CiA 302 Rev. 4.1 (master)

More information

The CANopen bus can be configured via any commercially available CANopen configuration tool. The HMS company also supplies suitable "CM CANopen Configuration Studio" software with the product. The configuration is saved directly on the module by means of a USB connection. Routing via PROFIBUS/PROFINET is not possible.

Preprogrammed function blocks are available for easier PLC programming in the TIA Portal.

For further information, please contact HMS directly:

<http://www.hms-networks.com/can-for-s7-1200>

Ordering and Support

Please note that ordering and support for the module are exclusively carried out via HMS. Please contact HMS directly should you have any questions concerning this module. The relevant contact details can be found on the Internet at

<http://www.hms-networks.com/can-for-s7-1200>

Exemption from liability/Use of hyperlinks

Siemens has prepared this description with great care. It is not possible, however, for Siemens to verify that the data supplied by external companies is complete, correct or up to date. The possibility that individual items of information might be incorrect, incomplete, or not up-to-date cannot therefore be ruled out. Unless compulsory by law, Siemens accepts no liability for the usability of the data or of the product for the user per se.

This article contains third-party Web addresses. Siemens is not responsible for the contents of these Web sites, nor does Siemens adopt these Web sites and their contents, as Siemens does not control the presented information and cannot be held responsible for the content and information they contain. You therefore use these links at your own risk.

SIMATIC S7-1500 Advanced Controllers



4/2	Introduction	4/140	<u>Connection system</u>
4/2	SIMATIC S7-1500/S7-1500F, SIPLUS S7-1500	4/140	Front connectors
		4/141	System cabling for SIMATIC S7-1500 and ET 200MP
4/5	Central processing units	4/142	- Fully modular connection
4/5	Standard CPUs	4/146	- Front connectors with single wires
4/20	SIPLUS Standard CPUs	4/147	<u>F digital/analog modules</u>
4/24	Compact CPUs	4/147	F digital input modules
4/30	Fail-safe CPUs	4/149	F digital output modules
4/47	SIPLUS fail-safe CPUs		
4/51	Technology CPUs		
4/60	I/O modules	4/151	Power supplies
4/60	<u>Digital modules</u>	4/151	1-phase, 24 V DC (for S7-1500 and ET200MP)
4/60	SM 521 digital input modules	4/154	System power supplies
4/65	SM 522 digital output modules		
4/73	SM 523 digital input/output modules	4/156	SIPLUS power supplies
4/75	<u>SIPLUS digital modules</u>	4/156	1-phase, 24 V DC (for S7-1500 and ET200MP)
4/75	SIPLUS SM 521 digital input modules	4/157	SIPLUS system power supplies
4/77	SIPLUS SM 522 digital output modules		
4/79	<u>Analog modules</u>	4/159	Operator control and monitoring
4/79	SM 531 analog input modules	4/159	SIMATIC HMI Basic Panels and Comfort Panels
4/88	SM 532 analog output modules	4/160	SIPLUS Basic Panels and Comfort Panels
4/92	SM 534 analog input/output modules		
4/96	<u>SIPLUS analog modules</u>	4/161	Accessories
4/96	SIPLUS SM 531 analog input modules	4/161	Mounting rails
4/98	SIPLUS SM 532 analog output modules	4/162	Labeling sheets
4/100	<u>Technology modules</u>	4/163	Spare parts
4/100	TM Count 2x24V counter module		
4/103	TM PosInput 2 counting and position detection module		
4/106	Time-based IO module TM Timer DIDQ 16x24V		
4/109	Interface module for PTO (Pulse Train Output) TM PTO 4		
4/112	SIWAREX WP521 ST, SIWAREX WP522 ST		
4/115	<u>SIPLUS technology modules</u>		
4/115	SIPLUS TM Count 2x24V counter module		
4/116	<u>Communication</u>		
4/116	CM PtP		
4/119	CM 1542-5		
4/121	CP 1542-5		
4/123	CM 1542-1		
4/126	CP 1543-1		
4/129	TIM 1531 IRC		
4/130	SCALANCE W774 RJ45 for use in control cabinet		
4/133	SCALANCE W734 RJ45 for use in control cabinet		
4/136	<u>SIPLUS communication</u>		
4/136	SIPLUS CM PtP		
4/138	SIPLUS NET CM 1542-5		
4/139	SIPLUS NET CP 1543-1		

Brochures

For brochures serving as selection guides for SIMATIC products, refer to:

www.siemens.com/simatic/printmaterial

SIMATIC S7-1500 Advanced Controllers

Introduction

SIMATIC S7-1500/S7-1500F, SIPLUS S7-1500

Overview



- Modular, scalable, and universally usable system in IP20 level of protection
- The system solution for a variety of automation applications in discrete automation
- Highest performance with excellent usability
- Configurable exclusively in the Totally Integrated Automation Portal with STEP 7 Professional V12 or higher

Performance

- Increase in performance through
 - Faster command execution
 - Language extensions
 - New data types
 - Faster backplane bus
 - Optimized code generation
- Powerful communication:
 - PROFINET IO (2-port switch) as standard interface; from CPU 1515-2 PN, one or more additional integrated PROFINET interfaces, e.g. for network separation, for connecting further PROFINET devices or for high-speed communication as an I-device
 - OPC UA Data Access Server as runtime option for the easy connection of SIMATIC S7-1500 in third-party devices/systems
 - Expandable with communication modules for bus systems and point-to-point connection

Integrated technology

- Motion control integrated without additional modules:
 - Standardized blocks (PLCopen) for connection of analog and PROFIdrive-capable drives
 - The motion control functionality supports speed-controlled axes, positioning axes, relative synchronous operation (synchronizing without specification of the synchronized position), as well as external encoders, cams and probes.
 - Extended motion control functions such as absolute synchronous operation (synchronizing with specification of the synchronized position) and camming are also integrated in the technology CPUs.
- Comprehensive trace functions for all CPU tags for real-time diagnostics and sporadic error detection; for effective commissioning and quick optimization of drives and controls
- Comprehensive control functionalities: e.g. easily configurable blocks for automatic optimization of the control parameters for optimum control quality
- Additional functions through available technology modules: e.g. high-speed counting, position detection, or measurement functions for signals up to 1 MHz

Safety Integrated

Protection of personnel and machinery – within the framework of an integrated complete system

- Fail-safe SIMATIC S7-1500(T)F Controllers for processing standard and safety programs on the same controller. Generation of the fail-safe and standard user program is carried out in the TIA Portal with the same editors; this enables fail-safe data to be evaluated like standard data in the standard user program, for example. Due to this integration the system benefits and the comprehensive functionality of SIMATIC are also available for fail-safe applications.

Security Integrated

- Password-based know-how protection against unauthorized reading and modification of program blocks
- Copy protection for greater protection against unauthorized copying of program blocks: With copy protection, individual blocks on the SIMATIC Memory Card can be tied to its serial number so that the block can only be run if the configured memory card is inserted into the CPU.
- Rights concept with four different authorization levels: Different access rights can be assigned to various user groups. The new protection level 4 makes it possible to also restrict communication to HMI devices.
- Improved manipulation protection: Changed or unauthorized transfers of engineering data are detected by the controller.
- For use of an Ethernet CP (CP 1543-1):
 - Additional access protection by means of a firewall
 - Establishment of secure VPN connections

Design and handling

- CPUs with display for plain text information (display simulator tool on the Internet):
 - Information about article numbers, firmware version, and the serial number of all connected modules can be displayed
 - Setting the IP address of the CPU and additional network settings possible directly on site, without programming device on the display
 - Display of occurring error messages directly as plain text message, meaning reduction in downtime
- Uniform front connectors for all modules and integrated potential bridges for flexible potential group formation simplify stock keeping and reduce wiring costs
- Integrated DIN rail in the S7-1500 DIN rail: quick and easy installation of additional components such as miniature circuit breakers, relays, etc.
- Central expansion with signal modules: for flexible adaptation to any application
- System cabling for digital signal modules: for fast and clearly arranged connecting to sensors and actuators in the field and simple wiring inside the control cabinet
- Power supply:
 - Load power supply modules (PMs) for supplying the module with 24 V
 - Power supply modules to supply power to the internal module electronics via the backplane bus
- Distributed expansion:
 - Use of up to 30 signal modules, communication modules, and technology modules via the PROFINET interface module IM 155-5 for the ET 200MP I/O system
 - No difference in terms of handling and system functions in central and distributed operation

Overview (continued)

Integrated system diagnostics

- Integrated system diagnostics for CPUs, activated by default:
 - Consistent plain text display of system diagnostic information in the display, TIA Portal, HMI, and web server, even for drive messages. Messages are updated even if the CPU is in STOP state.
 - System diagnostics integrated in the CPU firmware. Configuration by user not required. The diagnostics is automatically updated on configuration changes.

Support of SIMATIC ProDiag S7-1500

- ProDiag is a concept for the easy creation of machine and plant diagnostics. It increases availability and supports with fault analysis and elimination on-site.

Datalog (archives) and recipes

- SIMATIC Memory Card:
 - Plug-in load memory
 - Permits firmware updates
 - Storage option for STEP 7 projects (including comments and symbols), additional documentation, or csv files (for recipes and archives)
 - Easy access to plant-relevant operating data and configuration data with Office tools via the SD card reader (two-way data exchange from and to the controller)
- Integrated web server:
 - Easy access to plant-relevant operating data and configuration data via a web browser

Approvals

The SIMATIC S7-1500 complies with the following national and international standards:

- cULus approval
- cULus HazLoc approval
- FM approval
- ATEX approval (only for 24 V; not for 230 V)
- CE
- RCM (formerly C-Tick)
- KCC
- IECEx (24 V only; not for 230 V)
- EN 61000-6-4
- EN 60068-2-1/ -2/ -6/ -14/ -27/ -30/ -32
- EN 61131-2

You can find the marine approvals available for the S7-1500 on the Internet (SIMATIC Customer Support):
<http://www.siemens.com/automation/support>

Technical specifications

General technical specifications SIMATIC S7-1500	
Degree of protection	IP20 acc. to IEC 60 529
Ambient temperature	
• Horizontal installation	0...60 °C (display: at an operating temperature of typ. 50 °C, the display is switched off.)
• Vertical installation	0... 40 °C (display: at an operating temperature of typ. 40 °C, the display is switched off.)
Relative humidity	5%...95%, no condensation
Atmospheric pressure	From 1080 to 795 hPa (corresponds to an altitude of -1000 to +2000 m)
Insulation	
• < 50 V	707 V DC test voltage (type test)
• < 150 V	2200 V DC test voltage
• < 250 V	2500 V DC test voltage
Electromagnetic compatibility	Requirements of the EMC directive; interference immunity according to IEC 61000-6-2
• Pulse-shaped disturbance variables	Test according to: Electrostatic discharge according to IEC 61000-4-2, burst pulses according to IEC 61000-4-4, energy single pulse (surge) according to IEC 61000-4-5,
• Sinusoidal disturbance variables	Test according to: HF irradiation according to IEC 61000-4-3, HF decoupling according to IEC 61000-4-6 Requirements of the EMC directive; interference emission according to EN 61000-6-4
• Emission of radio frequency interference	Interference emission according to 61000-6-4 Interference emission of electromagnetic fields according to EN 61000-6-4

General technical specifications SIMATIC S7-1500	
Mechanical stress	
• Vibrations	Testing according to EN 60068-2-6 Tested with: 5 Hz ≤ f ≤ 8.4 Hz, constant amplitude 7 mm; 9 Hz ≤ f ≤ 150 Hz, constant acceleration 2 g; duration of vibration: 10 frequency passes per axis in each direction of the 3 mutually perpendicular axes
• Shock	Testing according to EN 60068-2-27 Tested with: Half-wave: strength of shock 15 g peak value, 11 ms duration; shock direction: 3 shocks each in ± direction in each of the 3 mutually vertical axes

SIMATIC S7-1500 Advanced Controllers

Introduction

SIMATIC S7-1500/S7-1500F, SIPLUS S7-1500

Technical specifications (continued)

General technical data of SIPLUS S7-1500	
Ambient temperature range	-40/-25/-20 ... +55/60/70 °C
Conformal coating	Coating of the printed circuit boards and the electronic components
Technical specifications	The technical data of the standard product applies except for the ambient conditions.

General technical data of SIPLUS S7-1500	
Ambient conditions	
Extended range of environmental conditions	
<ul style="list-style-type: none"> with reference to ambient temperature, air pressure and altitude 	Tmin ... Tmax at 1080 hPa ... 795 hPa (-1000 m ... +2000 m) // Tmin ... (Tmax - 10K) at 795 hPa ... 658 hPa (+2000 m ... +3500 m) // Tmin ... (Tmax - 20K) at 658 hPa ... 540 hPa (+3500 m ... +5000 m)
<ul style="list-style-type: none"> At cold restart, min. 	0° C
Relative humidity	
<ul style="list-style-type: none"> with condensation, max. 	100 %; RH incl. bedewing/frost (no commissioning in bedewed state)
Resistance	
<ul style="list-style-type: none"> to biologically active substances/ compliance with EN 60721-3-3 	Yes; Class 3B2 mold and fungal spores (except fauna); the supplied plug covers must remain in place on the unused interfaces during operation.
<ul style="list-style-type: none"> to chemically active substances/ compliance with EN 60721-3-3 	Yes; Class 3C4 (RH < 75%) incl. salt spray in accordance with EN 60068-2-52 (severity 3); the supplied plug covers must remain in place on the unused interfaces during operation.
<ul style="list-style-type: none"> to mechanically active substances, compliance with EN 60721-3-3 	Yes; Class 3S4 incl. sand, dust; the supplied plug covers must remain in place on unused interfaces during operation.

Overview CPU 1511-1 PN



- Entry-level CPU in the S7-1500 Controller product range
- Suitable for applications with medium requirements for program scope and processing speed
- Used as central controller in production lines with central and distributed I/O
- PROFINET IO IRT interface with 2-port switch
- PROFINET IO controller for operating distributed I/O on PROFINET
- PROFINET I-device for connecting the CPU as an intelligent PROFINET device under a SIMATIC or third-party PROFINET IO controller
- OPC UA Server (Data Access) as runtime option for the easy connection of SIMATIC S7-1500 to third-party devices/systems
- Isochronous mode
- Integrated motion control functionalities for controlling speed-controlled and positioning axes, support for external encoders, cams/cam tracks and probes
- Integrated web server for diagnostics with the option of creating user-defined web pages

Note:

SIMATIC Memory Card required for operation of the CPU

Overview CPU 1513-1 PN



- The CPU for applications with medium requirements for program/data storage in the S7-1500 Controller product range
- Medium to high processing speed for binary and floating-point arithmetic
- Used as central controller in production lines with central and distributed I/O
- PROFINET IO IRT interface with 2-port switch
- PROFINET IO controller for operating distributed I/O on PROFINET
- PROFINET I-device for connecting the CPU as an intelligent PROFINET device under a SIMATIC or third-party PROFINET IO controller
- OPC UA Server (Data Access) as runtime option for the easy connection of SIMATIC S7-1500 to third-party devices/systems
- Isochronous mode
- Integrated motion control functionalities for controlling speed-controlled and positioning axes, support for external encoders, cams/cam tracks and probes
- Integrated web server for diagnostics with the option of creating user-defined web pages

Note:

SIMATIC Memory Card required for operation of the CPU

SIMATIC S7-1500 Advanced Controllers

Central processing units

Standard CPUs

Overview CPU 1515-2 PN



- The CPU for applications with medium to high requirements for program/data storage in the S7-1500 Controller product range
- Medium to high processing speed for binary and floating-point arithmetic
- Used as central controller in production lines with central and distributed I/O
- PROFINET IO IRT interface with 2-port switch
- PROFINET IO controller for operating distributed I/O on PROFINET
- PROFINET I-device for connecting the CPU as an intelligent PROFINET device under a SIMATIC or third-party PROFINET IO controller
- Additional PROFINET interface with separate IP address for network separation, for connecting further PROFINET IO RT devices, or for high-speed communication as an I-device
- OPC UA Server (Data Access) as runtime option for the easy connection of SIMATIC S7-1500 to third-party devices/systems
- Isochronous mode
- Integrated motion control functionalities for controlling speed-controlled and positioning axes, precise position gearing between axes, support for external encoders, cams/cam tracks and probes
- Integrated web server for diagnostics with the option of creating user-defined web pages

Note:

SIMATIC Memory Card required for operation of the CPU

Overview CPU 1516-3 PN/DP



- The CPU with a large program and data memory in the S7-1500 Controller product range for applications with high requirements regarding program scope and networking.
- High processing speed for binary and floating-point arithmetic
- Used as central controller in production lines with central and distributed I/O
- PROFINET IO IRT interface with 2-port switch
- PROFINET IO controller for operating distributed I/O on PROFINET.
- PROFINET I-device for connecting the CPU as an intelligent PROFINET device under a SIMATIC or third-party PROFINET IO controller.
- Additional PROFINET interface with separate IP address for network separation, for connecting further PROFINET IO RT devices, or for high-speed communication as an I-device
- PROFIBUS DP master interface
- OPC UA Server (Data Access) as runtime option for the easy connection of SIMATIC S7-1500 to third-party devices/systems
- Isochronous mode on PROFIBUS and PROFINET
- Integrated motion control functionalities for controlling speed-controlled and positioning axes, support for external encoders, cams/cam tracks and probes
- Integrated web server for diagnostics with the option of creating user-defined web pages

Note:

SIMATIC Memory Card required for operation of the CPU

Overview CPU 1517-3 PN/DP



- The CPU with a very large program and data memory in the S7-1500 Controller product range for applications with high requirements regarding program scope and networking.
- High processing speed for binary and floating-point arithmetic
- For cross-industry automation tasks in series machine, special machine and plant construction
- Used as central controller in production lines with central and distributed I/O
- PROFINET IO IRT interface with 2-port switch
- PROFINET IO controller for operating distributed I/O on PROFINET.
- PROFINET I-device for connecting the CPU as an intelligent PROFINET device under a SIMATIC or third-party PROFINET IO controller.
- Additional PROFINET interface with separate IP address for network separation, for connecting further PROFINET IO RT devices, or for high-speed communication as an I-device
- PROFIBUS DP master interface
- OPC UA Server (Data Access) as runtime option for the easy connection of SIMATIC S7-1500 to third-party devices/systems
- Isochronous mode on PROFIBUS and PROFINET
- Integrated motion control functionalities for controlling speed-controlled and positioning axes, support for external encoders, precise position gearing between axes, cams/cam tracks and probes
- Integrated web server for diagnostics with the option of creating user-defined web pages

Note:

SIMATIC Memory Card required for operation of the CPU

Overview CPU 1518-4 PN/DP



- The CPU with a very large program and data memory in the S7-1500 Controller product range for demanding applications with extremely high requirements regarding program scope, performance and networking
- Extremely high processing speed for binary and floating-point arithmetic
- For cross-industry automation tasks in series machine, special machine and plant construction
- Used as central controller in production lines with central and distributed I/O
- PROFINET IO IRT interface with 2-port switch
- PROFINET IO controller for operating distributed I/O on PROFINET.
- PROFINET I-device for connecting the CPU as an intelligent PROFINET device under a SIMATIC or third-party PROFINET IO controller.
- Two additional PROFINET interfaces with separate IP address; for network separation. The PROFINET interface X2 can be used for connecting additional PROFINET IO RT devices or for fast communication as an I-device. The PROFINET interface X3 gives you the capability of transferring data at a speed of 1 Gbps.
- PROFIBUS DP master interface
- OPC UA Server (Data Access) as runtime option for the easy connection of SIMATIC S7-1500 to third-party devices/systems
- Isochronous mode on PROFIBUS and PROFINET
- Integrated motion control functionalities for controlling speed-controlled and positioning axes, support for external encoders, precise position gearing between axes, cams/cam tracks and probes
- Integrated web server for diagnostics with the option of creating user-defined web pages

Note:

SIMATIC Memory Card required for operation of the CPU

SIMATIC S7-1500 Advanced Controllers

Central processing units

Standard CPUs

Overview CPU 1518-4 PN/DP ODK

- The CPU with a very large program and data memory in the S7-1500 Controller product range for demanding applications with extremely high requirements regarding program scope, performance and networking
- Extremely high processing speed for binary and floating-point arithmetic
- For cross-industry automation tasks in series machines, special machines and plant construction
- C/C++ Runtime for the execution of functions and algorithms implemented in C/C++ in the CPU 1518-4 PN/DP ODK.
- Used as central controller in production lines with central and distributed I/O
- PROFINET IO IRT interface with 2-port switch
- PROFINET IO controller for operating distributed I/O on PROFINET
- PROFINET I-device for connecting the CPU as an intelligent PROFINET device under a SIMATIC or third-party PROFINET IO controller
- Two additional PROFINET interfaces with separate IP addresses for network separation The PROFINET interface X2 can be used for connecting additional PROFINET IO RT devices or for fast communication as an I-device. The PROFINET interface X3 gives you the capability of transferring data at a speed of 1 Gbps.
- PROFIBUS DP master interface
- OPC UA Server (Data Access) as runtime option for the easy connection of SIMATIC S7-1500 to third-party devices/ systems
- Isochronous mode on PROFIBUS and PROFINET
- Integrated motion control functionalities for controlling speed-controlled and positioning axes, support for external encoders, precise position gearing between axes, cams/cam tracks and probes
- Integrated web server for diagnostics with the option of creating user-defined web pages

Note

SIMATIC Memory Card required for operation of the CPU.

Technical specifications

Article number	6ES7511-1AK01-0AB0	6ES7513-1AL01-0AB0	6ES7515-2AM01-0AB0
	CPU 1511-1PN, 150KB PROGRAM, 1MB DATA	CPU 1513-1 PN, 300KB PROG., 1,5MB DATA	CPU 1515-2 PN, 500KB PROG., 3MB DATA
General information			
Product type designation	CPU 1511-1 PN	CPU 1513-1 PN	CPU 1515-2 PN
Engineering with			
• STEP 7 TIA Portal configurable/ integrated as of version	V14	V14	V14
Display			
Screen diagonal [cm]	3.45 cm	3.45 cm	6.1 cm
Supply voltage			
Type of supply voltage	24 V DC	24 V DC	24 V DC
Power loss			
Power loss, typ.	5.7 W	5.7 W	6.3 W
Memory			
Work memory			
• integrated (for program)	150 kbyte	300 kbyte	500 kbyte
• integrated (for data)	1 Mbyte	1.5 Mbyte	3 Mbyte
Load memory			
• Plug-in (SIMATIC Memory Card), max.	32 Gbyte	32 Gbyte	32 Gbyte
CPU processing times			
for bit operations, typ.	60 ns	40 ns	30 ns
for word operations, typ.	72 ns	48 ns	36 ns
for fixed point arithmetic, typ.	96 ns	64 ns	48 ns
for floating point arithmetic, typ.	384 ns	256 ns	192 ns
Counters, timers and their retentivity			
S7 counter			
• Number	2 048	2 048	2 048
IEC counter			
• Number	Any (only limited by the main memory)	Any (only limited by the main memory)	Any (only limited by the main memory)
S7 times			
• Number	2 048	2 048	2 048
IEC timer			
• Number	Any (only limited by the main memory)	Any (only limited by the main memory)	Any (only limited by the main memory)

Technical specifications (continued)

Article number	6ES7511-1AK01-0AB0 CPU 1511-1PN, 150KB PROGRAM, 1MB DATA	6ES7513-1AL01-0AB0 CPU 1513-1 PN, 300KB PROG., 1,5MB DATA	6ES7515-2AM01-0AB0 CPU 1515-2 PN, 500KB PROG., 3MB DATA
Data areas and their retentivity			
Flag			
• Number, max.	16 kbyte	16 kbyte	16 kbyte
Address area			
I/O address area			
• Inputs	32 kbyte; All inputs are in the process image	32 kbyte; All inputs are in the process image	32 kbyte; All inputs are in the process image
• Outputs	32 kbyte; All outputs are in the process image	32 kbyte; All outputs are in the process image	32 kbyte; All outputs are in the process image
Time of day			
Clock			
• Type	Hardware clock	Hardware clock	Hardware clock
1. Interface			
Interface types			
• Number of ports	2	2	2
• integrated switch	Yes	Yes	Yes
• RJ 45 (Ethernet)	Yes; X1	Yes; X1	Yes; X1
Functionality			
• PROFINET IO Controller	Yes	Yes	Yes
• PROFINET IO Device	Yes	Yes	Yes
• SIMATIC communication	Yes	Yes	Yes
• Open IE communication	Yes	Yes	Yes
• Web server	Yes	Yes	Yes
• Media redundancy	Yes	Yes	Yes
PROFINET IO Controller			
Services			
- PG/OP communication	Yes	Yes	Yes
- S7 routing	Yes	Yes	Yes
- Isochronous mode	Yes	Yes	Yes
- Open IE communication	Yes	Yes	Yes
- IRT	Yes	Yes	Yes
- MRP	Yes; As MRP redundancy manager and/or MRP client; max. number of devices in the ring: 50	Yes; As MRP redundancy manager and/or MRP client; max. number of devices in the ring: 50	Yes; As MRP redundancy manager and/or MRP client; max. number of devices in the ring: 50
- MRPD	Yes; Requirement: IRT	Yes; Requirement: IRT	Yes; Requirement: IRT
- PROFinergy	Yes		Yes
- Prioritized startup	Yes; Max. 32 PROFINET devices	Yes; Max. 32 PROFINET devices	Yes; Max. 32 PROFINET devices
- Number of connectable IO Devices, max.	128; In total, up to 256 distributed I/O devices can be connected via AS-i, PROFIBUS or PROFINET	128	256; In total, up to 1 000 distributed I/O devices can be connected via AS-i, PROFIBUS or PROFINET
- Of which IO devices with IRT, max.	64	64	64
- Number of connectable IO Devices for RT, max.	128	128	256
- of which in line, max.	128	128	256
- Number of IO Devices that can be simultaneously activated/deactivated, max.	8; in total across all interfaces	8; in total across all interfaces	8; in total across all interfaces
- Number of IO Devices per tool, max.	8	8	8
- Updating times	The minimum value of the update time also depends on communication share set for PROFINET IO, on the number of IO devices, and on the quantity of configured user data	The minimum value of the update time also depends on communication share set for PROFINET IO, on the number of IO devices, and on the quantity of configured user data	The minimum value of the update time also depends on communication share set for PROFINET IO, on the number of IO devices, and on the quantity of configured user data

SIMATIC S7-1500 Advanced Controllers

Central processing units

Standard CPUs

Technical specifications (continued)

Article number	6ES7511-1AK01-0AB0 CPU 1511-1PN, 150KB PROGRAM, 1MB DATA	6ES7513-1AL01-0AB0 CPU 1513-1 PN, 300KB PROG., 1,5MB DATA	6ES7515-2AM01-0AB0 CPU 1515-2 PN, 500KB PROG., 3MB DATA
Update time for IRT			
- for send cycle of 250 µs	250 µs to 4 ms; Note: In the case of IRT with isochronous mode, the minimum update time of 625 µs of the isochronous OB is decisive	250 µs to 4 ms; Note: In the case of IRT with isochronous mode, the minimum update time of 500 µs of the isochronous OB is decisive	250 µs to 4 ms; Note: In the case of IRT with isochronous mode, the minimum update time of 500 µs of the isochronous OB is decisive
- for send cycle of 500 µs	500 µs to 8 ms; Note: In the case of IRT with isochronous mode, the minimum update time of 625 µs of the isochronous OB is decisive	500 µs to 8 ms	500 µs to 8 ms
- for send cycle of 1 ms	1 ms to 16 ms	1 ms to 16 ms	1 ms to 16 ms
- for send cycle of 2 ms	2 ms to 32 ms	2 ms to 32 ms	2 ms to 32 ms
- for send cycle of 4 ms	4 ms to 64 ms	4 ms to 64 ms	4 ms to 64 ms
- With IRT and parameterization of "odd" send cycles	Update time = set "odd" send clock (any multiple of 125 µs: 375 µs, 625 µs ... 3 875 µs)	Update time = set "odd" send clock (any multiple of 125 µs: 375 µs, 625 µs ... 3 875 µs)	Update time = set "odd" send clock (any multiple of 125 µs: 375 µs, 625 µs ... 3 875 µs)
Update time for RT			
- for send cycle of 250 µs	250 µs to 128 ms	250 µs to 128 ms	250 µs to 128 ms
- for send cycle of 500 µs	500 µs to 256 ms	500 µs to 256 ms	500 µs to 256 ms
- for send cycle of 1 ms	1 ms to 512 ms	1 ms to 512 ms	1 ms to 512 ms
- for send cycle of 2 ms	2 ms to 512 ms	2 ms to 512 ms	2 ms to 512 ms
- for send cycle of 4 ms	4 ms to 512 ms	4 ms to 512 ms	4 ms to 512 ms
PROFINET IO Device			
Services			
- PG/OP communication	Yes	Yes	Yes
- S7 routing	Yes	Yes	Yes
- Isochronous mode	No	No	No
- Open IE communication	Yes	Yes	Yes
- IRT	Yes	Yes	Yes
- MRP	Yes	Yes	Yes
- MRPD	Yes; Requirement: IRT	Yes; Requirement: IRT	Yes; Requirement: IRT
- PROFinergy	Yes	Yes	Yes
- Shared device	Yes	Yes	Yes
- Number of IO Controllers with shared device, max.	4	4	4
2. Interface			
Interface types			
• Number of ports			1
• integrated switch			No
• RJ 45 (Ethernet)			Yes; X2
Functionality			
• PROFINET IO Controller			Yes
• PROFINET IO Device			Yes
• SIMATIC communication			Yes
• Open IE communication			Yes
• Web server			Yes
• Media redundancy			No

Technical specifications (continued)

Article number	6ES7511-1AK01-0AB0 CPU 1511-1PN, 150KB PROGRAM, 1MB DATA	6ES7513-1AL01-0AB0 CPU 1513-1 PN, 300KB PROG., 1,5MB DATA	6ES7515-2AM01-0AB0 CPU 1515-2 PN, 500KB PROG., 3MB DATA
PROFINET IO Controller			
Services			
- PG/OP communication			Yes
- S7 routing			Yes
- Isochronous mode			No
- Open IE communication			Yes
- IRT			No
- MRP			No
- PROFlenergy			Yes
- Prioritized startup			No
- Number of connectable IO Devices, max.			32; In total, up to 1 000 distributed I/O devices can be connected via AS-i, PROFIBUS or PROFINET
- Number of connectable IO Devices for RT, max.			32
- of which in line, max.			32
- Number of IO Devices that can be simultaneously activated/deactivated, max.			8; in total across all interfaces
- Number of IO Devices per tool, max.			8
- Updating times			The minimum value of the update time also depends on communication share set for PROFINET IO, on the number of IO devices, and on the quantity of configured user data
Update time for RT			
- for send cycle of 1 ms			1 ms to 512 ms
PROFINET IO Device			
Services			
- PG/OP communication			Yes
- S7 routing			Yes
- Isochronous mode			No
- Open IE communication			Yes
- IRT			No
- MRP			No
- MRPD			No
- PROFlenergy			Yes
- Prioritized startup			No
- Shared device			Yes
- Number of IO Controllers with shared device, max.			4
Protocols			
Supports protocol for PROFINET IO	Yes	Yes	Yes
PROFIsafe	No	No	No
PROFIBUS	No	No	No
Number of connections			
• Number of connections, max.	96; via integrated interfaces of the CPU and connected CPs / CMs	128; via integrated interfaces of the CPU and connected CPs / CMs	192; via integrated interfaces of the CPU and connected CPs / CMs
PROFINET IO Controller			
Services			
- Number of connectable IO Devices, max.	128; In total, up to 256 distributed I/O devices can be connected via AS-i, PROFIBUS or PROFINET	128; In total, up to 512 distributed I/O devices can be connected via AS-i, PROFIBUS or PROFINET	
- Of which IO devices with IRT, max.	64	64	
- Number of connectable IO Devices for RT, max.	128	128	
Isochronous mode			
Isochronous operation (application synchronized up to terminal)	Yes; With minimum OB 6x cycle of 625 µs	Yes; With minimum OB 6x cycle of 500 µs	Yes; With minimum OB 6x cycle of 500 µs

SIMATIC S7-1500 Advanced Controllers

Central processing units

Standard CPUs

Technical specifications (continued)

Article number	6ES7511-1AK01-0AB0 CPU 1511-1PN, 150KB PROGRAM, 1MB DATA	6ES7513-1AL01-0AB0 CPU 1513-1 PN, 300KB PROG., 1,5MB DATA	6ES7515-2AM01-0AB0 CPU 1515-2 PN, 500KB PROG., 3MB DATA
Supported technology objects			
Motion Control	Yes; Note: The number of axes affects the cycle time of the PLC program; selection guide via the TIA Selection Tool or SIZER	Yes; Note: The number of axes affects the cycle time of the PLC program; selection guide via the TIA Selection Tool or SIZER	Yes; Note: The number of axes affects the cycle time of the PLC program; selection guide via the TIA Selection Tool or SIZER
• Number of available Motion Control resources for technology objects (except cam disks)	800	800	2 400
• Required Motion Control resources			
- per speed-controlled axis	40	40	40
- per positioning axis	80	80	80
- per synchronous axis	160	160	160
- per external encoder	80	80	80
- per output cam	20	20	20
- per cam track	160	160	160
- per probe	40	40	40
Controller			
• PID_Compact	Yes; Universal PID controller with integrated optimization	Yes; Universal PID controller with integrated optimization	Yes; Universal PID controller with integrated optimization
• PID_3Step	Yes; PID controller with integrated optimization for valves	Yes; PID controller with integrated optimization for valves	Yes; PID controller with integrated optimization for valves
• PID-Temp	Yes; PID controller with integrated optimization for temperature	Yes; PID controller with integrated optimization for temperature	Yes; PID controller with integrated optimization for temperature
Counting and measuring			
• High-speed counter	Yes	Yes	Yes
Ambient conditions			
Ambient temperature during operation			
• horizontal installation, min.	0 °C	0 °C	0 °C
• horizontal installation, max.	60 °C; Display: 50 °C, at an operating temperature of typically 50 °C, the display is switched off	60 °C; Display: 50 °C, at an operating temperature of typically 50 °C, the display is switched off	60 °C; Display: 50 °C, at an operating temperature of typically 50 °C, the display is switched off
• vertical installation, min.	0 °C	0 °C	0 °C
• vertical installation, max.	40 °C; Display: 40 °C, at an operating temperature of typically 40 °C, the display is switched off	40 °C; Display: 40 °C, at an operating temperature of typically 40 °C, the display is switched off	40 °C; Display: 40 °C, at an operating temperature of typically 40 °C, the display is switched off
Configuration			
Programming			
Programming language			
- LAD	Yes	Yes	Yes
- FBD	Yes	Yes	Yes
- STL	Yes	Yes	Yes
- SCL	Yes	Yes	Yes
- GRAPH	Yes	Yes	Yes
Know-how protection			
• User program protection/password protection	Yes	Yes	Yes
• Copy protection	Yes	Yes	Yes
• Block protection	Yes	Yes	Yes
Access protection			
• Password for display	Yes	Yes	Yes
• Protection level: Write protection	Yes	Yes	Yes
• Protection level: Read/write protection	Yes	Yes	Yes
• Protection level: Complete protection	Yes	Yes	Yes
Dimensions			
Width	35 mm	35 mm	70 mm
Height	147 mm	147 mm	147 mm
Depth	129 mm	129 mm	129 mm
Weights			
Weight, approx.	430 g	430 g	830 g

SIMATIC S7-1500 Advanced Controllers

Central processing units

Standard CPUs

Technical specifications (continued)

Article number	6ES7516-3AN01-0AB0 CPU 1516-3 PN/DP, 1MB PROG., 5MB DATA	6ES7517-3AP00-0AB0 CPU 1517-3 PN/DP, 2MB PROG./8MB DATA	6ES7518-4AP00-0AB0 CPU 1518-4 PN/DP, 4MB PROG., 20MB DATA	6ES7518-4AP00-3AB0 CPU 1518-4 PN/DP ODK 4MB PROG./20MB DATA
General information				
Product type designation	CPU 1516-3 PN/DP	CPU 1517-3 PN/DP	CPU 1518-4 PN/DP	CPU 1518-4 PN/DP ODK
Engineering with				
• STEP 7 TIA Portal configurable/ integrated as of version	V14	V14	V14	V14
Display				
Screen diagonal [cm]	6.1 cm	6.1 cm	6.1 cm	6.1 cm
Supply voltage				
Type of supply voltage	24 V DC	24 V DC	24 V DC	24 V DC
Power loss				
Power loss, typ.	7 W	24 W	24 W	24 W
Memory				
Work memory				
• integrated (for program)	1 Mbyte	2 Mbyte	4 Mbyte	4 Mbyte
• integrated (for data)	5 Mbyte	8 Mbyte	20 Mbyte	20 Mbyte
• Integrated (for ODK application)				20 Mbyte
Load memory				
• Plug-in (SIMATIC Memory Card), max.	32 Gbyte	32 Gbyte	32 Gbyte	32 Gbyte
CPU processing times				
for bit operations, typ.	10 ns	2 ns	1 ns	1 ns
for word operations, typ.	12 ns	3 ns	2 ns	2 ns
for fixed point arithmetic, typ.	16 ns	3 ns	2 ns	2 ns
for floating point arithmetic, typ.	64 ns	12 ns	6 ns	6 ns
Counters, timers and their retentivity				
S7 counter				
• Number	2 048	2 048	2 048	2 048
IEC counter				
• Number	Any (only limited by the main memory)	Any (only limited by the main memory)	Any (only limited by the main memory)	Any (only limited by the main memory)
S7 times				
• Number	2 048	2 048	2 048	2 048
IEC timer				
• Number	Any (only limited by the main memory)	Any (only limited by the main memory)	Any (only limited by the main memory)	Any (only limited by the main memory)
Data areas and their retentivity				
Flag				
• Number, max.	16 kbyte	16 kbyte	16 kbyte	16 kbyte
Address area				
I/O address area				
• Inputs	32 kbyte; All inputs are in the process image	32 kbyte; All inputs are in the process image	32 kbyte; All inputs are in the process image	32 kbyte; All inputs are in the process image
• Outputs	32 kbyte; All outputs are in the process image	32 kbyte; All outputs are in the process image	32 kbyte; All outputs are in the process image	32 kbyte; All outputs are in the process image
Time of day				
Clock				
• Type	Hardware clock	Hardware clock	Hardware clock	Hardware clock
1. Interface				
Interface types				
• Number of ports	2	2	2	2
• integrated switch	Yes	Yes	Yes	Yes
• RJ 45 (Ethernet)	Yes; X1	Yes; X1	Yes; X1	Yes; X1
Functionality				
• PROFINET IO Controller	Yes	Yes	Yes	Yes
• PROFINET IO Device	Yes	Yes	Yes	Yes
• SIMATIC communication	Yes	Yes	Yes	Yes
• Open IE communication	Yes	Yes	Yes	Yes
• Web server	Yes	Yes	Yes	Yes
• Media redundancy	Yes	Yes	Yes	Yes

SIMATIC S7-1500 Advanced Controllers

Central processing units

Standard CPUs

Technical specifications (continued)

Article number	6ES7516-3AN01-0AB0 CPU 1516-3 PN/DP, 1MB PROG., 5MB DATA	6ES7517-3AP00-0AB0 CPU 1517-3 PN/DP, 2MB PROG./8MB DATA	6ES7518-4AP00-0AB0 CPU 1518-4 PN/DP, 4MB PROG., 20MB DATA	6ES7518-4AP00-3AB0 CPU 1518-4 PN/DP ODK 4MB PROG./20MB DATA
PROFINET IO Controller				
Services				
- PG/OP communication	Yes	Yes	Yes	Yes
- S7 routing	Yes	Yes	Yes	Yes
- Isochronous mode	Yes	Yes	Yes	Yes
- Open IE communication	Yes	Yes	Yes	Yes
- IRT	Yes	Yes	Yes	Yes
- MRP	Yes; As MRP redundancy manager and/or MRP client; max. number of devices in the ring: 50	Yes; As MRP redundancy manager and/or MRP client; max. number of devices in the ring: 50	Yes; As MRP redundancy manager and/or MRP client; max. number of devices in the ring: 50	Yes; As MRP redundancy manager and/or MRP client; max. number of devices in the ring: 50
- MRPD	Yes; Requirement: IRT	Yes; Requirement: IRT	Yes; Requirement: IRT	Yes; Requirement: IRT
- PROFinergy	Yes	Yes	Yes	Yes
- Prioritized startup	Yes; Max. 32 PROFINET devices	Yes; Max. 32 PROFINET devices	Yes; Max. 32 PROFINET devices	Yes; Max. 32 PROFINET devices
- Number of connectable IO Devices, max.	256; In total, up to 1 000 distributed I/O devices can be connected via AS-I, PROFIBUS or PROFINET	512; In total, up to 1 000 distributed I/O devices can be connected via AS-I, PROFIBUS or PROFINET	512; In total, up to 1 000 distributed I/O devices can be connected via AS-I, PROFIBUS or PROFINET	512; In total, up to 1 000 distributed I/O devices can be connected via AS-I, PROFIBUS or PROFINET
- Of which IO devices with IRT, max.	64	64	64	64
- Number of connectable IO Devices for RT, max.	256	512	512	512
- of which in line, max.	256	512	512	512
- Number of IO Devices that can be simultaneously activated/deactivated, max.	8; in total across all interfaces	8; in total across all interfaces	8; in total across all interfaces	8; in total across all interfaces
- Number of IO Devices per tool, max.	8	8	8	8
- Updating times	The minimum value of the update time also depends on communication share set for PROFINET IO, on the number of IO devices, and on the quantity of configured user data	The minimum value of the update time also depends on communication share set for PROFINET IO, on the number of IO devices, and on the quantity of configured user data	The minimum value of the update time also depends on communication share set for PROFINET IO, on the number of IO devices, and on the quantity of configured user data	The minimum value of the update time also depends on communication share set for PROFINET IO, on the number of IO devices, and on the quantity of configured user data
Update time for IRT				
- for send cycle of 125 µs			125 µs	125 µs
- for send cycle of 187.5 µs			187.5 µs	187.5 µs
- for send cycle of 250 µs	250 µs to 4 ms; Note: In the case of IRT with isochronous mode, the minimum update time of 500 µs of the isochronous OB is decisive	250 µs to 4 ms	250 µs to 4 ms	250 µs to 4 ms
- for send cycle of 500 µs	500 µs to 8 ms	500 µs to 8 ms	500 µs to 8 ms	500 µs to 8 ms
- for send cycle of 1 ms	1 ms to 16 ms	1 ms to 16 ms	1 ms to 16 ms	1 ms to 16 ms
- for send cycle of 2 ms	2 ms to 32 ms	2 ms to 32 ms	2 ms to 32 ms	2 ms to 32 ms
- for send cycle of 4 ms	4 ms to 64 ms	4 ms to 64 ms	4 ms to 64 ms	4 ms to 64 ms
- With IRT and parameterization of "odd" send cycles	Update time = set "odd" send clock (any multiple of 125 µs: 375 µs, 625 µs ... 3 875 µs)	Update time = set "odd" send clock (any multiple of 125 µs: 375 µs, 625 µs ... 3 875 µs)	Update time = set "odd" send clock (any multiple of 125 µs: 375 µs, 625 µs ... 3 875 µs)	Update time = set "odd" send clock (any multiple of 125 µs: 375 µs, 625 µs ... 3 875 µs)
Update time for RT				
- for send cycle of 250 µs	250 µs to 128 ms	250 µs to 128 ms	250 µs to 128 ms	250 µs to 128 ms
- for send cycle of 500 µs	500 µs to 256 ms	500 µs to 256 ms	500 µs to 256 ms	500 µs to 256 ms
- for send cycle of 1 ms	1 ms to 512 ms	1 ms to 512 ms	1 ms to 512 ms	1 ms to 512 ms
- for send cycle of 2 ms	2 ms to 512 ms	2 ms to 512 ms	2 ms to 512 ms	2 ms to 512 ms
- for send cycle of 4 ms	4 ms to 512 ms	4 ms to 512 ms	4 ms to 512 ms	4 ms to 512 ms

Technical specifications (continued)

Article number	6ES7516-3AN01-0AB0 CPU 1516-3 PN/DP, 1MB PROG., 5MB DATA	6ES7517-3AP00-0AB0 CPU 1517-3 PN/DP, 2MB PROG./8MB DATA	6ES7518-4AP00-0AB0 CPU 1518-4 PN/DP, 4MB PROG., 20MB DATA	6ES7518-4AP00-3AB0 CPU 1518-4 PN/DP ODK 4MB PROG./20MB DATA
PROFINET IO Device				
Services				
- PG/OP communication	Yes	Yes	Yes	Yes
- S7 routing	Yes	Yes	Yes	Yes
- Isochronous mode	No	No	No	No
- Open IE communication	Yes	Yes	Yes	Yes
- IRT	Yes	Yes	Yes	Yes
- MRP	Yes	Yes	Yes	Yes
- MRPD	Yes; Requirement: IRT	Yes; Requirement: IRT	Yes; Requirement: IRT	Yes; Requirement: IRT
- PROFinergy	Yes	Yes	Yes	Yes
- Shared device	Yes	Yes	Yes	Yes
- Number of IO Controllers with shared device, max.	4	4	4	4
2. Interface				
Interface types				
• Number of ports	1	1	1	1
• integrated switch	No	No	No	No
• RJ 45 (Ethernet)	Yes; X2	Yes; X2	Yes; X2	Yes; X2
Functionality				
• PROFINET IO Controller	Yes	Yes	Yes	Yes
• PROFINET IO Device	Yes	Yes	Yes	Yes
• SIMATIC communication	Yes	Yes	Yes	Yes
• Open IE communication	Yes	Yes	Yes	Yes
• Web server	Yes	Yes	Yes	Yes
• Media redundancy	No	No	No	No
PROFINET IO Controller				
Services				
- PG/OP communication	Yes	Yes	Yes	Yes
- S7 routing	Yes	Yes	Yes	Yes
- Isochronous mode	No	No	No	No
- Open IE communication	Yes	Yes	Yes	Yes
- IRT	No	No	No	No
- MRP	No	No	No	No
- PROFinergy	Yes	Yes	Yes	Yes
- Prioritized startup	No	No	No	No
- Number of connectable IO Devices, max.	32; In total, up to 1 000 distributed I/O devices can be connected via AS-i, PROFIBUS or PROFINET	128; In total, up to 1 000 distributed I/O devices can be connected via AS-i, PROFIBUS or PROFINET	128; In total, up to 1 000 distributed I/O devices can be connected via AS-i, PROFIBUS or PROFINET	128; In total, up to 1 000 distributed I/O devices can be connected via AS-i, PROFIBUS or PROFINET
- Number of connectable IO Devices for RT, max.	32	128	128	128
- of which in line, max.	32	128	128	128
- Number of IO Devices that can be simultaneously activated/deactivated, max.	8; in total across all interfaces	8; in total across all interfaces	8; in total across all interfaces	8; in total across all interfaces
- Number of IO Devices per tool, max.	8	8		
- Updating times	The minimum value of the update time also depends on communication share set for PROFINET IO, on the number of IO devices, and on the quantity of configured user data	The minimum value of the update time also depends on communication share set for PROFINET IO, on the number of IO devices, and on the quantity of configured user data	The minimum value of the update time also depends on communication share set for PROFINET IO, on the number of IO devices, and on the quantity of configured user data	The minimum value of the update time also depends on communication share set for PROFINET IO, on the number of IO devices, and on the quantity of configured user data
Update time for RT				
- for send cycle of 1 ms	1 ms to 512 ms	1 ms to 512 ms	1 ms to 512 ms	1 ms to 512 ms

SIMATIC S7-1500 Advanced Controllers

Central processing units

Standard CPUs

Technical specifications (continued)

Article number	6ES7516-3AN01-0AB0 CPU 1516-3 PN/DP, 1MB PROG., 5MB DATA	6ES7517-3AP00-0AB0 CPU 1517-3 PN/DP, 2MB PROG./8MB DATA	6ES7518-4AP00-0AB0 CPU 1518-4 PN/DP, 4MB PROG., 20MB DATA	6ES7518-4AP00-3AB0 CPU 1518-4 PN/DP ODK 4MB PROG./20MB DATA
PROFINET IO Device				
Services				
- PG/OP communication	Yes	Yes	Yes	Yes
- S7 routing	Yes	Yes	Yes	Yes
- Isochronous mode	No	No	No	No
- Open IE communication	Yes	Yes	Yes	Yes
- IRT	No	No	No	No
- MRP	No	No	No	No
- MRPD	No	No	No	No
- PROFinergy	Yes	Yes	Yes	Yes
- Prioritized startup	No	No	No	No
- Shared device	Yes	Yes	Yes	Yes
- Number of IO Controllers with shared device, max.	4	4	4	4
3. Interface				
Interface types				
• Number of ports	1	1	1	1
• integrated switch			No	No
• RJ 45 (Ethernet)			Yes; X3	Yes; X3
• RS 485	Yes; X3	Yes; X3		
Functionality				
• PROFINET IO Controller			No	No
• PROFINET IO Device			No	No
• PROFIBUS DP master	Yes	Yes		
• PROFIBUS DP slave	No	No		
• SIMATIC communication	Yes	Yes	Yes	Yes
• Open IE communication			Yes	Yes
• Web server			Yes	Yes
4. Interface				
Interface types				
• Number of ports			1	1
• RS 485			Yes; X4	Yes; X4
Functionality				
• PROFIBUS DP master			Yes	Yes
• PROFIBUS DP slave			No	No
• SIMATIC communication			Yes	Yes
Protocols				
Supports protocol for PROFINET IO	Yes	Yes	Yes	Yes
PROFIsafe	No	No	No	No
PROFIBUS	Yes	Yes	Yes	Yes
Number of connections				
• Number of connections, max.	256; via integrated interfaces of the CPU and connected CPs / CMs	320; via integrated interfaces of the CPU and connected CPs / CMs	384; via integrated interfaces of the CPU and connected CPs / CMs	384; via integrated interfaces of the CPU and connected CPs / CMs
PROFIBUS DP master				
Services				
- Number of DP slaves	125; In total, up to 1 000 distributed I/O devices can be connected via AS-i, PROFIBUS or PROFINET	125; In total, up to 1 000 distributed I/O devices can be connected via AS-i, PROFIBUS or PROFINET	125; In total, up to 1 000 distributed I/O devices can be connected via AS-i, PROFIBUS or PROFINET	125; In total, up to 1 000 distributed I/O devices can be connected via AS-i, PROFIBUS or PROFINET
Isochronous mode				
Isochronous operation (application synchronized up to terminal)	Yes; With minimum OB 6x cycle of 375 µs	Yes; With minimum OB 6x cycle of 250 µs	Yes; With minimum OB 6x cycle of 125 µs	Yes; With minimum OB 6x cycle of 125 µs
Supported technology objects				
Motion Control	Yes; Note: The number of axes affects the cycle time of the PLC program; selection guide via the TIA Selection Tool or SIZER	Yes; Note: The number of axes affects the cycle time of the PLC program; selection guide via the TIA Selection Tool or SIZER	Yes; Note: The number of axes affects the cycle time of the PLC program; selection guide via the TIA Selection Tool or SIZER	Yes; Note: The number of axes affects the cycle time of the PLC program; selection guide via the TIA Selection Tool or SIZER
• Number of available Motion Control resources for technology objects (except cam disks)	2 400	10 240	10 240	10 240

Technical specifications (continued)

Article number	6ES7516-3AN01-0AB0 CPU 1516-3 PN/DP, 1MB PROG., 5MB DATA	6ES7517-3AP00-0AB0 CPU 1517-3 PN/DP, 2MB PROG./8MB DATA	6ES7518-4AP00-0AB0 CPU 1518-4 PN/DP, 4MB PROG., 20MB DATA	6ES7518-4AP00-3AB0 CPU 1518-4 PN/DP ODK 4MB PROG./20MB DATA
Supported technology objects (continued)				
• Required Motion Control resources				
- per speed-controlled axis	40	40	40	40
- per positioning axis	80	80	80	80
- per synchronous axis	160	160	160	160
- per external encoder	80	80	80	80
- per output cam	20	20	20	20
- per cam track	160	160	160	160
- per probe	40	40	40	40
Controller				
• PID_Compact	Yes; Universal PID controller with integrated optimization	Yes; Universal PID controller with integrated optimization	Yes; Universal PID controller with integrated optimization	Yes; Universal PID controller with integrated optimization
• PID_3Step	Yes; PID controller with integrated optimization for valves	Yes; PID controller with integrated optimization for valves	Yes; PID controller with integrated optimization for valves	Yes; PID controller with integrated optimization for valves
• PID-Temp	Yes; PID controller with integrated optimization for temperature	Yes; PID controller with integrated optimization for temperature	Yes; PID controller with integrated optimization for temperature	Yes; PID controller with integrated optimization for temperature
Counting and measuring				
• High-speed counter	Yes	Yes	Yes	Yes
Ambient conditions				
Ambient temperature during operation				
• horizontal installation, min.	0 °C	0 °C	0 °C	0 °C
• horizontal installation, max.	60 °C; Display: 50 °C, at an operating temperature of typically 50 °C, the display is switched off	60 °C; Display: 50 °C, at an operating temperature of typically 50 °C, the display is switched off	60 °C; Display: 50 °C, at an operating temperature of typically 50 °C, the display is switched off	60 °C; Display: 50 °C, at an operating temperature of typically 50 °C, the display is switched off
• vertical installation, min.	0 °C	0 °C	0 °C	0 °C
• vertical installation, max.	40 °C; Display: 40 °C, at an operating temperature of typically 40 °C, the display is switched off	40 °C; Display: 40 °C, at an operating temperature of typically 40 °C, the display is switched off	40 °C; Display: 40 °C, at an operating temperature of typically 40 °C, the display is switched off	40 °C; Display: 40 °C, at an operating temperature of typically 40 °C, the display is switched off
Configuration				
Programming				
Programming language				
- LAD	Yes	Yes	Yes	Yes
- FBD	Yes	Yes	Yes	Yes
- STL	Yes	Yes	Yes	Yes
- SCL	Yes	Yes	Yes	Yes
- GRAPH	Yes	Yes	Yes	Yes
Know-how protection				
• User program protection/password protection	Yes	Yes	Yes	Yes
• Copy protection	Yes	Yes	Yes	Yes
• Block protection	Yes	Yes	Yes	Yes
Access protection				
• Password for display	Yes	Yes	Yes	Yes
• Protection level: Write protection	Yes	Yes	Yes	Yes
• Protection level: Read/write protection	Yes	Yes	Yes	Yes
• Protection level: Complete protection	Yes	Yes	Yes	Yes
Open Development interfaces				
• Size of ODK SO file, max.				5.8 Mbyte
Dimensions				
Width	70 mm	175 mm	175 mm	175 mm
Height	147 mm	147 mm	147 mm	147 mm
Depth	129 mm	129 mm	129 mm	129 mm
Weights				
Weight, approx.	845 g	1 978 g	1 988 g	1 988 g

SIMATIC S7-1500 Advanced Controllers

Central processing units

Standard CPUs

Ordering data	Article No.	Ordering data	Article No.
CPU 1511-1 PN Work memory 150 KB for program, 1 MB for data, PROFINET IO IRT interface; SIMATIC Memory Card required	6ES7511-1AK01-0AB0	PE connection element for DIN rail 2000 mm 20 units	6ES7590-5AA00-0AA0
CPU 1513-1 PN Work memory 300 KB for program, 1.5 MB for data, PROFINET IO IRT interface; SIMATIC Memory Card required	6ES7513-1AL01-0AB0	Power supply For supplying the backplane bus of the S7-1500 24 V DC input voltage, power 25 W 24/48/60 V DC input voltage, power 60 W	6ES7505-0KA00-0AB0 6ES7505-0RA00-0AB0
CPU 1515-2 PN Work memory 500 KB for program, 3 MB for data, PROFINET IO IRT interface, PROFINET interface; SIMATIC Memory Card required	6ES7515-2AM01-0AB0	24/48/60 V DC input voltage, power 60 W, buffering functionality 120/230 V AC input voltage, power 60 W	6ES7505-0RB00-0AB0 6ES7507-0RA00-0AB0
CPU 1516-3 PN/DP Work memory 1 MB for program, 5 MB for data, PROFINET IO IRT interface, PROFINET/PROFIBUS interface; SIMATIC Memory Card required	6ES7516-3AN01-0AB0	Power connector With coding element for power supply module; spare part, 10 units	6ES7590-8AA00-0AA0
CPU 1517-3 PN/DP Work memory 2 MB for program, 8 MB for data, PROFINET IO IRT interface, PROFINET/PROFIBUS interface; SIMATIC Memory Card required	6ES7517-3AP00-0AB0	Load power supply 24 V DC/3 A 24 V DC/8 A	6EP1332-4BA00 6EP1333-4BA00
CPU 1518-4 PN/DP Work memory 4 MB for program, 20 MB for data, PROFINET IO IRT interface, 2 PROFINET interfaces, PROFIBUS interface; SIMATIC Memory Card required	6ES7518-4AP00-0AB0	Power supply connector Spare part; for connecting the 24 V DC supply voltage • With push-in terminals	6ES7193-4JB00-0AA0
CPU 1518-4 PN/DP ODK Work memory 4 MB for program, 20 MB for data, PROFINET IO IRT interface, 2 PROFINET interfaces, PROFIBUS interface; SIMATIC Memory Card required	6ES7518-4AP00-3AB0	PROFIBUS FastConnect RS 485 bus connector with 90° cable outlet With insulation displacement, max. transmission rate 12 Mbps Without PG interface, grounding via control cabinet contact surface; 1 unit With PG interface, grounding via control cabinet contact surface; 1 unit	6ES7972-0BA70-0XA0 6ES7972-0BB70-0XA0
Accessories		PROFIBUS FC Standard Cable GP Standard type with special design for fast mounting, 2-wire, shielded; sold by the meter; max. delivery unit 1000 m, minimum order quantity 20 m	6XV1830-0EH10
SIMATIC Memory Card		PROFIBUS FC Robust Cable 2-wire, shielded; sold by the meter; max. delivery unit 1000 m, minimum order quantity 20 m	6XV1830-0JH10
4 MB	6ES7954-8LC02-0AA0	PROFIBUS FC Flexible Cable 2-wire, shielded; sold by the meter; max. delivery unit 1000 m, minimum order quantity 20 m	6XV1831-2K
12 MB	6ES7954-8LE02-0AA0	PROFIBUS FC Trailing Cable 2-wire, shielded; sold by the meter; max. delivery unit 1000 m, minimum order quantity 20 m Sheath color: Petrol	6XV1830-3EH10
24 MB	6ES7954-8LF02-0AA0	Sheath color: Violet	6XV1831-2L
256 MB	6ES7954-8LL02-0AA0	PROFIBUS FC Food Cable 2-wire, shielded; sold by the meter; max. delivery unit 1000 m, minimum order quantity 20 m	6XV1830-0GH10
2 GB	6ES7954-8LP02-0AA0		
32 GB	6ES7954-8LT03-0AA0		
SIMATIC S7-1500 DIN rail Fixed lengths, with grounding elements • 160 mm • 245 mm • 482 mm • 530 mm • 830 mm For cutting to length by customer, without drill holes; grounding elements must be ordered separately • 2000 mm	6ES7590-1AB60-0AA0 6ES7590-1AC40-0AA0 6ES7590-1AE80-0AA0 6ES7590-1AF30-0AA0 6ES7590-1AJ30-0AA0 6ES7590-1BC00-0AA0		

Ordering data	Article No.	Ordering data	Article No.
PROFIBUS FC Ground Cable 2-wire, shielded; sold by the meter; max. delivery unit 1000 m, minimum order quantity 20 m	6XV1830-3FH10	Front cover for PROFIBUS DP interface For CPU 1517-3 PN/DP and CPU 1518-4 PN/DP; spare part	6ES7591-8AA00-0AA0
PROFIBUS FC FRNC Cable GP 2-wire, shielded, flame-retardant, with copolymer outer sheath FRNC; sold by the meter; max. delivery unit 1000 m, minimum order quantity 20 m	6XV1830-0LH10	SIMATIC S7-1500 Starter Kit Comprising: CPU 1511C-1 PN, SIMATIC Memory Card 4 MB, 160 mm DIN rail, front connector, STEP 7 Professional 365-day license, PM 70 W 120/230 V AC power supply, Ethernet cable, documentation	6ES7511-1CK00-4YB5
PROFIBUS FastConnect Stripping Tool Preadjusted stripping tool for fast stripping of PROFIBUS FastConnect bus cables	6GK1905-6AA00	STEP 7 Professional V14 SP1 Target system: SIMATIC S7-1200, S7-1500, S7-300, S7-400, WinAC Requirement: Windows 7 Professional SP1 (64-bit), Windows 7 Enterprise SP1 (64-bit), Windows 7 Ultimate SP1 (64-bit), Windows 8.1 Professional (64-bit), Windows 8.1 Enterprise (64-bit), Windows 10 Professional Version 1607, Windows 10 Enterprise Version 1607, Windows 10 Enterprise 2016 LTSB, Windows 10 Enterprise 2015 LTSB, Windows Server 2008 R2 StdE (full installation), Windows Server 2012 StdE (full installation), Windows Server 2016 Standard (full installation); Type of delivery: English, German, Chinese, Italian, French, Spanish	
IE FC RJ45 plugs RJ45 plug connector for Industrial Ethernet with a rugged metal enclosure and integrated insulation displacement contacts for connecting Industrial Ethernet FC installation cables		STEP 7 Professional V14 SP1, floating license	6ES7822-1AA04-0YA5
IE FC RJ45 Plug 180 180° cable outlet 1 unit 10 units 50 units	6GK1901-1BB10-2AA0 6GK1901-1BB10-2AB0 6GK1901-1BB10-2AE0	STEP 7 Professional V14 SP1, floating license, software download incl. license key ¹⁾	6ES7822-1AE04-0YA5
IE FC TP Standard Cable GP 2x2 4-wire, shielded TP installation cable for connection to IE FC outlet RJ45/ IE FC RJ45 plug; PROFINET-compatible; with UL approval; sold by the meter; max. delivery unit 1000 m, minimum order quantity 20 m	6XV1840-2AH10	Email address required for delivery	
IE FC TP Trailing Cable 2 x 2 (Type C) 4-wire, shielded TP installation cable for connection to IE FC outlet RJ45/ IE FC RJ45 Plug 180/90 for use as trailing cable; PROFINET-compatible; with UL approval; sold by the meter; max. delivery unit 1000 m, minimum order quantity 20 m	6XV1840-3AH10	SIMATIC ODK 1500S V2.0 Open Development Kit for support in developing Windows and real-time library functions Package with data storage medium Download incl. license key ¹⁾ Email address required for delivery	6ES7806-2CD02-0YA0 6ES7806-2CD02-0YG0
IE FC TP Marine Cable 2 x 2 (Type B) 4-wire, shielded TP installation cable for connection to IE FC outlet RJ45/ IE FC RJ45 Plug 180/90 with marine approval, sold by the meter; max. delivery unit 1000 m, minimum order quantity 20 m	6XV1840-4AH10	SIMATIC Target 1500S for Simulink V1.0 Download incl. license key ¹⁾ Email address required for delivery	6ES7823-1BE00-0YA5
IE FC Stripping Tool Preadjusted stripping tool for fast stripping of Industrial Ethernet FC cables	6GK1901-1GA00	SIMATIC Manual Collection Electronic manuals on DVD, multi-language: LOGO!, SIMADYN, SIMATIC bus components, SIMATIC C7, SIMATIC distributed I/O, SIMATIC HMI, SIMATIC Sensors, SIMATIC NET, SIMATIC PC Based Automation, SIMATIC PCS 7, SIMATIC PG/PC, SIMATIC S7, SIMATIC Software, SIMATIC TDC	6ES7998-8XC01-8YE0
Display For CPU 1511-1 PN and CPU 1513-1 PN; spare part For CPU 1515-2 PN, CPU 1516-3 PN/DP, CPU 1517-3 PN/DP and CPU 1518-4 PN/DP; spare part	6ES7591-1AA01-0AA0 6ES7591-1BA01-0AA0	SIMATIC Manual Collection update service for 1 year Current "Manual Collection" DVD and the three subsequent updates	6ES7998-8XC01-8YE2

¹⁾ For up-to-date information and download availability, see:
<http://www.siemens.com/tia-online-software-delivery>

SIMATIC S7-1500 Advanced Controllers

Central processing units

SIPLUS Standard CPUs

Overview SIPLUS CPU 1511-1 PN



- Entry-level CPU in the S7-1500 Controller product range
- Suitable for applications with medium requirements for program scope and processing speed
- Used as central controller in production lines with central and distributed I/O
- PROFINET IO IRT interface with 2-port switch
- PROFINET IO controller for operating distributed I/O on PROFINET
- PROFINET I-device for connecting the CPU as an intelligent PROFINET device under a SIMATIC or third-party PROFINET IO controller
- Isochronous mode
- SIMATIC Memory Card required for operation of the CPU

Note:

SIPLUS extreme products are based on SIMATIC standard products. The contents listed here were taken from the respective standard products. SIPLUS extreme-specific information was added.

Overview SIPLUS CPU 1513-1 PN



- The CPU for applications with medium/high requirements for program and data storage in the S7-1500 Controller product range
- High processing speed for binary and floating-point arithmetic
- Used as central controller in production lines with central and distributed I/O

- PROFINET IO IRT interface with 2-port switch
- PROFINET IO controller for operating distributed I/O on PROFINET
- PROFINET I-device for connecting the CPU as an intelligent PROFINET device under a SIMATIC or third-party PROFINET IO controller
- Isochronous mode
- SIMATIC Memory Card required for operation of the CPU

Please note:

SIPLUS extreme products are based on SIMATIC standard products. The contents listed here were taken from the respective standard products. SIPLUS extreme-specific information was added.

Overview SIPLUS CPU 1516-3 PN/DP



- The CPU with large program and data memory in the S7-1500 Controller product range for applications with high program scope requirements.
- High processing speed for binary and floating-point arithmetic
- Used as central controller in production lines with central and distributed I/O
- PROFINET IO IRT interface with 2-port switch
- Additional PROFINET interface with separate IP address
- PROFINET IO controller for operating distributed I/O on PROFINET.
- PROFINET I-device for connecting the CPU as an intelligent PROFINET device under a SIMATIC or third-party PROFINET IO controller.
- PROFIBUS DP master interface
- Isochronous mode on PROFIBUS and PROFINET
- SIMATIC Memory Card required for operation of the CPU

Note:

SIPLUS extreme products are based on SIMATIC standard products. The contents listed here were taken from the respective standard products. SIPLUS extreme-specific information was added.

SIMATIC S7-1500 Advanced Controllers

Central processing units

SIPLUS Standard CPUs

Overview SIPLUS CPU 1518-4 PN/DP



- The CPU with a very large program and data memory in the S7-1500 Controller product range for demanding applications with extremely high requirements regarding program scope, performance and networking
- Extremely high processing speed for binary and floating-point arithmetic
- For cross-industry automation tasks in series machine, special machine and plant construction
- Used as central controller in production lines with central and distributed I/O

- PROFINET IO IRT interface with 2-port switch
- Two additional PROFINET interfaces with separate IP address
- PROFINET IO controller for operating distributed I/O on PROFINET.
- PROFINET I-device for connecting the CPU as an intelligent PROFINET device under a SIMATIC or third-party PROFINET IO controller.
- PROFIBUS DP master interface
- Isochronous mode on PROFIBUS and PROFINET
- Integrated motion control functionalities for controlling speed-controlled and positioning axes, support for external encoders
- Integrated web server with the option of creating user-defined web pages

SIMATIC Memory Card required for operating the CPU

Note:

SIPLUS extreme products are based on SIMATIC standard products. The contents listed here were taken from the respective standard products. SIPLUS extreme specific information has been added.

4

Technical specifications

Article number	6AG1511-1AK01-2AB0	6AG1511-1AK01-7AB0	6AG1513-1AL01-2AB0	6AG1513-1AL01-7AB0
Based on	6ES7511-1AK01-0AB0 SIPLUS S7-1500 CPU 1511-1 PN	6ES7511-1AK01-0AB0 SIPLUS S7-1500 CPU 1511-1 PN	6ES7513-1AL01-0AB0 SIPLUS S7-1500 CPU 1513-1 PN	6ES7513-1AL01-0AB0 SIPLUS S7-1500 CPU 1513-1 PN
Ambient conditions				
Ambient temperature during operation				
• horizontal installation, min.	-40 °C; = Tmin; Startup @ -20 °C	-40 °C; = Tmin; Startup @ -20 °C	-40 °C; = Tmin; Startup @ -20 °C	-40 °C; = Tmin; Startup @ -20 °C
• horizontal installation, max.	60 °C; Display: 50 °C, at an operating temperature of typically 50 °C, the display is switched off	70 °C; Display: 50 °C, at an operating temperature of typically 50 °C, the display is switched off	60 °C; Display: 50 °C, at an operating temperature of typically 50 °C, the display is switched off	70 °C; Display: 50 °C, at an operating temperature of typically 50 °C, the display is switched off
• vertical installation, min.	-40 °C; = Tmin; Startup @ -20 °C	-40 °C; = Tmin; Startup @ -20 °C	-40 °C; = Tmin; Startup @ -20 °C	-40 °C; = Tmin; Startup @ -20 °C
• vertical installation, max.	40 °C; Display: 40 °C, at an operating temperature of typically 40 °C, the display is switched off	40 °C; Display: 40 °C, at an operating temperature of typically 40 °C, the display is switched off	40 °C; Display: 40 °C, at an operating temperature of typically 40 °C, the display is switched off	40 °C; Display: 40 °C, at an operating temperature of typically 40 °C, the display is switched off
Extended ambient conditions				
• relative to ambient temperature-atmospheric pressure-installation altitude	Tmin ... Tmax at 1080 hPa ... 795 hPa (-1000 m ... +2000 m) // Tmin ... (Tmax - 10K) at 795 hPa ... 658 hPa (+2000 m ... +3500 m) // Tmin ... (Tmax - 20K) at 658 hPa ... 540 hPa (+3500 m ... +5000 m)	Tmin ... Tmax at 1080 hPa ... 795 hPa (-1000 m ... +2000 m) // Tmin ... (Tmax - 10K) at 795 hPa ... 658 hPa (+2000 m ... +3500 m) // Tmin ... (Tmax - 20K) at 658 hPa ... 540 hPa (+3500 m ... +5000 m)	Tmin ... Tmax at 1080 hPa ... 795 hPa (-1000 m ... +2000 m) // Tmin ... (Tmax - 10K) at 795 hPa ... 658 hPa (+2000 m ... +3500 m) // Tmin ... (Tmax - 20K) at 658 hPa ... 540 hPa (+3500 m ... +5000 m)	Tmin ... Tmax at 1080 hPa ... 795 hPa (-1000 m ... +2000 m) // Tmin ... (Tmax - 10K) at 795 hPa ... 658 hPa (+2000 m ... +3500 m) // Tmin ... (Tmax - 20K) at 658 hPa ... 540 hPa (+3500 m ... +5000 m)
Relative humidity				
- With condensation, tested in accordance with IEC 60068-2-38, max.	100 %; RH incl. condensation / frost (no commissioning in bedewed state), horizontal installation	100 %; RH incl. condensation / frost (no commissioning in bedewed state), horizontal installation	100 %; RH incl. condensation / frost (no commissioning in bedewed state), horizontal installation	100 %; RH incl. condensation / frost (no commissioning in bedewed state), horizontal installation

SIMATIC S7-1500 Advanced Controllers

Central processing units

SIPLUS Standard CPUs

Technical specifications (continued)

Article number	6AG1511-1AK01-2AB0	6AG1511-1AK01-7AB0	6AG1513-1AL01-2AB0	6AG1513-1AL01-7AB0
Based on	6ES7511-1AK01-0AB0 SIPLUS S7-1500 CPU 1511-1 PN	6ES7511-1AK01-0AB0 SIPLUS S7-1500 CPU 1511-1 PN	6ES7513-1AL01-0AB0 SIPLUS S7-1500 CPU 1513-1 PN	6ES7513-1AL01-0AB0 SIPLUS S7-1500 CPU 1513-1 PN
Resistance				
- against biologically active substances / conformity with EN 60721-3-3	Yes; Class 3B2 mold, fungus and dry rot spores (with the exception of fauna). The supplied connector covers must remain on the unused interfaces during operation!	Yes; Class 3B2 mold, fungus and dry rot spores (with the exception of fauna). The supplied connector covers must remain on the unused interfaces during operation!	Yes; Class 3B2 mold, fungus and dry rot spores (with the exception of fauna). The supplied connector covers must remain on the unused interfaces during operation!	Yes; Class 3B2 mold, fungus and dry rot spores (with the exception of fauna). The supplied connector covers must remain on the unused interfaces during operation!
- against chemically active substances / conformity with EN 60721-3-3	Yes; Class 3C4 (RH < 75%) incl. salt spray according to EN 60068-2-52 (degree of severity 3). The supplied connector covers must remain on the unused interfaces during operation!	Yes; Class 3C4 incl. salt spray. The supplied connector covers must remain on the unused interfaces during operation!	Yes; Class 3C4 (RH < 75%) incl. salt spray according to EN 60068-2-52 (degree of severity 3). The supplied connector covers must remain on the unused interfaces during operation!	Yes; Class 3C4 (RH < 75%) incl. salt spray according to EN 60068-2-52 (degree of severity 3). The supplied connector covers must remain on the unused interfaces during operation!
- against mechanically active substances / conformity with EN 60721-3-3	Yes; Class 3S4 incl. sand, dust. The supplied connector covers must remain on the unused interfaces during operation!	Yes; Class 3S4 incl. sand, dust. The supplied connector covers must remain on the unused interfaces during operation in corrosive atmospheres!	Yes; Class 3S4 incl. sand, dust. The supplied connector covers must remain on the unused interfaces during operation!	Yes; Class 3S4 incl. sand, dust. The supplied connector covers must remain on the unused interfaces during operation!

Article number	6AG1516-3AN01-2AB0	6AG1516-3AN01-7AB0	6AG1518-4AP00-4AB0
Based on	6ES7516-3AN01-0AB0 SIPLUS S7-1500 CPU 1516-3 PN/DP	6ES7516-3AN01-0AB0 SIPLUS S7-1500 CPU 1516-3 PN/DP	6ES7518-4AP00-0AB0 SIPLUS S7-1500 CPU 1518-4 PN/DP
Ambient conditions			
Ambient temperature during operation			
• horizontal installation, min.	-40 °C; = Tmin; Startup @ -20 °C	-40 °C; = Tmin; Startup @ -20 °C	0 °C
• horizontal installation, max.	60 °C; Display: 50 °C, at an operating temperature of typically 50 °C, the display is switched off	70 °C; Display: 50 °C, at an operating temperature of typically 50 °C, the display is switched off	60 °C; Display: 50 °C, at an operating temperature of typically 50 °C, the display is switched off
• vertical installation, min.	-40 °C; = Tmin; Startup @ -20 °C	-40 °C; = Tmin; Startup @ -20 °C	0 °C
• vertical installation, max.	40 °C; Display: 40 °C, at an operating temperature of typically 40 °C, the display is switched off	40 °C; Display: 40 °C, at an operating temperature of typically 40 °C, the display is switched off	40 °C; Display: 40 °C, at an operating temperature of typically 40 °C, the display is switched off
Extended ambient conditions			
• relative to ambient temperature-atmospheric pressure-installation altitude	Tmin ... Tmax at 1080 hPa ... 795 hPa (-1000 m ... +2000 m) // Tmin ... (Tmax - 10K) at 795 hPa ... 658 hPa (+2000 m ... +3500 m) // Tmin ... (Tmax - 20K) at 658 hPa ... 540 hPa (+3500 m ... +5000 m)		Tmin ... Tmax at 1080 hPa ... 795 hPa (-1000 m ... +2000 m) // Tmin ... (Tmax - 10K) at 795 hPa ... 658 hPa (+2000 m ... +3500 m) // Tmin ... (Tmax - 20K) at 658 hPa ... 540 hPa (+3500 m ... +5000 m)
Relative humidity			
- With condensation, tested in accordance with IEC 60068-2-38, max.	100 %; RH incl. condensation / frost (no commissioning in bedewed state), horizontal installation	100 %; RH incl. condensation / frost (no commissioning in bedewed state), horizontal installation	100 %; RH incl. condensation/frost (no commissioning under condensation conditions)
Resistance			
- against biologically active substances / conformity with EN 60721-3-3	Yes; Class 3B2 mold, fungus and dry rot spores (with the exception of fauna). The supplied connector covers must remain on the unused interfaces during operation!	Yes; Class 3B2 mold, fungus and dry rot spores (with the exception of fauna). The supplied connector covers must remain on the unused interfaces during operation!	Available soon
- against chemically active substances / conformity with EN 60721-3-3	Yes; Class 3C4 (RH < 75%) incl. salt spray according to EN 60068-2-52 (degree of severity 3). The supplied connector covers must remain on the unused interfaces during operation!	Yes; Class 3C4 incl. salt spray. The supplied connector covers must remain on the unused interfaces during operation!	Available soon
- against mechanically active substances / conformity with EN 60721-3-3	Yes; Class 3S4 incl. sand, dust. The supplied connector covers must remain on the unused interfaces during operation!	Yes; Class 3S4 incl. sand, dust. The supplied connector covers must remain on the unused interfaces during operation in corrosive atmospheres!	Available soon

Ordering data	Article No.	Ordering data	Article No.
SIPLUS CPU 1511-1 PN (Extended temperature range and exposure to media) Work memory 150 KB for program, 1 MB for data, PROFINET IO IRT interface; SIMATIC Memory Card required Temperature range -40 ... +60 °C (startup -20 °C) Temperature range -40 ... +70 °C (startup -20 °C)	 6AG1511-1AK01-2AB0 6AG1511-1AK01-7AB0	Accessories System power supply (Extended temperature range and exposure to media) 24 V DC input voltage, power 25 W 24/48/60 V DC input voltage, power 60 W 120/230 V AC input voltage, power 60 W	 6AG1505-0KA00-7AB0 6AG1505-0RA00-7AB0 6AG1507-0RA00-7AB0
SIPLUS CPU 1513-1 PN (Extended temperature range and exposure to media) Work memory 300 KB for program, 1.5 MB for data, PROFINET IO IRT interface; SIMATIC Memory Card required Temperature range -40 ... +60 °C (startup -20 °C) Temperature range -40 ... +70 °C (startup -20 °C)	 6AG1513-1AL01-2AB0 6AG1513-1AL01-7AB0	Load power supply (Extended temperature range and exposure to media) 24 V DC/3A 24 V DC/8A Display (Extended temperature range and exposure to media) For SIPLUS CPU 1511-1 PN and CPU 1513-1 PN; spare part For SIPLUS CPU 1516-3 PN/DP and SIPLUS CPU 1518-4 PN/DP; spare part	 6AG1332-4BA00-7AA0 6AG1333-4BA00-7AA0 6AG1591-1AA01-2AA0 6AG1591-1BA01-2AA0
SIPLUS CPU 1516-3 PN/DP (Extended temperature range and exposure to media) Work memory 1 MB for program, 5 MB for data, PROFINET IO IRT interface, PROFINET/PROFIBUS interface; SIMATIC Memory Card required Temperature range -40 ... +60 °C (startup -20 °C) Temperature range -40 ... +70 °C (startup -20 °C)	 6AG1516-3AN01-2AB0 6AG1516-3AN01-7AB0	Further accessories	See SIMATIC S7-1500, standard CPUs, page 4/18
SIPLUS CPU 1518-4 PN/DP (Exposure to media) Work memory 3 MB for program, 10 MB for data, PROFINET IO IRT interface, 2 PROFINET/PROFIBUS interfaces; SIMATIC Memory Card required	6AG1518-4AP00-4AB0		

SIMATIC S7-1500 Advanced Controllers

Central processing units

Compact CPUs

Overview CPU 1511C-1 PN



- The compact CPU with integral digital and analog inputs and outputs in the S7-1500 Controller product range
- With integrated technological functions, e.g. high-speed counter (HSC), frequency measurement, period duration measurement or stepper motor control, pulse duration modulation, frequency output
- Suitable for applications with medium requirements for program scope and processing speed
- Used as central controller in production lines with central and distributed I/O
- PROFINET IO IRT interface with 2-port switch
- PROFINET IO controller for operating distributed I/O on PROFINET
- PROFINET I-device for connecting the CPU as an intelligent PROFINET device under a SIMATIC or third-party PROFINET IO controller
- OPC UA Server (Data Access) as runtime option for the easy connection of SIMATIC S7-1500 to third-party devices/systems
- Isochronous mode
- Integrated motion control functionalities for controlling speed-controlled and positioning axes, support for external encoders, cams/cam tracks and probes
- Integrated web server for diagnostics with the option of creating user-defined web pages

Note

SIMATIC Memory Card required for operation of the CPU.

Overview CPU 1512C-1 PN



- The compact CPU with integral digital and analog inputs and outputs in the S7-1500 Controller product range
- With integrated technological functions, e.g. high-speed counter (HSC), frequency measurement, period duration measurement or stepper motor control, pulse duration modulation, frequency output
- Suitable for applications with medium requirements for program scope and processing speed
- Used as central controller in production lines with central and distributed I/O
- PROFINET IO IRT interface with 2-port switch
- PROFINET IO controller for operating distributed I/O on PROFINET
- PROFINET I-device for connecting the CPU as an intelligent PROFINET device under a SIMATIC or third-party PROFINET IO controller
- OPC UA Server (Data Access) as runtime option for the easy connection of SIMATIC S7-1500 to third-party devices/systems
- Isochronous mode
- Integrated motion control functionalities for controlling speed-controlled and positioning axes, support for external encoders, cams/cam tracks and probes
- Integrated web server for diagnostics with the option of creating user-defined web pages

Note

SIMATIC Memory Card required for operation of the CPU.

Technical specifications

Article number	6ES7511-1CK00-0AB0 CPU 1511C-1 PN, 175 KB PROG, 1 MB DATA	6ES7512-1CK00-0AB0 CPU 1512C-1 PN, 250 KB PROG, 1 MB DATA
General information		
Product type designation	CPU 1511C-1 PN	CPU 1512C-1 PN
Engineering with		
• STEP 7 TIA Portal configurable/ integrated as of version	V14	V14
Display		
Screen diagonal [cm]	3.45 cm	3.45 cm
Supply voltage		
Type of supply voltage	24 V DC	24 V DC
Input current		
Digital inputs		
• from load voltage L+ (without load), max.	20 mA; per group	20 mA; per group
Digital outputs		
• from load voltage L+, max.	30 mA; Per group, without load	30 mA; Per group, without load
Power loss		
Power loss, typ.	11.8 W	15.2 W
Memory		
Work memory		
• integrated (for program)	175 kbyte	250 kbyte
• integrated (for data)	1 Mbyte	1 Mbyte
Load memory		
• Plug-in (SIMATIC Memory Card), max.	32 Gbyte	32 Gbyte
CPU processing times		
for bit operations, typ.	60 ns	48 ns
for word operations, typ.	72 ns	58 ns
for fixed point arithmetic, typ.	96 ns	77 ns
for floating point arithmetic, typ.	384 ns	307 ns
Counters, timers and their retentivity		
S7 counter		
• Number	2 048	2 048
IEC counter		
• Number	Any (only limited by the main memory)	Any (only limited by the main memory)
S7 times		
• Number	2 048	2 048
IEC timer		
• Number	Any (only limited by the main memory)	Any (only limited by the main memory)
Data areas and their retentivity		
Flag		
• Number, max.	16 kbyte	16 kbyte
Address area		
I/O address area		
• Inputs	32 kbyte; All inputs are in the process image	32 kbyte; All inputs are in the process image
• Outputs	32 kbyte; All outputs are in the process image	32 kbyte; All outputs are in the process image
Time of day		
Clock		
• Type	Hardware clock	Hardware clock
Digital inputs		
integrated channels (DI)	16	32
Digital outputs		
integrated channels (DO)	16	32
Short-circuit protection	Yes; electronic/thermal	Yes; electronic/thermal
Analog outputs		
integrated channels (AO)	2	2
1. Interface		
Interface types		
• Number of ports	2	2
• integrated switch	Yes	Yes
• RJ 45 (Ethernet)	Yes; X1	Yes; X1

SIMATIC S7-1500 Advanced Controllers

Central processing units

Compact CPUs

Technical specifications (continued)

Article number	6ES7511-1CK00-0AB0 CPU 1511C-1 PN, 175 KB PROG, 1 MB DATA	6ES7512-1CK00-0AB0 CPU 1512C-1 PN, 250 KB PROG, 1 MB DATA
Functionality		
• PROFINET IO Controller	Yes	Yes
• PROFINET IO Device	Yes	Yes
• SIMATIC communication	Yes	Yes
• Open IE communication	Yes	Yes
• Web server	Yes	Yes
• Media redundancy	Yes	Yes
PROFINET IO Controller		
Services		
- PG/OP communication	Yes	Yes
- S7 routing	Yes	Yes
- Isochronous mode	Yes	Yes
- Open IE communication	Yes	Yes
- IRT	Yes	Yes
- MRP	Yes; As MRP redundancy manager and/or MRP client; max. number of devices in the ring: 50	Yes; As MRP redundancy manager and/or MRP client; max. number of devices in the ring: 50
- MRPD	Yes; Requirement: IRT	Yes; Requirement: IRT
- Prioritized startup	Yes; Max. 32 PROFINET devices	Yes; Max. 32 PROFINET devices
- Number of connectable IO Devices, max.	128; In total, up to 256 distributed I/O devices can be connected via AS-i, PROFIBUS or PROFINET	128; In total, up to 512 distributed I/O devices can be connected via AS-i, PROFIBUS or PROFINET
- Of which IO devices with IRT, max.	64	64
- Number of connectable IO Devices for RT, max.	128	128
- of which in line, max.	128	128
- Number of IO Devices that can be simultaneously activated/deactivated, max.	8; in total across all interfaces	8; in total across all interfaces
- Number of IO Devices per tool, max.	8	8
- Updating times	The minimum value of the update time also depends on communication share set for PROFINET IO, on the number of IO devices, and on the quantity of configured user data	The minimum value of the update time also depends on communication share set for PROFINET IO, on the number of IO devices, and on the quantity of configured user data
Update time for IRT		
- for send cycle of 250 µs	250 µs to 4 ms; Note: In the case of IRT with isochronous mode, the minimum update time of 625 µs of the isochronous OB is decisive	250 µs to 4 ms; Note: In the case of IRT with isochronous mode, the minimum update time of 625 µs of the isochronous OB is decisive
- for send cycle of 500 µs	500 µs to 8 ms; Note: In the case of IRT with isochronous mode, the minimum update time of 625 µs of the isochronous OB is decisive	500 µs to 8 ms; Note: In the case of IRT with isochronous mode, the minimum update time of 625 µs of the isochronous OB is decisive
- for send cycle of 1 ms	1 ms to 16 ms	1 ms to 16 ms
- for send cycle of 2 ms	2 ms to 32 ms	2 ms to 32 ms
- for send cycle of 4 ms	4 ms to 64 ms	4 ms to 64 ms
- With IRT and parameterization of "odd" send cycles	Update time = set "odd" send clock (any multiple of 125 µs: 375 µs, 625 µs ... 3 875 µs)	Update time = set "odd" send clock (any multiple of 125 µs: 375 µs, 625 µs ... 3 875 µs)
Update time for RT		
- for send cycle of 250 µs	250 µs to 128 ms	250 µs to 128 ms
- for send cycle of 500 µs	500 µs to 256 ms	500 µs to 256 ms
- for send cycle of 1 ms	1 ms to 512 ms	1 ms to 512 ms
- for send cycle of 2 ms	2 ms to 512 ms	2 ms to 512 ms
- for send cycle of 4 ms	4 ms to 512 ms	4 ms to 512 ms
PROFINET IO Device		
Services		
- PG/OP communication	Yes	Yes
- S7 routing	Yes	Yes
- Isochronous mode	No	No
- Open IE communication	Yes	Yes
- IRT	Yes	Yes
- MRP	Yes	Yes
- MRPD	Yes; Requirement: IRT	Yes; Requirement: IRT
- PROFlenergy	Yes	Yes
- Shared device	Yes	Yes
- Number of IO Controllers with shared device, max.	4	4

Technical specifications (continued)

Article number	6ES7511-1CK00-0AB0	6ES7512-1CK00-0AB0
	CPU 1511C-1 PN, 175 KB PROG, 1 MB DATA	CPU 1512C-1 PN, 250 KB PROG, 1 MB DATA
Protocols		
Number of connections		
• Number of connections, max.	96; via integrated interfaces of the CPU and connected CPs / CMs	128; via integrated interfaces of the CPU and connected CPs / CMs
PROFINET IO Controller		
Services		
- Number of connectable IO Devices, max.	128; In total, up to 256 distributed I/O devices can be connected via AS-i, PROFIBUS or PROFINET	128; In total, up to 512 distributed I/O devices can be connected via AS-i, PROFIBUS or PROFINET
- Of which IO devices with IRT, max.	64	64
- Number of connectable IO Devices for RT, max.	128	128
Isochronous mode		
Isochronous operation (application synchronized up to terminal)	Yes; With minimum OB 6x cycle of 625 µs	Yes; With minimum OB 6x cycle of 625 µs
Supported technology objects		
Motion Control	Yes; Note: The number of axes affects the cycle time of the PLC program; selection guide via the TIA Selection Tool or SIZER	Yes; Note: The number of axes affects the cycle time of the PLC program; selection guide via the TIA Selection Tool or SIZER
• Number of available Motion Control resources for technology objects (except cam disks)	800	800
• Required Motion Control resources		
- per speed-controlled axis	40	40
- per positioning axis	80	80
- per synchronous axis	160	160
- per external encoder	80	80
- per output cam	20	20
- per cam track	160	160
- per probe	40	40
Controller		
• PID_Compact	Yes; Universal PID controller with integrated optimization	Yes; Universal PID controller with integrated optimization
• PID_3Step	Yes; PID controller with integrated optimization for valves	Yes; PID controller with integrated optimization for valves
• PID-Temp	Yes; PID controller with integrated optimization for temperature	Yes; PID controller with integrated optimization for temperature
Counting and measuring		
• High-speed counter	Yes	Yes
Isolation		
Isolation tested with	707 V DC (type test)	707 V DC (type test)
Ambient conditions		
Ambient temperature during operation		
• horizontal installation, min.	0 °C	0 °C
• horizontal installation, max.	60 °C; Note derating data for onboard I/O in the manual. Display: 50 °C, at an operating temperature of typically 50 °C, the display is switched off	60 °C; Note derating data for onboard I/O in the manual. Display: 50 °C, at an operating temperature of typically 50 °C, the display is switched off
• vertical installation, min.	0 °C	0 °C
• vertical installation, max.	40 °C; Note derating data for onboard I/O in the manual. Display: 40 °C, at an operating temperature of typically 40 °C, the display is switched off	40 °C; Note derating data for onboard I/O in the manual. Display: 40 °C, at an operating temperature of typically 40 °C, the display is switched off
Configuration		
Programming		
Programming language		
- LAD	Yes	Yes
- FBD	Yes	Yes
- STL	Yes	Yes
- SCL	Yes	Yes
- GRAPH	Yes	Yes
Know-how protection		
• User program protection/password protection	Yes	Yes
• Copy protection	Yes	Yes
• Block protection	Yes	Yes

SIMATIC S7-1500 Advanced Controllers

Central processing units

Compact CPUs

Technical specifications (continued)

Article number	6ES7511-1CK00-0AB0	6ES7512-1CK00-0AB0
	CPU 1511C-1 PN, 175 KB PROG, 1 MB DATA	CPU 1512C-1 PN, 250 KB PROG, 1 MB DATA
Access protection		
• Password for display	Yes	Yes
• Protection level: Write protection	Yes	Yes
• Protection level: Read/write protection	Yes	Yes
• Protection level: Complete protection	Yes	Yes
Dimensions		
Width	85 mm	110 mm
Height	147 mm	147 mm
Depth	129 mm	129 mm
Weights		
Weight, approx.	1 050 g	1 360 g

Ordering data

Article No.	Article No.
CPU 1511C-1 PN Work memory 175 KB for program, 1 MB for data, 16 digital inputs, 16 digital outputs, 5 analog inputs, 2 analog outputs, 6 high-speed counters, PROFINET IO IRT interface; SIMATIC Memory Card required	SIMATIC S7-1500 DIN rail Fixed lengths, with grounding elements <ul style="list-style-type: none"> • 160 mm • 245 mm • 482 mm • 530 mm • 830 mm For cutting to length by customer, without drill holes; grounding elements must be ordered separately <ul style="list-style-type: none"> • 2000 mm
CPU 1512C-1 PN Work memory 250 KB for program, 1 MB for data, 32 digital inputs, 32 digital outputs, 5 analog inputs, 2 analog outputs, 6 high-speed counters, PROFINET IO IRT interface; SIMATIC Memory Card required	PE connection element for DIN rail 2000 mm 20 units
Accessories SIMATIC Memory Card 4 MB 12 MB 24 MB 256 MB 2 GB 32 GB	Power supply For supplying the backplane bus of the S7-1500 24 V DC input voltage, power 25 W 24/48/60 V DC input voltage, power 60 W 24/48/60 V DC input voltage, power 60 W, buffering functionality 120/230 V AC input voltage, power 60 W
Front connector For 25 mm modules; including cable ties and individual labeling strips; push-in terminal 40-pin; spare part	Power connector With coding element for power supply module; spare part, 10 units
Shielding set I/O For 25 mm modules; infeed element, shield bracket, and shield terminal; 4 units, spare part (one shield set supplied with the module).	Load power supply 24 V DC/3A 24 V DC/8A
Shield terminal 10 units; spare part	Power supply connector Spare part; for connecting the 24 V DC supply voltage <ul style="list-style-type: none"> • with push-in terminals
	6ES7590-1AB60-0AA0 6ES7590-1AC40-0AA0 6ES7590-1AE80-0AA0 6ES7590-1AF30-0AA0 6ES7590-1AJ30-0AA0 6ES7590-1BC00-0AA0 6ES7590-5AA00-0AA0 6ES7505-0KA00-0AB0 6ES7505-0RA00-0AB0 6ES7505-0RB00-0AB0 6ES7507-0RA00-0AB0 6ES7590-8AA00-0AA0 6EP1332-4BA00 6EP1333-4BA00 6ES7193-4JB00-0AA0

Ordering data	Article No.	Article No.
IE FC RJ45 plugs RJ45 plug connector for Industrial Ethernet with a rugged metal enclosure and integrated insulation displacement contacts for connecting Industrial Ethernet FC installation cables		
IE FC RJ45 Plug 180 180° cable outlet 1 unit 10 units 50 units	6GK1901-1BB10-2AA0 6GK1901-1BB10-2AB0 6GK1901-1BB10-2AE0	
IE FC TP Standard Cable GP 2x2 4-wire, shielded TP installation cable for connection to IE FC outlet RJ45/ IE FC RJ45 plug; PROFINET-compatible; with UL approval; sold by the meter; max. delivery unit 1000 m, minimum order quantity 20 m	6XV1840-2AH10	
IE FC TP Trailing Cable 2 x 2 (Type C) 4-wire, shielded TP installation cable for connection to IE FC outlet RJ45/ IE FC RJ45 Plug 180/90 for use as trailing cable; PROFINET-compatible; with UL approval; sold by the meter; max. delivery unit 1000 m, minimum order quantity 20 m	6XV1840-3AH10	
IE FC TP Marine Cable 2 x 2 (Type B) 4-wire, shielded TP installation cable for connection to IE FC outlet RJ45/ IE FC RJ45 Plug 180/90 with marine approval, sold by the meter; max. delivery unit 1000 m, minimum order quantity 20 m	6XV1840-4AH10	
IE FC Stripping Tool Preadjusted stripping tool for fast stripping of Industrial Ethernet FC cables	6GK1901-1GA00	
Display For CPU 1511(F), CPU 1511C, CPU 1512C, CPU 1513(F); spare part	6ES7591-1AA01-0AA0	
SIMATIC S7-1500 Starter Kit Comprising: CPU 1511C-1 PN, SIMATIC Memory Card 4 MB, 160 mm DIN rail, front connector, STEP 7 Professional 365-day license, PM 70 W 120/230 V AC power supply, Ethernet cable, documentation	6ES7511-1CK00-4YB5	
		STEP 7 Professional V14 SP1 Target system: SIMATIC S7-1200, S7-1500, S7-300, S7-400, WinAC Requirement: Windows 7 Professional SP 1 (64-bit), Windows 7 Enterprise SP1 (64-bit), Windows 7 Ultimate SP1 (64-bit), Windows 8.1 Professional (64-bit), Windows 8.1 Enterprise (64-bit), Windows 10 Professional Version 1607, Windows 10 Enterprise Version 1607, Windows 10 Enterprise 2016 LTSB, Windows 10 Enterprise 2015 LTSB, Windows Server 2008 R2 StdE (full installation), Windows Server 2012 StdE (full installation), Windows Server 2016 Standard (full installation); Type of delivery: English, German, Chinese, Italian, French, Spanish STEP 7 Professional V14 SP1, floating license STEP 7 Professional V14 SP1, floating license, software download incl. license key ¹⁾ Email address required for delivery
		6ES7822-1AA04-0YA5 6ES7822-1AE04-0YA5
		SIMATIC Manual Collection Electronic manuals on DVD, multi-language: LOGO!, SIMADYN, SIMATIC bus components, SIMATIC C7, SIMATIC distributed I/O, SIMATIC HMI, SIMATIC Sensors, SIMATIC NET, SIMATIC PC Based Automation, SIMATIC PCS 7, SIMATIC PG/PC, SIMATIC S7, SIMATIC Software, SIMATIC TDC
		6ES7998-8XC01-8YE0 6ES7998-8XC01-8YE2

¹⁾ For up-to-date information and download availability, see: <http://www.siemens.com/tia-online-software-delivery>

SIMATIC S7-1500 Advanced Controllers

Central processing units

Fail-safe CPUs

Overview CPU 1511F-1 PN



- Entry-level CPU in the S7-1500F Controller product range
- Suitable for standard and fail-safe applications with medium requirements for program scope and processing speed
- Used as central controller in production lines with central and distributed I/O
- Supports PROFIsafe in centralized and distributed configuration
- PROFINET IO IRT interface with 2-port switch
- PROFINET IO Controller for operating distributed I/O on PROFINET
- PROFINET I-device for connecting the CPU as an intelligent PROFINET device under a SIMATIC or third-party PROFINET IO controller
- Isochronous mode

Note:

SIMATIC Memory Card required for operation of the CPU

Overview CPU 1513F-1 PN



- The CPU for standard and fail-safe applications with medium/high requirements for program/data storage in the S7-1500 Controller product range
- High processing speed for binary and floating-point arithmetic
- Used as central controller in production lines with central and distributed I/O
- Supports PROFIsafe in centralized and distributed configuration
- PROFINET IO IRT interface with 2-port switch
- PROFINET IO Controller for operating distributed I/O on PROFINET
- PROFINET I-device for connecting the CPU as an intelligent PROFINET device under a SIMATIC or third-party PROFINET IO controller
- Isochronous mode

Note:

SIMATIC Memory Card required for operation of the CPU

Overview CPU 1515F-2 PN



- The CPU for applications with medium to high requirements for program/data storage in the S7-1500 Controller product range
- Can be used for fail-safe functions up to SIL 3 according to IEC 61508 and up to PLe according to ISO 13849.
- Medium to high processing speed for binary and floating-point arithmetic
- Used as central controller in production lines with central and distributed I/O
- Supports PROFIsafe in centralized and distributed configurations
- PROFINET IO IRT interface with 2-port switch
- Additional PROFINET interface with separate IP address
- PROFINET IO controller for operating distributed I/O on PROFINET
- PROFINET I-device for connecting the CPU as an intelligent PROFINET device under a SIMATIC or third-party PROFINET IO controller
- Isochronous mode
- Integrated motion control functionalities for controlling speed-controlled and positioning axes, support for external encoders
- Integrated web server with the option of creating user-defined web pages

Note:

SIMATIC Memory Card required for operation of the CPU

Overview CPU 1516F-3 PN/DP



- The CPU with a large program and data memory in the S7-1500 Controller product range for fail-safe applications with high requirements regarding program scope and networking.
- Can be used for fail-safe functions up to SIL 3 according to IEC 61508 and up to PLe according to ISO 13849.
- High processing speed for binary and floating-point arithmetic
- Used as central controller in production lines with central and distributed I/O.
- Supports PROFIsafe in centralized and distributed configuration.
- PROFINET IO IRT interface with 2-port switch.
- Additional PROFINET interface with separate IP address.
- PROFINET IO controller for operating distributed I/O on PROFINET.
- PROFINET I-device for connecting the CPU as an intelligent PROFINET device under a SIMATIC or third-party PROFINET IO controller.
- PROFIBUS DP master interface.
- Isochronous mode on PROFIBUS and PROFINET.
- Integrated motion control functionalities for controlling speed-controlled and positioning axes, support for external encoders.
- Integrated web server with the option of creating user-defined web pages.

Note:

SIMATIC Memory Card required for operation of the CPU

SIMATIC S7-1500 Advanced Controllers

Central processing units

Fail-safe CPUs

Overview CPU 1517F-3 PN/DP



- The CPU with a very large program and data memory in the S7-1500 Controller product range for fail-safe applications with high requirements regarding program scope and networking.
- Can be used for fail-safe functions up to SIL 3 according to IEC 61508 and up to PLe according to ISO 13849.
- High processing speed for binary and floating-point arithmetic
- For cross-industry automation tasks in series machine, special machine and plant construction
- Used as central controller in production lines with central and distributed I/O
- Supports PROFIsafe in centralized and distributed configurations
- PROFINET IO IRT interface with 2-port switch
- Additional PROFINET interface with separate IP address
- PROFINET IO controller for operating distributed I/O on PROFINET.
- PROFINET I-device for connecting the CPU as an intelligent PROFINET device under a SIMATIC or third-party PROFINET IO controller.
- PROFIBUS DP master interface
- Isochronous mode on PROFIBUS and PROFINET
- Integrated motion control functionalities for controlling speed-controlled and positioning axes, support for external encoders, positionally precise gearing between axes
- Integrated web server with the option of creating user-defined web pages

Note:

SIMATIC Memory Card required for operation of the CPU

Overview CPU 1518F-4 PN/DP



- The CPU with a very large program and data memory in the S7-1500 Controller product range for fail-safe applications with highest requirements regarding program scope and networking.
- Can be used for fail-safe functions up to SIL 3 according to IEC 61508 and up to PLe according to ISO 13849.
- Extremely high processing speed for binary and floating-point arithmetic.
- For cross-industry automation tasks in series machine, special machine and plant construction
- Used as central controller in production lines with central and distributed I/O.
- Supports PROFIsafe in centralized and distributed configuration.
- PROFINET IO IRT interface with 2-port switch.
- Two additional PROFINET interfaces with separate IP addresses.
- PROFINET IO controller for operating distributed I/O on PROFINET.
- PROFINET I-device for connecting the CPU as an intelligent PROFINET device under a SIMATIC or third-party PROFINET IO controller.
- PROFIBUS DP master interface.
- Isochronous mode on PROFIBUS and PROFINET.
- Integrated motion control functionalities for controlling speed-controlled and positioning axes, support for external encoders
- Integrated web server with the option of creating user-defined web pages.

Note:

SIMATIC Memory Card required for operation of the CPU.

Overview CPU 1518F-4 PN/DP ODK

- The CPU with a very large program and data memory in the S7-1500 Controller product range for demanding applications with extremely high requirements regarding program scope, performance and networking
- Can be used for fail-safe functions up to SIL 3 according to IEC 61508 and up to PLe according to ISO 13849
- Extremely high processing speed for binary and floating-point arithmetic
- For cross-industry automation tasks in series machines, special machines and plant construction
- C/C++ Runtime for the execution of functions and algorithms implemented in C/C++ in the CPU 1518-4 PN/DP ODK.
- Used as central controller in production lines with central and distributed I/O
- Supports PROFIsafe in centralized and distributed configurations
- PROFINET IO IRT interface with 2-port switch
- PROFINET IO controller for operating distributed I/O on PROFINET
- PROFINET I-device for connecting the CPU as an intelligent PROFINET device under a SIMATIC or third-party PROFINET IO controller
- Two additional PROFINET interfaces with separate IP addresses for network separation. The PROFINET interface X2 can be used for connecting additional PROFINET IO RT devices or for fast communication as an I-device. The PROFINET interface X3 gives you the capability of transferring data at a speed of 1 Gbps.
- PROFIBUS DP master interface
- OPC UA Server (Data Access) as runtime option for the easy connection of SIMATIC S7-1500 to third-party devices/ systems
- Isochronous mode on PROFIBUS and PROFINET
- Integrated motion control functionalities for controlling speed-controlled and positioning axes, support for external encoders, precise position gearing between axes, cams/cam tracks and probes
- Integrated web server for diagnostics with the option of creating user-defined web pages

Note

SIMATIC Memory Card required for operation of the CPU.

Technical specifications

Article number	6ES7511-1FK01-0AB0 CPU 1511F-1PN, 225KB PROG, 1MB DATA	6ES7513-1FL01-0AB0 CPU 1513F-1 PN, 450KB PROG, 1.5MB DATA	6ES7515-2FM01-0AB0 CPU 1515F-2 PN, 750KB PROG.,3MB DATA	6ES7516-3FN01-0AB0 CPU 1516F-3 PN/DP, 1.5MB PROG., 5MB DATA
General information				
Product type designation	CPU 1511F-1 PN	CPU 1513F-1 PN	CPU 1515F-2 PN	CPU 1516F-3 PN/DP
Engineering with				
• STEP 7 TIA Portal configurable/ integrated as of version	V14	V14	V14	V14
Display				
Screen diagonal [cm]	3.45 cm	3.45 cm	6.1 cm	6.1 cm
Supply voltage				
Type of supply voltage	24 V DC	24 V DC	24 V DC	24 V DC
Power loss				
Power loss, typ.	5.7 W	5.7 W	6.3 W	7 W
Memory				
Work memory				
• integrated (for program)	225 kbyte	450 kbyte	750 kbyte	1.5 Mbyte
• integrated (for data)	1 Mbyte	1.5 Mbyte	3 Mbyte	5 Mbyte
Load memory				
• Plug-in (SIMATIC Memory Card), max.	32 Gbyte	32 Gbyte	32 Gbyte	32 Gbyte
CPU processing times				
for bit operations, typ.	60 ns	40 ns	30 ns	10 ns
for word operations, typ.	72 ns	48 ns	36 ns	12 ns
for fixed point arithmetic, typ.	96 ns	64 ns	48 ns	16 ns
for floating point arithmetic, typ.	384 ns	256 ns	192 ns	64 ns
Counters, timers and their retentivity				
S7 counter				
• Number	2 048	2 048	2 048	2 048
IEC counter				
• Number	Any (only limited by the main memory)	Any (only limited by the main memory)	Any (only limited by the main memory)	Any (only limited by the main memory)
S7 times				
• Number	2 048	2 048	2 048	2 048
IEC timer				
• Number	Any (only limited by the main memory)	Any (only limited by the main memory)	Any (only limited by the main memory)	Any (only limited by the main memory)

SIMATIC S7-1500 Advanced Controllers

Central processing units

Fail-safe CPUs

Technical specifications (continued)

Article number	6ES7511-1FK01-0AB0 CPU 1511F-1PN, 225KB PROG, 1MB DATA	6ES7513-1FL01-0AB0 CPU 1513F-1 PN, 450KB PROG, 1.5MB DATA	6ES7515-2FM01-0AB0 CPU 1515F-2 PN, 750KB PROG.,3MB DATA	6ES7516-3FN01-0AB0 CPU 1516F-3 PN/DP, 1.5MB PROG., 5MB DATA
Data areas and their retentivity				
Flag				
• Number, max.	16 kbyte	16 kbyte	16 kbyte	16 kbyte
Address area				
I/O address area				
• Inputs	32 kbyte; All inputs are in the process image	32 kbyte; All inputs are in the process image	32 kbyte; All inputs are in the process image	32 kbyte; All inputs are in the process image
• Outputs	32 kbyte; All outputs are in the process image	32 kbyte; All outputs are in the process image	32 kbyte; All outputs are in the process image	32 kbyte; All outputs are in the process image
Time of day				
Clock				
• Type	Hardware clock	Hardware clock	Hardware clock	Hardware clock
1. Interface				
Interface types				
• Number of ports	2	2	2	2
• integrated switch	Yes	Yes	Yes	Yes
• RJ 45 (Ethernet)	Yes; X1	Yes; X1	Yes; X1	Yes; X1
Functionality				
• PROFINET IO Controller	Yes	Yes	Yes	Yes
• PROFINET IO Device	Yes	Yes	Yes	Yes
• SIMATIC communication	Yes	Yes	Yes	Yes
• Open IE communication	Yes	Yes	Yes	Yes
• Web server	Yes	Yes	Yes	Yes
• Media redundancy	Yes	Yes	Yes	Yes
PROFINET IO Controller				
Services				
- PG/OP communication	Yes	Yes	Yes	Yes
- S7 routing	Yes	Yes	Yes	Yes
- Isochronous mode	Yes	Yes	Yes	Yes
- Open IE communication	Yes	Yes	Yes	Yes
- IRT	Yes	Yes	Yes	Yes
- MRP	Yes; As MRP redundancy manager and/or MRP client; max. number of devices in the ring: 50	Yes; As MRP redundancy manager and/or MRP client; max. number of devices in the ring: 50	Yes; As MRP redundancy manager and/or MRP client; max. number of devices in the ring: 50	Yes; As MRP redundancy manager and/or MRP client; max. number of devices in the ring: 50
- MRPD	Yes; Requirement: IRT	Yes; Requirement: IRT	Yes; Requirement: IRT	Yes; Requirement: IRT
- PROFIenergy	Yes	Yes	Yes	Yes
- Prioritized startup	Yes; Max. 32 PROFINET devices	Yes; Max. 32 PROFINET devices	Yes; Max. 32 PROFINET devices	Yes; Max. 32 PROFINET devices
- Number of connectable IO Devices, max.	128; In total, up to 256 distributed I/O devices can be connected via AS-i, PROFIBUS or PROFINET	128	256; In total, up to 1 000 distributed I/O devices can be connected via AS-i, PROFIBUS or PROFINET	256; In total, up to 1 000 distributed I/O devices can be connected via AS-i, PROFIBUS or PROFINET
- Of which IO devices with IRT, max.	64	64	64	64
- Number of connectable IO Devices for RT, max.	128	128	256	256
- of which in line, max.	128	128	256	256
- Number of IO Devices that can be simultaneously activated/deactivated, max.	8; in total across all interfaces	8; in total across all interfaces	8; in total across all interfaces	8; in total across all interfaces
- Number of IO Devices per tool, max.	8	8	8	8
- Updating times	The minimum value of the update time also depends on communication share set for PROFINET IO, on the number of IO devices, and on the quantity of configured user data	The minimum value of the update time also depends on communication share set for PROFINET IO, on the number of IO devices, and on the quantity of configured user data	The minimum value of the update time also depends on communication share set for PROFINET IO, on the number of IO devices, and on the quantity of configured user data	The minimum value of the update time also depends on communication share set for PROFINET IO, on the number of IO devices, and on the quantity of configured user data

Technical specifications (continued)

Article number	6ES7511-1FK01-0AB0 CPU 1511F-1PN, 225KB PROG, 1MB DATA	6ES7513-1FL01-0AB0 CPU 1513F-1 PN, 450KB PROG, 1.5MB DATA	6ES7515-2FM01-0AB0 CPU 1515F-2 PN, 750KB PROG.,3MB DATA	6ES7516-3FN01-0AB0 CPU 1516F-3 PN/DP, 1.5MB PROG., 5MB DATA
Update time for IRT				
- for send cycle of 250 µs	250 µs to 4 ms; Note: In the case of IRT with isochronous mode, the minimum update time of 625 µs of the isochronous OB is decisive	250 µs to 4 ms; Note: In the case of IRT with isochronous mode, the minimum update time of 500 µs of the isochronous OB is decisive	250 µs to 4 ms; Note: In the case of IRT with isochronous mode, the minimum update time of 500 µs of the isochronous OB is decisive	250 µs to 4 ms; Note: In the case of IRT with isochronous mode, the minimum update time of 500 µs of the isochronous OB is decisive
- for send cycle of 500 µs	500 µs to 8 ms; Note: In the case of IRT with isochronous mode, the minimum update time of 625 µs of the isochronous OB is decisive	500 µs to 8 ms	500 µs to 8 ms	500 µs to 8 ms
- for send cycle of 1 ms	1 ms to 16 ms	1 ms to 16 ms	1 ms to 16 ms	1 ms to 16 ms
- for send cycle of 2 ms	2 ms to 32 ms	2 ms to 32 ms	2 ms to 32 ms	2 ms to 32 ms
- for send cycle of 4 ms	4 ms to 64 ms	4 ms to 64 ms	4 ms to 64 ms	4 ms to 64 ms
- With IRT and parameterization of "odd" send cycles	Update time = set "odd" send clock (any multiple of 125 µs: 375 µs, 625 µs ... 3 875 µs)	Update time = set "odd" send clock (any multiple of 125 µs: 375 µs, 625 µs ... 3 875 µs)	Update time = set "odd" send clock (any multiple of 125 µs: 375 µs, 625 µs ... 3 875 µs)	Update time = set "odd" send clock (any multiple of 125 µs: 375 µs, 625 µs ... 3 875 µs)
Update time for RT				
- for send cycle of 250 µs	250 µs to 128 ms	250 µs to 128 ms	250 µs to 128 ms	250 µs to 128 ms
- for send cycle of 500 µs	500 µs to 256 ms	500 µs to 256 ms	500 µs to 256 ms	500 µs to 256 ms
- for send cycle of 1 ms	1 ms to 512 ms	1 ms to 512 ms	1 ms to 512 ms	1 ms to 512 ms
- for send cycle of 2 ms	2 ms to 512 ms	2 ms to 512 ms	2 ms to 512 ms	2 ms to 512 ms
- for send cycle of 4 ms	4 ms to 512 ms	4 ms to 512 ms	4 ms to 512 ms	4 ms to 512 ms
PROFINET IO Device				
Services				
- PG/OP communication	Yes	Yes	Yes	Yes
- S7 routing	Yes	Yes	Yes	Yes
- Isochronous mode	No	No	No	No
- Open IE communication	Yes	Yes	Yes	Yes
- IRT	Yes	Yes	Yes	Yes
- MRP	Yes	Yes	Yes	Yes
- MRPD	Yes; Requirement: IRT	Yes; Requirement: IRT	Yes; Requirement: IRT	Yes; Requirement: IRT
- PROFINergy	Yes	Yes	Yes	Yes
- Shared device	Yes	Yes	Yes	Yes
- Number of IO Controllers with shared device, max.	4	4	4	4
2. Interface				
Interface types				
• Number of ports			1	1
• integrated switch			No	No
• RJ 45 (Ethernet)			Yes; X2	Yes; X2
Functionality				
• PROFINET IO Controller			Yes	Yes
• PROFINET IO Device			Yes	Yes
• SIMATIC communication			Yes	Yes
• Open IE communication			Yes	Yes
• Web server			Yes	Yes
• Media redundancy			No	No

SIMATIC S7-1500 Advanced Controllers

Central processing units

Fail-safe CPUs

Technical specifications (continued)

Article number	6ES7511-1FK01-0AB0 CPU 1511F-1PN, 225KB PROG, 1MB DATA	6ES7513-1FL01-0AB0 CPU 1513F-1 PN, 450KB PROG, 1.5MB DATA	6ES7515-2FM01-0AB0 CPU 1515F-2 PN, 750KB PROG.,3MB DATA	6ES7516-3FN01-0AB0 CPU 1516F-3 PN/DP, 1.5MB PROG., 5MB DATA
PROFINET IO Controller				
Services				
- PG/OP communication			Yes	Yes
- S7 routing			Yes	Yes
- Isochronous mode			No	No
- Open IE communication			Yes	Yes
- IRT			No	No
- MRP			No	No
- PROFlenergy			Yes	Yes
- Prioritized startup			No	No
- Number of connectable IO Devices, max.			32; In total, up to 1 000 distributed I/O devices can be connected via AS-i, PROFIBUS or PROFINET	32; In total, up to 1 000 distributed I/O devices can be connected via AS-i, PROFIBUS or PROFINET
- Number of connectable IO Devices for RT, max.			32	32
- of which in line, max.			32	32
- Number of IO Devices that can be simultaneously activated/deactivated, max.			8; in total across all interfaces	8; in total across all interfaces
- Number of IO Devices per tool, max.			8	8
- Updating times			The minimum value of the update time also depends on communication share set for PROFINET IO, on the number of IO devices, and on the quantity of configured user data	The minimum value of the update time also depends on communication share set for PROFINET IO, on the number of IO devices, and on the quantity of configured user data
Update time for RT				
- for send cycle of 1 ms			1 ms to 512 ms	1 ms to 512 ms
PROFINET IO Device				
Services				
- PG/OP communication			Yes	Yes
- S7 routing			Yes	Yes
- Isochronous mode			No	No
- Open IE communication			Yes	Yes
- IRT			No	No
- MRP			No	No
- MRPD			No	No
- PROFlenergy			Yes	Yes
- Prioritized startup			No	No
- Shared device			Yes	Yes
- Number of IO Controllers with shared device, max.			4	4
3. Interface				
Interface types				
• Number of ports				1
• RS 485				Yes; X3
Functionality				
• PROFIBUS DP master				Yes
• PROFIBUS DP slave				No
• SIMATIC communication				Yes
Protocols				
Supports protocol for PROFINET IO	Yes	Yes	Yes	Yes
PROFIsafe	Yes	Yes	Yes	Yes
PROFIBUS	No	No	No	Yes
Number of connections				
• Number of connections, max.	96; via integrated interfaces of the CPU and connected CPs / CMs	128; via integrated interfaces of the CPU and connected CPs / CMs	192; via integrated interfaces of the CPU and connected CPs / CMs	256; via integrated interfaces of the CPU and connected CPs / CMs

Technical specifications (continued)

Article number	6ES7511-1FK01-0AB0 CPU 1511F-1PN, 225KB PROG, 1MB DATA	6ES7513-1FL01-0AB0 CPU 1513F-1 PN, 450KB PROG, 1.5MB DATA	6ES7515-2FM01-0AB0 CPU 1515F-2 PN, 750KB PROG.,3MB DATA	6ES7516-3FN01-0AB0 CPU 1516F-3 PN/DP, 1.5MB PROG., 5MB DATA
PROFINET IO Controller				
Services				
- Number of connectable IO Devices, max.	128; In total, up to 256 distributed I/O devices can be connected via AS-i, PROFIBUS or PROFINET	128; In total, up to 512 distributed I/O devices can be connected via AS-i, PROFIBUS or PROFINET		
- Of which IO devices with IRT, max.	64	64		
- Number of connectable IO Devices for RT, max.	128	128		
Isochronous mode				
Isochronous operation (application synchronized up to terminal)	Yes; With minimum OB 6x cycle of 625 µs	Yes; With minimum OB 6x cycle of 500 µs	Yes; With minimum OB 6x cycle of 500 µs	Yes; With minimum OB 6x cycle of 375 µs
Supported technology objects				
Motion Control	Yes; Note: The number of axes affects the cycle time of the PLC program; selection guide via the TIA Selection Tool or SIZER	Yes	Yes; Note: The number of axes affects the cycle time of the PLC program; selection guide via the TIA Selection Tool or SIZER	Yes; Note: The number of axes affects the cycle time of the PLC program; selection guide via the TIA Selection Tool or SIZER
• Number of available Motion Control resources for technology objects (except cam disks)	800		2 400	2 400
• Required Motion Control resources				
- per speed-controlled axis	40		40	40
- per positioning axis	80		80	80
- per synchronous axis	160		160	160
- per external encoder	80		80	80
- per output cam	20		20	20
- per cam track	160		160	160
- per probe	40		40	40
• Speed-controlled axis				
- Number of speed-controlled axes, max.		6; Requirement: There must be no other motion technology objects created		
• Positioning axis				
- Number of positioning axes, max.		6; Requirement: There must be no other motion technology objects created		
• Synchronized axes (relative gear synchronization)				
- Number of axes, max.		3; Requirement: There must be no other motion technology objects created		
• External encoders				
- Number of external encoders, max.		6; Requirement: There must be no other motion technology objects created		
Controller				
• PID_Compact	Yes; Universal PID controller with integrated optimization	Yes; Universal PID controller with integrated optimization	Yes; Universal PID controller with integrated optimization	Yes; Universal PID controller with integrated optimization
• PID_3Step	Yes; PID controller with integrated optimization for valves	Yes; PID controller with integrated optimization for valves	Yes; PID controller with integrated optimization for valves	Yes; PID controller with integrated optimization for valves
• PID-Temp	Yes; PID controller with integrated optimization for temperature	Yes; PID controller with integrated optimization for temperature	Yes; PID controller with integrated optimization for temperature	Yes; PID controller with integrated optimization for temperature
Counting and measuring				
• High-speed counter	Yes	Yes	Yes	Yes
Highest safety class achievable in safety mode				
Probability of failure (for service life of 20 years and repair time of 100 hours)				
- Low demand mode: PFDavg in accordance with SIL3	< 2.00E-05	< 2.00E-05	< 2.00E-05	< 2.00E-05
- High demand/continuous mode: PFH in accordance with SIL3	< 1.00E-09	< 1.00E-09	< 1.00E-09	< 1.00E-09 1/h

SIMATIC S7-1500 Advanced Controllers

Central processing units

Fail-safe CPUs

Technical specifications (continued)

Article number	6ES7511-1FK01-0AB0 CPU 1511F-1PN, 225KB PROG., 1MB DATA	6ES7513-1FL01-0AB0 CPU 1513F-1 PN, 450KB PROG., 1.5MB DATA	6ES7515-2FM01-0AB0 CPU 1515F-2 PN, 750KB PROG., 3MB DATA	6ES7516-3FN01-0AB0 CPU 1516F-3 PN/DP, 1.5MB PROG., 5MB DATA
Ambient conditions				
Ambient temperature during operation				
• horizontal installation, min.	0 °C	0 °C	0 °C	0 °C
• horizontal installation, max.	60 °C; Display: 50 °C, at an operating temperature of typically 50 °C, the display is switched off	60 °C; Display: 50 °C, at an operating temperature of typically 50 °C, the display is switched off	60 °C; Display: 50 °C, at an operating temperature of typically 50 °C, the display is switched off	60 °C; Display: 50 °C, at an operating temperature of typically 50 °C, the display is switched off
• vertical installation, min.	0 °C	0 °C	0 °C	0 °C
• vertical installation, max.	40 °C; Display: 40 °C, at an operating temperature of typically 40 °C, the display is switched off	40 °C; Display: 40 °C, at an operating temperature of typically 40 °C, the display is switched off	40 °C; Display: 40 °C, at an operating temperature of typically 40 °C, the display is switched off	40 °C; Display: 40 °C, at an operating temperature of typically 40 °C, the display is switched off
Configuration				
Programming				
Programming language				
- LAD	Yes; incl. failsafe	Yes; incl. failsafe	Yes; incl. failsafe	Yes; incl. failsafe
- FBD	Yes; incl. failsafe	Yes; incl. failsafe	Yes; incl. failsafe	Yes; incl. failsafe
- STL	Yes	Yes	Yes	Yes
- SCL	Yes	Yes	Yes	Yes
- GRAPH	Yes	Yes	Yes	Yes
Know-how protection				
• User program protection/password protection	Yes	Yes	Yes	Yes
• Copy protection	Yes	Yes	Yes	Yes
• Block protection	Yes	Yes	Yes	Yes
Access protection				
• Password for display	Yes	Yes	Yes	Yes
• Protection level: Write protection	Yes	Yes; Specific write protection both for Standard and for Failsafe	Yes	Yes
• Protection level: Read/write protection	Yes	Yes	Yes	Yes
• Protection level: Complete protection	Yes	Yes	Yes	Yes
Dimensions				
Width	35 mm	35 mm	70 mm	70 mm
Height	147 mm	147 mm	147 mm	147 mm
Depth	129 mm	129 mm	129 mm	129 mm
Weights				
Weight, approx.	430 g	430 g	830 g	845 g

Article number	6ES7517-3FP00-0AB0 CPU 1517F-3 PN/DP, 3MB PROG., 8MB DATA	6ES7518-4FP00-0AB0 CPU 1518F-4 PN/DP, 6 MB PROG., 20MB DATA	6ES7518-4FP00-3AB0 CPU 1518F-4 PN/DP ODK, 6 MB PROG., 20MB DATA
General information			
Product type designation	CPU 1517F-3PN/DP	CPU 1518F-4PN/DP	CPU 1518F-4 PN/DP ODK
Engineering with			
• STEP 7 TIA Portal configurable/integrated as of version	V14	V14	V14
Display			
Screen diagonal [cm]	6.1 cm	6.1 cm	6.1 cm
Supply voltage			
Type of supply voltage	24 V DC	24 V DC	24 V DC
Power loss			
Power loss, typ.	24 W	24 W	24 W

Technical specifications (continued)

Article number	6ES7517-3FP00-0AB0 CPU 1517F-3 PN/DP, 3MB PROG., 8MB DATA	6ES7518-4FP00-0AB0 CPU 1518F-4 PN/DP, 6 MB PROG, 20MB DATA	6ES7518-4FP00-3AB0 CPU 1518F-4 PN/DP ODK, 6 MB PROG, 20MB DATA
Memory			
Work memory			
• integrated (for program)	3 Mbyte	6 Mbyte	6 Mbyte
• integrated (for data)	8 Mbyte	20 Mbyte	20 Mbyte
• Integrated (for ODK application)			20 Mbyte
Load memory			
• Plug-in (SIMATIC Memory Card), max.	32 Gbyte	32 Gbyte	32 Gbyte
CPU processing times			
for bit operations, typ.	2 ns	1 ns	1 ns
for word operations, typ.	3 ns	2 ns	2 ns
for fixed point arithmetic, typ.	3 ns	2 ns	2 ns
for floating point arithmetic, typ.	12 ns	6 ns	6 ns
Counters, timers and their retentivity			
S7 counter			
• Number	2 048	2 048	2 048
IEC counter			
• Number	Any (only limited by the main memory)	Any (only limited by the main memory)	Any (only limited by the main memory)
S7 times			
• Number	2 048	2 048	2 048
IEC timer			
• Number	Any (only limited by the main memory)	Any (only limited by the main memory)	Any (only limited by the main memory)
Data areas and their retentivity			
Flag			
• Number, max.	16 kbyte	16 kbyte	16 kbyte
Address area			
I/O address area			
• Inputs	32 kbyte; All inputs are in the process image	32 kbyte; All inputs are in the process image	32 kbyte; All inputs are in the process image
• Outputs	32 kbyte; All outputs are in the process image	32 kbyte; All outputs are in the process image	32 kbyte; All outputs are in the process image
Time of day			
Clock			
• Type	Hardware clock	Hardware clock	Hardware clock
1. Interface			
Interface types			
• Number of ports	2	2	2
• integrated switch	Yes	Yes	Yes
• RJ 45 (Ethernet)	Yes; X1	Yes; X1	Yes; X1
Functionality			
• PROFINET IO Controller	Yes	Yes	Yes
• PROFINET IO Device	Yes	Yes	Yes
• SIMATIC communication	Yes	Yes	Yes
• Open IE communication	Yes	Yes	Yes
• Web server	Yes	Yes	Yes
• Media redundancy	Yes	Yes	Yes

SIMATIC S7-1500 Advanced Controllers

Central processing units

Fail-safe CPUs

Technical specifications (continued)

Article number	6ES7517-3FP00-0AB0 CPU 1517F-3 PN/DP, 3MB PROG., 8MB DATA	6ES7518-4FP00-0AB0 CPU 1518F-4 PN/DP, 6 MB PROG, 20MB DATA	6ES7518-4FP00-3AB0 CPU 1518F-4 PN/DP ODK, 6 MB PROG, 20MB DATA
PROFINET IO Controller			
Services			
- PG/OP communication	Yes	Yes	Yes
- S7 routing	Yes	Yes	Yes
- Isochronous mode	Yes	Yes	Yes
- Open IE communication	Yes	Yes	Yes
- IRT	Yes	Yes	Yes
- MRP	Yes; As MRP redundancy manager and/or MRP client; max. number of devices in the ring: 50	Yes; As MRP redundancy manager and/or MRP client; max. number of devices in the ring: 50	Yes; As MRP redundancy manager and/or MRP client; max. number of devices in the ring: 50
- MRPD	Yes; Requirement: IRT	Yes; Requirement: IRT	Yes; Requirement: IRT
- PROFInergy	Yes	Yes	Yes
- Prioritized startup	Yes; Max. 32 PROFINET devices	Yes; Max. 32 PROFINET devices	Yes; Max. 32 PROFINET devices
- Number of connectable IO Devices, max.	512; In total, up to 1 000 distributed I/O devices can be connected via AS-i, PROFIBUS or PROFINET	512; In total, up to 1 000 distributed I/O devices can be connected via AS-i, PROFIBUS or PROFINET	512; In total, up to 1 000 distributed I/O devices can be connected via AS-i, PROFIBUS or PROFINET
- Of which IO devices with IRT, max.	64	64	64
- Number of connectable IO Devices for RT, max.	512	512	512
- of which in line, max.	512	512	512
- Number of IO Devices that can be simultaneously activated/deactivated, max.	8; in total across all interfaces	8; in total across all interfaces	8; in total across all interfaces
- Number of IO Devices per tool, max.	8	8	8
- Updating times	The minimum value of the update time also depends on communication share set for PROFINET IO, on the number of IO devices, and on the quantity of configured user data	The minimum value of the update time also depends on communication share set for PROFINET IO, on the number of IO devices, and on the quantity of configured user data	The minimum value of the update time also depends on communication share set for PROFINET IO, on the number of IO devices, and on the quantity of configured user data
Update time for IRT			
- for send cycle of 125 µs		125 µs	125 µs
- for send cycle of 187.5 µs		187.5 µs	187.5 µs
- for send cycle of 250 µs	250 µs to 4 ms; Note: In the case of IRT with isochronous mode, the minimum update time of 500 µs of the isochronous OB is decisive	250 µs to 4 ms	250 µs to 4 ms
- for send cycle of 500 µs	500 µs to 8 ms	500 µs to 8 ms	500 µs to 8 ms
- for send cycle of 1 ms	1 ms to 16 ms	1 ms to 16 ms	1 ms to 16 ms
- for send cycle of 2 ms	2 ms to 32 ms	2 ms to 32 ms	2 ms to 32 ms
- for send cycle of 4 ms	4 ms to 64 ms	4 ms to 64 ms	4 ms to 64 ms
- With IRT and parameterization of "odd" send cycles	Update time = set "odd" send clock (any multiple of 125 µs: 375 µs, 625 µs ... 3 875 µs)	Update time = set "odd" send clock (any multiple of 125 µs: 375 µs, 625 µs ... 3 875 µs)	Update time = set "odd" send clock (any multiple of 125 µs: 375 µs, 625 µs ... 3 875 µs)
Update time for RT			
- for send cycle of 250 µs	250 µs to 128 ms	250 µs to 128 ms	250 µs to 128 ms
- for send cycle of 500 µs	500 µs to 256 ms	500 µs to 256 ms	500 µs to 256 ms
- for send cycle of 1 ms	1 ms to 512 ms	1 ms to 512 ms	1 ms to 512 ms
- for send cycle of 2 ms	2 ms to 512 ms	2 ms to 512 ms	2 ms to 512 ms
- for send cycle of 4 ms	4 ms to 512 ms	4 ms to 512 ms	4 ms to 512 ms
PROFINET IO Device			
Services			
- PG/OP communication	Yes	Yes	Yes
- S7 routing	Yes	Yes	Yes
- Isochronous mode	No	No	No
- Open IE communication	Yes	Yes	Yes
- IRT	Yes	Yes	Yes
- MRP	Yes	Yes	Yes
- MRPD	Yes; Requirement: IRT	Yes; Requirement: IRT	Yes; Requirement: IRT
- PROFInergy	Yes	Yes	Yes
- Shared device	Yes	Yes	Yes
- Number of IO Controllers with shared device, max.	4	4	4

Technical specifications (continued)

Article number	6ES7517-3FP00-0AB0 CPU 1517F-3 PN/DP, 3MB PROG., 8MB DATA	6ES7518-4FP00-0AB0 CPU 1518F-4 PN/DP, 6 MB PROG, 20MB DATA	6ES7518-4FP00-3AB0 CPU 1518F-4 PN/DP ODK, 6 MB PROG, 20MB DATA
2. Interface			
Interface types			
• Number of ports	1	1	1
• integrated switch	No	No	No
• RJ 45 (Ethernet)	Yes; X2	Yes; X2	Yes; X2
Functionality			
• PROFINET IO Controller	Yes	Yes	Yes
• PROFINET IO Device	Yes	Yes	Yes
• SIMATIC communication	Yes	Yes	Yes
• Open IE communication	Yes	Yes	Yes
• Web server	Yes	Yes	Yes
• Media redundancy	No	No	No
PROFINET IO Controller			
Services			
- PG/OP communication	Yes	Yes	Yes
- S7 routing	Yes	Yes	Yes
- Isochronous mode	No	No	No
- Open IE communication	Yes	Yes	Yes
- IRT	No	No	No
- MRP	No	No	No
- PROFlenergy	Yes	Yes	Yes
- Prioritized startup	No	No	No
- Number of connectable I/O Devices, max.	128; In total, up to 1 000 distributed I/O devices can be connected via AS-i, PROFIBUS or PROFINET	128; In total, up to 1 000 distributed I/O devices can be connected via AS-i, PROFIBUS or PROFINET	128; In total, up to 1 000 distributed I/O devices can be connected via AS-i, PROFIBUS or PROFINET
- Number of connectable I/O Devices for RT, max.	128	128	32
- of which in line, max.	128	128	128
- Number of IO Devices that can be simultaneously activated/deactivated, max.	8; in total across all interfaces	8; in total across all interfaces	8; in total across all interfaces
- Number of IO Devices per tool, max.	8		
- Updating times	The minimum value of the update time also depends on communication share set for PROFINET IO, on the number of IO devices, and on the quantity of configured user data	The minimum value of the update time also depends on communication share set for PROFINET IO, on the number of IO devices, and on the quantity of configured user data	The minimum value of the update time also depends on communication share set for PROFINET IO, on the number of IO devices, and on the quantity of configured user data
Update time for RT			
- for send cycle of 1 ms	1 ms to 512 ms	1 ms to 512 ms	1 ms to 512 ms
PROFINET IO Device			
Services			
- PG/OP communication	Yes	Yes	Yes
- S7 routing	Yes	Yes	Yes
- Isochronous mode	No	No	No
- Open IE communication	Yes	Yes	Yes
- IRT	No	No	No
- MRP	No	No	No
- MRPD	No	No	No
- PROFlenergy	Yes	Yes	Yes
- Prioritized startup	No	No	No
- Shared device	Yes	Yes	Yes
- Number of IO Controllers with shared device, max.	4	4	4
3. Interface			
Interface types			
• Number of ports	1	1	1
• integrated switch		No	No
• RJ 45 (Ethernet)		Yes; X3	Yes; X3
• RS 485	Yes; X3		

SIMATIC S7-1500 Advanced Controllers

Central processing units

Fail-safe CPUs

Technical specifications (continued)

Article number	6ES7517-3FP00-0AB0 CPU 1517F-3 PN/DP, 3MB PROG., 8MB DATA	6ES7518-4FP00-0AB0 CPU 1518F-4 PN/DP, 6 MB PROG, 20MB DATA	6ES7518-4FP00-3AB0 CPU 1518F-4 PN/DP ODK, 6 MB PROG, 20MB DATA
Functionality			
• PROFINET IO Controller		No	No
• PROFINET IO Device		No	No
• PROFIBUS DP master	Yes		
• PROFIBUS DP slave	No		
• SIMATIC communication	Yes	Yes	Yes
• Open IE communication		Yes	Yes
• Web server		Yes	Yes
4. Interface			
Interface types			
• Number of ports		1	1
• RS 485		Yes; X4	Yes; X4
Functionality			
• PROFIBUS DP master		Yes	Yes
• PROFIBUS DP slave		No	No
• SIMATIC communication		Yes	Yes
Protocols			
Supports protocol for PROFINET IO	Yes	Yes	Yes
PROFIsafe	Yes	Yes	Yes
PROFIBUS	Yes	Yes	Yes
Number of connections			
• Number of connections, max.	320; via integrated interfaces of the CPU and connected CPs / CMs	384; via integrated interfaces of the CPU and connected CPs / CMs	384; via integrated interfaces of the CPU and connected CPs / CMs
Isochronous mode			
Isochronous operation (application synchronized up to terminal)	Yes; With minimum OB 6x cycle of 250 µs	Yes; With minimum OB 6x cycle of 125 µs	Yes; With minimum OB 6x cycle of 125 µs
Supported technology objects			
Motion Control	Yes; Note: The number of axes affects the cycle time of the PLC program; selection guide via the TIA Selection Tool or SIZER	Yes; Note: The number of axes affects the cycle time of the PLC program; selection guide via the TIA Selection Tool or SIZER	Yes; Note: The number of axes affects the cycle time of the PLC program; selection guide via the TIA Selection Tool or SIZER
• Number of available Motion Control resources for technology objects (except cam disks)	10 240	10 240	10 240
• Required Motion Control resources			
- per speed-controlled axis	40	40	40
- per positioning axis	80	80	80
- per synchronous axis	160	160	160
- per external encoder	80	80	80
- per output cam	20	20	20
- per cam track	160	160	160
- per probe	40	40	40
Controller			
• PID_Compact	Yes; Universal PID controller with integrated optimization	Yes; Universal PID controller with integrated optimization	Yes; Universal PID controller with integrated optimization
• PID_3Step	Yes; PID controller with integrated optimization for valves	Yes; PID controller with integrated optimization for valves	Yes; PID controller with integrated optimization for valves
• PID-Temp	Yes; PID controller with integrated optimization for temperature	Yes; PID controller with integrated optimization for temperature	Yes; PID controller with integrated optimization for temperature
Counting and measuring			
• High-speed counter	Yes	Yes	Yes
Highest safety class achievable in safety mode			
Probability of failure (for service life of 20 years and repair time of 100 hours)			
- Low demand mode: PFDavg in accordance with SIL3	< 2.00E-05	< 2.00E-05	< 2.00E-05
- High demand/continuous mode: PFH in accordance with SIL3	< 1.00E-09	< 1.00E-09	< 1.00E-09

Technical specifications (continued)

Article number	6ES7517-3FP00-0AB0 CPU 1517F-3 PN/DP, 3MB PROG., 8MB DATA	6ES7518-4FP00-0AB0 CPU 1518F-4 PN/DP, 6 MB PROG, 20MB DATA	6ES7518-4FP00-3AB0 CPU 1518F-4 PN/DP ODK, 6 MB PROG, 20MB DATA
Ambient conditions			
Ambient temperature during operation			
• horizontal installation, min.	0 °C	0 °C	0 °C
• horizontal installation, max.	60 °C; Display: 50 °C, at an operating temperature of typically 50 °C, the display is switched off	60 °C; Display: 50 °C, at an operating temperature of typically 50 °C, the display is switched off	60 °C; Display: 50 °C, at an operating temperature of typically 50 °C, the display is switched off
• vertical installation, min.	0 °C	0 °C	0 °C
• vertical installation, max.	40 °C; Display: 40 °C, at an operating temperature of typically 40 °C, the display is switched off	40 °C; Display: 40 °C, at an operating temperature of typically 40 °C, the display is switched off	40 °C; Display: 40 °C, at an operating temperature of typically 40 °C, the display is switched off
Configuration			
Programming			
Programming language			
- LAD	Yes; incl. failsafe	Yes; incl. failsafe	Yes; incl. failsafe
- FBD	Yes; incl. failsafe	Yes; incl. failsafe	Yes; incl. failsafe
- STL	Yes	Yes	Yes
- SCL	Yes	Yes	Yes
- GRAPH	Yes	Yes	Yes
Know-how protection			
• User program protection/password protection	Yes	Yes	Yes
• Copy protection	Yes	Yes	Yes
• Block protection	Yes	Yes	Yes
Access protection			
• Password for display	Yes	Yes	Yes
• Protection level: Write protection	Yes	Yes	Yes
• Protection level: Read/write protection	Yes	Yes	Yes
• Protection level: Complete protection	Yes	Yes	Yes
Open Development interfaces			
• Size of ODK SO file, max.			6 Mbyte
Dimensions			
Width	175 mm	175 mm	175 mm
Height	147 mm	147 mm	147 mm
Depth	129 mm	129 mm	129 mm
Weights			
Weight, approx.	1 978 g	1 988 g	1 988 g

SIMATIC S7-1500 Advanced Controllers

Central processing units

Fail-safe CPUs

4

Ordering data	Article No.	Ordering data	Article No.
CPU 1511F-1 PN Fail-safe CPU, work memory 230 KB for program, 1 MB for data, PROFINET IO IRT interface; SIMATIC Memory Card required	6ES7511-1FK01-0AB0	SIMATIC S7-1500 DIN rail Fixed lengths, with grounding elements <ul style="list-style-type: none"> • 160 mm • 245 mm • 482 mm • 530 mm • 830 mm For cutting to length by customer, without drill holes; grounding elements must be ordered separately <ul style="list-style-type: none"> • 2000 mm 	6ES7590-1AB60-0AA0 6ES7590-1AC40-0AA0 6ES7590-1AE80-0AA0 6ES7590-1AF30-0AA0 6ES7590-1AJ30-0AA0
CPU 1513F-1 PN Fail-safe CPU, work memory 450 KB for program, 1.5 MB for data, PROFINET IO IRT interface; SIMATIC Memory Card required	6ES7513-1FL01-0AB0		
CPU 1515F-2 PN Fail-safe CPU, work memory 750 KB for program, 3 MB for data, PROFINET IO IRT interface, PROFINET interface; SIMATIC Memory Card required	6ES7515-2FM01-0AB0		6ES7590-1BC00-0AA0
CPU 1516F-3 PN/DP Fail-safe CPU, work memory 1.5 MB for program, 5 MB for data, PROFINET IO IRT interface, PROFINET/PROFIBUS interface; SIMATIC Memory Card required	6ES7516-3FN01-0AB0	PE connection element for DIN rail 2000 mm 20 units	6ES7590-5AA00-0AA0
CPU 1517F-3 PN/DP Fail-safe CPU, work memory 3 MB for program, 8 MB for data, PROFINET IO IRT interface, PROFINET/PROFIBUS interface; SIMATIC Memory Card required	6ES7517-3FP00-0AB0	Power supply For supplying the backplane bus of the S7-1500 <ul style="list-style-type: none"> 24 V DC input voltage, power 25 W 24/48/60 V DC input voltage, power 60 W 24/48/60 V DC input voltage, power 60 W, buffering functionality 120/230 V AC input voltage, power 60 W 	6ES7505-0KA00-0AB0 6ES7505-0RA00-0AB0 6ES7505-0RB00-0AB0 6ES7507-0RA00-0AB0
CPU 1518F-4 PN/DP Fail-safe CPU, work memory 6 MB for program, 20 MB for data, PROFINET IO IRT interface, 2 PROFINET interfaces, PROFIBUS interface; SIMATIC Memory Card required	6ES7518-4FP00-0AB0	Power connector With coding element for power supply module; spare part, 10 units	6ES7590-8AA00-0AA0
CPU 1518F-4 PN/DP ODK Fail-safe CPU, work memory 6 MB for program, 20 MB for data, PROFINET IO IRT interface, 2 PROFINET interfaces, PROFIBUS interface; SIMATIC Memory Card required	6ES7518-4FP00-3AB0	Load power supply 24 V DC/3A 24 V DC/8A	6EP1332-4BA00 6EP1333-4BA00
Accessories SIMATIC Memory Card 4 MB 12 MB 24 MB 256 MB 2 GB 32 GB	6ES7954-8LC02-0AA0 6ES7954-8LE02-0AA0 6ES7954-8LF02-0AA0 6ES7954-8LL02-0AA0 6ES7954-8LP02-0AA0 6ES7954-8LT03-0AA0	Power supply connector Spare part; for connecting the 24 V DC supply voltage <ul style="list-style-type: none"> • with push-in terminals 	6ES7193-4JB00-0AA0
		PROFIBUS FastConnect RS 485 bus connector with 90° cable outlet With insulation displacement, max. transmission rate 12 Mbps Without PG interface, grounding via control cabinet contact surface; 1 unit With PG interface, grounding via control cabinet contact surface; 1 unit	6ES7972-0BA70-0XA0 6ES7972-0BB70-0XA0
		PROFIBUS FC Standard Cable GP Standard type with special design for fast mounting, 2-wire, shielded; sold by the meter; max. delivery unit 1000 m, minimum order quantity 20 m	6XV1830-0EH10
		PROFIBUS FC Robust Cable 2-wire, shielded; sold by the meter; max. delivery unit 1000 m, minimum order quantity 20 m	6XV1830-0JH10
		PROFIBUS FC Flexible Cable 2-wire, shielded; sold by the meter; max. delivery unit 1000 m, minimum order quantity 20 m	6XV1831-2K

Ordering data	Article No.	Article No.	
PROFIBUS FC Trailing Cable 2-wire, shielded; sold by the meter; max. delivery unit 1000 m, minimum order quantity 20 m Sheath color: Petrol Sheath color: Violet	6XV1830-3EH10 6XV1831-2L	IE FC TP Marine Cable 2 x 2 (Type B) 4-wire, shielded TP installation cable for connection to IE FC outlet RJ45/ IE FC RJ45 Plug 180/90 with marine approval, sold by the meter; max. delivery unit 1000 m, minimum order quantity 20 m	6XV1840-4AH10
PROFIBUS FC Food Cable 2-wire, shielded; sold by the meter; max. delivery unit 1000 m, minimum order quantity 20 m	6XV1830-0GH10	IE FC Stripping Tool Preadjusted stripping tool for fast stripping of Industrial Ethernet FC cables	6GK1901-1GA00
PROFIBUS FC Ground Cable 2-wire, shielded; sold by the meter; max. delivery unit 1000 m, minimum order quantity 20 m	6XV1830-3FH10	Display For CPU 1511(F)-1 PN and CPU 1513(F)-1 PN; spare part For CPU 1515(F)-2 PN, CPU 1516(F)-3 PN/DP, CPU 1517(F)-3 PN/DP, CPU 1518(F)-4 PN/DP and CPU 1518(F)-4 PN/DP ODK; spare part	6ES7591-1AA01-0AA0 6ES7591-1BA01-0AA0
PROFIBUS FC FRNC Cable GP 2-wire, shielded, flame-retardant, with copolymer outer sheath FRNC; sold by the meter; max. delivery unit 1000 m, minimum order quantity 20 m	6XV1830-0LH10	Front cover for PROFIBUS DP interface For CPU 1517-3 PN/DP and CPU 1518-4 PN/DP; spare part	6ES7591-8AA00-0AA0
PROFIBUS FastConnect Stripping Tool Preadjusted stripping tool for fast stripping of PROFIBUS FastConnect bus cables	6GK1905-6AA00	SIMATIC S7-1500 Starter Kit Comprising: CPU 1511C-1 PN, SIMATIC Memory Card 4 MB, 160 mm DIN rail, front connector, STEP 7 Professional 365-day license, PM 70 W 120/230 V AC power supply, Ethernet cable, documentation	6ES7511-1CK00-4YB5
IE FC RJ45 plugs RJ45 plug connector for Industrial Ethernet with a rugged metal enclosure and integrated insulation displacement contacts for connecting Industrial Ethernet FC installation cables		STEP 7 Safety Advanced V14 SP1 Task: Engineering tool for configuring and programming fail-safe user programs for SIMATIC S7-1200 FC, S7-1500F, S7-1500F Software Controller, S7-300F, S7-400F, WinAC RTX F, ET 200SP F Controller and the fail-safe ET 200SP, ET 200S, ET 200M, ET 200iSP, ET 200pro and ET 200eco I/O Requirement: STEP 7 Professional V14 SP1 Floating license for 1 user, software and documentation on DVD, license key on USB flash drive Floating license for 1 user, software, documentation and license key for download ¹⁾ ; email address required for delivery	6ES7833-1FA14-0YA5 6ES7833-1FA14-0YH5
IE FC RJ45 Plug 180 180° cable outlet 1 unit 10 units 50 units	6GK1901-1BB10-2AA0 6GK1901-1BB10-2AB0 6GK1901-1BB10-2AE0		
IE FC TP Standard Cable GP 2x2 4-wire, shielded TP installation cable for connection to IE FC outlet RJ45/ IE FC RJ45 plug; PROFINET-compatible; with UL approval; sold by the meter; max. delivery unit 1000 m, minimum order quantity 20 m	6XV1840-2AH10		
IE FC TP Trailing Cable 2 x 2 (Type C) 4-wire, shielded TP installation cable for connection to IE FC outlet RJ45/ IE FC RJ45 Plug 180/90 for use as trailing cable; PROFINET-compatible; with UL approval; sold by the meter; max. delivery unit 1000 m, minimum order quantity 20 m	6XV1840-3AH10		

¹⁾ For up-to-date information and download availability, see: <http://www.siemens.com/tia-online-software-delivery>

SIMATIC S7-1500 Advanced Controllers

Central processing units

Fail-safe CPUs

Ordering data**Article No.****Article No.****STEP 7 Professional V14 SP1**

Target system:

SIMATIC S7-1200, S7-1500,
S7-300, S7-400, WinAC

Requirement:

Windows 7 Professional SP1
(64-bit),
Windows 7 Enterprise SP1 (64-bit),
Windows 7 Ultimate SP1 (64-bit),
Windows 8.1 Professional (64-bit),
Windows 8.1 Enterprise (64-bit),
Windows 10 Professional
Version 1607,
Windows 10 Enterprise
Version 1607,
Windows 10 Enterprise 2016 LTSB,
Windows 10 Enterprise 2015 LTSB,
Windows Server 2008 R2 StdE
(full installation),
Windows Server 2012 StdE
(full installation),
Windows Server 2016 Standard
(full installation);

Type of delivery:

English, German, Chinese, Italian,
French, SpanishSTEP 7 Professional V14 SP1,
floating license**6ES7822-1AA04-0YA5**STEP 7 Professional V14 SP1,
floating license,
software download
incl. license key ¹⁾**6ES7822-1AE04-0YA5**

Email address required for delivery

SIMATIC ODK 1500S V2.0Open Development Kit for
support in developing Windows
and real-time library functions

Package with data storage medium

6ES7806-2CD02-0YA0Download incl. license key ¹⁾**6ES7806-2CD02-0YG0**

Email address required for delivery

**SIMATIC Target 1500S
for Simulink V1.0****6ES7823-1BE00-0YA5**Download incl. license key ¹⁾

Email address required for delivery

SIMATIC Manual Collection**6ES7998-8XC01-8YE0**Electronic manuals on DVD,
multi-language:
LOGO!, SIMADYN, SIMATIC bus
components, SIMATIC C7,
SIMATIC distributed I/O,
SIMATIC HMI, SIMATIC Sensors,
SIMATIC NET, SIMATIC PC Based
Automation, SIMATIC PCS 7,
SIMATIC PG/PC, SIMATIC S7,
SIMATIC Software, SIMATIC TDC**SIMATIC Manual Collection
update service for 1 year****6ES7998-8XC01-8YE2**Current "Manual Collection" DVD
and the three subsequent updates¹⁾ For up-to-date information and download availability, see:
<http://www.siemens.com/tia-online-software-delivery>

Overview SIPLUS CPU 1511F-1 PN



- Entry-level CPU in the SIPLUS S7-1500F Controller product range
- Suitable for standard and fail-safe applications with medium requirements for program scope and processing speed
- Used as central controller in production lines with central and distributed I/O
- Supports PROFIsafe in centralized and distributed configurations
- PROFINET IO IRT interface with 2-port switch
- PROFINET IO controller for operating distributed I/O on PROFINET
- PROFINET I-device for connecting the CPU as an intelligent PROFINET device under a SIMATIC or third-party PROFINET IO controller
- Isochronous mode

Note:

SIMATIC Memory Card required for operation of the CPU.

SIPLUS extreme products are based on SIMATIC standard products. The contents listed here were taken from the corresponding standard products. SIPLUS extreme-specific information was added.

Overview SIPLUS CPU 1513F-1 PN



- The CPU for standard and fail-safe applications with medium/high requirements for program/data storage in the SIPLUS S7-1500 Controller product range
- High processing speed for binary and floating-point arithmetic
- Used as central controller in production lines with central and distributed I/O
- Supports PROFIsafe in centralized and distributed configurations
- PROFINET IO IRT interface with 2-port switch
- PROFINET IO controller for operating distributed I/O on PROFINET
- PROFINET I-device for connecting the CPU as an intelligent PROFINET device under a SIMATIC or third-party PROFINET IO controller
- Isochronous mode

Note:

SIMATIC Memory Card required for operation of the CPU.

SIPLUS extreme products are based on SIMATIC standard products. The contents listed here were taken from the corresponding standard products. SIPLUS extreme-specific information was added.

SIMATIC S7-1500 Advanced Controllers

Central processing units

SIPLUS fail-safe CPUs

Overview SIPLUS CPU 1516F-3 PN/DP



- The CPU with a large program and data memory in the SIPLUS S7-1500 Controller product range for fail-safe applications with high requirements regarding program scope and networking.
- Can be used for fail-safe functions up to SIL 3 according to IEC 61508 and up to PLe according to ISO 13849.
- High processing speed for binary and floating-point arithmetic
- Used as central controller in production lines with central and distributed I/O.
- Supports PROFIsafe in centralized and distributed configuration.
- PROFINET IO IRT interface with 2-port switch.
- Additional PROFINET interface with separate IP address.
- PROFINET IO controller for operating distributed I/O on PROFINET.
- PROFINET I-device for connecting the CPU as an intelligent PROFINET device under a SIMATIC or third-party PROFINET IO controller.
- PROFIBUS DP master interface.
- Isochronous mode on PROFIBUS and PROFINET.
- Integrated motion control functionalities for controlling speed-controlled and positioning axes, support for external encoders.
- Integrated web server with the option of creating user-defined web pages.

Note:

SIMATIC Memory Card required for operation of the CPU

SIPLUS extreme products are based on SIMATIC standard products. The contents listed here were taken from the corresponding standard products. SIPLUS extreme-specific information was added.

Overview SIPLUS CPU 1518-4 PN/DP



- The CPU with a very large program and data memory in the SIPLUS S7-1500 Controller product range for fail-safe applications with highest requirements regarding program scope, performance and networking.
- Can be used for fail-safe functions up to SIL 3 according to IEC 61508 and up to PLe according to ISO 13849.
- Extremely high processing speed for binary and floating-point arithmetic.
- For cross-industry automation tasks in series machine, special machine and plant construction
- Used as central controller in production lines with central and distributed I/O.
- Supports PROFIsafe in centralized and distributed configuration.
- PROFINET IO IRT interface with 2-port switch.
- Two additional PROFINET interfaces with separate IP addresses.
- PROFINET IO controller for operating distributed I/O on PROFINET.
- PROFINET I-device for connecting the CPU as an intelligent PROFINET device under a SIMATIC or third-party PROFINET IO controller.
- PROFIBUS DP master interface.
- Isochronous mode on PROFIBUS and PROFINET.
- Integrated motion control functionalities for controlling speed-controlled and positioning axes, support for external encoders
- Integrated web server with the option of creating user-defined web pages.

Note:

SIMATIC Memory Card required for operation of the CPU.

SIPLUS extreme products are based on SIMATIC standard products. The contents listed here were taken from the corresponding standard products. SIPLUS extreme-specific information was added.

SIMATIC S7-1500 Advanced Controllers

Central processing units

SIPLUS fail-safe CPUs

Technical specifications

Article number	6AG1511-1FK01-2AB0	6AG1513-1FL01-2AB0	6AG1516-3FN01-2AB0	6AG1518-4FP00-4AB0
Based on	6ES7511-1FK01-0AB0 SIPLUS S7-1500 CPU 1511F-1 PN	6ES7513-1FL01-0AB0 SIPLUS S7-1500 CPU 1513F-1 PN	6ES7516-3FN01-0AB0 SIPLUS S7-1500 CPU-1516F-3 PN/DP	6ES7518-4FP00-0AB0 SIPLUS S7-1500 CPU 1518F-4 PN/DP
Ambient conditions				
Ambient temperature during operation				
• horizontal installation, min.	-25 °C; = Tmin; startup @ -25 °C; startup display @ -20 °C	-25 °C; = Tmin; startup @ -25 °C; startup display @ -20 °C	-25 °C; = Tmin; startup @ -25 °C; startup display @ -20 °C	0 °C
• horizontal installation, max.	60 °C; Display: 50 °C, at an operating temperature of typically 50 °C, the display is switched off	60 °C; Display: 50 °C, at an operating temperature of typically 50 °C, the display is switched off	60 °C; Display: 50 °C, at an operating temperature of typically 50 °C, the display is switched off	60 °C; Display: 50 °C, at an operating temperature of typically 50 °C, the display is switched off
• vertical installation, min.	-25 °C; = Tmin; startup @ -25 °C; startup display @ -20 °C	-25 °C; = Tmin; startup @ -25 °C; startup display @ -20 °C	-25 °C; = Tmin; startup @ -25 °C; startup display @ -20 °C	0 °C
• vertical installation, max.	40 °C; Display: 40 °C, at an operating temperature of typically 40 °C, the display is switched off	40 °C; Display: 40 °C, at an operating temperature of typically 40 °C, the display is switched off	40 °C; Display: 40 °C, at an operating temperature of typically 40 °C, the display is switched off	40 °C; Display: 40 °C, at an operating temperature of typically 40 °C, the display is switched off
Extended ambient conditions				
• relative to ambient temperature-atmospheric pressure-installation altitude	Tmin ... Tmax at 1080 hPa ... 795 hPa (-1000 m ... +2000 m)	Tmin ... Tmax at 1080 hPa ... 795 hPa (-1000 m ... +2000 m)	Tmin ... Tmax at 1080 hPa ... 795 hPa (-1000 m ... +2000 m)	Tmin ... Tmax at 1080 hPa ... 795 hPa (-1000 m ... +2000 m)
Relative humidity				
- With condensation, tested in accordance with IEC 60068-2-38, max.	100 %; RH incl. condensation / frost (no commissioning in bedewed state), horizontal installation	100 %; RH incl. condensation / frost (no commissioning in bedewed state), horizontal installation	100 %; RH incl. condensation / frost (no commissioning in bedewed state), horizontal installation	100 %; RH incl. condensation/frost (no commissioning under condensation conditions)
Resistance				
- against biologically active substances / conformity with EN 60721-3-3	Yes; Class 3B2 mold, fungus and dry rot spores (with the exception of fauna). The supplied connector covers must remain on the unused interfaces during operation!	Yes; Class 3B2 mold, fungus and dry rot spores (with the exception of fauna). The supplied connector covers must remain on the unused interfaces during operation!	Yes; Class 3B2 mold, fungus and dry rot spores (with the exception of fauna). The supplied connector covers must remain on the unused interfaces during operation!	Yes; Class 3B2 mold, fungus and dry rot spores (with the exception of fauna). The supplied connector covers must remain on the unused interfaces during operation!
- against chemically active substances / conformity with EN 60721-3-3	Yes; Class 3C4 (RH < 75%) incl. salt spray according to EN 60068-2-52 (degree of severity 3). The supplied connector covers must remain on the unused interfaces during operation!	Yes; Class 3C4 (RH < 75%) incl. salt spray according to EN 60068-2-52 (degree of severity 3). The supplied connector covers must remain on the unused interfaces during operation!	Yes; Class 3C4 (RH < 75%) incl. salt spray according to EN 60068-2-52 (degree of severity 3). The supplied connector covers must remain on the unused interfaces during operation!	Yes; Class 3C4 (RH < 75%) incl. salt spray according to EN 60068-2-52 (degree of severity 3). The supplied connector covers must remain on the unused interfaces during operation!
- against mechanically active substances / conformity with EN 60721-3-3	Yes; Class 3S4 incl. sand, dust. The supplied connector covers must remain on the unused interfaces during operation!	Yes; Class 3S4 incl. sand, dust. The supplied connector covers must remain on the unused interfaces during operation!	Yes; Class 3S4 incl. sand, dust. The supplied connector covers must remain on the unused interfaces during operation!	Yes; Class 3S4 incl. sand, dust. The supplied connector covers must remain on the unused interfaces during operation!

SIMATIC S7-1500 Advanced Controllers

Central processing units

SIPLUS fail-safe CPUs

Ordering data

Article No.

CPU 1511F-1 PN

(Extended temperature range and exposure to media)

Fail-safe CPU, work memory 225 KB for program, 1 MB for data, PROFINET IO IRT interface; SIMATIC Memory Card required

6AG1511-1FK01-2AB0

SIPLUS CPU 1513F-1 PN

(Extended temperature range and exposure to media)

Fail-safe CPU, work memory 450 KB for program, 1.5 MB for data, PROFINET IO IRT interface; SIMATIC Memory Card required

6AG1513-1FL01-2AB0

SIPLUS CPU 1516F-3 PN/DP

(Extended temperature range and exposure to media)

Fail-safe CPU, work memory 1.5 MB for program, 5 MB for data, PROFINET IO IRT interface, PROFINET/PROFIBUS interface; SIMATIC Memory Card required

6AG1516-3FN01-2AB0

CPU 1518F-4 PN/DP

(Exposure to media)

Fail-safe CPU, work memory 6 MB for program, 20 MB for data, PROFINET IO IRT interface, 2 PROFINET interfaces, PROFIBUS interface; SIMATIC Memory Card required

6AG1518-4FP00-4AB0

Article No.

Accessories

Power supply

(Extended temperature range and exposure to media)

For supplying the backplane bus of the S7-1500

24 V DC input voltage, power 25 W

6AG1505-0KA00-7AB0

24/48/60 V DC input voltage, power 60 W

6AG1505-0RA00-7AB0

24/48/60 V DC input voltage, power 60 W, buffering functionality

6ES7505-0RB00-0AB0

120/230 VAC input voltage, power 60 W

6AG1507-0RA00-7AB0

Load power supply

(Extended temperature range and exposure to media)

24 V DC/3A

6AG1332-4BA00-7AA0

24 V DC/8A

6AG1333-4BA00-7AA0

Display

(Extended temperature range and exposure to media)

For SIPLUS CPU 1511F-1 PN and CPU 1513F-1 PN; spare part

6AG1591-1AA01-2AA0

For SIPLUS CPU 1516F-3 PN/DP and CPU 1518-4F PN/DP; spare part

6AG1591-1BA01-2AA0

Other accessories

See SIMATIC S7-1500, fail-safe CPUs, page 4/44

Overview CPU 1511T-1 PN



- Entry-level CPU in the S7-1500T Controller product range
- Suitable for applications with medium requirements for program scope and processing speed
- Used as central controller in production lines with central and distributed I/O
- PROFINET IO IRT interface with 2-port switch
- PROFINET IO controller for operating distributed I/O on PROFINET
- PROFINET I-device for connecting the CPU as an intelligent PROFINET device under a SIMATIC or third-party PROFINET IO controller
- OPC UA Server (Data Access) as runtime option for the easy connection of SIMATIC S7-1500 to third-party devices/ systems
- Isochronous mode
- Integrated motion control functionalities for controlling speed-controlled, positioning and synchronized axes (gearing and camming), support for external encoders, cams/cam tracks and probes
- Integrated web server for diagnostics with the option of creating user-defined web pages

Note

SIMATIC Memory Card required for operating the CPU.

Overview CPU 1515T-2 PN



- The CPU for applications with medium to high requirements for program/data storage in the S7-1500T Controller product range
- Medium to high processing speed for binary and floating-point arithmetic
- Used as central controller in production lines with central and distributed I/O
- PROFINET IO IRT interface with 2-port switch
- PROFINET IO controller for operating distributed I/O on PROFINET
- PROFINET I-device for connecting the CPU as an intelligent PROFINET device under a SIMATIC or third-party PROFINET IO controller
- Additional PROFINET interface with separate IP address for network separation, for connecting further PROFINET IO RT devices, or for high-speed communication as an I-device
- OPC UA Server (Data Access) as runtime option for the easy connection of SIMATIC S7-1500 to third-party devices/ systems
- Isochronous mode
- Integrated motion control functionalities for controlling speed-controlled, positioning and synchronized axes (gearing and camming), support for external encoders, cams/cam tracks and probes
- Integrated web server for diagnostics with the option of creating user-defined web pages

Note

SIMATIC Memory Card required for operation of the CPU.

SIMATIC S7-1500 Advanced Controllers

Central processing units

Technology CPUs

Overview CPU 1517T-3 PN/DP



- The CPU with a very large program and data memory in the S7-1500 Controller product range for applications with high requirements regarding program scope and networking.
- High processing speed for binary and floating-point arithmetic
- For cross-industry automation tasks in series machines, special machines and plant construction
- Used as central controller in production lines with central and distributed I/O
- PROFINET IO IRT interface with 2-port switch
- PROFINET IO controller for operating distributed I/O on PROFINET.
- PROFINET I-device for connecting the CPU as an intelligent PROFINET device under a SIMATIC or third-party PROFINET IO controller.
- Additional PROFINET interface with separate IP address for network separation, for connecting further PROFINET IO RT devices, or for high-speed communication as an I-device
- PROFIBUS DP master interface
- OPC UA Server (Data Access) as runtime option for the easy connection of SIMATIC S7-1500 to third-party devices/systems
- Isochronous mode on PROFIBUS and PROFINET
- Integrated motion control functionalities for controlling speed-controlled, positioning and synchronized axes (gearing and camming), support for external encoders, cams/cam tracks and probes
- Integrated web server for diagnostics with the option of creating user-defined web pages

Note

SIMATIC Memory Card required for operation of the CPU.

Overview CPU 1517TF-3 PN/DP



- The CPU with a very large program and data memory in the S7-1500 Controller product range for fail-safe applications with high requirements regarding program scope and networking.
- Can be used for fail-safe functions up to SIL 3 according to IEC 61508 and up to PLe according to ISO 13849
- High processing speed for binary and floating-point arithmetic
- For cross-industry automation tasks in series machines, special machines and plant construction
- Used as central controller in production lines with central and distributed I/O
- PROFINET IO IRT interface with 2-port switch
- PROFINET IO controller for operating distributed I/O on PROFINET.
- PROFINET I-device for connecting the CPU as an intelligent PROFINET device under a SIMATIC or third-party PROFINET IO controller.
- Additional PROFINET interface with separate IP address for network separation, for connecting further PROFINET IO RT devices, or for high-speed communication as an I-device
- PROFIBUS DP master interface
- OPC UA Server (Data Access) as runtime option for the easy connection of SIMATIC S7-1500 to third-party devices/systems
- Isochronous mode on PROFIBUS and PROFINET
- Integrated motion control functionalities for controlling speed-controlled, positioning and synchronized axes (gearing and camming), support for external encoders, cams/cam tracks and probes
- Integrated web server for diagnostics with the option of creating user-defined web pages

Note

SIMATIC Memory Card required for operation of the CPU.

Technical specifications

Article number	6ES7511-1TK01-0AB0 CPU 1511T-1PN, 225KB prog., 1MB data	6ES7515-2TM01-0AB0 CPU 1515T-2 PN, 750KB prog., 3MB data	6ES7517-3TP00-0AB0 CPU 1517T-3 PN/DP, 3MB prog., 8MB data	6ES7517-3UP00-0AB0 CPU 1517TF-3 PN/DP, 3MB prog., 8MB data
General information				
Product type designation	CPU 1511T-1 PN	CPU 1515T-2 PN	CPU 1517T-3 PN/DP	CPU 1517TF-3 PN/DP
Engineering with				
• STEP 7 TIA Portal configurable/ integrated as of version	V14	V14	V14	V14
Display				
Screen diagonal [cm]	3.45 cm	6.1 cm	6.1 cm	6.1 cm
Supply voltage				
Type of supply voltage	24 V DC	24 V DC	24 V DC	24 V DC
Power loss				
Power loss, typ.	5.7 W	6.3 W	24 W	24 W
Memory				
Work memory				
• integrated (for program)	225 kbyte	750 kbyte	3 Mbyte	3 Mbyte
• integrated (for data)	1 Mbyte	3 Mbyte	8 Mbyte	8 Mbyte
Load memory				
• Plug-in (SIMATIC Memory Card), max.	32 Gbyte	32 Gbyte	32 Gbyte	32 Gbyte
CPU processing times				
for bit operations, typ.	60 ns	30 ns	2 ns	2 ns
for word operations, typ.	72 ns	36 ns	3 ns	3 ns
for fixed point arithmetic, typ.	96 ns	48 ns	3 ns	3 ns
for floating point arithmetic, typ.	384 ns	192 ns	12 ns	12 ns
Counters, timers and their retentivity				
S7 counter				
• Number	2 048	2 048	2 048	2 048
IEC counter				
• Number	Any (only limited by the main memory)	Any (only limited by the main memory)	Any (only limited by the main memory)	Any (only limited by the main memory)
S7 times				
• Number	2 048	2 048	2 048	2 048
IEC timer				
• Number	Any (only limited by the main memory)	Any (only limited by the main memory)	Any (only limited by the main memory)	Any (only limited by the main memory)
Data areas and their retentivity				
Flag				
• Number, max.	16 kbyte	16 kbyte	16 kbyte	16 kbyte
Address area				
I/O address area				
• Inputs	32 kbyte; All inputs are in the process image	32 kbyte; All inputs are in the process image	32 kbyte; All inputs are in the process image	32 kbyte; All inputs are in the process image
• Outputs	32 kbyte; All outputs are in the process image	32 kbyte; All outputs are in the process image	32 kbyte; All outputs are in the process image	32 kbyte; All outputs are in the process image
Time of day				
Clock				
• Type	Hardware clock	Hardware clock	Hardware clock	Hardware clock
1. Interface				
Interface types				
• Number of ports	2	2	2	2
• integrated switch	Yes	Yes	Yes	Yes
• RJ 45 (Ethernet)	Yes; X1	Yes; X1	Yes; X1	Yes; X1
Functionality				
• PROFINET IO Controller	Yes	Yes	Yes	Yes
• PROFINET IO Device	Yes	Yes	Yes	Yes
• SIMATIC communication	Yes	Yes	Yes	Yes
• Open IE communication	Yes	Yes	Yes	Yes
• Web server	Yes	Yes	Yes	Yes
• Media redundancy	Yes	Yes	Yes	Yes

SIMATIC S7-1500 Advanced Controllers

Central processing units

Technology CPUs

Technical specifications (continued)

Article number	6ES7511-1TK01-0AB0 CPU 1511T-1PN, 225KB prog., 1MB data	6ES7515-2TM01-0AB0 CPU 1515T-2 PN, 750KB prog., 3MB data	6ES7517-3TP00-0AB0 CPU 1517T-3 PN/DP, 3MB prog., 8MB data	6ES7517-3UP00-0AB0 CPU 1517TF-3 PN/DP, 3MB prog., 8MB data
PROFINET IO Controller				
Services				
- PG/OP communication	Yes	Yes	Yes	Yes
- S7 routing	Yes	Yes	Yes	Yes
- Isochronous mode	Yes	Yes	Yes	Yes
- Open IE communication	Yes	Yes	Yes	Yes
- IRT	Yes	Yes	Yes	Yes
- MRP	Yes; As MRP redundancy manager and/or MRP client; max. number of devices in the ring: 50	Yes; As MRP redundancy manager and/or MRP client; max. number of devices in the ring: 50	Yes; As MRP redundancy manager and/or MRP client; max. number of devices in the ring: 50	Yes; As MRP redundancy manager and/or MRP client; max. number of devices in the ring: 50
- MRPD	Yes; Requirement: IRT	Yes; Requirement: IRT	Yes; Requirement: IRT	Yes; Requirement: IRT
- PROFinergy	Yes	Yes	Yes	Yes
- Prioritized startup	Yes; Max. 32 PROFINET devices	Yes; Max. 32 PROFINET devices	Yes; Max. 32 PROFINET devices	Yes; Max. 32 PROFINET devices
- Number of connectable IO Devices, max.	128; In total, up to 256 distributed I/O devices can be connected via AS-I, PROFIBUS or PROFINET	256; In total, up to 1 000 distributed I/O devices can be connected via AS-I, PROFIBUS or PROFINET	512; In total, up to 1 000 distributed I/O devices can be connected via AS-I, PROFIBUS or PROFINET	512; In total, up to 1 000 distributed I/O devices can be connected via AS-I, PROFIBUS or PROFINET
- Of which IO devices with IRT, max.	64	64	64	64
- Number of connectable IO Devices for RT, max.	128	256	512	512
- of which in line, max.	128	256	512	512
- Number of IO Devices that can be simultaneously activated/deactivated, max.	8; in total across all interfaces	8; in total across all interfaces	8; in total across all interfaces	8; in total across all interfaces
- Number of IO Devices per tool, max.	8	8	8	8
- Updating times	The minimum value of the update time also depends on communication share set for PROFINET IO, on the number of IO devices, and on the quantity of configured user data	The minimum value of the update time also depends on communication share set for PROFINET IO, on the number of IO devices, and on the quantity of configured user data	The minimum value of the update time also depends on communication share set for PROFINET IO, on the number of IO devices, and on the quantity of configured user data	The minimum value of the update time also depends on communication share set for PROFINET IO, on the number of IO devices, and on the quantity of configured user data
Update time for IRT				
- for send cycle of 250 µs	250 µs to 4 ms; Note: In the case of IRT with isochronous mode, the minimum update time of 625 µs of the isochronous OB is decisive	250 µs to 4 ms; Note: In the case of IRT with isochronous mode, the minimum update time of 500 µs of the isochronous OB is decisive	250 µs to 4 ms; Note: In the case of IRT with isochronous mode, the minimum update time of 500 µs of the isochronous OB is decisive	250 µs to 4 ms; Note: In the case of IRT with isochronous mode, the minimum update time of 500 µs of the isochronous OB is decisive
- for send cycle of 500 µs	500 µs to 8 ms; Note: In the case of IRT with isochronous mode, the minimum update time of 625 µs of the isochronous OB is decisive	500 µs to 8 ms	500 µs to 8 ms	500 µs to 8 ms
- for send cycle of 1 ms	1 ms to 16 ms	1 ms to 16 ms	1 ms to 16 ms	1 ms to 16 ms
- for send cycle of 2 ms	2 ms to 32 ms	2 ms to 32 ms	2 ms to 32 ms	2 ms to 32 ms
- for send cycle of 4 ms	4 ms to 64 ms	4 ms to 64 ms	4 ms to 64 ms	4 ms to 64 ms
- With IRT and parameterization of "odd" send cycles	Update time = set "odd" send clock (any multiple of 125 µs: 375 µs, 625 µs ... 3 875 µs)	Update time = set "odd" send clock (any multiple of 125 µs: 375 µs, 625 µs ... 3 875 µs)	Update time = set "odd" send clock (any multiple of 125 µs: 375 µs, 625 µs ... 3 875 µs)	Update time = set "odd" send clock (any multiple of 125 µs: 375 µs, 625 µs ... 3 875 µs)
Update time for RT				
- for send cycle of 250 µs	250 µs to 128 ms	250 µs to 128 ms	250 µs to 128 ms	250 µs to 128 ms
- for send cycle of 500 µs	500 µs to 256 ms	500 µs to 256 ms	500 µs to 256 ms	500 µs to 256 ms
- for send cycle of 1 ms	1 ms to 512 ms	1 ms to 512 ms	1 ms to 512 ms	1 ms to 512 ms
- for send cycle of 2 ms	2 ms to 512 ms	2 ms to 512 ms	2 ms to 512 ms	2 ms to 512 ms
- for send cycle of 4 ms	4 ms to 512 ms	4 ms to 512 ms	4 ms to 512 ms	4 ms to 512 ms
PROFINET IO Device				
Services				
- PG/OP communication	Yes	Yes	Yes	Yes
- S7 routing	Yes	Yes	Yes	Yes
- Isochronous mode	No	No	No	No
- Open IE communication	Yes	Yes	Yes	Yes
- IRT	Yes	Yes	Yes	Yes
- MRP	Yes	Yes	Yes	Yes

Technical specifications (continued)

Article number	6ES7511-1TK01-0AB0 CPU 1511T-1PN, 225KB prog., 1MB data	6ES7515-2TM01-0AB0 CPU 1515T-2 PN, 750KB prog., 3MB data	6ES7517-3TP00-0AB0 CPU 1517T-3 PN/DP, 3MB prog., 8MB data	6ES7517-3UP00-0AB0 CPU 1517TF-3 PN/DP, 3MB prog., 8MB data
Services (continued)				
- MRPD	Yes; Requirement: IRT	Yes; Requirement: IRT	Yes; Requirement: IRT	Yes; Requirement: IRT
- PROFlenergy	Yes	Yes	Yes	Yes
- Shared device	Yes	Yes	Yes	Yes
- Number of IO Controllers with shared device, max.	4	4	4	4
2. Interface				
Interface types				
• Number of ports		1	1	1
• integrated switch		No	No	No
• RJ 45 (Ethernet)		Yes; X2	Yes; X2	Yes; X2
Functionality				
• PROFINET IO Controller		Yes	Yes	Yes
• PROFINET IO Device		Yes	Yes	Yes
• SIMATIC communication		Yes	Yes	Yes
• Open IE communication		Yes	Yes	Yes
• Web server		Yes	Yes	Yes
• Media redundancy		No	No	No
PROFINET IO Controller				
Services				
- PG/OP communication		Yes	Yes	Yes
- S7 routing		Yes	Yes	Yes
- Isochronous mode		No	No	No
- Open IE communication		Yes	Yes	Yes
- IRT		No	No	No
- MRP		No	No	No
- PROFlenergy		Yes	Yes	Yes
- Prioritized startup		No	No	No
- Number of connectable IO Devices, max.		32; In total, up to 1 000 distributed I/O devices can be connected via AS-i, PROFIBUS or PROFINET	128; In total, up to 1 000 distributed I/O devices can be connected via AS-i, PROFIBUS or PROFINET	128; In total, up to 1 000 distributed I/O devices can be connected via AS-i, PROFIBUS or PROFINET
- Number of connectable IO Devices for RT, max.		32	128	32
- of which in line, max.		32	128	128
- Number of IO Devices that can be simultaneously activated/deactivated, max.		8; in total across all interfaces	8; in total across all interfaces	8; in total across all interfaces
- Number of IO Devices per tool, max.		8	8	8
- Updating times		The minimum value of the update time also depends on communication share set for PROFINET IO, on the number of IO devices, and on the quantity of configured user data	The minimum value of the update time also depends on communication share set for PROFINET IO, on the number of IO devices, and on the quantity of configured user data	The minimum value of the update time also depends on communication share set for PROFINET IO, on the number of IO devices, and on the quantity of configured user data
Update time for RT				
- for send cycle of 1 ms		1 ms to 512 ms	1 ms to 512 ms	1 ms to 512 ms
PROFINET IO Device				
Services				
- PG/OP communication		Yes	Yes	Yes
- S7 routing		Yes	Yes	Yes
- Isochronous mode		No	No	No
- Open IE communication		Yes	Yes	Yes
- IRT		No	No	No
- MRP		No	No	No
- MRPD		No	No	No
- PROFlenergy		Yes	Yes	Yes
- Prioritized startup		No	No	No
- Shared device		Yes	Yes	Yes
- Number of IO Controllers with shared device, max.		4	4	4

SIMATIC S7-1500 Advanced Controllers

Central processing units

Technology CPUs

Technical specifications (continued)

Article number	6ES7511-1TK01-0AB0 CPU 1511T-1PN, 225KB prog., 1MB data	6ES7515-2TM01-0AB0 CPU 1515T-2 PN, 750KB prog., 3MB data	6ES7517-3TP00-0AB0 CPU 1517T-3 PN/DP, 3MB prog., 8MB data	6ES7517-3UP00-0AB0 CPU 1517TF-3 PN/DP, 3MB prog., 8MB data
3. Interface				
Interface types				
• Number of ports			1	1
• RS 485			Yes	Yes
Functionality				
• PROFIBUS DP master			Yes	Yes
• PROFIBUS DP slave			No	No
• SIMATIC communication			Yes	Yes
Protocols				
Supports protocol for PROFINET IO	Yes	Yes	Yes	Yes
PROFIsafe	No	No	No	Yes
PROFIBUS	No	No	Yes	Yes
Number of connections				
• Number of connections, max.	96; via integrated interfaces of the CPU and connected CPs / CMs	192; via integrated interfaces of the CPU and connected CPs / CMs	320; via integrated interfaces of the CPU and connected CPs / CMs	320; via integrated interfaces of the CPU and connected CPs / CMs
PROFINET IO Controller				
Services				
- Number of connectable IO Devices, max.	128; In total, up to 256 distributed I/O devices can be connected via AS-i, PROFIBUS or PROFINET			
- Of which IO devices with IRT, max.	64			
- Number of connectable IO Devices for RT, max.	128			
PROFIBUS DP master				
Services				
- Number of DP slaves			125; In total, up to 1 000 distributed I/O devices can be connected via AS-i, PROFIBUS or PROFINET	125; In total, up to 512 distributed I/O devices can be connected via AS-i, PROFIBUS or PROFINET
Isochronous mode				
Isochronous operation (application synchronized up to terminal)	Yes; With minimum OB 6x cycle of 625 µs	Yes; With minimum OB 6x cycle of 500 µs	Yes; With minimum OB 6x cycle of 250 µs	Yes; With minimum OB 6x cycle of 250 µs
Supported technology objects				
Motion Control	Yes; Note: The number of axes affects the cycle time of the PLC program; selection guide via the TIA Selection Tool or SIZER	Yes; Note: The number of axes affects the cycle time of the PLC program; selection guide via the TIA Selection Tool or SIZER	Yes; Note: The number of axes affects the cycle time of the PLC program; selection guide via the TIA Selection Tool or SIZER	Yes; Note: The number of axes affects the cycle time of the PLC program; selection guide via the TIA Selection Tool or SIZER
• Number of available Motion Control resources for technology objects (except cam disks)	800	2 400	10 240	10 240
Required Motion Control resources				
- per speed-controlled axis	40	40	40	40
- per positioning axis	80	80	80	80
- per synchronous axis	160	160	160	160
- per external encoder	80	80	80	80
- per output cam	20	20	20	20
- per cam track	160	160	160	160
- per probe	40	40	40	40
Controller				
• PID_Compact	Yes; Universal PID controller with integrated optimization	Yes; Universal PID controller with integrated optimization	Yes; Universal PID controller with integrated optimization	Yes; Universal PID controller with integrated optimization
• PID_3Step	Yes; PID controller with integrated optimization for valves	Yes; PID controller with integrated optimization for valves	Yes; PID controller with integrated optimization for valves	Yes; PID controller with integrated optimization for valves
• PID-Temp	Yes; PID controller with integrated optimization for temperature	Yes; PID controller with integrated optimization for temperature	Yes; PID controller with integrated optimization for temperature	Yes; PID controller with integrated optimization for temperature
Counting and measuring				
• High-speed counter	Yes	Yes	Yes	Yes

Technical specifications (continued)

Article number	6ES7511-1TK01-0AB0 CPU 1511T-1PN, 225KB prog., 1MB data	6ES7515-2TM01-0AB0 CPU 1515T-2 PN, 750KB prog., 3MB data	6ES7517-3TP00-0AB0 CPU 1517T-3 PN/DP, 3MB prog., 8MB data	6ES7517-3UP00-0AB0 CPU 1517TF-3 PN/DP, 3MB prog., 8MB data
Highest safety class achievable in safety mode				
Probability of failure (for service life of 20 years and repair time of 100 hours)				
- Low demand mode: PFDavg in accordance with SIL3				< 2.00E-05
- High demand/continuous mode: PFH in accordance with SIL3				< 1.00E-09 1/h
Ambient conditions				
Ambient temperature during operation				
• horizontal installation, min.	0 °C	0 °C	0 °C	0 °C
• horizontal installation, max.	60 °C; Display: 50 °C, at an operating temperature of typically 50 °C, the display is switched off	60 °C; Display: 50 °C, at an operating temperature of typically 50 °C, the display is switched off	60 °C; Display: 50 °C, at an operating temperature of typically 50 °C, the display is switched off	60 °C; Display: 50 °C, at an operating temperature of typically 50 °C, the display is switched off
• vertical installation, min.	0 °C	0 °C	0 °C	0 °C
• vertical installation, max.	40 °C; Display: 40 °C, at an operating temperature of typically 40 °C, the display is switched off	40 °C; Display: 40 °C, at an operating temperature of typically 40 °C, the display is switched off	40 °C; Display: 40 °C, at an operating temperature of typically 40 °C, the display is switched off	40 °C; Display: 40 °C, at an operating temperature of typically 40 °C, the display is switched off
Configuration				
Programming				
Programming language				
- LAD	Yes	Yes	Yes	Yes; incl. failsafe
- FBD	Yes	Yes	Yes	Yes; incl. failsafe
- STL	Yes	Yes	Yes	Yes
- SCL	Yes	Yes	Yes	Yes
- GRAPH	Yes	Yes	Yes	Yes
Know-how protection				
• User program protection/password protection	Yes	Yes	Yes	Yes
• Copy protection	Yes	Yes	Yes	Yes
• Block protection	Yes	Yes	Yes	Yes
Access protection				
• Password for display	Yes	Yes	Yes	Yes
• Protection level: Write protection	Yes	Yes	Yes	Yes
• Protection level: Read/write protection	Yes	Yes	Yes	Yes
• Protection level: Complete protection	Yes	Yes	Yes	Yes
Dimensions				
Width	35 mm	70 mm	175 mm	175 mm
Height	147 mm	147 mm	147 mm	147 mm
Depth	129 mm	129 mm	129 mm	129 mm
Weights				
Weight, approx.	430 g	830 g	1 978 g	1 978 g

SIMATIC S7-1500 Advanced Controllers

Central processing units

Technology CPUs

Ordering data	Article No.	Ordering data	Article No.
CPU 1511T-1 PN Work memory 225 KB for program, 1 MB for data, PROFINET IO IRT interface; SIMATIC Memory Card required	6ES7511-1TK01-0AB0	Load power supply 24 V DC/3A 24 V DC/8A	6EP1332-4BA00 6EP1333-4BA00
CPU 1515T-2 PN Work memory 750 KB for program, 3 MB for data, PROFINET IO IRT interface, PROFINET interface; SIMATIC Memory Card required	6ES7515-2TM01-0AB0	Power supply connector Spare part; for connecting the 24 V DC supply voltage • with push-in terminals	6ES7193-4JB00-0AA0
CPU 1517T-3 PN/DP 3 MB work memory for program, 8 MB for data, PROFINET IO IRT interface, PROFINET/PROFIBUS interface; SIMATIC Memory Card required	6ES7517-3TP00-0AB0	PROFIBUS FastConnect RS 485 bus connector with 90° cable outlet With insulation displacement, max. transmission rate 12 Mbps Without PG interface, grounding via control cabinet contact surface; 1 unit	6ES7972-0BA70-0XA0
CPU 1517T-3 PN/DP 3 MB work memory for program, 8 MB for data, PROFINET IO IRT interface, PROFINET/PROFIBUS interface; SIMATIC Memory Card required	6ES7517-3UP00-0AB0	With PG interface, grounding via control cabinet contact surface; 1 unit	6ES7972-0BB70-0XA0
Accessories		PROFIBUS FC Standard Cable GP Standard type with special design for fast mounting, 2-wire, shielded; sold by the meter; max. delivery unit 1000 m, minimum order quantity 20 m	6XV1830-0EH10
SIMATIC Memory Card		PROFIBUS FC Robust Cable 2-wire, shielded; sold by the meter; max. delivery unit 1000 m, minimum order quantity 20 m	6XV1830-0JH10
4 MB 12 MB 24 MB 256 MB 2 GB 32 GB	6ES7954-8LC02-0AA0 6ES7954-8LE02-0AA0 6ES7954-8LF02-0AA0 6ES7954-8LL02-0AA0 6ES7954-8LP02-0AA0 6ES7954-8LT03-0AA0	PROFIBUS FC Flexible Cable 2-wire, shielded; sold by the meter; max. delivery unit 1000 m, minimum order quantity 20 m	6XV1831-2K
SIMATIC S7-1500 DIN rail Fixed lengths, with grounding elements • 160 mm • 245 mm • 482 mm • 530 mm • 830 mm For cutting to length by customer, without drill holes; grounding elements must be ordered separately • 2000 mm	6ES7590-1AB60-0AA0 6ES7590-1AC40-0AA0 6ES7590-1AE80-0AA0 6ES7590-1AF30-0AA0 6ES7590-1AJ30-0AA0 6ES7590-1BC00-0AA0	PROFIBUS FC Trailing Cable 2-wire, shielded; sold by the meter; max. delivery unit 1000 m, minimum order quantity 20 m Sheath color: Petrol Sheath color: Violet	6XV1830-3EH10 6XV1831-2L
PE connection element for DIN rail 2000 mm 20 units	6ES7590-5AA00-0AA0	PROFIBUS FC Food Cable 2-wire, shielded; sold by the meter; max. delivery unit 1000 m, minimum order quantity 20 m	6XV1830-0GH10
Power supply For supplying the backplane bus of the S7-1500 24 V DC input voltage, power 25 W 24/48/60 V DC input voltage, power 60 W 24/48/60 V DC input voltage, power 60 W, buffering functionality 120/230 V AC input voltage, power 60 W	6ES7505-0KA00-0AB0 6ES7505-0RA00-0AB0 6ES7505-0RB00-0AB0 6ES7507-0RA00-0AB0	PROFIBUS FC Ground Cable 2-wire, shielded; sold by the meter; max. delivery unit 1000 m, minimum order quantity 20 m	6XV1830-3FH10
Power connector With coding element for power supply module; spare part, 10 units	6ES7590-8AA00-0AA0	PROFIBUS FC FRNC Cable GP 2-wire, shielded, flame-retardant, with copolymer outer sheath FRNC; sold by the meter; max. delivery unit 1000 m, minimum order quantity 20 m	6XV1830-0LH10
		PROFIBUS FastConnect Stripping Tool Preadjusted stripping tool for fast stripping of PROFIBUS FastConnect bus cables	6GK1905-6AA00

4

Ordering data	Article No.	Article No.
IE FC RJ45 plugs RJ45 plug connector for Industrial Ethernet with a rugged metal enclosure and integrated insulation displacement contacts for connecting Industrial Ethernet FC installation cables		
IE FC RJ45 Plug 180 180° cable outlet 1 unit 10 units 50 units	6GK1901-1BB10-2AA0 6GK1901-1BB10-2AB0 6GK1901-1BB10-2AE0	
IE FC TP Standard Cable GP 2x2 4-wire, shielded TP installation cable for connection to IE FC outlet RJ45/ IE FC RJ45 plug; PROFINET-compatible; with UL approval; sold by the meter; max. delivery unit 1000 m, minimum order quantity 20 m	6XV1840-2AH10	
IE FC TP Trailing Cable 2 x 2 (Type C) 4-wire, shielded TP installation cable for connection to IE FC outlet RJ45/ IE FC RJ45 Plug 180/90 for use as trailing cable; PROFINET-compatible; with UL approval; sold by the meter; max. delivery unit 1000 m, minimum order quantity 20 m	6XV1840-3AH10	
IE FC TP Marine Cable 2 x 2 (Type B) 4-wire, shielded TP installation cable for connection to IE FC outlet RJ45/ IE FC RJ45 Plug 180/90 with marine approval, sold by the meter; max. delivery unit 1000 m, minimum order quantity 20 m	6XV1840-4AH10	
IE FC Stripping Tool Preadjusted stripping tool for fast stripping of Industrial Ethernet FC cables	6GK1901-1GA00	
Display For CPU 1511T-1 PN; spare part For CPU 1515T-2 PN, CPU 1517T-3 PN/DP and CPU 1517TF-3 PN/DP; spare part	6ES7591-1AA01-0AA0 6ES7591-1BA01-0AA0	
Front cover for PROFIBUS DP interface For CPU 1517T-3 PN/DP and CPU 1517TF-3 PN/DP; spare part	6ES7591-8AA00-0AA0	
SIMATIC S7-1500 Starter Kit Comprising: CPU 1511C-1 PN, SIMATIC Memory Card 4 MB, 160 mm DIN rail, front connector, STEP 7 Professional 365-day license, PM 70 W 120/230 V AC power supply, Ethernet cable, documentation	6ES7511-1CK00-4YB5	
STEP 7 Professional V14 SP1 Target system: SIMATIC S7-1200, S7-1500, S7-300, S7-400, WinAC Requirement: Windows 7 Professional SP1 (64-bit), Windows 7 Enterprise SP1 (64-bit), Windows 7 Ultimate SP1 (64-bit), Windows 8.1 Professional (64-bit), Windows 8.1 Enterprise (64-bit), Windows 10 Professional Version 1607, Windows 10 Enterprise Version 1607, Windows 10 Enterprise 2016 LTSB, Windows 10 Enterprise 2015 LTSB, Windows Server 2008 R2 StdE (full installation), Windows Server 2012 StdE (full installation), Windows Server 2016 Standard (full installation); Type of delivery: English, German, Chinese, Italian, French, Spanish STEP 7 Professional V14 SP1, floating license STEP 7 Professional V14 SP1, floating license, software download incl. license key ¹⁾ Email address required for delivery		6ES7822-1AA04-0YA5 6ES7822-1AE04-0YA5
STEP 7 Safety Advanced V14 SP1 Task: Engineering tool for configuring and programming fail-safe user programs for SIMATIC S7-1200 FC, S7-1500F, S7-1500F Software Controller, S7-300F, S7-400F, WinAC RTX F, ET 200SP F Controller and the fail-safe ET 200SP, ET 200S, ET 200M, ET 200iSP, ET 200pro and ET 200eco I/O Requirement: STEP 7 Professional V14 SP1 Floating license for 1 user, software and documentation on DVD, license key on USB flash drive Floating license for 1 user, software, documentation and license key for download ¹⁾ ; email address required for delivery		6ES7833-1FA14-0YA5 6ES7833-1FA14-0YH5
SIMATIC Manual Collection Electronic manuals on DVD, multi-language: LOGO!, SIMADYN, SIMATIC bus components, SIMATIC C7, SIMATIC distributed I/O, SIMATIC HMI, SIMATIC Sensors, SIMATIC NET, SIMATIC PC Based Automation, SIMATIC PCS 7, SIMATIC PG/PC, SIMATIC S7, SIMATIC Software, SIMATIC TDC		6ES7998-8XC01-8YE0
SIMATIC Manual Collection update service for 1 year Current "Manual Collection" DVD and the three subsequent updates		6ES7998-8XC01-8YE2

¹⁾ For up-to-date information and download availability, see: <http://www.siemens.com/tia-online-software-delivery>

SIMATIC S7-1500 Advanced Controllers

I/O modules

Digital modules

SM 521 digital input modules

Overview



- 16 and 32-channel digital input modules
- For flexible adaptation of the controller to the corresponding task
- For subsequent expansion of the system with additional inputs
- 35 mm wide modules with parameters and diagnostic functions
- 25 mm wide modules for use in tight spaces: particularly economical, without parameters or diagnostic functions

4

Technical specifications

Article number	6ES7521-1BH00-0AB0	6ES7521-1BL00-0AB0	6ES7521-1BH50-0AA0	6ES7521-1FH00-0AA0	6ES7521-7EH00-0AB0
	S7-1500, DI 16X24VDC HF	S7-1500, DI 32X24VDC HF	S7-1500, DI 16X24VDC SRC BA	S7-1500, DI 16X230VAC BA	S7-1500, DI 16 X 24...125V UC HF
General information					
Product type designation	DI 16x24VDC HF	DI 32x24VDC HF	DI 16x24VDC SRC BA	DI 16x230VAC BA	DI 16x24 ... 125VUC HF
Product function					
• I&M data	Yes; I&M0 to I&M3	Yes; I&M0 to I&M3	Yes; I&M0 to I&M3	Yes; I&M0 to I&M3	Yes; I&M0 to I&M3
Engineering with					
• STEP 7 TIA Portal configurable/integrated as of version	V13 SP1 / -	V13 SP1 / -	V12 / V12	V12 / V12	V13 SP1 / -
• STEP 7 configurable/integrated as of version	V5.5 SP3 / -	V5.5 SP3 / -	V5.5 SP3 / -	V5.5 SP3 / -	V5.5 SP3 / -
• PROFIBUS as of GSD version/GSD revision	V1.0 / V5.1	V1.0 / V5.1	V1.0 / V5.1	V1.0 / V5.1	V1.0 / V5.1
• PROFINET as of GSD version/GSD revision	V2.3 / -	V2.3 / -	V2.3 / -	V2.3 / -	V2.3 / -
Operating mode					
• DI	Yes	Yes	Yes	Yes	Yes
• Counter	Yes	Yes	No	No	No
• Oversampling	No	No	No	No	No
• MSI	Yes	Yes	Yes	Yes	Yes
Supply voltage					
Type of supply voltage	DC	DC	DC		
Rated value (DC)	24 V	24 V			
Reverse polarity protection	Yes	Yes			
Digital inputs					
Number of digital inputs	16	32	16	16	16
Digital inputs, parameterizable	Yes	Yes	No	No	Yes
Source/sink input	P-reading	P-reading	m-reading	P-reading	Yes
Input characteristic curve in accordance with IEC 61131, type 1				Yes	
Input characteristic curve in accordance with IEC 61131, type 3	Yes	Yes	Yes		Yes; at 24 V DC
Digital input functions, parameterizable					
• Gate start/stop	Yes	Yes			
• Freely usable digital input	Yes	Yes			
• Counter					
- Number, max.	2	2			
- Counting frequency, max.	1 kHz	1 kHz			
- Counting width	32 bit	32 bit			
- Counting direction up/down	Up	Up			

Technical specifications (continued)

Article number	6ES7521-1BH00-0AB0 S7-1500, DI 16X24VDC HF	6ES7521-1BL00-0AB0 S7-1500, DI 32X24VDC HF	6ES7521-1BH50-0AA0 S7-1500, DI 16X24VDC SRC BA	6ES7521-1FH00-0AA0 S7-1500, DI 16X230VAC BA	6ES7521-7EH00-0AB0 S7-1500, DI 16 X 24...125V UC HF
Input voltage					
• Type of input voltage	DC	DC	DC	AC	AC/DC
• Rated value (DC)	24 V	24 V	24 V		24 V; 48 V, 125 V
• Rated value (AC)				230 V; 120/230V AC, 50/60 Hz	24 V; 48 V, 125 V (50 - 60 Hz)
• for signal "0"	-30 to +5V	-30 to +5V	-5 to +30V	0V AC to 40V AC	-5 ... +5 V
• for signal "1"	+11 to +30V	+11 to +30V	-11 to -30V	79V AC to 264V AC	+11 V DC to +146 V DC
Input current					
• for signal "1", typ.	2.5 mA	2.5 mA	4.5 mA	11 mA; At 230 V AC and 5.5 mA at 120 V AC	3 mA; at 24 V DC
Input delay (for rated value of input voltage) for standard inputs					
- parameterizable	Yes; 0.05 / 0.1 / 0.4 / 1.6 / 3.2 / 12.8 / 20 ms	Yes; 0.05 / 0.1 / 0.4 / 1.6 / 3.2 / 12.8 / 20 ms	No	No	Yes; 0.05 / 0.1 / 0.4 / 1.6 / 3.2 / 12.8 / 20 ms parameterizable with DC, 20 ms fixed with AC
for interrupt inputs					
- parameterizable	Yes	Yes	No	No	Yes
for counter/technological functions					
- parameterizable	Yes	Yes	No	No	No
Cable length					
• shielded, max.	1 000 m	1 000 m	1 000 m	1 000 m	1 000 m
• unshielded, max.	600 m	600 m	600 m	600 m	600 m
Encoder					
Connectable encoders					
• 2-wire sensor	Yes	Yes	Yes	Yes	Yes
- permissible quiescent current (2-wire sensor), max.	1.5 mA	1.5 mA	1.5 mA	2 mA	1.5 mA
Isochronous mode					
Isochronous operation (application synchronized up to terminal)	Yes	Yes	No	No	No
Filtering and processing time (TCI), min.	80 µs; At 50 µs filter time	80 µs; At 50 µs filter time			
Bus cycle time (TDP), min.	250 µs	250 µs			
Interrupts/diagnostics/ status information					
Diagnostics function	Yes	Yes	No	No	Yes
Alarms					
• Diagnostic alarm	Yes	Yes	No	No	Yes
• Hardware interrupt	Yes	Yes	No	No	Yes
Diagnostic messages					
• Monitoring the supply voltage	Yes	Yes	No	No	No
• Wire-break	Yes; to I < 350 µA	Yes; to I < 350 µA	No	No	Yes; To I < 550 µA
• Short-circuit	No	No	No	No	No
Diagnostics indication LED					
• RUN LED	Yes; Green LED	Yes; Green LED	Yes; Green LED	Yes; Green LED	Yes; Green LED
• ERROR LED	Yes; Red LED	Yes; Red LED	Yes; Red LED	Yes; Red LED	Yes; Red LED
• Monitoring of the supply voltage (PWR-LED)	Yes; Green LED	Yes; Green LED	No	No	No
• Channel status display	Yes; Green LED	Yes; Green LED	Yes; Green LED	Yes; Green LED	Yes; Green LED
• for channel diagnostics	Yes; Red LED	Yes; Red LED	No	No	Yes; Red LED
• for module diagnostics	Yes; Red LED	Yes; Red LED	No	Yes; Red LED	Yes; Red LED
Potential separation					
Potential separation channels					
• between the channels and backplane bus	Yes	Yes	Yes	Yes	Yes
Isolation					
Isolation tested with	707 V DC (type test)	707 V DC (type test)	707 V DC (type test)	3 100 V DC	2 000 V DC

SIMATIC S7-1500 Advanced Controllers

I/O modules

Digital modules

SM 521 digital input modules

Technical specifications (continued)

Article number	6ES7521-1BH00-0AB0 S7-1500, DI 16X24VDC HF	6ES7521-1BL00-0AB0 S7-1500, DI 32X24VDC HF	6ES7521-1BH50-0AA0 S7-1500, DI 16X24VDC SRC BA	6ES7521-1FH00-0AA0 S7-1500, DI 16X230VAC BA	6ES7521-7EH00-0AB0 S7-1500, DI 16 X 24...125V UC HF
Standards, approvals, certificates					
Suitable for safety functions	No	No	No	No	No
Ambient conditions					
Ambient temperature during operation					
• horizontal installation, min.	0 °C	0 °C	0 °C	0 °C	0 °C
• horizontal installation, max.	60 °C	60 °C	60 °C	60 °C	60 °C
• vertical installation, min.	0 °C	0 °C	0 °C	0 °C	0 °C
• vertical installation, max.	40 °C	40 °C	40 °C	40 °C	40 °C
Decentralized operation					
Prioritized startup	Yes	Yes	Yes	Yes	Yes
Dimensions					
Width	35 mm	35 mm	35 mm	35 mm	35 mm
Height	147 mm	147 mm	147 mm	147 mm	147 mm
Depth	129 mm	129 mm	129 mm	129 mm	129 mm
Weights					
Weight, approx.	240 g	260 g	230 g	300 g	240 g
Article number	6ES7521-1BH10-0AA0 S7-1500, DI 16X24VDC BA		6ES7521-1BL10-0AA0 S7-1500, DI 32X24VDC BA		
General information					
Product type designation	DI 16 x 24 V DC BA		DI 32x24VDC BA		
Product function					
• I&M data	Yes; I&M0 to I&M3		Yes; I&M0 to I&M3		
Engineering with					
• STEP 7 TIA Portal configurable/ integrated as of version	V13 / V13		V13 / V13		
• STEP 7 configurable/integrated as of version	V5.5 SP3 / -		V5.5 SP3 / -		
• PROFIBUS as of GSD version/ GSD revision	V1.0 / V5.1		V1.0 / V5.1		
• PROFINET as of GSD version/ GSD revision	V2.3 / -		V2.3 / -		
Operating mode					
• DI	Yes		Yes		
• Counter	No		No		
• MSI	Yes		Yes		
Supply voltage					
Type of supply voltage	DC		DC		
Rated value (DC)	24 V		24 V		
Digital inputs					
Number of digital inputs	16		32		
Digital inputs, parameterizable	No		No		
Source/sink input	P-reading		P-reading		
Input characteristic curve in accordance with IEC 61131, type 3	Yes		Yes		
Input voltage					
• Type of input voltage	DC		DC		
• Rated value (DC)	24 V		24 V		
• for signal "0"	-30 to +5V		-30 to +5V		
• for signal "1"	+11 to +30V		+11 to +30V		
Input current					
• for signal "1", typ.	2.7 mA		2.7 mA		
Input delay (for rated value of input voltage)					
for standard inputs					
- parameterizable	No		No		
for interrupt inputs					
- parameterizable	No		No		
for counter/technological functions					
- parameterizable	No		No		

Technical specifications (continued)

Article number	6ES7521-1BH10-0AA0 S7-1500, DI 16X24VDC BA	6ES7521-1BL10-0AA0 S7-1500, DI 32X24VDC BA
Cable length		
• shielded, max.	1 000 m	1 000 m
• unshielded, max.	600 m	600 m
Encoder		
Connectable encoders		
• 2-wire sensor	Yes	Yes
- permissible quiescent current (2-wire sensor), max.	1.5 mA	1.5 mA
Isochronous mode		
Isochronous operation (application synchronized up to terminal)	No	No
Interrupts/diagnostics/status information		
Diagnostics function	No	No
Alarms		
• Diagnostic alarm	No	No
• Hardware interrupt	No	No
Diagnostic messages		
• Monitoring the supply voltage	No	No
• Wire-break	No	No
• Short-circuit	No	No
Diagnostics indication LED		
• RUN LED	Yes; Green LED	Yes; Green LED
• ERROR LED	Yes; Red LED	Yes; Red LED
• Monitoring of the supply voltage (PWR-LED)	No	No
• Channel status display	Yes; Green LED	Yes; Green LED
• for channel diagnostics	No	No
• for module diagnostics	No	No
Potential separation		
Potential separation channels		
• between the channels and backplane bus	Yes	Yes
Isolation		
Isolation tested with	707 V DC (type test)	707 V DC (type test)
Standards, approvals, certificates		
Suitable for safety functions	No	No
Ambient conditions		
Ambient temperature during operation		
• horizontal installation, min.	0 °C	0 °C
• horizontal installation, max.	60 °C	60 °C
• vertical installation, min.	0 °C	0 °C
• vertical installation, max.	40 °C	40 °C
Decentralized operation		
Prioritized startup	Yes	Yes
Dimensions		
Width	25 mm	25 mm
Height	147 mm	147 mm
Depth	129 mm	129 mm
Weights		
Weight, approx.	230 g	260 g
Other		
Note:	Supplied incl. 40-pole push-in front connectors	Supplied incl. 40-pole push-in front connectors

SIMATIC S7-1500 Advanced Controllers

I/O modules

Digital modules

SM 521 digital input modules

Ordering data

SM 521 digital input modules

Module width 35 mm

16 inputs, 24 V DC, isolated, parameterizable diagnostics and hardware interrupts

6ES7521-1BH00-0AB0

32 inputs, 24 V DC, isolated, parameterizable diagnostics and hardware interrupts

6ES7521-1BL00-0AB0

16 inputs, 24 V DC, isolated, input delay 3.2 ms

6ES7521-1BH50-0AA0

16 inputs, 230 V AC, isolated, input delay 20 ms

6ES7521-1FH00-0AA0

16 inputs, 24 ... 125 V UC, input delay 0.05 ... 20 ms, parameterizable diagnostics and hardware interrupts

6ES7521-7EH00-0AB0

Module width 25 mm; front connector (push-in) included in delivery package

16 inputs, 24 V DC, isolated

6ES7521-1BH10-0AA0

32 inputs, 24 V DC, isolated

6ES7521-1BL10-0AA0

Accessories

Front connectors

For 35 mm modules; including four potential bridges, cable ties and individual labeling strips, 40-pin

- Screw terminals
- Push-in

6ES7592-1AM00-0XB0

6ES7592-1BM00-0XB0

For 25 mm modules; including cable ties and individual labeling strips; push-in terminal 40-pin; spare part

6ES7592-1BM00-0XA0

Potential bridges for front connectors

6ES7592-3AA00-0AA0

For 35 mm modules; 20 pieces; spare part

Article No.

DIN A4 labeling sheets

For 35 mm modules; 10 sheets with 10 labeling strips each for I/O modules; perforated, AI gray

6ES7592-2AX00-0AA0

For 25 mm modules; 10 sheets with 20 labeling strips each for I/O modules; perforated, AI gray

6ES7592-1AX00-0AA0

U connector

5 units; spare part

6ES7590-0AA00-0AA0

Universal front door for I/O modules

For 35 mm modules; 5 front doors; with 5 labeling strips (front) and 5 cabling diagrams per front door; spare part

6ES7528-0AA00-7AA0

For 25 mm modules; 5 front doors; with 5 labeling strips (front) and 5 cabling diagrams per front door; spare part

6ES7528-0AA00-0AA0

SIMATIC Manual Collection

Electronic manuals on DVD, multi-language: LOGO!, SIMADYN, SIMATIC bus components, SIMATIC C7, SIMATIC distributed I/O, SIMATIC HMI, SIMATIC Sensors, SIMATIC NET, SIMATIC PC Based Automation, SIMATIC PCS 7, SIMATIC PG/PC, SIMATIC S7, SIMATIC Software, SIMATIC TDC

6ES7998-8XC01-8YE0

SIMATIC Manual Collection update service for 1 year

Current "Manual Collection" DVD and the three subsequent updates

6ES7998-8XC01-8YE2

Overview



- 8, 16 and 32-channel digital output modules
- For flexible adaptation of the controller to the corresponding task
- For subsequent expansion of the system with additional outputs
- 35 mm wide modules with parameters and diagnostic functions
- 25 mm wide modules for use in tight spaces: particularly economical, without parameters or diagnostic functions

Technical specifications

Article number	6ES7522-1BH01-0AB0 S7-1500, DQ 16X24V DC/ 0.5A HF	6ES7522-1BL01-0AB0 S7-1500, DQ 32X24VDC/ 0.5A HF	6ES7522-1BF00-0AB0 S7-1500, DQ 8X24VDC/2A HF	6ES7522-5EH00-0AB0 S7-1500, DQ 16X24...48VUC/125VDC/ 0.5A ST
General information				
Product type designation	DQ 16x24VDC/0.5A HF	DQ 32x24VDC/0.5A HF	DQ 8x24VDC/2A HF	DQ 16x24 ... 48VUC/ 125VDC/0.5A ST
Product function				
• I&M data	Yes; I&M0 to I&M3	Yes; I&M0 to I&M3	Yes; I&M0 to I&M3	Yes; I&M0 to I&M3
Engineering with				
• STEP 7 TIA Portal configurable/ integrated as of version	V13 SP1 / -	V13 SP1 / -	V13 SP1 / -	V13 SP1 / -
• STEP 7 configurable/integrated as of version			V5.5 SP3 / -	V5.5 SP3 / -
• PROFIBUS as of GSD version/ GSD revision	V1.0 / V5.1	V1.0 / V5.1	V1.0 / V5.1	V1.0 / V5.1
• PROFINET as of GSD version/ GSD revision	V2.3 / -	V2.3 / -	V2.3 / -	V2.3 / -
Operating mode				
• DQ	Yes	Yes	Yes	Yes
• DQ with energy-saving function	No	No	Yes; with an application	No
• PWM	No	No	Yes	No
• Oversampling	No	No	No	No
• MSO	Yes	Yes	Yes	Yes
Supply voltage				
Type of supply voltage	DC	DC	DC	
Rated value (DC)	24 V	24 V	24 V	
Reverse polarity protection	Yes; through internal protection with 7 A per group	Yes; through internal protection with 7 A per group	Yes; through internal protection with 10 A per group	
Digital outputs				
Type of digital output	Transistor	Transistor	Transistor	Transistor
Number of digital outputs	16	32	8	16
Current-sinking				Yes
Current-sourcing	Yes	Yes	Yes	Yes
Digital outputs, parameterizable	Yes	Yes	Yes	Yes
Short-circuit protection	Yes; Clocked electronically	Yes; Clocked electronically	Yes	
Limitation of inductive shutdown voltage to	L+ (-53 V)	L+ (-53 V)	-17 V	200 V (suppressor diode)
Controlling a digital input	Yes	Yes	Yes	Yes
Digital output functions, parameterizable				
• Freely usable digital output			Yes	
• PWM output			Yes	
- Number, max.			2	
- Cycle duration, parameterizable			Yes; 2 ... 100 ms continuous	

SIMATIC S7-1500 Advanced Controllers

I/O modules

Digital modules

SM 522 digital output modules

Technical specifications (continued)

Article number	6ES7522-1BH01-0AB0 S7-1500, DQ 16X24V DC/ 0.5A HF	6ES7522-1BL01-0AB0 S7-1500, DQ 32X24VDC/ 0.5A HF	6ES7522-1BF00-0AB0 S7-1500, DQ 8X24VDC/2A HF	6ES7522-5EH00-0AB0 S7-1500, DQ 16X24...48VUC/125VDC/ 0.5A ST
Switching capacity of the outputs				
• with resistive load, max.	0.5 A	0.5 A		0.5 A
• on lamp load, max.	5 W	5 W	10 W	40 W; At 125 V DC, 10 W at 48 V UC, 5 W at 24 V UC
Load resistance range				
• lower limit	48 Ω	48 Ω	12 Ω	
• upper limit	12 kΩ	12 kΩ	4 kΩ	
Output voltage				
• Type of output voltage	DC	DC	DC	UC
• for signal "1", min.	L+ (-0.8 V)	L+ (-0.8 V)	L+ (-0.8 V)	L+ (-1.0 V)
Output current				
• for signal "1" rated value	0.5 A	0.5 A	2 A	0.5 A
• for signal "0" residual current, max.	0.5 mA	0.5 mA	0.5 mA	
Output delay with resistive load				
• "0" to "1", typ.			80 μs	
• "0" to "1", max.	100 μs	100 μs	100 μs	5 ms
• "1" to "0", typ.			300 μs	
• "1" to "0", max.	500 μs	500 μs	500 μs	5 ms
Parallel switching of two outputs				
• for logic links	Yes	Yes	Yes	Yes
• for uprating	No	No	No	No
• for redundant control of a load	Yes	Yes	Yes	Yes
Switching frequency				
• with resistive load, max.	100 Hz	100 Hz	100 Hz; With PWM operation: 500 Hz	25 Hz
• with inductive load, max.	0.5 Hz; According to IEC 60947-5-1, DC-13	0.5 Hz; According to IEC 60947-5-1, DC-13	0.5 Hz; According to IEC 60947-5-1, DC-13; max. 500 Hz with PWM operation only with external circuit; see additional description in the manual	0.5 Hz
• on lamp load, max.	10 Hz	10 Hz	10 Hz	10 Hz
Total current of the outputs				
• Current per channel, max.	0.5 A; see additional description in the manual	0.5 A; see additional description in the manual	2 A; see additional description in the manual	0.5 A
• Current per group, max.	4 A; see additional description in the manual	4 A; see additional description in the manual	8 A; see additional description in the manual	0.5 A
• Current per module, max.	8 A; see additional description in the manual	16 A; see additional description in the manual	16 A; see additional description in the manual	8 A
Cable length				
• shielded, max.	1 000 m	1 000 m	1 000 m	1 000 m
• unshielded, max.	600 m	600 m	600 m	600 m
Isochronous mode				
Isochronous operation (application synchronized up to terminal)	Yes	Yes	No	No
Execution and activation time (TCO), min.	70 μs	70 μs		
Bus cycle time (TDP), min.	250 μs	250 μs		
Interrupts/diagnostics/status infor- mation				
Diagnostics function	Yes	Yes	Yes	No
Substitute values connectable	Yes	Yes	Yes	Yes
Alarms				
• Diagnostic alarm	Yes	Yes	Yes	No
Diagnostic messages				
• Monitoring the supply voltage	Yes	Yes	Yes	No
• Wire-break	Yes	Yes	No	No
• Short-circuit	Yes	Yes	Yes	No
• Group error	Yes	Yes	Yes	

Technical specifications (continued)

Article number	6ES7522-1BH01-0AB0 S7-1500, DQ 16X24V DC/ 0.5A HF	6ES7522-1BL01-0AB0 S7-1500, DQ 32X24VDC/ 0.5A HF	6ES7522-1BF00-0AB0 S7-1500, DQ 8X24VDC/2A HF	6ES7522-5EH00-0AB0 S7-1500, DQ 16X24...48VUC/125VDC/ 0.5A ST
Diagnostics indication LED				
• RUN LED	Yes; Green LED	Yes; Green LED	Yes; Green LED	Yes; Green LED
• ERROR LED	Yes; Red LED	Yes; Red LED	Yes; Red LED	Yes; Red LED
• Monitoring of the supply voltage (PWR-LED)	Yes; Green LED	Yes; Green LED	Yes; Green LED	No
• Channel status display	Yes; Green LED	Yes; Green LED	Yes; Green LED	Yes; Green LED
• for channel diagnostics	Yes; Red LED	Yes; Red LED	Yes; Red LED	No
• for module diagnostics	Yes; Red LED	Yes; Red LED	Yes; Red LED	Yes; Red LED
Potential separation				
Potential separation channels				
• between the channels and backplane bus	Yes	Yes	Yes	Yes
Isolation				
Isolation tested with	707 V DC (type test)	707 V DC (type test)	707 V DC (type test)	2 000 V DC
Standards, approvals, certificates				
Suitable for safety functions	No	No	No	No
Ambient conditions				
Ambient temperature during operation				
• horizontal installation, min.	0 °C			0 °C
• horizontal installation, max.	60 °C			60 °C
• vertical installation, min.	0 °C			0 °C
• vertical installation, max.	60 °C			40 °C
Decentralized operation				
Prioritized startup	Yes	Yes	Yes	Yes
Dimensions				
Width	35 mm	35 mm	35 mm	35 mm
Height	147 mm	147 mm	147 mm	147 mm
Depth	129 mm	129 mm	129 mm	129 mm
Weights				
Weight, approx.	230 g	280 g	240 g	230 g
Article number	6ES7522-5HF00-0AB0 S7-1500, DQ 8X230VAC/5A ST (RELAY)	6ES7522-5HH00-0AB0 S7-1500, DQ 16X230VAC/2A ST (RELAY)	6ES7522-5FF00-0AB0 S7-1500, DQ 8X230VAC/2A ST (TRIAC)	6ES7522-5FH00-0AB0 S7-1500, DQ 16X230VAC/1A ST (TRIAC)
General information				
Product type designation	DQ 8x230 V AC/5 A ST (relay)	DQ 16x230VAC/2A ST (relay)	DQ 8x230 V AC/2A ST (triac)	DQ 16x230VAC/1A ST (Triac)
Product function				
• I&M data	Yes; I&M0 to I&M3	Yes; I&M0 to I&M3	Yes; I&M0 to I&M3	Yes; I&M0 to I&M3
Engineering with				
• STEP 7 TIA Portal configurable/integrated as of version	V12 / V12	V13 SP1 / -	V12 / V12	V13 SP1 / -
• STEP 7 configurable/integrated as of version	V5.5 SP3 / -	V5.5 SP3 / -	V5.5 SP3 / -	V5.5 SP3 / -
• PROFIBUS as of GSD version/GSD revision	V1.0 / V5.1	V1.0 / V5.1	V1.0 / V5.1	V1.0 / V5.1
• PROFINET as of GSD version/GSD revision	V2.3 / -	V2.3 / -	V2.3 / -	V2.3 / -
Operating mode				
• DQ	Yes	Yes	Yes	Yes
• DQ with energy-saving function	No	No	No	No
• PWM	No	No	No	No
• Oversampling	No	No	No	No
• MSO	Yes	Yes	Yes	Yes
Supply voltage				
Type of supply voltage	DC	DC		
Rated value (DC)	24 V	24 V		
Reverse polarity protection	Yes	Yes		

SIMATIC S7-1500 Advanced Controllers

I/O modules

Digital modules

SM 522 digital output modules

Technical specifications (continued)

Article number	6ES7522-5HF00-0AB0 S7-1500, DQ 8X230VAC/5A ST (RELAY)	6ES7522-5HH00-0AB0 S7-1500, DQ 16X230VAC/2A ST (RELAY)	6ES7522-5FF00-0AB0 S7-1500, DQ 8X230VAC/2A ST (TRIAC)	6ES7522-5FH00-0AB0 S7-1500, DQ 16X230VAC/1A ST (TRIAC)
Digital outputs				
Type of digital output	Relays	Relays	Triac	Triac
Number of digital outputs	8	16	8	16
Current-sinking	Yes	Yes		Yes
Current-sourcing	Yes	Yes	Yes	Yes
Digital outputs, parameterizable	Yes	Yes	Yes	Yes
Short-circuit protection	No	No	No	No
Controlling a digital input	possible	Yes		
Switching capacity of the outputs				
• with resistive load, max.			2 A	1 A
• on lamp load, max.	1 500 W; 10 000 operating cycles	50 W (230 V AC), 5 W (24 V DC)	50 W	50 W
• Low energy/fluorescent lamps with electronic control gear	10x 58 W (25 000 operating cycles)			
• Fluorescent tubes, conventionally compensated	1x 58 W (25 000 operating cycles)			
• Fluorescent tubes, uncompensated	10x 58 W (25 000 operating cycles)			
Output voltage				
• Type of output voltage			AC	AC
• for signal "1", min.			L1 (-1.5 V) at maximum output current; L1 (-8.5 V) at minimum output current	L1 (-1.5 V) at maximum output current; L1 (-8.5 V) at minimum output current
Output current				
• for signal "1" rated value	5 A	2 A	2 A	1 A
• for signal "0" residual current, max.	0 A	0 A	2 mA	2 mA
Output delay with resistive load				
• "0" to "1", max.			1 AC cycle	1 AC cycle
• "1" to "0", max.			1 AC cycle	1 AC cycle
Parallel switching of two outputs				
• for logic links	Yes	Yes	No	No
• for uprating	No	No	No	No
• for redundant control of a load	Yes	Yes	Yes	Yes
Switching frequency				
• with resistive load, max.	2 Hz	1 Hz	10 Hz	10 Hz
• with inductive load, max.	0.5 Hz	0.5 Hz	0.5 Hz	0.5 Hz
• on lamp load, max.	2 Hz	1 Hz	1 Hz	1 Hz
Total current of the outputs				
• Current per channel, max.	8 A; see additional description in the manual	2 A; see additional description in the manual	2 A; see additional description in the manual	1 A; see additional description in the manual
• Current per group, max.	8 A; see additional description in the manual	2 A; see additional description in the manual	2 A; see additional description in the manual	2 A; see additional description in the manual
• Current per module, max.	64 A; see additional description in the manual	32 A; see additional description in the manual	10 A; see additional description in the manual	10 A; see additional description in the manual
Relay outputs				
• Number of relay outputs	8	16		
• Rated supply voltage of relay coil L+ (DC)	24 V	24 V		
• Current consumption of relays (coil current of all relays), typ.	80 mA	150 mA		
• external protection for relay outputs	With miniature circuit breaker with characteristic B for: cos ϕ 1.0: 600 A cos ϕ 0.5 ... 0.7: 900 A with 8 A Diazed fuse: 1000 A	Miniature circuit breaker B10 / B16		

Technical specifications (continued)

Article number	6ES7522-5HF00-0AB0 S7-1500, DQ 8X230VAC/5A ST (RELAY)	6ES7522-5HH00-0AB0 S7-1500, DQ 16X230VAC/2A ST (RELAY)	6ES7522-5FF00-0AB0 S7-1500, DQ 8X230VAC/2A ST (TRIAC)	6ES7522-5FH00-0AB0 S7-1500, DQ 16X230VAC/1A ST (TRIAC)
Relay outputs (continued)				
• Contact connection (internal)	No	No		
• Size of motor starters according to NEMA, max.	5	5		
• Number of operating cycles, max.	4 000 000; see additional description in the manual	see additional description in the manual		
• Relay approved acc. to UL 508	Yes; 250 V AC/5 A g.p.; 120 V AC TV-4 tungsten; A300, R300	No		
Switching capacity of contacts				
- with inductive load, max.	see additional description in the manual	2 A; see additional description in the manual		
- with resistive load, max.	see additional description in the manual	2 A; see additional description in the manual		
Triac outputs				
• Size of motor starters according to NEMA, max.			5	4
Cable length				
• shielded, max.	1 000 m	1 000 m	1 000 m	1 000 m
• unshielded, max.	600 m	600 m	600 m	600 m
Isochronous mode				
Isochronous operation (application synchronized up to terminal)	No	No	No	No
Interrupts/diagnostics/status information				
Diagnostics function	Yes	Yes	No	No
Substitute values connectable	Yes	Yes	Yes	Yes
Alarms				
• Diagnostic alarm	Yes	Yes	No	No
Diagnostic messages				
• Monitoring the supply voltage	Yes	Yes	No	No
• Wire-break	No	No	No	No
• Short-circuit	No	No	No	No
Diagnostics indication LED				
• RUN LED	Yes; Green LED	Yes; Green LED	Yes; Green LED	Yes; Green LED
• ERROR LED	Yes; Red LED	Yes; Red LED	Yes; Red LED	Yes; Red LED
• Monitoring of the supply voltage (PWR-LED)	Yes; Green LED	Yes; Green LED	No	No
• Channel status display	Yes; Green LED	Yes; Green LED	Yes; Green LED	Yes; Green LED
• for channel diagnostics	No	No	No	No
• for module diagnostics	Yes; Red LED	Yes; Red LED	Yes; Red LED	Yes; Red LED
Potential separation				
Potential separation channels				
• between the channels and backplane bus	Yes	Yes	Yes	Yes
Isolation				
Isolation tested with	Between channels: 3 100 V DC; between channels backplane bus: 3 100 V DC; between L+ and backplane bus: 707 V DC (type test)	Between channels: 3 100 V DC; between channels backplane bus: 3 100 V DC; between L+ and backplane bus: 707 V DC (type test)	3 100 V DC	3 100 V DC
Standards, approvals, certificates				
Suitable for safety functions	No	No	No	No
Ambient conditions				
Ambient temperature during operation				
• horizontal installation, min.	0 °C	0 °C	0 °C	0 °C
• horizontal installation, max.	60 °C	60 °C	60 °C	60 °C
• vertical installation, min.	0 °C	0 °C	0 °C	0 °C
• vertical installation, max.	40 °C	40 °C	40 °C	60 °C

SIMATIC S7-1500 Advanced Controllers

I/O modules

Digital modules

SM 522 digital output modules

Technical specifications (continued)

Article number	6ES7522-5HF00-0AB0	6ES7522-5HH00-0AB0	6ES7522-5FF00-0AB0	6ES7522-5FH00-0AB0
	S7-1500, DQ 8X230VAC/5A ST (RELAY)	S7-1500, DQ 16X230VAC/2A ST (RELAY)	S7-1500, DQ 8X230VAC/2A ST (TRIAC)	S7-1500, DQ 16X230VAC/1A ST (TRIAC)
Decentralized operation				
Prioritized startup	Yes	Yes	Yes	Yes
Dimensions				
Width	35 mm	35 mm	35 mm	35 mm
Height	147 mm	147 mm	147 mm	147 mm
Depth	129 mm	129 mm	129 mm	129 mm
Weights				
Weight, approx.	350 g	350 g	290 g	310 g

Article number	6ES7522-1BH10-0AA0	6ES7522-1BL10-0AA0
	S7-1500, DQ 16X24VDC/0.5A BA	S7-1500, DQ 32X24VDC/0.5A BA
General information		
Product type designation	DQ 16x24VDC/0.5A BA	DQ 32x24VDC/0.5A BA
Product function		
• I&M data	Yes; I&M0 to I&M3	Yes; I&M0 to I&M3
Engineering with		
• STEP 7 TIA Portal configurable/integrated as of version	V13 / V13	V13 / V13
• STEP 7 configurable/integrated as of version	V5.5 SP3 / -	V5.5 SP3 / -
• PROFIBUS as of GSD version/GSD revision	V1.0 / V5.1	V1.0 / V5.1
• PROFINET as of GSD version/GSD revision	V2.3 / -	V2.3 / -
Operating mode		
• DQ	Yes	Yes
• DQ with energy-saving function	No	No
• PWM	No	No
• Oversampling	No	No
• MSO	Yes	Yes
Supply voltage		
Type of supply voltage	DC	DC
Rated value (DC)	24 V	24 V
Reverse polarity protection	Yes; through internal protection with 7 A per group	Yes; through internal protection with 7 A per group
Digital outputs		
Type of digital output	Transistor	Transistor
Number of digital outputs	16	32
Current-sourcing	Yes	Yes
Digital outputs, parameterizable	No	No
Short-circuit protection	Yes	Yes
Limitation of inductive shutdown voltage to	L+ (-53 V)	L+ (-53 V)
Controlling a digital input	Yes	Yes
Switching capacity of the outputs		
• with resistive load, max.	0.5 A	0.5 A
• on lamp load, max.	5 W	5 W
Load resistance range		
• lower limit	48 Ω	48 Ω
• upper limit	12 kΩ	12 kΩ
Output voltage		
• Type of output voltage	DC	DC
• for signal *1*, min.	L+ (-0.8 V)	L+ (-0.8 V)

Technical specifications (continued)

Article number	6ES7522-1BH10-0AA0 S7-1500, DQ 16X24VDC/0.5A BA	6ES7522-1BL10-0AA0 S7-1500, DQ 32X24VDC/0.5A BA
Output current		
• for signal "1" rated value	0.5 A	0.5 A
• for signal "0" residual current, max.	0.5 mA	0.5 mA
Output delay with resistive load		
• "0" to "1", max.	100 µs	100 µs
• "1" to "0", max.	500 µs	500 µs
Parallel switching of two outputs		
• for logic links	Yes	Yes
• for uprating	No	No
• for redundant control of a load	Yes	Yes
Switching frequency		
• with resistive load, max.	100 Hz	100 Hz
• with inductive load, max.	0.5 Hz; According to IEC 60947-5-1, DC-13	0.5 Hz; According to IEC 60947-5-1, DC-13
• on lamp load, max.	10 Hz	10 Hz
Total current of the outputs		
• Current per channel, max.	0.5 A; see additional description in the manual	0.5 A; see additional description in the manual
• Current per group, max.	4 A; see additional description in the manual	4 A; see additional description in the manual
• Current per module, max.	8 A; see additional description in the manual	16 A; see additional description in the manual
Cable length		
• shielded, max.	1 000 m	1 000 m
• unshielded, max.	600 m	600 m
Isochronous mode		
Isochronous operation (application synchronized up to terminal)	No	No
Interrupts/diagnostics/ status information		
Diagnostics function	No	No
Substitute values connectable	No	No
Alarms		
• Diagnostic alarm	No	No
Diagnostic messages		
• Monitoring the supply voltage	No	No
• Wire-break	No	No
• Short-circuit	No	No
• Group error	No	No
Diagnostics indication LED		
• RUN LED	Yes; Green LED	Yes; Green LED
• ERROR LED	Yes; Red LED	Yes; Red LED
• Monitoring of the supply voltage (PWR-LED)	Yes; Green LED	Yes; Green LED
• Channel status display	Yes; Green LED	Yes; Green LED
• for channel diagnostics	No	No
• for module diagnostics	No	No
Potential separation		
Potential separation channels		
• between the channels and backplane bus	Yes	Yes
Isolation		
Isolation tested with	707 V DC (type test)	707 V DC (type test)
Standards, approvals, certificates		
Suitable for safety functions	No	No
Decentralized operation		
Prioritized startup	Yes	Yes

SIMATIC S7-1500 Advanced Controllers

I/O modules

Digital modules

SM 522 digital output modules

Technical specifications (continued)

Article number	6ES7522-1BH10-0AA0 S7-1500, DQ 16X24VDC/0.5A BA	6ES7522-1BL10-0AA0 S7-1500, DQ 32X24VDC/0.5A BA
Dimensions		
Width	25 mm	25 mm
Height	147 mm	147 mm
Depth	129 mm	129 mm
Weights		
Weight, approx.	230 g	280 g
Other		
Note:	Supplied incl. 40-pole push-in front connectors	Supplied incl. 40-pole push-in front connectors

Ordering data

SM 522 digital output modules

Module width 35 mm

8 outputs, 24 V DC;
2 A, isolated**6ES7522-1BF00-0AB0**16 outputs, 24 V DC;
0.5 A, isolated**6ES7522-1BH01-0AB0**32 outputs, 24 V DC;
0.5 A, isolated**6ES7522-1BL01-0AB0**

8 relay outputs, 230 V AC, 5 A

6ES7522-5HF00-0AB0

16 relay outputs, 230 V AC, 2 A

6ES7522-5HH00-0AB0

8 outputs (triac), 230 V AC, 2 A

6ES7522-5FF00-0AB0

16 outputs (triac), 230 V AC, 1 A

6ES7522-5FH00-0AB016 outputs, 24 ... 48 V UC,
125 V DC, 0.5 A, isolated**6ES7522-5EH00-0AB0**Module width 25 mm;
front connector (push-in)
included in delivery package16 outputs, 24 V DC;
0.5 A, isolated**6ES7522-1BH10-0AA0**32 outputs, 24 V DC;
0.5 A, isolated**6ES7522-1BL10-0AA0**

Accessories

Front connectors

For 35 mm modules;
including four potential bridges,
cable ties and individual labeling
strips, 40-pin

- Screw terminals
- Push-in

6ES7592-1AM00-0XB0**6ES7592-1BM00-0XB0**For 25 mm modules;
including cable ties and individual
labeling strips; push-in terminal
40-pin;
spare part**6ES7592-1BM00-0XA0**

Potential bridges for front connectors

6ES7592-3AA00-0AA0For 35 mm modules;
20 pieces; spare part

DIN A4 labeling sheets

For 35 mm modules;
10 sheets with 10 labeling strips
each for I/O modules; perforated,
Al gray**6ES7592-2AX00-0AA0**For 25 mm modules;
10 sheets with 20 labeling strips
each for I/O modules; perforated,
Al gray**6ES7592-1AX00-0AA0**

U connector

5 units; spare part

6ES7590-0AA00-0AA0

Universal front door for I/O modules

For 35 mm modules;
5 front doors; with 5 labeling
strips (front) and 5 cabling
diagrams per front door; spare part**6ES7528-0AA00-7AA0**For 25 mm modules;
5 front doors; with 5 labeling
strips (front) and 5 cabling
diagrams per front door; spare part**6ES7528-0AA00-0AA0**

SIMATIC Manual Collection

Electronic manuals on DVD,
multi-language:
LOGO!, SIMADYN, SIMATIC bus
components, SIMATIC C7,
SIMATIC distributed I/O,
SIMATIC HMI, SIMATIC Sensors,
SIMATIC NET, SIMATIC PC Based
Automation, SIMATIC PCS 7,
SIMATIC PG/PC, SIMATIC S7,
SIMATIC Software, SIMATIC TDC**6ES7998-8XC01-8YE0**

SIMATIC Manual Collection update service for 1 year

Current "Manual Collection" DVD
and the three subsequent updates**6ES7998-8XC01-8YE2**

Overview



- 16 digital inputs and 16 digital outputs
- For flexible adaptation of the controller to the corresponding task
- For subsequent expansion of the system with additional inputs and outputs
- For use in the tightest spaces: particularly economical, without parameters or diagnostic functions

Technical specifications

Article number	6ES7523-1BL00-0AA0 S7-1500, DI/DQ 16X24CDV/ 16X24VDC/0.5A BA
General information	
Product type designation	DI 16x24VDC / DQ16x24VDC/0.5A BA
Product function	
• I&M data	Yes; I&M0 to I&M3
Engineering with	
• STEP 7 TIA Portal configurable/ integrated as of version	V13 / V13
• STEP 7 configurable/integrated as of version	V5.5 SP3 / -
• PROFIBUS as of GSD version/ GSD revision	V1.0 / V5.1
• PROFINET as of GSD version/ GSD revision	V2.3 / -
Operating mode	
• DI	Yes
• Counter	No
• DQ	Yes
• DQ with energy-saving function	No
• PWM	No
• Oversampling	No
• MSI	Yes
• MSO	Yes
Supply voltage	
Type of supply voltage	DC
Rated value (DC)	24 V
Reverse polarity protection	Yes; through internal protection with 7 A per group
Digital inputs	
Number of digital inputs	16
Digital inputs, parameterizable	No
Source/sink input	P-reading
Input characteristic curve in accordance with IEC 61131, type 3	Yes
Input voltage	
• Type of input voltage	DC
• Rated value (DC)	24 V
• for signal "0"	-30 to +5V
• for signal "1"	+11 to +30V
Input current	
• for signal "1", typ.	2.7 mA

Article number	6ES7523-1BL00-0AA0 S7-1500, DI/DQ 16X24CDV/ 16X24VDC/0.5A BA
Input delay (for rated value of input voltage) for standard inputs	
- parameterizable	No
for interrupt inputs	
- parameterizable	No
Cable length	
• shielded, max.	1 000 m
• unshielded, max.	600 m
Digital outputs	
Type of digital output	Transistor
Number of digital outputs	16
Current-sourcing	Yes
Digital outputs, parameterizable	No
Short-circuit protection	Yes
Limitation of inductive shutdown voltage to	L+ (-53 V)
Controlling a digital input	Yes
Switching capacity of the outputs	
• with resistive load, max.	0.5 A
• on lamp load, max.	5 W
Load resistance range	
• lower limit	48 Ω
• upper limit	12 kΩ
Output voltage	
• Type of output voltage	DC
• for signal "1", min.	L+ (-0.8 V)
Output current	
• for signal "1" rated value	0.5 A
• for signal "0" residual current, max.	0.5 mA
Output delay with resistive load	
• "0" to "1", max.	100 μs
• "1" to "0", max.	500 μs
Parallel switching of two outputs	
• for logic links	Yes
• for uprating	No
• for redundant control of a load	Yes

SIMATIC S7-1500 Advanced Controllers

I/O modules

Digital modules

SM 523 digital input/output modules

Technical specifications (continued)

Article number	6ES7523-1BL00-0AA0 S7-1500, DI/DQ 16X24CDV/ 16X24VDC/0.5A BA
Switching frequency	
• with resistive load, max.	100 Hz
• with inductive load, max.	0.5 Hz
• on lamp load, max.	10 Hz
Total current of the outputs	
• Current per channel, max.	0.5 A; see additional description in the manual
• Current per group, max.	4 A; see additional description in the manual
• Current per module, max.	8 A; see additional description in the manual
Cable length	
• shielded, max.	1 000 m
• unshielded, max.	600 m
Encoder	
Connectable encoders	
• 2-wire sensor	Yes
- permissible quiescent current (2-wire sensor), max.	1.5 mA
Isochronous mode	
Isochronous operation (application synchronized up to terminal)	No
Interrupts/diagnostics/ status information	
Diagnostics function	No
Substitute values connectable	No
Alarms	
• Diagnostic alarm	No
• Hardware interrupt	No
Diagnostic messages	
• Monitoring the supply voltage	No
• Wire-break	No
• Short-circuit	No
• Group error	No

Article number	6ES7523-1BL00-0AA0 S7-1500, DI/DQ 16X24CDV/ 16X24VDC/0.5A BA
Diagnostics indication LED	
• RUN LED	Yes; Green LED
• ERROR LED	Yes; Red LED
• Monitoring of the supply voltage (PWR-LED)	Yes; Green LED
• Channel status display	Yes; Green LED
• for channel diagnostics	No
• for module diagnostics	No
Potential separation	
Potential separation channels	
• between the channels and backplane bus	Yes
Isolation	
Isolation tested with	707 V DC (type test)
Ambient conditions	
Ambient temperature during operation	
• horizontal installation, min.	0 °C
• horizontal installation, max.	60 °C
• vertical installation, min.	0 °C
• vertical installation, max.	40 °C
Decentralized operation	
Prioritized startup	Yes
Dimensions	
Width	25 mm
Height	147 mm
Depth	129 mm
Weights	
Weight, approx.	280 g
Other	
Note:	Supplied incl. 40-pole push-in front connectors

Ordering data

Ordering data	Article No.
SM 523 digital input/output module Module width 25 mm; front connector (push-in) included in delivery package 16 inputs, 24 V DC, isolated; 16 outputs, 24 V DC; 0.5 A, isolated	6ES7523-1BL00-0AA0
Accessories	
Front connectors For 25 mm modules; including cable ties and individual labeling strips; push-in terminal 40-pin; spare part	6ES7592-1BM00-0XA0
DIN A4 labeling sheets For 25 mm modules; 10 sheets with 20 labeling strips each for I/O modules; perforated, Al gray	6ES7592-1AX00-0AA0
U connector 5 units; spare part	6ES7590-0AA00-0AA0

Ordering data	Article No.
Universal front door for I/O modules For 25 mm modules; 5 front doors; with 5 labeling strips (front) and 5 cabling diagrams per front door; spare part	6ES7528-0AA00-0AA0
SIMATIC Manual Collection Electronic manuals on DVD, multi-language: LOGO!, SIMADYN, SIMATIC bus components, SIMATIC C7, SIMATIC distributed I/O, SIMATIC HMI, SIMATIC Sensors, SIMATIC NET, SIMATIC PC Based Automation, SIMATIC PCS 7, SIMATIC PG/PC, SIMATIC S7, SIMATIC Software, SIMATIC TDC	6ES7998-8XC01-8YE0
SIMATIC Manual Collection update service for 1 year Current "Manual Collection" DVD and the three subsequent updates	6ES7998-8XC01-8YE2

Overview



- 16 and 32-channel digital input modules
- For flexible adaptation of the controller to the corresponding task
- For subsequent expansion of the system with additional inputs

Note:

SIPLUS extreme products are based on SIMATIC standard products. The contents listed here were taken from the respective standard products. SIPLUS extreme-specific information was added.

Technical specifications

Article number	6AG1521-1BH00-7AB0	6AG1521-1BL00-7AB0	6AG1521-1BH50-7AA0	6AG1521-1FH00-7AA0
Based on	6ES7521-1BH00-0AB0	6ES7521-1BL00-0AB0	6ES7521-1BH50-0AA0	6ES7521-1FH00-0AA0
	SIPLUS S7-1500 DI 16X24VDC HF	SIPLUS S7-1500 DI 32X24VDC HF	SIPLUS S7-1500 DI 16X24VDC SRC BA	SIPLUS S7-1500 DI 16X230VAC BA
Ambient conditions				
Ambient temperature during operation				
• horizontal installation, min.	-40 °C; = Tmin	-40 °C; = Tmin	-40 °C; = Tmin	-40 °C; = Tmin
• horizontal installation, max.	70 °C; = Tmax	70 °C; = Tmax; > +60 °C number of simultaneously controllable inputs max. 16	70 °C; = Tmax; > +60 °C number of simultaneously controllable inputs max. 8	70 °C; = Tmax; > +60 °C number of simultaneously controllable inputs max. 8
• vertical installation, min.	-40 °C; = Tmin	-40 °C; = Tmin	-40 °C; = Tmin	-40 °C; = Tmin
• vertical installation, max.	40 °C; = Tmax	40 °C; = Tmax	40 °C; = Tmax	40 °C; = Tmax
Extended ambient conditions				
• relative to ambient temperature-atmospheric pressure-installation altitude	Tmin ... Tmax at 1080 hPa ... 795 hPa (-1000 m ... +2000 m) // Tmin ... (Tmax - 10K) at 795 hPa ... 658 hPa (+2000 m ... +3500 m) // Tmin ... (Tmax - 20K) at 658 hPa ... 540 hPa (+3500 m ... +5000 m)	Tmin ... Tmax at 1080 hPa ... 795 hPa (-1000 m ... +2000 m) // Tmin ... (Tmax - 10K) at 795 hPa ... 658 hPa (+2000 m ... +3500 m) // Tmin ... (Tmax - 20K) at 658 hPa ... 540 hPa (+3500 m ... +5000 m)	Tmin ... Tmax at 1080 hPa ... 795 hPa (-1000 m ... +2000 m) // Tmin ... (Tmax - 10K) at 795 hPa ... 658 hPa (+2000 m ... +3500 m) // Tmin ... (Tmax - 20K) at 658 hPa ... 540 hPa (+3500 m ... +5000 m)	Tmin ... Tmax at 1080 hPa ... 795 hPa (-1000 m ... +2000 m)
Relative humidity				
- With condensation, tested in accordance with IEC 60068-2-38, max.	100 %; RH incl. condensation/frost (no commissioning under condensation conditions)	100 %; RH incl. condensation/frost (no commissioning under condensation conditions)	100 %; RH incl. condensation/frost (no commissioning under condensation conditions)	100 %; RH incl. condensation/frost (no commissioning under condensation conditions)
Resistance				
- against biologically active substances / conformity with EN 60721-3-3	Yes; Class 3B2 mold, fungus and dry rot spores (with the exception of fauna). The supplied connector covers must remain on the unused interfaces during operation!	Yes; Class 3B2 mold, fungus and dry rot spores (with the exception of fauna). The supplied connector covers must remain on the unused interfaces during operation!	Yes; Class 3B2 mold, fungus and dry rot spores (with the exception of fauna). The supplied connector covers must remain on the unused interfaces during operation!	Yes; Class 3B2 mold, fungus and dry rot spores (with the exception of fauna). The supplied connector covers must remain on the unused interfaces during operation!
- against chemically active substances / conformity with EN 60721-3-3	Yes; Class 3C4 (RH < 75%) incl. salt spray according to EN 60068-2-52 (degree of severity 3). The supplied connector covers must remain on the unused interfaces during operation!	Yes; Class 3C4 (RH < 75%) incl. salt spray according to EN 60068-2-52 (degree of severity 3). The supplied connector covers must remain on the unused interfaces during operation!	Yes; Class 3C4 (RH < 75%) incl. salt spray according to EN 60068-2-52 (degree of severity 3). The supplied connector covers must remain on the unused interfaces during operation!	Yes; Class 3C4 (RH < 75%) incl. salt spray according to EN 60068-2-52 (degree of severity 3). The supplied connector covers must remain on the unused interfaces during operation!
- against mechanically active substances / conformity with EN 60721-3-3	Yes; Class 3S4 incl. sand, dust. The supplied connector covers must remain on the unused interfaces during operation!	Yes; Class 3S4 incl. sand, dust. The supplied connector covers must remain on the unused interfaces during operation!	Yes; Class 3S4 incl. sand, dust. The supplied connector covers must remain on the unused interfaces during operation!	Yes; Class 3S4 incl. sand, dust. The supplied connector covers must remain on the unused interfaces during operation!

SIMATIC S7-1500 Advanced Controllers

I/O modules

SIPLUS digital modules

SIPLUS SM 521 digital input modules**Ordering data****Article No.****SIPLUS SM 521 digital input modules**

(Extended temperature range and exposure to media)

16 inputs, 24 V DC, isolated, parameterizable diagnostics and hardware interrupts

6AG1521-1BH00-7AB0

32 inputs, 24 V DC, isolated, parameterizable diagnostics and hardware interrupts

6AG1521-1BL00-7AB0

16 inputs, 24 V DC, isolated, input delay 3.2 ms

6AG1521-1BH50-7AA0

16 inputs, 230 V AC, isolated, input delay 20 ms

6AG1521-1FH00-7AA0**Accessories****Article No.**

See SIMATIC S7-1500 SM 521 digital input modules, page 4/64

Overview



- 8, 16 and 32-channel digital output modules
- For flexible adaptation of the controller to the corresponding task
- For subsequent expansion of the system with additional outputs

Note:

SIPLUS extreme products are based on SIMATIC standard products. The contents listed here were taken from the respective standard products. SIPLUS extreme specific information has been added.

Technical specifications

Article number	6AG1522-1BF00-7AB0	6AG1522-1BH01-7AB0	6AG1522-1BL01-7AB0	6AG1522-5HF00-2AB0	6AG1522-5FF00-7AB0
Based on	6ES7522-1BF00-0AB0	6ES7522-1BH01-0AB0	6ES7522-1BL01-0AB0	6ES7522-5HF00-0AB0	6ES7522-5FF00-0AB0
	SIPLUS S7-1500 DQ 8X24VDC/2A HF	SIPLUS S7-1500 DQ 16X24VDC/0.5A HF	SIPLUS S7-1500 DQ 32X24VDC/0.5A HF	SIPLUS S7-1500 DQ 8X230VAC/5A ST (RELAY)	SIPLUS S7-1500 DQ 8X230VAC/2A ST (TRIAC)
Ambient conditions					
Ambient temperature during operation					
• horizontal installation, min.	-40 °C; = Tmin	-40 °C; = Tmin	-40 °C; = Tmin	-25 °C; = Tmin	-40 °C; = Tmin
• horizontal installation, max.	70 °C; = Tmax; > +60 °C Number of simultaneously controllable outputs max. 8x 0.5 A, max. total current per group 2 A	70 °C; = Tmax; see Derating BasedOn (e.g. manual), additionally Tmax > 60 °C max. aggregate current 2 A per group	70 °C; = Tmax; see Derating BasedOn (e.g. manual), additionally Tmax > 60 °C max. aggregate current 2 A per group	60 °C; = Tmax	70 °C; = Tmax; > +60 °C number of simultaneously controllable outputs max. 8x 0.25 A, max. total current 2 A
• vertical installation, min.	-40 °C; = Tmin			-25 °C; = Tmin	-40 °C; = Tmin
• vertical installation, max.	40 °C; = Tmax			40 °C; = Tmax	40 °C; = Tmax
Extended ambient conditions					
• relative to ambient temperature-atmospheric pressure-installation altitude	Tmin ... Tmax at 1080 hPa ... 795 hPa (-1000 m ... +2000 m) // Tmin ... (Tmax - 10K) at 795 hPa ... 658 hPa (+2000 m ... +3500 m) // Tmin ... (Tmax - 20K) at 658 hPa ... 540 hPa (+3500 m ... +5000 m)	Tmin ... Tmax at 1080 hPa ... 795 hPa (-1000 m ... +2000 m) // Tmin ... (Tmax - 10K) at 795 hPa ... 658 hPa (+2000 m ... +3500 m) // Tmin ... (Tmax - 20K) at 658 hPa ... 540 hPa (+3500 m ... +5000 m)	Tmin ... Tmax at 1080 hPa ... 795 hPa (-1000 m ... +2000 m) // Tmin ... (Tmax - 10K) at 795 hPa ... 658 hPa (+2000 m ... +3500 m) // Tmin ... (Tmax - 20K) at 658 hPa ... 540 hPa (+3500 m ... +5000 m)	Tmin ... Tmax at 1080 hPa ... 795 hPa (-1000 m ... +2000 m)	Tmin ... Tmax at 1080 hPa ... 795 hPa (-1000 m ... +2000 m)
Relative humidity					
- With condensation, tested in accordance with IEC 60068-2-38, max.	100 %; RH incl. condensation/frost (no commissioning under condensation conditions)	100 %; RH incl. condensation / frost (no commissioning in bedewed state), horizontal installation	100 %; RH incl. condensation / frost (no commissioning in bedewed state), horizontal installation	100 %; RH incl. condensation/frost (no commissioning under condensation conditions)	100 %; RH incl. condensation/frost (no commissioning under condensation conditions)

SIMATIC S7-1500 Advanced Controllers

I/O modules

SIPLUS digital modules

SIPLUS SM 522 digital output modules

Technical specifications (continued)

Article number	6AG1522-1BF00-7AB0	6AG1522-1BH01-7AB0	6AG1522-1BL01-7AB0	6AG1522-5HF00-2AB0	6AG1522-5FF00-7AB0
Based on	6ES7522-1BF00-0AB0 SIPLUS S7-1500 DQ 8X24VDC/2A HF	6ES7522-1BH01-0AB0 SIPLUS S7-1500 DQ 16X24VDC/0.5A HF	6ES7522-1BL01-0AB0 SIPLUS S7-1500 DQ 32X24VDC/0.5A HF	6ES7522-5HF00-0AB0 SIPLUS S7-1500 DQ 8X230VAC/5A ST (RELAY)	6ES7522-5FF00-0AB0 SIPLUS S7-1500 DQ 8X230VAC/2A ST (TRIAC)
Resistance					
- against biologically active substances / conformity with EN 60721-3-3	Yes; Class 3B2 mold, fungus and dry rot spores (with the exception of fauna). The supplied connector covers must remain on the unused interfaces during operation!	Yes; Class 3B2 mold, fungus and dry rot spores (with the exception of fauna). The supplied connector covers must remain on the unused interfaces during operation!	Yes; Class 3B2 mold, fungus and dry rot spores (with the exception of fauna). The supplied connector covers must remain on the unused interfaces during operation!	Yes; Class 3B2 mold, fungus and dry rot spores (with the exception of fauna). The supplied connector covers must remain on the unused interfaces during operation!	Yes; Class 3B2 mold, fungus and dry rot spores (with the exception of fauna). The supplied connector covers must remain on the unused interfaces during operation!
- against chemically active substances / conformity with EN 60721-3-3	Yes; Class 3C4 (RH < 75%) incl. salt spray according to EN 60068-2-52 (degree of severity 3). The supplied connector covers must remain on the unused interfaces during operation!	Yes; Class 3C4 (RH < 75%) incl. salt spray according to EN 60068-2-52 (degree of severity 3). The supplied connector covers must remain on the unused interfaces during operation!	Yes; Class 3C4 (RH < 75%) incl. salt spray according to EN 60068-2-52 (degree of severity 3). The supplied connector covers must remain on the unused interfaces during operation!	Yes; Class 3C4 (RH < 75%) incl. salt spray according to EN 60068-2-52 (degree of severity 3). The supplied connector covers must remain on the unused interfaces during operation!	Yes; Class 3C4 (RH < 75%) incl. salt spray according to EN 60068-2-52 (degree of severity 3). The supplied connector covers must remain on the unused interfaces during operation!
- against mechanically active substances / conformity with EN 60721-3-3	Yes; Class 3S4 incl. sand, dust. The supplied connector covers must remain on the unused interfaces during operation!	Yes; Class 3S4 incl. sand, dust. The supplied connector covers must remain on the unused interfaces during operation!	Yes; Class 3S4 incl. sand, dust. The supplied connector covers must remain on the unused interfaces during operation!	Yes; Class 3S4 incl. sand, dust. The supplied connector covers must remain on the unused interfaces during operation!	Yes; Class 3S4 incl. sand, dust. The supplied connector covers must remain on the unused interfaces during operation!

Ordering data

SIPLUS SM 522 digital output modules

(Extended temperature range and exposure to media)

8 outputs, 24 V DC;
2 A, isolated**6AG1522-1BF00-7AB0**16 outputs, 24 V DC;
0.5 A, isolated**6AG1522-1BH01-7AB0**32 outputs, 24 V DC;
0.5 A, isolated**6AG1522-1BL01-7AB0**

8 relay outputs, 230 V AC, 5 A

6AG1522-5HF00-2AB0

8 outputs (triac), 230 V AC, 2 A

6AG1522-5FF00-7AB0

Accessories

See SIMATIC S7-1500
SM 522 digital output
modules, page 4/72

Overview



- 4 or 8-channel analog input modules
- Optionally with extremely short conversion times
- For the connection of analog sensors without additional amplifiers
- Even solves more complex automation tasks

Technical specifications

Article number	6ES7531-7QD00-0AB0	6ES7531-7KF00-0AB0	6ES7531-7NF10-0AB0	6ES7531-7NF00-0AB0
	S7-1500, AI 4xU/I/RTD/TC ST	S7-1500, AI 8xU/I/RTD/TC ST	S7-1500, AI 8xU/I HS	S7-1500, AI 8xU/I HF
General information				
Product type designation	AI 4xU/I/RTD/TC ST	AI 8xU/I/RTD/TC ST	AI 8xU/I HS	AI 8xU/I HF
Product function				
• I&M data	Yes; I&M0 to I&M3	Yes; I&M0 to I&M3	Yes; I&M0 to I&M3	Yes; I&M0 to I&M3
• Measuring range scalable	No	No	No	No
• Scalable measured values	No	No	No	Yes
• Adjustment of measuring range	No	No	No	Yes
Engineering with				
• STEP 7 TIA Portal configurable/ integrated as of version	V13 / V13.0.2	V12 / V12	V14 / -	V14 / -
• STEP 7 configurable/integrated as of version	V5.5 SP3 / -	V5.5 SP3 / -	V5.5 SP3 / -	V5.5 SP3 / -
• PROFIBUS as of GSD version/ GSD revision	V1.0 / V5.1	V1.0 / V5.1	V1.0 / V5.1	V1.0 / V5.1
• PROFINET as of GSD version/ GSD revision	V2.3 / -	V2.3 / -	V2.3 / -	V2.3 / -
Operating mode				
• Oversampling	No	No	Yes	No
• MSI	Yes	Yes	Yes	Yes
CiR – Configuration in RUN				
Reparameterization possible in RUN	Yes	Yes	Yes	Yes
Calibration possible in RUN	Yes	Yes	Yes	Yes
Supply voltage				
Type of supply voltage	DC	DC	DC	DC
Rated value (DC)	24 V	24 V	24 V	24 V
Reverse polarity protection	Yes	Yes	Yes	Yes

SIMATIC S7-1500 Advanced Controllers

I/O modules

Analog modules

SM 531 analog input modules

Technical specifications (continued)

Article number	6ES7531-7QD00-0AB0 S7-1500, AI 4XU/I/RTD/TC ST	6ES7531-7KF00-0AB0 S7-1500, AI 8XU/I/RTD/TC ST	6ES7531-7NF10-0AB0 S7-1500, AI 8XU/I HS	6ES7531-7NF00-0AB0 S7-1500, AI 8XU/I HF
Analog inputs				
Number of analog inputs	4	8	8	8
• For current measurement	4	8	8	8
• For voltage measurement	4	8	8	8
• For resistance/resistance thermometer measurement	2	4		
• For thermocouple measurement	4	8		
permissible input voltage for voltage input (destruction limit), max.	28.8 V	28.8 V	28.8 V	28.8 V
permissible input current for current input (destruction limit), max.	40 mA	40 mA	40 mA	40 mA
Technical unit for temperature measurement adjustable	Yes; °C/°F/K	Yes; °C/°F/K		
Analog input with oversampling	No			
Standardization of measured values	No			
Input ranges (rated values), voltages				
• 0 to +5 V	No	No	No	No
• 0 to +10 V	No	No	No	No
• 1 V to 5 V	Yes	Yes	Yes	Yes
• -1 V to +1 V	Yes	Yes		
• -10 V to +10 V	Yes	Yes	Yes	Yes
• -2.5 V to +2.5 V	Yes	Yes	No	Yes
• -25 mV to +25 mV	No	No	No	No
• -250 mV to +250 mV	Yes	Yes	No	No
• -5 V to +5 V	Yes	Yes	Yes	Yes
• -50 mV to +50 mV	Yes	Yes	No	No
• -500 mV to +500 mV	Yes	Yes	No	No
• -80 mV to +80 mV	Yes	Yes	No	No
Input ranges (rated values), currents				
• 0 to 20 mA	Yes	Yes	Yes	Yes
• -20 mA to +20 mA	Yes	Yes	Yes	Yes
• 4 mA to 20 mA	Yes	Yes	Yes	Yes
Input ranges (rated values), thermocouples				
• Type B	Yes	Yes	No	No
• Type C	No	No	No	No
• Type E	Yes	Yes	No	No
• Type J	Yes	Yes	No	No
• Type K	Yes	Yes	No	No
• Type L	No	No	No	No
• Type N	Yes	Yes	No	No
• Type R	Yes	Yes	No	No
• Type S	Yes	Yes	No	No
• Type T	Yes	Yes	No	No
• Type U	No			
• Type TXK/TXK(L) to GOST	No	No	No	No

Technical specifications (continued)

Article number	6ES7531-7QD00-0AB0 S7-1500, AI 4XU/I/RTD/TC ST	6ES7531-7KF00-0AB0 S7-1500, AI 8XU/I/RTD/TC ST	6ES7531-7NF10-0AB0 S7-1500, AI 8XU/I HS	6ES7531-7NF00-0AB0 S7-1500, AI 8XU/I HF
Input ranges (rated values), resistance thermometer				
• Cu 10	No	No	No	No
• Cu 10 according to GOST	No	No	No	No
• Cu 50	No	No	No	No
• Cu 50 according to GOST	No	No	No	No
• Cu 100	No	No	No	No
• Cu 100 according to GOST	No	No	No	No
• Ni 10	No	No	No	No
• Ni 10 according to GOST	No	No	No	No
• Ni 100	Yes; Standard/climate	Yes; Standard/climate	No	No
• Ni 100 according to GOST	No	No	No	No
• Ni 1000	Yes; Standard/climate	Yes; Standard/climate	No	No
• Ni 1000 according to GOST	No	No	No	No
• LG-Ni 1000	Yes; Standard/climate	Yes; Standard/climate	No	No
• Ni 120	No	No	No	No
• Ni 120 according to GOST	No	No	No	No
• Ni 200	No	No	No	No
• Ni 200 according to GOST	No	No	No	No
• Ni 500	No	No	No	No
• Ni 500 according to GOST	No	No	No	No
• Pt 10	No	No	No	No
• Pt 10 according to GOST	No	No	No	No
• Pt 50	No	No	No	No
• Pt 50 according to GOST	No	No	No	No
• Pt 100	Yes; Standard/climate	Yes; Standard/climate	No	No
• Pt 100 according to GOST	No	No	No	No
• Pt 1000	Yes; Standard/climate	Yes; Standard/climate	No	No
• Pt 1000 according to GOST	No	No	No	No
• Pt 200	Yes; Standard/climate	Yes; Standard/climate	No	No
• Pt 200 according to GOST	No	No	No	No
• Pt 500	Yes; Standard/climate	Yes; Standard/climate	No	No
• Pt 500 according to GOST	No	No	No	No
Input ranges (rated values), resistors				
• 0 to 150 ohms	Yes	Yes	No	No
• 0 to 300 ohms	Yes	Yes	No	No
• 0 to 600 ohms	Yes	Yes	No	No
• 0 to 3000 ohms	No	No	No	No
• 0 to 6000 ohms	Yes	Yes	No	No
• PTC	Yes	Yes	No	No
Thermocouple (TC)				
Temperature compensation				
- parameterizable	Yes	Yes		
Cable length				
• shielded, max.	800 m; for U/I, 200 m for R/ RTD, 50 m for TC	800 m; for U/I, 200 m for R/ RTD, 50 m for TC	800 m	800 m

SIMATIC S7-1500 Advanced Controllers

I/O modules

Analog modules

SM 531 analog input modules

Technical specifications (continued)

Article number	6ES7531-7QD00-0AB0 S7-1500, AI 4XU/I/RTD/TC ST	6ES7531-7KF00-0AB0 S7-1500, AI 8XU/I/RTD/TC ST	6ES7531-7NF10-0AB0 S7-1500, AI 8XU/I HS	6ES7531-7NF00-0AB0 S7-1500, AI 8XU/I HF
Analog value generation for the inputs				
Integration and conversion time/ resolution per channel				
• Resolution with overrange (bit including sign), max.	16 bit	16 bit	16 bit	24 bit; When using the function "Scaling of the measured values" or "Measuring range adaptation" (32-bit REAL format); 16 bits when using the S7 format (16-bit INTEGER)
• Integration time, parameterizable	Yes	Yes		Yes
• Integration time (ms)	2,5 / 16,67 / 20 / 100 ms	2,5 / 16,67 / 20 / 100 ms		Fast mode: 2.5 / 16.67 / 20 / 100 ms, standard mode: 7.5 / 50 / 60 / 300 ms
• Basic conversion time, including integration time (ms)	9 / 23 / 27 / 107 ms	9 / 23 / 27 / 107 ms		Fast mode: 4 / 18 / 22 / 102 ms; Standard mode: 9 / 52 / 62 / 302 ms
- additional conversion time for wire-break monitoring	9 ms (to be considered in R/RTD/TC measurement)	9 ms (to be considered in R/RTD/TC measurement)		
- additional conversion time for resistance measurement	150 ohm, 300 ohm, 600 ohm, Pt100, Pt200, Ni100: 2 ms, 6000 ohm, Pt500, Pt1000, Ni1000, LG-Ni1000, PTC: 4 ms	150 ohm, 300 ohm, 600 ohm, Pt100, Pt200, Ni100: 2 ms, 6000 ohm, Pt500, Pt1000, Ni1000, LG-Ni1000, PTC: 4 ms		
• Interference voltage suppression for interference frequency f1 in Hz	400 / 60 / 50 / 10	400 / 60 / 50 / 10 Hz		400 / 60 / 50 / 10 Hz
• Basic execution time of the module (all channels released)				Corresponds to the channel with the highest basic conversion time
• Basic execution time of the module (all channels released)			62.5 µs; independent of number of activated channels	
Smoothing of measured values				
• parameterizable	Yes	Yes	Yes	Yes
Encoder				
Connection of signal encoders				
• for voltage measurement	Yes	Yes	Yes	Yes
• for current measurement as 2-wire transducer	Yes	Yes	Yes	Yes; with external transmitter supply
- Burden of 2-wire transmitter, max.	820 Ω	820 Ω	820 Ω	
• for current measurement as 4-wire transducer	Yes	Yes	Yes	Yes
• for resistance measurement with two-wire connection	Yes; Only for PTC	Yes; Only for PTC	No	No
• for resistance measurement with three-wire connection	Yes; All measuring ranges except PTC; internal compensation of the cable resistances	Yes; All measuring ranges except PTC; internal compensation of the cable resistances	No	No
• for resistance measurement with four-wire connection	Yes; All measuring ranges except PTC	Yes; All measuring ranges except PTC	No	No

Technical specifications (continued)

Article number	6ES7531-7QD00-0AB0 S7-1500, AI 4XU/I/RTD/TC ST	6ES7531-7KF00-0AB0 S7-1500, AI 8XU/I/RTD/TC ST	6ES7531-7NF10-0AB0 S7-1500, AI 8XU/I HS	6ES7531-7NF00-0AB0 S7-1500, AI 8XU/I HF
Errors/accuracies				
Basic error limit (operational limit at 25 °C)				
• Voltage, relative to input range, (+/-)	0.1 %	0.1 %	0.2 %	0.05 %
• Current, relative to input range, (+/-)	0.1 %	0.1 %	0.2 %	0.05 %
• Resistance, relative to input range, (+/-)	0.1 %	0.1 %		
• Resistance thermometer, relative to input range, (+/-)	0.1 %; Ptxxx standard: ±0.7 K, Ptxxx climate: ±0.2 K, Nixxx standard: ±0.3 K, Nixxx climate: ±0.15 K	Ptxxx standard: ±0.7 K, Ptxxx climate: ±0.2 K, Nixxx standard: ±0.3 K, Nixxx climate: ±0.15 K		
• Thermocouple, relative to input range, (+/-)	0.1 %; Type B: > 600 °C ±1.7 K, type E: > -200 °C ±0.7 K, type J: > -210 °C ±0.8 K, type K: > -200 °C ±1.2 K, type N: > -200 °C ±1.2 K, type R: > 0 °C ±1.9 K, type S: > 0 °C ±1.9 K, type T: > -200 °C ±0.8 K	Type B: > 600 °C ±1.7 K, type E: > -200 °C ±0.7 K, type J: > -210 °C ±0.8 K, type K: > -200 °C ±1.2 K, type N: > -200 °C ±1.2 K, type R: > 0 °C ±1.9 K, type S: > 0 °C ±1.9 K, type T: > -200 °C ±0.8 K		
Interference voltage suppression for $f = n \times (f_1 \pm 1 \%)$, $f_1 =$ interference frequency				
• Series mode interference (peak value of interference < rated value of input range), min.	40 dB	40 dB		80 dB; in the Standard operating mode, 40 dB in the Fast operating mode
• Common mode voltage, max.	10 V	10 V	10 V	60 V DC/30 V AC
• Common mode interference, min.	60 dB	60 dB	50 dB at 400 Hz; 60 dB at 60 / 50 / 10 Hz	80 dB
Isochronous mode				
Isochronous operation (application synchronized up to terminal)	No	No	Yes	No
Filtering and processing time (TCI), min.			80 µs	
Bus cycle time (TDP), min.			250 µs	
Interrupts/diagnostics/status information				
Diagnostics function	Yes	Yes	Yes	Yes
Alarms				
• Diagnostic alarm	Yes	Yes	Yes	Yes
• Limit value alarm	Yes; two upper and two lower limit values in each case	Yes; two upper and two lower limit values in each case	Yes; two upper and two lower limit values in each case	Yes; two upper and two lower limit values in each case
Diagnostic messages				
• Monitoring the supply voltage	Yes	Yes	Yes	Yes
• Wire-break	Yes; Only for 1 to 5 V, 4 to 20 mA, TC, R, and RTD	Yes; Only for 1 to 5 V, 4 to 20 mA, TC, R, and RTD	Yes; only for 1 ... 5 V and 4 ... 20 mA	Yes; only for 1 ... 5 V and 4 ... 20 mA
• Overflow/underflow	Yes	Yes	Yes	Yes
Diagnostics indication LED				
• RUN LED	Yes; Green LED	Yes; Green LED	Yes; Green LED	Yes; Green LED
• ERROR LED	Yes; Red LED	Yes; Red LED	Yes; Red LED	Yes; Red LED
• Monitoring of the supply voltage (PWR-LED)	Yes; Green LED	Yes; Green LED	Yes; Green LED	Yes; Green LED
• Channel status display	Yes; Green LED	Yes; Green LED	Yes; Green LED	Yes; Green LED
• for channel diagnostics	Yes; Red LED	Yes; Red LED	Yes; Red LED	Yes; Red LED
• for module diagnostics	Yes; Red LED	Yes; Red LED	Yes; Red LED	Yes; Red LED
Potential separation				
Potential separation channels				
• between the channels and backplane bus	Yes	Yes	Yes	Yes

SIMATIC S7-1500 Advanced Controllers

I/O modules

Analog modules

SM 531 analog input modules**Technical specifications (continued)**

Article number	6ES7531-7QD00-0AB0 S7-1500, AI 4XU/I/RTD/TC ST	6ES7531-7KF00-0AB0 S7-1500, AI 8XU/I/RTD/TC ST	6ES7531-7NF10-0AB0 S7-1500, AI 8XU/I HS	6ES7531-7NF00-0AB0 S7-1500, AI 8XU/I HF
Isolation				
Isolation tested with	707 V DC (type test)	707 V DC (type test)	707 V DC (type test)	2 000 V DC between the channels and the supply voltage L+; 2 000 V DC between the channels and the backplane bus; 2 000 V DC between the channels; 707 V DC (type test) between the supply voltage L+ and the backplane bus
Ambient conditions				
Ambient temperature during operation				
• horizontal installation, min.	0 °C	0 °C	0 °C	0 °C
• horizontal installation, max.	60 °C	60 °C	60 °C	60 °C
• vertical installation, min.	0 °C	0 °C	0 °C	0 °C
• vertical installation, max.	40 °C	40 °C	40 °C	40 °C
Decentralized operation				
Prioritized startup	No	No	Yes	Yes
Dimensions				
Width	25 mm	35 mm	35 mm	35 mm
Height	147 mm	147 mm	147 mm	147 mm
Depth	129 mm	129 mm	129 mm	129 mm
Weights				
Weight, approx.	210 g	310 g	300 g	280 g
Other				
Note:	Supplied incl. 40-pole push-in front connectors. Additional basic error and noise for integration time = 2.5 ms: Voltage: ±250 mV (±0.02%), ±80 mV (±0.05%), ±50 mV (±0.05%); resistance: 150 Ohms (±0.02%); resistance thermometer: Pt100 climate: ±0.08 K, Ni100 climate: ±0.08 K; thermoelement: Type B, R, S: ±3 K, type E, J, K, N, T: ±1 K	Additional basic error and noise for integration time = 2.5 ms: Voltage: ±250 mV (±0.02%), ±80 mV (±0.05%), ±50 mV (±0.05%); resistance: 150 ohms ±0.02%; resistance thermometer: Pt100 climate: ±0.08 K, Ni100 climate: ±0.08 K; thermocouple: Type B, R, S: ±3 K, type E, J, K, N, T: ±1 K		

Technical specifications (continued)

Article number	6ES7531-7PF00-0AB0 S7-1500, AI 8 X U/R/RTD/TC HF
General information	
Product type designation	AI 8xU/R/RTD/TC HF
Product function	
• I&M data	Yes; I&M0 to I&M3
• Measuring range scalable	Yes
• Scalable measured values	No
• Adjustment of measuring range	No
Engineering with	
• STEP 7 TIA Portal configurable/integrated as of version	V14 / -
• STEP 7 configurable/integrated as of version	V5.5 SP3 / -
• PROFIBUS as of GSD version/GSD revision	V1.0 / V5.1
• PROFINET as of GSD version/GSD revision	V2.3 / -
Operating mode	
• Oversampling	No
• MSI	Yes
CiR – Configuration in RUN	
Reparameterization possible in RUN	Yes
Calibration possible in RUN	Yes
Supply voltage	
Type of supply voltage	DC
Rated value (DC)	24 V
Reverse polarity protection	Yes
Analog inputs	
Number of analog inputs	8; Plus one additional RTD (reference) channel
• For voltage measurement	8; Plus one additional RTD (reference) channel
• For resistance/resistance thermometer measurement	8; Plus one additional RTD (reference) channel
• For thermocouple measurement	8; Plus one additional RTD (reference) channel
permissible input voltage for voltage input (destruction limit), max.	20 V
Technical unit for temperature measurement adjustable	Yes; °C/°F/K
Input ranges (rated values), voltages	
• 0 to +5 V	No
• 0 to +10 V	No
• 1 V to 5 V	No
• -1 V to +1 V	Yes
• -10 V to +10 V	No
• -2.5 V to +2.5 V	No
• -25 mV to +25 mV	Yes
• -250 mV to +250 mV	Yes
• -5 V to +5 V	No
• -50 mV to +50 mV	Yes
• -500 mV to +500 mV	Yes
• -80 mV to +80 mV	Yes
Input ranges (rated values), currents	
• 0 to 20 mA	No
• -20 mA to +20 mA	No
• 4 mA to 20 mA	No

Article number	6ES7531-7PF00-0AB0 S7-1500, AI 8 X U/R/RTD/TC HF
Input ranges (rated values), thermocouples	
• Type B	Yes
• Type C	Yes
• Type E	Yes
• Type J	Yes
• Type K	Yes
• Type L	No
• Type N	Yes
• Type R	Yes
• Type S	Yes
• Type T	Yes
• Type TXK/TXK(L) to GOST	Yes
Input ranges (rated values), resistance thermometer	
• Cu 10	Yes; Standard/climate
• Cu 10 according to GOST	Yes; Standard/climate
• Cu 50	Yes; Standard/climate
• Cu 50 according to GOST	Yes; Standard/climate
• Cu 100	Yes; Standard/climate
• Cu 100 according to GOST	Yes; Standard/climate
• Ni 10	Yes; Standard/climate
• Ni 10 according to GOST	Yes; Standard/climate
• Ni 100	Yes; Standard/climate
• Ni 100 according to GOST	Yes; Standard/climate
• Ni 1000	Yes; Standard/climate
• Ni 1000 according to GOST	Yes; Standard/climate
• LG-Ni 1000	Yes; Standard/climate
• Ni 120	Yes; Standard/climate
• Ni 120 according to GOST	Yes; Standard/climate
• Ni 200	Yes; Standard/climate
• Ni 200 according to GOST	Yes; Standard/climate
• Ni 500	Yes; Standard/climate
• Ni 500 according to GOST	Yes; Standard/climate
• Pt 10	Yes; Standard/climate
• Pt 10 according to GOST	Yes; Standard/climate
• Pt 50	Yes; Standard/climate
• Pt 50 according to GOST	Yes; Standard/climate
• Pt 100	Yes; Standard/climate
• Pt 100 according to GOST	Yes; Standard/climate
• Pt 1000	Yes; Standard/climate
• Pt 1000 according to GOST	Yes; Standard/climate
• Pt 200	Yes; Standard/climate
• Pt 200 according to GOST	Yes; Standard/climate
• Pt 500	Yes; Standard/climate
• Pt 500 according to GOST	Yes; Standard/climate
Input ranges (rated values), resistors	
• 0 to 150 ohms	Yes
• 0 to 300 ohms	Yes
• 0 to 600 ohms	Yes
• 0 to 3000 ohms	No
• 0 to 6000 ohms	Yes
• PTC	Yes
Thermocouple (TC) Temperature compensation	
- parameterizable	Yes
Cable length	
• shielded, max.	800 m; at U; 200 m at R/RTD/TC

SIMATIC S7-1500 Advanced Controllers

I/O modules

Analog modules

SM 531 analog input modules

Technical specifications (continued)

Article number	6ES7531-7PF00-0AB0 S7-1500, AI 8 X U/R/RTD/TC HF
Analog value generation for the inputs	
Integration and conversion time/resolution per channel	
<ul style="list-style-type: none"> Resolution with overrange (bit including sign), max. 	21 bit; For measuring mode RTC and TC when using the function "Scalable temperature measuring range" (32-bit REAL format); 16-bit for measuring mode R and U; 16 bits for all measuring modes when using the S7 format (16-bit INTEGER)
<ul style="list-style-type: none"> Integration time, parameterizable Integration time (ms) 	Yes Fast mode: 2.5 / 16.67 / 20 / 100 ms, standard mode: 7.5 / 50 / 60 / 300 ms
<ul style="list-style-type: none"> Basic conversion time, including integration time (ms) - additional conversion time for wire-break monitoring 	Fast mode: 4 / 18 / 22 / 102 ms; Standard mode: 9 / 52 / 62 / 302 ms Thermocouples, 150 Ohm, 300 Ohm, 600 Ohm, Cu10, Cu50, Cu100, Ni10, Ni50, Ni100, Ni120, Ni200, Pt10, Pt50, Pt100, Pt200: 4 ms; 6 kOhm, Ni500, Ni1000, LG-Ni1000, Pt500, Pt1000: 13 ms
<ul style="list-style-type: none"> Interference voltage suppression for interference frequency f1 in Hz Basic execution time of the module (all channels released) 	400 / 60 / 50 / 10 Hz Corresponds to the channel with the highest basic conversion time
Smoothing of measured values	
<ul style="list-style-type: none"> parameterizable 	Yes
Encoder	
Connection of signal encoders	
<ul style="list-style-type: none"> for voltage measurement for current measurement as 2-wire transducer for current measurement as 4-wire transducer for resistance measurement with two-wire connection for resistance measurement with three-wire connection for resistance measurement with four-wire connection 	Yes No No Yes Yes; All measuring ranges except PTC; internal compensation of the cable resistances Yes; All measuring ranges except PTC
Errors/accuracies	
Basic error limit (operational limit at 25 °C)	
<ul style="list-style-type: none"> Voltage, relative to input range, (+/-) Resistance, relative to input range, (+/-) Resistance thermometer, relative to input range, (+/-) Thermocouple, relative to input range, (+/-) 	0.05 % 0.05 % Cuxxx Standard: ±0.3 K, Cuxxx Klima: ±0.2 K, Ptxxx Standard: ±0.5 K, Ptxxx Klima: ±0.2 K, Nixxx Standard: ±0.3 K, Nixxx Klima: ±0.15 K Type B: > 600 °C ±1 K, Type E: > -200 °C ±0.5 K, Type J: > -210 °C ±0.5 K, Type K: > -200 °C ±1 K, Type N: > -200 °C ±1 K, Type R: > 0 °C ±1 K, Type S: > 0 °C ±1 K, Type T: > -200 °C ±0.5 K, Type C: ±2 K, Type TXK/TXK(L): ±0.5 K

Article number	6ES7531-7PF00-0AB0 S7-1500, AI 8 X U/R/RTD/TC HF	
Interference voltage suppression for f = n x (f1 +/- 1 %), f1 = interference frequency	<ul style="list-style-type: none"> Series mode interference (peak value of interference < rated value of input range), min. Common mode voltage, max. Common mode interference, min. 	80 dB; in the Standard operating mode, 40 dB in the Fast operating mode 60 V DC/30 V AC 80 dB
Isochronous mode		
Isochronous operation (application synchronized up to terminal)		No
Interrupts/diagnostics/status information		
Diagnostics function		Yes
Alarms		
<ul style="list-style-type: none"> Diagnostic alarm Limit value alarm 		Yes Yes; two upper and two lower limit values in each case
Diagnostic messages		
<ul style="list-style-type: none"> Monitoring the supply voltage Wire-break Overflow/underflow 		Yes Yes; Only with TC, R, RTD Yes
Diagnostics indication LED		
<ul style="list-style-type: none"> RUN LED ERROR LED Monitoring of the supply voltage (PWR-LED) Channel status display for channel diagnostics for module diagnostics 		Yes; Green LED Yes; Red LED Yes; Green LED Yes; Green LED Yes; Red LED Yes; Red LED
Potential separation		
Potential separation channels		
<ul style="list-style-type: none"> between the channels and backplane bus 		Yes
Isolation		
Isolation tested with		2 000 V DC between the channels and the supply voltage L+; 2 000 V DC between the channels and the backplane bus; 2 000 V DC between the channels; 707 V DC (type test) between the supply voltage L+ and the backplane bus
Ambient conditions		
Ambient temperature during operation		
<ul style="list-style-type: none"> horizontal installation, min. horizontal installation, max. vertical installation, min. vertical installation, max. 		0 °C 60 °C 0 °C 40 °C
Decentralized operation		
Prioritized startup		Yes
Dimensions		
Width		35 mm
Height		147 mm
Depth		129 mm
Weights		
Weight, approx.		290 g
Other		
Note:		For the R/RDT three-wire measurement, the conductor compensation is made alternating with the measurement. This then requires two module cycles for a measured value.

Ordering data	Article No.	Article No.
<p>SM 531 analog input modules</p> <p>4 x U/I/RTD/TC 4 analog inputs, ±10 V, ±5 V, ±2.5 V, ±1 V, ±500 mV, ±250 mV, ±80 mV, ±50 mV, 1 ... 5 V, 0/4 ... 20 mA, ±20 mA, thermocouples type B, E, J, K, N, R, S, T, resistance thermometers Ni 100, Ni 1000, LG-Ni 1000, Pt 100, Pt 1000, Pt 250, Pt 500, resistors 0...150/300/600/6000 ohms; 16 bit; incl. infeed element, shield bracket, shield terminal, labeling strips, U connector, printed front door</p> <p>8 x U/I HS 8 analog inputs, ±10 V, ±5 V, 1 ... 5 V or 0/4 ... 20 mA, ±20 mA, 16 bit + sign; incl. infeed element, shield bracket, shield terminal, labeling strips, U connector, printed front door</p> <p>8 x U/I/RTD/TC 8 analog inputs ±10 V, ±5 V, ±2.5 V, ±1 V, ±500 mV, ±250 mV, ±80 mV, ±50 mV, 1 ... 5 V, 0/4 ... 20 mA, ±20 mA, thermocouples type B, E, J, K, N, R, S, T, resistance thermometers Ni 100, Ni 1000, LG-Ni 1000, Pt 100, Pt 1000, Pt 250, Pt 500, resistors 0...150/300/600/6000 ohms, 16 bit; incl. infeed element, shield bracket, shield terminal, labeling strips, U connector, printed front door</p> <p>8 x U/I HF 8 analog inputs, ±10 V, ±5 V, 1 ... 5 V or 0/4 ... 20 mA, ±20 mA, 16 bit + sign; incl. infeed element, shield bracket, shield terminal, labeling strips, U connector, printed front door</p> <p>8 x U/R/RTD/TC 8 analog inputs, ±1 V, ±500 mV, ±250 mV, ±80 mV, ±50 mV, ±25 mV; thermocouples type B, E, J, K, N, R, S, T, TXK/TXK(L) according to GOST; resistance thermometers Cu 10, Cu 50, Cu 100, Ni 10, Ni 100, Ni 120, Ni 200, Ni 500, Ni 1000, LG-Ni 1000, Pt 10, Pt 50, Pt 100, Pt 200, Pt500, Pt 1000; resistors 0...150/300/600/6000 ohms, PTC; 16 bit; incl. infeed element, shield bracket, shield terminal, labeling strips, U connector, printed front door</p>	<p>6ES7531-7QD00-0AB0</p> <p>6ES7531-7NF10-0AB0</p> <p>6ES7531-7KF00-0AB0</p> <p>6ES7531-7NF00-0AB0</p> <p>6ES7531-7PF00-0AB0</p>	<p>Accessories</p> <p>Front connectors For 35 mm modules; including four potential bridges, cable ties and individual labeling strips, 40-pin • Screw terminals • Push-in For 25 mm modules; including cable ties and individual labeling strips; push-in terminal 40-pin; spare part</p> <p>DIN A4 labeling sheets For 35 mm modules; 10 sheets with 10 labeling strips each for I/O modules; perforated, Al gray For 25 mm modules; 10 sheets with 20 labeling strips each for I/O modules; perforated, Al gray</p> <p>U connector 5 units; spare part</p> <p>Universal front door for I/O modules For 35 mm modules; 5 front doors; with 5 labeling strips (front) and 5 cabling diagrams per front door; spare part For 25 mm modules; 5 front doors; with 5 labeling strips (front) and 5 cabling diagrams per front door; spare part</p> <p>Shielding set I/O For 35 mm modules; infeed element, shield bracket, and shield terminal; 5 units, spare part (one shield set supplied with the module). For 25 mm modules; infeed element, shield bracket, and shield terminal; 4 units, spare part (one shield set supplied with the module).</p> <p>Shield terminal element 10 units; spare part</p> <p>SIMATIC Manual Collection Electronic manuals on DVD, multi-language: LOGO!, SIMADYN, SIMATIC bus components, SIMATIC C7, SIMATIC distributed I/O, SIMATIC HMI, SIMATIC Sensors, SIMATIC NET, SIMATIC PC Based Automation, SIMATIC PCS 7, SIMATIC PG/PC, SIMATIC S7, SIMATIC Software, SIMATIC TDC</p> <p>SIMATIC Manual Collection update service for 1 year Current "Manual Collection" DVD and the three subsequent updates</p> <p>6ES7592-1AM00-0XB0 6ES7592-1BM00-0XB0 6ES7592-1BM00-0XA0</p> <p>6ES7592-2AX00-0AA0</p> <p>6ES7592-1AX00-0AA0</p> <p>6ES7590-0AA00-0AA0</p> <p>6ES7528-0AA00-7AA0</p> <p>6ES7528-0AA00-0AA0</p> <p>6ES7590-5CA00-0AA0</p> <p>6ES7590-5CA10-0XA0</p> <p>6ES7590-5BA00-0AA0</p> <p>6ES7998-8XC01-8YE0</p> <p>6ES7998-8XC01-8YE2</p>

SIMATIC S7-1500 Advanced Controllers

I/O modules

Analog modules

SM 532 analog output modules

Overview



- 2, 4 and 8-channel analog output modules
- Optionally with extremely short conversion times
- For connecting analog actuators without additional amplifiers
- Even solves more complex automation tasks

4

Technical specifications

Article number	6ES7532-5NB00-0AB0 S7-1500, AQ 2XU/I ST	6ES7532-5HD00-0AB0 S7-1500, AQ 4XU/I ST	6ES7532-5HF00-0AB0 S7-1500, AQ 8XU/I HS	6ES7532-5ND00-0AB0 S7-1500, AQ 4XU/I HF
General information				
Product type designation	AQ 2xU/I ST	AQ 4xU/I ST	AQ 8xU/I HS	AQ 4xU/I HF
Product function				
• I&M data	Yes; I&M0 to I&M3	Yes; I&M0 to I&M3	Yes; I&M0 to I&M3	Yes; I&M0 to I&M3
• Output range scalable	No	No	No	
Engineering with				
• STEP 7 TIA Portal configurable/ integrated as of version	V13 / V13.0.2	V12 / V12	V14 / -	V14 / -
• STEP 7 configurable/integrated as of version	V5.5 SP3 / -	V5.5 SP3 / -	V5.5 SP3 / -	V5.5 SP3 / -
• PROFIBUS as of GSD version/ GSD revision	V1.0 / V5.1	V1.0 / V5.1	V1.0 / V5.1	V1.0 / V5.1
• PROFINET as of GSD version/ GSD revision	V2.3 / -	V2.3 / -	V2.3 / -	V2.3 / -
Operating mode				
• Oversampling	No	No	Yes	No
• MSO	Yes	Yes	Yes	Yes
CiR – Configuration in RUN				
Reparameterization possible in RUN	Yes	Yes	Yes	Yes
Calibration possible in RUN	Yes	Yes	Yes	Yes
Supply voltage				
Type of supply voltage	DC	DC	DC	DC
Rated value (DC)	24 V	24 V	24 V	24 V
Reverse polarity protection	Yes	Yes	Yes	Yes
Analog outputs				
Number of analog outputs	2	4	8	4
Cycle time (all channels), min.	3.2 ms; independent of number of activated channels	3.2 ms; independent of number of activated channels	125 µs; independent of number of activated channels	125 µs; independent of number of activated channels
Output ranges, voltage				
• 0 to 10 V	Yes	Yes	Yes	Yes
• 1 V to 5 V	Yes	Yes	Yes	Yes
• -5 V to +5 V	No	No	No	No
• -10 V to +10 V	Yes	Yes	Yes	Yes

Technical specifications (continued)

Article number	6ES7532-5NB00-0AB0 S7-1500, AQ 2XU/I ST	6ES7532-5HD00-0AB0 S7-1500, AQ 4XU/I ST	6ES7532-5HF00-0AB0 S7-1500, AQ 8XU/I HS	6ES7532-5ND00-0AB0 S7-1500, AQ 4XU/I HF
Output ranges, current				
• 0 to 20 mA	Yes	Yes	Yes	Yes
• -20 mA to +20 mA	Yes	Yes	Yes	Yes
• 4 mA to 20 mA	Yes	Yes	Yes	Yes
Connection of actuators				
• for voltage output two-wire connection	Yes	Yes	Yes	Yes
• for voltage output four-wire connection	Yes	Yes	Yes	Yes
• for current output two-wire connection	Yes	Yes	Yes	Yes
Load impedance (in rated range of output)				
• with voltage outputs, min.	1 k Ω ; 0.5 k Ω m at 1 to 5 V	1 k Ω ; 0.5 k Ω m at 1 to 5 V	1 k Ω	1 k Ω ; 0.5 k Ω m at 1 to 5 V
• with voltage outputs, capacitive load, max.	1 μ F	1 μ F	100 nF	1 μ F
• with current outputs, max.	750 Ω	750 Ω	500 Ω	750 Ω
• with current outputs, inductive load, max.	10 mH	10 mH	1 mH	10 mH
Cable length				
• shielded, max.	800 m; for current, 200 m for voltage	800 m; for current, 200 m for voltage	200 m	800 m; for current, 200 m for voltage
Analog value generation for the outputs				
Integration and conversion time/ resolution per channel				
• Resolution with overrange (bit including sign), max.	16 bit	16 bit	16 bit	16 bit
• Conversion time (per channel)	0.5 ms	0.5 ms	50 μ s; independent of number of activated channels	125 μ s; independent of number of activated channels
Settling time				
• for resistive load	1.5 ms	1.5 ms	30 μ s; see additional description in the manual	0.2 ms; see additional description in the manual
• for capacitive load	2.5 ms	2.5 ms	100 μ s; see additional description in the manual	1.8 ms; see additional description in the manual
• for inductive load	2.5 ms	2.5 ms	100 μ s; see additional description in the manual	2 ms; see additional description in the manual
Errors/accuracies				
Basic error limit (operational limit at 25 °C)				
• Voltage, relative to output range, (+/-)	0.2 %	0.2 %	0.2 %	0.06 %
• Current, relative to output range, (+/-)	0.2 %	0.2 %	0.2 %	0.1 %
Isochronous mode				
Isochronous operation (application synchronized up to terminal)	No	No	Yes	Yes
Execution and activation time (TCO), min.			100 μ s	100 μ s
Bus cycle time (TDP), min.			250 μ s	250 μ s
Interrupts/diagnostics/ status information				
Diagnostics function	Yes	Yes	Yes	Yes
Substitute values connectable	Yes	Yes	Yes	Yes
Alarms				
• Diagnostic alarm	Yes	Yes	Yes	Yes

SIMATIC S7-1500 Advanced Controllers

I/O modules

Analog modules

SM 532 analog output modules**Technical specifications (continued)**

Article number	6ES7532-5NB00-0AB0 S7-1500, AQ 2XU/I ST	6ES7532-5HD00-0AB0 S7-1500, AQ 4XU/I ST	6ES7532-5HF00-0AB0 S7-1500, AQ 8XU/I HS	6ES7532-5ND00-0AB0 S7-1500, AQ 4XU/I HF
Diagnostic messages				
• Monitoring the supply voltage	Yes	Yes	Yes	Yes
• Wire-break	Yes; Only for output type "current"	Yes; Only for output type "current"	Yes; Only for output type "current"	Yes; Only for output type "current"
• Short-circuit	Yes; Only for output type "voltage"	Yes; Only for output type "voltage"	Yes; Only for output type "voltage"	Yes; Only for output type "voltage"
• Overflow/underflow	Yes	Yes	Yes	Yes
Diagnostics indication LED				
• RUN LED	Yes; Green LED	Yes; Green LED	Yes; Green LED	Yes; Green LED
• ERROR LED	Yes; Red LED	Yes; Red LED	Yes; Red LED	Yes; Red LED
• Monitoring of the supply voltage (PWR-LED)	Yes; Green LED	Yes; Green LED	Yes; Green LED	Yes; Green LED
• Channel status display	Yes; Green LED	Yes; Green LED	Yes; Green LED	Yes; Green LED
• for channel diagnostics	Yes; Red LED	Yes; Red LED	Yes; Red LED	Yes; Red LED
• for module diagnostics	Yes; Red LED	Yes; Red LED	Yes; Red LED	Yes; Red LED
Potential separation				
Potential separation channels				
• between the channels and backplane bus	Yes	Yes	Yes	Yes
Isolation				
Isolation tested with	707 V DC (type test)	707 V DC (type test)	707 V DC (type test)	2 000 V DC between the channels and the supply voltage L+; 2 000 V DC between the channels and the backplane bus; 2 000 V DC between the channels; 707 V DC (type test) between the supply voltage L+ and the backplane bus
Ambient conditions				
Ambient temperature during operation				
• horizontal installation, min.	0 °C			
• horizontal installation, max.	60 °C			
• vertical installation, min.	0 °C			
• vertical installation, max.	40 °C			
Decentralized operation				
Prioritized startup	No	No	No	Yes
Dimensions				
Width	25 mm	35 mm	35 mm	35 mm
Height	147 mm	147 mm	147 mm	147 mm
Depth	129 mm	129 mm	129 mm	129 mm
Weights				
Weight, approx.	200 g	310 g	325 g	300 g
Other				
Note:	Supplied incl. 40-pole push-in front connectors			

SIMATIC S7-1500 Advanced Controllers

I/O modules

Analog modules

SM 534 analog input/output modules

Overview



- 4 analog inputs/ 2 analog outputs
- For flexible adaptation of the controller to the corresponding task
- For subsequent expansion of the system with additional inputs and outputs
- For use in the tightest spaces

4

Technical specifications

Article number	6ES7534-7QE00-0AB0 S7-1500, AI 4X U/I/RTD/TC/AQ 2X U/I ST
General information	
Product type designation	AI 4xU/I/RTD/TC / AQ 2xU/I ST
Product function	
• I&M data	Yes; I&M0 to I&M3
• Measuring range scalable	No
• Scalable measured values	No
• Adjustment of measuring range	No
• Output range scalable	No
Engineering with	
• STEP 7 TIA Portal configurable/ integrated as of version	V13 / V13.0.2
• STEP 7 configurable/integrated as of version	V5.5 SP3 / -
• PROFIBUS as of GSD version/ GSD revision	V1.0 / V5.1
• PROFINET as of GSD version/ GSD revision	V2.3 / -
Operating mode	
• Oversampling	No
• MSI	Yes
• MSO	Yes
CiR – Configuration in RUN	
Reparameterization possible in RUN	Yes
Calibration possible in RUN	Yes
Supply voltage	
Type of supply voltage	DC
Rated value (DC)	24 V
Reverse polarity protection	Yes

Article number	6ES7534-7QE00-0AB0 S7-1500, AI 4X U/I/RTD/TC/AQ 2X U/I ST
Analog inputs	
Number of analog inputs	4
• For current measurement	4
• For voltage measurement	4
• For resistance/resistance thermometer measurement	2
• For thermocouple measurement	4
permissible input voltage for voltage input (destruction limit), max.	28.8 V
permissible input current for current input (destruction limit), max.	40 mA
Technical unit for temperature measurement adjustable	Yes; °C/°F/K
Analog input with oversampling	No
Standardization of measured values	No
Input ranges (rated values), voltages	
• 0 to +5 V	No
• 0 to +10 V	No
• 1 V to 5 V	Yes
• -1 V to +1 V	Yes
• -10 V to +10 V	Yes
• -2.5 V to +2.5 V	Yes
• -25 mV to +25 mV	No
• -250 mV to +250 mV	Yes
• -5 V to +5 V	Yes
• -50 mV to +50 mV	Yes
• -500 mV to +500 mV	Yes
• -80 mV to +80 mV	Yes
Input ranges (rated values), currents	
• 0 to 20 mA	Yes
• -20 mA to +20 mA	Yes
• 4 mA to 20 mA	Yes

Technical specifications (continued)

Article number	6ES7534-7QE00-0AB0 S7-1500, AI 4X U/I/RTD/TC/AQ 2X U/I ST	Article number	6ES7534-7QE00-0AB0 S7-1500, AI 4X U/I/RTD/TC/AQ 2X U/I ST
Input ranges (rated values), thermocouples		Thermocouple (TC)	
• Type B	Yes	Temperature compensation	
• Type C	No	- parameterizable	
• Type E	Yes	Yes	
• Type J	Yes	Cable length	
• Type K	Yes	• shielded, max.	
• Type L	No	800 m; for U/I, 200 m for R/RTD, 50 m for TC	
• Type N	Yes	Analog outputs	
• Type R	Yes	Number of analog outputs	
• Type S	Yes	2	
• Type T	Yes	Cycle time (all channels), min.	
• Type U	No	3.2 ms; ±0.5 ms, regardless of the number of activated channels	
• Type TXK/TXK(L) to GOST	No	Output ranges, voltage	
Input ranges (rated values), resistance thermometer		• 0 to 10 V	
• Cu 10	No	• 1 V to 5 V	
• Cu 10 according to GOST	No	• -5 V to +5 V	
• Cu 50	No	• -10 V to +10 V	
• Cu 50 according to GOST	No	Output ranges, current	
• Cu 100	No	• 0 to 20 mA	
• Cu 100 according to GOST	No	• -20 mA to +20 mA	
• Ni 10	No	• 4 mA to 20 mA	
• Ni 10 according to GOST	No	Connection of actuators	
• Ni 100	Yes; Standard/climate	• for voltage output two-wire connection	
• Ni 100 according to GOST	No	• for voltage output four-wire connection	
• Ni 1000	Yes; Standard/climate	• for current output two-wire connection	
• Ni 1000 according to GOST	No	Load impedance (in rated range of output)	
• LG-Ni 1000	Yes; Standard/climate	• with voltage outputs, min.	
• Ni 120	No	1 kΩ; 0.5 kΩ at 1 to 5 V	
• Ni 120 according to GOST	No	• with voltage outputs, capacitive load, max.	
• Ni 200	No	1 μF	
• Ni 200 according to GOST	No	• with current outputs, max.	
• Ni 500	No	750 Ω	
• Ni 500 according to GOST	No	• with current outputs, inductive load, max.	
• Pt 10	No	10 mH	
• Pt 10 according to GOST	No	Cable length	
• Pt 50	No	• shielded, max.	
• Pt 50 according to GOST	No	800 m; for current, 200 m for voltage	
• Pt 100	Yes; Standard/climate	Analog value generation for the inputs	
• Pt 100 according to GOST	No	Integration and conversion time/ resolution per channel	
• Pt 1000	Yes; Standard/climate	• Resolution with overrange (bit including sign), max.	
• Pt 1000 according to GOST	No	16 bit	
• Pt 200	Yes; Standard/climate	• Integration time, parameterizable	
• Pt 200 according to GOST	No	• Integration time (ms)	
• Pt 500	Yes; Standard/climate	• Basic conversion time, including integration time (ms)	
• Pt 500 according to GOST	No	- additional conversion time for wire-break monitoring	
Input ranges (rated values), resistors		- additional conversion time for resistance measurement	
• 0 to 150 ohms	Yes	150 ohm, 300 ohm, 600 ohm, Pt100, Pt200, Ni100: 2 ms, 6000 ohm, Pt500, Pt1000, Ni1000, LG-Ni1000, PTC: 4 ms	
• 0 to 300 ohms	Yes	400 / 60 / 50 / 10	
• 0 to 600 ohms	Yes	Smoothing of measured values	
• 0 to 3000 ohms	No	• parameterizable	
• 0 to 6000 ohms	Yes	Yes	
• PTC	Yes		

SIMATIC S7-1500 Advanced Controllers

I/O modules

Analog modules

SM 534 analog input/output modules

Technical specifications (continued)

Article number	6ES7534-7QE00-0AB0 S7-1500, AI 4X U/I/RTD/TC/AQ 2X U/I ST
Analog value generation for the outputs	
Integration and conversion time/resolution per channel	
• Resolution with overrange (bit including sign), max.	16 bit
• Conversion time (per channel)	0.5 ms
Settling time	
• for resistive load	1.5 ms
• for capacitive load	2.5 ms
• for inductive load	2.5 ms
Encoder	
Connection of signal encoders	
• for voltage measurement	Yes
• for current measurement as 2-wire transducer	Yes
- Burden of 2-wire transmitter, max.	820 Ω
• for current measurement as 4-wire transducer	Yes
• for resistance measurement with two-wire connection	Yes; Only for PTC
• for resistance measurement with three-wire connection	Yes; All measuring ranges except PTC; internal compensation of the cable resistances
• for resistance measurement with four-wire connection	Yes; All measuring ranges except PTC
Errors/accuracies	
Basic error limit (operational limit at 25 °C)	
• Voltage, relative to input range, (+/-)	0.1 %
• Current, relative to input range, (+/-)	0.1 %
• Resistance, relative to input range, (+/-)	0.1 %
• Resistance thermometer, relative to input range, (+/-)	0.1 %; Ptxxx standard: ±0.7 K, Ptxxx climate: ±0.2 K, Nixxx standard: ±0.3 K, Nixxx climate: ±0.15 K
• Thermocouple, relative to input range, (+/-)	0.1 %; Type B: > 600 °C ±1.7 K, type E: > -200 °C ±0.7 K, type J: > -210 °C ±0.8 K, type K: > -200 °C ±1.2 K, type N: > -200 °C ±1.2 K, type R: > 0 °C ±1.9 K, type S: > 0 °C ±1.9 K, type T: > -200 °C ±0.8 K
• Voltage, relative to output range, (+/-)	0.2 %
• Current, relative to output range, (+/-)	0.2 %
Interference voltage suppression for $f = n \times (f_1 \pm 1 \%)$, $f_1 =$ interference frequency	
• Series mode interference (peak value of interference < rated value of input range), min.	40 dB
• Common mode voltage, max.	10 V
• Common mode interference, min.	60 dB
Isochronous mode	
Isochronous operation (application synchronized up to terminal)	No

Article number	6ES7534-7QE00-0AB0 S7-1500, AI 4X U/I/RTD/TC/AQ 2X U/I ST
Interrupts/diagnostics/status information	
Diagnostics function	Yes
Substitute values connectable	Yes
Alarms	
• Diagnostic alarm	Yes
• Limit value alarm	Yes; two upper and two lower limit values in each case
Diagnostic messages	
• Monitoring the supply voltage	Yes
• Wire-break	Yes; only for input type 1 ... 5 V, 4 ... 20 mA, TC, R, RTD and output type current
• Short-circuit	Yes; Only for output type "voltage"
• Overflow/underflow	Yes
Diagnostics indication LED	
• RUN LED	Yes; Green LED
• ERROR LED	Yes; Red LED
• Monitoring of the supply voltage (PWR-LED)	Yes; Green LED
• Channel status display	Yes; Green LED
• for channel diagnostics	Yes; Red LED
• for module diagnostics	Yes; Red LED
Potential separation	
Potential separation analog inputs	
• between the channels and backplane bus	Yes
Potential separation analog outputs	
• between the channels and backplane bus	Yes
Isolation	
Isolation tested with	707 V DC (type test)
Ambient conditions	
Ambient temperature during operation	
• horizontal installation, min.	0 °C
• horizontal installation, max.	60 °C
• vertical installation, min.	0 °C
• vertical installation, max.	40 °C
Decentralized operation	
Prioritized startup	No
Dimensions	
Width	25 mm
Height	147 mm
Depth	129 mm
Weights	
Weight, approx.	250 g
Other	
Note:	Supplied incl. 40-pole push-in front connectors. Additional basic error and noise for integration time = 2.5 ms: Voltage: ±250 mV (±0.02%), ±80 mV (±0.05%), ±50 mV (±0.05%); resistance: 150 Ohms (±0.02%); resistance thermometer: Pt100 climate: ±0.08 K, Ni100 climate: ±0.08 K; thermoelement: Type B, R, S: ±3 K, type E, J, K, N, T: ±1 K

Ordering data	Article No.	Accessories	Article No.
<p>SM 534 analog input/output module</p> <p>Module width 25 mm</p> <p>4 analog inputs ± 10 V, ± 5 V, ± 2.5 V, ± 1 V, ± 500 mV, ± 250 mV, ± 80 mV, ± 50 mV, 1 ... 5 V, 0/4 ... 20 mA, ± 20 mA, thermocouples type B, E, J, K, N, R, S, T, resistance thermometers Ni 100, Ni 1000, LG-Ni 1000, Pt 100, Pt 1000, Pt 250, Pt 500, resistors 0...150/300/600/6000 Ohm, 16 bit; 2 analog outputs, ± 10 V, 1 ... 5 V, 0 ... 10 V or ± 20 mA, 0/4 ... 20 mA, 16 bit; incl. infeed element, shield bracket, shield terminal, labeling strips, U connector, printed front door</p>	<p>6ES7534-7QE00-0AB0</p>	<p>Front connectors</p> <p>For 25 mm modules; including cable ties and individual labeling strips; push-in terminal 40-pin; spare part</p> <p>DIN A4 labeling sheets</p> <p>For 25 mm modules; 10 sheets with 20 labeling strips each for I/O modules; perforated, Al gray</p> <p>U connector</p> <p>5 units; spare part</p> <p>Universal front door for I/O modules</p> <p>For 25 mm modules; 5 front doors; with 5 labeling strips (front) and 5 cabling diagrams per front door; spare part</p> <p>Shielding set I/O</p> <p>For 25 mm modules; infeed element, shield bracket, and shield terminal; 4 units, spare part (one shield set supplied with the module).</p> <p>Shield terminal element</p> <p>10 units; spare part</p> <p>SIMATIC Manual Collection</p> <p>Electronic manuals on DVD, multi-language: LOGO!, SIMADYN, SIMATIC bus components, SIMATIC C7, SIMATIC distributed I/O, SIMATIC HMI, SIMATIC Sensors, SIMATIC NET, SIMATIC PC Based Automation, SIMATIC PCS 7, SIMATIC PG/PC, SIMATIC S7, SIMATIC Software, SIMATIC TDC</p> <p>SIMATIC Manual Collection update service for 1 year</p> <p>Current "Manual Collection" DVD and the three subsequent updates</p>	<p>6ES7592-1BM00-0XA0</p> <p>6ES7592-1AX00-0AA0</p> <p>6ES7590-0AA00-0AA0</p> <p>6ES7528-0AA00-0AA0</p> <p>6ES7590-5CA10-0XA0</p> <p>6ES7590-5BA00-0AA0</p> <p>6ES7998-8XC01-8YE0</p> <p>6ES7998-8XC01-8YE2</p>

SIMATIC S7-1500 Advanced Controllers

I/O modules

SIPLUS analog modules

SIPLUS SM 531 analog input modules

Overview



- 8-channel analog input modules
- Optionally with extremely short conversion times
- For the connection of analog sensors without additional amplifiers
- Even solves more complex automation tasks

Note:

SIPLUS extreme products are based on SIMATIC standard products. The contents listed here were taken from the respective standard products. SIPLUS extreme-specific information was added.

Technical specifications

Article number	6AG1531-7NF10-7AB0	6AG1531-7KF00-7AB0
Based on	6ES7531-7NF10-0AB0 SIPLUS S7-1500 AI 8XU/I HS	6ES7531-7KF00-0AB0 SIPLUS S7-1500 AI 8XU/I/RTD/TC ST
Ambient conditions		
Ambient temperature during operation		
• horizontal installation, min.	-40 °C; = Tmin; Startup @ -25 °C	-40 °C; = Tmin; Startup @ -25 °C
• horizontal installation, max.	70 °C; = Tmax; > +60 °C max. 4x ±20 mA or 4x ±10 V permissible	70 °C; = Tmax; > +60 °C max. 2x ±20 mA or 4x ±10 V or 4x RTD permissible
• vertical installation, min.	-40 °C; = Tmin; Startup @ -25 °C	-40 °C; = Tmin; Startup @ -25 °C
• vertical installation, max.	40 °C; = Tmax	50 °C; = Tmax
Extended ambient conditions		
• relative to ambient temperature-atmospheric pressure-installation altitude	Tmin ... Tmax at 1080 hPa ... 795 hPa (-1000 m ... +2000 m) // Tmin ... (Tmax - 10K) at 795 hPa ... 658 hPa (+2000 m ... +3500 m) // Tmin ... (Tmax - 20K) at 658 hPa ... 540 hPa (+3500 m ... +5000 m)	Tmin ... Tmax at 1080 hPa ... 795 hPa (-1000 m ... +2000 m) // Tmin ... (Tmax - 10K) at 795 hPa ... 658 hPa (+2000 m ... +3500 m) // Tmin ... (Tmax - 20K) at 658 hPa ... 540 hPa (+3500 m ... +5000 m)
Relative humidity		
- With condensation, tested in accordance with IEC 60068-2-38, max.	100 %; RH incl. condensation/frost (no commissioning under condensation conditions)	100 %; RH incl. condensation/frost (no commissioning under condensation conditions)
Resistance		
- against biologically active substances / conformity with EN 60721-3-3	Yes; Class 3B2 mold, fungus and dry rot spores (with the exception of fauna). The supplied connector covers must remain on the unused interfaces during operation!	Yes; Class 3B2 mold, fungus and dry rot spores (with the exception of fauna). The supplied connector covers must remain on the unused interfaces during operation!
- against chemically active substances / conformity with EN 60721-3-3	Yes; Class 3C4 (RH < 75%) incl. salt spray according to EN 60068-2-52 (degree of severity 3). The supplied connector covers must remain on the unused interfaces during operation!	Yes; Class 3C4 (RH < 75%) incl. salt spray according to EN 60068-2-52 (degree of severity 3). The supplied connector covers must remain on the unused interfaces during operation!
- against mechanically active substances / conformity with EN 60721-3-3	Yes; Class 3S4 incl. sand, dust. The supplied connector covers must remain on the unused interfaces during operation!	Yes; Class 3S4 incl. sand, dust. The supplied connector covers must remain on the unused interfaces during operation!

Ordering data	Article No.	Accessories	Article No.
<p>SIPLUS SM 531 analog input modules</p> <p>(Extended temperature range and exposure to media)</p> <p>8 analog inputs, ± 10 V, ± 5 V, 1 ... 5 V or 0/4 ... 20 mA, ± 20 mA, 16 bit + sign; incl. infeed element, shield bracket, shield terminal, labeling strips, U connector, printed front door</p> <p>8 analog inputs ± 10 V, ± 5 V, ± 2.5 V, ± 1 V, ± 500 mV, ± 250 mV, ± 80 mV, ± 50 mV, 1 ... 5 V, 0/4 ... 20 mA, ± 20 mA, thermocouples type B, E, J, K, N, R, S, T, resistance thermometers Ni 100, Ni 1000, LG-Ni 1000, Pt 100, Pt 1000, Pt 250, Pt 500, resistors 0...150/300/600/6000 Ohm, 16 bit</p>	<p>6AG1531-7NF10-7AB0</p> <p>6AG1531-7KF00-7AB0</p>	<p>Accessories</p>	<p>See SIMATIC S7-1500 SM 531 analog input modules, page 4/87</p>

SIMATIC S7-1500 Advanced Controllers

I/O modules

SIPLUS analog modules

SIPLUS SM 532 analog output modules**Overview**

- 4 and 8-channel analog output modules
- Optionally with extremely short conversion times
- For connecting analog actuators without additional amplifiers
- Even solves more complex automation tasks

Note:

SIPLUS extreme products are based on SIMATIC standard products. The contents listed here were taken from the respective standard products. SIPLUS extreme-specific information was added.

Technical specifications

Article number	6AG1532-5HD00-7AB0	6AG1532-5HF00-7AB0
Based on	6ES7532-5HD00-0AB0 SIPLUS S7-1500 AQ 4XU/I ST	6ES7532-5HF00-0AB0 SIPLUS S7-1500 AQ 8XU/I HS
Ambient conditions		
Ambient temperature during operation		
• horizontal installation, min.	-25 °C; = Tmin	-40 °C; = Tmin; Startup @ -25 °C
• horizontal installation, max.	70 °C; = Tmax; > +60 °C max. 4x ±10 V permissible	70 °C; = Tmax; > +60 °C max. 4x ±10 V permissible
• vertical installation, min.	-25 °C; = Tmin	-40 °C; = Tmin; Startup @ -25 °C
• vertical installation, max.	40 °C; = Tmax	40 °C; = Tmax
Extended ambient conditions		
• relative to ambient temperature-atmospheric pressure-installation altitude	Tmin ... Tmax at 1080 hPa ... 795 hPa (-1000 m ... +2000 m) // Tmin ... (Tmax - 10K) at 795 hPa ... 658 hPa (+2000 m ... +3500 m) // Tmin ... (Tmax - 20K) at 658 hPa ... 540 hPa (+3500 m ... +5000 m)	Tmin ... Tmax at 1080 hPa ... 795 hPa (-1000 m ... +2000 m) // Tmin ... (Tmax - 10K) at 795 hPa ... 658 hPa (+2000 m ... +3500 m) // Tmin ... (Tmax - 20K) at 658 hPa ... 540 hPa (+3500 m ... +5000 m)
Relative humidity		
- With condensation, tested in accordance with IEC 60068-2-38, max.	100 %; RH incl. condensation/frost (no commissioning under condensation conditions)	100 %; RH incl. condensation/frost (no commissioning under condensation conditions)
Resistance		
- against biologically active substances / conformity with EN 60721-3-3	Yes; Class 3B2 mold, fungus and dry rot spores (with the exception of fauna). The supplied connector covers must remain on the unused interfaces during operation!	Yes; Class 3B2 mold, fungus and dry rot spores (with the exception of fauna). The supplied connector covers must remain on the unused interfaces during operation!
- against chemically active substances / conformity with EN 60721-3-3	Yes; Class 3C4 (RH < 75%) incl. salt spray according to EN 60068-2-52 (degree of severity 3). The supplied connector covers must remain on the unused interfaces during operation!	Yes; Class 3C4 (RH < 75%) incl. salt spray according to EN 60068-2-52 (degree of severity 3). The supplied connector covers must remain on the unused interfaces during operation!
- against mechanically active substances / conformity with EN 60721-3-3	Yes; Class 3S4 incl. sand, dust. The supplied connector covers must remain on the unused interfaces during operation!	Yes; Class 3S4 incl. sand, dust. The supplied connector covers must remain on the unused interfaces during operation!

Ordering data	Article No.	Accessories	Article No.
<p>SIPLUS SM 532 analog output modules</p> <p>(Extended temperature range and exposure to media)</p> <p>4 analog outputs, ± 10 V, 1 ... 5 V, 0 ... 10 V or ± 20 mA, 0/4 ... 20 mA, 16 bit</p> <p>8 analog outputs, ± 10 V, 1 ... 5 V, 0 ... 10 V or ± 20 mA, 0/4 ... 20 mA, 16 bit; incl. infeed element, shield bracket, shield terminal, labeling strips, U connector, printed front door</p>	<p>6AG1532-5HD00-7AB0</p> <p>6AG1532-5HF00-7AB0</p>	<p>Accessories</p>	<p>See SIMATIC S7-1500 SM 532 analog output modules, page 4/91</p>

SIMATIC S7-1500 Advanced Controllers

I/O modules

Technology modules

TM Count 2x24V counter module

Overview



- 2-channel high-speed counter module
- With comprehensive parameterization options for an optimum adaptation to the task and reduction of control load
- Speed and time period measuring
- Storage and comparison functions
- Connection of 24 V encoders

4

Technical specifications

Article number	6ES7550-1AA00-0AB0 S7-1500, TM COUNT 2X24V
General information	
Product type designation	TM Count 2x24V
Product function	
• I&M data	Yes; I&M 0
Engineering with	
• STEP 7 TIA Portal configurable/integrated as of version	V12 / V12
• STEP 7 configurable/integrated as of version	V5.5 SP3 / -
• PROFINET as of GSD version/GSD revision	V2.3 / -
Installation type/mounting	
Rail mounting	Yes; S7-1500 mounting rail
Supply voltage	
Load voltage L+	
• Rated value (DC)	24 V
• Reverse polarity protection	Yes
Input current	
Current consumption, max.	75 mA; without load
Encoder supply	
Number of outputs	1; A common 24V encoder supply for both channels
24 V encoder supply	
• 24 V	Yes; L+ (-0.8 V)
• Short-circuit protection	Yes
• Output current, max.	1 A; total current of all encoders/channels
Power	
Power available from the backplane bus	1.3 W
Power loss	
Power loss, typ.	4 W

Article number	6ES7550-1AA00-0AB0 S7-1500, TM COUNT 2X24V
Digital inputs	
Number of digital inputs	6; 3 per channel
Digital inputs, parameterizable	Yes
Input characteristic curve in accordance with IEC 61131, type 3	Yes
Digital input functions, parameterizable	
• Gate start/stop	Yes
• Capture	Yes
• Synchronization	Yes
• Freely usable digital input	Yes
Input voltage	
• Type of input voltage	DC
• Rated value (DC)	24 V
• for signal "0"	-30 to +5V
• for signal "1"	+11 to +30V
• permissible voltage at input, min.	-30 V
• permissible voltage at input, max.	30 V
Input current	
• for signal "1", typ.	2.5 mA
Input delay (for rated value of input voltage) for standard inputs	
- parameterizable	Yes; none / 0.05 / 0.1 / 0.4 / 0.8 / 1.6 / 3.2 / 12.8 / 20 ms
- at "0" to "1", min.	6 µs; for parameterization "none"
- at "1" to "0", min.	6 µs; for parameterization "none"
for counter/technological functions	
- parameterizable	Yes
Cable length	
• shielded, max.	1 000 m
• unshielded, max.	600 m

Technical specifications (continued)

Article number	6ES7550-1AA00-0AB0 S7-1500, TM COUNT 2X24V
Digital outputs	
Type of digital output	Transistor
Number of digital outputs	4; 2 per channel
Digital outputs, parameterizable	Yes
Short-circuit protection	Yes; electronic/thermal
Limitation of inductive shutdown voltage to	L+ (-33 V)
Controlling a digital input	Yes
Digital output functions, parameterizable	
• Switching tripped by comparison values	Yes
• Freely usable digital output	Yes
Switching capacity of the outputs	
• with resistive load, max.	0.5 A; Per digital output
• on lamp load, max.	5 W
Load resistance range	
• lower limit	48 Ω
• upper limit	12 kΩ
Output voltage	
• Type of output voltage	DC
• for signal "1", min.	23.2 V; L+ (-0.8 V)
Output current	
• for signal "1" rated value	0.5 A; Per digital output
• for signal "0" residual current, max.	0.5 mA
Output delay with resistive load	
• "0" to "1", max.	50 μs
• "1" to "0", max.	50 μs
Switching frequency	
• with resistive load, max.	10 kHz
• with inductive load, max.	0.5 Hz; Acc. to IEC 60947-5-1, DC-13; observe derating curve
• on lamp load, max.	10 Hz
Total current of the outputs	
• Current per module, max.	2 A
Cable length	
• shielded, max.	1 000 m
• unshielded, max.	600 m
Encoder	
Connectable encoders	
• 2-wire sensor	Yes
- permissible quiescent current (2-wire sensor), max.	1.5 mA
Encoder signals, incremental encoder (asymmetrical)	
• Input voltage	24 V
• Input frequency, max.	200 kHz
• Counting frequency, max.	800 kHz; with quadruple evaluation
• Cable length, shielded, max.	600 m; depending on input frequency, encoder and cable quality; max. 50 m at 200 kHz
• Signal filter, parameterizable	Yes
• Incremental encoder with A/B tracks, 90° phase offset	Yes
• Incremental encoder with A/B tracks, 90° phase offset and zero track	Yes
• Pulse encoder	Yes
• Pulse encoder with direction	Yes
• Pulse encoder with one impulse signal per count direction	Yes

Article number	6ES7550-1AA00-0AB0 S7-1500, TM COUNT 2X24V
Encoder signal 24 V	
- permissible voltage at input, min.	-30 V
- permissible voltage at input, max.	30 V
Interface types	
• Input characteristic curve in accordance with IEC 61131, type 3	Yes
• Source/sink input	Yes
Isochronous mode	
Isochronous operation (application synchronized up to terminal)	Yes
Filtering and processing time (TCI), min.	130 μs
Bus cycle time (TDP), min.	250 μs
Interrupts/diagnostics/status information	
Alarms	
• Diagnostic alarm	Yes
• Hardware interrupt	Yes
Diagnostic messages	
• Monitoring the supply voltage	Yes
• Wire-break	Yes
• Short-circuit	Yes
• A/B transition error at incremental encoder	Yes
Diagnostics indication LED	
• RUN LED	Yes; Green LED
• ERROR LED	Yes; Red LED
• MAINT LED	Yes; yellow LED
• Monitoring of the supply voltage (PWR-LED)	Yes; Green LED
• Channel status display	Yes; Green LED
• for channel diagnostics	Yes; Red LED
• Status indicator backward counting (green)	Yes
• Status indicator forward counting (green)	Yes
Integrated Functions	
Number of counters	2
Counting frequency (counter) max.	800 kHz; with quadruple evaluation
Counting functions	
• Continuous counting	Yes
• Counter response parameterizable	Yes
• Hardware gate via digital input	Yes
• Software gate	Yes
• Event-controlled stop	Yes
• Synchronization via digital input	Yes
• Counting range, parameterizable	Yes
Comparator	
- Number of comparators	2; Per channel
- Direction dependency	Yes
- Can be changed from user program	Yes
Position detection	
• Incremental acquisition	Yes
• Suitable for S7-1500 Motion Control	Yes

SIMATIC S7-1500 Advanced Controllers

I/O modules

Technology modules

TM Count 2x24V counter module

Technical specifications (continued)

Article number	6ES7550-1AA00-0AB0 S7-1500, TM COUNT 2X24V
Measuring functions	
• Measuring time, parameterizable	Yes
• Dynamic measurement period adjustment	Yes
• Number of thresholds, parameterizable	2
Measuring range	
- Frequency measurement, min.	0.04 Hz
- Frequency measurement, max.	800 kHz
- Cycle duration measurement, min.	1.25 µs
- Cycle duration measurement, max.	25 s
Accuracy	
- Frequency measurement	100 ppm; depending on measuring interval and signal evaluation
- Cycle duration measurement	100 ppm; depending on measuring interval and signal evaluation
- Velocity measurement	100 ppm; depending on measuring interval and signal evaluation
Potential separation	
Potential separation channels	
• between the channels	No
• between the channels and backplane bus	Yes
• Between the channels and load voltage L+	No
Isolation	
Isolation tested with	707 V DC (type test)
Ambient conditions	
Ambient temperature during operation	
• horizontal installation, min.	0 °C
• horizontal installation, max.	60 °C; Please note derating for inductive loads
• vertical installation, min.	0 °C
• vertical installation, max.	40 °C; Please note derating for inductive loads
Decentralized operation	
to SIMATIC S7-1500	Yes
to standard PROFINET controller	Yes
Dimensions	
Width	35 mm
Height	147 mm
Depth	129 mm
Weights	
Weight, approx.	250 g

Ordering data

Article No.

TM Count 2x24V counter module	6ES7550-1AA00-0AB0
With 2 channels, max. 200 kHz; for 24 V encoder	
Accessories	
Front connectors	
For 35 mm modules; including four potential bridges, cable ties and individual labeling strips, 40-pin	
• Screw terminals	6ES7592-1AM00-0XB0
• Push-in	6ES7592-1BM00-0XB0
DIN A4 labeling sheets	
10 sheets with 10 labeling strips each for I/O modules; perforated, Al grey	
DIN A4 labeling sheets	
6ES7592-2AX00-0AA0	
U connector	
5 units; spare part	
Universal front door for I/O modules	
5 front doors; with 5 labeling strips (front) and 5 cabling diagrams per front door; spare part	
Shielding set I/O	
6ES7590-5CA00-0AA0	
Infeed element, shield bracket, and shield terminal; 5 units, spare part	
Shield terminal element	
6ES7590-5BA00-0AA0	
10 units; spare part	
SIMATIC Manual Collection	
6ES7998-8XC01-8YE0	
Electronic manuals on DVD, multi-language: LOGO!, SIMADYN, SIMATIC bus components, SIMATIC C7, SIMATIC distributed I/O, SIMATIC HMI, SIMATIC Sensors, SIMATIC NET, SIMATIC PC Based Automation, SIMATIC PCS 7, SIMATIC PG/PC, SIMATIC S7, SIMATIC Software, SIMATIC TDC	
SIMATIC Manual Collection update service for 1 year	
6ES7998-8XC01-8YE2	
Current "Manual Collection" DVD and the three subsequent updates	

Overview



- 2-channel counting and position detection module with RS 422 interface
- Extensive parameterization options for optimum task-specific adaptation
- Reduces load on controller due to preprocessing on the module
- Position detection with incremental and SSI absolute encoders
- Speed and time period measuring
- Storage and comparison functions
- Connection of encoders with RS 422 signals or 5V-TTL signals

Technical specifications

Article number	6ES7551-1AB00-0AB0 S7-1500, TM POSINPUT 2
General information	
Product type designation	TM PosInput 2
Product function	
• I&M data	Yes; I&M 0
Engineering with	
• STEP 7 TIA Portal configurable/integrated as of version	V12 SP1 / V12 SP1
• STEP 7 configurable/integrated as of version	V5.5 SP3 / -
• PROFINET as of GSD version/GSD revision	V2.3 / -
Installation type/mounting	
Rail mounting	Yes; S7-1500 mounting rail
Supply voltage	
Load voltage L+	
• Rated value (DC)	24 V
• Reverse polarity protection	Yes
Input current	
Current consumption, max.	75 mA; without load
Encoder supply	
Number of outputs	4; One 5V and 24V encoder supply per channel
5 V encoder supply	
• 5 V	Yes; 5.2 V +/-2%
• short-circuit protection	Yes
• Output current, max.	300 mA; Per channel
24 V encoder supply	
• 24 V	Yes; L+ (-0.8 V)
• Short-circuit protection	Yes
• Output current, max.	300 mA; Per channel
Power	
Power available from the backplane bus	1.3 W
Power loss	
Power loss, typ.	5.5 W

Article number	6ES7551-1AB00-0AB0 S7-1500, TM POSINPUT 2
Digital inputs	
Number of digital inputs	4; 2 per channel
Digital inputs, parameterizable	Yes
Input characteristic curve in accordance with IEC 61131, type 3	Yes
Digital input functions, parameterizable	
• Gate start/stop	Yes; only for pulse and incremental encoders
• Capture	Yes
• Synchronization	Yes; only for pulse and incremental encoders
• Freely usable digital input	Yes
Input voltage	
• Type of input voltage	DC
• Rated value (DC)	24 V
• for signal "0"	-30 to +5V
• for signal "1"	+11 to +30V
• permissible voltage at input, min.	-30 V
• permissible voltage at input, max.	30 V
Input current	
• for signal "1", typ.	2.5 mA
Input delay (for rated value of input voltage) for standard inputs	
- parameterizable	Yes; none / 0.05 / 0.1 / 0.4 / 0.8 / 1.6 / 3.2 / 12.8 / 20 ms
- at "0" to "1", min.	6 µs; for parameterization "none"
- at "1" to "0", min.	6 µs; for parameterization "none"
for counter/technological functions	
- parameterizable	Yes
Cable length	
• shielded, max.	1 000 m
• unshielded, max.	600 m

SIMATIC S7-1500 Advanced Controllers

I/O modules

Technology modules

TM PosInput 2 counting and position detection module

Technical specifications (continued)

Article number	6ES7551-1AB00-0AB0 S7-1500, TM POSINPUT 2
Digital outputs	
Type of digital output	Transistor
Number of digital outputs	4; 2 per channel
Digital outputs, parameterizable	Yes
Short-circuit protection	Yes; electronic/thermal
Limitation of inductive shutdown voltage to	L+ (-33 V)
Controlling a digital input	Yes
Digital output functions, parameterizable	
• Switching tripped by comparison values	Yes
• Freely usable digital output	Yes
Switching capacity of the outputs	
• with resistive load, max.	0.5 A; Per digital output
• on lamp load, max.	5 W
Load resistance range	
• lower limit	48 Ω
• upper limit	12 kΩ
Output voltage	
• Type of output voltage	DC
• for signal "1", min.	23.2 V; L+ (-0.8 V)
Output current	
• for signal "1" rated value	0.5 A; Per digital output
• for signal "0" residual current, max.	0.5 mA
Output delay with resistive load	
• "0" to "1", max.	50 μs
• "1" to "0", max.	50 μs
Switching frequency	
• with resistive load, max.	10 kHz
• with inductive load, max.	0.5 Hz; Acc. to IEC 60947-5-1, DC-13; observe derating curve
• on lamp load, max.	10 Hz
Total current of the outputs	
• Current per module, max.	2 A
Cable length	
• shielded, max.	1 000 m
• unshielded, max.	600 m
Encoder signals, incremental encoder (symmetrical)	
• Input voltage	RS 422
• Input frequency, max.	1 MHz
• Counting frequency, max.	4 MHz; with quadruple evaluation
• Cable length, shielded, max.	32 m; at 1 MHz
• Signal filter, parameterizable	Yes
• Incremental encoder with A/B tracks, 90° phase offset	Yes
• Incremental encoder with A/B tracks, 90° phase offset and zero track	Yes
• Pulse encoder	Yes
• Pulse encoder with direction	Yes
• Pulse encoder with one impulse signal per count direction	Yes

Article number	6ES7551-1AB00-0AB0 S7-1500, TM POSINPUT 2
Encoder signals, incremental encoder (asymmetrical)	
• Input voltage	5 V TTL (push-pull encoders only)
• Input frequency, max.	1 MHz
• Counting frequency, max.	4 MHz; with quadruple evaluation
• Signal filter, parameterizable	Yes
• Incremental encoder with A/B tracks, 90° phase offset	Yes
• Incremental encoder with A/B tracks, 90° phase offset and zero track	Yes
• Pulse encoder	Yes
• Pulse encoder with direction	Yes
• Pulse encoder with one impulse signal per count direction	Yes
Encoder signals, absolute encoder (SSI)	
• Input signal	to RS-422
• Telegram length, parameterizable	10 ... 40 bit
• Clock frequency, max.	2 MHz; 125 kHz, 250 kHz, 500 kHz, 1 MHz, 1.5 MHz or 2 MHz
• Binary code	Yes
• Gray code	Yes
• Cable length, shielded, max.	320 m; Cable length, RS-422 SSI absolute encoders, Siemens type 6FX2001-5, 24 V supply: 125 kHz, 320 meters shielded, max.; 250 kHz, 160 meters shielded, max.; 500 kHz, 60 meters shielded, max.; 1 MHz, 20 meters shielded, max.; 1.5 MHz, 10 meters shielded, max.; 2 MHz, 8 meters shielded, max.
• Parity bit, parameterizable	Yes
• Monoflop time	16, 32, 48, 64 μs & automatic
• Multiturn	Yes
• Singleturn	Yes
Interface types	
• RS 422	Yes
• TTL 5 V	Yes; push-pull encoders only
Isochronous mode	
Isochronous operation (application synchronized up to terminal)	Yes
Filtering and processing time (TCI), min.	130 μs; only for pulse and incremental encoders
Bus cycle time (TDP), min.	250 μs
Interrupts/diagnostics/status information	
Alarms	
• Diagnostic alarm	Yes
• Hardware interrupt	Yes
Diagnostic messages	
• Monitoring the supply voltage	Yes
• Wire-break	Yes
• Short-circuit	Yes
• A/B transition error at incremental encoder	Yes
• Telegram error at SSI encoder	Yes
Diagnostics indication LED	
• RUN LED	Yes; Green LED
• ERROR LED	Yes; Red LED
• MAINT LED	Yes; yellow LED
• Monitoring of the supply voltage (PWR-LED)	Yes; Green LED
• Channel status display	Yes; Green LED
• for channel diagnostics	Yes; Red LED

Technical specifications (continued)

Article number	6ES7551-1AB00-0AB0 S7-1500, TM POSINPUT 2
Integrated Functions	
Number of counters	2
Counting frequency (counter) max.	4 MHz; with quadruple evaluation
Counting functions	
• Can be used with TO High_Speed_Counter	Yes; only for pulse and incremental encoders
• Continuous counting	Yes
• Counter response parameterizable	Yes
• Hardware gate via digital input	Yes
• Software gate	Yes
• Event-controlled stop	Yes
• Synchronization via digital input	Yes
• Counting range, parameterizable	Yes
Comparator	
- Number of comparators	2; Per channel
- Direction dependency	Yes
- Can be changed from user program	Yes
Position detection	
• Incremental acquisition	Yes
• Absolute acquisition	Yes
• Suitable for S7-1500 Motion Control	Yes
Measuring functions	
• Measuring time, parameterizable	Yes
• Dynamic measurement period adjustment	Yes
• Number of thresholds, parameterizable	2
Measuring range	
- Frequency measurement, min.	0.04 Hz
- Frequency measurement, max.	4 MHz
- Cycle duration measurement, min.	0.25 µs
- Cycle duration measurement, max.	25 s

Article number	6ES7551-1AB00-0AB0 S7-1500, TM POSINPUT 2
Accuracy	
- Frequency measurement	100 ppm; depending on measuring interval and signal evaluation
- Cycle duration measurement	100 ppm; depending on measuring interval and signal evaluation
- Velocity measurement	100 ppm; depending on measuring interval and signal evaluation
Potential separation	
Potential separation channels	
• between the channels	No
• between the channels and backplane bus	Yes
• Between the channels and load voltage L+	No
Isolation	
Isolation tested with	707 V DC (type test)
Ambient conditions	
Ambient temperature during operation	
• horizontal installation, min.	0 °C
• horizontal installation, max.	60 °C; Please note derating for inductive loads
• vertical installation, min.	0 °C
• vertical installation, max.	40 °C; Please note derating for inductive loads
Decentralized operation	
to SIMATIC S7-1500	Yes
to standard PROFINET controller	Yes
Dimensions	
Width	35 mm
Height	147 mm
Depth	129 mm
Weights	
Weight, approx.	325 g

Ordering data

Ordering data	Article No.
TM PosInput 2 counting and position detecting module With 2 channels, max. 1 MHz counting frequency; for SSI encoders and incremental encoders with RS 422 or 5V TTL interface	6ES7551-1AB00-0AB0
Accessories	
Front connectors For 35 mm modules; including four potential bridges, cable ties and individual labeling strips, 40-pin	
• Screw terminals	6ES7592-1AM00-0XB0
• Push-in	6ES7592-1BM00-0XB0
DIN A4 labeling sheets	6ES7592-2AX00-0AAA
10 sheets with 10 labeling strips each for I/O modules; perforated, Al grey	
U connector	6ES7590-0AA00-0AAA
5 units; spare part	

Ordering data	Article No.
Universal front door for I/O modules 5 front doors; with 5 labeling strips (front) and 5 cabling diagrams per front door; spare part	6ES7528-0AA00-7AA0
Shielding set I/O Infeed element, shield bracket, and shield terminal; 5 units, spare part	6ES7590-5CA00-0AAA
Shield terminal element 10 units; spare part	6ES7590-5BA00-0AAA
SIMATIC Manual Collection Electronic manuals on DVD, multi-language: LOGO!, SIMADYN, SIMATIC bus components, SIMATIC C7, SIMATIC distributed I/O, SIMATIC HMI, SIMATIC Sensors, SIMATIC NET, SIMATIC PC Based Automation, SIMATIC PCS 7, SIMATIC PG/PC, SIMATIC S7, SIMATIC Software, SIMATIC TDC	6ES7998-8XC01-8YE0
SIMATIC Manual Collection update service for 1 year Current "Manual Collection" DVD and the three subsequent updates	6ES7998-8XC01-8YE2

SIMATIC S7-1500 Advanced Controllers

I/O modules

Technology modules

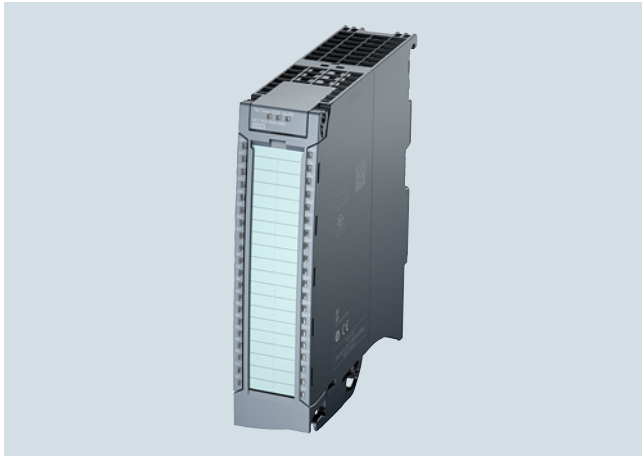
Time-based IO module TM Timer DIDQ 16x24V**Overview**

- 8 digital inputs, 16 digital outputs, of which up to 16 can be used in different configurations as technological, time-controlled channels
- Inputs for detecting the input edges with μs accuracy
- Outputs for outputting switching signals with μs accuracy
- 32x oversampling
- PWM output
- Counter function
- Outputs can be switched between 0.5 A standard and especially fast 0.1 A high-speed operation

4

Technical specifications

Article number	6ES7552-1AA00-0AB0 S7-1500, TM TIMER DIDQ 16X24V
General information	
Product type designation	TM Timer DIDQ 16x24V
Product function	
• I&M data	Yes; I&M 0
Engineering with	
• STEP 7 TIA Portal configurable/integrated as of version	V13 Update 3
Installation type/mounting	
Rail mounting	Yes; S7-1500 mounting rail
Load voltage 1L+	
• Rated value (DC)	24 V
• Reverse polarity protection	Yes; against destruction
Load voltage 2L+	
• Rated value (DC)	24 V
• Reverse polarity protection	Yes; against destruction
Input current	
from load voltage 1L+ (without load), max.	40 mA; without load
from load voltage 2L+ (without load), max.	30 mA; without load
Encoder supply	
Number of outputs	8; max. depending on parameterization
24 V encoder supply	
• 24 V	Yes; L+ (-0.8 V)
• Short-circuit protection	Yes
• Output current, max.	1.2 A; Total current of all encoders / channels, max. 0.5 A per output

Article number	6ES7552-1AA00-0AB0 S7-1500, TM TIMER DIDQ 16X24V
Power	
Power available from the backplane bus	1.3 W
Power loss	
Power loss, typ.	5 W
Digital inputs	
Number of digital inputs	8; max. depending on parameterization
• in groups of	8
Digital inputs, parameterizable	Yes
Input characteristic curve in accordance with IEC 61131, type 3	Yes
Digital input functions, parameterizable	
• Digital input with time stamp	Yes
- Number, max.	8
• Counter	Yes
- Number, max.	4
• Counter for incremental encoder	Yes
- Number, max.	4
• Digital input with oversampling	Yes
- Number, max.	8
• HW enable for digital input	Yes
- Number, max.	4
• HW enable for digital output	Yes
- Number, max.	4

Technical specifications (continued)

Article number	6ES7552-1AA00-0AB0 S7-1500, TM TIMER DIDQ 16X24V
Input voltage	
• Type of input voltage	DC
• Rated value (DC)	24 V
• for signal "0"	-30 to +5V
• for signal "1"	+11 to +30V
• permissible voltage at input, min.	-30 V
• permissible voltage at input, max.	30 V
Input current	
• for signal "1", typ.	2.5 mA
Input delay (for rated value of input voltage)	
• Minimum pulse width for program reactions	3 µs for parameterization "none"
for standard inputs	
- parameterizable	Yes; none / 0.05 / 0.1 / 0.4 / 0.8 ms
- at "0" to "1", min.	4 µs; for parameterization "none"
- at "1" to "0", min.	4 µs; for parameterization "none"
Cable length	
• shielded, max.	1 000 m; Depending on sensor, cable quality and rate of change
• unshielded, max.	600 m; Depending on sensor, cable quality and rate of change
Digital outputs	
Type of digital output	Transistor
Number of digital outputs	16; max. depending on parameterization
• in groups of	8
Current-sinking	Yes; With High Speed output
Current-sourcing	Yes
Digital outputs, parameterizable	Yes
Short-circuit protection	Yes; electronic/thermal
Limitation of inductive shutdown voltage to	-0.8 V
Controlling a digital input	Yes
Digital output functions, parameterizable	
• Digital output with time stamp	Yes
- Number, max.	16
• PWM output	Yes
- Number, max.	16
• Digital output with oversampling	Yes
- Number, max.	16
Switching capacity of the outputs	
• with resistive load, max.	0.5 A; 0.1 A with High Speed output
• on lamp load, max.	5 W; 1 W with High Speed output
Load resistance range	
• lower limit	48 Ω; 240 ohm with High Speed output
• upper limit	12 kΩ
Output voltage	
• Type of output voltage	DC
• for signal "0", max.	1 V; With High Speed output
• for signal "1", min.	23.2 V; L+ (-0.8 V)

Article number	6ES7552-1AA00-0AB0 S7-1500, TM TIMER DIDQ 16X24V
Output current	
• for signal "1" rated value	0.5 A; 0.1 A with High Speed output, observe derating
• for signal "0" residual current, max.	0.5 mA
Output delay with resistive load	
• "0" to "1", max.	1 µs; With High Speed output, 5 µs with Standard output
• "1" to "0", max.	1 µs; With High Speed output, 6 µs with Standard output
Switching frequency	
• with resistive load, max.	10 kHz
• on lamp load, max.	10 Hz
Total current of the outputs	
• Current per group, max.	4 A
• Current per module, max.	8 A; Observe derating
Cable length	
• shielded, max.	1 000 m; Depending on load and cable quality
• unshielded, max.	600 m; Depending on load and cable quality
Encoder	
Connectable encoders	
• Incremental encoder (asymmetrical)	Yes
• 24 V initiator	Yes
• 2-wire sensor	Yes
- permissible quiescent current (2-wire sensor), max.	1.5 mA
Encoder signals, incremental encoder (asymmetrical)	
• Input voltage	24 V
• Input frequency, max.	50 kHz
• Counting frequency, max.	200 kHz; with quadruple evaluation
• Cable length, shielded, max.	600 m; Depending on input frequency, encoder and cable quality; max. 200 m at 50 kHz
• Incremental encoder with A/B tracks, 90° phase offset	Yes
• Pulse encoder	Yes
Encoder signal 24 V	
- permissible voltage at input, min.	-30 V
- permissible voltage at input, max.	30 V
Interface types	
• Input characteristic curve in accordance with IEC 61131, type 3	Yes

SIMATIC S7-1500 Advanced Controllers

I/O modules

Technology modules

Time-based IO module TM Timer DIDQ 16x24V

Technical specifications (continued)

Article number	6ES7552-1AA00-0AB0 S7-1500, TM TIMER DIDQ 16X24V
Isochronous mode	
Isochronous operation (application synchronized up to terminal)	Yes
Bus cycle time (TDP), min.	250 µs
Interrupts/diagnostics/status information	
Diagnostics function	Yes
Substitute values connectable	Yes
Alarms	
• Diagnostic alarm	Yes
Diagnostic messages	
• Monitoring the supply voltage	Yes
• Short-circuit	Yes
Diagnostics indication LED	
• RUN LED	Yes; Green LED
• ERROR LED	Yes; Red LED
• MAINT LED	Yes; yellow LED
• Monitoring of the supply voltage (PWR-LED)	Yes; Green LED
• Channel status display	Yes; Green LED
• for channel diagnostics	Yes; Red LED
Integrated Functions	
Number of counters	4
Counting frequency (counter) max.	200 kHz; with quadruple evaluation
Counting functions	
• Continuous counting	Yes
Potential separation	
Potential separation channels	
• between the channels and backplane bus	Yes
Isolation	
Isolation tested with	707 V DC (type test)
Ambient conditions	
Ambient temperature during operation	
• horizontal installation, min.	0 °C
• horizontal installation, max.	60 °C
• vertical installation, min.	0 °C
• vertical installation, max.	40 °C; Observe derating
Decentralized operation	
to SIMATIC S7-1500	Yes
Dimensions	
Width	35 mm
Height	147 mm
Depth	129 mm
Weights	
Weight, approx.	320 g

Ordering data

Article No.

Time-based IO module TM Timer DIDQ 16x24V

6ES7552-1AA00-0AB0

Max. 16 time-controlled inputs or outputs

Accessories

Front connector

For 35 mm modules; including four potential bridges, cable ties and individual labeling strips, 40-pin

- Screw terminals
- Push-in

6ES7592-1AM00-0XB0
6ES7592-1BM00-0XB0

DIN A4 labeling sheets

6ES7592-2AX00-0AA0

10 sheets with 10 labeling strips each for I/O modules; perforated, AI grey

U connector

6ES7590-0AA00-0AA0

5 units; spare part

Universal front door for I/O modules

6ES7528-0AA00-7AA0

5 front doors; with 5 labeling strips (front) and 5 cabling diagrams per front door; spare part

Shielding set I/O

6ES7590-5CA00-0AA0

Infeed element, shield bracket, and shield terminal; 5 units, spare part:

Note: Only shield bracket and shield terminal are required for the TM Timer DIDQ 16x24V

Shield terminal element

6ES7590-5BA00-0AA0

10 units; spare part

SIMATIC Manual Collection

6ES7998-8XC01-8YE0

Electronic manuals on DVD, multi-language: LOGO!, SIMADYN, SIMATIC bus components, SIMATIC C7, SIMATIC distributed I/O, SIMATIC HMI, SIMATIC Sensors, SIMATIC NET, SIMATIC PC Based Automation, SIMATIC PCS 7, SIMATIC PG/PC, SIMATIC S7, SIMATIC Software, SIMATIC TDC

SIMATIC Manual Collection update service for 1 year

6ES7998-8XC01-8YE2

Current "Manual Collection" DVD and the three subsequent updates

Overview

- 4-channel interface module for PTO (Pulse Train Output)
- 3 signal interfaces can be configured for speed and direction:
 - 24 V asymmetrical up to 200 kHz
 - RS 422, 5 V symmetrical up to 1 MHz
 - TTL 5 V asymmetrical up to 200 kHz
- 3 signal types can be configured:
 - Pulse and direction
 - Pulses for forward movement and pulses for backwards movement
 - 2 phase-shifted signals, with simple or quadruple evaluation
- Supported technology objects:
 - Speed controlled axis (S7-1500, S7-1500T)
 - Positioning axis (S7-1200, S7-1500, S7-1500T)
 - Synchronous axis (S7-1500, S7-1500T)
 - Probe (S7-1500, S7-1500T)

Technical specifications

Article number	6ES7553-1AA00-0AB0 S7-1500, TM PTO4
General information	
Product type designation	TM PTO 4
HW functional status	FS01
Number of channels	4; Axes
Product function	
• I&M data	Yes; I&M0 to I&M3
• Isochronous mode	Yes
Engineering with	
• STEP 7 TIA Portal configurable/integrated as of version	STEP 7 V14 or higher
• STEP 7 configurable/integrated as of version	V5.5 SP3 with GSD file / -
• PROFINET as of GSD version/GSD revision	GSDML V2.32
Installation type/mounting	
Rail mounting	Yes; S7-1500 mounting rail
Supply voltage	
Load voltage L+	
• Rated value (DC)	24 V
• permissible range, lower limit (DC)	19.2 V
• permissible range, upper limit (DC)	28.8 V
• Reverse polarity protection	Yes
Input current	
Current consumption, max.	70 mA; without load
Power	
Power available from the backplane bus	1.3 W
Power loss	
Power loss, typ.	4 W

Article number	6ES7553-1AA00-0AB0 S7-1500, TM PTO4
Address area	
Occupied address area	
• Inputs	18 byte; Per channel
• Outputs	10 byte; Per channel
Digital inputs	
Number of digital inputs	12; 3 per channel, of which 1 DIQ
Digital inputs, parameterizable	Yes
Input characteristic curve in accordance with IEC 61131, type 3	Yes
Digital input functions, parameterizable	
• Synchronization	Yes
• Probe	Yes
• Drive ready	Yes
Input voltage	
• Type of input voltage	DC
• Rated value (DC)	24 V
• for signal "0"	-5 ... +5 V
• for signal "1"	+11 to +30V
• permissible voltage at input, min.	-5 V
• permissible voltage at input, max.	30 V
Input current	
• for signal "1", typ.	2.5 mA
Input delay (for rated value of input voltage) for standard inputs	
- parameterizable	Yes; none / 0.05 / 0.1 / 0.4 / 0.8 / 1.6 / 3.2 / 12.8 / 20 ms
- at "0" to "1", min.	4 µs; for parameterization "none"
- at "1" to "0", min.	4 µs; for parameterization "none"
for counter/technological functions	
- parameterizable	Yes
Cable length	
• shielded, max.	1 000 m
• unshielded, max.	600 m

SIMATIC S7-1500 Advanced Controllers

I/O modules

Technology modules

Interface module for PTO (Pulse Train Output) TM PTO 4

Technical specifications (continued)

Article number	6ES7553-1AA00-0AB0 S7-1500, TM PTO4
Digital outputs	
Number of digital outputs	12; 3 per channel, of which 1 DIQ
Current-sinking	Yes; For DQn.0 and DQn.1 push-pull outputs
Current-sourcing	Yes
Digital outputs, parameterizable	Yes
Short-circuit protection	Yes; electronic/thermal
• Response threshold, typ.	0.2 A for DQn.0 and DQn.1, 0.9 A for DIQn.2
Controlling a digital input	Yes
Digital output functions, parameterizable	
• PTO (pulse train output) signal interface	
- 24 V asymmetrical	Yes
- RS 422 symmetrical	No
- TTL (5 V) asymmetrical	No
• PTO (pulse train output) signal type	
- Pulse and direction	Yes
- Count up, count down	Yes
- Incremental encoder (A, B phase shift)	Yes
- Incremental encoder (A, B phase shift, quadruple)	Yes
Switching capacity of the outputs	
• with resistive load, max.	0.1 A; 0.5 A for DIQn.2
• on lamp load, max.	1 W; 5 W for DIQn.2
Load resistance range	
• lower limit	240 Ω; 48 ohms for DIQn.2
• upper limit	12 kΩ
Output voltage	
• Type of output voltage	DC
• for signal "1", min.	23.2 V; L+ (-0.8 V), L+ (-1.3 V) for DIQn.2
Output current	
• for signal "1" rated value	0.1 A; 0.5 A for DIQn.2
• for signal "1" permissible range, max.	0.12 A; 0.6 A for DIQn.2
• for signal "1" minimum load current	2 mA
• for signal "0" residual current, max.	0.5 mA
Output delay with resistive load	
• "0" to "1", typ.	1 μs; 28 μs for DIQn.2
• "1" to "0", typ.	1 μs; 25 μs for DIQn.2
Switching frequency	
• with resistive load, max.	1 kHz; For DIQn.2
• with inductive load, max.	0.5 Hz; According to IEC 60947-5-1, DC-13, for DIQn.2
• on lamp load, max.	10 Hz; For DIQn.2
• For signal interface 24 V asymmetrical	200 kHz; With DQn.0 and DQn.1
Cable length	
• shielded, max.	600 m; Up to 10 kHz, 50 m at 200 kHz
Isochronous mode	
Isochronous operation (application synchronized up to terminal)	Yes
Bus cycle time (TDP), min.	250 μs; 375 μs if all 4 channels are used
Jitter, max.	1 μs

Article number	6ES7553-1AA00-0AB0 S7-1500, TM PTO4
Interrupts/diagnostics/status information	
Diagnostics function	Yes
Alarms	
• Diagnostic alarm	Yes
Diagnostic messages	
• Monitoring the supply voltage	Yes
• Short-circuit	Yes; Thermal overload protection
• Group error	Yes
Diagnostics indication LED	
• RUN LED	Yes; Green LED
• ERROR LED	Yes; Red LED
• MAINT LED	Yes; yellow LED
• Monitoring of the supply voltage (PWR-LED)	Yes; Green LED
• Channel status display	Yes; Green LED
• for channel diagnostics	Yes; Red LED
Potential separation	
Potential separation channels	
• between the channels	No
• between the channels and backplane bus	Yes
• Between the channels and load voltage L+	No
Isolation	
Isolation tested with	707 V DC (type test)
Ambient conditions	
Ambient temperature during operation	
• horizontal installation, min.	0 °C
• horizontal installation, max.	60 °C; Observe derating
• vertical installation, min.	0 °C
• vertical installation, max.	40 °C; Observe derating
Decentralized operation	
to SIMATIC S7-300	Yes; Via control and feedback interface
to SIMATIC S7-400	Yes; Via control and feedback interface
to SIMATIC S7-1200	Yes
to SIMATIC S7-1500	Yes
to standard PROFINET controller	Yes; Via control and feedback interface
Dimensions	
Width	35 mm
Height	147 mm
Depth	129 mm
Weights	
Weight, approx.	300 g

Interface module for PTO (Pulse Train Output) TM PTO 4

Ordering data	Article No.		Article No.
Interface module for TM PTO 4 stepper drives 4 Pulse Train Output PTO channels; PTO: 24 V or RS 422; 2 DQ PTO, 2 DI 24 V, 1 DIQ 24 V per channel	6ES7553-1AA00-0AB0	Shielding set I/O Infeed element, shield bracket, and shield terminal; 5 units, spare part	6ES7590-5CA00-0AA0
Accessories		Shield terminal element 10 units; spare part	6ES7590-5BA00-0AA0
Front connectors For 35 mm modules; including four potential bridges, cable ties and individual labeling strips, 40-pin • Screw terminals • Push-in	6ES7592-1AM00-0XB0 6ES7592-1BM00-0XB0	SIMATIC Manual Collection SIMATIC Manual Collection on DVD in 5 languages, all manuals for S7-1200/1500/200/300/400, LOGO!, SIMATIC DP, PC, PG, STEP 7, Engineering SW, Runtime SW, PCS7, SIMATIC HMI, SIMATIC NET, SIMATIC IDENT	6ES7998-8XC01-8YE0
DIN A4 labeling sheets 10 sheets with 10 labeling strips each for I/O modules; perforated, Al grey	6ES7592-2AX00-0AA0	SIMATIC Manual Collection update service for 1 year Current Manual Collection DVD and the three subsequent updates	6ES7998-8XC01-8YE2
U connector 5 units; spare part	6ES7590-0AA00-0AA0		
Universal front door for I/O modules 5 front doors; with 5 labeling strips (front) and 5 cabling diagrams per front door; spare part	6ES7528-0AA00-7AA0		

SIMATIC S7-1500 Advanced Controllers

I/O modules

Technology modules

SIWAREX WP521 ST, SIWAREX WP522 ST

Overview



SIWAREX WP521 ST



SIWAREX WP522 ST

SIWAREX WP521 ST / WP522 ST (ST = Standard) are versatile weighing modules for the SIMATIC S7-1500 Advanced Controller family. With these electronic weighing systems, simple weighing applications, such as platform or hopper scales, can be seamlessly integrated into the S7-1500 automation environment.

Technical specifications

SIWAREX WP521 ST, WP522 ST	
Weighing modes	<ul style="list-style-type: none"> • Non-automatic scales, e.g. platform and hopper scales
Ports	<ul style="list-style-type: none"> • 1 x SIMATIC S7-1500 system bus • 1 x Ethernet (SIWATOOL, Modbus TCP/IP) • 1 x RS485 (Modbus RTU or remote display) per channel • 3 x digital outputs (24 V DC) per channel • 4 x digital outputs (24 V DC short-circuit proof) per channel
Functions	<ul style="list-style-type: none"> • 3 limits • Zeroing • Tare • Tare specification • Zero adjustment • Trace function for signal analysis • Internal restore point • SIMATIC S7-1500 integrated and/or stand-alone operation
Parameter assignment	<ul style="list-style-type: none"> • By means of function block in SIMATIC S7-1500 and HMI • Using SIWATOOL V7 • Using Modbus TCP/IP • Using Modbus RTU

SIWAREX WP521 ST, WP522 ST	
Remote display (see accessories)	
Connection	via RS 485
Display	Additional display for weight value
Measuring accuracy	
Error limit according to DIN 1319-1 of full-scale value at 20 °C ± 10 K (68 °F ± 10 K)	0.05%
Internal resolution	Up to ±4 million parts
Number of measurements/second	100 or 120 (selectable)
Filter	<ul style="list-style-type: none"> • Low-pass filter 0.05 ... 50 Hz • Average value filter
Weighing functions	
Zeroing	Per command
Tare	Per command
Tare specification	Per command

Technical specifications (continued)

SIWAREX WP521 ST, WP522 ST	
Compatible sensors	Analog load cells / full-bridge strain gauges (1-4 mV/V) in 4-wire or 6-wire system
Load cell powering	
Supply voltage (regulated via feedback)	4.85 V DC
Permissible load resistance	
• R _{Lmin}	> 40 Ω
• R _{Lmax}	< 4 100 Ω
With SIWAREX IS Ex interface	
• R _{Lmin}	> 50 Ω
• R _{Lmax}	< 4 100 Ω
Load cell characteristic	1 ... 4 mV/V
Permissible range of the measurement signal (with 4 mV/V sensors)	-21.3 ... +21.3 mV
Max. distance of load cells	800 m (2 624 ft)
Connection to load cells in Ex zone 1	Optionally via SIWAREX IS Ex interface

SIWAREX WP521 ST, WP522 ST	
Certificates	<ul style="list-style-type: none"> • ATEX Zone 2 • UL • KCC • EAC • RCM • FM- IECEx
Auxiliary power supply	
Rated voltage	24 V DC
Max. power consumption WP521 ST / WP522 ST	120 mA / 200 mA
Max. power consumption SIMATIC Bus	35 mA @ 15 V
IP degree of protection according to DIN EN 60529; IEC 60529	IP20
Climatic requirements	
T_{min(IND)} ... T_{max(IND)} (operating temperature)	
• Horizontal installation	-10 ... +60 °C (14 ... 140 °F)
• Vertical installation	-10 ... +40 °C (14 ... 104 °F)
EMC requirements	according to IEC 61000-6-2:2004; IEC 61000-6-4:2007+A1:2011
Dimensions (W x H x D)	35 x 147 x 129 mm (1.38 x 5.79 x 5.08 in)

Ordering data

Article No.

Article No.

Weighing module TM SIWAREX WP521 ST	7MH4980-1AA01
Single-channel, for platform or hopper scales with analog load cells / full-bridge strain gauges (1 - 4 mV/V), 1 x LC, 4 x DQ, 3 x DI, 1 x RS 485, Ethernet port, including shielding set.	
Weighing module TM SIWAREX WP522 ST	7MH4980-2AA01
Double channel, for two separate platform or hopper scales with analog load cells / full-bridge strain gauges (1 - 4 mV/V), per channel 1 x LC, 4 x DQ, 3 x DI, 1 x RS 485, Ethernet port, including shielding set.	
SIMATIC S7-1500, front connector with screw-type terminals	6ES7592-1AM00-0XB0
40-pole, for 35 mm wide modules, including 4 jumper links and cable ties	
SIMATIC S7-1500, front connector with push-in technology	6ES7592-1BM00-0XB0
40-pole, for 35 mm wide modules, including 4 jumper links and cable ties	

Configuration package SIWAREX WP521 ST / WP522 ST on CD-ROM	7MH4980-1AK01
<ul style="list-style-type: none"> • "Ready for use" software for operating a scale with SIWAREX WP52x ST and a touch panel (in a variety of languages), including function block and HMI visualization • Service software SIWATOOL V7.0 • Device manuals (PDF files in a variety of languages) 	
Ethernet cable patch cord 2 m (7 ft)	6XV1850-2GH20
For connecting SIWAREX WP52x ST to a PC (SIWATOOL V7 or Modbus TCP/IP)	

SIMATIC S7-1500 Advanced Controllers

I/O modules

Technology modules

SIWAREX WP521 ST, SIWAREX WP522 ST**Ordering data****Article No.****Remote display (optional)**

The digital remote displays can be connected directly to the SIWAREX WP231 via the RS 485 interface.

Suitable remote display:
S102

Siebert Industrieelektronik GmbH
Postfach 1180
D-66565 Eppelborn, Germany
Tel.: +49 6806/980-0
Fax: +49 6806/980-999
Internet: <http://www.siebert.de>

Detailed information is available from the manufacturer.

Accessories**SIWAREX JB junction box, aluminum housing****7MH4710-1BA**

For connecting up to 4 load cells in parallel, and for connecting multiple junction boxes.

SIWAREX JB junction box, stainless steel housing**7MH4710-1EA**

For connecting up to 4 load cells in parallel.

SIWAREX JB junction box, stainless steel housing (ATEX)**7MH4710-1EA01**

For connecting up to 4 load cells in parallel.
(For zone allocation, see manual or type examination certificate)

Article No.**Ex interface SIWAREX IS**

For intrinsically-safe connection of load cells. With ATEX approval (not UL/FM). Suitable for SIWAREX electronic weighing system. Compatibility of load cells must be checked.

- Short-circuit current < 199 mA DC
- Short-circuit current < 137 mA DC

7MH4710-5BA
7MH4710-5CA**Load cell cable (optional)****Cable Li2Y 1 x 2 x 0.75 ST + 2 x (2 x 0.34 ST) – CY**

For connecting SIWAREX electronic weighing systems to junction box (JB), extension box (EB) and Ex interface or between two extension boxes. For permanent installation. Occasional bending is possible.

External diameter:
approx. 10.8 mm (0.43 in)

Permissible ambient temperature
-40 ... +80 °C (-40 ... +176 °F).

Sold by the meter.

- Sheath color: orange
- For potentially explosive atmospheres. Sheath color: blue

7MH4702-8AG
7MH4702-8AF

Overview



- 2-channel high-speed counter module
- With comprehensive parameterization options for an optimum adaptation to the task and reduction of control load
- Speed and time period measuring
- Storage and comparison functions
- Connection of 24 V encoders

Note:

SIPLUS extreme products are based on SIMATIC standard products. The contents listed here were taken from the respective standard products. SIPLUS extreme-specific information was added.

Technical specifications

Article number	6AG1550-1AA00-7AB0
Based on	6ES7550-1AA00-0AB0 SIPLUS S7-1500 TM COUNT 2X24V
Ambient conditions	
Ambient temperature during operation	
• horizontal installation, min.	-40 °C; = Tmin; Startup @ -25 °C
• horizontal installation, max.	70 °C; = Tmax; note derating for inductive loads; > +60 °C total current of the encoder supply max. 0.5 A, total current of the outputs max. 1 A
• vertical installation, min.	-40 °C; = Tmin; Startup @ -25 °C
• vertical installation, max.	40 °C; Please note derating for inductive loads
Extended ambient conditions	
• relative to ambient temperature-atmospheric pressure-installation altitude	Tmin ... Tmax at 1080 hPa ... 795 hPa (-1000 m ... +2000 m) // Tmin ... (Tmax - 10K) at 795 hPa ... 658 hPa (+2000 m ... +3500 m) // Tmin ... (Tmax - 20K) at 658 hPa ... 540 hPa (+3500 m ... +5000 m)
Relative humidity	
- With condensation, tested in accordance with IEC 60068-2-38, max.	100 %; RH incl. condensation/frost (no commissioning under condensation conditions)
Resistance	
- against biologically active substances / conformity with EN 60721-3-3	Yes; Class 3B2 mold, fungus and dry rot spores (with the exception of fauna). The supplied connector covers must remain on the unused interfaces during operation!
- against chemically active substances / conformity with EN 60721-3-3	Yes; Class 3C4 (RH < 75%) incl. salt spray according to EN 60068-2-52 (degree of severity 3). The supplied connector covers must remain on the unused interfaces during operation!
- against mechanically active substances / conformity with EN 60721-3-3	Yes; Class 3S4 incl. sand, dust. The supplied connector covers must remain on the unused interfaces during operation!

Ordering data

Article No.

SIPLUS TM Count 2x24V counter module	6AG1550-1AA00-7AB0
(Extended temperature range and exposure to media)	
With 2 channels, max. 200 kHz; for 24 V encoder	
Accessories	See SIMATIC S7-1500, TM Count 2x24V counter module, page 4/102

SIMATIC S7-1500 Advanced Controllers

I/O modules

Communication

CM PtP

Overview



- Modules for serial communication connections, scaled according to interface types, protocols, and performance
- 4 versions with different physical transmission characteristics:
 - RS 232C, max. 19.2 kbps
 - RS 232C, max. 115.2 kbps
 - RS 422/RS 485, max. 19.2 kbps
 - RS 422/RS 485, max. 115.2 kbps
- Protocols supported
 - Freepoint: User-parameterizable telegram format for universal communication
 - 3964(R) for improved transmission reliability
 - Modbus RTU Master
 - Modbus RTU Slave
 - USS, implemented through instructions

Technical specifications

Article number	6ES7540-1AD00-0AA0	6ES7541-1AD00-0AB0	6ES7540-1AB00-0AA0	6ES7541-1AB00-0AB0
	S7-1500, CM PtP RS 232 BA	S7-1500, CM PtP RS 232 HF	S7-1500, CM PtP RS 422/485 BA	S7-1500, CM PtP RS 422/485 HF
General information				
Product type designation	CM PtP RS232 BA	CM PtP RS232 HF	CM PtP RS422/485 BA	CM PtP RS422/485 HF
Product function				
• I&M data	Yes; I&M 0	Yes; I&M 0	Yes; I&M 0	Yes; I&M 0
Engineering with				
• STEP 7 TIA Portal configurable/integrated as of version	V12 / V12	V12 / V12	V12 / V12	V12 / V12
• STEP 7 configurable/integrated as of version	V5.5 SP2 with GSD file	V5.5 SP2 with GSD file	V5.5 SP2 with GSD file	V5.5 SP2 with GSD file
• PROFIBUS as of GSD version/GSD revision	- / -	- / -	- / -	- / -
• PROFINET as of GSD version/GSD revision	V2.3	V2.3 / -	V2.3	V2.3 / -
Installation type/mounting				
Rail mounting	Yes; S7-1500 mounting rail	Yes; S7-1500 mounting rail	Yes; S7-1500 mounting rail	Yes; S7-1500 mounting rail
Supply voltage				
Type of supply voltage	system power supply	system power supply	system power supply	system power supply
Input current				
Current consumption (rated value)	35 mA; From the backplane bus	35 mA; From the backplane bus	33 mA; From the backplane bus	33 mA; From the backplane bus
Power				
Power available from the backplane bus	0.65 W	0.65 W	0.65 W	0.65 W
Power loss				
Power loss, typ.	0.6 W	0.6 W	0.6 W	0.6 W
1. Interface				
Interface types				
• RS 485			Yes	Yes
• RS 422			Yes	Yes
• RS 232	Yes	Yes		
RS 232				
• Transmission rate, max.	19.2 kbit/s	115.2 kbit/s		
• Cable length, max.	15 m	15 m		
• RS 232 auxiliary signals	RTS, CTS, DTR, DSR, RI, DCD	RTS, CTS, DTR, DSR, RI, DCD		
RS 485				
• Transmission rate, max.			19.2 kbit/s	115.2 kbit/s
• Cable length, max.			1 200 m	1 200 m

Technical specifications (continued)

Article number	6ES7540-1AD00-0AA0 S7-1500, CM PTP RS 232 BA	6ES7541-1AD00-0AB0 S7-1500, CM PTP RS 232 HF	6ES7540-1AB00-0AA0 S7-1500, CM PTP RS 422/485 BA	6ES7541-1AB00-0AB0 S7-1500, CM PTP RS 422/485 HF
RS 422				
• Transmission rate, max.			19.2 kbit/s	115.2 kbit/s
• Cable length, max.			1 200 m	1 200 m
• 4-wire full duplex connection			Yes	Yes
• 4-wire multipoint connection			No	No
Integrated protocols				
Freepoint				
- Telegram length, max.	1 kbyte	4 kbyte	1 kbyte	4 kbyte
- Bits per character	7 or 8	7 or 8	7 or 8	7 or 8
- Number of stop bits	1 or 2 bit	1 or 2 bit	1 or 2 bit	1 or 2 bit
- Parity	None, even, odd, always 1, always 0, any	None, even, odd, always 1, always 0, any	None, even, odd, always 1, always 0, any	None, even, odd, always 1, always 0, any
3964 (R)				
- Telegram length, max.	1 kbyte	4 kbyte	1 kbyte	4 kbyte
- Bits per character	7 or 8	7 or 8	7 or 8	7 or 8
- Number of stop bits	1 or 2 bit	1 or 2 bit	1 or 2 bit	1 or 2 bit
- Parity	None, even, odd, always 1, always 0, any	None, even, odd, always 1, always 0, any	None, even, odd, always 1, always 0, any	None, even, odd, always 1, always 0, any
Modbus RTU master				
- Address area		1 to 247, extended 1 to 65535		1 to 247, extended 1 to 65535
- Number of slaves, max.		1		32
MODBUS RTU slave				
- Address area		1 to 247, extended 1 to 65535		1 to 247, extended 1 to 65535
Telegram buffer				
• Buffer memory for telegrams	2 kbyte	8 kbyte	2 kbyte	8 kbyte
• Number of telegrams which can be buffered	255	255	255	255
Interrupts/diagnostics/status information				
Diagnostics function	Yes	Yes	Yes	Yes
Alarms				
• Diagnostic alarm	Yes	Yes	Yes	Yes
• Hardware interrupt	No	No	No	No
Diagnostic messages				
• Wire-break	Yes	Yes	Yes	Yes
Diagnostics indication LED				
• RUN LED	Yes; Green LED	Yes; Green LED	Yes; Green LED	Yes; Green LED
• ERROR LED	Yes; Red LED	Yes; Red LED	Yes; Red LED	Yes; Red LED
• Receive RxD	Yes; yellow LED	Yes; yellow LED	Yes; yellow LED	Yes; yellow LED
• Transmit TxD	Yes; yellow LED	Yes; yellow LED	Yes; yellow LED	Yes; yellow LED
Potential separation				
between backplane bus and interface	Yes	Yes	Yes	Yes
Isolation				
Isolation tested with	707 V DC (type test)	707 V DC (type test)	707 V DC (type test)	707 V DC (type test)
Ambient conditions				
Ambient temperature during operation				
• horizontal installation, min.	0 °C	0 °C	0 °C	0 °C
• horizontal installation, max.	60 °C	60 °C	60 °C	60 °C
• vertical installation, min.	0 °C	0 °C	0 °C	0 °C
• vertical installation, max.	40 °C	40 °C	40 °C	40 °C
Decentralized operation				
to SIMATIC S7-300	Yes	Yes	Yes	Yes
to SIMATIC S7-400	Yes	Yes	Yes	Yes
to SIMATIC S7-1500	Yes	Yes	Yes	Yes
to standard PROFINET controller	Yes	Yes	Yes	Yes
Fast Startup supported	Yes	Yes	Yes	Yes

SIMATIC S7-1500 Advanced Controllers

I/O modules

Communication

CM PtP**Technical specifications** (continued)

Article number	6ES7540-1AD00-0AA0 S7-1500, CM PTP RS 232 BA	6ES7541-1AD00-0AB0 S7-1500, CM PTP RS 232 HF	6ES7540-1AB00-0AA0 S7-1500, CM PTP RS 422/485 BA	6ES7541-1AB00-0AB0 S7-1500, CM PTP RS 422/485 HF
Dimensions				
Width	35 mm	35 mm	35 mm	35 mm
Height	147 mm	147 mm	147 mm	147 mm
Depth	127 mm	127 mm	127 mm	127 mm
Weights				
Weight, approx.	0.22 kg	0.22 kg	0.22 kg	0.22 kg

4

Ordering data

Article No.	Article No.
CM PtP RS 232 BA communication module Basic communication module with one RS 232 interface, Freeport, 3964(R) and USS protocols, 9-pin sub D connector, max. 19.2 kbps	Accessories RS 232 connecting cable For linking to SIMATIC S7 5 m 6ES7902-1AB00-0AA0 10 m 6ES7902-1AC00-0AA0 15 m 6ES7902-1AD00-0AA0
CM PtP RS 232 HF communication module High Feature communication module with one RS 232 interface, Freeport, 3964(R), USS and Modbus RTU protocols, 9-pin sub D connector, max. 115.2 kbps	RS 422/485 connecting cable For linking to SIMATIC S7 5 m 6ES7902-3AB00-0AA0 10 m 6ES7902-3AC00-0AA0 50 m 6ES7902-3AG00-0AA0
CM PtP RS 422/485 BA communication module Basic communication module with one RS 422/485 interface, Freeport, 3964(R) and USS protocols, 15-pin sub D socket, max. 19.2 kbps	SIMATIC Manual Collection Electronic manuals on DVD, multi-language: LOGO!, SIMADYN, SIMATIC bus components, SIMATIC C7, SIMATIC distributed I/O, SIMATIC HMI, SIMATIC Sensors, SIMATIC NET, SIMATIC PC Based Automation, SIMATIC PCS 7, SIMATIC PG/PC, SIMATIC S7, SIMATIC Software, SIMATIC TDC
CM PtP RS 422/485 HF communication module High Feature communication module with one RS 422/485 interface, Freeport, 3964(R), USS and Modbus RTU protocols, 15-pin sub D socket, max. 115.2 kbps	SIMATIC Manual Collection update service for 1 year Current "Manual Collection" DVD and the three subsequent updates

Overview



DP-M	DP-S	FMS	PG/OP	S7	
●	●		●	●	

The CM 1542-5 communication module expands the SIMATIC S7-1500 Controller to include a PROFIBUS connection for communication with lower-level PROFIBUS devices in bandwidths from 9.6 kbps to 12 Mbps. The module can also be used to implement separate PROFIBUS lines, in other words, to control a number of different field devices via a number of PROFIBUS segments. The CM 1542-5 assumes all communication tasks, thus reducing the CPU workload.

The CM 1542-5 is suitable for S7 communication as well as for conventional PROFIBUS communication. This makes it possible to establish communication between the S7-1500 Controller and other devices, for example those from the SIMATIC S7-300/400 range.

- PROFIBUS DP master or DP slave with electrical interface for connecting the SIMATIC S7-1500 to PROFIBUS at up to 12 Mbps (including 45.45 kbps)
- Communication services:
 - PROFIBUS DP
 - PG/OP communication
 - S7 communication
 - Open user communication (SEND/RECEIVE) via FDL
- Time synchronization
- Simple programming and configuration over PROFIBUS
- Cross-network PG communication using S7 routing
- Module replacement without a PG
- Data record routing (PROFIBUS DP)
- Adding or modifying distributed I/O during operation

Technical specifications

Article number	6GK7542-5DX00-0XE0
Product type designation	CM 1542-5
Transmission rate	
Transfer rate	
• at the 1st interface acc. to PROFIBUS	9.6 kbit/s ... 12 Mbit/s
Interfaces	
Number of interfaces acc. to Industrial Ethernet	0
Number of electrical connections	
• at the 1st interface acc. to PROFIBUS	1
Type of electrical connection	
• at the 1st interface acc. to PROFIBUS	9-pin Sub-D socket (RS485)
Supply voltage, current consumption, power loss	
Type of voltage of the supply voltage	DC
Supply voltage 1 from backplane bus	15 V
Relative symmetrical tolerance at DC	
• at 15 V	3 %
Consumed current	
• from backplane bus at DC at 15 V typical	0.2 A
Power loss [W]	3 W
Permitted ambient conditions	
Ambient temperature	
• for vertical installation during operation	0 ... 40 °C
• for horizontally arranged busbars during operation	0 ... 60 °C
• during storage	-40 ... +70 °C
• during transport	-40 ... +70 °C
Relative humidity at 25 °C without condensation during operation maximum	95 %
Protection class IP	IP20
Design, dimensions and weight	
Module format	Compact module S7-1500 single width
Width	35 mm
Height	142 mm
Depth	129 mm
Net weight	0.4 kg
Mounting type	
• S7-1500 rail mounting	Yes
Product properties, functions, components general	
Number of units	
• per CPU maximum	8
• Note	depending on CPU type
Performance data open communication	
Number of possible connections for open communication by means of SEND/RECEIVE blocks maximum	30
Amount of data	
• as user data per connection for open communication by means of SEND/RECEIVE blocks maximum	240 byte

SIMATIC S7-1500 Advanced Controllers

I/O modules

Communication

CM 1542-5

Technical specifications (continued)

Article number	6GK7542-5DX00-0XE0
Product type designation	CM 1542-5
Performance data PROFIBUS DP	
Service as DP master	
• DPV1	Yes
Number of DP slaves on DP master usable	125
Amount of data	
• of the address area of the inputs as DP master total	8 192 byte
• of the address area of the outputs as DP master total	8 192 byte
• of the address area of the inputs per DP slave	244 byte
• of the address area of the outputs per DP slave	244 byte
Service as DP slave	
• DPV0	Yes
• DPV1	Yes
Amount of data	
• of the address area of the inputs as DP slave total	240 byte
• of the address area of the outputs as DP slave total	240 byte
Performance data S7 communication	
Number of possible connections for S7 communication	
• maximum	48
• Note	depending on the system upper limit
Performance data multi-protocol mode	
Number of active connections with multi-protocol mode	48
Performance data telecontrol	
Protocol is supported	
• TCP/IP	No
Configuration software	
• required	STEP 7 Professional V12 (TIA Portal) or higher
Identification & maintenance function	
• I&MO - device-specific information	Yes
• I&M1 – higher-level designation/ location designation	Yes
Product functions Diagnosis	
Product function Web-based diagnostics	Yes; yes, via S7-1500 CPU
Product functions Time	
Product function pass on time synchronization	Yes

Ordering data

Article No.

CM 1542-5

communication module

Communication module for electrical connection of SIMATIC S7-1500 to PROFIBUS as DP master or DP slave; S7 and PG/OP communication, data record routing, time synchronization, diagnostics

6GK7542-5DX00-0XE0

Accessories

PROFIBUS FastConnect RS 485 connector

With 90° cable outlet; insulation displacement technology, max. transmission rate 12 Mbps

- Without PG interface
- With PG interface

6ES7972-0BA52-0XA0
6ES7972-0BB52-0XA0

PROFIBUS FC Standard Cable

2-wire bus cable, shielded, special design for fast mounting, delivery unit: max. 1000 m, minimum order 20 m, sold by the meter

6XV1830-0EH10

PROFIBUS FastConnect Stripping Tool

Stripping tool for fast stripping of the PROFIBUS FastConnect bus cable

6GK1905-6AA00

PROFIBUS bus terminal 12M

Bus terminal for connection of PROFIBUS nodes up to 12 Mbps with connecting cable

6GK1500-0AA10

Note:

You can find order information for software for communication with PC systems in the Catalog IK PI or in the Industry Mall.

Overview

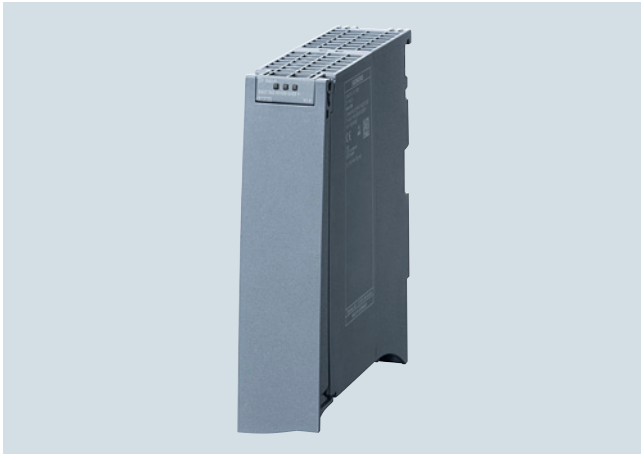

DP-M	DP-S	FMS	PG/OP	S7/S5	
●	●		●		

The CP 1542-5 communications processor expands the SIMATIC S7-1500 Controller to include a PROFIBUS connection for communication with lower-level PROFIBUS devices in bandwidths from 9.6 kbps to 12 Mbps. The processor also allows the implementation of separate PROFIBUS lines; in other words, the control of multiple field devices via several PROFIBUS segments. The CP 1542-5 handles all communication tasks, thus reducing the CPU load.

- PROFIBUS DP master or DP slave with electrical interface for connecting the SIMATIC S7-1500 to PROFIBUS at up to 12 Mbps (including 45.45 kbps)

Communication services:

- PROFIBUS DP
- PG/OP communication
- Time synchronization
- Simple programming and configuration over PROFIBUS
- Cross-network PG communication using S7 routing
- Module replacement without a PG

Technical specifications

Article number	6GK7542-5FX00-0XE0
Product type designation	CP 1542-5
Transmission rate	
Transfer rate	
• at the 1st interface acc. to PROFIBUS	9.6 kbit/s ... 12 Mbit/s
Interfaces	
Number of interfaces acc. to Industrial Ethernet	0
Number of electrical connections	
• at the 1st interface acc. to PROFIBUS	1
Type of electrical connection	
• at the 1st interface acc. to PROFIBUS	9-pin Sub-D socket (RS485)
Supply voltage, current consumption, power loss	
Type of voltage of the supply voltage	DC
Supply voltage 1 from backplane bus	15 V
Relative symmetrical tolerance at DC	
• at 15 V	3 %
Consumed current	
• from backplane bus at DC at 15 V typical	0.1 A
Power loss [W]	1.5 W
Permitted ambient conditions	
Ambient temperature	
• for vertical installation during operation	0 ... 40 °C
• for horizontally arranged busbars during operation	0 ... 60 °C
• during storage	-40 ... +70 °C
• during transport	-40 ... +70 °C
Relative humidity at 25 °C without condensation during operation maximum	95 %
Protection class IP	IP20
Design, dimensions and weight	
Module format	Compact module S7-1500 single width
Width	35 mm
Height	142 mm
Depth	129 mm
Net weight	0.27 kg
Mounting type	
• S7-1500 rail mounting	Yes
Product properties, functions, components general	
Number of units	
• per CPU maximum	8
• Note	depending on CPU type

SIMATIC S7-1500 Advanced Controllers

I/O modules

Communication

CP 1542-5

Technical specifications (continued)

Article number	6GK7542-5FX00-0XE0
Product type designation	CP 1542-5
Performance data PROFIBUS DP	
Service as DP master	
• DPV1	Yes
Number of DP slaves on DP master usable	32
Amount of data	
• of the address area of the inputs as DP master total	2 048 byte
• of the address area of the outputs as DP master total	2 048 byte
• of the address area of the inputs per DP slave	244 byte
• of the address area of the outputs per DP slave	244 byte
Service as DP slave	
• DPV0	Yes
• DPV1	Yes
Amount of data	
• of the address area of the inputs as DP slave total	240 byte
• of the address area of the outputs as DP slave total	240 byte
Performance data S7 communication	
Number of possible connections for S7 communication	
• maximum	16
• Note	depending on the system upper limit
Performance data multi-protocol mode	
Number of active connections with multi-protocol mode	16
Performance data telecontrol	
Protocol is supported	
• TCP/IP	No
Configuration software	
• required	STEP 7 Professional V12 SP1 (TIA Portal) or higher
Identification & maintenance function	
• I&MO - device-specific information	Yes
• I&M1 – higher-level designation/location designation	Yes
Product functions Diagnosis	
Product function Web-based diagnostics	Yes; yes, via S7-1500 CPU
Product functions Time	
Product function pass on time synchronization	Yes

Ordering data

Article No.

CP 1542-5 communications processor

Communication module for electrical connection of SIMATIC S7-1500 to PROFIBUS as DP master or DP slave; PG/OP communication, time synchronization, diagnostics; smaller quantity structure

6GK7542-5FX00-0XE0

Accessories

PROFIBUS FastConnect RS 485 connector

With 90° cable outlet; insulation displacement technology, max. transmission rate 12 Mbps

- Without programming device interface
- With programming device interface

6ES7972-0BA52-0XA0

6ES7972-0BB52-0XA0

PROFIBUS FC Standard Cable

2-wire bus cable, shielded, special design for fast mounting, delivery unit: max. 1000 m, minimum order 20 m, sold by the meter

6XV1830-0EH10

PROFIBUS FastConnect Stripping Tool

Stripping tool for fast stripping of the PROFIBUS FastConnect bus cable

6GK1905-6AA00

PROFIBUS bus terminal 12M

Bus terminal for connection of PROFIBUS stations for up to 12 Mbps with connecting cable

6GK1500-0AA10

Note:

You can find order information for software for communication with PC systems in the Catalog IK PI or in the Industry Mall.

Overview



ISO	TCP/ UDP	PN	MRP	IT	IP-R	PG/OP	S7/S5
	●	●	●	●	●	●	●

Communication module for connecting a SIMATIC S7-1500 to PROFINET networks as PROFINET IO controller or PROFINET IO device.

The CM 1542-1 supports the following communication services:

- PG/OP communication
- S7 communication
- Open communication (SEND/RECEIVE)
- PROFINET communication
- IT communication;
 - Web diagnostics by means of access to the web server of the S7-1500 system
 - Static IP routing with up to 1 Mbps via IPv4 to other CM 1543-1 / CM 1542-1 units in a S7-1500 system, e.g., for web server accesses without real-time capability

Technical specifications

Article number	6GK7542-1AX00-0XE0
Product type designation	CM 1542-1
Transmission rate	
Transfer rate	
• at the 1st interface	10 ... 100 Mbit/s
Interfaces	
Number of interfaces acc. to Industrial Ethernet	1
Number of electrical connections	
• at the 1st interface acc. to Industrial Ethernet	2
Type of electrical connection	
• at the 1st interface acc. to Industrial Ethernet	RJ45 port
Supply voltage, current consumption, power loss	
Type of voltage of the supply voltage	DC
Supply voltage 1 from backplane bus	15 V
Relative symmetrical tolerance at DC	
• at 15 V	3 %
Consumed current	
• from backplane bus at DC at 15 V typical	0.22 A
Power loss [W]	3.3 W
Permitted ambient conditions	
Ambient temperature	
• for vertical installation during operation	0 ... 40 °C
• for horizontally arranged busbars during operation	0 ... 60 °C
• during storage	-40 ... +70 °C
• during transport	-40 ... +70 °C
Relative humidity at 25 °C without condensation during operation maximum	95 %
Protection class IP	IP20
Design, dimensions and weight	
Module format	Compact module S7-1500 single width
Width	35 mm
Height	142 mm
Depth	129 mm
Net weight	0.4 kg
Mounting type	
• S7-1500 rail mounting	Yes

SIMATIC S7-1500 Advanced Controllers

I/O modules

Communication

CM 1542-1

Technical specifications (continued)

Article number	6GK7542-1AX00-0XE0
Product type designation	CM 1542-1
Product properties, functions, components general	
Number of units	
• per CPU maximum	8
• Note	depending on CPU type
Performance data open communication	
Number of possible connections for open communication	
• by means of T blocks maximum	64; depending on the system upper limit
Amount of data	
• as user data per ISO on TCP connection for open communication by means of T blocks maximum	65 536 byte
Number of Multicast stations	6
Performance data S7 communication	
Number of possible connections for S7 communication	
• maximum	64
• Note	depending on the system upper limit
Performance data multi-protocol mode	
Number of active connections with multi-protocol mode	64
Performance data PROFINET communication as PN IO-Controller	
Product function PROFINET IO controller	Yes
Number of PN IO devices on PROFINET IO controller usable total	128
Number of PN IO IRT devices on PROFINET IO controller usable	64
Number of external PN IO lines with PROFINET per rack	10
Amount of data	
• as user data for input variables as PROFINET IO controller maximum	8 Kibyte
• as user data for input variables as PROFINET IO controller maximum	8 Kibyte
• as user data for input variables per PN IO device as PROFINET IO controller maximum	1 433 byte
• as user data for output variables per PN IO device as PROFINET IO controller maximum	1 433 byte
• as user data for input variables per PN IO device for each sub-module as PROFINET IO controller maximum	256 byte
• as user data for output variables per PN IO device for each sub-module as PROFINET IO controller maximum	256 byte

Article number	6GK7542-1AX00-0XE0
Product type designation	CM 1542-1
Performance data telecontrol	
Protocol is supported	
• TCP/IP	Yes
Product function MIB support	Yes
Protocol is supported	
• SNMP v1	Yes
• DCP	Yes
• LLDP	Yes
Configuration software	
• required	STEP 7 Professional V13 (TIA Portal) or higher
Identification & maintenance function	
• I&M0 - device-specific information	Yes
• I&M1 – higher-level designation/ location designation	Yes
Product functions Diagnosis	
Product function Web-based diagnostics	Yes; yes, via S7-1500 CPU
Product functions switch	
Product feature Switch	Yes
Product function	
• switch-managed	No
• with IRT PROFINET IO switch	Yes
• Configuration with STEP 7	Yes
Product functions Redundancy	
Product function	
• Ring redundancy	Yes
• Redundancy manager	Yes
Protocol is supported Media Redundancy Protocol (MRP)	Yes
Product functions Security	
Product function	
• switch-off of non-required services	Yes
• Blocking of communication via physical ports	No
• log file for unauthorized access	No
Product functions Time	
Product function SICLOCK support	Yes
Product function pass on time synchronization	Yes
Protocol is supported	
• NTP	Yes

4

Ordering data	Article No.	Ordering data	Article No.
<p>CM 1542-1 communication module</p> <p>For connecting SIMATIC S7-1500 to PROFINET IO, TCP/IP, ISO-on-TCP, UDP, S7 communication, IP broadcast/multicast, SNMPV1, time synchronization via NTP; 2 x RJ45 interface with 10/100 Mbps</p>	6GK7542-1AX00-0XE0	<p>SCALANCE X204-2 Industrial Ethernet switch</p> <p>Industrial Ethernet switches with integral SNMP access, web diagnostics, copper cable diagnostics and PROFINET diagnostics for configuring line, star and ring topologies; four 10/100 Mbps RJ45 ports and two FO ports</p>	6GK5204-2BB10-2AA3
<p>Accessories</p>		<p>SCALANCE X308-2 Industrial Ethernet switch</p> <p>2 x 1000 Mbps SC ports, optical (multimode, glass), up to 750 m 1 x 10/100/1000 Mbps RJ45 port, electrical 7 x 10/100 Mbps RJ45 ports, electrical</p>	6GK5308-2FL10-2AA3
<p>IE FC RJ45 Plug 4 x 2</p> <p>RJ45 plug connector for Industrial Ethernet (10/100/1000 Mbps) with a rugged metal enclosure and integrated insulation displacement contacts for connecting Industrial Ethernet FC installation cables; 180° cable outlet; for network components and CPs/CPU with Industrial Ethernet interface</p> <ul style="list-style-type: none"> • 1 pack = 1 unit • 1 pack = 10 units • 1 pack = 50 units 	<p>6GK1901-1BB11-2AA0</p> <p>6GK1901-1BB11-2AB0</p> <p>6GK1901-1BB11-2AE0</p>		
<p>IE FC TP Standard Cable GP 4 x 2</p> <p>8-wire, shielded TP installation cable for connection to IE FC RJ45 modular outlet for universal applications; with UL approval; sold by the meter; max. quantity 1000 m, minimum order 20 m</p> <ul style="list-style-type: none"> • AWG22, for connection to IE FC RJ45 modular outlet • AWG24, for connection to IE FC RJ45 Plug 4 x 2 	<p>6XV1870-2E</p> <p>6XV1878-2A</p>		

SIMATIC S7-1500 Advanced Controllers

I/O modules

Communication

CP 1543-1

Overview



ISO	TCP/UDP	PN	MRP	IT	IP-R	PG/OP	S7/S5
●	●			●	●	●	●

The SIMATIC CP 1543-1 communications processor securely connects the new SIMATIC S7-1500 Controller to Industrial Ethernet networks. By combining a variety of security features such as an SPI (Stateful Packet Inspection) firewall, VPN and data encryption protocols such as FTPS and SNMPv3, the communications processor protects individual S7-1500 stations or even entire automation cells against unauthorized access.

The CP can also be used for linking the S7-1500 station into an IPv6-based network. All functions are configured by means of STEP 7 Professional V12 (TIA Portal) or higher.

The CP 1543-1 supports the following communications services:

- PG/OP communication
- S7 communication
- Open user communication (SEND/RECEIVE, FETCH/WRITE)
- IT communication
 - FTP functions (File Transfer Protocol FTP/FTPS) for file management and access to data blocks in the CPU (client and server function)
 - Access (read and write modes) to csv files stored on the memory card of the CPU via FTP(S)
 - Sending emails via SMTP or ESMTP with "SMTP-Auth" for authentication on an email server (also with IPv6)
 - Static IP routing with up to 1 Mbps via IPv4 to other CM 1543-1 or CM 1542-1 units in a S7-1500 system, e.g., for web server accesses without real-time capability. Securing a cell by activating the security function in the CP 1543-1 automatically deactivates IP routing.
- Security functions
 - Stateful Packet Inspection (layers 3 and 4) firewall
 - Secure communication via VPN (IPsec)
 - Secure access to the web server of the CPU via the HTTPS protocol
 - Secure file transfer using FTPS
 - Secure transfer of the time of day (NTP)
 - SNMPv3 for tap-proof transfer of network analysis information
 - Encrypted email communication via SMTPS (Port 587)
 - Open communication over TCP/IP
- Integration of the S7-1500 into IPv6-based networks; An IPv6-compliant IP address can be used for the following communication services:
 - FETCH/WRITE access (CP as server)
 - FTP server mode
 - FTP client mode with addressing by program block
 - Email transfer with addressing by program block

Technical specifications

Article number	6GK7543-1AX00-0XE0
Product type designation	CP 1543-1
Transmission rate	
Transfer rate	
• at the 1st interface	10 ... 1 000 Mbit/s
Interfaces	
Number of interfaces acc. to Industrial Ethernet	1
Number of electrical connections	
• at the 1st interface acc. to Industrial Ethernet	1
Type of electrical connection	
• at the 1st interface acc. to Industrial Ethernet	RJ45 port
Supply voltage, current consumption, power loss	
Type of voltage of the supply voltage	DC
Supply voltage 1 from backplane bus	15 V
Relative symmetrical tolerance at DC	
• at 15 V	3 %
Consumed current	
• from backplane bus at DC at 15 V typical	0.35 A
Power loss [W]	5.3 W

Article number	6GK7543-1AX00-0XE0
Product type designation	CP 1543-1
Permitted ambient conditions	
Ambient temperature	
• for vertical installation during operation	0 ... 40 °C
• for horizontally arranged busbars during operation	0 ... 60 °C
• during storage	-40 ... +70 °C
• during transport	-40 ... +70 °C
Relative humidity at 25 °C without condensation during operation maximum	95 %
Protection class IP	IP20
Design, dimensions and weight	
Module format	Compact module S7-1500 single width
Width	35 mm
Height	142 mm
Depth	129 mm
Net weight	0.35 kg
Mounting type	
• S7-1500 rail mounting	Yes

Technical specifications (continued)

Article number	6GK7543-1AX00-0XE0
Product type designation	CP 1543-1
Product properties, functions, components general	
Number of units	
• per CPU maximum	8
• Note	depending on CPU type
Performance data open communication	
Number of possible connections for open communication	
• by means of T blocks maximum	118; depending on the system upper limit
Amount of data	
• as user data per ISO on TCP connection for open communication by means of T blocks maximum	65 536 byte
Number of Multicast stations	118
Performance data S7 communication	
Number of possible connections for S7 communication	
• maximum	118
• Note	depending on the system upper limit
Performance data multi-protocol mode	
Number of active connections with multi-protocol mode	118
Performance data IT functions	
Number of possible connections	
• as client by means of FTP maximum	32
• as server by means of FTP maximum	16
• as server by means of HTTP maximum	4
• as e-mail client maximum	1
Amount of data as user data for email maximum	64 Kibyte
Performance data telecontrol	
Protocol is supported	
• TCP/IP	Yes
Product function MIB support	Yes
Protocol is supported	
• SNMP v1	Yes
• DCP	Yes
• LLDP	No
Configuration software	
• required	STEP 7 Professional V12 (TIA Portal) or higher
Identification & maintenance function	
• I&M0 - device-specific information	Yes
• I&M1 - higher-level designation/location designation	Yes
Product functions Diagnosis	
Product function Web-based diagnostics	Yes; yes, via S7-1500 CPU

Article number	6GK7543-1AX00-0XE0
Product type designation	CP 1543-1
Product functions Routing	
Product function	
• Static IP routing	Yes
• Static IP routing IPv6	No
• dynamic IP routing	No
• dynamic IP routing IPv6	No
Protocol is supported	
• RIP v1	No
• RIPv2	No
• RIPnG for IPv6	No
• OSPFv2	No
• OSPFv3 for IPv6	No
• VRRP	No
• VRRP for IPv6	No
• BGP	No
• PPP	No
• PPOE via DSL	No
Product functions Security	
Firewall version	stateful inspection
Product function with VPN connection	IPSec
Type of encryption algorithms with VPN connection	AES-256, AES-192, AES-128, 3DES-168, DES-56
Type of authentication procedure with VPN connection	Preshared key (PSK), X.509v3 certificates
Type of hashing algorithms with VPN connection	MD5, SHA-1
Number of possible connections with VPN connection	16
Product function	
• password protection for Web applications	No
• ACL - IP-based	No
• ACL - IP-based for PLC/routing	No
• switch-off of non-required services	Yes
• Blocking of communication via physical ports	No
• log file for unauthorized access	Yes
Product functions Time	
Product function SICLOCK support	Yes
Product function pass on time synchronization	Yes
Protocol is supported	
• NTP	Yes

SIMATIC S7-1500 Advanced Controllers

I/O modules

Communication

CP 1543-1

Ordering data

Article No.

Article No.

CP 1543-1**communications processor**

For connecting SIMATIC S7-1500 to Industrial Ethernet via TCP/IP, ISO and UDP and security functions (VPN, firewall); 1 x RJ45 interface with 10/100/1000 Mbps; SNMPV1/V3; time synchronization via NTP, FTP, email, IPv4/IPv6

6GK7543-1AX00-0XE0**Accessories****IE FC RJ45 Plug 180 2 x 2**

RJ45 plug connector for Industrial Ethernet with a rugged metal enclosure and integrated insulation displacement contacts for connecting Industrial Ethernet FC installation cables; with 180° cable outlet; for network components and CPs/CPU with Industrial Ethernet interface

- 1 pack = 1 unit
- 1 pack = 10 units
- 1 pack = 50 units

6GK1901-1BB10-2AA0
6GK1901-1BB10-2AB0
6GK1901-1BB10-2AE0

IE FC RJ45 Plug 4 x 2

RJ45 plug connector for Industrial Ethernet (10/100/1000 Mbps) with a rugged metal enclosure and integrated insulation displacement contacts for connecting Industrial Ethernet FC installation cables; 180° cable outlet; for network components and CPs/CPU with Industrial Ethernet interface

- 1 pack = 1 unit
- 1 pack = 10 units
- 1 pack = 50 units

6GK1901-1BB11-2AA0
6GK1901-1BB11-2AB0
6GK1901-1BB11-2AE0

IE FC TP Standard Cable GP 2 x 2 (Type A)

4-wire, shielded TP installation cable for connection to IE FC outlet RJ45/IE FC RJ45 plug; PROFINET-compatible; with UL approval; sold by the meter; max. length 1000 m, minimum order quantity 20 m

6XV1840-2AH10**IE FC TP Standard Cable GP 4 x 2**

8-wire, shielded TP installation cable for connection to IE FC RJ45 modular outlet for universal applications; with UL approval; sold by the meter; max. quantity 1000 m, minimum order 20 m

- AWG22, for connection to IE FC RJ45 modular outlet
- AWG24, for connection to IE FC RJ45 Plug 4 x 2

6XV1870-2E**6XV1878-2A****IE FC Stripping Tool**

Preadjusted stripping tool for fast stripping of the Industrial Ethernet FC cables

6GK1901-1GA00**Industrial Ethernet switch SCALANCE X204-2**

Industrial Ethernet switches with integral SNMP access, web diagnostics, copper cable diagnostics and PROFINET diagnostics for configuring line, star and ring topologies; four 10/100 Mbps RJ45 ports and two FO ports

6GK5204-2BB10-2AA3**Industrial Ethernet switch SCALANCE X308-2**

2 x 1000 Mbps multimode fiber-optic cable ports (SC sockets), 1 x 10/100/1000 Mbps RJ45 port, 7 x 10/100 Mbps RJ45 ports; for glass fiber-optic cable (multimode) up to max. 750 m

6GK5308-2FL00-2AA3Note:

You can find order information for software for communication with PC systems in the Catalog IK PI or in the Industry Mall.

Overview



- SINAUT communication module TIM 1531 IRC with four interfaces as a stand-alone unit for SIMATIC S7-1500 for use in wide area networks (WAN)
- For universal use in a SINAUT station, node station and control center
- Internet communication via integrated MSC-VPN tunnel with direct connection to DSL router or operation via IPsec VPN with additional SIMATIC NET components
- Wireless communication via GPRS/UMTS/LTE router, GPRS/UMTS/LTE modem or wireless devices
- Wired communication via Ethernet, DSL, dial-up modems or dedicated line modem
- Message frame memory for seamless recording of data and support of redundant communication paths
- Easy configuration in the TIA Portal

Ordering data

Ordering data	Article No.	Ordering data	Article No.
TIM 1531 IRC communication module TIM 1531 IRC communication module for SIMATIC S7-1500, S7-400, S7-300 with SINAUT ST7 with three RJ45 interfaces for communication via IP-based networks (WAN/LAN) and an RS 232/RS 485-interface for communication via classical WAN networks	6GK7543-1MX00-0XE0	SIMATIC PM 1507 Stabilized power supply for SIMATIC S7-1500 Input: 120/230 V AC Output: 24 V DC • Output current 3 A • Output current 8 A	6EP1332-4BA00 6EP1333-4BA00
Accessories STEP 7 Professional V14 SP1 Target system: SIMATIC S7-1200, S7-1500, S7-300, S7-400, WinAC Requirement: Windows 7 Professional SP1 (64-bit), Windows 7 Enterprise SP1 (64-bit), Windows 7 Ultimate SP1 (64-bit), Windows 8.1 Professional(64-bit), Windows 8.1 Enterprise (64-bit), Windows 10 Professional Version 1607, Windows 10 Enterprise Version 1607, Windows 10 Enterprise 2016 LTSC, Windows 10 Enterprise 2015 LTSC, Windows Server 2008 R2 StdE (full installation), Windows Server 2012 StdE (Vollinstallation), Windows Server 2016 Standard (full installation) Type of delivery: English, German, Chinese, Italian, French, Spanish		IE FC RJ45 Plug 180 RJ45 plug connector for Industrial Ethernet with a rugged metal housing and integrated insulation displacement/terminal contacts for connecting Industrial Ethernet FC installation cables; with 180° cable outlet • 1 pack = 1 unit • 1 pack = 10 units • 1 pack = 50 units	6GK1901-1BB10-2AA0 6GK1901-1BB10-2AB0 6GK1901-1BB10-2AE0
STEP 7 Professional V14 SP1, floating license	6ES7822-1AA04-0YA5		
STEP 7 Professional V14 SP1, floating license, software download incl. license key ¹⁾ Email address required for delivery	6ES7822-1AE04-0YA5		
STEP 7 Professional V14 SP1, trial license	6ES7822-1AA04-0YA7		

¹⁾ For up-to-date information and download availability, see: <http://www.siemens.com/tia-online-software-delivery>

SIMATIC S7-1500 Advanced Controllers

I/O modules

Communication

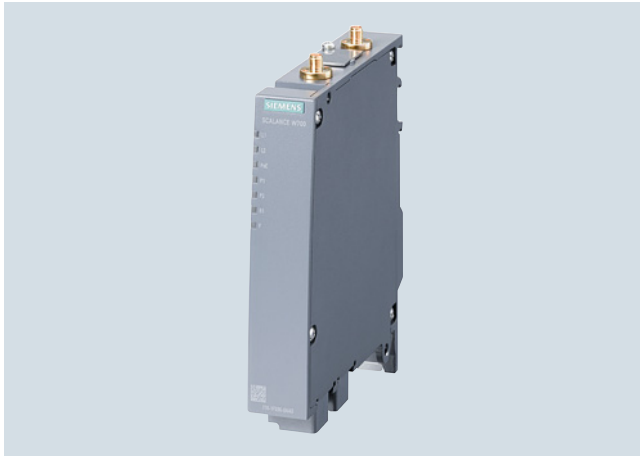
SCALANCE W774 RJ45 for use in control cabinet**Overview**

- Access points in SIMATIC design suitable for applications where the device is to be mounted in the control cabinet

4

Technical specifications

Article number	6GK5774-1FX00-0AA0 6GK5774-1FX00-0AB0 ¹⁾
Product type designation	SCALANCE W774-1 RJ45
Transmission rate	
• Transfer rate with WLAN maximum	300 Mbit/s
• Transfer rate for Industrial Ethernet	10 Mbit/s, 100 Mbit/s, 10 Mbit/s, 100 Mbit/s
Interfaces	
Number of electrical connections	
• for network components or terminal equipment	2
• for power supply	1
• for redundant voltage supply	1
Type of electrical connection	
• for network components or terminal equipment	RJ45 socket
• for power supply	4-pole screw terminal, PoE
design of the removable storage	
• C-PLUG	Yes
• KEY-PLUG	Yes
Interfaces wireless	
Number of radio cards permanently installed	1
Transmission mode for multiple input multiple output (MIMO)	2x2
Number of spatial streams	2
Number of electrical connections for external antenna(s)	2
Type of electrical connection for external antenna(s)	R-SMA (socket)
Product feature external antenna can be mounted directly on device	Yes

Article number	6GK5774-1FX00-0AA0 6GK5774-1FX00-0AB0 ¹⁾
Product type designation	SCALANCE W774-1 RJ45
Supply voltage, current consumption, power loss	
Type of voltage of the supply voltage	DC
Supply voltage 1	
• from terminal block	19.2 V
Supply voltage 2	
• from terminal block	28.8 V
Supply voltage	
• from Power-over-Ethernet acc. to IEEE802.3at for type 1 and IEEE802.3af	48 V
Consumed current	
• at DC at 24 V typical	0.25 A
• with Power-over-Ethernet according to IEEE802.3at for type 1 and IEEE802.3af typical	0.125 A
Power loss [W]	
• at DC at 24 V typical	6 W
• with Power-over-Ethernet according to IEEE802.3at for type 1 and IEEE802.3af typical	6 W
Permitted ambient conditions	
Ambient temperature	
• during operation	-20 ... +60 °C
• during storage	-40 ... +85 °C
• during transport	-40 ... +85 °C
Relative humidity at 25 °C without condensation during operation maximum	97 %
Ambient condition for operation	When used under hazardous conditions (Zone 2), the SCALANCE W774-1 RJ45 or W734-1 RJ45 product must be installed in an enclosure. To comply with EN 50021, this enclosure must meet the requirements of at least IP 54 in compliance with EN 60529.
Protection class IP	IP30

¹⁾ Wireless approval in the USA

Technical specifications (continued)

Article number	6GK5774-1FX00-0AA0 6GK5774-1FX00-0AB0 ¹⁾
Product type designation	SCALANCE W774-1 RJ45
Design, dimensions and weight	
Width	26 mm
Height	156 mm
Depth	127 mm
Width of the enclosure without antenna	26 mm
Height of the enclosure without antenna	147 mm
Depth of the enclosure without antenna	127 mm
Net weight	0.52 kg
Mounting type	wall mounting only if flat mounted
• S7-300 rail mounting	Yes
• S7-1500 rail mounting	Yes
• 35 mm DIN rail mounting	Yes
• wall mounting	Yes
Wireless frequencies	
Operating frequency	
• for WLAN in 2.4 GHz frequency band	2.41 ... 2.48 GHz
• for WLAN in 5 GHz frequency band	4.9 ... 5.8 GHz
Product properties, functions, components general	
Product function Access Point Mode	Yes
Product function Client Mode	Yes
Number of SSIDs	4
Product function	
• iPCF Access Point	Yes; Only in combination with the 'KEY-PLUG W780 iFeatures'
• iPCF client	Yes; Only in combination with the 'KEY-PLUG W740 iFeatures'
• iPCF-MC Access Point	No
• iPCF-MC client	Yes; Only in combination with the 'KEY-PLUG W740 iFeatures'
Number of iPCF-capable radio modules	1
Product function iREF	Yes
Number of iREF-capable radio modules	1
Product function iPRP	Yes; In combination with the 'KEY-PLUG W780 iFeatures' only
Product functions management, configuration	
Number of manageable IP addresses in client	8
Product function	
• CLI	Yes
• web-based management	Yes
• MIB support	Yes
• TRAPs via email	Yes
• Configuration with STEP 7	Yes
• configuration with STEP 7 in the TIA Portal	Yes
• operation with IWLAN controller	No
• operation with Enterasys WLAN controller	No
• forced roaming on IP down with IWLAN	Yes
• forced roaming on link down with IWLAN	Yes
• WDS	Yes

Article number	6GK5774-1FX00-0AA0 6GK5774-1FX00-0AB0 ¹⁾
Product type designation	SCALANCE W774-1 RJ45
Protocol is supported	
• Address Resolution Protocol (ARP)	Yes
• ICMP	Yes
• Telnet	Yes
• HTTP	Yes
• HTTPS	Yes
• TFTP	Yes
• DCP	Yes
• LLDP	Yes
Identification & maintenance function	
• I&MO - device-specific information	Yes
• I&M1 – higher-level designation/location designation	Yes
Product functions Diagnosis	
Product function	
• PROFINET IO diagnosis	Yes
• Link Check	No
• connection monitoring IP-Alive	No
• localization via Aeroscout	Yes
• SysLog	Yes
Protocol is supported	
• SNMP v1	Yes
• SNMP v2	Yes
• SNMP v3	Yes
Product functions VLAN	
Product function	
• function VLAN with IWLAN	Yes
Product functions DHCP	
Product function	
• DHCP client	Yes
• in Client Mode DHCP server via LAN	Yes
• DHCP Option 82	Yes
Product functions Redundancy	
Protocol is supported	
• STP/RSTP	Yes
• MSTP	Yes
• RSTP	Yes
Product functions Security	
Product function	
• ACL - MAC-based	Yes
• Management security, ACL-IP based	Yes
• IEEE 802.1x (radius)	Yes
• NAT/NAPT	No
• access protection according to IEEE802.11i	Yes
• WPA/WPA2	Yes
• TKIP/AES	Yes
Protocol is supported	
• SSH	Yes
• RADIUS	Yes
Product functions Time	
Protocol is supported	
• NTP	Yes
• SNTP	Yes
• SIMATIC Time	Yes

¹⁾ Wireless approval in the USA

SIMATIC S7-1500 Advanced Controllers

I/O modules

Communication

SCALANCE W774 RJ45 for use in control cabinet

Technical specifications (continued)

Article number	6GK5774-1FX00-0AA0 6GK5774-1FX00-0AB0 ¹⁾
Product type designation	SCALANCE W774-1 RJ45
Standards, specifications, approvals	
Standard	
• for FM	FM 3611: Class I, Division 2, Groups A,B,C,D, T4 / Class 1, Zone 2, Group IIC, T4
• for hazardous zone	EN 60079-15:2005, EN 60079-0:2006, II 3 G Ex nA II T4 KEMA 07 ATEX 0145X
• for safety from CSA and UL	UL 60950-1 CSA C22.2 No. 60950-1
Certificate of suitability	
• EC declaration of conformity	Yes
• CE marking	Yes
• C-Tick	Yes
• CCC	No
• E1 approval	No
• Railway application in accordance with EN 50155	No
• NEMA TS2	No
• IEC 61375	No
• IEC 61850-3	No
• NEMA4X	No
• Power-over-Ethernet according IEEE802.3at for type 1 and IEEE802.3af	Yes
• Power-over-Ethernet according to IEEE802.3at for type 2	Yes
Standard for wireless communication	
• IEEE 802.11a	Yes
• IEEE 802.11b	Yes
• IEEE 802.11e	Yes
• IEEE 802.11g	Yes
• IEEE 802.11h	Yes
• IEEE 802.11i	Yes
• IEEE 802.11n	Yes
Wireless approval	You will find the current list of countries at: www.siemens.com/wireless-approvals
Marine classification association	
• American Bureau of Shipping Europe Ltd. (ABS)	Yes
• Bureau Veritas (BV)	Yes
• DNV GL	Yes
• Lloyds Register of Shipping (LRS)	Yes
• Nippon Kaiji Kyokai (NK)	Yes
• Polski Rejestr Statkow (PRS)	Yes
• Royal Institution of Naval Architects (RINA)	Yes
Accessories	
accessories	24 V DC screw terminal included in scope of delivery

¹⁾ Wireless approval in the USA

Ordering data

Article No.

SCALANCE W774 access points

IWLAN access points with built-in wireless interface for establishing wireless connections with iFeatures; wireless networks IEEE 802.11a/b/g/h/n at 2.4/5 GHz up to 300 Mbps; WPA2/AES; integrated 2-port switch; Power over Ethernet (PoE), IP30 degree of protection (-20°C to +60°C); scope of delivery: Mounting hardware, 4-pin screw terminal for 24V DC; manual on CD-ROM; German/English

SCALANCE W774-1 RJ45

IWLAN Access Point with one built-in wireless interface

- National approvals for operation outside the USA
- National approvals for operation within the USA¹⁾

Accessories

KEY-PLUG W780 iFeatures

Swap medium for enabling additional iFeatures, for simple device replacement if a fault occurs and for storage of configuration data; can be used in SCALANCE W access points with PLUG compartment

C-PLUG

Swap medium for simple replacement of devices if a fault occurs; for storing configuration data; can be used in SIMATIC NET products with PLUG compartment

IE FC RJ45 Plug 180 2 x 2

RJ45 plug connector for Industrial Ethernet with a rugged metal enclosure and integrated insulation-displacement contacts for connecting Industrial Ethernet FC installation cables; with a 180° cable outlet; for network components and CPUs/CPUs with Industrial Ethernet interface

- 1 pack = 1 unit
- 1 pack = 10 units
- 1 pack = 50 units

IE FC Standard Cable GP 2 x 2

4-wire, shielded TP installation cable for connection to IE FC outlet RJ45 plug / IE FC RJ45 plug; PROFINET-compliant; with UL approval; sold by the meter; max. quantity 1000 m, minimum order 20 m

IE FC Stripping Tool

Preadjusted stripping tool for fast stripping of the Industrial Ethernet FC cables

Antennas and miscellaneous IWLAN accessories

See Catalog IK PI or Industry Mall

¹⁾ Please note national approvals under <http://www.siemens.com/wireless-approvals>

Overview

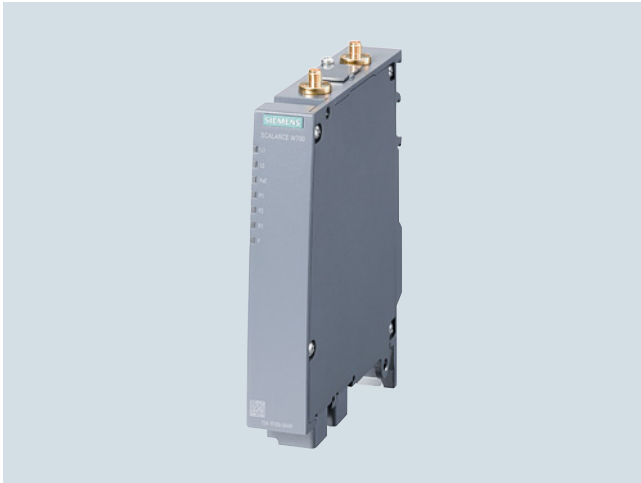

- Client modules in SIMATIC design suitable for applications where the device is to be mounted in the control cabinet



ET 200MP station with SCALANCE W734 RJ45

Technical specifications

Article number	6GK5734-1FX00-0AA0 6GK5734-1FX00-0AB0 ¹⁾
Product type designation	SCALANCE W734-1 RJ45
Transmission rate	
• Transfer rate with WLAN maximum	300 Mbit/s
• Transfer rate for Industrial Ethernet	10 Mbit/s, 100 Mbit/s, 10 Mbit/s, 100 Mbit/s
Interfaces	
Number of electrical connections	
• for network components or terminal equipment	2
• for power supply	1
• for redundant voltage supply	1
Type of electrical connection	
• for network components or terminal equipment	RJ45 socket
• for power supply	4-pole screw terminal, PoE
design of the removable storage	
• C-PLUG	Yes
• KEY-PLUG	Yes
Interfaces wireless	
Number of radio cards permanently installed	1
Transmission mode for multiple input multiple output (MIMO)	2x2
Number of spatial streams	2
Number of electrical connections for external antenna(s)	2
Type of electrical connection for external antenna(s)	R-SMA (socket)
Product feature external antenna can be mounted directly on device	Yes

Article number	6GK5734-1FX00-0AA0 6GK5734-1FX00-0AB0 ¹⁾
Product type designation	SCALANCE W734-1 RJ45
Supply voltage, current consumption, power loss	
Type of voltage of the supply voltage	DC
Supply voltage 1	
• from terminal block	19.2 V
Supply voltage 2	
• from terminal block	28.8 V
Supply voltage	
• from Power-over-Ethernet acc. to IEEE802.3at for type 1 and IEEE802.3af	48 V
Consumed current	
• at DC at 24 V typical	0.25 A
• with Power-over-Ethernet according to IEEE802.3at for type 1 and IEEE802.3af typical	0.125 A
Power loss [W]	
• at DC at 24 V typical	6 W
• with Power-over-Ethernet according to IEEE802.3at for type 1 and IEEE802.3af typical	6 W
Permitted ambient conditions	
Ambient temperature	
• during operation	-20 ... +60 °C
• during storage	-40 ... +85 °C
• during transport	-40 ... +85 °C
Relative humidity at 25 °C without condensation during operation maximum	95 %
Ambient condition for operation	When used under hazardous conditions (Zone 2), the SCALANCE W734-1 RJ45 or W734-1 RJ45 product must be installed in an enclosure. To comply with EN 50021, this enclosure must meet the requirements of at least IP 54 in compliance with EN 60529.
Protection class IP	IP30

¹⁾ Wireless approval in the USA

SIMATIC S7-1500 Advanced Controllers

I/O modules

Communication

SCALANCE W734 RJ45 for use in control cabinet

Technical specifications (continued)

Article number	6GK5734-1FX00-0AA0 6GK5734-1FX00-0AB0 ¹⁾
Product type designation	SCALANCE W734-1 RJ45
Design, dimensions and weight	
Width	26 mm
Height	156 mm
Depth	127 mm
Width of the enclosure without antenna	26 mm
Height of the enclosure without antenna	147 mm
Depth of the enclosure without antenna	127 mm
Net weight	0.52 kg
Mounting type	wall mounting only if flat mounted
• S7-300 rail mounting	Yes
• S7-1500 rail mounting	Yes
• 35 mm DIN rail mounting	Yes
• wall mounting	Yes
Wireless frequencies	
Operating frequency	
• for WLAN in 2.4 GHz frequency band	2.41 ... 2.48 GHz
• for WLAN in 5 GHz frequency band	4.9 ... 5.8 GHz
Product properties, functions, components general	
Product function Access Point Mode	No
Product function Client Mode	Yes
Product function	
• iPCF client	Yes; Only in combination with the 'KEY-PLUG W780 iFeatures' or 'KEY-PLUG W740 iFeatures'
• iPCF-MC Access Point	No
• iPCF-MC client	Yes; Only in combination with 'KEY-PLUG W780 iFeatures' or 'KEY-PLUG W740 iFeatures'
Number of iPCF-capable radio modules	1
Product function iPRP	Yes; In combination with the 'KEY-PLUG W780 iFeatures' or 'KEY-PLUG W740 iFeatures' only
Product functions management, configuration	
Number of manageable IP addresses in client	8
Product function	
• CLI	Yes
• web-based management	Yes
• MIB support	Yes
• TRAPs via email	Yes
• Configuration with STEP 7	Yes
• configuration with STEP 7 in the TIA Portal	Yes
• WDS	No
Protocol is supported	
• Address Resolution Protocol (ARP)	Yes
• ICMP	Yes
• Telnet	Yes
• HTTP	Yes
• HTTPS	Yes
• TFTP	Yes
• DCP	Yes
• LLDP	No

Article number	6GK5734-1FX00-0AA0 6GK5734-1FX00-0AB0 ¹⁾
Product type designation	SCALANCE W734-1 RJ45
Identification & maintenance function	
• I&M0 - device-specific information	Yes
• I&M1 - higher-level designation/location designation	Yes
Product functions Diagnosis	
Product function	
• PROFINET IO diagnosis	Yes
• Link Check	No
• connection monitoring IP-Alive	No
• SysLog	Yes
Protocol is supported	
• SNMP v1	Yes
• SNMP v2	Yes
• SNMP v3	Yes
Product functions VLAN	
Product function	
• function VLAN with IWLAN	No
Product functions DHCP	
Product function	
• DHCP client	Yes
• in Client Mode DHCP server via LAN	Yes
• DHCP Option 82	Yes
Product functions Redundancy	
Protocol is supported	
• STP/RSTP	Yes
• MSTP	Yes
• RSTP	Yes
Product functions Security	
Product function	
• ACL - MAC-based	Yes
• Management security, ACL-IP based	Yes
• IEEE 802.1x (radius)	Yes
• NAT/NAPT	Yes
• access protection according to IEEE802.11i	Yes
• WPA/WPA2	Yes
• TKIP/AES	Yes
Protocol is supported	
• SSH	Yes
• RADIUS	Yes
Product functions Time	
Protocol is supported	
• NTP	Yes
• SNTP	Yes
• SIMATIC Time	Yes

¹⁾ Wireless approval in the USA

Technical specifications (continued)

Article number	6GK5734-1FX00-0AA0 6GK5734-1FX00-0AB0 ¹⁾
Product type designation	SCALANCE W734-1 RJ45
Standards, specifications, approvals	
Standard	
• for FM	FM 3611: Class I, Division 2, Groups A,B,C,D, T4 / Class 1, Zone 2, Group IIC, T4
• for hazardous zone	EN 60079-15:2005, EN 60079-0:2006, II 3 G Ex nA II T4 KEMA 07 ATEX 0145X
• for safety from CSA and UL	UL 60950-1 CSA C22.2 No. 60950-1
Certificate of suitability	
• EC declaration of conformity	Yes
• CE marking	Yes
• C-Tick	Yes
• CCC	No
• E1 approval	No
• Railway application in accordance with EN 50155	No
• NEMA TS2	No
• IEC 61375	No
• IEC 61850-3	No
• NEMA4X	No
• Power-over-Ethernet according IEEE802.3at for type 1 and IEEE802.3af	Yes
• Power-over-Ethernet according to IEEE802.3at for type 2	Yes
Standard for wireless communication	
• IEEE 802.11a	Yes
• IEEE 802.11b	Yes
• IEEE 802.11e	Yes
• IEEE 802.11g	Yes
• IEEE 802.11h	Yes
• IEEE 802.11i	Yes
• IEEE 802.11n	Yes
Wireless approval	You will find the current list of countries at: www.siemens.com/wireless-approvals
Marine classification association	
• American Bureau of Shipping Europe Ltd. (ABS)	Yes
• Bureau Veritas (BV)	Yes
• DNV GL	Yes
• Lloyds Register of Shipping (LRS)	Yes
• Nippon Kaiji Kyokai (NK)	Yes
• Polski Rejestr Statkow (PRS)	Yes
• Royal Institution of Naval Architects (RINA)	Yes
Accessories	
accessories	24 V DC screw terminal included in scope of delivery

¹⁾ Wireless approval in the USA

Ordering data

Article No.

SCALANCE W734 Client Modules

IWLAN Ethernet client modules with built-in wireless interface; wireless networks IEEE 802.11a/b/g/h/n at 2.4/5 GHz up to 300 Mbps; WPA2/AES; integrated 2-port switch; Power over Ethernet (PoE), IP30 degree of protection (-20°C to +60°C); scope of delivery: Mounting hardware, 4-pin screw terminal for 24V DC; manual on CD-ROM; German/English

SCALANCE W734-1 RJ45

For managing the wireless connection of up to eight linked devices with Industrial Ethernet connection

- National approvals for operation outside the USA
- National approvals for operation within the USA ¹⁾

6GK5734-1FX00-0AA0

6GK5734-1FX00-0AB0

Accessories

KEY-PLUG W740 iFeatures

Swap medium for enabling additional iFeatures, for simple device replacement if a fault occurs and for storage of configuration data; can be used in SCALANCE W client modules with PLUG compartment

6GK5907-4PA00

C-PLUG

Swap medium for simple replacement of devices if a fault occurs; for storing configuration data; can be used in SIMATIC NET products with PLUG compartment

6GK1900-0AB00

IE FC RJ45 Plug 180 2 x 2

RJ45 plug connector for Industrial Ethernet with a rugged metal enclosure and integrated insulation-displacement contacts for connecting Industrial Ethernet FC installation cables; with a 180° cable outlet; for network components and CPs/CPUs with Industrial Ethernet interface

- 1 pack = 1 unit
- 1 pack = 10 units
- 1 pack = 50 units

6GK1901-1BB10-2AA0

6GK1901-1BB10-2AB0

6GK1901-1BB10-2AE0

IE FC Standard Cable GP 2 x 2

4-wire, shielded TP installation cable for connection to IE FC outlet RJ45 plug / IE FC RJ45 plug; PROFINET-compliant; with UL approval; sold by the meter; max. quantity 1000 m minimum order 20 m

6XV1840-2AH10

IE FC Stripping Tool

Preadjusted stripping tool for fast stripping of the Industrial Ethernet FC cables

6GK1901-1GA00

Antennas and miscellaneous IWLAN accessories

See Catalog IK PI or Industry Mall

¹⁾ Please note national approvals under <http://www.siemens.com/wireless-approvals>

SIMATIC S7-1500 Advanced Controllers

I/O modules

SIPLUS communication

SIPLUS CM PtP**Overview**

- Modules for serial communication connections, scaled according to interface types, protocols, and performance
- 4 versions with different physical transmission characteristics:
 - RS 232C, max. 19.2 kbps
 - RS 232C, max. 115.2 kbps
 - RS 422/RS 485, max. 19.2 kbps
 - RS 422/RS 485, max. 115.2 kbps
- Protocols supported
 - Freeprot: User-parameterizable telegram format for universal communication
 - 3964(R) for improved transmission reliability
 - Modbus RTU Master
 - Modbus RTU Slave
 - USS, implemented through instructions

Note:

SIPLUS extreme products are based on SIMATIC standard products. The contents listed here were taken from the respective standard products. SIPLUS extreme-specific information was added.

Technical specifications

Article number	6AG1540-1AD00-7AA0	6AG1541-1AD00-7AB0	6AG1540-1AB00-7AA0	6AG1541-1AB00-7AB0
Based on	6ES7540-1AD00-0AA0 SIPLUS S7-1500 CM PTP RS 232 BA	6ES7541-1AD00-0AB0 SIPLUS S7-1500 CM PTP RS 232 HF	6ES7540-1AB00-0AA0 SIPLUS S7-1500 CM PTP RS 422/485 BA	6ES7541-1AB00-0AB0 SIPLUS S7-1500 CM PTP RS 422/485 HF
Ambient conditions				
Ambient temperature during operation				
• horizontal installation, min.	-40 °C; = Tmin; Startup @ -25 °C	-40 °C; = Tmin; Startup @ -25 °C	-40 °C; = Tmin; Startup @ -25 °C	-40 °C; = Tmin; Startup @ -25 °C
• horizontal installation, max.	70 °C	70 °C	70 °C	70 °C
• vertical installation, min.	-40 °C; = Tmin; Startup @ -25 °C	-40 °C; = Tmin; Startup @ -25 °C	-40 °C; = Tmin; Startup @ -25 °C	-40 °C; = Tmin; Startup @ -25 °C
• vertical installation, max.	40 °C	40 °C	40 °C	40 °C
Extended ambient conditions				
• relative to ambient temperature-atmospheric pressure-installation altitude	Tmin ... Tmax at 1080 hPa ... 795 hPa (-1000 m ... +2000 m) // Tmin ... (Tmax - 10K) at 795 hPa ... 658 hPa (+2000 m ... +3500 m) // Tmin ... (Tmax - 20K) at 658 hPa ... 540 hPa (+3500 m ... +5000 m)	Tmin ... Tmax at 1080 hPa ... 795 hPa (-1000 m ... +2000 m) // Tmin ... (Tmax - 10K) at 795 hPa ... 658 hPa (+2000 m ... +3500 m) // Tmin ... (Tmax - 20K) at 658 hPa ... 540 hPa (+3500 m ... +5000 m)	Tmin ... Tmax at 1080 hPa ... 795 hPa (-1000 m ... +2000 m) // Tmin ... (Tmax - 10K) at 795 hPa ... 658 hPa (+2000 m ... +3500 m) // Tmin ... (Tmax - 20K) at 658 hPa ... 540 hPa (+3500 m ... +5000 m)	Tmin ... Tmax at 1080 hPa ... 795 hPa (-1000 m ... +2000 m) // Tmin ... (Tmax - 10K) at 795 hPa ... 658 hPa (+2000 m ... +3500 m) // Tmin ... (Tmax - 20K) at 658 hPa ... 540 hPa (+3500 m ... +5000 m)
Relative humidity				
- With condensation, tested in accordance with IEC 60068-2-38, max.	100 %; RH incl. condensation/frost (no commissioning under condensation conditions)	100 %; RH incl. condensation/frost (no commissioning under condensation conditions)	100 %; RH incl. condensation/frost (no commissioning under condensation conditions)	100 %; RH incl. condensation/frost (no commissioning under condensation conditions)

Technical specifications (continued)

Article number	6AG1540-1AD00-7AA0	6AG1541-1AD00-7AB0	6AG1540-1AB00-7AA0	6AG1541-1AB00-7AB0
Based on	6ES7540-1AD00-0AA0 SIPLUS S7-1500 CM PtP RS 232 BA	6ES7541-1AD00-0AB0 SIPLUS S7-1500 CM PtP RS 232 HF	6ES7540-1AB00-0AA0 SIPLUS S7-1500 CM PtP RS 422/485 BA	6ES7541-1AB00-0AB0 SIPLUS S7-1500 CM PtP RS 422/485 HF
Resistance				
- against biologically active substances / conformity with EN 60721-3-3	Yes; Class 3B2 mold, fungus and dry rot spores (with the exception of fauna). The supplied connector covers must remain on the unused interfaces during operation!	Yes; Class 3B2 mold, fungus and dry rot spores (with the exception of fauna). The supplied connector covers must remain on the unused interfaces during operation!	Yes; Class 3B2 mold, fungus and dry rot spores (with the exception of fauna). The supplied connector covers must remain on the unused interfaces during operation!	Yes; Class 3B2 mold, fungus and dry rot spores (with the exception of fauna). The supplied connector covers must remain on the unused interfaces during operation!
- against chemically active substances / conformity with EN 60721-3-3	Yes; Class 3C4 (RH < 75%) incl. salt spray according to EN 60068-2-52 (degree of severity 3). The supplied connector covers must remain on the unused interfaces during operation!	Yes; Class 3C4 (RH < 75%) incl. salt spray according to EN 60068-2-52 (degree of severity 3). The supplied connector covers must remain on the unused interfaces during operation!	Yes; Class 3C4 (RH < 75%) incl. salt spray according to EN 60068-2-52 (degree of severity 3). The supplied connector covers must remain on the unused interfaces during operation!	Yes; Class 3C4 (RH < 75%) incl. salt spray according to EN 60068-2-52 (degree of severity 3). The supplied connector covers must remain on the unused interfaces during operation!
- against mechanically active substances / conformity with EN 60721-3-3	Yes; Class 3S4 incl. sand, dust. The supplied connector covers must remain on the unused interfaces during operation!	Yes; Class 3S4 incl. sand, dust. The supplied connector covers must remain on the unused interfaces during operation!	Yes; Class 3S4 incl. sand, dust. The supplied connector covers must remain on the unused interfaces during operation!	Yes; Class 3S4 incl. sand, dust. The supplied connector covers must remain on the unused interfaces during operation!

Ordering data**Article No.****Article No.**

SIPLUS CM PtP RS 232 BA communication module
(Extended temperature range and exposure to media)
Basic communication module with 1 interface RS 232, Freeport, 3964(R) and USS protocols, 9-pin sub D connector, max. 19.2 kbps

6AG1540-1AD00-7AA0**Accessories**

See SIMATIC S7-1500, CM PtP communication module, page 4/118

SIPLUS CM PtP RS 232 HF communication module
(Extended temperature range and exposure to media)
High Feature communication module with 1 interface RS 232, Freeport, 3964(R), USS and Modbus RTU protocols, 9-pin sub D connector, max. 115.2 kbps

6AG1541-1AD00-7AB0

SIPLUS CM PtP RS 422/485 BA communication module
(Extended temperature range and exposure to media)
Basic communication module with 1 interface RS 422/485, Freeport, 3964(R) and USS protocols, 15-pin sub D socket, max. 19.2 kbps

6AG1540-1AB00-7AA0

SIPLUS CM PtP RS 422/485 HF communication module
(Extended temperature range and exposure to media)
High Feature communication module with 1 interface RS 422/485, Freeport, 3964(R), USS and Modbus RTU protocols, 15-pin sub D socket, max. 115.2 kbps

6AG1541-1AB00-7AB0

SIMATIC S7-1500 Advanced Controllers

I/O modules

SIPLUS communication

SIPLUS NET CM 1542-5**Overview**

DP-M	DP-S	FMS	PG/OP	S7/S5	
●	●		●	●	

The CM 1542-5 communication module expands the SIMATIC S7-1500 Controller to include a PROFIBUS connection for communication with lower-level PROFIBUS devices in bandwidths from 9.6 kbps to 12 Mbps. The module can also be used to implement separate PROFIBUS lines, in other words, to control a number of different field devices via a number of PROFIBUS segments. The CM 1542-5 handles all communication tasks, thus reducing the CPU load.

Apart from classic PROFIBUS communication; the CM 1542-5 is also suitable for S7 communication. This makes it possible to establish communication between the S7-1500 Controller and other devices, for example those from the SIMATIC S7-300/400 range.

- PROFIBUS DP master or DP slave with electrical interface for connecting the SIMATIC S7-1500 to PROFIBUS at up to 12 Mbps (including 45.45 kbps)
- Communications services:
 - PROFIBUS DP
 - PG/OP communication
 - S7 communication
- Time synchronization
- Simple programming and configuration over PROFIBUS
- Cross-network PG communication using S7 routing
- Module replacement without a PG
- Data record routing (PROFIBUS DP)
- Adding or modifying distributed I/O during operation

Note:

SIPLUS extreme products are based on SIMATIC standard products. The contents listed here were taken from the respective standard products. SIPLUS extreme-specific information was added.

Ordering data**Article No.****SIPLUS CM 1542-5 communication module**

(Extended temperature range and exposure to media)

Communication module for electrical connection of SIMATIC S7-1500 to PROFIBUS as a DP master or DP slave

6AG1542-5DX00-7XE0**Accessories**

See SIMATIC S7-1500, CM 1542-5 communication module, page 4/120

Overview



ISO	TCP/UDP	PN	MRP	IT	IP-R	PG/OP	S7/S5
●	●			●	●	●	●

The SIMATIC CP 1543-1 communications processor securely connects the new SIMATIC S7-1500 Controller to Industrial Ethernet networks. By combining a variety of security features such as an SPI (Stateful Packet Inspection) firewall, VPN and data encryption protocols such as FTPS and SNMPv3, the communications processor protects individual S7-1500 stations or even entire automation cells against unauthorized access.

The CP can also be used for linking the S7-1500 station into an IPv6-based network. All functions are configured by means of STEP 7 Professional V12 (TIA Portal) or higher.

The CP 1543-1 supports the following communications services:

- PG/OP communication
- S7 communication
- Open communication (SEND/RECEIVE, FETCH/WRITE)
- IT communication
 - FTP functions (File Transfer Protocol FTP/FTPS) for file management and access to data blocks in the CPU (client and server function)
 - Sending emails via SMTP or ESMTP with "SMTP-Auth" for authentication on an email server (also with IPv6)
- Security functions
 - Stateful Packet Inspection (layers 3 and 4) firewall
 - Secure communication via VPN (IPsec)
 - Secure access to the web server of the CPU via the HTTPS protocol
 - Secure file transfer using FTPS
 - Secure transfer of the time of day (NTP)
 - SNMPv3 for tap-proof transfer of network analysis information
- Integration of the S7-1500 into IPv6-based networks; An IPv6-compliant IP address can be used for the following communication services:
 - FETCH/WRITE access (CP as server)
 - FTP server mode
 - FTP client mode with addressing by program block
 - Email transfer with addressing by program block

Note

SIPLUS extreme products are based on SIMATIC standard products. The contents listed here were taken from the respective standard products. SIPLUS extreme specific information was added.

Ordering data

Article No.

SIPLUS CP 1543-1 communications processor**6AG1543-1AX00-2XE0**

(Extended temperature range and exposure to media)

For connection of SIMATIC S7-1500 to Industrial Ethernet via TCP/IP, ISO and UDP and Security functions; 1 x RJ45 interface with 10/100/1000 Mbps; electronic manual on DVD

Accessories

See SIMATIC S7-1500, SIMATIC CP 1543-1 communications processor, page 4/128

SIMATIC S7-1500 Advanced Controllers

I/O modules

Connection system

Front connectors

Overview



- Uniform, 40-pin front connector, suitable for SIMATIC S7-1500 I/O modules
- Versions for 25 mm wide or 35 mm wide modules
- With screw-type or push-in terminals
- Connectable wire cross-sections: 0.25 mm² to 1.5 mm² (AWG 24 to 16)
- Front connector for 35 mm modules to be ordered separately; front connector for 25 mm modules included in scope of supply of modules

Design

- 40 terminals, arranged in two rows, numbered consecutively from 1 to 40
- Direct assignment of terminal to LED and labeling simplifies wiring, commissioning, and troubleshooting
- Holders for four potential bridges for simple and flexible creation of potential groups; four units are supplied with the front connector (optionally available as spare parts in packs of 20)
- Integrated shielding concept for analog modules and technology modules; allows space-saving installation without tools and ensures high ruggedness and EMC stability; components supplied with analog modules
- Cable ties for mechanical fixing of the cable bundle and for strain relief; 1 unit supplied with front connector

Ordering data

Article No.

Front connectors

For 35 mm modules; including four potential bridges, cable ties and individual labeling strips, 40-pin

- Screw terminals
- Push-in

6ES7592-1AM00-0XB0

6ES7592-1BM00-0XB0

For 25 mm modules; including cable ties and individual labeling strips; push-in, 40-pin; spare part

6ES7592-1BM00-0XA0

Potential bridges for front connectors

For 35 mm modules; 20 pieces; spare part

6ES7592-3AA00-0AA0

Overview

With two cabling systems, SIMATIC TOP connect ensures efficient wiring of the input and output module of the SIMATIC S7-1500: Fully modular connection for fast and clearly arranged connecting to sensors and actuators in the field, and flexible connection for simple wiring inside the control cabinet.

With the TIA Selection Tool, you can select suitable system cabling for the individual I/O modules with a simple mouse click. Suitable components for the respective I/O module are always offered. These can be transferred to the order list and then ordered in the Industry Mall.

More information can be found on the Internet at <http://www.siemens.com/tia-selection-tool>

Design

Two cabling variants are available for a wide range of control cabinet concepts:

Fully modular connection

The system consists of:

- Front connector module
- Connecting cable
- Connection modules in the following versions: Basic module, signal module and function module

Connection errors are thus practically excluded and installation overhead is significantly reduced. Systematic connection of the SIMATIC system. The assembly overhead for the connecting cables is drastically reduced thanks to the use of pre-assembled or easily assembled cables sold by the meter.

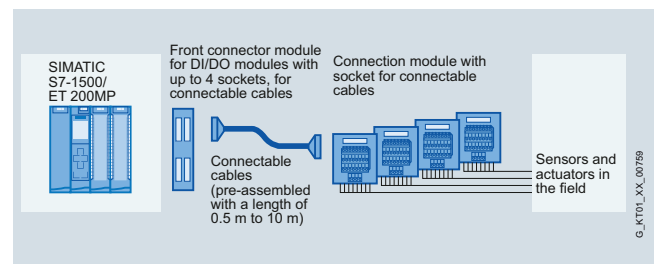

SIMATIC TOP connect for S7-1500/ ET200 MP, fully modular connection

Flexible connection

Flexible connection with front connectors is available with 20 (Pin1 – 20) or 40 wired single wires.

These are available in lengths from 2.5 m to 10.0 m.

The single wires are available in different versions:

- Wire type H05V-K is used for industrial applications
- The UL/CSA-approved wire is available for export to North America
- The halogen-free version is used where low smoke gas density in the event of fire is required, e.g. in building automation

The blue wires are numbered sequentially and can be routed direct to each element in the control cabinet. The numbering of the single wires corresponds to the coding of the front connector contacts.

In comparison to conventional single wiring, there is a cost saving of 50% for assembly, since the single wires that have already been checked on the connector are fixed.

Thus no complex pre-assembly of up to two times 20 single wires per module is necessary.

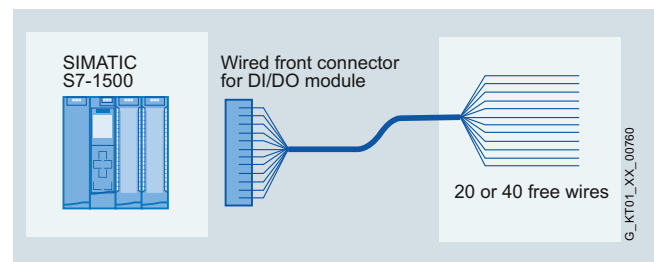

SIMATIC TOP connect for S7-1500/ ET200 MP, flexible connection

SIMATIC S7-1500 Advanced Controllers

I/O modules

Connection system

System cabling for SIMATIC S7-1500 and ET 200MP > Fully modular connection

Overview



The fully modular connection for connecting to the digital I/O modules of the SIMATIC S7-1500 or ET 200MP consists of modified front connectors, called front connector modules, pre-assembled connecting cables of various lengths, and connection modules. Suitable components can be selected for the application in question and joined by means of simple plugs. The connection modules are used instead of conventional terminal blocks and act as the interface to the sensors and actuators.

Benefits

- Easy plugging in of front connector module, connecting cable and connection module
- Fast and low-cost wiring
- In the case of digital signals, the supply voltage can be connected to the front connector module or the connection module
- Reduction in wiring errors, clear control cabinet wiring
- Byte-by-byte, or four-byte distribution of the signals in the case of digital signals
- Each component can be replaced individually
- Every cable length can be configured without cutting, or pre-assembled cables can be used

Design

Front connector module

Modified front connectors, called front connector modules, are available for connecting to the I/O modules. These are plugged into the I/O module to be wired instead of the front connector. The front connector modules are available in many different versions for digital I/O modules, analog I/O modules and for the 24 V, 2-ampère module. The connecting cables are plugged into these front connector modules.

Connecting cable

The connecting cable is available in two different versions.

As a pre-assembled 16-pole or 50-pole round cable (shielded or unshielded) up to a length of 10 m, or as a 16-pole round-sheath ribbon cable (with or without shield), which can be easily assembled by the user; or as 2 x 16-pole round-sheath ribbon cables (without shield).

When assembled, there are one or two insulation displacement connectors (female ribbon connectors) at both ends of the cable.

The round-sheath ribbon cable is assembled by the user with the aid of pliers (can be ordered separately). The cable transmits 8 or 2 x 8 channels over a distance of up to 30 m.

The connecting cable connects the front connector module with the connection module.

Connection module

The system has digital and analog connection modules for connecting the I/O signals. These are snapped onto the standard mounting rail. The connection modules with basic or signal functionality are available in 1-byte or 4-byte versions.

Connection modules are available for two different connection methods: with push-in or screw-type terminals. The potential can be fed in at the connection module or at the front connector module.

If other voltage or power levels are required in the field, the connection module for TPRo or TPOo output signals is used. For the TPRo connection module, relays are used for the implementation. For the TPOo connection module, optocouplers are used for the implementation. This converts the 24 V DC output signal simply and reliably to another voltage or power level. If 230 V AC or 110 V AC input signals have to be transmitted to the controller in the field, a connection module with relay TPRi is available that simply converts the 230/110 V AC signal to 24 V DC. This means that there is always the same voltage level on the module side.

Use with optocouplers for the TPRo relay modules

If higher switching frequencies of the relay connection module are required for the output signals, the relay can simply be replaced with an optocoupler (note technical specifications) in order to increase the switching frequency here.

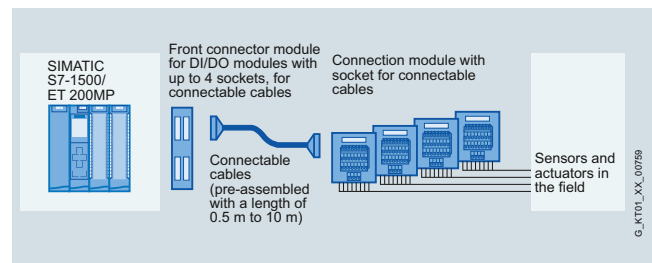

SIMATIC TOP connect for S7-1500/ ET200 MP, fully modular connection

Technical specifications Front connector modules

Rated operating voltage	24 V DC
Max. permissible operating voltage	60 V DC
Max. permissible continuous current • per connector pin	1 A
Max. permissible total current	2 A/byte
Permissible ambient temperature	0 to +60 °C
Test voltage	0.5 kV, 50 Hz, 60 sec.
Clearance and creepage distances	IEC 664 (1980), IEC 664 A (1981), in accordance with DIN VDE 0110 (01.89), overvoltage class II, pollution degree 2

Wiring rules for the front connector modules

SIMATIC TOP connect front connector module, connection for potential infeed	
	Push-in Screw terminals
Modules up to 4 connections	
Connectable cable cross-sections	
• Solid conductors	No
• Flexible cables with/without wire end ferrule	0.25 to 1.5 mm ²
Number of cables per connection	1 or a combination of 2 wires up to 1.5 mm ² (total) in a common wire end ferrule
Max. diameter of the cable insulation	3.1 mm
Stripped length of the cables	
• Without insulating collar	6 mm
• With insulating collar	-
Wire end ferrules according to DIN 46228	
• Without insulating collar	Form A; 5 to 7 mm long
• with insulating collar 0.25 to 1.0 mm ²	-
• with insulating collar 1.5 mm ²	-
Blade width of the screwdriver	3.5 mm (cylindrical design)
Tightening torque for connecting the cables	- 0.4 Nm to 0.7 Nm

Technical specifications Connecting cable

Technical specifications of connecting cable from SIMATIC S7 to connection module	
Operating voltage	60 V DC
Continuous current per signal conductor	1 A
Max. aggregate current	4 A/byte
Operating temperature	0 to +60 °C
Outer diameter of pre-assembled round cable in mm unshielded/ shielded (16-pole)	Approx. 6.5/7.0
Outer diameter of round-sheath ribbon cable in mm 16-pole/2 x 16-pole	Approx. 9.5/11.5

Ordering data**Article No.****Front connector modules**

Front connector module for digital modules for the connection of 16-pin connecting cables	
Power supply via • Push-in • Screw terminals	6ES7921-5AH20-0AA0 6ES7921-5AB20-0AA0
Front connector module for digital modules for the connection of 50-pin connecting cables	
Power supply via • Push-in • Screw terminals	6ES7921-5CH20-0AA0 6ES7921-5CB20-0AA0
Front connector module for 2 A digital modules for the connection of 16-pin connecting cables	
Power supply via • Push-in • Screw terminals	6ES7921-5AJ00-0AA0 6ES7921-5AD00-0AA0
Front connector module for analog modules for the connection of 16-pin connecting cables	6ES7921-5AK20-0AA0
Front connector module for analog modules for the connection of 50-pin connecting cables	6ES7921-5CK20-0AA0

SIMATIC S7-1500 Advanced Controllers

I/O modules

Connection system

System cabling for SIMATIC S7-1500 and ET 200MP > Fully modular connection

Ordering data**Article No.****Article No.****Connecting cables****Connecting cables for SIMATIC S7-300/S7-1500****Pre-assembled round cable**16-pin, 0.14 mm²

Unshielded

- 0.5 m
- 1.0 m
- 1.5 m
- 2.0 m
- 2.5 m
- 3.0 m
- 4.0 m
- 5.0 m
- 6.5 m
- 8.0 m
- 10.0 m

6ES7923-0BA50-0CB0
 6ES7923-0BB00-0CB0
 6ES7923-0BB50-0CB0
 6ES7923-0BC00-0CB0
 6ES7923-0BC50-0CB0
 6ES7923-0BD00-0CB0
 6ES7923-0BE00-0CB0
 6ES7923-0BF00-0CB0
 6ES7923-0BG50-0CB0
 6ES7923-0BJ00-0CB0
 6ES7923-0CB00-0CB0

Shielded

- 1.0 m
- 2.0 m
- 2.5 m
- 3.0 m
- 4.0 m
- 5.0 m
- 6.5 m
- 8.0 m
- 10.0 m

6ES7923-0BB00-0DB0
 6ES7923-0BC00-0DB0
 6ES7923-0BC50-0DB0
 6ES7923-0BD00-0DB0
 6ES7923-0BE00-0DB0
 6ES7923-0BF00-0DB0
 6ES7923-0BG50-0DB0
 6ES7923-0BJ00-0DB0
 6ES7923-0CB00-0DB0

Version 4 x 16 to 1 x 50-pin,
0.14 mm²

Unshielded

- 0.5 m
- 1.0 m
- 1.5 m
- 2.0 m
- 2.5 m
- 3.0 m
- 4.0 m
- 5.0 m
- 6.5 m
- 8.0 m
- 10.0 m

6ES7923-5BA50-0EB0
 6ES7923-5BB00-0EB0
 6ES7923-5BB50-0EB0
 6ES7923-5BC00-0EB0
 6ES7923-5BC50-0EB0
 6ES7923-5BD00-0EB0
 6ES7923-5BE00-0EB0
 6ES7923-5BF00-0EB0
 6ES7923-5BG50-0EB0
 6ES7923-5BJ00-0EB0
 6ES7923-5CB00-0EB0

Round-sheath ribbon cable16-pin, 0.14 mm²

Unshielded

- 30 m
- 60 m

6ES7923-0CD00-0AA0
 6ES7923-0CG00-0AA0

Shielded

- 30 m
- 60 m

6ES7923-0CD00-0BA0
 6ES7923-0CG00-0BA0

Round-sheath ribbon cable2 x 16-pin, 0.14 mm²

Unshielded

- 30 m
- 60 m

6ES7923-2CD00-0AA0
 6ES7923-2CG00-0AA0

Connector (female ribbon connector)

6ES7921-3BE10-0AA0

16-pin,
insulation displacement system,
with strain relief devices;
packing unit: 8 connectors
and 8 cable grips

Connecting cables for S7-1500**Pre-assembled round cable**50-pin, 0.14 mm²

Unshielded

- 0.5 m
- 1.0 m
- 1.5 m
- 2.0 m
- 2.5 m
- 3.0 m
- 4.0 m
- 5.0 m
- 6.5 m
- 8.0 m
- 10.0 m

6ES7923-5BA50-0CB0
 6ES7923-5BB00-0CB0
 6ES7923-5BB50-0CB0
 6ES7923-5BC00-0CB0
 6ES7923-5BC50-0CB0
 6ES7923-5BD00-0CB0
 6ES7923-5BE00-0CB0
 6ES7923-5BF00-0CB0
 6ES7923-5BG50-0CB0
 6ES7923-5BJ00-0CB0
 6ES7923-5CB00-0CB0

Shielded

- 1.0 m
- 2.0 m
- 2.5 m
- 3.0 m
- 4.0 m
- 5.0 m
- 6.5 m
- 8.0 m
- 10.0 m

6ES7923-5BB00-0DB0
 6ES7923-5BC00-0DB0
 6ES7923-5BC50-0DB0
 6ES7923-5BD00-0DB0
 6ES7923-5BE00-0DB0
 6ES7923-5BF00-0DB0
 6ES7923-5BG50-0DB0
 6ES7923-5BJ00-0DB0
 6ES7923-5CB00-0DB0

Accessories**Manual pliers**For preparing the connectors
(female ribbon connector)

6ES7928-0AA00-0AA0

Ordering data	Article No.	Article No.	
Connection modules			
Connection module TP1 For 1-wire connection, for 16-pin connecting cables <ul style="list-style-type: none"> • Push-in terminals without LEDs • Screw-type terminals without LEDs • Push-in terminals with LEDs • Screw-type terminals with LEDs For 1-wire connection, for 50-pin connecting cables <ul style="list-style-type: none"> • Push-in terminals without LEDs • Push-in terminals with LEDs • Screw-type terminals without LEDs • Screw-type terminals with LEDs 	6ES7924-0AA20-0AC0 6ES7924-0AA20-0AA0 6ES7924-0AA20-0BC0 6ES7924-0AA20-0BA0 6ES7924-2AA20-0AC0 6ES7924-2AA20-0BC0 6ES7924-2AA20-0AA0 6ES7924-2AA20-0BA0	Connection module for digital output modules 2 A Connection module TP2 <ul style="list-style-type: none"> • Push-in terminals without LEDs • Screw-type terminals without LEDs 	6ES7924-0BB20-0AC0 6ES7924-0BB20-0AA0
Connection module TP3 For 3-wire connection, for 16-pin connecting cables <ul style="list-style-type: none"> • Push-in terminals without LEDs • Screw-type terminals without LEDs • Push-in terminals with LEDs • Screw-type terminals with LEDs • Push-in terminals with LEDs and one isolating terminal per channel • Screw-type terminals with LEDs and one isolating terminal per channel • Push-in terminals with LED and fuse per channel • Screw-type terminals with LED and fuse per channel For 3-wire connection, for 50-pin connecting cables <ul style="list-style-type: none"> • Push-in terminals without LEDs • Screw-type terminals without LEDs • Push-in terminals with LEDs • Screw-type terminals with LEDs 	6ES7924-0CA20-0AC0 6ES7924-0CA20-0AA0 6ES7924-0CA20-0BC0 6ES7924-0CA20-0BA0 6ES7924-0CH20-0BC0 6ES7924-0CH20-0BA0 6ES7924-0CL20-0BC0 6ES7924-0CL20-0BA0 6ES7924-2CA20-0AC0 6ES7924-2CA20-0AA0 6ES7924-2CA20-0BC0 6ES7924-2CA20-0BA0	Connection module for analog modules (for S7-1500 only) Connection module TPA, 16-pin <ul style="list-style-type: none"> • Push-in terminals without LEDs • Screw-type terminals without LEDs Connection module TPA, 50-pin <ul style="list-style-type: none"> • Push-in terminals without LEDs • Screw-type terminals without LEDs 	6ES7924-0CC20-0AC0 6ES7924-0CC20-0AA0 6ES7924-2CC20-0AC0 6ES7924-2CC20-0AA0
Accessories			
ID labels for connection modules in S7-1500 design			
ID labels, insertable PU = 340 units		3RT1900-1SB20	
Shield plate for analog connection module			
PU = 4 units (for connection of 16-pin connecting cable)		6ES7928-1AA20-4AA0	
PU = 4 units (for connection of 16-pin connecting cable) (for S7-1500 only)		6ES7928-1BA20-4AA0	
Shield connection clamp			
For shield plate at SIMATIC end, PU = 10 units		6ES7590-5BA00-0AA0	
For shield plate at field end, 2 x 2 ... 6 mm		6ES7390-5AB00-0AA0	
For shield plate at field end, 3 ... 8 mm		6ES7390-5BA00-0AA0	
For shield plate at field end, 4 ... 13 mm		6ES7390-5CA00-0AA0	
Connection module TPRo Relay module for 8 outputs, relay as normally open contact <ul style="list-style-type: none"> • Push-in terminals with LEDs • Screw-type terminals with LEDs 	6ES7924-0BD20-0BC0 6ES7924-0BD20-0BA0		
Connection module TPRI Relay module for 8 outputs (110 V AC), relay as normally open contact <ul style="list-style-type: none"> • Push-in terminals with LEDs • Screw-type terminals with LEDs 	6ES7924-0BG20-0BC0 6ES7924-0BG20-0BA0		
Connection module TPRI Relay module for 8 outputs (230 V AC), relay as normally open contact <ul style="list-style-type: none"> • Push-in terminals with LEDs • Screw-type terminals with LEDs 	6ES7924-0BE20-0BC0 6ES7924-0BE20-0BA0		
Connection module TPOo Optocoupler module for 8 outputs (max. 24 V DC/4 A) <ul style="list-style-type: none"> • Push-in terminals with LEDs • Screw-type terminals with LEDs 	6ES7924-0BF20-0BC0 6ES7924-0BF20-0BA0		

SIMATIC S7-1500 Advanced Controllers

I/O modules

Connection system

System cabling for SIMATIC S7-1500 and ET 200MP > Front connectors with single wires

Overview



Can be used for SIMATIC S7-1500 and ET 200MP digital modules (24 V DC)

The front connectors with single wires replace the SIMATIC standard connectors

- 6ES7592-1AM00-0XB0

Technical specifications

Front connector with single wires for 16 channels (pins 1-20)	
Rated operating voltage	24 V DC
Permissible continuous current with simultaneous load of all wires, max.	1.5 A
Permissible ambient temperature	0 to 60 °C
Wire type	H05V-K, UL 1007/1569; CSA TR64, or halogen-free
Number of single wires	20
Wire cross-section	0.5 mm ² ; Cu
Bundle diameter in mm	approx. 15
Wire color	Blue, RAL 5010
Designation of wires	Numbered from 1 to 20 (front connector contact = wire number)
Assembly	Screw contacts
Front connector with single wires for 32 channels (pins 1-40)	
Rated operating voltage	24 V DC
Permissible continuous current with simultaneous load of all wires, max.	1.5 A
Permissible ambient temperature	0 to 60 °C
Wire type	H05V-K, UL 1007/1569; CSA TR64, or halogen-free
Number of single wires	40
Wire cross-section	0.5 mm ² ; Cu
Bundle diameter in mm	approx. 17
Wire color	Blue, RAL 5010
Designation of wires	Numbered from 1 to 40 (front connector contact = wire number)
Assembly	Screw contacts

Ordering data

Article No.

Front connector with single wires for 32 channels (pins 1-40)	
Wire type H05V-K (0.5 mm² with screw connection)	
• 2.5 m	6ES7922-5BC50-0AC0
• 3.2 m	6ES7922-5BD20-0AC0
• 5.0 m	6ES7922-5BF00-0AC0
• 6.5 m	6ES7922-5BG50-0AC0
• 8.0 m	6ES7922-5BJ00-0AC0
• 10.0 m	6ES7922-5CB00-0AC0
Wire type H05Z-K, halogen-free (0.5 mm² with screw connection)	
• 2.5 m	6ES7922-5BC50-0HC0
• 3.2 m	6ES7922-5BD20-0HC0
• 5.0 m	6ES7922-5BF00-0HC0
• 6.5 m	6ES7922-5BG50-0HC0
• 8.0 m	6ES7922-5BJ00-0HC0
• 10.0 m	6ES7922-5CB00-0HC0
Wire type UL/CSA-certified (0.5 mm² with screw connection)	
• 3.2 m	6ES7922-5BD20-0UC0
• 5.0 m	6ES7922-5BF00-0UC0
• 6.5 m	6ES7922-5BG50-0UC0
Front connector with single wires for 16 channels (pins 1-20)	
Wire type H05V-K (0.5 mm² with screw connection)	
• 2.5 m	6ES7922-5BC50-0AB0
• 3.2 m	6ES7922-5BD20-0AB0
• 5.0 m	6ES7922-5BF00-0AB0
• 6.5 m	6ES7922-5BG50-0AB0
• 8.0 m	6ES7922-5BJ00-0AB0
• 10.0 m	6ES7922-5CB00-0AB0
Wire type H05Z-K, halogen-free (0.5 mm² with screw connection)	
• 2.5 m	6ES7922-5BC50-0HB0
• 3.2 m	6ES7922-5BD20-0HB0
• 5.0 m	6ES7922-5BF00-0HB0
• 6.5 m	6ES7922-5BG50-0HB0
• 8.0 m	6ES7922-5BJ00-0HB0
• 10.0 m	6ES7922-5CB00-0HB0
Wire type UL/CSA-certified (0.5 mm² with screw connection)	
• 3.2 m	6ES7922-5BD20-0UB0
• 5.0 m	6ES7922-5BF00-0UB0
• 6.5 m	6ES7922-5BG50-0UB0

Overview



Fail-safe digital input module:

F-DI 16x24VDC PROFISAFE

Important properties:

- 16-channel fail-safe digital input module for ET 200MP/S7-1500
- For fail-safe reading of sensor information (1 or 2 channels)
- Provides integral discrepancy evaluation for 2-out-of-2 signals
- 4 internal sensor supplies (incl. test function) onboard
- Certified up to SIL 3 (IEC 61508), PL e (ISO 13849)
- LED display for error, operation, supply voltage and status
- Clear module labeling
 - Plain text identification of the module type
 - Complete Article No.
 - 2D matrix code (article and serial number)
 - Connection diagram
 - Hardware and firmware version
- Optional labeling accessories
 - Labeling sheets, yellow
- The modules support PROFIsafe in both PROFIBUS and PROFINET configurations. Can be used with all fail-safe SIMATIC S7-1500 F-CPU's in the central configuration, as well as ET 200MP distributed I/O with all other SIMATIC S7 F-CPU's.

Technical specifications

Article number	6ES7526-1BH00-0AB0 ET 200MP, F-DI 16X24VDC
General information	
Product type designation	F-DI 16x24VDC
Product function	
• I&M data	Yes; I&M0 to I&M3
Engineering with	
• STEP 7 TIA Portal configurable/ integrated as of version	V13 SP1 with HSP0086
Operating mode	
• DI	Yes
Supply voltage	
Type of supply voltage	24 V DC
Rated value (DC)	24 V
Reverse polarity protection	Yes
Encoder supply	
Number of outputs	4
Short-circuit protection	Yes; Electronic (response threshold 0.7 A to 1.8 A)
24 V encoder supply	
• 24 V	Yes; min. L+ (-1.5 V)
• Short-circuit protection	Yes
• Output current, max.	300 mA; Max. 100 mA when mounted vertically
Digital inputs	
Number of digital inputs	16
Source/sink input	Yes; P-reading
Input characteristic curve in accordance with IEC 61131, type 1	Yes
Input voltage	
• Type of input voltage	DC
• Rated value (DC)	24 V
• for signal "0"	-30 to +5V
• for signal "1"	+15 to +30V
Input current	
• for signal "1", typ.	3.7 mA
Input delay (for rated value of input voltage)	
for standard inputs	
- parameterizable	Yes
Cable length	
• shielded, max.	1 000 m
• unshielded, max.	500 m
Interrupts/diagnostics/ status information	
Diagnostics function	Yes
Alarms	
• Diagnostic alarm	Yes
• Hardware interrupt	No
Diagnostic messages	
• Monitoring the supply voltage	Yes
• Wire-break	No
• Short-circuit	Yes
• Group error	Yes
Diagnostics indication LED	
• RUN LED	Yes; Green LED
• ERROR LED	Yes; Red LED
• Channel status display	Yes; Green LED
• for channel diagnostics	Yes; Red LED
• for module diagnostics	Yes; Red LED

SIMATIC S7-1500 Advanced Controllers

I/O modules

F digital/analog modules

F digital input modules

Technical specifications (continued)

Article number	6ES7526-1BH00-0AB0 ET 200MP, F-DI 16X24VDC
Potential separation	
Potential separation channels	
• between the channels and backplane bus	Yes
Isolation	
Isolation tested with	707 V DC (type test)
Standards, approvals, certificates	
Suitable for safety functions	Yes
Highest safety class achievable in safety mode	
• Performance level according to ISO 13849-1	PLe
• SIL acc. to IEC 61508	SIL 3
Probability of failure (for service life of 20 years and repair time of 100 hours)	
- Low demand mode: PFDavg in accordance with SIL3	< 5.00E-05
- High demand/continuous mode: PFH in accordance with SIL3	< 1.00E-09 1/h
Ambient conditions	
Ambient temperature during operation	
• horizontal installation, min.	0 °C
• horizontal installation, max.	60 °C
• vertical installation, min.	0 °C
• vertical installation, max.	40 °C
Dimensions	
Width	35 mm
Height	147 mm
Depth	129 mm
Weights	
Weight, approx.	280 g

Ordering data

Article No.

F digital input module

16 inputs, 24 V DC, PROFISAFE

6ES7526-1BH00-0AB0

Accessories

Coding elements

E-coding element type F for ET 200 MP-module F-DI/F-DQ; 5 units, spare part

6ES7592-6EF00-1AA0

Front connectors

Incl. four potential bridges, cable ties and individual labeling strips, 40-pin

- Screw terminals
- Push-in

6ES7592-1AM00-0XB0
6ES7592-1BM00-0XB0

DIN A4 labeling sheets

For 35-mm F-modules; 10 sheets with 10 labeling strips each for I/O modules; perforated, yellow

6ES7592-2CX00-0AA0

U connector

5 units; spare part

6ES7590-0AA00-0AA0

Front door for F-I/O modules

5 front doors; with 5 labeling strips (front) and 5 cabling diagrams per front door; spare part

6ES7528-0AA10-7AA0

STEP 7 Safety Advanced V14 SP1

Task:

Engineering tool for configuring and programming fail-safe user programs for SIMATIC S7-1200 FC, S7-1500F, S7-1500F Software Controller, S7-300F, S7-400F, WinAC RTX F, ET 200SP F Controller and the fail-safe ET 200SP, ET 200S, ET 200M, ET 200iSP, ET 200pro and ET 200eco I/O

Requirement:

STEP 7 Professional V14 SP1

Floating license for 1 user, software and documentation on DVD; license key on USB flash drive

6ES7833-1FA14-0YA5Floating license for 1 user, software, documentation and license key for download¹⁾; email address required for delivery**6ES7833-1FA14-0YH5**

S7 Distributed Safety V5.4 programming tool

Task:

Engineering tool for configuring fail-safe user programs for SIMATIC S7-300F, S7-400F, WinAC RTX F, ET 200S, ET 200MP, ET 200M, ET 200iSP, ET 200pro, ET 200eco

Requirement:

STEP 7 V5.3 SP3 and higher

Floating license for 1 user

6ES7833-1FC02-0YA5Floating license for 1 user, license key download without software or documentation¹⁾; email address required for delivery**6ES7833-1FC02-0YH5**

¹⁾ For up-to-date information and download availability, see: <http://www.siemens.com/tia-online-software-delivery>

Overview



Digital fail-safe digital output module:
F-DQ 8x24VDC 2A PPM PROFISAFE

Important properties:

- 8-channel digital fail-safe output module for ET 200MP/S7-1500
- Fail-safe 2-channel activation (parameterizable PM/PP switching) of actuators
- Actuators can be controlled up to 2 A
- Certified up to SIL 3 (IEC 61508), PL e (ISO 13849)
- LED display for error, operation, supply voltage and status
- Clear module labeling
 - Plain text identification of the module type
 - Complete Article No.
 - 2D matrix code (article and serial number)
 - Connection diagram
 - Hardware and firmware version
- Optional labeling accessories
 - Labeling sheets, yellow
- The module supports PROFIsafe in both PROFIBUS and PROFINET configurations.
- Can be used with all fail-safe SIMATIC S7-1500 F-CPU's in the central configuration, as well as ET 200MP distributed I/O with all other SIMATIC S7 F-CPU's.

Technical specifications

Article number	6ES7526-2BF00-0AB0 ET 200MP, F-DQ 8x24VDC 2A PPM
General information	
Product type designation	F-DQ 8x24VDC/2A PPM
Product function	
• I&M data	Yes; I&M0 to I&M3
Engineering with	
• STEP 7 TIA Portal configurable/ integrated as of version	V13 SP1 with HSP0086
Operating mode	
• DQ	Yes
Supply voltage	
Type of supply voltage	24 V DC
Rated value (DC)	24 V
Reverse polarity protection	Yes
Digital outputs	
Number of digital outputs	8
Current-sinking	Yes
Current-sourcing	Yes
Short-circuit protection	Yes
Open-circuit detection	Yes
Overload protection	Yes
Limitation of inductive shutdown voltage to	PM-switching: -24 V + (-47 V), PP-switching: -24 V
Switching capacity of the outputs	
• with resistive load, max.	2 A
• on lamp load, max.	10 W
Load resistance range	
• lower limit	12 Ω
• upper limit	2 000 Ω
Output voltage	
• Type of output voltage	DC
• for signal "1", min.	24 V; L+ (-0.5 V)
Output current	
• for signal "1" rated value	2 A
• for signal "0" residual current, max.	0.5 mA; Current-sourcing, or current sourcing and sinking switches individually, current sinking: max. 1 mA
Switching frequency	
• with resistive load, max.	30 Hz
• with inductive load, max.	0.1 Hz
• on lamp load, max.	10 Hz
Total current of the outputs	
• Current per channel, max.	2 A
Total current of the outputs (per module)	
horizontal installation	
- up to 40 °C, max.	16 A
- up to 60 °C, max.	8 A
vertical installation	
- up to 40 °C, max.	8 A
Cable length	
• shielded, max.	1 000 m
• unshielded, max.	500 m

SIMATIC S7-1500 Advanced Controllers

I/O modules

F digital/analog modules

F digital output modules

Technical specifications (continued)

Article number	6ES7526-2BF00-0AB0 ET 200MP, F-DQ 8X24VDC 2A PPM
Interrupts/diagnostics/ status information	
Diagnostics function	Yes
Substitute values connectable	No
Alarms	
• Diagnostic alarm	Yes
Diagnostic messages	
• Monitoring the supply voltage	Yes
• Wire-break	Yes
• Short-circuit	Yes
• Group error	Yes
Diagnostics indication LED	
• RUN LED	Yes; Green LED
• ERROR LED	Yes; Red LED
• Monitoring of the supply voltage (PWR-LED)	Yes
• Channel status display	Yes; Green LED
• for channel diagnostics	Yes; Red LED
• for module diagnostics	Yes; Red LED
Potential separation	
Potential separation channels	
• between the channels and backplane bus	Yes
Isolation	
Isolation tested with	707 V DC (type test)
Standards, approvals, certificates	
Suitable for safety functions	Yes
Highest safety class achievable in safety mode	
• Performance level according to ISO 13849-1	PLe
• SIL acc. to IEC 61508	SIL 3
Probability of failure (for service life of 20 years and repair time of 100 hours)	
- Low demand mode: PFDavg in accordance with SIL3	< 6.00E-05
- High demand/continuous mode: PFH in accordance with SIL3	< 2.00E-09 1/h
Ambient conditions	
Ambient temperature during operation	
• horizontal installation, min.	0 °C
• horizontal installation, max.	60 °C
• vertical installation, min.	0 °C
• vertical installation, max.	40 °C
Dimensions	
Width	35 mm
Height	147 mm
Depth	129 mm
Weights	
Weight, approx.	300 g

Ordering data

Article No.

F digital output module

8 outputs, 24 V DC, 2 A, PROFISAFE, p/m-switching

6ES7526-2BF00-0AB0

Accessories

Coding elements

E-coding element type F for ET 200 MP-module F-DI/F-DQ; 5 units, spare part

6ES7592-6EF00-1AA0

Front connectors

Incl. four potential bridges, cable ties and individual labeling strips, 40-pin

- Screw terminals
- Push-in

6ES7592-1AM00-0XB0
6ES7592-1BM00-0XB0

DIN A4 labeling sheets

For 35-mm F-modules; 10 sheets with 10 labeling strips each for I/O modules; perforated, yellow

6ES7592-2CX00-0AA0

U connector

5 units; spare part

6ES7590-0AA00-0AA0

Front door for F-I/O modules

5 front doors; with 5 labeling strips (front) and 5 cabling diagrams per front door; spare part

6ES7528-0AA10-7AA0

STEP 7 Safety Advanced V14 SP1

Task:

Engineering tool for configuring and programming fail-safe user programs for SIMATIC S7-1200 FC, S7-1500F, S7-1500F Software Controller, S7-300F, S7-400F, WinAC RTX F, ET 200SP F Controller and the fail-safe ET 200SP, ET 200S, ET 200M, ET 200iSP, ET 200pro and ET 200eco I/O

Requirement:

STEP 7 Professional V14 SP1

Floating license for 1 user, software and documentation on DVD; license key on USB flash drive

6ES7833-1FA14-0YA5

Floating license for 1 user, software, documentation and license key for download¹⁾; email address required for delivery

6ES7833-1FA14-0YH5

S7 Distributed Safety V5.4 programming tool

Task:

Engineering tool for configuring fail-safe user programs for SIMATIC S7-300F, S7-400F, WinAC RTX F, ET 200S, ET 200MP, ET 200M, ET 200iSP, ET 200pro, ET 200eco

Requirement:

STEP 7 V5.3 SP3 and higher

Floating license for 1 user

6ES7833-1FC02-0YA5

Floating license for 1 user, license key download without software or documentation¹⁾; email address required for delivery

6ES7833-1FC02-0YH5

¹⁾ For up-to-date information and download availability, see: <http://www.siemens.com/tia-online-software-delivery>

SIMATIC S7-1500 Advanced Controllers

Power supplies

1-phase, 24 V DC (for S7-1500 and ET200MP)

Overview



The design and functionality of the SIMATIC PM 1507 single-phase load power supply (PM = power module) with automatic range selection of the input voltage makes it an optimal match to the SIMATIC S7-1500 PLC. It supplies the S7-1500 system components such as CPU, system power supply (PS), I/O circuits of the input and output modules and, if necessary, the sensors and actuators with 24 V DC.

4

Technical specifications

Article number	6EP1332-4BA00	6EP1333-4BA00
Product	S7-1500 PM1507	S7-1500 PM1507
Power supply, type	24 V/3 A	24 V/8 A
Input		
Input	1-phase AC	1-phase AC
Supply voltage		
• 1 at AC Rated value	120 V	120 V
• 2 at AC Rated value	230 V	230 V
• Note	Automatic range selection	Automatic range selection
Input voltage		
• 1 at AC	85 ... 132 V	85 ... 132 V
• 2 at AC	170 ... 264 V	170 ... 264 V
Wide-range input	No	No
Overvoltage resistance	$2.3 \times V_{in \text{ rated}}$, 1.3 ms	$2.3 \times V_{in \text{ rated}}$, 1.3 ms
Mains buffering at $I_{out \text{ rated}}$, min.	20 ms; at $V_{in} = 93/187 \text{ V}$	20 ms; at $V_{in} = 93/187 \text{ V}$
Rated line frequency 1	50 Hz	50 Hz
Rated line frequency 2	60 Hz	60 Hz
Rated line range	45 ... 65 Hz	45 ... 65 Hz
Input current		
• at rated input voltage 120 V	1.4 A	3.7 A
• at rated input voltage 230 V	0.8 A	1.7 A
Switch-on current limiting (+25 °C), max.	23 A	62 A
Duration of inrush current limiting at 25 °C		
• maximum	3 ms	3 ms
I^2t , max.	1.3 A ² ·s	12 A ² ·s
Built-in incoming fuse	T 3, 15 A/250 V (not accessible)	T 6.3 A/250 V (not accessible)
Protection in the mains power input (IEC 898)	Recommended miniature circuit breaker: 10 A characteristic B or 6 A characteristic C	Recommended miniature circuit breaker: 16 A characteristic B or 10 A characteristic C

SIMATIC S7-1500 Advanced Controllers

Power supplies

1-phase, 24 V DC (for S7-1500 and ET200MP)

Technical specifications (continued)

Article number	6EP1332-4BA00	6EP1333-4BA00
Product	S7-1500 PM1507	S7-1500 PM1507
Power supply, type	24 V/3 A	24 V/8 A
Output		
Output	Controlled, isolated DC voltage	Controlled, isolated DC voltage
Rated voltage V_{out} DC	24 V	24 V
Total tolerance, static \pm	1 %	1 %
Static mains compensation, approx.	0.1 %	0.1 %
Static load balancing, approx.	0.1 %	0.1 %
Residual ripple peak-peak, max.	50 mV	50 mV
Spikes peak-peak, max. (bandwidth: 20 MHz)	150 mV	150 mV
Product function	No	No
Output voltage adjustable		
Status display	LED green for 24 V OK; LED red for error; LED yellow for stand-by	LED green for 24 V OK; LED red for error; LED yellow for stand-by
On/off behavior	No overshoot of V_{out} (soft start)	No overshoot of V_{out} (soft start)
Startup delay, max.	1.5 s	1.5 s
Voltage rise, typ.	10 ms	10 ms
Rated current value I_{out} rated	3 A	8 A
Current range	0 ... 3 A	0 ... 8 A
Supplied active power typical	72 W	192 W
Short-term overload current		
• on short-circuiting during the start-up typical	12 A	35 A
• at short-circuit during operation typical	12 A	35 A
Duration of overloading capability for excess current		
• on short-circuiting during the start-up	70 ms	70 ms
• at short-circuit during operation	70 ms	70 ms
Parallel switching for enhanced performance	No	No
Efficiency		
Efficiency at V_{out} rated, I_{out} rated, approx.	87 %	90 %
Power loss at V_{out} rated, I_{out} rated, approx.	11 W	21 W
Closed-loop control		
Dynamic mains compensation (V_{in} rated ± 15 %), max.	0.1 %	0.1 %
Dynamic load smoothing (I_{out} : 50/100/50 %), $U_{out} \pm$ typ.	1 %	2 %
Dynamic load smoothing (I_{out} : 10/90/10 %), $U_{out} \pm$ typ.	3 %	3 %
Load step setting time 10 to 90%, typ.	5 ms	5 ms
Load step setting time 90 to 10%, typ.	5 ms	5 ms
Setting time maximum	5 ms	5 ms
Protection and monitoring		
Output overvoltage protection	Additional control loop, limitation (closed loop control) at < 28.8 V	Additional control loop, limitation (closed loop control) at < 28.8 V
Current limitation	3.15 ... 3.6 A	8.4 ... 9.6 A
Current limitation, typ.	3.4 A	9 A
Property of the output	Yes	Yes
Short-circuit proof		
Short-circuit protection	Electronic shutdown, automatic restart	Electronic shutdown, automatic restart
Overload/short-circuit indicator	-	-
Safety		
Primary/secondary isolation	Yes	Yes
Galvanic isolation	Safety extra-low output voltage U_{out} acc. to EN 60950-1 and EN 50178 and EN 61131-2	Safety extra-low output voltage U_{out} acc. to EN 60950-1 and EN 50178 and EN 61131-2
Protection class	Class I	Class I
Leakage current		
• maximum	3.5 mA	3.5 mA
• typical	0.4 mA	1.3 mA

SIMATIC S7-1500 Advanced Controllers

Power supplies

1-phase, 24 V DC (for S7-1500 and ET200MP)

Technical specifications (continued)

	6EP1332-4BA00	6EP1333-4BA00
Article number	6EP1332-4BA00	6EP1333-4BA00
Product	S7-1500 PM1507	S7-1500 PM1507
Power supply, type	24 V/3 A	24 V/8 A
CE mark	Yes	Yes
UL/cUL (CSA) approval	cULus-Listed (UL 508, CSA C22.2 No. 142), File E143289	cULus-Listed (UL 508, CSA C22.2 No. 142), File E143289
Explosion protection	IECEX Ex nA nC IIC T4 Gc; ATEX (EX) II 3G Ex nA nC IIC T4 Gc; cULus (ISA 12.12.01, CSA C22.2 No.213) Class I, Div. 2, Group ABCD, T4, File E330455	IECEX Ex nA nC IIC T3 Gc; ATEX (EX) II 3G Ex nA nC IIC T3 Gc; cULus (ISA 12.12.01, CSA C22.2 No.213) Class I, Div. 2, Group ABCD, T3, File E330455
FM approval	Class I, Div. 2, Group ABCD, T4	Class I, Div. 2, Group ABCD, T4
CB approval	Yes	Yes
Marine approval	GL, ABS, BV, DNV	GL, ABS, BV, DNV
Degree of protection (EN 60529)	IP20	IP20
EMC		
Emitted interference	EN 55022 Class B	EN 55022 Class B
Supply harmonics limitation	EN 61000-3-2	EN 61000-3-2
Noise immunity	EN 61000-6-2	EN 61000-6-2
Operating data		
Ambient temperature		
• during operation	0 ... 60 °C	0 ... 60 °C
- Note	with natural convection	with natural convection
• during transport	-40 ... +85 °C	-40 ... +85 °C
• during storage	-40 ... +85 °C	-40 ... +85 °C
Humidity class according to EN 60721	Climate class 3K3, no condensation	Climate class 3K3, no condensation
Mechanics		
Connection technology	Screw-/spring clamp connection	Screw-/spring clamp connection
Connections		
• Supply input	L, N, PE: 1 screw terminal each for 0.5 ... 2.5 mm ²	L, N, PE: 1 screw terminal each for 0.5 ... 2.5 mm ²
• Output	L+, M: 2 spring-loaded terminals each for 0.5 to 2.5 mm ²	L+, M: 2 spring-loaded terminals each for 0.5 to 2.5 mm ²
Product function		
• removable terminal at input	Yes	Yes
• removable terminal at output	Yes	Yes
Width of the enclosure	50 mm	75 mm
Height of the enclosure	147 mm	147 mm
Depth of the enclosure	129 mm	129 mm
Weight, approx.	0.45 kg	0.74 kg
Product feature of the enclosure housing for side-by-side mounting	Yes	Yes
Installation	Can be mounted onto S7-1500 rail	Can be mounted onto S7-1500 rail
MTBF at 40 °C	1 611 993 h	1 362 918 h
Other information	Specifications at rated input voltage and ambient temperature +25 °C (unless otherwise specified)	Specifications at rated input voltage and ambient temperature +25 °C (unless otherwise specified)

Ordering data**Article No.****Article No.****SIMATIC PM 1507**

Stabilized power supply
for SIMATIC S7-1500
Input: 120/230 V AC
Output: 24 V DC

- Output current 3 A
- Output current 8 A

6EP1332-4BA00**6EP1333-4BA00****Power connector**

With coding element for
power supply module; spare part,
10 units per packing unit

6ES7590-8AA00-0AA0

SIMATIC S7-1500 Advanced Controllers

Power supplies

System power supplies

Overview



- System power supplies for the SIMATIC S7-1500
- For conversion of AC or DC line voltages to the operating voltages required for the internal electronics
- 25 or 60 W output power
- Can be used for S7-1500 or ET 200MP
- Engineering and configuration via STEP 7 V12 and higher (PS 60W 24/48/60V DC HF: from STEP 7 V14 SP1)
- In addition with PS 60W 24/48/60V DC HF: Retentive storage of CPU work memory (data) for all S7-1500 CPUs

4

Technical specifications

Article number	6ES7505-0KA00-0AB0 S7-1500, PS 25W 24V DC	6ES7505-0RA00-0AB0 S7-1500, PS 60W 24/48/60V DC	6ES7505-0RB00-0AB0 S7-1500, PS 60W 24/48/60V DC HF	6ES7507-0RA00-0AB0 S7-1500, PS 60W 120/230V AC/DC
General information				
Product type designation	PS 25W 24VDC	PS 60W 24/48/60V DC	PS 60W 24/48/60V DC HF	PS 60W 120/230V AC/DC
HW functional status	E01	E01	E01	E01
Firmware version	V1.0.0	V1.0.0	V1.0.0	V1.0.0
Engineering with				
• STEP 7 TIA Portal configurable/ integrated as of version	V12 / V12	V12 / V12	V14 SP1	V12 / V12
• STEP 7 configurable/integrated as of version	V5.5 SP3 or higher	V5.5 SP3 or higher		V5.5 SP3 or higher
Supply voltage				
Rated value (DC)	24 V	24 V / 48 V / 60 V	24 V / 48 V / 60 V	120 V / 230 V
permissible range, lower limit (DC)	Static 19.2 V, dynamic 18.5 V	Static 19.2 V, dynamic 18.5 V	Static 19.2 V, dynamic 18.5 V	88 V
permissible range, upper limit (DC)	Static 28.8 V, dynamic 30.2 V	Static 72 V, dynamic 75.5 V	Static 72 V, dynamic 75.5 V	300 V
Rated value (AC)				120 V / 230 V
permissible range, lower limit (AC)				85 V
permissible range, upper limit (AC)				264 V
Reverse polarity protection	Yes	Yes	Yes	
Short-circuit protection	Yes	Yes	Yes	Yes
Line frequency				
• Rated value 50 Hz				Yes
• permissible range, lower limit				47 Hz
• permissible range, upper limit				63 Hz
Mains buffering				
• Mains/voltage failure stored energy time	20 ms	20 ms	20 ms	20 ms
Input current				
Rated value at 24 V DC	1.3 A	3 A	3 A	
Rated value at 48 V DC		1.5 A	1.5 A	
Rated value at 60 V DC		1.2 A	1.2 A	
Rated value at 120 V DC				0.6 A
Rated value at 230 V DC				0.3 A
Rated value at 120 V AC				0.6 A
Rated value at 230 V AC				0.34 A
Output current				
Short-circuit protection	Yes	Yes	Yes	Yes

Technical specifications (continued)

Article number	6ES7505-0KA00-0AB0 S7-1500, PS 25W 24V DC	6ES7505-0RA00-0AB0 S7-1500, PS 60W 24/48/60V DC	6ES7505-0RB00-0AB0 S7-1500, PS 60W 24/48/60V DC HF	6ES7507-0RA00-0AB0 S7-1500, PS 60W 120/230V AC/DC
Power				
Infeed power to the backplane bus	25 W	60 W	60 W	60 W
Power loss				
Power loss at nominal rating conditions	6.2 W	12 W	12 W	12 W
Interrupts/diagnostics/ status information				
Status indicator	Yes	Yes	Yes	Yes
Potential separation				
primary/secondary	Yes	Yes; Electrical isolation for 230 V AC (reinforced isolation)		Yes
Isolation				
Isolation tested with	707 V DC (type test)	2 500 V DC/2 s (routine test)	2 500 V DC/2 s (routine test)	2 500 V DC/2 s (routine test)
EMC				
Interference immunity against voltage surge				
<ul style="list-style-type: none"> on the supply lines acc. to IEC 61000-4-5 	Yes; +/- 1 kV (acc. to IEC 61000-4-5; 1995; surge symm.), +/- 2 kV (acc. to IEC 61000-4-5; 1995; surge asymm.), no external protective circuit required	Yes; +/- 1 kV (acc. to IEC 61000-4-5; 1995; surge symm.), +/- 2 kV (acc. to IEC 61000-4-5; 1995; surge asymm.), no external protective circuit required	Yes; +/- 1 kV (acc. to IEC 61000-4-5; 1995; surge symm.), +/- 2 kV (acc. to IEC 61000-4-5; 1995; surge asymm.), no external protective circuit required	Yes; +/- 1 kV (acc. to IEC 61000-4-5; 1995; surge symm.), +/- 2 kV (acc. to IEC 61000-4-5; 1995; surge asymm.), no external protective circuit required
Degree and class of protection				
Degree of protection acc. to EN 60529	IP20	IP20	IP20	IP20
Protection class	3; with protective conductor	1; with protective conductor	1; with protective conductor	1; with protective conductor
Dimensions				
Width	35 mm	70 mm	105 mm	70 mm
Height	147 mm	147 mm	147 mm	147 mm
Depth	129 mm	129 mm	129 mm	129 mm
Weights				
Weight, approx.	350 g	600 g	865 g	600 g

Ordering data

Ordering data	Article No.	Article No.
Power supply		
For supplying the backplane bus of the S7-1500		
24 V DC input voltage, power 25 W	6ES7505-0KA00-0AB0	
24/48/60 V DC input voltage, power 60 W	6ES7505-0RA00-0AB0	
24/48/60 V DC input voltage, power 60 W, buffering functionality	6ES7505-0RB00-0AB0	
120/230 V AC input voltage, power 60 W	6ES7507-0RA00-0AB0	
Accessories		
SIMATIC S7-1500 mounting rail		
Fixed lengths, with grounding elements		
<ul style="list-style-type: none"> 160 mm 245 mm 482 mm 530 mm 830 mm 		6ES7590-1AB60-0AA0 6ES7590-1AC40-0AA0 6ES7590-1AE80-0AA0 6ES7590-1AF30-0AA0 6ES7590-1AJ30-0AA0
For cutting to length by customer, without drill holes; grounding elements must be ordered separately		
<ul style="list-style-type: none"> 2000 mm 		6ES7590-1BC00-0AA0
PE connection element for mounting rail 2000 mm		6ES7590-5AA00-0AA0
Spare part, 20 units		
Power connector		6ES7590-8AA00-0AA0
With coding element for power supply module; spare part, 10 units		

SIMATIC S7-1500 Advanced Controllers

SIPLUS power supplies

1-phase, 24 V DC (for S7-1500 and ET200MP)

Overview



The design and functionality of the SIMATIC PM 1507 single-phase load power supply (PM = power module) with automatic range selection of the input voltage makes it an optimal match to the SIMATIC S7-1500 PLC. It supplies the S7-1500 system components such as CPU, system power supply (PS), I/O circuits of the input and output modules and, if necessary, the sensors and actuators with 24 V DC.

Note

SIPLUS extreme products are based on Siemens standard products. The contents listed here were taken from the respective standard products. SIPLUS extreme specific information was added.

Article No.	6AG1332-4BA00-7AA0	6AG1333-4BA00-7AA0
Article number based on	6EP1332-4BA00	6EP1333-4BA00
Ambient temperature range	-40 ... +70 °C	
Conformal coating	Coating of the printed circuit boards and the electronic components	
Technical specifications	The technical specifications of the standard product apply, except for the ambient conditions.	
Ambient conditions		
Extended range of environmental conditions		
• with reference to ambient temperature, air pressure and altitude	Tmin ... Tmax at 1080 hPa ... 795 hPa (-1000 m ... +2000 m) // Tmin ... (Tmax - 10K) at 795 hPa ... 658 hPa (+2000 m ... +3500 m) // Tmin ... (Tmax - 20K) at 658 hPa ... 540 hPa (+3500 m ... +5000 m)	
Relative humidity		
• with condensation, max.	100 %; RH incl. bedewing/frost (no commissioning in bedewed state)	
Resistance		
• to biologically active substances/ compliance with EN 60721-3-3	Yes; Class 3B2 mold and fungal spores (except fauna); the supplied plug covers must remain in place on the unused interfaces during operation.	
• to chemically active substances/ compliance with EN 60721-3-3	Yes; Class 3C4 (RH < 75%) incl. salt spray in accordance with EN 60068-2-52 (severity 3); the supplied plug covers must remain in place on the unused interfaces during operation.	
• to mechanically active substances, compliance with EN 60721-3-3	Yes; Class 3S4 incl. sand, dust; the supplied plug covers must remain in place on unused interfaces during operation.	

Ordering data

SIPLUS S7-1500 PM 1507

(Extended temperature range and exposure to media)

Input 120/230 V AC, output 24 V DC, 3 A

Input 120/230 V AC, output 24 V DC, 8 A

Article No.

6AG1332-4BA00-7AA0

6AG1333-4BA00-7AA0

Article No.

Accessories

See SIMATIC PM 1507, 1-phase, 24 V DC (for S7-1500 and ET200MP), page 4/153

Overview



- System power supplies for the SIMATIC S7-1500
- For conversion of AC or DC line voltages to the operating voltages required for the internal electronics
- 25 or 60 W output power
- Can be used for S7-1500 or ET 200MP
- Configuration via STEP 7 V12

Note:

SIPLUS extreme products are based on SIMATIC standard products. The contents listed here were taken from the respective standard products. SIPLUS extreme-specific information was added.

Technical specifications

Article number	6AG1505-0KA00-7AB0 6ES7505-0KA00-0AB0	6AG1505-0RA00-7AB0 6ES7505-0RA00-0AB0	6AG1507-0RA00-7AB0 6ES7507-0RA00-0AB0
Based on	SIPLUS S7-1500 PS 25W 24V DC	SIPLUS S7-1500 PS 60W 24/48/60V DC	SIPLUS S7-1500 PS 60W 120/230V AC/DC
Ambient conditions			
Ambient temperature during operation			
• min.	-40 °C; = Tmin; Startup @ -25 °C	-40 °C; = Tmin; Startup @ -25 °C	-40 °C; = Tmin; Startup @ -25 °C
• max.	70 °C; = Tmax; for vertical mounting position Tmax = +40 °C	70 °C; = Tmax; > +60 °C max. power input 30 W; for vertical mounting position Tmax = +40 °C	70 °C; = Tmax; for vertical mounting position Tmax = +40 °C
Ambient temperature during storage/transportation			
• min.		-40 °C	
• max.		70 °C	
Extended ambient conditions			
• relative to ambient temperature-atmospheric pressure-installation altitude	Tmin ... Tmax at 1080 hPa ... 795 hPa (-1000 m ... +2000 m) // Tmin ... (Tmax - 10K) at 795 hPa ... 658 hPa (+2000 m ... +3500 m) // Tmin ... (Tmax - 20K) at 658 hPa ... 540 hPa (+3500 m ... +5000 m)	Tmin ... Tmax at 1080 hPa ... 795 hPa (-1000 m ... +2000 m) // Tmin ... (Tmax - 10K) at 795 hPa ... 658 hPa (+2000 m ... +3500 m) // Tmin ... (Tmax - 20K) at 658 hPa ... 540 hPa (+3500 m ... +5000 m)	Tmin ... Tmax at 1080 hPa ... 795 hPa (-1000 m ... +2000 m)
Relative humidity			
- With condensation, tested in accordance with IEC 60068-2-38, max.	100 %; RH incl. condensation/frost (no commissioning under condensation conditions)	100 %; RH incl. condensation/frost (no commissioning under condensation conditions)	100 %; RH incl. condensation/frost (no commissioning under condensation conditions)
Resistance			
- against biologically active substances / conformity with EN 60721-3-3	Yes; Class 3B2 mold, fungus and dry rot spores (with the exception of fauna). The supplied connector covers must remain on the unused interfaces during operation!	Yes; Class 3B2 mold, fungus and dry rot spores (with the exception of fauna). The supplied connector covers must remain on the unused interfaces during operation!	Yes; Class 3B2 mold, fungus and dry rot spores (with the exception of fauna). The supplied connector covers must remain on the unused interfaces during operation!
- against chemically active substances / conformity with EN 60721-3-3	Yes; Class 3C4 (RH < 75%) incl. salt spray according to EN 60068-2-52 (degree of severity 3). The supplied connector covers must remain on the unused interfaces during operation!	Yes; Class 3C4 (RH < 75%) incl. salt spray according to EN 60068-2-52 (degree of severity 3). The supplied connector covers must remain on the unused interfaces during operation!	Yes; Class 3C4 (RH < 75%) incl. salt spray according to EN 60068-2-52 (degree of severity 3). The supplied connector covers must remain on the unused interfaces during operation!
- against mechanically active substances / conformity with EN 60721-3-3	Yes; Class 3S4 incl. sand, dust. The supplied connector covers must remain on the unused interfaces during operation!	Yes; Class 3S4 incl. sand, dust. The supplied connector covers must remain on the unused interfaces during operation!	Yes; Class 3S4 incl. sand, dust. The supplied connector covers must remain on the unused interfaces during operation!

SIMATIC S7-1500 Advanced Controllers

SIPLUS power supplies

SIPLUS system power supplies

Ordering data**Article No.****SIPLUS S7-1500
system power supply**

(Extended temperature range
and exposure to media)

For supplying the backplane bus
of the S7-1500

24 V DC input voltage,
power 25 W

6AG1505-0KA00-7AB0

24/48/60 V DC input voltage,
power 60 W

6AG1505-0RA00-7AB0

120/230 V AC input voltage,
power 60 W

6AG1507-0RA00-7AB0**Accessories****Article No.**

See SIMATIC S7-1500,
system power supplies,
page 4/155

Overview



Basic Panels 2nd Generation

SIMATIC HMI Basic Panels (2nd Generation) with their fully developed HMI basic functions are the ideal entry level series for simple HMI applications.

The device family offers panels with 4", 7", 9" and 12" widescreen displays, as well as combined key and touch operation.

The innovative high-resolution widescreen displays with 64 000 colors are also suitable for upright installation, and they can be dimmed down to 100%. The innovative operator interface with improved usability opens up a diverse range of options thanks to new controls and graphics. The new USB interface enables the connection of keyboard, mouse or barcode scanner, and supports the simple archiving of data on a USB flash drive as well as the manual backup and restoring of the complete panel.

The integrated Ethernet or RS 485/422 interface (version-specific) enables simple connection to the controller.

For more information, see chapter 3, page 3/170.

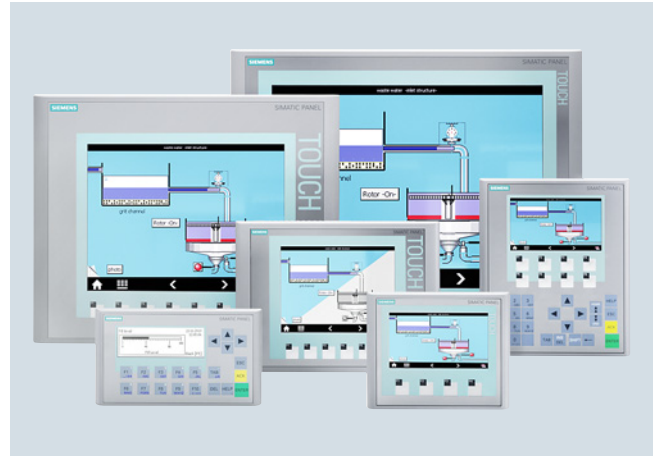

Basic Panels 1st Generation

- Ideal entry-level series from 3" to 15" for operating and monitoring compact machines and systems
- Clear process representation thanks to use of pixel-graphics displays
- Intuitive operation using touch and tactile function keys
- Equipped with all the necessary basic functions such as alarm logging, recipe management, plots, vector graphics, and language switching
- Simple connection to the controller via integral Ethernet interface or separate version with RS 485/422
- Faster commissioning thanks to integrated diagnostics viewer and IP setting for SIMATIC S7-1200 and S7-1500 PLCs

For more information, see chapter 3, page 3/171.

SIMATIC S7-1500 Advanced Controllers

Operator control and monitoring

SIPLUS Basic Panels and Comfort Panels

Overview (continued)



SIMATIC HMI Comfort Panels - Standard devices

- Excellent HMI functionality for demanding applications
- Widescreen TFT displays with 4", 7", 9", 12", 15", 19" and 22" diagonals (all 16 million colors) with up to 40% more visualization area as compared to the predecessor devices
- Integrated high-end functionality with archives, scripts, PDF/Word/Excel viewer, Internet Explorer, Media Player and web Server
- Dimmable displays from 0 to 100% via PROFIenergy, via the HMI project or via a controller

- Modern industrial design, cast aluminum fronts for 7" upwards
- Upright installation for all touch devices
- Optimal selection option: seven touch and five key versions are available
- Data security in the event of a power failure for the device and for the SIMATIC HMI Memory Card
- Innovative service and commissioning concept through second SD card (automatic backup)
- Maximum performance with short screen refresh times
- Suitable for extremely harsh industrial environments thanks to extended approvals such as ATEX 2/22 and marine approvals
- Wide range of communication options: PROFIBUS and PROFINET onboard; 2 x PROFINET with integrated switch for 7" models or larger; plus 1 x PROFINET with Gigabit support for 15" models or larger
- All versions can be used as an OPC UA client or as an OPC DA server
- Key-operated devices with LED in every function key and new text input mechanism, similar to the keypads of mobile phones
- All keys have a service life of 2 million operations
- Configuring with the WinCC engineering software of the TIA Portal

Note:

A 7" and 15" Comfort Outdoor version will be available soon. For more information, please go to:

<http://www.siemens.com/hmi>

For more Information, see chapter 3, page 3/172.

SIPLUS Basic Panels and Comfort Panels

Overview

SIPLUS extreme products are based on SIMATIC standard products.

For SIPLUS technical documentation, see:
<http://www.siemens.com/siplus-extreme>

For more information, see chapter 3, page 3/174.

Overview



- Aluminum mounting rail for mounting the SIMATIC S7-1500 or ET 200MP
- With integrated DIN rail for snapping on a wide range of standard components
- Attachment of modules with a single screw
- Installation by screwing to the control cabinet wall.
- Entire length of rail can be used

Ordering data

Article No.

SIMATIC S7-1500 DIN rail

Fixed lengths, with grounding elements

- 160 mm
- 245 mm
- 482 mm
- 530 mm
- 830 mm

6ES7590-1AB60-0AA0
6ES7590-1AC40-0AA0
6ES7590-1AE80-0AA0
6ES7590-1AF30-0AA0
6ES7590-1AJ30-0AA0

For cutting to length by customer, without drill holes; grounding elements must be ordered separately

6ES7590-1BC00-0AA0

PE connection element for DIN rail 2000 mm

20 units

6ES7590-5AA00-0AA0

SIMATIC Manual Collection

6ES7998-8XC01-8YE0

Electronic manuals on DVD, multi-language:
 LOGO!, SIMADYN, SIMATIC bus components, SIMATIC C7, SIMATIC distributed I/O, SIMATIC HMI, SIMATIC Sensors, SIMATIC NET, SIMATIC PC Based Automation, SIMATIC PCS 7, SIMATIC PG/PC, SIMATIC S7, SIMATIC Software, SIMATIC TDC

SIMATIC Manual Collection update service for 1 year

6ES7998-8XC01-8YE2

Current "Manual Collection" DVD and the three subsequent updates

SIMATIC S7-1500 Advanced Controllers

Accessories

Labeling sheets

Overview

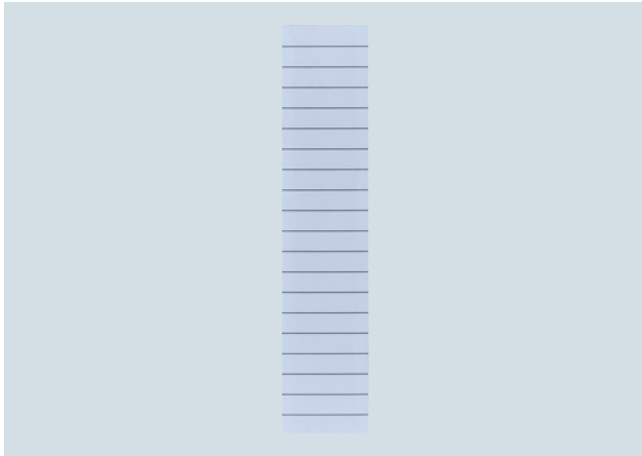

- Film sheets for the application-specific, automatic labeling of I/O modules of the SIMATIC S7-1500 using standard laser printers
- Printing direct from the TIA Portal possible
 - No double entry of symbols and/or addresses
 - Saves time and avoids typing errors
- Plain color films, tear-resistant, dirt-repellent
- Simple handling:
 - Perforated labeling sheets in DIN A4 format for easy separation of the labeling strips.
 - Detached strips can be inserted directly into the I/O modules.
- Different colors to differentiate module types; yellow reserved for fail-safe systems

Ordering data

Article No.

DIN A4 labeling sheet

For 35 mm module;
10 sheets with 10 labeling strips
each for I/O modules; perforated,
Al gray

6ES7592-2AX00-0AA0

For 25 mm modules;
10 sheets with 20 labeling strips
each for I/O modules; perforated,
Al gray

6ES7592-1AX00-0AA0

SIMATIC Manual Collection

Electronic manuals on DVD,
multi-language:
LOGO!, SIMADYN, SIMATIC bus
components, SIMATIC C7,
SIMATIC distributed I/O,
SIMATIC HMI, SIMATIC Sensors,
SIMATIC NET, SIMATIC PC Based
Automation, SIMATIC PCS 7,
SIMATIC PG/PC, SIMATIC S7,
SIMATIC Software, SIMATIC TDC

6ES7998-8XC01-8YE0

SIMATIC Manual Collection update service for 1 year

Current "Manual Collection" DVD
and the three subsequent updates

6ES7998-8XC01-8YE2

Overview
Front doors

- Versions:
 - Universal front doors for digital and analog I/O modules
 - Universal front doors for the interface module IM155-5 PN ST
- Included in the scope of delivery of the respective modules. Can be ordered as a spare part in a set consisting of five universal (unlabeled) front doors.
- Front doors for I/O modules: Universal labeling sheets and cabling diagrams are included. Cabling diagrams can be detached from preperforated sheets and inserted inside the door.

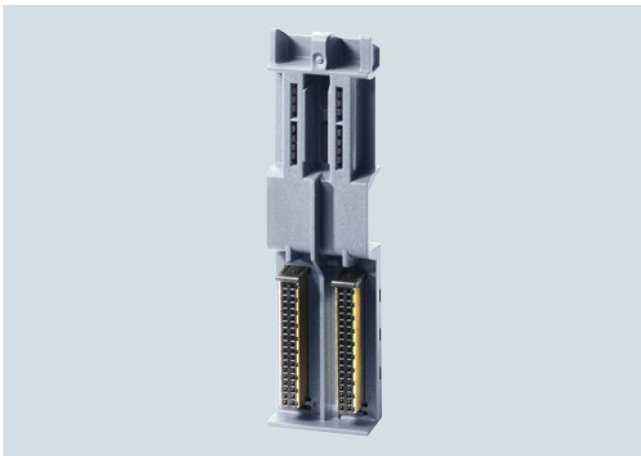
U connector

- To interconnect the modules (self-assembling backplane bus)
- Implementation of a rugged, interference-free station setup through
 - Consistent separation of supply voltage of modules and data signals
 - Fully shielded, gold-plated contacts for the data bus
- Included in the scope of delivery of each module. Available as spare part in sets of 5.

Shielding

- Components for implementing the integrated shielding concept of the S7-1500:
 - 24 V DC infeed element for supplying the analog module: strict separation of infeed and analog signals ensures high EMC stability.
 - Shield bracket for insertion in the front connector: allows a low-impedance connection and optimally dissipates interference.
 - Universal shield terminal: connects the cable shield with the shield bracket and is simultaneously used for mechanical fixing.
- Included in the scope of delivery of the analog modules. Available as a spare part in two versions:
 - Shielding set, comprising infeed element, shield bracket, and shield terminal (pack of 5 units each)
 - Individual shield terminals (pack of 20)
- No tool required for assembly/disassembly

SIMATIC S7-1500 Advanced Controllers

Accessories

Spare parts

Ordering data	Article No.		Article No.
Universal front door for IM 155-5 PN ST 5 front doors; spare part	6ES7528-0AA70-7AA0		
Universal front door for I/O modules 5 front doors; with 5 labeling strips (front) and 5 cabling diagrams per front door; spare part <ul style="list-style-type: none"> For 35 mm modules For 25 mm modules 	6ES7528-0AA00-7AA0 6ES7528-0AA00-0AA0		
U connector 5 units; spare part	6ES7590-0AA00-0AA0		
Shielding set I/O Infeed element, shield bracket, and shield terminal; 5 units; spare part <ul style="list-style-type: none"> For 35 mm modules For 25 mm modules 	6ES7590-5CA00-0AA0 6ES7590-5CA10-0XA0		
Shield terminal element 10 units; spare part	6ES7590-5BA00-0AA0		
		SIMATIC Manual Collection Electronic manuals on DVD, multi-language: LOGO!, SIMADYN, SIMATIC bus components, SIMATIC C7, SIMATIC distributed I/O, SIMATIC HMI, SIMATIC Sensors, SIMATIC NET, SIMATIC PC Based Automation, SIMATIC PCS 7, SIMATIC PG/PC, SIMATIC S7, SIMATIC Software, SIMATIC TDC	6ES7998-8XC01-8YE0
		SIMATIC Manual Collection update service for 1 year Current "Manual Collection" DVD and the three subsequent updates	6ES7998-8XC01-8YE2

SIMATIC S7-300 Advanced Controllers



5/3	Introduction	5/129	<u>Ex analog modules</u>
5/3	S7-300/S7-300F, SIPLUS S7-300	5/129	Ex analog input modules
5/5	Central processing units	5/132	Ex analog output modules
5/5	Standard CPUs	5/134	<u>SIPLUS S7-300 Ex analog modules</u>
5/16	SIPLUS S7-300 standard CPUs	5/134	SIPLUS S7-300 Ex analog input modules
5/22	Compact CPUs	5/136	<u>Function modules</u>
5/32	SIPLUS S7-300 compact CPUs	5/136	FM 350-1 counter module
5/39	Fail-safe CPUs	5/139	FM 350-2 counter module
5/46	SIPLUS S7-300 fail-safe CPUs	5/141	FM 351 positioning module
5/52	Technology CPUs	5/144	FM 352 cam controller
5/58	I/O modules	5/146	FM 352-5 high-speed Boolean processor
5/58	<u>Digital modules</u>	5/151	FM 353 positioning module
5/58	SM 321 digital input modules	5/153	FM 355 controller module
5/64	SM 322 digital output modules	5/158	FM 355-2 temperature controller module
5/71	SM 323/SM 327 digital input/output modules	5/163	SM 338 POS input module
5/75	<u>SIPLUS S7-300 digital modules</u>	5/165	IM 174 PROFIBUS module
5/75	SIPLUS S7-300 SM 321	5/168	SIWAREX U
5/79	SIPLUS S7-300 SM 322	5/171	SIWAREX FTA
5/83	SIPLUS S7-300 SM 323	5/174	SIWAREX FTC
5/85	<u>Analog modules</u>	5/177	SIFLOW FC070
5/85	SM 331 analog input modules	5/180	<u>SIPLUS S7-300 function modules</u>
5/93	SM 332 analog output modules	5/180	SIPLUS S7-300 FM 350-1
5/96	SM 334 analog input/output modules	5/182	SIPLUS S7-300 FM 350-2
5/100	<u>SIPLUS S7-300 analog modules</u>	5/184	SIPLUS SIWAREX U
5/100	SIPLUS S7-300 SM 331	5/186	SIPLUS DCF 77 radio clock module
5/103	SIPLUS S7-300 SM 332	5/187	<u>Communication</u>
5/105	SIPLUS S7-300 SM 334	5/187	CP 340
5/107	<u>F digital/analog modules</u>	5/189	CP 341
5/107	SM 326 F digital input modules - Safety Integrated	5/191	Loadable drivers for CP 441-2 and CP 341
5/110	SM 326 F digital output modules - Safety Integrated	5/193	CP 343-2P / CP 343-2
5/113	SM 336 F analog input modules - Safety Integrated	5/195	CP 342-5
5/115	Isolation module	5/197	CP 342-5 FO
5/116	SIPLUS S7-300	5/299	CP 343-5
5/116	<u>F digital/analog modules</u>	5/201	CP 343-1 Lean
5/116	SIPLUS S7-300 SM 326 - Safety Integrated	5/204	CP 343-1
5/118	SIPLUS S7-300 SM 326 - Safety Integrated	5/207	CP 343-1 Advanced
5/120	SIPLUS S7-300 SM 336 - Safety Integrated	5/211	CP 343-1 ERPC
5/122	SIPLUS S7-300 isolation module	5/214	CSM 377 unmanaged
5/123	<u>Ex digital modules</u>	5/216	TIM 3V-IE Advanced (for S7-300)
5/123	Ex digital input modules	5/219	TIM 3V-IE (for S7-300)
5/125	Ex digital output modules	5/222	TIM 4R-IE (for S7-300/-400/PC)
5/127	<u>SIPLUS S7-300 Ex digital modules</u>	5/226	TIM 3V-IE DNP3 (for S7-300)
5/127	SIPLUS S7-300 Ex digital input modules	5/227	TIM 4R-IE DNP3 (for S7-300/-400)
		5/229	ASM 475

Brochures

For brochures serving as selection guides for SIMATIC products, refer to:

www.siemens.com/simatic/printmaterial

SIMATIC S7-300 Advanced Controllers



I/O modules (continued)

- 5/231 SIPLUS S7-300 communication
- 5/231 SIPLUS S7-300 CP 340
- 5/233 SIPLUS S7-300 CP 341
- 5/235 SIPLUS S7-300 CP 343-1 Lean
- 5/237 SIPLUS S7-300 CP 343-1
- 5/239 SIPLUS S7-300 CP 343-1 Advanced
- 5/241 SIPLUS TIM 3V-IE for WAN and Ethernet
- 5/242 SIPLUS TIM 4R-IE for WAN and Ethernet
- 5/243 Special modules
- 5/243 SM 374 simulator
- 5/244 DM 370 dummy module
- 5/245 SIPLUS S7-300 special modules
- 5/245 SIPLUS S7-300 DM 370
- 5/247 Connection system
- 5/247 Front connectors
- 5/249 Fully modular connection
- 5/253 Flexible connection
- 5/254 Front connectors for S7-300
with crimp connections

5/255 Power supplies
5/255 1-phase, 24 V DC
(for S7-300 and ET200M)

5/259 SIPLUS power supplies
5/259 1-phase, 24 V DC
(for S7-300 and ET200M)

5/261 Interface modules
5/261 IM 360/361/365 interface modules

5/262 SIPLUS interface modules
5/262 SIPLUS S7-300 IM 365

5/263 Accessories
5/263 DIN rail
5/264 Labeling sheets

Overview



S7-300

- The modular mini PLC system for the low and mid-performance ranges
- With comprehensive range of modules for optimum adaptation to the automation task
- Flexible use through simple implementation of distributed structures and versatile networking
- User-friendly handling and uncomplicated design without a fan
- Can be expanded without problems when the tasks increase
- Powerful thanks to a range of integrated functions

S7-300F

- Fail-safe automation system for plants with increased safety requirements for production technology
- Based on S7-300
- Additional ET 200S and ET 200M distributed I/O stations complete with safety-related modules can be connected
- Safety-related communication via PROFIBUS DP with PROFIsafe profile
- Standard modules can be used in addition for non-safety-relevant applications

Technical specifications

General technical data SIMATIC S7-300	
Degree of protection	IP20 according to IEC 60 529
Ambient temperature	<ul style="list-style-type: none"> • For horizontal installation 0 to 60 °C • For vertical installation 0 to 40 °C
Relative humidity	10 to 95%, non-condensing, corresponds to relative humidity (RH), stress level 2 acc. to IEC 61131, Part 2
Air pressure	From 1080 to 795 hPa (corresponds to an altitude of -1000 to +2000 m)
Insulation	<ul style="list-style-type: none"> • < 50 V 500 V DC test voltage • < 150 V 2500 V DC test voltage • < 250 V 4000 V DC test voltage
Electromagnetic compatibility	<p>Requirements of the EMC directive; interference immunity according to IEC 61000-6-2</p> <ul style="list-style-type: none"> • Pulse-shaped disturbance variables Test according to: Electrostatic discharge according to IEC 61000-4-2, burst pulses according to IEC 61000-4-4, energy single pulse (surge) according to IEC 61000-4-5, • Sinusoidal disturbance variables Test according to: HF irradiation according to IEC 61000-4-3, HF decoupling according to IEC 61000-4-6 • Emission of radio interference Interference emission according to EN 50081-2 <p>Test according to: Emitted interference of electromagnetic fields according to EN 55016: Limit value class A, (measured at a distance of 10 m) Interference emission via AC mains according to EN 55011: Limit value class A, Group 1</p>
Mechanical strength	<ul style="list-style-type: none"> • Vibrations Frequency range $10 \text{ Hz} \leq f \leq 58 \text{ Hz}$ <ul style="list-style-type: none"> • Continuous: 0.0375 mm amplitude • Occasionally 0.75 mm amplitude <p>Frequency range $58 \text{ Hz} \leq f \leq 150 \text{ Hz}$</p> <ul style="list-style-type: none"> • Continuous: 0.5 g constant acceleration • Occasionally 1 g constant acceleration <p>Testing according to IEC 60068-2-6 Tested with: $5 \text{ Hz} \leq f \leq 9 \text{ Hz}$, constant amplitude 3.5 mm; $9 \text{ Hz} \leq f \leq 150 \text{ Hz}$, constant acceleration 1 g; Duration of oscillation: 10 frequency passes per axis in each direction of the 3 mutually perpendicular axes</p> <ul style="list-style-type: none"> • Shock Testing according to IEC 60068-2-27 Tested with: Half-sine wave: strength of shock 15 g peak value, 11 ms duration; Shock direction: 3 shocks each in \pm direction in each of the 3 mutually vertical axes

SIMATIC S7-300 Advanced Controllers

Introduction

S7-300/S7-300F, SIPLUS S7-300

Technical specifications (continued)

General technical data of SIPLUS S7-300	
Ambient temperature range	-40/-25 ... +60/70 °C
Conformal coating	Coating of the printed circuit boards and the electronic components
Technical data	The technical data of the standard product applies except for the environmental conditions.
Ambient conditions	
Extended range of environmental conditions	
<ul style="list-style-type: none"> with reference to ambient temperature, air pressure and altitude 	Tmin ... Tmax at 1080 hPa ... 795 hPa (-1000 m ... +2000 m) // Tmin ... (Tmax - 10K) at 795 hPa ... 658 hPa (+2000 m ... +3500 m) // Tmin ... (Tmax - 20K) at 658 hPa ... 540 hPa (+3500 m ... +5000 m)
<ul style="list-style-type: none"> At cold restart, min. 	0° C
Relative humidity	
<ul style="list-style-type: none"> with condensation, max. 	100 %; RH incl. bedewing/frost (no commissioning in bedewed state)
Resistance	
<ul style="list-style-type: none"> to biologically active substances/ compliance with EN 60721-3-3 	Yes; Class 3B2 mold and fungal spores (except fauna); the supplied plug covers must remain in place on the unused interfaces during operation.
<ul style="list-style-type: none"> to chemically active substances/ compliance with EN 60721-3-3 	Yes; Class 3C4 (RH < 75%) incl. salt spray in accordance with EN 60068-2-52 (severity 3); the supplied plug covers must remain in place on the unused interfaces during operation.
<ul style="list-style-type: none"> to mechanically active substances, compliance with EN 60721-3-3 	Yes; Class 3S4 incl. sand, dust; the supplied plug covers must remain in place on unused interfaces during operation.

Overview CPU 312



- The entry level CPU in Totally Integrated Automation (TIA)
- For smaller applications with moderate processing performance requirements

SIMATIC Micro Memory Card required for operation of the CPU.

Overview CPU 314



- For plants with medium program scope requirements
- High processing power in binary and floating-point arithmetic

SIMATIC Micro Memory Card required for operation of CPU.

Overview CPU 315-2 DP



- The CPU with medium to large program memory and quantity structures for optional use of SIMATIC engineering tools
- High processing power in binary and floating-point arithmetic
- Used as central controller in production lines with central and distributed I/O
- PROFIBUS DP master/slave interface
- For comprehensive I/O expansion
- For configuring distributed I/O structures
- Isochronous mode on PROFIBUS

SIMATIC Micro Memory Card required for operation of CPU.

SIMATIC S7-300 Advanced Controllers

Central processing units

Standard CPUs

Overview 315-2 PN/DP



- The CPU with mid-range program memory and quantity frameworks
- High processing power in binary and floating-point arithmetic
- Used as central controller in production lines with central and distributed I/O
- PROFINET interface with 2-port switch
- PROFINET IO controller for operating distributed I/O on PROFINET
- PROFINET I-device for connecting the CPU as intelligent PROFINET device under a SIMATIC or third-party PROFINET IO controller
- Component Based Automation (CBA) on PROFINET
- PROFINET proxy for intelligent devices on PROFIBUS DP in Component Based Automation (CBA)
- Integrated web server with the option of creating user-defined web pages
- Combined MPI/PROFIBUS DP master/slave interface
- Isochronous mode on PROFIBUS and PROFINET

SIMATIC Micro Memory Card required for operation of CPU.

Overview CPU 317-2 DP



- The CPU with a large program memory and quantity framework for demanding applications
- For cross-industry automation tasks in series machine, special machine and plant construction
- Used as central controller in production lines with central and distributed I/O
- High processing power in binary and floating-point arithmetic
- 2 PROFIBUS DP master/slave interfaces
- For comprehensive I/O expansion
- For configuring distributed I/O structures
- Isochronous mode on PROFIBUS
- Optionally supports the use of SIMATIC engineering tools

SIMATIC Micro Memory Card required for operation of CPU.

Overview CPU 317-2 PN/DP



- The CPU with a large program memory and quantity framework for demanding applications
- For cross-industry automation tasks in series machine, special machine and plant construction
- Used as central controller in production lines with central and distributed I/O
- High processing power in binary and floating-point arithmetic
- PROFINET interface with 2-port switch
- PROFINET IO controller for operating distributed I/O on PROFINET
- PROFINET I-device for connecting the CPU as intelligent PROFINET device under a SIMATIC or third-party PROFINET IO controller
- Distributed intelligence in Component Based Automation (CBA) on PROFINET
- PROFINET proxy for intelligent devices on PROFIBUS DP in Component Based Automation (CBA)
- Integrated web server with the option of creating user-defined web pages
- Combined MPI/PROFIBUS DP master/slave interface
- Isochronous mode on PROFIBUS and PROFINET
- Optionally supports the use of SIMATIC engineering tools

SIMATIC Micro Memory Card required for operation of CPU.

Overview CPU 319-3 PN/DP



- The CPU with high command processing performance, large program memory and quantity framework for demanding applications
- For cross-industry automation tasks in series machine, special machine and plant construction
- Used as central controller in production lines with central and distributed I/O on PROFIBUS and PROFINET
- PROFINET IO controller for operating distributed I/O on PROFINET
- PROFINET I-device for connecting the CPU as intelligent PROFINET device under a SIMATIC or non-Siemens PROFINET IO controller
- PROFINET interface with 2-port switch
- Isochronous mode on PROFIBUS or PROFINET
- Integrated web server with the option of creating user-defined web pages
- Distributed intelligence in Component Based Automation (CBA) on PROFINET
- PROFINET proxy for intelligent devices on PROFIBUS DP in Component Based Automation (CBA)
- Optionally supports the use of SIMATIC engineering tools

SIMATIC Micro Memory Card required for operation of the CPU.

SIMATIC S7-300 Advanced Controllers

Central processing units

Standard CPUs

Technical specifications

Article number	6ES7312-1AE14-0AB0 CPU312, 32KB	6ES7314-1AG14-0AB0 CPU314, 128 KB	6ES7315-2AH14-0AB0 CPU315-2DP, 256 KB	6ES7315-2EH14-0AB0 CPU315-2 PN/DP, 384 KB
General information				
Engineering with				
• Programming package	STEP 7 V5.5 + SP1 or higher or STEP 7 V5.2 + SP1 or higher with HSP 218	STEP 7 V5.5 + SP1 or higher or STEP 7 V5.2 + SP1 or higher with HSP 218	STEP 7 V5.5 + SP1 or higher or STEP 7 V5.2 + SP1 or higher with HSP 218	STEP 7 V5.5 or higher
Supply voltage				
Rated value (DC)				
• 24 V DC	Yes	Yes	Yes	Yes
Power loss				
Power loss, typ.	4 W	4 W	4.5 W	4.65 W
Memory				
Work memory				
• integrated	32 kbyte	128 kbyte	256 kbyte	384 kbyte
• Size of retentive memory for retentive data blocks	32 kbyte	64 kbyte	128 kbyte	128 kbyte
Load memory				
• Plug-in (MMC), max.	8 Mbyte	8 Mbyte	8 Mbyte	8 Mbyte
CPU processing times				
for bit operations, typ.	0.1 µs	0.06 µs	0.05 µs	0.05 µs
for word operations, typ.	0.24 µs	0.12 µs	0.09 µs	0.09 µs
for fixed point arithmetic, typ.	0.32 µs	0.16 µs	0.12 µs	0.12 µs
for floating point arithmetic, typ.	1.1 µs	0.59 µs	0.45 µs	0.45 µs
Counters, timers and their retentivity				
S7 counter				
• Number	256	256	256	256
IEC counter				
• present	Yes	Yes	Yes	Yes
S7 times				
• Number	256	256	256	256
IEC timer				
• present	Yes	Yes	Yes	Yes
Data areas and their retentivity				
Flag				
• Number, max.	256 byte	256 byte	2 048 byte	2 048 byte
Address area				
I/O address area				
• Inputs	1 024 byte	1 024 byte	2 048 byte	2 048 byte
• Outputs	1 024 byte	1 024 byte	2 048 byte	2 048 byte
Process image				
• Inputs, adjustable	1 024 byte	1 024 byte	2 048 byte	2 048 byte
• Outputs, adjustable	1 024 byte	1 024 byte	2 048 byte	2 048 byte
Time of day				
Clock				
• Hardware clock (real-time)		Yes	Yes	Yes
Operating hours counter				
• Number	1	1	1	1

Technical specifications (continued)

Article number	6ES7312-1AE14-0AB0 CPU312, 32KB	6ES7314-1AG14-0AB0 CPU314, 128 KB	6ES7315-2AH14-0AB0 CPU315-2DP, 256 KB	6ES7315-2EH14-0AB0 CPU315-2 PN/DP, 384 KB
1. Interface				
Interface type	Integrated RS 485 interface	Integrated RS 485 interface	Integrated RS 485 interface	Integrated RS 485 interface
Physics	RS 485	RS 485	RS 485	RS 485
Functionality				
• MPI	Yes	Yes	Yes	Yes
• PROFIBUS DP master	No	No	No	Yes
• PROFIBUS DP slave	No	No	No	Yes
• Point-to-point connection	No	No	No	No
DP master				
• Number of DP slaves, max.				124
2. Interface				
Interface type			Integrated RS 485 interface	PROFINET
Physics			RS 485	Ethernet RJ45
Interface types				
• Number of ports				2
Functionality				
• MPI			No	No
• PROFINET IO Controller				Yes; Also simultaneously with IO-Device functionality
• PROFINET IO Device				Yes; Also simultaneously with IO Controller functionality
• PROFINET CBA				Yes
• PROFIBUS DP master			Yes	No
• PROFIBUS DP slave			Yes	No
DP master				
• Number of DP slaves, max.			124; Per station	
Isochronous mode				
Isochronous operation (application synchronized up to terminal)			Yes	Yes; Via PROFIBUS DP or PROFINET interface
Communication functions				
PG/OP communication	Yes	Yes	Yes	Yes
Data record routing	No	No	Yes	Yes
Global data communication				
• supported	Yes	Yes	Yes	Yes
S7 basic communication				
• supported	Yes	Yes	Yes	Yes
S7 communication				
• supported	Yes	Yes	Yes	Yes
S5 compatible communication				
• supported	Yes; via CP and loadable FC	Yes; via CP and loadable FC	Yes; via CP and loadable FC	Yes; via CP and loadable FC

SIMATIC S7-300 Advanced Controllers

Central processing units

Standard CPUs

Technical specifications (continued)

Article number	6ES7312-1AE14-0AB0 CPU312, 32KB	6ES7314-1AG14-0AB0 CPU314, 128 KB	6ES7315-2AH14-0AB0 CPU315-2DP, 256 KB	6ES7315-2EH14-0AB0 CPU315-2 PN/DP, 384 KB
Open IE communication				
• TCP/IP				Yes; via integrated PROFINET interface and loadable FBs 8
- Number of connections, max.				8
• ISO-on-TCP (RFC1006)				Yes; via integrated PROFINET interface and loadable FBs 8
- Number of connections, max.				8
• UDP				Yes; via integrated PROFINET interface and loadable FBs 8
- Number of connections, max.				8
Web server				
• supported				Yes
Number of connections				
• overall	6	12	16	16
Ambient conditions				
Ambient temperature during operation				
• min.	0 °C	0 °C	0 °C	0 °C
• max.	60 °C	60 °C	60 °C	60 °C
Configuration				
Programming				
Programming language				
- LAD	Yes	Yes	Yes	Yes
- FBD	Yes	Yes	Yes	Yes
- STL	Yes	Yes	Yes	Yes
- SCL	Yes	Yes	Yes	Yes
- CFC		Yes	Yes	Yes
- GRAPH	Yes	Yes	Yes	Yes
- HiGraph®	Yes	Yes	Yes	Yes
Know-how protection				
• User program protection/password protection	Yes	Yes	Yes	Yes
• Block encryption	Yes; With S7 block Privacy	Yes; With S7 block Privacy	Yes; With S7 block Privacy	Yes; With S7 block Privacy
Dimensions				
Width	40 mm	40 mm	40 mm	40 mm
Height	125 mm	125 mm	125 mm	125 mm
Depth	130 mm	130 mm	130 mm	130 mm
Weights				
Weight, approx.	270 g	280 g	290 g	340 g

Technical specifications (continued)

Article number	6ES7317-2AK14-0AB0 CPU317-2 DP, 1 MB	6ES7317-2EK14-0AB0 CPU317-2 PN/DP, 1 MB	6ES7318-3EL01-0AB0 CPU319-3 PN/DP, 2 MB
General information			
Engineering with			
• Programming package	STEP 7 as of V5.5 + SP1 or STEP 7 V5.2 + SP1 or higher with HSP 202	STEP 7 V5.5 or higher	STEP 7 V5.5 or higher
Supply voltage			
Rated value (DC)			
• 24 V DC	Yes	Yes	Yes
Power loss			
Power loss, typ.	4.5 W	4.65 W	14 W
Memory			
Work memory			
• integrated	1 024 kbyte	1 024 kbyte	2 048 kbyte
• Size of retentive memory for retentive data blocks	256 kbyte	256 kbyte	700 kbyte
Load memory			
• Plug-in (MMC), max.	8 Mbyte	8 Mbyte	8 Mbyte
CPU processing times			
for bit operations, typ.	0.025 µs	0.025 µs	0.004 µs
for word operations, typ.	0.03 µs	0.03 µs	0.01 µs
for fixed point arithmetic, typ.	0.04 µs	0.04 µs	0.01 µs
for floating point arithmetic, typ.	0.16 µs	0.16 µs	0.04 µs
Counters, timers and their retentivity			
S7 counter			
• Number	512	512	2 048
IEC counter			
• present	Yes	Yes	Yes
S7 times			
• Number	512	512	2 048
IEC timer			
• present	Yes	Yes	Yes
Data areas and their retentivity			
Flag			
• Number, max.	4 096 byte	4 096 byte	8 192 byte
Address area			
I/O address area			
• Inputs	8 192 byte	8 192 byte	8 192 byte
• Outputs	8 192 byte	8 192 byte	8 192 byte
Process image			
• Inputs, adjustable	8 192 byte	8 192 byte	8 192 byte
• Outputs, adjustable	8 192 byte	8 192 byte	8 192 byte
Time of day			
Clock			
• Hardware clock (real-time)	Yes	Yes	Yes
Operating hours counter			
• Number	4	4	4
1. Interface			
Interface type	Integrated RS 485 interface	Integrated RS 485 interface	Integrated RS 485 interface
Physics	RS 485	RS 485	RS 485
Functionality			
• MPI	Yes	Yes	Yes
• PROFIBUS DP master	Yes	Yes	Yes
• PROFIBUS DP slave	Yes; A DP slave at both interfaces simultaneously is not possible	Yes	Yes; A DP slave at both interfaces simultaneously is not possible
• Point-to-point connection	No	No	No
DP master			
• Number of DP slaves, max.	124	124	124

SIMATIC S7-300 Advanced Controllers

Central processing units

Standard CPUs

Technical specifications (continued)

Article number	6ES7317-2AK14-0AB0 CPU317-2 DP, 1 MB	6ES7317-2EK14-0AB0 CPU317-2 PN/DP, 1 MB	6ES7318-3EL01-0AB0 CPU319-3 PN/DP, 2 MB
2. Interface			
Interface type	Integrated RS 485 interface	PROFINET	Integrated RS 485 interface
Physics	RS 485	Ethernet RJ45	RS 485
Interface types			
• Number of ports		2	
Functionality			
• MPI	No	No	No
• PROFINET IO Controller		Yes; Also simultaneously with IO-Device functionality	No
• PROFINET IO Device		Yes; Also simultaneously with IO Controller functionality	No
• PROFINET CBA		Yes	No
• PROFIBUS DP master	Yes	No	Yes
• PROFIBUS DP slave	Yes; A DP slave at both interfaces simultaneously is not possible	No	Yes; A DP slave at both interfaces simultaneously is not possible
DP master			
• Number of DP slaves, max.	124		124
3. Interface			
Interface type			PROFINET
Physics			Ethernet RJ45
Interface types			
• Number of ports			2
Functionality			
• MPI			No
• PROFINET IO Controller			Yes; Also simultaneously with I-Device functionality
• PROFINET IO Device			Yes; Also simultaneously with IO Controller functionality
• PROFINET CBA			Yes
• PROFIBUS DP master			No
• PROFIBUS DP slave			No
Isochronous mode			
Isochronous operation (application synchronized up to terminal)		Yes; Via PROFIBUS DP or PROFINET interface	Yes; Via 2nd PROFIBUS DP or PROFINET interface
Communication functions			
PG/OP communication	Yes	Yes	Yes
Data record routing	Yes	Yes	Yes
Global data communication			
• supported	Yes	Yes	Yes
S7 basic communication			
• supported	Yes	Yes	Yes
S7 communication			
• supported	Yes	Yes	Yes
S5 compatible communication			
• supported	Yes; via CP and loadable FC	Yes; via CP and loadable FC	Yes; via CP and loadable FC

SIMATIC S7-300 Advanced Controllers

Central processing units

Standard CPUs

Technical specifications (continued)

Article number	6ES7317-2AK14-0AB0 CPU317-2 DP, 1 MB	6ES7317-2EK14-0AB0 CPU317-2 PN/DP, 1 MB	6ES7318-3EL01-0AB0 CPU319-3 PN/DP, 2 MB
Open IE communication			
• TCP/IP		Yes; via integrated PROFINET interface and loadable FBs	Yes; via integrated PROFINET interface and loadable FBs
- Number of connections, max.		16	32
• ISO-on-TCP (RFC1006)		Yes; via integrated PROFINET interface and loadable FBs	Yes; via integrated PROFINET interface and loadable FBs
- Number of connections, max.		16	32
• UDP		Yes; via integrated PROFINET interface and loadable FBs	Yes; via integrated PROFINET interface and loadable FBs
- Number of connections, max.		16	32
Web server			
• supported		Yes	Yes
Number of connections			
• overall	32	32	32
Ambient conditions			
Ambient temperature during operation			
• min.	0 °C	0 °C	0 °C
• max.	60 °C	60 °C	60 °C
Configuration			
Programming			
Programming language			
- LAD	Yes	Yes	Yes
- FBD	Yes	Yes	Yes
- STL	Yes	Yes	Yes
- SCL	Yes	Yes	Yes
- CFC	Yes	Yes	Yes
- GRAPH	Yes	Yes	Yes
- HiGraph®	Yes	Yes	Yes
Know-how protection			
• User program protection/password protection	Yes	Yes	Yes
• Block encryption	Yes; With S7 block Privacy	Yes; With S7 block Privacy	Yes; With S7 block Privacy
Dimensions			
Width	40 mm	40 mm	120 mm
Height	125 mm	125 mm	125 mm
Depth	130 mm	130 mm	130 mm
Weights			
Weight, approx.	360 g	340 g	1 250 g

SIMATIC S7-300 Advanced Controllers

Central processing units

Standard CPUs

Ordering data	Article No.	Article No.
CPU 312 Work memory 32 KB, supply voltage 24 V DC, MPI; MMC required	6ES7312-1AE14-0AB0	SIMATIC Manual Collection Electronic manuals on DVD, multilingual: LOGO!, SIMADYN, SIMATIC bus components, SIMATIC C7, SIMATIC distributed I/O, SIMATIC HMI, SIMATIC Sensors, SIMATIC NET, SIMATIC PC Based Automation, SIMATIC PCS 7, SIMATIC PG/PC, SIMATIC S7, SIMATIC Software, SIMATIC TDC
CPU 314 Work memory 128 KB, supply voltage 24 V DC, MPI; MMC required	6ES7314-1AG14-0AB0	SIMATIC Manual Collection update service for 1 year Current "Manual Collection" DVD and the three subsequent updates
CPU 315-2 DP Work memory 256 KB, supply voltage 24 V DC, MPI, PROFIBUS DP master/slave interface; MMC required	6ES7315-2AH14-0AB0	Power supply connector 10 units, spare part
CPU 315-2 PN/DP Work memory 384 KB, 24 V DC power supply, combined MPI/PROFIBUS DP master/slave interface, Ethernet/PROFINET interface with 2-port switch; MMC required	6ES7315-2EH14-0AB0	USB A2 PC adapter For connecting a PG/PC or Notebook to PROFIBUS or MPI; USB cable included in scope of delivery
CPU 317-2 DP Work memory 1 MB, supply voltage 24 V DC, MPI, PROFIBUS DP master/slave interface; MMC required	6ES7317-2AK14-0AB0	PROFIBUS bus components
CPU 317-2 PN/DP Work memory 1 MB, 24 V DC power supply, combined MPI/PROFIBUS DP master/slave interface, Ethernet/PROFINET interface with 2-port switch; MMC required	6ES7317-2EK14-0AB0	PROFIBUS DP RS 485 bus connector • with 90° cable outlet, max. transfer rate 12 Mbps - without PG interface - with PG interface • with 90° cable outlet for FastConnect connection system, max. transfer rate 12 Mbps - without PG interface, 1 unit - without PG interface, 100 units - with PG interface, 1 unit - with PG interface, 100 units • with axial cable outlet for SIMATIC OP, for connecting to PPI, MPI, PROFIBUS
CPU 319-3 PN/DP Work memory 2 MB, power supply 24 V DC, combined MPI/PROFIBUS DP master/slave interface, PROFIBUS DP master/ slave interface, Ethernet/ PROFINET interface with 2-port switch; MMC required	6ES7318-3EL01-0AB0	PROFIBUS FastConnect bus cable Standard type with special design for quick mounting, 2-wire, shielded, sold by the meter, max. delivery unit 1000 m, minimum ordering quantity 20 m
SIMATIC Micro Memory Card 64 KB 128 KB 512 KB 2 MB 4 MB 8 MB	6ES7953-8LF31-0AA0 6ES7953-8LG31-0AA0 6ES7953-8LJ31-0AA0 6ES7953-8LL31-0AA0 6ES7953-8LM31-0AA0 6ES7953-8LP31-0AA0	RS 485 repeater for PROFIBUS Transmission rate up to 12 Mbps; 24 V DC; IP20 enclosure
MPI cable For connection of SIMATIC S7 and PG via MPI; 5 m in length	6ES7901-0BF00-0AA0	
Slot number plates	6ES7912-0AA00-0AA0	

Ordering data	Article No.		Article No.
PROFINET bus components			
IE FC TP Standard Cable GP 2x2	6XV1840-2AH10	IE FC RJ45 plugs	
4-wire, shielded TP installation cable for connection to IE FC Outlet RJ45/IE FC RJ45 Plug; PROFINET-compatible; with UL approval; Sold by the meter		RJ45 plug connector for Industrial Ethernet with a rugged metal enclosure and integrated insulation displacement contacts for connecting Industrial Ethernet FC installation cables	
FO Standard Cable GP (50/125)	6XV1873-2A	IE FC RJ45 Plug 145	
Standard cable, splittable, UL approval, sold by the meter		145° cable outlet	
SCALANCE X204-2 Industrial Ethernet switch	6GK5204-2BB10-2AA3	1 unit	6GK1901-1BB30-0AA0
Industrial Ethernet switches with integral SNMP access, web diagnostics, copper cable diagnostics and PROFINET diagnostics for configuring line, star and ring topologies; four 10/100 Mbps RJ45 ports and two FO ports		10 units	6GK1901-1BB30-0AB0
CSM 377 Compact Switch Module	6GK7377-1AA00-0AA0	50 units	6GK1901-1BB30-0AE0
Unmanaged switch for connecting a SIMATIC S7-300, ET200 M and up to three other stations to Industrial Ethernet with 10/100 Mbps; 4 x RJ45 ports; external 24 V DC power supply, LED diagnostics, S7-300 module incl. electronic manual on CD-ROM		IE FC RJ45 Plug 180	
		180° cable outlet	
		1 unit	6GK1901-1BB10-2AA0
		10 units	6GK1901-1BB10-2AB0
		50 units	6GK1901-1BB10-2AE0
		PROFIBUS/PROFINET bus components	
		For establishing MPI/PROFIBUS/PROFINET communication	See Catalogs IK PI, CA 01

SIMATIC S7-300 Advanced Controllers

Central processing units

SIPLUS S7-300 standard CPUs

Overview SIPLUS S7-300 CPU 314



- For plants with medium requirements on the program scope
- High processing performance in binary and floating-point arithmetic

SIMATIC Micro Memory Card required for operation of CPU.

Note:

SIPLUS extreme products are based on SIMATIC standard products. The contents listed here were taken from the respective standard products. SIPLUS extreme-specific information was added.

Overview SIPLUS S7-300 CPU 315-2DP



- The CPU with medium to large program memory and quantity structures for optional use of SIMATIC engineering tools
- High processing performance in binary and floating-point arithmetic
- PROFIBUS DP master/slave interface
- For comprehensive I/O expansion
- For configuring distributed I/O structures

SIMATIC Micro Memory Card required for operation of CPU.

Note:

SIPLUS extreme products are based on SIMATIC standard products. The contents listed here were taken from the respective standard products. SIPLUS extreme-specific information was added.

Overview SIPLUS S7-300 CPU 315-2 PN/DP



- The CPU with medium-sized program memory and quantity frameworks
- High processing performance in binary and floating-point arithmetic
- Used as central controller in production lines with central and distributed I/O
- Component Based Automation (CBA) on PROFINET
- PROFINET proxy for intelligent devices on PROFIBUS DP in Component Based Automation (CBA)
- PROFINET IO controller for operating distributed I/O on PROFINET
- PROFINET interface with 2-port switch
- Combined MPI/PROFIBUS DP master/slave interface
- Isochronous mode on PROFIBUS

SIMATIC Micro Memory Card required for operation of CPU.

Note:

SIPLUS extreme products are based on SIMATIC standard products. The contents listed here were taken from the respective standard products. SIPLUS extreme-specific information was added.

Overview SIPLUS S7-300 CPU 317-2 PN/DP



- The CPU with a large program memory and quantity framework for demanding applications
- Distributed intelligence in Component Based Automation (CBA) on PROFINET
- PROFINET proxy for intelligent devices on PROFIBUS DP in Component Based Automation (CBA)
- PROFINET IO controller for operating distributed I/O on PROFINET
- For cross-industry automation tasks in series machine, special machine and plant construction
- Used as central controller in production lines with central and distributed I/O
- For comprehensive I/O expansion
- For configuring distributed I/O structures
- High processing performance in binary and floating-point arithmetic
- Combined MPI/PROFIBUS DP master/slave interface
- Optionally supports the use of SIMATIC engineering tools

Micro Memory Card required for operation of CPU.

Note:

SIPLUS extreme products are based on SIMATIC standard products. The contents listed here were taken from the respective standard products. SIPLUS extreme-specific information was added.

SIMATIC S7-300 Advanced Controllers

Central processing units

SIPLUS S7-300 standard CPUs

Technical specifications

Article number	6AG1314-1AG14-2AY0	6AG1314-1AG14-7AB0	6AG1315-2AH14-2AY0	6AG1315-2AH14-7AB0
Based on	6ES7314-1AG14-0AB0 SIPLUS CPU314 EN50155	6ES7314-1AG14-0AB0 SIPLUS S7-300 CPU314	6ES7315-2AH14-0AB0 SIPLUS CPU 315-2DP EN50155	6ES7315-2AH14-0AB0 SIPLUS S7-300 CPU 315-2DP
Ambient conditions				
Ambient temperature during operation				
• min.	-25 °C; = Tmin	-25 °C; = Tmin	-25 °C; = Tmin	-25 °C; = Tmin
• max.	60 °C; = Tmax; the rated temperature range of -25 ... +55 °C (T1) applies for the use on railway vehicles according to EN50155	70 °C; = Tmax; 60 °C @ UL/cUL, ATEX and FM use	60 °C; = Tmax; the rated temperature range of -25 ... +55 °C (T1) applies for the use on railway vehicles according to EN50155	70 °C; = Tmax; 60 °C @ UL/cUL, ATEX and FM use
Ambient temperature during storage/transportation				
• min.	-40 °C	-40 °C	-40 °C	-40 °C
• max.	70 °C	70 °C	70 °C	70 °C
Extended ambient conditions				
• relative to ambient temperature-atmospheric pressure-installation altitude		Tmin ... Tmax at 1080 hPa ... 795 hPa (-1000 m ... +2000 m) // Tmin ... (Tmax - 10K) at 795 hPa ... 658 hPa (+2000 m ... +3500 m) // Tmin ... (Tmax - 20K) at 658 hPa ... 540 hPa (+3500 m ... +5000 m)		Tmin ... Tmax at 1080 hPa ... 795 hPa (-1000 m ... +2000 m) // Tmin ... (Tmax - 10K) at 795 hPa ... 658 hPa (+2000 m ... +3500 m) // Tmin ... (Tmax - 20K) at 658 hPa ... 540 hPa (+3500 m ... +5000 m)
Relative humidity				
- With condensation, tested in accordance with IEC 60068-2-38, max.	100 %; RH incl. condensation / frost (no commissioning in bedewed state), horizontal installation	100 %; RH incl. condensation/frost (no commissioning under condensation conditions)	100 %; RH incl. condensation / frost (no commissioning in bedewed state), horizontal installation	100 %; RH incl. condensation/frost (no commissioning under condensation conditions)
Resistance				
- against biologically active substances / conformity with EN 60721-3-3	Yes; Class 3B2 mold, fungus and dry rot spores (with the exception of fauna). The supplied connector covers must remain on the unused interfaces during operation!	Yes; Class 3B2 mold, fungus and dry rot spores (with the exception of fauna). The supplied connector covers must remain on the unused interfaces during operation!	Yes; Class 3B2 mold, fungus and dry rot spores (with the exception of fauna). The supplied connector covers must remain on the unused interfaces during operation!	Yes; Class 3B2 mold, fungus and dry rot spores (with the exception of fauna). The supplied connector covers must remain on the unused interfaces during operation in corrosive atmospheres!
- against chemically active substances / conformity with EN 60721-3-3	Yes; Class 3C4 (RH < 75%) incl. salt spray according to EN 60068-2-52 (degree of severity 3). The supplied connector covers must remain on the unused interfaces during operation!	Yes; Class 3C4 incl. salt spray according to EN 60068-2-52 (degree of severity 3). The supplied connector covers must remain on the unused interfaces during operation!	Yes; Class 3C4 (RH < 75%) incl. salt spray according to EN 60068-2-52 (degree of severity 3). The supplied connector covers must remain on the unused interfaces during operation!	Yes; Class 3C4 incl. salt spray according to EN 60068-2-52 (degree of severity 3). The supplied connector covers must remain on the unused interfaces during operation!
- against mechanically active substances / conformity with EN 60721-3-3	Yes; Class 3S4 incl. sand, dust. The supplied connector covers must remain on the unused interfaces during operation!	Yes; Class 3S4 incl. sand, dust. The supplied connector covers must remain on the unused interfaces during operation!	Yes; Class 3S4 incl. sand, dust. The supplied connector covers must remain on the unused interfaces during operation!	Yes; Class 3S4 incl. sand, dust. The supplied connector covers must remain on the unused interfaces during operation!

Technical specifications (continued)

Article number	6AG1315-2EH14-2AY0	6AG1315-2EH14-7AB0	6AG1317-2EK14-2AY0	6AG1317-2EK14-7AB0
Based on	6ES7315-2EH14-0AB0 SIPLUS S7-300 CPU315-2PN/DP EN50155	6ES7315-2EH14-0AB0 SIPLUS S7-300 CPU315-2PN/DP	6ES7317-2EK14-0AB0 SIPLUS S7-300 CPU317-2PN/DP EN50155	6ES7317-2EK14-0AB0 SIPLUS S7-300 CPU317-2PN/DP
Ambient conditions				
Ambient temperature during operation				
• min.	-25 °C; = Tmin	-25 °C; = Tmin	-25 °C; = Tmin	-25 °C; = Tmin
• max.	60 °C; = Tmax; the rated temperature range of -25 ... +55 °C (T1) applies for the use on railway vehicles according to EN50155	70 °C; = Tmax; 60 °C @ UL/cUL, ATEX and FM use	60 °C; = Tmax; the rated temperature range of -25 ... +55 °C (T1) applies for the use on railway vehicles according to EN50155	70 °C; = Tmax; @ 60°C for UL/ATEX/FM use
Ambient temperature during storage/transportation				
• min.	-40 °C	-40 °C	-40 °C	-40 °C
• max.	70 °C	70 °C	70 °C	70 °C
Extended ambient conditions				
• relative to ambient temperature-atmospheric pressure-installation altitude	Tmin ... Tmax at 1080 hPa ... 795 hPa (-1000 m ... +2000 m) // Tmin ... (Tmax - 10K) at 795 hPa ... 658 hPa (+2000 m ... +3500 m) // Tmin ... (Tmax - 20K) at 658 hPa ... 540 hPa (+3500 m ... +5000 m)	Tmin ... Tmax at 1080 hPa ... 795 hPa (-1000 m ... +2000 m) // Tmin ... (Tmax - 10K) at 795 hPa ... 658 hPa (+2000 m ... +3500 m) // Tmin ... (Tmax - 20K) at 658 hPa ... 540 hPa (+3500 m ... +5000 m)	Tmin ... Tmax at 1080 hPa ... 795 hPa (-1000 m ... +2000 m) // Tmin ... (Tmax - 10K) at 795 hPa ... 658 hPa (+2000 m ... +3500 m) // Tmin ... (Tmax - 20K) at 658 hPa ... 540 hPa (+3500 m ... +5000 m)	Tmin ... Tmax at 1080 hPa ... 795 hPa (-1000 m ... +2000 m) // Tmin ... (Tmax - 10K) at 795 hPa ... 658 hPa (+2000 m ... +3500 m) // Tmin ... (Tmax - 20K) at 658 hPa ... 540 hPa (+3500 m ... +5000 m)
Relative humidity				
- With condensation, tested in accordance with IEC 60068-2-38, max.	100 %; RH incl. condensation/frost (no commissioning under condensation conditions)	100 %; RH incl. condensation/frost (no commissioning under condensation conditions)	100 %; Relative humidity, incl. condensation / frost permitted (no commissioning under condensation conditions)	100 %; Relative humidity, incl. condensation / frost permitted (no commissioning under condensation conditions)
Resistance				
- against biologically active substances / conformity with EN 60721-3-3	Yes; Class 3B2 mold, fungus and dry rot spores (with the exception of fauna). The supplied connector covers must remain on the unused interfaces during operation in corrosive atmospheres!	Yes; Class 3B2 mold, fungus and dry rot spores (with the exception of fauna). The supplied connector covers must remain on the unused interfaces during operation in corrosive atmospheres!	Yes; Class 3B2 mold, fungus and dry rot spores (with the exception of fauna). The supplied connector covers must remain on the unused interfaces during operation!	Yes; Class 3B2 mold, fungus and dry rot spores (with the exception of fauna). The supplied connector covers must remain on the unused interfaces during operation in corrosive atmospheres!
- against chemically active substances / conformity with EN 60721-3-3	Yes; Class 3C4 incl. salt spray according to EN 60068-2-52 (degree of severity 3). The supplied connector covers must remain on the unused interfaces during operation!	Yes; Class 3C4 incl. salt spray according to EN 60068-2-52 (degree of severity 3). The supplied connector covers must remain on the unused interfaces during operation!	Yes; Class 3C4 incl. salt spray according to EN 60068-2-52 (degree of severity 3). The supplied connector covers must remain on the unused interfaces during operation!	Yes; Class 3C4 incl. salt spray according to EN 60068-2-52 (degree of severity 3). The supplied connector covers must remain on the unused interfaces during operation!
- against mechanically active substances / conformity with EN 60721-3-3	Yes; Class 3S4 incl. sand, dust. The supplied connector covers must remain on the unused interfaces during operation!	Yes; Class 3S4 incl. sand, dust. The supplied connector covers must remain on the unused interfaces during operation!	Yes; Class 3S4 incl. sand, dust. The supplied connector covers must remain on the unused interfaces during operation!	Yes; Class 3S4 incl. sand, dust. The supplied connector covers must remain on the unused interfaces during operation!

SIMATIC S7-300 Advanced Controllers

Central processing units

SIPLUS S7-300 standard CPUs

Ordering data

Article No.

Article No.

SIPLUS S7-300 CPU 314

For industrial applications with extended ambient conditions

CPU, work memory 128 KB, power supply 24 V DC, MPI; MMC required

Extended temperature range and exposure to media

6AG1314-1AG14-7AB0

For rolling stock railway applications

CPU, work memory 128 KB, power supply 24 V DC, MPI; MMC required

Conforms to EN 50155

6AG1314-1AG14-2AY0

SIPLUS S7-300 CPU 315-2 DP

For industrial applications with extended ambient conditions

CPU, work memory 256 KB, power supply 24 V DC, MPI, PROFIBUS DP master/slave interface; MMC required

Extended temperature range and exposure to media

6AG1315-2AH14-7AB0

For rolling stock railway applications

CPU, work memory 256 KB, power supply 24 V DC, MPI, PROFIBUS DP master/slave interface; MMC required

Conforms to EN 50155

6AG1315-2AH14-2AY0

SIPLUS S7-300 CPU 315-2 PN/DP

For industrial applications with extended ambient conditions

CPU, work memory 384 KB, power supply 24 V DC, combined MPI/PROFIBUS DP master/slave interface, Ethernet/PROFINET interface with 2-port switch; MMC required

Extended temperature range and exposure to media

6AG1315-2EH14-7AB0

For rolling stock railway applications

CPU, work memory 384 KB, power supply 24 V DC, combined MPI/PROFIBUS DP master/slave interface, Ethernet/PROFINET interface with 2-port switch; MMC required

Conforms to EN 50155

6AG1315-2EH14-2AY0

SIPLUS S7-300 CPU 317-2 PN/DP

For industrial applications with extended ambient conditions

CPU, work memory 1 MB, power supply 24 V DC, combined MPI/PROFIBUS DP master/slave interface, Ethernet/PROFINET interface; MMC required

Extended temperature range and exposure to media

6AG1317-2EK14-7AB0

For rolling stock railway applications

CPU, work memory 1 MB, power supply 24 V DC, combined MPI/PROFIBUS DP master/slave interface, Ethernet/PROFINET interface; MMC required

Conforms to EN 50155

6AG1317-2EK14-2AY0

Accessories

Mandatory

SIMATIC Micro Memory Card

64 KB

6ES7953-8LF31-0AA0

128 KB

6ES7953-8LG31-0AA0

512 KB

6ES7953-8LJ31-0AA0

2 MB

6ES7953-8LL31-0AA0

4 MB

6ES7953-8LM31-0AA0

8 MB

6ES7953-8LP31-0AA0

For communication within the application

PROFIBUS DP RS 485 bus connector

(extended temperature range and exposure to media)

with 90° cable outlet, max. transfer rate 12 Mbps

- Without PG interface
- With PG interface

6AG1972-0BA12-2XA0

6AG1972-0BB12-2XA0

with inclined cable outlet, max. transmission rate 12 Mbps

- without PG interface
- with PG interface

6AG1972-0BA42-7XA0

6AG1972-0BB42-7XA0

With insulation displacement terminals, max. transfer rate 12 Mbps

- with PG interface, grounding via control cabinet cover

6AG1972-0BB70-7XA0

(extended temperature range)

with axial cable outlet for SIMATIC OP, for connecting to PPI, MPI, PROFIBUS

6AG1500-0EA02-2AA0

SIMATIC S7-300 Advanced Controllers

Central processing units

SIPLUS S7-300 standard CPUs

Ordering data	Article No.	Ordering data	Article No.
IE FC RJ45 Plug 180 (extended temperature range and exposure to media) 180° cable outlet • 1 unit	6AG1901-1BB10-7AA0	IE FC TP Standard Cable GP 2x2 4-wire, shielded TP installation cable for connection to IE FC Outlet RJ45/IE FC RJ45 Plug; PROFINET-compatible; with UL approval; Sold by the meter	6XV1840-2AH10
SIPLUS SCALANCE X-200 Industrial Ethernet switches Industrial Ethernet switches with integral SNMP access, online diagnostics, copper cable diagnostics and PROFINET diagnostics for configuring line, star and ring topologies; with integrated redundancy manager (except: SCALANCE X208PRO); incl. operating instructions, Industrial Ethernet network manual and configuration software on CD-ROM • With electrical and optical ports for glass multimode FOC up to 3 km • Extended temperature range and exposure to media • SIPLUS SCALANCE X204-2 with four 10/100 Mbps RJ45 ports and two fiber-optic ports	6AG1204-2BB10-4AA3	FO Standard Cable GP (50/125) Standard cable, splittable, UL approval, sold by the meter <i>For commissioning</i> MPI cable For connection of SIMATIC S7 and PG via MPI; 5 m in length USB A2 PC adapter For connecting a PG/PC or Notebook to PROFIBUS or MPI; USB cable included in scope of delivery <i>Consumables</i> Power supply connector 10 units, spare part Slot number plates <i>Documentation</i> SIMATIC Manual Collection Electronic manuals on DVD, multi-language: LOGO!, SIMADYN, SIMATIC bus components, SIMATIC C7, SIMATIC distributed I/O, SIMATIC HMI, SIMATIC Sensors, SIMATIC NET, SIMATIC PC Based Automation, SIMATIC PCS 7, SIMATIC PG/PC, SIMATIC S7, SIMATIC Software, SIMATIC TDC SIMATIC Manual Collection update service for 1 year Current "Manual Collection" DVD and the three subsequent updates	6XV1873-2A 6ES7901-0BF00-0AA0 6GK1571-0BA00-0AA0 6ES7391-1AA00-0AA0 6ES7912-0AA00-0AA0 6ES7998-8XC01-8YE0 6ES7998-8XC01-8YE2
PROFIBUS FastConnect bus cable Standard type with special design for quick mounting, 2-wire, shielded, sold by the meter, max. delivery unit 1000 m, minimum ordering quantity 20 m	6XV1830-0EH10		
RS 485 repeater for PROFIBUS (extended temperature range and exposure to media) Transmission rate up to 12 Mbps; 24 V DC; IP20 enclosure	6AG1972-0AA02-7XA0		

SIMATIC S7-300 Advanced Controllers

Central processing units

Compact CPUs

Overview CPU 312 C



- The compact CPU with integral digital inputs/outputs
- For small applications with increased processing performance requirements
- With technological functions

SIMATIC Micro Memory Card required for operation of CPU.

Overview CPU 313C-2 PtP



- The compact CPU with integrated digital inputs/outputs as well as second serial interface
- For plants with high processing performance and response time requirements
- With technological functions

SIMATIC Micro Memory Card required for operation of the CPU.

Overview CPU 313C



- The compact CPU with integral digital and analog inputs/outputs
- For plants with high processing performance and response time requirements
- With technological functions

SIMATIC Micro Memory Card required for operation of the CPU.

Overview CPU 313C-2 DP



- The compact CPU with integral digital inputs/outputs and PROFIBUS DP master/slave interface
- For plants with high processing performance and response time requirements
- With technological functions
- For tasks with special functions
- For connecting distributed I/Os

SIMATIC Micro Memory Card required for operation of the CPU.

Overview CPU 314C-2 PtP



- The compact CPU with integrated digital and analog inputs/outputs as well as second serial interface
- For plants with high processing performance and response time requirements
- With technological functions

SIMATIC Micro Memory Card required for operation of the CPU.

Overview CPU 314C-2 DP



- The compact CPU with integral digital and analog inputs/outputs and PROFIBUS DP master/slave interface
- With technological functions
- For plants with high processing performance and response time requirements
- For connecting distributed I/Os

SIMATIC Micro Memory Card required for operation of the CPU.

Overview CPU 314C-2 PN/DP



- The compact CPU with integral digital and analog inputs/outputs and technological functions
- High processing performance in binary and floating-point arithmetic
- For connecting distributed I/O via PROFIBUS and PROFINET
- Combined MPI/PROFIBUS DP master/slave interface
- PROFINET interface with 2-port switch
- PROFINET IO controller for operating distributed I/O on PROFINET
- PROFINET I-device for connecting the CPU as intelligent PROFINET device under a SIMATIC or third-party PROFINET IO controller
- Component Based Automation (CBA) on PROFINET
- PROFINET proxy for intelligent devices on PROFIBUS DP in Component Based Automation (CBA)
- Integrated web server with the option of creating user-defined web pages
- Isochronous mode on PROFINET

SIMATIC Micro Memory Card required for operation of CPU.

SIMATIC S7-300 Advanced Controllers

Central processing units

Compact CPUs

Technical specifications

Article number	6ES7312-5BF04-0AB0 CPU312C, 10DI/6DO, 64 KB	6ES7313-5BG04-0AB0 CPU313C, 24DI/16DO/5AI/2AO, 128 KB	6ES7313-6BG04-0AB0 CPU313C-2 PTP, 16DI/16DO, 128 KB	6ES7313-6CG04-0AB0 CPU313C-2 DP, 16DI/16DO, 128 KB
General information				
Engineering with				
• Programming package	STEP 7 V5.5 + SP1 or higher or STEP 7 V5.3 + SP2 or higher with HSP 203	STEP 7 V5.5 + SP1 or higher or STEP 7 V5.3 + SP2 or higher with HSP 203	STEP 7 as of V5.5 + SP1 or STEP 7 V5.3 + SP2 or higher with HSP 204	STEP 7 V5.5 + SP1 or higher or STEP 7 V5.3 + SP2 or higher with HSP 203
Supply voltage				
Rated value (DC)				
• 24 V DC	Yes	Yes	Yes	Yes
Power loss				
Power loss, typ.	8 W	12 W	9 W	9 W
Memory				
Work memory				
• integrated	64 kbyte	128 kbyte	128 kbyte	128 kbyte
• Size of retentive memory for retentive data blocks	64 kbyte	64 kbyte	64 kbyte	64 kbyte
Load memory				
• Plug-in (MMC), max.	8 Mbyte	8 Mbyte	8 Mbyte	8 Mbyte
CPU processing times				
for bit operations, typ.	0.1 µs	0.07 µs	0.07 µs	0.07 µs
for word operations, typ.	0.24 µs	0.15 µs	0.15 µs	0.15 µs
for fixed point arithmetic, typ.	0.32 µs	0.2 µs	0.2 µs	0.2 µs
for floating point arithmetic, typ.	1.1 µs	0.72 µs	0.72 µs	0.72 µs
Counters, timers and their retentivity				
S7 counter				
• Number	256	256	256	256
IEC counter				
• present	Yes	Yes	Yes	Yes
S7 times				
• Number	256	256	256	256
IEC timer				
• present	Yes	Yes	Yes	Yes
Data areas and their retentivity				
Flag				
• Number, max.	256 byte	256 byte	256 byte	256 byte
Address area				
I/O address area				
• Inputs	1 024 byte	1 024 byte	1 024 byte	2 048 byte
• Outputs	1 024 byte	1 024 byte	1 024 byte	2 048 byte
Process image				
• Inputs, adjustable	1 024 byte	1 024 byte	1 024 byte	2 048 byte
• Outputs, adjustable	1 024 byte	1 024 byte	1 024 byte	2 048 byte
Time of day				
Clock				
• Hardware clock (real-time)		Yes	Yes	Yes
Operating hours counter				
• Number	1	1	1	1
Digital inputs				
integrated channels (DI)	10	24	16	16
Digital outputs				
integrated channels (DO)	6	16	16	16

Technical specifications (continued)

Article number	6ES7312-5BF04-0AB0 CPU312C, 10DI/6DO, 64 KB	6ES7313-5BG04-0AB0 CPU313C, 24DI/16DO/5AI/2AO, 128 KB	6ES7313-6BG04-0AB0 CPU313C-2 PTP, 16DI/16DO, 128 KB	6ES7313-6CG04-0AB0 CPU313C-2 DP, 16DI/16DO, 128 KB
Analog inputs				
integrated channels (AI)	0	5; 4 x current/voltage, 1 x resistance	0	0
Input ranges				
• Voltage		Yes; ± 10 V / 100 k Ω ; 0 V to 10 V / 100 k Ω		
• Current		Yes; ± 20 mA / 100 Ω ; 0 mA to 20 mA / 100 Ω ; 4 mA to 20 mA / 100 Ω		
• Resistance thermometer		Yes; Pt 100 / 10 M Ω		
• Resistance		Yes; 0 Ω to 600 Ω / 10 M Ω		
Analog outputs				
integrated channels (AO)	0	2	0	0
Output ranges, voltage				
• 0 to 10 V		Yes		
• -10 V to +10 V		Yes		
Output ranges, current				
• 0 to 20 mA		Yes		
• -20 mA to +20 mA		Yes		
• 4 mA to 20 mA		Yes		
1. Interface				
Interface type	Integrated RS 485 interface	Integrated RS 485 interface	Integrated RS 485 interface	Integrated RS 485 interface
Physics	RS 485	RS 485	RS 485	RS 485
Functionality				
• MPI	Yes	Yes	Yes	Yes
• PROFIBUS DP master	No	No	No	No
• PROFIBUS DP slave	No	No	No	No
• Point-to-point connection	No	No	No	No
2. Interface				
Interface type			Integrated RS 422/ 485 interface	Integrated RS 485 interface
Physics			RS 422/RS 485 (X.27)	RS 485
Functionality				
• MPI			No	No
• PROFINET IO Controller			No	No
• PROFINET IO Device			No	No
• PROFINET CBA			No	No
• PROFIBUS DP master			No	Yes
• PROFIBUS DP slave			No	Yes
DP master				
• Number of DP slaves, max.				124
Communication functions				
PG/OP communication	Yes	Yes	Yes	Yes
Data record routing	No	No	No	Yes
Global data communication				
• supported	Yes	Yes	Yes	Yes
S7 basic communication				
• supported	Yes	Yes	Yes; Server	Yes
S7 communication				
• supported	Yes	Yes	Yes	Yes
S5 compatible communication				
• supported	Yes; via CP and loadable FC	Yes; via CP and loadable FC	Yes; via CP and loadable FC	Yes; via CP and loadable FC
Number of connections				
• overall	6	8	8	8

SIMATIC S7-300 Advanced Controllers

Central processing units

Compact CPUs

Technical specifications (continued)

Article number	6ES7312-5BF04-0AB0 CPU312C, 10DI/6DO, 64 KB	6ES7313-5BG04-0AB0 CPU313C, 24DI/16DO/5AI/2AO, 128 KB	6ES7313-6BG04-0AB0 CPU313C-2 PTP, 16DI/16DO, 128 KB	6ES7313-6CG04-0AB0 CPU313C-2 DP, 16DI/16DO, 128 KB
Integrated Functions				
Number of counters	2; See "Technological Functions" manual	3; See "Technological Functions" manual	3; See "Technological Functions" manual	3; See "Technological Functions" manual
Counting frequency (counter) max.	10 kHz	30 kHz	30 kHz	30 kHz
Frequency measurement	Yes	Yes	Yes	Yes
Number of frequency meters	2; up to 10 kHz (see "Technological Functions" manual)	3; up to 30 kHz (see "Technological Functions" manual)	3; up to 30 kHz (see "Technological Functions" manual)	3; up to 30 kHz (see "Technological Functions" manual)
controlled positioning	No	No	No	No
integrated function blocks (closed-loop control)	No	Yes; PID controller (see "Technological Functions" manual)	Yes; PID controller (see "Technological Functions" manual)	Yes; PID controller (see "Technological Functions" manual)
PID controller	No	Yes	Yes	Yes
Number of pulse outputs	2; Pulse width modulation up to 2.5 kHz (see "Technological Functions" Manual)	3; Pulse width modulation up to 2.5 kHz (see "Technological Functions" Manual)	3; Pulse width modulation up to 2.5 kHz (see "Technological Functions" Manual)	3; Pulse width modulation up to 2.5 kHz (see "Technological Functions" Manual)
Limit frequency (pulse)	2.5 kHz	2.5 kHz	2.5 kHz	2.5 kHz
Ambient conditions				
Ambient temperature during operation				
• min.	0 °C	0 °C	0 °C	0 °C
• max.	60 °C	60 °C	60 °C	60 °C
Configuration				
Programming				
Programming language				
- LAD	Yes	Yes	Yes	Yes
- FBD	Yes	Yes	Yes	Yes
- STL	Yes	Yes	Yes	Yes
- SCL	Yes	Yes	Yes	Yes
- CFC		Yes	Yes	Yes
- GRAPH	Yes	Yes	Yes	Yes
- HiGraph®	Yes	Yes	Yes	Yes
Know-how protection				
• User program protection/password protection	Yes	Yes	Yes	Yes
• Block encryption	Yes; With S7 block Privacy	Yes; With S7 block Privacy	Yes; With S7 block Privacy	Yes; With S7 block Privacy
Dimensions				
Width	80 mm	120 mm	80 mm	80 mm
Height	125 mm	125 mm	125 mm	125 mm
Depth	130 mm	130 mm	130 mm	130 mm
Weights				
Weight, approx.	410 g	660 g	500 g	500 g

Technical specifications (continued)

Article number	6ES7314-6BH04-0AB0 CPU314C-2PTP, 24DI/16DO/5AI/2AO, 192 KB	6ES7314-6CH04-0AB0 CPU314C-2DP, 24DI/16DO/5AI/2AO, 192 KB	6ES7314-6EH04-0AB0 CPU314C-2PN/DP, 24DI/16DO/4AI/2AO, 192KB
General information			
Engineering with			
• Programming package	STEP 7 as of V5.5 + SP1 or STEP 7 V5.3 + SP2 or higher with HSP 204	STEP 7 V5.5 + SP1 or higher or STEP 7 V5.3 + SP2 or higher with HSP 203	STEP 7 V5.5 or higher with HSP 191
Supply voltage			
Rated value (DC)			
• 24 V DC	Yes	Yes	Yes
Power loss			
Power loss, typ.	13 W	13 W	14 W
Memory			
Work memory			
• integrated	192 kbyte	192 kbyte	192 kbyte
• Size of retentive memory for retentive data blocks	64 kbyte	64 kbyte	64 kbyte
Load memory			
• Plug-in (MMC), max.	8 Mbyte	8 Mbyte	8 Mbyte
CPU processing times			
for bit operations, typ.	0.06 µs	0.06 µs	0.06 µs
for word operations, typ.	0.12 µs	0.12 µs	0.12 µs
for fixed point arithmetic, typ.	0.16 µs	0.16 µs	0.16 µs
for floating point arithmetic, typ.	0.59 µs	0.59 µs	0.59 µs
Counters, timers and their retentivity			
S7 counter			
• Number	256	256	256
IEC counter			
• present	Yes	Yes	Yes
S7 times			
• Number	256	256	256
IEC timer			
• present	Yes	Yes	Yes
Data areas and their retentivity			
Flag			
• Number, max.	256 byte	256 byte	256 byte
Address area			
I/O address area			
• Inputs	1 024 byte	2 048 byte	2 048 byte
• Outputs	1 024 byte	2 048 byte	2 048 byte
Process image			
• Inputs, adjustable	1 024 byte	2 048 byte	2 048 byte
• Outputs, adjustable	1 024 byte	2 048 byte	2 048 byte
Time of day			
Clock			
• Hardware clock (real-time)	Yes	Yes	Yes
Operating hours counter			
• Number	1	1	1
Digital inputs			
integrated channels (DI)	24	24	24
Digital outputs			
integrated channels (DO)	16	16	16

SIMATIC S7-300 Advanced Controllers

Central processing units

Compact CPUs

Technical specifications (continued)

Article number	6ES7314-6BH04-0AB0 CPU314C-2PTP, 24DI/16DO/5AI/2AO, 192 KB	6ES7314-6CH04-0AB0 CPU314C-2DP, 24DI/16DO/5AI/2AO, 192 KB	6ES7314-6EH04-0AB0 CPU314C-2PN/DP, 24DI/16DO/4AI/2AO, 192KB
Analog inputs			
integrated channels (AI)	5; 4 x current/voltage, 1 x resistance	5; 4 x current/voltage, 1 x resistance	5; 4 x current/voltage, 1 x resistance
Input ranges			
• Voltage	Yes; $\pm 10\text{ V} / 100\text{ k}\Omega$; 0 V to 10 V / 100 k Ω	Yes; $\pm 10\text{ V} / 100\text{ k}\Omega$; 0 V to 10 V / 100 k Ω	Yes; $\pm 10\text{ V} / 100\text{ k}\Omega$; 0 V to 10 V / 100 k Ω
• Current	Yes; $\pm 20\text{ mA} / 100\ \Omega$; 0 mA to 20 mA / 100 Ω ; 4 mA to 20 mA / 100 Ω	Yes; $\pm 20\text{ mA} / 100\ \Omega$; 0 mA to 20 mA / 100 Ω ; 4 mA to 20 mA / 100 Ω	Yes; $\pm 20\text{ mA} / 100\ \Omega$; 0 mA to 20 mA / 100 Ω ; 4 mA to 20 mA / 100 Ω
• Resistance thermometer	Yes; Pt 100 / 10 M Ω	Yes; Pt 100 / 10 M Ω	Yes; Pt 100 / 10 M Ω
• Resistance	Yes; 0 Ω to 600 Ω / 10 M Ω	Yes; 0 Ω to 600 Ω / 10 M Ω	Yes; 0 Ω to 600 Ω / 10 M Ω
Analog outputs			
integrated channels (AO)	2	2	2
Output ranges, voltage			
• 0 to 10 V	Yes	Yes	Yes
• -10 V to +10 V	Yes	Yes	Yes
Output ranges, current			
• 0 to 20 mA	Yes	Yes	Yes
• -20 mA to +20 mA	Yes	Yes	Yes
• 4 mA to 20 mA	Yes	Yes	Yes
1. Interface			
Interface type	Integrated RS 485 interface	Integrated RS 485 interface	Integrated RS 485 interface
Physics	RS 485	RS 485	RS 485
Functionality			
• MPI	Yes	Yes	Yes
• PROFIBUS DP master	No	No	Yes
• PROFIBUS DP slave	No	No	Yes
• Point-to-point connection	No	No	No
DP master			
• Number of DP slaves, max.			124
2. Interface			
Interface type	Integrated RS 422/ 485 interface	Integrated RS 485 interface	PROFINET
Physics	RS 422/RS 485 (X.27)	RS 485	Ethernet RJ45
Interface types			
• Number of ports			2
Functionality			
• MPI	No	No	No
• PROFINET IO Controller	No	No	Yes; Also simultaneously with IO-Device functionality
• PROFINET IO Device	No	No	Yes; Also simultaneously with IO Controller functionality
• PROFINET CBA	No	No	Yes
• PROFIBUS DP master	No	Yes	No
• PROFIBUS DP slave	No	Yes	No
DP master			
• Number of DP slaves, max.		124	
Isochronous mode			
Isochronous operation (application synchronized up to terminal)			Yes; For PROFINET only
Communication functions			
PG/OP communication	Yes	Yes	Yes
Data record routing	No	Yes	Yes
Global data communication			
• supported	Yes	Yes	Yes

Technical specifications (continued)

Article number	6ES7314-6BH04-0AB0 CPU314C-2PTP, 24DI/16DO/5AI/2AO, 192 KB	6ES7314-6CH04-0AB0 CPU314C-2DP, 24DI/16DO/5AI/2AO, 192 KB	6ES7314-6EH04-0AB0 CPU314C-2PN/DP, 24DI/16DO/4AI/2AO, 192KB
S7 basic communication			
• supported	Yes	Yes	Yes
S7 communication			
• supported	Yes	Yes	Yes
S5 compatible communication			
• supported	Yes; via CP and loadable FC	Yes; via CP and loadable FC	Yes; via CP and loadable FC
Open IE communication			
• TCP/IP			Yes; via integrated PROFINET interface and loadable FBs
- Number of connections, max.			8
• ISO-on-TCP (RFC1006)			Yes; via integrated PROFINET interface and loadable FBs
- Number of connections, max.			8
• UDP			Yes; via integrated PROFINET interface and loadable FBs
- Number of connections, max.			8
Web server			
• supported			Yes
Number of connections			
• overall	12	12	12
Integrated Functions			
Number of counters	4; See "Technological Functions" manual	4; See "Technological Functions" manual	4; See "Technological Functions" manual
Counting frequency (counter) max.	60 kHz	60 kHz	60 kHz
Frequency measurement	Yes	Yes	Yes
Number of frequency meters	4; up to 60 kHz (see "Technological Functions" manual)	4; up to 60 kHz (see "Technological Functions" manual)	4; up to 60 kHz (see "Technological Functions" manual)
controlled positioning	Yes	Yes	Yes
integrated function blocks (closed-loop control)	Yes; PID controller (see "Technological Functions" manual)	Yes; PID controller (see "Technological Functions" manual)	Yes; PID controller (see "Technological Functions" manual)
PID controller	Yes	Yes	Yes
Number of pulse outputs	4; Pulse width modulation up to 2.5 kHz (see "Technological Functions" Manual)	4; Pulse width modulation up to 2.5 kHz (see "Technological Functions" Manual)	4; Pulse width modulation up to 2.5 kHz (see "Technological Functions" Manual)
Limit frequency (pulse)	2.5 kHz	2.5 kHz	2.5 kHz
Ambient conditions			
Ambient temperature during operation			
• min.	0 °C	0 °C	0 °C
• max.	60 °C	60 °C	60 °C
Configuration			
Programming			
Programming language			
- LAD	Yes	Yes	Yes
- FBD	Yes	Yes	Yes
- STL	Yes	Yes	Yes
- SCL	Yes	Yes	Yes
- CFC	Yes	Yes	Yes
- GRAPH	Yes	Yes	Yes
- HiGraph®	Yes	Yes	Yes
Know-how protection			
• User program protection/password protection	Yes	Yes	Yes
• Block encryption	Yes; With S7 block Privacy	Yes; With S7 block Privacy	Yes; With S7 block Privacy
Dimensions			
Width	120 mm	120 mm	120 mm
Height	125 mm	125 mm	125 mm
Depth	130 mm	130 mm	130 mm
Weights			
Weight, approx.	680 g	680 g	730 g

SIMATIC S7-300 Advanced Controllers

Central processing units

Compact CPUs

Ordering data	Article No.	Ordering data	Article No.
CPU 312C Compact CPU, work memory 64 KB, supply voltage 24 V DC, 10 DI/6 DQ integrated, integrated functions, MPI; including slot number labels; MMC required	6ES7312-5BF04-0AB0	Point-to-point link cable For connection to CPU 31xC-2 PtP	
CPU 313C Compact CPU, work memory 128 KB, supply voltage 24 V DC, 24 DI/16 DQ, 4 AI/2 AQ integrated, integrated functions, MPI; MMC required	6ES7313-5BG04-0AB0	5 m 10 m 50 m	6ES7902-3AB00-0AA0 6ES7902-3AC00-0AA0 6ES7902-3AG00-0AA0
CPU 313C-2 PtP Compact CPU, work memory 128 KB, supply voltage 24 V DC, 16 DI/16 DQ integrated, integrated functions, MPI, RS 422/485 interface; MMC required	6ES7313-6BG04-0AB0	Front connector (1 unit) For compact CPUs	
CPU 313C-2 DP Compact CPU, 128 KB work memory, 24 V DC power supply, 16 DI/16 DQ integrated, integrated functions, MPI, PROFIBUS DP master/slave interface; MMC required	6ES7313-6CG04-0AB0	40-pin, with screw contacts • 1 unit • 100 units	6ES7392-1AM00-0AA0 6ES7392-1AM00-1AB0
CPU 314C-2 PtP Compact CPU, work memory 192 KB, supply voltage 24 V DC, 24 DI/16 DQ/4 AI/2 AQ integrated, integrated functions, MPI, RS 422/485 interface; MMC required	6ES7314-6BH04-0AB0	40-pin, with spring-loaded contacts • 1 unit • 100 units	6ES7392-1BM01-0AA0 6ES7392-1BM01-1AB0
CPU 314C-2 DP Compact CPU, work memory 192 KB, supply voltage 24 V DC, 24 DI/16 DQ/4 AI/2 AQ integrated, integrated functions, MPI, PROFIBUS DP master/slave interface; MMC required	6ES7314-6CH04-0AB0	SIMATIC TOP connect	See page 5/248; for information about which components can be used for the respective module, see Industry Mall
CPU 314C-2 PNDP Compact CPU, 192 KB work memory, 24 V DC power supply, 24 DI/16 DO/4 AI/2 AQ integrated, integrated functions, MPI; PROFIBUS DP master/slave interface; PROFINET IO controller/ I-device interface, MMC is required	6ES7314-6EH04-0AB0	Front door, elevated design	6ES7328-7AA20-0AA0
SIMATIC Micro Memory Card		Slot number plates	6ES7912-0AA00-0AA0
64 KB	6ES7953-8LF31-0AA0	SIMATIC Manual Collection	6ES7998-8XC01-8YE0
128 KB	6ES7953-8LG31-0AA0	Electronic manuals on DVD, multilingual: LOGO!, SIMADYN, SIMATIC bus components, SIMATIC C7, SIMATIC distributed I/O, SIMATIC HMI, SIMATIC Sensors, SIMATIC NET, SIMATIC PC Based Automation, SIMATIC PCS 7, SIMATIC PG/PC, SIMATIC S7, SIMATIC Software, SIMATIC TDC	
512 KB	6ES7953-8LJ31-0AA0	SIMATIC Manual Collection update service for 1 year	6ES7998-8XC01-8YE2
2 MB	6ES7953-8LL31-0AA0	Current "Manual Collection" DVD and the three subsequent updates	
4 MB	6ES7953-8LM31-0AA0	Power supply connector	6ES7391-1AA00-0AA0
8 MB	6ES7953-8LP31-0AA0	10 units, spare part	
MPI cable	6ES7901-0BF00-0AA0	Labeling strips	6ES7392-2XX00-0AA0
For connection of SIMATIC S7 and PG via MPI; 5 m in length		10 units, spare part	
		Label cover	6ES7392-2XY00-0AA0
		10 units, spare part	

Ordering data	Article No.	Ordering data	Article No.
Labeling sheets for machine inscription for modules with 40-pin front connector, DIN A4, for printing with laser printer; 10 units Petrol Light beige Yellow Red	6ES7392-2AX10-0AA0 6ES7392-2BX10-0AA0 6ES7392-2CX10-0AA0 6ES7392-2DX10-0AA0	PROFINET bus components IE FC TP Standard Cable GP 2x2 4-wire, shielded TP installation cable for connection to IE FC Outlet RJ45/IE FC RJ45 Plug; PROFINET-compatible; with UL approval; Sold by the meter: Max. delivery unit 1000 m (3281 ft) minimum order quantity 20 m (65.62 ft)	6XV1840-2AH10
USB A2 PC adapter for connecting a PG/PC or Notebook to PROFIBUS or MPI; USB cable included in scope of delivery	6GK1571-0BA00-0AA0	FO Standard Cable GP (50/125) Standard cable, splittable, UL approval, sold by the meter Max. delivery unit 1000 m (3281 ft) minimum order quantity 20 m (65.62 ft)	6XV1873-2A
PROFIBUS DP RS 485 bus connector <ul style="list-style-type: none"> with 90° cable outlet, max. transfer rate 12 Mbps <ul style="list-style-type: none"> without PG interface with PG interface with 90° cable outlet for FastConnect connection system, max. transfer rate 12 Mbps <ul style="list-style-type: none"> without PG interface, 1 unit without PG interface, 100 units with PG interface, 1 unit with PG interface, 100 units with axial cable outlet for SIMATIC OP, for connecting to PPI, MPI, PROFIBUS 	6ES7972-0BA12-0XA0 6ES7972-0BB12-0XA0 6ES7972-0BA52-0XA0 6ES7972-0BA52-0XB0 6ES7972-0BB52-0XA0 6ES7972-0BB52-0XB0 6GK1500-0EA02	SCALANCE X204-2 Industrial Ethernet switch Industrial Ethernet switches with integral SNMP access, web diagnostics, copper cable diagnostics and PROFINET diagnostics for configuring line, star and ring topologies; four 10/100 Mbps RJ45 ports and two FO ports	6GK5204-2BB10-2AA3
PROFIBUS FastConnect bus cable Standard type with special design for quick mounting, 2-wire, shielded, sold by the meter, max. delivery unit 1000 m, minimum ordering quantity 20 m	6XV1830-0EH10	CSM 377 Compact Switch Module Unmanaged switch for connecting a SIMATIC S7-300, ET 200M and up to three other stations to Industrial Ethernet with 10/100 Mbps; 4 x RJ45 ports; external 24 V DC power supply, LED diagnostics, S7-300 module incl. electronic manual on CD-ROM	6GK7377-1AA00-0AA0
RS 485 repeater for PROFIBUS Transmission rate up to 12 Mbps; 24 V DC; IP20 enclosure	6ES7972-0AA02-0XA0	IE FC RJ45 plugs RJ45 plug connector for Industrial Ethernet with a rugged metal enclosure and integrated insulation displacement contacts for connecting Industrial Ethernet FC installation cables	
		IE FC RJ45 Plug 180 180° cable outlet 1 unit 10 units 50 units	6GK1901-1BB10-2AA0 6GK1901-1BB10-2AB0 6GK1901-1BB10-2AE0
		PROFIBUS/PROFINET bus components For establishing MPI/PROFIBUS/PROFINET communication	See Catalogs IK PI, CA 01

SIMATIC S7-300 Advanced Controllers

Central processing units

SIPLUS S7-300 compact CPUs

Overview SIPLUS S7-300 CPU 312C



- The compact CPU with integral digital inputs/outputs
- For small applications with increased processing performance requirements
- With technological functions

Micro Memory Card required for operation of CPU.

Note:

SIPLUS extreme products are based on SIMATIC standard products. The contents listed here were taken from the respective standard products. SIPLUS extreme-specific information was added.

Overview SIPLUS S7-300 CPU 313C-2 DP



- The compact CPU with integral digital inputs/outputs and PROFIBUS DP master/slave interface
- With technological functions
- For tasks with special functions
- For connecting distributed I/O

Micro Memory Card required for operation of CPU.

Note:

SIPLUS extreme products are based on SIMATIC standard products. The contents listed here were taken from the respective standard products. SIPLUS extreme-specific information was added.

Overview SIPLUS S7-300 CPU 313C



- The compact CPU with integral digital and analog inputs/outputs
- For plants with high processing performance and response time requirements
- With technological functions

Micro Memory Card required to operate the CPU.

Note:

SIPLUS extreme products are based on Siemens Industry standard products. The contents listed here were taken from the respective standard products. SIPLUS extreme-specific information was added.

Overview SIPLUS S7-300 CPU 314C-2 PtP



- The compact CPU with integrated digital and analog inputs/outputs as well as second serial interface
- For plants with high processing performance and response time requirements
- With technological functions

SIMATIC Micro Memory Card required for operation of CPU.

Note:

SIPLUS extreme products are based on SIMATIC standard products. The contents listed here were taken from the respective standard products. SIPLUS extreme-specific information was added.

SIMATIC S7-300 Advanced Controllers

Central processing units

SIPLUS S7-300 compact CPUs

Overview SIPLUS S7-300 CPU 314C-2 DP



- The compact CPU with integral digital and analog inputs/outputs and PROFIBUS DP master/slave interface
- With technological functions
- For tasks with special functions
- For connecting distributed I/O

Micro Memory Card required for operation of CPU.

Note:

SIPLUS extreme products are based on SIMATIC standard products. The contents listed here were taken from the respective standard products. SIPLUS extreme-specific information was added.

Overview SIPLUS S7-300 CPU 314C-2 PN/DP



- The compact CPU with integral digital and analog inputs/outputs and technological functions
- High processing performance in binary and floating-point arithmetic
- For connecting distributed I/O via PROFIBUS and PROFINET
- Combined MPI/PROFIBUS DP master/slave interface
- PROFINET interface with 2-port switch
- PROFINET IO controller for operating distributed I/O on PROFINET
- PROFINET I-device for connecting the CPU as intelligent PROFINET device under a SIMATIC or third-party PROFINET IO controller
- Component Based Automation (CBA) on PROFINET
- PROFINET proxy for intelligent devices on PROFIBUS DP in Component Based Automation (CBA)
- Integrated web server with the option of creating user-defined web pages
- Isochronous mode on PROFINET

SIMATIC Micro Memory Card required for operation of CPU.

Note:

SIPLUS extreme products are based on SIMATIC standard products. The contents listed here were adopted from the respective standard products. SIPLUS extreme specific information was added.

SIMATIC S7-300 Advanced Controllers

Central processing units

SIPLUS S7-300 compact CPUs

Technical specifications

Article number	6AG1312-5BF04-2AY0	6AG1312-5BF04-7AB0	6AG1313-5BG04-2AY0	6AG1313-5BG04-7AB0
Based on	6ES7312-5BF04-0AB0 SIPLUS S7-300 CPU312C EN50155	6ES7312-5BF04-0AB0 SIPLUS S7-300 CPU312C	6ES7313-5BG04-0AB0 SIPLUS S7-300 CPU313C EN50155	6ES7313-5BG04-0AB0 SIPLUS S7-300 CPU313C
Ambient conditions				
Ambient temperature during operation				
• min.	-25 °C; = Tmin	-25 °C; = Tmin	-25 °C; = Tmin	-25 °C; = Tmin
• max.	60 °C; = Tmax; the rated temperature range of -25 ... +55 °C (T1) applies for the use on railway vehicles according to EN50155	70 °C; = Tmax; 60 °C @ UL/cUL, ATEX and FM use	60 °C; = Tmax; the rated temperature range of -25 ... +55 °C (T1) applies for the use on railway vehicles according to EN50155	70 °C; = Tmax; 60 °C @ UL/cUL, ATEX and FM use
Ambient temperature during storage/transportation				
• min.	-40 °C	-40 °C	-40 °C	-40 °C
• max.	70 °C	70 °C	70 °C	70 °C
Extended ambient conditions				
• relative to ambient temperature-atmospheric pressure-installation altitude	Tmin ... Tmax at 1080 hPa ... 795 hPa (-1000 m ... +2000 m) // Tmin ... (Tmax - 10K) at 795 hPa ... 658 hPa (+2000 m ... +3500 m) // Tmin ... (Tmax - 20K) at 658 hPa ... 540 hPa (+3500 m ... +5000 m)	Tmin ... Tmax at 1080 hPa ... 795 hPa (-1000 m ... +2000 m) // Tmin ... (Tmax - 10K) at 795 hPa ... 658 hPa (+2000 m ... +3500 m) // Tmin ... (Tmax - 20K) at 658 hPa ... 540 hPa (+3500 m ... +5000 m)	Tmin ... Tmax at 1080 hPa ... 795 hPa (-1000 m ... +2000 m) // Tmin ... (Tmax - 10K) at 795 hPa ... 658 hPa (+2000 m ... +3500 m) // Tmin ... (Tmax - 20K) at 658 hPa ... 540 hPa (+3500 m ... +5000 m)	Tmin ... Tmax at 1080 hPa ... 795 hPa (-1000 m ... +2000 m) // Tmin ... (Tmax - 10K) at 795 hPa ... 658 hPa (+2000 m ... +3500 m) // Tmin ... (Tmax - 20K) at 658 hPa ... 540 hPa (+3500 m ... +5000 m)
Relative humidity				
- With condensation, tested in accordance with IEC 60068-2-38, max.	100 %; RH incl. condensation / frost (no commissioning in bedewed state), horizontal installation	100 %; RH incl. condensation/frost (no commissioning under condensation conditions)	100 %; RH incl. condensation / frost (no commissioning in bedewed state), horizontal installation	100 %; RH incl. condensation/frost (no commissioning under condensation conditions)
Resistance				
- against biologically active substances / conformity with EN 60721-3-3	Yes; Class 3B2 mold, fungus and dry rot spores (with the exception of fauna). The supplied connector covers must remain on the unused interfaces during operation in corrosive atmospheres!	Yes; Class 3B2 mold, fungus and dry rot spores (with the exception of fauna). The supplied connector covers must remain on the unused interfaces during operation!	Yes; Class 3B2 mold, fungus and dry rot spores (with the exception of fauna). The supplied connector covers must remain on the unused interfaces during operation in corrosive atmospheres!	Yes; Class 3B2 mold, fungus and dry rot spores (with the exception of fauna). The supplied connector covers must remain on the unused interfaces during operation!
- against chemically active substances / conformity with EN 60721-3-3	Yes; Class 3C4 (RH < 75%) incl. salt spray according to EN 60068-2-52 (degree of severity 3). The supplied connector covers must remain on the unused interfaces during operation!	Yes; Class 3C4 (RH < 75%) incl. salt spray according to EN 60068-2-52 (degree of severity 3). The supplied connector covers must remain on the unused interfaces during operation!	Yes; Class 3C4 (RH < 75%) incl. salt spray according to EN 60068-2-52 (degree of severity 3). The supplied connector covers must remain on the unused interfaces during operation!	Yes; Class 3C4 (RH < 75%) incl. salt spray according to EN 60068-2-52 (degree of severity 3). The supplied connector covers must remain on the unused interfaces during operation!
- against mechanically active substances / conformity with EN 60721-3-3	Yes; Class 3S4 incl. sand, dust. The supplied connector covers must remain on the unused interfaces during operation!	Yes; Class 3S4 incl. sand, dust. The supplied connector covers must remain on the unused interfaces during operation!	Yes; Class 3S4 incl. sand, dust. The supplied connector covers must remain on the unused interfaces during operation!	Yes; Class 3S4 incl. sand, dust. The supplied connector covers must remain on the unused interfaces during operation!

SIMATIC S7-300 Advanced Controllers

Central processing units

SIPLUS S7-300 compact CPUs

Technical specifications (continued)

Article number	6AG1313-6CG04-2AY0	6AG1313-6CG04-7AB0	6AG1314-6BH04-7AB0
Based on	6ES7313-6CG04-0AB0 SIPLUS S7-300 CPU313C-2DP EN50155	6ES7313-6CG04-0AB0 SIPLUS S7-300 CPU313C-2DP	6ES7314-6BH04-0AB0 SIPLUS S7-300 CPU314C-2 PtP
Ambient conditions			
Ambient temperature during operation			
• min.	-25 °C; = Tmin	-25 °C; = Tmin	-25 °C; = Tmin
• max.	70 °C; = Tmax; the rated temperature range of -25 ... +55 °C (T1) applies for the use on railway vehicles according to EN50155	70 °C; = Tmax; 60 °C @ UL/cUL, ATEX and FM use	70 °C; = Tmax; 60 °C @ UL/cUL, ATEX and FM use
Ambient temperature during storage/transportation			
• min.	-40 °C	-40 °C	-40 °C
• max.	70 °C	70 °C	70 °C
Extended ambient conditions			
• relative to ambient temperature-atmospheric pressure-installation altitude		Tmin ... Tmax at 1080 hPa ... 795 hPa (-1000 m ... +2000 m) // Tmin ... (Tmax - 10K) at 795 hPa ... 658 hPa (+2000 m ... +3500 m) // Tmin ... (Tmax - 20K) at 658 hPa ... 540 hPa (+3500 m ... +5000 m)	Tmin ... Tmax at 1080 hPa ... 795 hPa (-1000 m ... +2000 m) // Tmin ... (Tmax - 10K) at 795 hPa ... 658 hPa (+2000 m ... +3500 m) // Tmin ... (Tmax - 20K) at 658 hPa ... 540 hPa (+3500 m ... +5000 m)
Relative humidity			
- With condensation, tested in accordance with IEC 60068-2-38, max.	100 %; RH incl. condensation / frost (no commissioning in bedewed state), horizontal installation	100 %; RH incl. condensation/frost (no commissioning under condensation conditions)	100 %; RH incl. condensation/frost (no commissioning under condensation conditions)
Resistance			
- against biologically active substances / conformity with EN 60721-3-3	Yes; Class 3B2 mold, fungus and dry rot spores (with the exception of fauna). The supplied connector covers must remain on the unused interfaces during operation!	Yes; Class 3B2 mold, fungus and dry rot spores (with the exception of fauna). The supplied connector covers must remain on the unused interfaces during operation!	Yes; Class 3B2 mold, fungus and dry rot spores (with the exception of fauna). The supplied connector covers must remain on the unused interfaces during operation!
- against chemically active substances / conformity with EN 60721-3-3	Yes; Class 3C4 (RH < 75%) incl. salt spray according to EN 60068-2-52 (degree of severity 3). The supplied connector covers must remain on the unused interfaces during operation!	Yes; Class 3C4 (RH < 75%) incl. salt spray according to EN 60068-2-52 (degree of severity 3). The supplied connector covers must remain on the unused interfaces during operation!	Yes; Class 3C4 (RH < 75%) incl. salt spray according to EN 60068-2-52 (degree of severity 3). The supplied connector covers must remain on the unused interfaces during operation!
- against mechanically active substances / conformity with EN 60721-3-3	Yes; Class 3S4 incl. sand, dust. The supplied connector covers must remain on the unused interfaces during operation!	Yes; Class 3S4 incl. sand, dust. The supplied connector covers must remain on the unused interfaces during operation!	Yes; Class 3S4 incl. sand, dust. The supplied connector covers must remain on the unused interfaces during operation!

SIMATIC S7-300 Advanced Controllers

Central processing units

SIPLUS S7-300 compact CPUs

Technical specifications (continued)

Article number	6AG1314-6CH04-2AY0	6AG1314-6CH04-7AB0	6AG1314-6EH04-7AB0
Based on	6ES7314-6CH04-0AB0 SIPLUS S7-300 CPU314C-2DP EN50155	6ES7314-6CH04-0AB0 SIPLUS S7-300 CPU314C-2DP	6ES7314-6EH04-0AB0 SIPLUS S7-300 CPU314C-2PN/DP
Ambient conditions			
Ambient temperature during operation			
• min.	-25 °C; = Tmin	-25 °C; = Tmin	-25 °C; = Tmin
• max.	60 °C; = Tmax; the rated temperature range of -25 ... +55 °C (T1) applies for the use on railway vehicles according to EN50155	70 °C; = Tmax; 60 °C @ UL/cUL, ATEX and FM use	70 °C; = Tmax; @ 60°C for UL/ATEX/FM use
Ambient temperature during storage/transportation			
• min.	-40 °C	-40 °C	-40 °C
• max.	70 °C	70 °C	70 °C
Extended ambient conditions			
• relative to ambient temperature-atmospheric pressure-installation altitude		Tmin ... Tmax at 1080 hPa ... 795 hPa (-1000 m ... +2000 m) // Tmin ... (Tmax - 10K) at 795 hPa ... 658 hPa (+2000 m ... +3500 m) // Tmin ... (Tmax - 20K) at 658 hPa ... 540 hPa (+3500 m ... +5000 m)	Tmin ... Tmax at 1080 hPa ... 795 hPa (-1000 m ... +2000 m) // Tmin ... (Tmax - 10K) at 795 hPa ... 658 hPa (+2000 m ... +3500 m) // Tmin ... (Tmax - 20K) at 658 hPa ... 540 hPa (+3500 m ... +5000 m)
Relative humidity			
- With condensation, tested in accordance with IEC 60068-2-38, max.	100 %; RH incl. condensation / frost (no commissioning in bedwired state), horizontal installation	100 %; RH incl. condensation/frost (no commissioning under condensation conditions)	100 %; RH incl. condensation/frost (no commissioning under condensation conditions)
Resistance			
- against biologically active substances / conformity with EN 60721-3-3	Yes; Class 3B2 mold, fungus and dry rot spores (with the exception of fauna). The supplied connector covers must remain on the unused interfaces during operation in corrosive atmospheres!	Yes; Class 3B2 mold, fungus and dry rot spores (with the exception of fauna). The supplied connector covers must remain on the unused interfaces during operation!	Yes; Class 3B2 mold, fungus and dry rot spores (with the exception of fauna). The supplied connector covers must remain on the unused interfaces during operation!
- against chemically active substances / conformity with EN 60721-3-3	Yes; Class 3C4 (RH < 75%) incl. salt spray according to EN 60068-2-52 (degree of severity 3). The supplied connector covers must remain on the unused interfaces during operation!	Yes; Class 3C4 (RH < 75%) incl. salt spray according to EN 60068-2-52 (degree of severity 3). The supplied connector covers must remain on the unused interfaces during operation!	Yes; Class 3C4 (RH < 75%) incl. salt spray according to EN 60068-2-52 (degree of severity 3). The supplied connector covers must remain on the unused interfaces during operation!
- against mechanically active substances / conformity with EN 60721-3-3	Yes; Class 3S4 incl. sand, dust. The supplied connector covers must remain on the unused interfaces during operation!	Yes; Class 3S4 incl. sand, dust. The supplied connector covers must remain on the unused interfaces during operation!	Yes; Class 3S4 incl. sand, dust. The supplied connector covers must remain on the unused interfaces during operation!

SIMATIC S7-300 Advanced Controllers

Central processing units

SIPLUS S7-300 compact CPUs

Ordering data	Article No.	Article No.	
<p>SIPLUS S7-300 CPU 312C</p> <p><i>For industrial applications with extended ambient conditions</i></p> <p>Compact CPU, work memory 64 KB, 24 V DC power supply, 10 DI/6 DQ integrated, integrated functions, MPI; including slot number labels; MMC required</p> <p>Extended temperature range and exposure to media</p> <p><i>For rolling stock railway applications</i></p> <p>Compact CPU, work memory 64 KB, 24 V DC power supply, 10 DI/6 DQ integrated, integrated functions, MPI; including slot number labels; MMC required</p> <p>Conforms to EN 50155</p>	6AG1312-5BF04-7AB0	<p>SIPLUS S7-300 CPU 314C-2 PtP</p> <p><i>For industrial applications with extended ambient conditions</i></p> <p>Compact CPU, work memory 192 KB, 24 V DC power supply, 24 DI/16 DQ, 4 AI/2 AQ integrated, integrated functions, MPI, RS 422/485 interface; MMC required</p> <p>Extended temperature range and exposure to media</p>	6AG1314-6BH04-7AB0
<p>SIPLUS S7-300 CPU 313C</p> <p><i>For industrial applications with extended ambient conditions</i></p> <p>Compact CPU, work memory 128 KB, supply voltage 24 V DC, 24 DI/16 DQ, 4 AI/2 AQ integrated, integrated functions, MPI; MMC required</p> <p>Extended temperature range and exposure to media</p> <p><i>For rolling stock railway applications</i></p> <p>Compact CPU, work memory 128 KB, supply voltage 24 V DC, 24 DI/16 DQ, 4 AI/2 AQ integrated, integrated functions, MPI; MMC required</p> <p>Conforms to EN 50155</p>	6AG1313-5BG04-7AB0	<p>SIPLUS S7-300 CPU 314C-2 DP</p> <p><i>For industrial applications with extended ambient conditions</i></p> <p>Compact CPU, work memory 192 KB, 24 V DC power supply, 24 DI/16 DQ, 4 AI/2 AQ integrated, integrated functions, MPI, PROFIBUS DP master/slave interface; MMC required</p> <p>Extended temperature range and exposure to media</p> <p><i>For rolling stock railway applications</i></p> <p>Compact CPU, work memory 192 KB, 24 V DC power supply, 24 DI/16 DQ, 4 AI/2 AQ integrated, integrated functions, MPI, PROFIBUS DP master/slave interface; MMC required</p> <p>Conforms to EN 50155</p>	6AG1314-6CH04-7AB0
<p>SIPLUS S7-300 CPU 313C-2 DP</p> <p><i>For industrial applications with extended ambient conditions</i></p> <p>Compact CPU, work memory 128 KB, power supply 24 V DC, 16 DI/16 DQ integrated, integrated functions, MPI, PROFIBUS DP master/slave interface; MMC required</p> <p>Extended temperature range and exposure to media</p> <p><i>For rolling stock railway applications</i></p> <p>Compact CPU, work memory 128 KB, power supply 24 V DC, 16 DI/16 DQ integrated, integrated functions, MPI, PROFIBUS DP master/slave interface; MMC required</p> <p>Conforms to EN 50155</p>	6AG1313-6CG04-7AB0	<p>SIPLUS S7-300 CPU 314C-2 PN/DP</p> <p><i>For industrial applications with extended environmental conditions</i></p> <p>Compact CPU, work memory 192 KB, 24 V DC supply voltage, 24 DI/16 DQ, 4 AI/2 AQ integrated, integrated functions, MPI; PROFIBUS DP master/slave interface; PROFINET IO controller/I-device interface, MMC is required</p> <p>Extended temperature range and exposure to media</p>	6AG1314-6EH04-7AB0
		<p>Accessories</p> <p><i>Mandatory</i></p> <p>SIMATIC Micro Memory Card</p> <p>64 KB 6ES7953-8LF31-0AA0</p> <p>128 KB 6ES7953-8LG31-0AA0</p> <p>512 KB 6ES7953-8LJ31-0AA0</p> <p>2 MB 6ES7953-8LL31-0AA0</p> <p>4 MB 6ES7953-8LM31-0AA0</p> <p>8 MB 6ES7953-8LP31-0AA0</p>	
		<p>Front connector (1 unit)</p> <p>For compact CPUs</p> <p>40-pin, with spring-loaded contacts</p> <ul style="list-style-type: none"> • 1 unit 6ES7392-1BM01-0AA0 • 100 units 6ES7392-1BM01-1AB0 	

SIMATIC S7-300 Advanced Controllers

Central processing units

SIPLUS S7-300 compact CPUs

Ordering data	Article No.	Ordering data	Article No.
<p><i>For communication within the application</i></p> <p>PROFIBUS DP RS 485 bus connector</p> <p>(extended temperature range and exposure to media)</p> <p>With 90° cable outlet, max. transfer rate 12 Mbps</p> <ul style="list-style-type: none"> Without PG interface With PG interface <p>With angled cable outlet, max. transfer rate 12 Mbps</p> <ul style="list-style-type: none"> without PG interface with PG interface <p>(extended temperature range)</p> <p>With axial cable outlet for SIMATIC OP, for connecting to PPI, MPI, PROFIBUS</p>	<p>6AG1972-0BA12-2XA0</p> <p>6AG1972-0BB12-2XA0</p> <p>6AG1972-0BA42-7XA0</p> <p>6AG1972-0BB42-7XA0</p> <p>6AG1500-0EA02-2AA0</p>	<p>RS 485 repeater for PROFIBUS</p> <p>(extended temperature range and exposure to media)</p> <p>Transmission rate up to 12 Mbps; 24 V DC; IP20 enclosure</p> <p>Point-to-point link cable</p> <p>For connection to CPU 31xC-2 PtP</p> <p>5 m</p> <p>10 m</p> <p>50 m</p> <p><i>For commissioning</i></p> <p>MPI cable</p> <p>For connection of SIMATIC S7 and PG via MPI; length 5 m</p> <p>USB A2 PC adapter</p>	<p>6AG1972-0AA02-7XA0</p> <p>6ES7902-3AB00-0AA0</p> <p>6ES7902-3AC00-0AA0</p> <p>6ES7902-3AG00-0AA0</p> <p>6ES7901-0BF00-0AA0</p> <p>6GK1571-0BA00-0AA0</p>
<p>IE FC RJ45 Plug 180</p> <p>(extended temperature range and exposure to media)</p> <p>180° cable outlet</p> <ul style="list-style-type: none"> 1 unit 	<p>6AG1901-1BB10-7AA0</p>	<p><i>Consumables</i></p> <p>Front door, elevated design</p> <p>For compact CPUs; for connecting 1.3 mm²/16 AWG wires; wiring diagram and labels in petrol</p> <p>Power supply connector</p> <p>10 units, spare part</p> <p>Slot number plates</p> <p>Labeling strips</p> <p>10 units, spare part</p> <p>Label cover</p> <p>10 units, spare part</p> <p>Labeling sheets for machine inscription</p> <p>For modules with 40-pin front connector, DIN A4, for printing with laser printer; 10 units</p> <p>Petrol</p> <p>Light beige</p> <p>Yellow</p> <p>Red</p>	<p>6ES7328-7AA20-0AA0</p> <p>6ES7391-1AA00-0AA0</p> <p>6ES7912-0AA00-0AA0</p> <p>6ES7392-2XX00-0AA0</p> <p>6ES7392-2XY00-0AA0</p> <p>6ES7392-2AX10-0AA0</p> <p>6ES7392-2BX10-0AA0</p> <p>6ES7392-2CX10-0AA0</p> <p>6ES7392-2DX10-0AA0</p>
<p>SIPLUS SCALANCE X-200 Industrial Ethernet switches</p> <p>Industrial Ethernet switches with integral SNMP access, online diagnostics, copper cable diagnostics and PROFINET diagnostics for configuring line, star and ring topologies; with integrated redundancy manager (exception: SCALANCE X208PRO); incl. operating instructions, Industrial Ethernet network manual and configuration software on CD-ROM</p> <ul style="list-style-type: none"> With electrical and optical ports for glass multimode FOC up to 3 km Extended temperature range and exposure to media SIPLUS SCALANCE X204-2 With four 10/100 Mbps RJ45 ports and two fiber-optic ports 	<p>6AG1204-2BB10-4AA3</p>	<p><i>Documentation</i></p> <p>SIMATIC Manual Collection</p> <p>Electronic manuals on DVD, multilingual: LOGO!, SIMADYN, SIMATIC bus components, SIMATIC C7, SIMATIC distributed I/O, SIMATIC HMI, SIMATIC Sensors, SIMATIC NET, SIMATIC PC Based Automation, SIMATIC PCS 7, SIMATIC PG/PC, SIMATIC S7, SIMATIC Software, SIMATIC TDC</p> <p>SIMATIC Manual Collection update service for 1 year</p> <p>Current "Manual Collection" DVD and the three subsequent updates</p>	<p>6ES7998-8XC01-8YE0</p> <p>6ES7998-8XC01-8YE2</p>
<p>PROFIBUS FastConnect bus cable</p> <p>Standard type with special design for quick mounting, 2-wire, shielded, sold by the meter; max. length 1000 m, minimum ordering quantity 20 m</p>	<p>6XV1830-0EH10</p>		
<p>IE FC TP Standard Cable GP 2x2</p> <p>4-wire, shielded TP installation cable for connection to IE FC Outlet RJ45/IE FC RJ45 Plug; PROFINET-compatible; with UL approval</p> <p>Sold by the meter; max. length 1 000 m minimum order quantity 20 m</p>	<p>6XV1840-2AH10</p>		
<p>FO Standard Cable GP (50/125)</p> <p>Standard cable, splittable, UL approval, sold by the meter; max. length 1 000 m minimum order quantity 20 m</p>	<p>6XV1873-2A</p>		

SIMATIC S7-300 Advanced Controllers

Central processing units

Fail-safe CPUs

Overview CPU 315F-2 DP



- Based on the SIMATIC CPU 315-2 DP
- For setting up a fail-safe automation system in plants with increased safety requirements
- Complies with safety requirements to SIL 3 acc. to IEC 61508 and PL e acc. to ISO 13849.1
- Distributed fail-safe I/O modules can be connected locally via the integrated PROFIBUS DP interface (PROFIsafe)
- Fail-safe I/O modules of the ET 200M range can also be centrally connected
- Central and distributed use of standard modules for non safety-oriented applications

SIMATIC Micro Memory Card required for operation of CPU.

Overview CPU 315F-2 PN/DP



- Based on CPU 315-2 PN/DP
- The CPU with medium-sized program memory and quantity structures for setting up a fail-safe automation system in plants with increased safety requirements
- Complies with safety requirements to SIL 3 acc. to IEC 61508 and PL e acc. to ISO 13849.1
- Distributed fail-safe I/O modules can be locally connected via the integrated PROFINET interface (PROFIsafe) and/or via the integrated PROFIBUS DP interface (PROFIsafe)

- Fail-safe I/O modules of the ET 200M range can also be centrally connected
- Central and distributed use of standard modules for non safety-relevant applications
- Component Based Automation (CBA) on PROFINET
- PROFINET IO controller for operating distributed I/O on PROFINET
- PROFINET interface with 2-port switch
- PROFINET proxy for intelligent devices on PROFIBUS DP in Component Based Automation (CBA)

SIMATIC Micro Memory Card required for operation of CPU.

Overview CPU 317F-2 DP



- The fail-safe CPU with a large program memory and quantity framework for demanding applications
- For constructing a fail-safe automation system for plants with increased safety requirements
- Complies with safety requirements to SIL 3 acc. to IEC 61508 and PL e acc. to ISO 13849.1
- Fail-safe I/O modules can be connected in a distributed configuration to both integral PROFIBUS DP interfaces (PROFIsafe)
- Fail-safe I/O modules of the ET 200M range can also be centrally connected
- Standard modules for non-safety-related applications can be operated centrally and locally

SIMATIC Micro Memory Card required for operation of CPU.

SIMATIC S7-300 Advanced Controllers

Central processing units

Fail-safe CPUs

Overview CPU 317F-2 PN/DP



- Based on CPU 317-2 PN/DP
- The fail-safe CPU with a large program memory and quantity framework for demanding applications; for setting up a fail-safe automation system in plants with increased safety requirements.
- Complies with safety requirements to SIL 3 acc. to IEC 61508 and PL e acc. to ISO 13849.1
- Distributed fail-safe I/O modules can be locally connected via the integrated PROFINET interface (PROFIsafe) and/or via the integrated PROFIBUS DP interface (PROFIsafe)
- Fail-safe I/O modules of the ET 200M range can also be centrally connected
- Central and distributed use of standard modules for non safety-relevant applications
- Component Based Automation (CBA) on PROFINET
- PROFINET IO controller for operating distributed I/O on PROFINET
- PROFINET interface with 2-port switch
- PROFINET proxy for intelligent devices on PROFIBUS DP in Component Based Automation (CBA)

SIMATIC Micro Memory Card required for operation of CPU.

Overview CPU 319F-3 PN/DP



- The fail-safe CPU with high-performance command processing, large program memory and large quantity structure for demanding applications
- For constructing a fail-safe automation system for plants with increased safety requirements
- Complies with safety requirements to SIL 3 acc. to IEC 61508 and PL e acc. to 13849.1
- Distributed fail-safe I/O modules can be locally connected via the integrated PROFINET interface (PROFIsafe) and/or via the integrated PROFIBUS DP interface (PROFIsafe)
- Fail-safe I/O modules of ET200M can also be connected centrally
- Standard modules for non-safety-related applications can be operated centrally and locally
- Distributed intelligence in Component Based Automation (CBA) on PROFINET
- Isochronous mode on PROFIBUS
- PROFINET proxy for intelligent devices on PROFIBUS DP in Component Based Automation (CBA)

SIMATIC Micro Memory Card required for operation of CPU.

SIMATIC S7-300 Advanced Controllers

Central processing units

Fail-safe CPUs

Technical specifications

Article number	6ES7315-6FF04-0AB0	6ES7315-2FJ14-0AB0	6ES7317-6FF04-0AB0	6ES7317-2FK14-0AB0	6ES7318-3FL01-0AB0
	CPU315F, 384KB	CPU315F-2 PN/DP, 512 KB	CPU317F-2DP, 1.5 MB	CPU317F-2 PN/DP, 1.5 MB	CPU319F-3 PN/DP, 2.5 MB
General information					
Engineering with					
• Programming package	STEP 7 V5.5 + SP1 or higher or STEP 7 V5.2 + SP1 or higher with HSP 218 + Distributed Safety	STEP 7 V5.5 or higher, Distributed Safety V5.4 SP4	STEP 7 V5.5 + SP1 or higher or STEP 7 V5.2 + SP1 or higher with HSP 202 + Distributed Safety	STEP 7 V5.5 or higher, Distributed Safety V5.4 SP4	STEP 7 V5.5 or higher, Distributed Safety V5.4 SP4
Supply voltage					
Rated value (DC)					
• 24 V DC	Yes	Yes	Yes	Yes	Yes
Power loss					
Power loss, typ.	4.5 W	4.65 W	4.5 W	4.65 W	14 W
Memory					
Work memory					
• integrated	384 kbyte	512 kbyte	1 536 kbyte	1 536 kbyte	2 560 kbyte
• Size of retentive memory for retentive data blocks	128 kbyte	128 kbyte	256 kbyte	256 kbyte	700 kbyte
Load memory					
• Plug-in (MMC), max.	8 Mbyte	8 Mbyte	8 Mbyte	8 Mbyte	8 Mbyte
CPU processing times					
for bit operations, typ.	0.05 µs	0.05 µs	0.025 µs	0.025 µs	0.004 µs
for word operations, typ.	0.09 µs	0.09 µs	0.03 µs	0.03 µs	0.01 µs
for fixed point arithmetic, typ.	0.12 µs	0.12 µs	0.04 µs	0.04 µs	0.01 µs
for floating point arithmetic, typ.	0.45 µs	0.45 µs	0.16 µs	0.16 µs	0.04 µs
Counters, timers and their retentivity					
S7 counter					
• Number	256	256	512	512	2 048
IEC counter					
• present	Yes	Yes	Yes	Yes	Yes
S7 times					
• Number	256	256	512	512	2 048
IEC timer					
• present	Yes	Yes	Yes	Yes	Yes
Data areas and their retentivity					
Flag					
• Number, max.	2 048 byte	2 048 byte	4 096 byte	4 096 byte	8 192 byte
Address area					
I/O address area					
• Inputs	2 048 byte	2 048 byte	8 192 byte	8 192 byte	8 192 byte
• Outputs	2 048 byte	2 048 byte	8 192 byte	8 192 byte	8 192 byte
Process image					
• Inputs, adjustable	2 048 byte	2 048 byte	8 192 byte	8 192 byte	8 192 byte
• Outputs, adjustable	2 048 byte	2 048 byte	8 192 byte	8 192 byte	8 192 byte
Time of day					
Clock					
• Hardware clock (real-time)	Yes	Yes	Yes	Yes	Yes
Operating hours counter					
• Number	1	1	4	4	4

5

SIMATIC S7-300 Advanced Controllers

Central processing units

Fail-safe CPUs

Technical specifications (continued)

Article number	6ES7315-6FF04-0AB0 CPU315F, 384KB	6ES7315-2FJ14-0AB0 CPU315F-2 PN/DP, 512 KB	6ES7317-6FF04-0AB0 CPU317F-2DP, 1.5 MB	6ES7317-2FK14-0AB0 CPU317F-2 PN/DP, 1.5 MB	6ES7318-3FL01-0AB0 CPU319F-3 PN/DP, 2.5 MB
1. Interface					
Interface type	Integrated RS 485 interface	Integrated RS 485 interface	Integrated RS 485 interface	Integrated RS 485 interface	Integrated RS 485 interface
Physics	RS 485	RS 485	RS 485	RS 485	RS 485
Functionality					
• MPI	Yes	Yes	Yes	Yes	Yes
• PROFIBUS DP master	No	Yes	Yes	Yes	Yes
• PROFIBUS DP slave	No	Yes	Yes; A DP slave at both interfaces simultaneously is not possible	Yes	Yes; A DP slave at both interfaces simultaneously is not possible
• Point-to-point connection	No	No	No	No	No
DP master					
• Number of DP slaves, max.		124	124	124	124
2. Interface					
Interface type	Integrated RS 485 interface	PROFINET	Integrated RS 485 interface	PROFINET	Integrated RS 485 interface
Physics	RS 485	Ethernet RJ45	RS 485	Ethernet RJ45	RS 485
Interface types					
• Number of ports		2		2	
Functionality					
• MPI	No	No	No	No	No
• PROFIBUS IO Controller		Yes; Also simultaneously with IO-Device functionality		Yes; Also simultaneously with IO-Device functionality	No
• PROFIBUS IO Device		Yes; Also simultaneously with IO Controller functionality		Yes; Also simultaneously with IO Controller functionality	No
• PROFIBUS CBA		Yes		Yes	No
• PROFIBUS DP master	Yes	No	Yes	No	Yes
• PROFIBUS DP slave	Yes	No	Yes; A DP slave at both interfaces simultaneously is not possible	No	Yes; A DP slave at both interfaces simultaneously is not possible
DP master					
• Number of DP slaves, max.	124; Per station		124		124
3. Interface					
Interface type					PROFINET
Physics					Ethernet RJ45
Interface types					
• Number of ports					2
Functionality					
• MPI					No
• PROFIBUS IO Controller					Yes; Also simultaneously with I-Device functionality
• PROFIBUS IO Device					Yes; Also simultaneously with IO Controller functionality
• PROFIBUS CBA					Yes
• PROFIBUS DP master					No
• PROFIBUS DP slave					No
Isochronous mode					
Isochronous operation (application synchronized up to terminal)	Yes	Yes; Via PROFIBUS DP or PROFINET interface		Yes; Via PROFIBUS DP or PROFINET interface	Yes; Via 2nd PROFIBUS DP or PROFINET interface

Technical specifications (continued)

Article number	6ES7315-6FF04-0AB0 CPU315F, 384KB	6ES7315-2FJ14-0AB0 CPU315F-2 PN/DP, 512 KB	6ES7317-6FF04-0AB0 CPU317F-2DP, 1.5 MB	6ES7317-2FK14-0AB0 CPU317F-2 PN/DP, 1.5 MB	6ES7318-3FL01-0AB0 CPU319F-3 PN/DP, 2.5 MB
Communication functions					
PG/OP communication	Yes	Yes	Yes	Yes	Yes
Data record routing	Yes	Yes	Yes	Yes	Yes
Global data communication					
• supported	Yes	Yes	Yes	Yes	Yes
S7 basic communication					
• supported	Yes	Yes	Yes	Yes	Yes
S7 communication					
• supported	Yes	Yes	Yes	Yes	Yes
S5 compatible communication					
• supported	Yes; via CP and loadable FC	Yes; via CP and loadable FC	Yes; via CP and loadable FC	Yes; via CP and loadable FC	Yes; via CP and loadable FC
Open IE communication					
• TCP/IP		Yes; via integrated PROFINET interface and loadable FBs		Yes; via integrated PROFINET interface and loadable FBs	Yes; via integrated PROFINET interface and loadable FBs
- Number of connections, max.		8		16	32
• ISO-on-TCP (RFC1006)		Yes; via integrated PROFINET interface and loadable FBs		Yes; via integrated PROFINET interface and loadable FBs	Yes; via integrated PROFINET interface and loadable FBs
- Number of connections, max.		8		16	32
• UDP		Yes; via integrated PROFINET interface and loadable FBs		Yes; via integrated PROFINET interface and loadable FBs	Yes; via integrated PROFINET interface and loadable FBs
- Number of connections, max.		8		16	32
Web server					
• supported		Yes; only read function		Yes	Yes
Number of connections					
• overall	16	16	32	32	32
Ambient conditions					
Ambient temperature during operation					
• min.	0 °C	0 °C	0 °C	0 °C	0 °C
• max.	60 °C	60 °C	60 °C	60 °C	60 °C
Configuration					
Programming					
Programming language					
- LAD	Yes	Yes	Yes	Yes	Yes
- FBD	Yes	Yes	Yes	Yes	Yes
- STL	Yes	Yes	Yes	Yes	Yes
- SCL	Yes	Yes	Yes	Yes	Yes
- CFC	Yes	Yes	Yes	Yes	Yes
- GRAPH	Yes	Yes	Yes	Yes	Yes
- HiGraph®	Yes	Yes	Yes	Yes	Yes
Know-how protection					
• User program protection/password protection	Yes	Yes	Yes	Yes	Yes
• Block encryption	Yes; With S7 block Privacy	Yes; With S7 block Privacy	Yes; With S7 block Privacy	Yes; With S7 block Privacy	Yes; With S7 block Privacy
Dimensions					
Width	40 mm	40 mm	40 mm	40 mm	120 mm
Height	125 mm	125 mm	125 mm	125 mm	125 mm
Depth	130 mm	130 mm	130 mm	130 mm	130 mm
Weights					
Weight, approx.	290 g	340 g	360 g	340 g	1 250 g

SIMATIC S7-300 Advanced Controllers

Central processing units

Fail-safe CPUs

Ordering data	Article No.	Ordering data	Article No.
CPU 315F-2 DP CPU for SIMATIC S7-300F; work memory 384 KB, supply voltage 24 V DC, MPI, PROFIBUS DP master/slave interface, incl. slot number labels; MMC required	6ES7315-6FF04-0AB0	STEP 7 Safety Advanced V14 SP1 Task: Engineering tool for configuring and programming fail-safe user programs for SIMATIC S7-1200 FC, S7-1500F, S7-1500F Software Controller, S7-300F, S7-400F, WinAC RTX F, ET 200SP F Controller and the fail-safe ET 200SP, ET 200S, ET 200M, ET 200iSP, ET 200pro and ET 200eco I/O Requirement: STEP 7 Professional V14 SP1 Floating license for 1 user, software and documentation on DVD; license key on USB flash drive	6ES7833-1FA14-0YA5 6ES7833-1FA14-0YH5
CPU 315F-2 PN/DP CPU for SIMATIC S7-300F; work memory 512 KB, supply voltage 24 V DC; MPI/PROFIBUS DP master/slave interface; Industrial Ethernet PROFINET interface; incl. slot number labels; MMC required	6ES7315-2FJ14-0AB0	SIMATIC Micro Memory Card 64 KB 128 KB 512 KB 2 MB 4 MB 8 MB	6ES7953-8LF31-0AA0 6ES7953-8LG31-0AA0 6ES7953-8LJ31-0AA0 6ES7953-8LL31-0AA0 6ES7953-8LM31-0AA0 6ES7953-8LP31-0AA0
CPU 317F-2 DP Work memory 1.5 MB, power supply 24 V DC, MPI, PROFIBUS DP master/slave interface, MMC required	6ES7317-6FF04-0AB0	MPI cable For connection of SIMATIC S7 and PG via MPI; 5 m in length	6ES7901-0BF00-0AA0
CPU 317F-2 PN/DP Work memory 1.5 MB, supply voltage 24 V DC, MPI, PROFIBUS DP master/slave inter- face; Industrial Ethernet PROFINET interface; MMC required	6ES7317-2FK14-0AB0	Slot number plates SIMATIC Manual Collection Electronic manuals on DVD, multilingual: LOGO!, SIMADYN, SIMATIC bus components, SIMATIC C7, SIMATIC distributed I/O, SIMATIC HMI, SIMATIC Sensors, SIMATIC NET, SIMATIC PC Based Automation, SIMATIC PCS 7, SIMATIC PG/PC, SIMATIC S7, SIMATIC Software, SIMATIC TDC	6ES7912-0AA00-0AA0 6ES7998-8XC01-8YE0
CPU 319F-3 PN/DP Work memory 2.5 MB, power supply 24 V DC, combined MPI/PROFIBUS DP master/slave interface, PROFIBUS DP master/slave inter- face, Ethernet/PROFINET interface; MMC required	6ES7318-3FL01-0AB0	SIMATIC Manual Collection update service for 1 year Current "Manual Collection" DVD and the three subsequent updates	6ES7998-8XC01-8YE2
S7 Distributed Safety V5.4 programming tool Task: Configuration software for configuring fail-safe user programs for SIMATIC S7-300F, S7-400F, WinAC RTX F, ET 200S, ET 200M, ET 200iSP, ET 200pro, ET 200eco Requirement: STEP 7 V5.3 SP3 and higher Floating license Floating license for 1 user, license key download without software or documentation ¹⁾ ; email address required for delivery	6ES7833-1FC02-0YA5 6ES7833-1FC02-0YH5	Power supply connector 10 units, spare part	6ES7391-1AA00-0AA0
S7 Distributed Safety upgrade From V5.x to V5.4; floating license for 1 user	6ES7833-1FC02-0YE5	USB A2 PC adapter For connecting a PG/PC or Notebook to PROFIBUS or MPI; USB cable included in scope of delivery	6GK1571-0BA00-0AA0

SIMATIC S7-300 Advanced Controllers

Central processing units

Fail-safe CPUs

Ordering data	Article No.	Ordering data	Article No.
PROFIBUS bus components		PROFINET bus components	
PROFIBUS DP RS 485 bus connector		IE FC TP standard cable GP 2x2	6XV1840-2AH10
<ul style="list-style-type: none"> with 90° cable outlet, max. transfer rate 12 Mbps <ul style="list-style-type: none"> without PG interface with PG interface with 90° cable outlet for FastConnect connection system, max. transfer rate 12 Mbps <ul style="list-style-type: none"> without PG interface, 1 unit without PG interface, 100 units with PG interface, 1 unit with PG interface, 100 units with axial cable outlet for SIMATIC OP, for connecting to PPI, MPI, PROFIBUS 	6ES7972-0BA12-0XA0 6ES7972-0BB12-0XA0	4-wire, shielded TP installation cable for connection to IE FC Outlet RJ45/IE FC RJ45 Plug; PROFINET-compatible; with UL approval; Sold by the meter	
	6ES7972-0BA52-0XA0 6ES7972-0BA52-0XB0 6ES7972-0BB52-0XA0 6ES7972-0BB52-0XB0 6GK1500-0EA02	FO Standard Cable GP (50/125)	6XV1873-2A
PROFIBUS FastConnect bus cable	6XV1830-0EH10	Standard cable, splittable, UL approval, sold by the meter	
Standard type with special design for quick mounting, 2-wire, shielded, sold by the meter, max. delivery unit 1000 m, minimum ordering quantity 20 m		SCALANCE X204-2 Industrial Ethernet switch	6GK5204-2BB10-2AA3
RS 485 repeater for PROFIBUS	6ES7972-0AA02-0XA0	Industrial Ethernet switches with integral SNMP access, web diagnostics, copper cable diagnostics and PROFINET diagnostics for configuring line, star and ring topologies; four 10/100 Mbps RJ45 ports and two FO ports	
Transmission rate up to 12 Mbps; 24 V DC; IP20 enclosure		CSM 377 Compact Switch Module	6GK7377-1AA00-0AA0
		Unmanaged switch for connecting a SIMATIC S7-300, ET 200M and up to three other stations to Industrial Ethernet with 10/100 Mbps; 4 x RJ45 ports; external 24 V DC power supply, LED diagnostics, S7-300 module incl. electronic manual on CD-ROM	
		IE FC RJ45 plugs	
		RJ45 plug connector for Industrial Ethernet with a rugged metal enclosure and integrated insulation displacement contacts for connecting Industrial Ethernet FC installation cables	
		IE FC RJ45 Plug 145	
		145° cable outlet	
		1 unit	6GK1901-1BB30-0AA0
		10 units	6GK1901-1BB30-0AB0
		50 units	6GK1901-1BB30-0AE0
		IE FC RJ45 plug 180	
		180° cable outlet	
		1 unit	6GK1901-1BB10-2AA0
		10 units	6GK1901-1BB10-2AB0
		50 units	6GK1901-1BB10-2AE0
		PROFIBUS/PROFINET bus components	See Catalogs IK PI, CA 01
		For establishing MPI/PROFIBUS/PROFINET communication	

¹⁾ For up-to-date information and download availability, see: <http://www.siemens.com/tia-online-software-delivery>

SIMATIC S7-300 Advanced Controllers

Central processing units

SIPLUS S7-300 fail-safe CPUs

Overview SIPLUS S7-300 CPU 315F-2 DP



- For configuring a fail-safe automation system for plants with increased safety requirements
- Complies with safety requirements up to SIL 3 according to IEC 61508 and up to Cat. 4 according to EN 954-1
- Distributed fail-safe I/O modules can be connected through the integral PROFIBUS DP interface (PROFIsafe)
- The fail-safe I/O modules of ET 200M can be also centrally connected
- The standard modules for non-safety applications can be operated both centrally and locally

Micro Memory Card required for operation of CPU.

Note:

SIPLUS extreme products are based on SIMATIC standard products. The contents listed here were taken from the respective standard products. SIPLUS extreme-specific information was added.

Overview SIPLUS S7-300 CPU 315F-2 PN/DP



- The CPU with a medium sized program memory and quantity structures to build a fail-safe automation system for plants with increased safety requirements
- Complies with safety requirements up to SIL 3 according to IEC 61508, PL e in accordance with ISO 13849 and up to Cat. 4 of EN 954-1
- The fail-safe I/O modules can be locally connected to the integrated PROFINET interface (PROFIsafe) and/or to the integrated PROFIBUS DP interface (PROFIsafe)
- The fail-safe I/O modules of ET 200M can be also centrally connected
- The standard modules for non-safety applications can be operated both centrally and locally
- Component Based Automation (CBA) on PROFINET
- PROFINET IO controller for operating distributed I/O on PROFINET
- PROFINET interface with 2-port switch
- PROFINET proxy for intelligent devices on PROFIBUS DP in Component Based Automation (CBA)

Micro Memory Card required for operation of CPU.

Note:

SIPLUS extreme products are based on SIMATIC standard products. The contents listed here were taken from the respective standard products. SIPLUS extreme-specific information was added.

Overview SIPLUS S7-300 CPU 317F-2 DP



- The fail-safe CPU with a large program memory and quantity framework for demanding applications
- For configuring a fail-safe automation system for plants with increased safety requirements
- Complies with safety requirements up to SIL 3 according to IEC 61508 and up to Cat. 4 according to EN 954-1
- Fail-safe I/O modules can be connected in a distributed configuration to both integral PROFIBUS DP interfaces (PROFIsafe)
- The fail-safe I/O modules of ET 200M can be also centrally connected
- The standard modules for non-safety applications can be operated both centrally and locally

Micro Memory Card required for operation of CPU.

Note:

SIPLUS extreme products are based on SIMATIC standard products. The contents listed here were taken from the respective standard products. SIPLUS extreme-specific information was added.

Overview SIPLUS S7-300 CPU 317F-2 PN/DP



- The fail-safe CPU with a large program memory and quantity structures for demanding applications to build a fail-safe automation system for plants with increased safety requirements
- Complies with safety requirements up to SIL 3 according to IEC 61508, PL e in accordance with ISO 13849-1 and up to category 4 of EN 954-1
- The fail-safe I/O modules can be locally connected via the integrated PROFINET interface (PROFIsafe) and/or via the integrated PROFIBUS DP interface (PROFIsafe)
- The fail-safe I/O modules of ET 200M can be also centrally connected
- The standard modules for non-safety applications can be operated both centrally and locally
- Component Based Automation (CBA) on PROFINET
- PROFINET IO controller for operating distributed I/O on PROFINET
- PROFINET interface with 2-port switch
- PROFINET proxy for intelligent devices on PROFIBUS DP in Component Based Automation (CBA)

SIMATIC Micro Memory Card required for operation of CPU.

Note:

SIPLUS extreme products are based on SIMATIC standard products. The contents listed here were taken from the respective standard products. SIPLUS extreme-specific information was added.

SIMATIC S7-300 Advanced Controllers

Central processing units

SIPLUS S7-300 fail-safe CPUs

Technical specifications

Article number	6AG1315-6FF04-2AB0	6AG1315-6FF04-2AY0	6AG1315-2FJ14-2AB0	6AG1315-2FJ14-2AY0
Based on	6ES7315-6FF04-0AB0 SIPLUS S7-300 CPU 315F-2DP	6ES7315-6FF04-0AB0 SIPLUS S7-300 CPU 315F-2DP EN50155	6ES7315-2FJ14-0AB0 SIPLUS S7-300 CPU315F-2PN/DP	6ES7315-2FJ14-0AB0 SIPLUS S7-300 CPU315F-2PN/DP EN50155
Ambient conditions				
Ambient temperature during operation				
• min.	-25 °C	-25 °C; = Tmin	-25 °C; = Tmin	-25 °C; = Tmin
• max.	60 °C	60 °C; = Tmax; the rated temperature range of -25 ... +55 °C (T1) applies for the use on railway vehicles according to EN50155	60 °C; = Tmax	60 °C; = Tmax; the rated temperature range of -25 ... +55 °C (T1) applies for the use on railway vehicles according to EN50155
Ambient temperature during storage/transportation				
• min.	-40 °C	-40 °C	-40 °C	-40 °C
• max.	70 °C	70 °C	70 °C	70 °C
Extended ambient conditions				
• relative to ambient temperature-atmospheric pressure-installation altitude	Tmin ... Tmax at 1080 hPa ... 795 hPa (-1000 m ... +2000 m)	Tmin ... Tmax at 1080 hPa ... 795 hPa (-1000 m ... +2000 m)	Tmin ... Tmax at 1080 hPa ... 795 hPa (-1000 m ... +2000 m)	
Relative humidity				
- With condensation, tested in accordance with IEC 60068-2-38, max.	100 %; RH incl. condensation/frost (no commissioning under condensation conditions)	100 %; RH incl. condensation / frost (no commissioning in bedewed state), horizontal installation	100 %; RH incl. condensation / frost (no commissioning in bedewed state), horizontal installation	100 %; RH incl. condensation / frost (no commissioning in bedewed state), horizontal installation
Resistance				
- against biologically active substances / conformity with EN 60721-3-3	Yes; Class 3B2 mold, fungus and dry rot spores (with the exception of fauna). The supplied connector covers must remain on the unused interfaces during operation!	Yes; Class 3B2 mold, fungus and dry rot spores (with the exception of fauna). The supplied connector covers must remain on the unused interfaces during operation in corrosive atmospheres!	Yes; Class 3B2 mold, fungus and dry rot spores (with the exception of fauna). The supplied connector covers must remain on the unused interfaces during operation!	Yes; Class 3B2 mold, fungus and dry rot spores (with the exception of fauna). The supplied connector covers must remain on the unused interfaces during operation in corrosive atmospheres!
- against chemically active substances / conformity with EN 60721-3-3	Yes; Class 3C4 (RH < 75%) incl. salt spray according to EN 60068-2-52 (degree of severity 3). The supplied connector covers must remain on the unused interfaces during operation!	Yes; Class 3C4 (RH < 75%) incl. salt spray according to EN 60068-2-52 (degree of severity 3). The supplied connector covers must remain on the unused interfaces during operation!	Yes; Class 3C4 (RH < 75%) incl. salt spray according to EN 60068-2-52 (degree of severity 3). The supplied connector covers must remain on the unused interfaces during operation!	Yes; Class 3C4 (RH < 75%) incl. salt spray according to EN 60068-2-52 (degree of severity 3). The supplied connector covers must remain on the unused interfaces during operation!
- against mechanically active substances / conformity with EN 60721-3-3	Yes; Class 3S4 incl. sand, dust. The supplied connector covers must remain on the unused interfaces during operation!	Yes; Class 3S4 incl. sand, dust. The supplied connector covers must remain on the unused interfaces during operation!	Yes; Class 3S4 incl. sand, dust. The supplied connector covers must remain on the unused interfaces during operation!	Yes; Class 3S4 incl. sand, dust. The supplied connector covers must remain on the unused interfaces during operation!

SIMATIC S7-300 Advanced Controllers

Central processing units

SIPLUS S7-300 fail-safe CPUs

Technical specifications (continued)

Article number	6AG1317-6FF04-2AB0	6AG1317-2FK14-2AB0	6AG1317-2FK14-2AY0
Based on	6ES7317-6FF04-0AB0 SIPLUS S7-300 CPU317F-2DP	6ES7317-2FK14-0AB0 SIPLUS S7-300 CPU317F-2PN/DP	6ES7317-2FK14-0AB0 SIPLUS S7-300 CPU317F-2PN/DP EN50155
Ambient conditions			
Ambient temperature during operation			
• min.	-25 °C; = Tmin	-25 °C; = Tmin	-25 °C; = Tmin
• max.	60 °C; = Tmax	60 °C; = Tmax	60 °C; = Tmax; the rated temperature range of -25 ... +55 °C (T1) applies for the use on railway vehicles according to EN50155
Ambient temperature during storage/transportation			
• min.	-40 °C	-40 °C	-40 °C
• max.	70 °C	70 °C	70 °C
Extended ambient conditions			
• relative to ambient temperature-atmospheric pressure-installation altitude	Tmin ... Tmax at 1080 hPa ... 795 hPa (-1000 m ... +2000 m)	Tmin ... Tmax at 1080 hPa ... 795 hPa (-1000 m ... +2000 m)	Tmin ... Tmax at 1080 hPa ... 795 hPa (-1000 m ... +2000 m)
Relative humidity			
- With condensation, tested in accordance with IEC 60068-2-38, max.	100 %; RH incl. condensation / frost (no commissioning in bedewed state), horizontal installation	100 %; RH incl. condensation / frost (no commissioning in bedewed state), horizontal installation	100 %; RH incl. condensation / frost (no commissioning in bedewed state), horizontal installation
Resistance			
- against biologically active substances / conformity with EN 60721-3-3	Yes; Class 3B2 mold, fungus and dry rot spores (with the exception of fauna). The supplied connector covers must remain on the unused interfaces during operation!	Yes; Class 3B2 mold, fungus and dry rot spores (with the exception of fauna). The supplied connector covers must remain on the unused interfaces during operation!	Yes; Class 3B2 mold, fungus and dry rot spores (with the exception of fauna). The supplied connector covers must remain on the unused interfaces during operation in corrosive atmospheres!
- against chemically active substances / conformity with EN 60721-3-3	Yes; Class 3C4 (RH < 75%) incl. salt spray according to EN 60068-2-52 (degree of severity 3). The supplied connector covers must remain on the unused interfaces during operation!	Yes; Class 3C4 (RH < 75%) incl. salt spray according to EN 60068-2-52 (degree of severity 3). The supplied connector covers must remain on the unused interfaces during operation!	Yes; Class 3C4 (RH < 75%) incl. salt spray according to EN 60068-2-52 (degree of severity 3). The supplied connector covers must remain on the unused interfaces during operation!
- against mechanically active substances / conformity with EN 60721-3-3	Yes; Class 3S4 incl. sand, dust. The supplied connector covers must remain on the unused interfaces during operation!	Yes; Class 3S4 incl. sand, dust. The supplied connector covers must remain on the unused interfaces during operation!	Yes; Class 3S4 incl. sand, dust. The supplied connector covers must remain on the unused interfaces during operation!

SIMATIC S7-300 Advanced Controllers

Central processing units

SIPLUS S7-300 fail-safe CPUs

Ordering data

Article No.

Article No.

SIPLUS S7-300 CPU 315F-2 DP

For industrial applications with extended ambient conditions

CPU for SIPLUS S7-300F; work memory 384 KB, 24 V DC supply voltage, MPI, PROFIBUS DP master/slave interface; incl. slot number labels; MMC required

Extended temperature range and exposure to media

For rolling stock railway applications

Conforms to EN 50155

6AG1315-6FF04-2AB0

6AG1315-6FF04-2AY0

SIPLUS S7-300 CPU 315F-2 PN/DP

For industrial applications with extended ambient conditions

CPU for SIPLUS S7-300F; work memory 512 KB, power supply 24 V DC; MPI/PROFIBUS DP master/slave interface; Industrial Ethernet / PROFINET interface; incl. slot number plates

Extended temperature range and exposure to media

For rolling stock railway applications

CPU for SIPLUS S7-300F; work memory 512 KB, power supply 24 V DC; MPI/PROFIBUS DP master/slave interface; Industrial Ethernet / PROFINET interface; incl. slot number plates

Conforms to EN 50155

6AG1315-2FJ14-2AB0

6AG1315-2FJ14-2AY0

SIPLUS S7-300 CPU 317F-2 DP

For industrial applications with extended ambient conditions

CPU for SIPLUS S7-300F, work memory 1.5 MB, 24 V DC power supply, MPI, PROFIBUS DP master/slave interface; MMC required

Extended temperature range and exposure to media

6AG1317-6FF04-2AB0

SIPLUS S7-300 CPU 317F-2 PN/DP

For industrial applications with extended ambient conditions

CPU for SIMATIC S7-300F, 1.5 MB work memory, 24 V DC power supply, MPI/ PROFIBUS DP master/slave interface; Industrial Ethernet PROFINET interface; MMC require

Extended temperature range and exposure to media

For rolling stock railway applications

CPU for SIMATIC S7-300F, 1.5 MB work memory, 24 V DC power supply, MPI/ PROFIBUS DP master/slave interface; Industrial Ethernet PROFINET interface; MMC require conforms to EN 50155

6AG1317-2FK14-2AB0

6AG1317-2FK14-2AY0

Accessories

Mandatory

SIMATIC Micro Memory Card

64 KB

6ES7953-8LF31-0AA0

128 KB

6ES7953-8LG31-0AA0

512 KB

6ES7953-8LJ31-0AA0

2 MB

6ES7953-8LL31-0AA0

4 MB

6ES7953-8LM31-0AA0

8 MB

6ES7953-8LP31-0AA0

For communication within the application

PROFIBUS DP RS 485 bus connector

(extended temperature range and exposure to media)

With 90° cable outlet, max. transfer rate 12 Mbps

- Without PG interface
- With PG interface

6AG1972-0BA12-2XA0
6AG1972-0BB12-2XA0

With angled cable outlet, max. transfer rate 12 Mbps

- Without PG interface
- With PG interface

6AG1972-0BA42-7XA0
6AG1972-0BB42-7XA0

(extended temperature range)

6AG1500-0EA02-2AA0

With axial cable outlet for SIMATIC OP, for connecting to PPI, MPI, PROFIBUS

RS 485 repeater for PROFIBUS

6AG1972-0AA02-7XA0

(extended temperature range and exposure to media)

Transmission rate up to 12 Mbps; 24 V DC; IP20 enclosure

SIMATIC S7-300 Advanced Controllers

Central processing units

SIPLUS S7-300 fail-safe CPUs

Ordering data	Article No.	Article No.
IE FC RJ45 Plug 180 (extended temperature range and exposure to media) 180° cable outlet • 1 unit	6AG1901-1BB10-7AA0	
SIPLUS SCALANCE X-200 Industrial Ethernet switches Industrial Ethernet switches with integral SNMP access, online diagnostics, copper cable diagnostics and PROFINET diagnostics for configuring line, star and ring topologies; with integrated redundancy manager (exception: SCALANCE X208PRO); incl. operating instructions, Industrial Ethernet network manual and configuration software on CD-ROM • With electrical and optical ports for glass multimode FOC up to 3 km • Extended temperature range and exposure to media • SIPLUS SCALANCE X204-2 with four 10/100 Mbps RJ45 ports and two FO ports	6AG1204-2BB10-4AA3	S7 Distributed Safety programming tool V5.4 Task: Configuration software for configuring fail-safe user programs for SIMATIC S7-300F, S7-400F, WinAC RTX F, ET 200S, ET 200M, ET 200iSP, ET 200pro, ET 200eco Requirement: STEP 7 V5.3 SP3 and higher Floating license Floating license for 1 user, license key download without software or documentation ¹⁾ ; email address required for delivery
PROFIBUS FastConnect bus cable Standard type with special design for quick mounting, 2-wire, shielded, sold by the meter; max. delivery unit 1000 m, minimum ordering quantity 20 m	6XV1830-0EH10	S7 Distributed Safety Upgrade From V5.x to V5.4; floating license for 1 user 6ES7833-1FC02-0YE5
IE FC TP Standard Cable GP 2x2 4-wire, shielded TP installation cable for connection to IE FC Outlet RJ45/IE FC RJ45 Plug; PROFINET-compatible; with UL approval Sold by the meter	6XV1840-2AH10	STEP 7 Safety Advanced V14 SP1 Task: Engineering tool for configuring and programming fail-safe user programs for SIMATIC S7-1200 FC, S7-1500F, S7-1500F Software Controller, S7-300F, S7-400F, WinAC RTX F, ET 200SP F Controller and the fail-safe ET 200SP, ET 200S, ET 200M, ET 200iSP, ET 200pro and ET 200eco I/O Requirement: STEP 7 Professional V14 SP1 Floating license for 1 user, software and documentation on DVD; license key on USB flash drive 6ES7833-1FA14-0YA5 6ES7833-1FA14-0YH5
FO Standard Cable GP (50/125) <i>For commissioning</i>	6XV1873-2A	Consumables Power supply connector 10 units, spare part 6ES7391-1AA00-0AA0
MPI cable For connection of SIMATIC S7 and PG via MPI; length 5 m	6ES7901-0BF00-0AA0	Slot number plates 6ES7912-0AA00-0AA0
USB A2 PC adapter For connecting a programming device/PC or notebook to PROFIBUS or MPI; USB cable included in scope of delivery	6GK1571-0BA00-0AA0	Documentation SIMATIC Manual Collection Electronic manuals on DVD, multilingual: LOGO!, SIMADYN, SIMATIC bus components, SIMATIC C7, SIMATIC distributed I/O, SIMATIC HMI, SIMATIC Sensors, SIMATIC NET, SIMATIC PC Based Automation, SIMATIC PCS 7, SIMATIC PG/PC, SIMATIC S7, SIMATIC Software, SIMATIC TDC SIMATIC Manual Collection update service for 1 year Current "Manual Collection" DVD and the three subsequent updates 6ES7998-8XC01-8YE0 6ES7998-8XC01-8YE2

¹⁾ For up-to-date information and download availability, see: <http://www.siemens.com/tia-online-software-delivery>

SIMATIC S7-300 Advanced Controllers

Central processing units

Technology CPUs

Overview CPU 315T-3 PN/DP



- SIMATIC CPU with integral technology/motion control functionality
- With full standard CPU 315-2 PN/DP functionality (except for CBA)
- For cross-industry automation tasks in series machine, special machine and plant construction
- Ideal for synchronized motion, such as coupling to a virtual/real master, gear synchronization, cam disk, path interpolation, or print mark compensation
- 3D path interpolation with different kinematics
- Position and pressure-regulated hydraulic axes
- Used as central controller in production lines with central and distributed I/O
- With integrated I/O for high-speed technology functions (e.g. camming, reference point acquisition)
- PROFIBUS DP (DRIVE) interface for isochronous connection of drive components
- PROFINET interface with 2-port switch
- PROFINET IO controller for operating distributed I/O on PROFINET
- One common S7 user program for control and motion control tasks (no additional programming language necessary for motion control)
- "S7 technology" option package required (version V4.2 SP3 and higher)

SIMATIC Micro Memory Card (8 MB) required for operation of the CPU.

Overview CPU 317T-3 PN/DP



- SIMATIC CPU with integral technology/motion control functionality
- With full standard CPU 317-2 PN/DP functionality (except for CBA)
- For cross-industry automation tasks in series machine, special machine and plant construction
- Ideal for synchronized motion, such as coupling to a virtual/real master, gear synchronization, cam disk, path interpolation, or print mark compensation
- 3D path interpolation with different kinematics
- Position and pressure-regulated hydraulic axes
- Used as central controller in production lines with central and distributed I/O
- With integrated I/O for high-speed technology functions (e.g. camming, reference point acquisition)
- PROFIBUS DP (DRIVE) interface for isochronous connection of drive components
- PROFINET interface with 2-port switch
- PROFINET IO controller for operating distributed I/O on PROFINET
- One common S7 user program for control and motion control tasks (no additional programming language necessary for motion control)
- "S7 Technology" option package required (version V4.2 SP3 and higher)

SIMATIC Micro Memory Card (8 MB) required for operation of the CPU.

Overview CPU 317TF-3 PN/DP



- Fail-safe SIMATIC CPU 317TF-3 PN/DP with integral technology/motion control functionality
- Spare-part-compatible successor to the CPU 317TF-2 DP (Article No. 6ES7317-6TF14-0AB0)
- With full functionality of the standard CPU 317-2 PN/DP and CPU 317F-2 PN/DP (except for CBA)
- For cross-industry automation tasks in series machine, special machine and plant construction

- Ideal for synchronized motion, such as coupling to a virtual/real master, gear synchronization, cam disk, path interpolation, or print mark compensation
- 3D path interpolation with different kinematics
- Position and pressure-regulated hydraulic axes
- Used as central controller in production lines with central and distributed I/O
- With integrated I/O for high-speed technology functions (e.g. camming, reference point acquisition)
- PROFIBUS DP (DRIVE) interface for isochronous connection of drive components
- PROFINET interface with 2-port switch
- PROFINET IO controller for operating distributed I/O on PROFINET
- One common S7 user program for control and motion control tasks (no additional programming language necessary for motion control)
- "S7 Technology" option package required
- "S7 Distributed Safety" option package required (version V4.2 SP3 and higher)

SIMATIC Micro Memory Card (8 MB) required for operation of the CPU.

Technical specifications

Article number	6ES7315-7TJ10-0AB0 CPU315T-3 PN/DP, 384KB	6ES7317-7TK10-0AB0 CPU317T-3 PN/DP, 1024KB	6ES7317-7UL10-0AB0 CPU317TF-3 PN/DP, 1,5 MB
General information			
Engineering with			
• Programming package	STEP 7 V5.5 SP2 or higher and S7-Technology option package V4.2 SP3	STEP 7 V5.5 SP2 or higher and S7-Technology option package V4.2 SP3	STEP 7 V5.5 SP2 or higher; S7-Technology option package V4.2 SP3 or higher, Distributed Safety V5.4 SP5 or higher, S7-F Configuration Pack V5.5 SP10 or higher
Supply voltage			
Rated value (DC)			
• 24 V DC	Yes	Yes	Yes
Power loss			
Power loss, typ.	7.5 W	7.5 W	8.5 W
Memory			
Work memory			
• integrated	384 kbyte	1 024 kbyte	1 536 kbyte
• Size of retentive memory for retentive data blocks	128 kbyte	256 kbyte	256 kbyte
Load memory			
• Plug-in (MMC), max.	8 Mbyte	8 Mbyte	8 Mbyte
CPU processing times			
for bit operations, typ.	0.05 µs	0.025 µs	0.025 µs
for word operations, typ.	0.09 µs	0.03 µs	0.03 µs
for fixed point arithmetic, typ.	0.12 µs	0.04 µs	0.04 µs
for floating point arithmetic, typ.	0.45 µs	0.16 µs	0.16 µs

SIMATIC S7-300 Advanced Controllers

Central processing units

Technology CPUs

Technical specifications (continued)

Article number	6ES7315-7TJ10-0AB0 CPU315T-3 PN/DP, 384KB	6ES7317-7TK10-0AB0 CPU317T-3 PN/DP, 1024KB	6ES7317-7UL10-0AB0 CPU317TF-3 PN/DP, 1,5 MB
Counters, timers and their retentivity			
S7 counter			
• Number	256	512	512
IEC counter			
• present	Yes	Yes	Yes
S7 times			
• Number	256	512	512
IEC timer			
• present	Yes	Yes	Yes
Data areas and their retentivity			
Flag			
• Number, max.	2 048 byte	4 096 byte	4 096 byte
Address area			
I/O address area			
• Inputs	2 048 byte	8 192 byte	8 192 byte
• Outputs	2 048 byte	8 192 byte	8 192 byte
Process image			
• Inputs, adjustable	2 048 byte	8 192 byte	8 192 byte
• Outputs, adjustable	2 048 byte	8 192 byte	8 192 byte
Time of day			
Clock			
• Hardware clock (real-time)	Yes	Yes	Yes
Operating hours counter			
• Number	1	4	4
Digital outputs			
Integrated high-speed cams			
• Switching accuracy (+/-)	70 µs	70 µs	70 µs
1. Interface			
Interface type	Integrated RS 485 interface	Integrated RS 485 interface	Integrated RS 485 interface
Physics	RS 485	RS 485	RS 485
Functionality			
• MPI	Yes	Yes	Yes
• PROFIBUS DP master	Yes	Yes	Yes
• PROFIBUS DP slave	Yes	Yes	Yes
• Point-to-point connection	No	No	No
DP master			
• Number of DP slaves, max.	124	124	124
2. Interface			
Interface type	Integrated RS 485 interface	Integrated RS 485 interface	Integrated RS 485 interface
Physics	RS 485	RS 485	RS 485
Functionality			
• MPI	No	No	No
• PROFIBUS DP master	Yes; DP(DRIVE)-Master	Yes; DP(DRIVE)-Master	Yes; DP(DRIVE)-Master
• PROFIBUS DP slave	No	No	No
DP master			
• Number of DP slaves, max.	64	64	64
3. Interface			
Interface type	PROFINET	PROFINET	PROFINET
Physics	Ethernet RJ45	Ethernet RJ45	Ethernet RJ45
Interface types			
• Number of ports	2	2	2
Functionality			
• MPI	No	No	No
• PROFINET IO Controller	Yes; Also simultaneously with IO-Device functionality	Yes; Also simultaneously with IO-Device functionality	Yes; Also simultaneously with IO-Device functionality
• PROFINET IO Device	Yes; Also simultaneously with IO Controller functionality	Yes; Also simultaneously with IO Controller functionality	Yes; Also simultaneously with IO Controller functionality
• PROFIBUS DP master	No	No	No
• PROFIBUS DP slave	No	No	No

Technical specifications (continued)

Article number	6ES7315-7TJ10-0AB0 CPU315T-3 PN/DP, 384KB	6ES7317-7TK10-0AB0 CPU317T-3 PN/DP, 1024KB	6ES7317-7UL10-0AB0 CPU317TF-3 PN/DP, 1,5 MB
Isochronous mode			
Isochronous operation (application synchronized up to terminal)	Yes; Via PROFIBUS DP or PROFINET interface	Yes; Via PROFIBUS DP or PROFINET interface	Yes; Via PROFIBUS DP or PROFINET interface
Communication functions			
PG/OP communication	Yes	Yes	Yes
Data record routing	Yes	Yes	Yes
Global data communication			
• supported	Yes	Yes	Yes
S7 basic communication			
• supported	Yes	Yes	Yes
S7 communication			
• supported	Yes	Yes	Yes
S5 compatible communication			
• supported	Yes; via CP and loadable FC	Yes; via CP and loadable FC	Yes; via CP and loadable FC
Open IE communication			
• TCP/IP	Yes; via integrated PROFINET interface and loadable FBs	Yes; via integrated PROFINET interface and loadable FBs	Yes; via integrated PROFINET interface and loadable FBs
- Number of connections, max.	8	16	16
• ISO-on-TCP (RFC1006)	Yes; via integrated PROFINET interface and loadable FBs	Yes; via integrated PROFINET interface and loadable FBs	Yes; via integrated PROFINET interface and loadable FBs
- Number of connections, max.	8	16	16
• UDP	Yes; via integrated PROFINET interface and loadable FBs	Yes; via integrated PROFINET interface and loadable FBs	Yes; via integrated PROFINET interface and loadable FBs
- Number of connections, max.	8	16	16
Web server			
• supported	Yes	Yes	Yes
Number of connections			
• overall	16	32	32
Ambient conditions			
Ambient temperature during operation			
• min.	0 °C	0 °C	0 °C
• max.	60 °C	60 °C	60 °C
Configuration			
Programming			
Programming language			
- LAD	Yes	Yes	Yes
- FBD	Yes	Yes	Yes
- STL	Yes	Yes	Yes
- SCL	Yes	Yes	Yes
- CFC	Yes	Yes	Yes
- GRAPH	Yes	Yes	Yes
- HiGraph®	Yes	Yes	Yes
Know-how protection			
• User program protection/password protection	Yes	Yes	Yes
• Block encryption	Yes; With S7 block Privacy	Yes; With S7 block Privacy	Yes; With S7 block Privacy
Dimensions			
Width	120 mm	120 mm	120 mm
Height	125 mm	125 mm	125 mm
Depth	130 mm	130 mm	130 mm
Weights			
Weight, approx.	640 g	640 g	640 g

SIMATIC S7-300 Advanced Controllers

Central processing units

Technology CPUs

Ordering data	Article No.	Ordering data	Article No.
CPU 315T-3 PN/DP 384 KB work memory, 24 V DC power supply, MPI, PROFIBUS DP master/slave interface, PROFIBUS DP (DRIVE) interface, Ethernet/PROFINET interface with 2-port switch; with technology/motion control functions; MMC required	6ES7315-7TJ10-0AB0	S7 Distributed Safety V5.4 programming tool Task: Configuration software for configuring fail-safe user programs for SIMATIC S7-300F, S7-400F, WinAC RTX F, ET 200S, ET 200M, ET 200iSP, ET 200pro, ET 200eco Requirement: STEP 7 V5.3 SP3 and higher	
CPU 317T-3 PN/DP 1024 KB work memory, 24 V DC power supply, MPI, PROFIBUS DP master/slave interface, PROFIBUS DP (DRIVE) interface, Ethernet/PROFINET interface with 2-port switch; with technology/motion control functions; MMC required	6ES7317-7TK10-0AB0	Floating license for 1 user Floating license for 1 user, license key download without software or documentation ¹⁾ ; email address required for delivery S7 Distributed Safety upgrade from V5.x to V5.4; floating license for 1 user	6ES7833-1FC02-0YA5 6ES7833-1FC02-0YH5 6ES7833-1FC02-0YE5
CPU 317TF-3 PN/DP 1.5 MB work memory, 24 V DC power supply, MPI, PROFIBUS DP master/slave interface, PROFIBUS DP (DRIVE) interface, Ethernet/PROFINET interface with 2-port switch; with technology/motion control functions; MMC required	6ES7317-7UL10-0AB0	SIMATIC Micro Memory Card 8 MB	6ES7953-8LP31-0AA0
S7 Technology V4.2 V4.2 SP3 and higher can be used for CPU 317TF-3 PN/DP Task: Option package for configuring and programming technology tasks with the SIMATIC S7 CPU 31xT and SIMATIC S7 CPU 317TF Requirement: STEP 7 V5.5 SP5 and higher Type of delivery: incl. up-to-date Service Pack; on DVD; incl. documentation for CPU 31xT-2 DP, CPU 317TF-2 DP (included on DVD) Floating license Floating license for 1 user, license key download without software or documentation ¹⁾ ; email address required for delivery Upgrade to V4.2 Trial license	6ES7864-1CC42-0YA5 6ES7864-1CC42-0XH5 6ES7864-1CC42-0YE5 6ES7864-1CC42-0YA7	MPI cable for connection of SIMATIC S7 and PG via MPI; 5 m in length Front connectors 40-pin, with screw contacts <ul style="list-style-type: none"> • 1 unit • 100 units 40-pin, with spring-loaded contacts <ul style="list-style-type: none"> • 1 unit • 100 units Slot number plates SIMATIC Manual Collection Electronic manuals on DVD, multilingual: LOGO!, SIMADYN, SIMATIC bus components, SIMATIC C7, SIMATIC distributed I/O, SIMATIC HMI, SIMATIC Sensors, SIMATIC NET, SIMATIC PC Based Automation, SIMATIC PCS 7, SIMATIC PG/PC, SIMATIC S7, SIMATIC Software, SIMATIC TDC	6ES7901-0BF00-0AA0 6ES7392-1AM00-0AA0 6ES7392-1AM00-1AB0 6ES7392-1BM01-0AA0 6ES7392-1BM01-1AB0 6ES7912-0AA00-0AA0 6ES7998-8XC01-8YE0
		SIMATIC Manual Collection update service for 1 year Current "Manual Collection" DVD and the three subsequent updates	6ES7998-8XC01-8YE2
		Power supply connector 10 units, spare part	6ES7391-1AA00-0AA0
		Labeling strips 10 units, spare part	6ES7392-2XX00-0AA0
		Label cover 10 units, spare part	6ES7392-2XY00-0AA0

¹⁾ For up-to-date information and download availability, see:
<http://www.siemens.com/tia-online-software-delivery>

Ordering data	Article No.	Ordering data	Article No.
Labeling sheets for machine inscription for modules with 40-pin front connector, DIN A4, for printing with laser printer; 10 units Petrol Light beige Yellow Red	6ES7392-2AX10-0AA0 6ES7392-2BX10-0AA0 6ES7392-2CX10-0AA0 6ES7392-2DX10-0AA0	PROFINET bus components IE FC TP Standard Cable GP 2x2 4-wire, shielded TP installation cable for connection to IE FC outlet RJ45/ IE FC RJ45 plug; PROFINET-compatible; with UL approval; sold by the meter	6XV1840-2AH10
USB A2 PC adapter for connecting a PG/PC or Notebook to PROFIBUS or MPI; USB cable included in scope of delivery	6GK1571-0BA00-0AA0	FO Standard Cable GP (50/125) Standard cable, splittable, UL approval, sold by the meter	6XV1873-2A
PROFIBUS bus components PROFIBUS DP RS 485 bus connector <ul style="list-style-type: none"> with 90° cable outlet, max. transfer rate 12 Mbps <ul style="list-style-type: none"> without PG interface with PG interface with 90° cable outlet for FastConnect connection system, max. transfer rate 12 Mbps <ul style="list-style-type: none"> without PG interface, 1 unit without PG interface, 100 units with PG interface, 1 unit with PG interface, 100 units with axial cable outlet for SIMATIC OP, for connecting to PPI, MPI, PROFIBUS 	6ES7972-0BA12-0XA0 6ES7972-0BB12-0XA0 6ES7972-0BA52-0XA0 6ES7972-0BA52-0XB0 6ES7972-0BB52-0XA0 6ES7972-0BB52-0XB0 6GK1500-0EA02	SCALANCE X204-2 Industrial Ethernet switch Industrial Ethernet switches with integral SNMP access, web diagnostics, copper cable diagnostics and PROFINET diagnostics for configuring line, star and ring topologies; four 10/100 Mbps RJ45 ports and two FO ports	6GK5204-2BB10-2AA3
PROFIBUS FastConnect bus cable Standard type with special design for quick mounting, 2-wire, shielded, sold by the meter, max. delivery unit 1000 m, minimum ordering quantity 20 m	6XV1830-0EH10	CSM 377 Compact Switch Module Unmanaged switch for connecting a SIMATIC S7-300, ET 200M and up to three other stations to Industrial Ethernet with 10/100 Mbps; 4 x RJ45 ports; external 24 V DC power supply, LED diagnostics, S7-300 module incl. electronic manual on CD-ROM	6GK7377-1AA00-0AA0
RS 485 repeater for PROFIBUS Transmission rate up to 12 Mbps; 24 V DC; IP20 enclosure	6ES7972-0AA02-0XA0	IE FC RJ45 plugs RJ45 plug connector for Industrial Ethernet with a rugged metal enclosure and integrated insulation displacement contacts for connecting Industrial Ethernet FC installation cables	
		IE FC RJ45 Plug 180 180° cable outlet 1 unit 10 units 50 units	6GK1901-1BB10-2AA0 6GK1901-1BB10-2AB0 6GK1901-1BB10-2AE0
		PROFIBUS/PROFINET bus components For establishing MPI/PROFIBUS/PROFINET communication	See Catalogs IK PI, CA 01

SIMATIC S7-300 Advanced Controllers

I/O modules

Digital modules

SM 321 digital input modules

Overview



- Digital inputs
- For connecting standard switches and two-wire proximity switches (BEROs)

Technical specifications

Article number	6ES7321-1BH02-0AA0	6ES7321-1BH50-0AA0	6ES7321-1BL00-0AA0	6ES7321-1BP00-0AA0	6ES7321-1BH10-0AA0
	SM321, 16DI, DC24V	SM321, 16DI, DC24V, SOURCE INPUT	SM321, 32DI, DC24V	SM321, 64 DI, DC 24V, 3MS, SINK/SOURCE	SM321, 16DI, DC24V, 0.05MS INPUT DELAY.
Supply voltage					
Load voltage L+					
• Rated value (DC)	24 V	24 V	24 V	24 V	24 V
Input current					
from backplane bus 5 V DC, max.	10 mA	10 mA	15 mA	100 mA	110 mA
Power loss					
Power loss, typ.	3.5 W	3.5 W	6.5 W	7 W	3.8 W
Digital inputs					
Number of digital inputs	16	16	32	64	16
Input characteristic curve in accordance with IEC 61131, type 1	Yes	Yes	Yes	Yes	Yes
Number of simultaneously controllable inputs					
horizontal installation					
- up to 40 °C, max.	16	16	32	64	16
- up to 60 °C, max.	16	16	16	32	16
vertical installation					
- up to 40 °C, max.	16	16	32	32	16
Input voltage					
• Type of input voltage	DC	DC	DC	DC	DC
• Rated value (DC)	24 V	24 V	24 V	24 V	24 V
• for signal "0"	-30 to +5V	-5 to +30V	-30 to +5V	-30 to +5V	-30 to +5V
• for signal "1"	13 to 30V	-13 to -30V	13 to 30V	13 to 30V	13 to 30V
Input current					
• for signal "1", typ.	7 mA	7 mA	7 mA	4.2 mA	7 mA
Input delay (for rated value of input voltage)					
for standard inputs					
- parameterizable	No	No	No	No	No
- at "0" to "1", min.	1.2 ms	1.2 ms	1.2 ms	1.2 ms	25 µs
- at "0" to "1", max.	4.8 ms	4.8 ms	4.8 ms	4.8 ms	75 µs
Cable length					
• shielded, max.	1 000 m	1 000 m	1 000 m	1 000 m	1 000 m
• unshielded, max.	600 m	600 m	600 m	600 m	600 m

Technical specifications (continued)

Article number	6ES7321-1BH02-0AA0 SM321, 16DI, DC24V	6ES7321-1BH50-0AA0 SM321, 16DI, DC24V, SOURCE INPUT	6ES7321-1BL00-0AA0 SM321, 32DI, DC24V	6ES7321-1BP00-0AA0 SM321, 64 DI, DC 24V, 3MS, SINK/SOURCE	6ES7321-1BH10-0AA0 SM321, 16DI, DC24V, 0.05MS INPUT DELAY.
Encoder					
Connectable encoders					
• 2-wire sensor	Yes	Yes	Yes	No	Yes
- permissible quiescent current (2-wire sensor), max.	1.5 mA	1.5 mA	1.5 mA		1.5 mA
Isochronous mode					
Isochronous operation (application synchronized up to terminal)	No	No	No	No	Yes
Interrupts/diagnostics/ status information					
Diagnostic functions	No	No	No	No	No
Alarms					
• Diagnostic alarm	No	No	No	No	No
• Hardware interrupt	No	No	No	No	No
Potential separation					
Potential separation digital inputs					
• between the channels	No	No	No	No	No
• between the channels, in groups of	16	16	16	16	16
• between the channels and backplane bus	Yes; Optocoupler	Yes; Optocoupler	Yes; Optocoupler	Yes; Optocoupler	Yes; Optocoupler
Isolation					
Isolation tested with	500 V DC	500 V DC	500 V DC	500 V DC	500 V DC
Connection method					
required front connector	20-pin	20-pin	40-pin	Cable: 6ES7392-4Bxx0-0AA0 terminal blocks: 6ES7392-1xN00-0AA0	20-pin
Dimensions					
Width	40 mm	40 mm	40 mm	40 mm	40 mm
Height	125 mm	125 mm	125 mm	125 mm	125 mm
Depth	120 mm	120 mm	120 mm	112 mm	120 mm
Weights					
Weight, approx.	200 g	200 g	260 g	230 g	200 g

SIMATIC S7-300 Advanced Controllers

I/O modules

Digital modules

SM 321 digital input modules

Technical specifications (continued)

Article number	6ES7321-7BH01-0AB0 SM321, 16DI, 24V DC	6ES7321-1CH00-0AA0 SM321, 16 DI, AC/DC 24-48V, 1CH/COMMON	6ES7321-1CH20-0AA0 SM321, 16DI, DC48-125V	6ES7321-1FH00-0AA0 SM321, 16 DI, 120/230V AC
Supply voltage				
Load voltage L+				
• Rated value (DC)	24 V	24 V	48 V	
Load voltage L1				
• Rated value (AC)		24 V		230 V; 120/230 V AC; all load voltages must have the same phase.
Input current				
from load voltage L+ (without load), max.	90 mA			
from backplane bus 5 V DC, max.	130 mA	100 mA	40 mA	29 mA
Power loss				
Power loss, typ.	4 W	1.5 W; at 24 V; 2,8 W at 48 V	4.3 W	4.9 W
Digital inputs				
Number of digital inputs	16	16	16	16
Input characteristic curve in accordance with IEC 61131, type 1		Yes	Yes	Yes
Input characteristic curve in accordance with IEC 61131, type 2	Yes			
Number of simultaneously controllable inputs				
horizontal installation				
- up to 40 °C, max.	16	16	8	16
- up to 60 °C, max.	16	16	8; 6 to Ue 146 V	16
vertical installation				
- up to 40 °C, max.	16	16	8	16
Input voltage				
• Type of input voltage	DC	AC/DC	DC	AC
• Rated value (DC)	24 V	24 V; DC 24 or 48 V	48 V; 48 V DC to 125 V DC	
• Rated value (AC)		24 V; AC 24 or 48 V		230 V; 120/230V AC
• for signal "0"	-30 to +5V	-5V AC to +5V AC	-146 V DC to +15 V DC	0 to 40V
• for signal "1"	13 to 30V	14V AC to 60V AC	30 V DC to 146 V DC	79 to 264V
• Frequency range		0 to 63 Hz		47 ... 63 Hz
Input current				
• for signal "1", typ.	7 mA	2.7 mA	3.5 mA	6.5 mA; (120V, 60Hz), 16mA (230V, 50Hz)
Input delay (for rated value of input voltage)				
for standard inputs				
- parameterizable	Yes; 0.1 / 0.5 / 3 / 15 / 20 ms	No	No	No
- at "0" to "1", min.		16 ms	0.1 ms	25 ms
- at "0" to "1", max.		16 ms	3.5 ms	25 ms
Cable length				
• shielded, max.	1 000 m	1 000 m	1 000 m	1 000 m
• unshielded, max.	600 m	600 m	600 m	600 m
Encoder				
Connectable encoders				
• 2-wire sensor	Yes	Yes	Yes	Yes
- permissible quiescent current (2-wire sensor), max.	2 mA	1 mA	1 mA	2 mA
Isochronous mode				
Isochronous operation (application synchronized up to terminal)	Yes	No	No	No

Technical specifications (continued)

Article number	6ES7321-7BH01-0AB0 SM321, 16DI, 24V DC	6ES7321-1CH00-0AA0 SM321, 16 DI, AC/DC 24-48V, 1CH/COMMON	6ES7321-1CH20-0AA0 SM321, 16DI, DC48-125V	6ES7321-1FH00-0AA0 SM321, 16 DI, 120/230V AC
Interrupts/diagnostics/status information				
Diagnostic functions	Yes; Parameterizable	No	No	No
Alarms				
• Diagnostic alarm	Yes; Parameterizable	No	No	No
• Hardware interrupt	Yes; Parameterizable	No	No	No
Potential separation				
Potential separation digital inputs				
• between the channels	No	Yes	No	No
• between the channels, in groups of	16	1	8	4
• between the channels and backplane bus	Yes; Optocoupler	Yes; Optocoupler	Yes; Optocoupler	Yes; Optocoupler
Isolation				
Isolation tested with	500 V DC	1500 V AC	1500 V DC	4 000 V DC
Connection method				
required front connector	20-pin	40-pin	20-pin	20-pin
Dimensions				
Width	40 mm	40 mm	40 mm	40 mm
Height	125 mm	125 mm	125 mm	125 mm
Depth	120 mm	120 mm	120 mm	120 mm
Weights				
Weight, approx.	200 g	260 g	200 g	240 g

Article number	6ES7321-1EL00-0AA0 SM321, 32DI, AC120V	6ES7321-1FF01-0AA0 SM321, 8DI, AC120/230V	6ES7321-1FF10-0AA0 SM321, 8 DI, AC/DC 120/230V, 1CH/COMMON
Load voltage L1			
• Rated value (AC)	120 V	230 V; 120/230V AC	230 V; 120/230 V AC; all load voltages must have the same phase.
Input current			
from backplane bus 5 V DC, max.	16 mA	29 mA	100 mA
Power loss			
Power loss, typ.	4 W	4.9 W	4.9 W
Digital inputs			
Number of digital inputs	32	8	8
Input characteristic curve in accordance with IEC 61131, type 1		Yes	Yes
Input characteristic curve in accordance with IEC 61131, type 2	Yes		
Number of simultaneously controllable inputs			
horizontal installation			
- up to 40 °C, max.	32		
- up to 60 °C, max.	24	8	8
vertical installation			
- up to 40 °C, max.	32	8	8
Input voltage			
• Type of input voltage	AC	AC	AC
• Rated value (AC)	120 V	230 V; 120/230V AC	120 V; 120/230V AC
• for signal *0*	0 to 20V	0 to 40V	0 to 40V
• for signal *1*	74 to 132V	79 to 264V	79 to 264V
• Frequency range	47 ... 63 Hz	47 ... 63 Hz	47 ... 63 Hz
Input current			
• for signal *1*, typ.	21 mA	6.5 mA; (120 V); 11 mA (230 V)	7.5 mA; (120 V); 17.3 mA (230 V)

SIMATIC S7-300 Advanced Controllers

I/O modules

Digital modules

SM 321 digital input modules**Technical specifications (continued)**

Article number	6ES7321-1EL00-0AA0 SM321, 32DI, AC120V	6ES7321-1FF01-0AA0 SM321, 8DI, AC120/230V	6ES7321-1FF10-0AA0 SM321, 8 DI, AC/DC 120/230V, 1CH/COMMON
Input delay (for rated value of input voltage) for standard inputs			
- parameterizable	No	No	No
- at "0" to "1", max.	15 ms	25 ms	25 ms
Cable length			
• shielded, max.	1 000 m	1 000 m	1 000 m
• unshielded, max.	600 m	600 m	600 m
Encoder			
Connectable encoders			
• 2-wire sensor	Yes	Yes	Yes
- permissible quiescent current (2-wire sensor), max.	4 mA	2 mA	2 mA
Isochronous mode			
Isochronous operation (application synchronized up to terminal)	No	No	No
Interrupts/diagnostics/ status information			
Diagnostic functions	No	No	No
Alarms			
• Diagnostic alarm	No	No	No
• Hardware interrupt	No	No	No
Potential separation			
Potential separation digital inputs			
• between the channels	No	No	Yes
• between the channels, in groups of	8	2	1
• between the channels and backplane bus	Yes; Optocoupler	Yes; Optocoupler	Yes; Optocoupler
Isolation			
Isolation tested with	2500 V DC	4 000 V DC	1500 V AC
Connection method			
required front connector	40-pin	20-pin	40-pin
Dimensions			
Width	40 mm	40 mm	40 mm
Height	125 mm	125 mm	125 mm
Depth	120 mm	120 mm	120 mm
Weights			
Weight, approx.	300 g	240 g	240 g

Ordering data	Article No.	Ordering data	Article No.
SM 321 digital input modules		Front door, elevated design	6ES7328-0AA00-7AA0
incl. labeling strips, bus connector		e.g. for 32-channel modules; for connecting 1.3 mm ² /16 AWG conductors; circuit diagram and nameplates in petrol	
16 inputs, 24 V DC	6ES7321-1BH02-0AA0	SIMATIC TOP connect	See page 5/248
16 inputs, 24 V DC, active low	6ES7321-1BH50-0AA0	Bus connectors	6ES7390-0AA00-0AA0
32 inputs, 24 V DC	6ES7321-1BL00-0AA0	1 unit (spare part)	
64 inputs, 24 V DC, active high/low	6ES7321-1BP00-0AA0	Labeling strips	
Note: 6ES7392-4...0-0AA0 connecting cable and 6ES7392-1.N00-0AA0 terminal blocks necessary.		10 units (spare part)	
16 inputs, 24 to 48 V DC	6ES7321-1CH00-0AA0	for modules with 20-pin front connector	6ES7392-2XX00-0AA0
16 inputs, 48 to 125 V DC	6ES7321-1CH20-0AA0	for modules with 40-pin front connector	6ES7392-2XX10-0AA0
16 inputs, 24 V DC, for isochronous mode	6ES7321-1BH10-0AA0	Label cover	
32 inputs, 120 V AC	6ES7321-1EL00-0AA0	10 units (spare part)	
8 inputs, 120/230 V AC	6ES7321-1FF01-0AA0	for modules with 20-pin front connector	6ES7392-2XY00-0AA0
8 inputs, 120/230 V AC, single root	6ES7321-1FF10-0AA0	for modules with 40-pin front connector	6ES7392-2XY10-0AA0
16 inputs, 120/230 V AC	6ES7321-1FH00-0AA0	Labeling sheets for machine inscription	
16 inputs, 24 V DC, for isochronous mode, diagnostics-capable	6ES7321-7BH01-0AB0	for modules with 20-pin front connector, DIN A4, for printing with laser printer; 10 units	
Front connector		Petrol	6ES7392-2AX00-0AA0
20-pin, with screw contacts		Light beige	6ES7392-2BX00-0AA0
• 1 unit	6ES7392-1AJ00-0AA0	Yellow	6ES7392-2CX00-0AA0
• 100 units	6ES7392-1AJ00-1AB0	Red	6ES7392-2DX00-0AA0
20-pin, with spring-loaded contacts		for modules with 40-pin front connector, DIN A4, for printing with laser printer; 10 units	
• 1 unit	6ES7392-1BJ00-0AA0	Petrol	6ES7392-2AX10-0AA0
• 100 units	6ES7392-1BJ00-1AB0	Light beige	6ES7392-2BX10-0AA0
40-pin, with screw contacts		Yellow	6ES7392-2CX10-0AA0
• 1 unit	6ES7392-1AM00-0AA0	Red	6ES7392-2DX10-0AA0
• 100 units	6ES7392-1AM00-1AB0	SIMATIC Manual Collection	6ES7998-8XC01-8YE0
40-pin, with spring-loaded contacts		Electronic manuals on DVD, multilingual: LOGO!, SIMADYN, SIMATIC bus components, SIMATIC C7, SIMATIC distributed I/O, SIMATIC HMI, SIMATIC Sensors, SIMATIC NET, SIMATIC PC Based Automation, SIMATIC PCS 7, SIMATIC PG/PC, SIMATIC S7, SIMATIC Software, SIMATIC TDC	
• 1 unit	6ES7392-1BM01-0AA0	SIMATIC Manual Collection update service for 1 year	6ES7998-8XC01-8YE2
• 100 units	6ES7392-1BM01-1AB0	Current "Manual Collection" DVD and the three subsequent updates	
S7-300 connecting cable			
For 64-channel modules; 2 units			
1 m	6ES7392-4BB00-0AA0		
2.5 m	6ES7392-4BC50-0AA0		
5 m	6ES7392-4BF00-0AA0		
Terminal block			
For 64-channel modules; 2 units			
With screw contacts	6ES7392-1AN00-0AA0		
With spring-loaded contacts	6ES7392-1BN00-0AA0		

SIMATIC S7-300 Advanced Controllers

I/O modules

Digital modules

SM 322 digital output modules

Overview



- Digital outputs
- For connecting solenoid valves, contactors, low-power motors, lamps and motor starters

Technical specifications

Article number	6ES7322-1BH01-0AA0	6ES7322-1BH10-0AA0	6ES7322-1BL00-0AA0	6ES7322-1BP00-0AA0	6ES7322-1BP50-0AA0	6ES7322-8BF00-0AB0
	SM322, 16DO 24V DC, 0,5A	SM322 HIGH SPEED, 16DO 24V DC, 0,5A	SM322, 32DO 24V DC, 0,5A	SM322 64DA, DC24V, 0,3A P-WRITE	SM322 64DO, DC24V, 0,3A M-WRITE	SM322, 8DO, 24V DC, 0,5A
Supply voltage						
Load voltage L+						
• Rated value (DC)	24 V	24 V	24 V	24 V	24 V	24 V
Input current						
from load voltage L+ (without load), max.	80 mA	110 mA	160 mA	75 mA	75 mA	90 mA
from backplane bus 5 V DC, max.	80 mA	70 mA	110 mA	100 mA	100 mA	70 mA
Power loss						
Power loss, typ.	4.9 W	5 W	6.6 W	6 W	6 W	5 W
Digital outputs						
Number of digital outputs	16	16	32	64	64	8
Limitation of inductive shutdown voltage to	L+ (-53 V)	L+ (-53 V)	L+ (-53 V)	L+ (-53 V)	M+ (45 V)	L+ (-45 V)
Switching capacity of the outputs						
• on lamp load, max.	5 W	5 W	5 W	5 W	5 W	5 W
Load resistance range						
• lower limit	48 Ω	48 Ω	48 Ω	80 Ω	80 Ω	48 Ω
• upper limit	4 kΩ	4 kΩ	4 kΩ	10 kΩ	10 kΩ	3 kΩ
Output voltage						
• for signal *1*, min.	L+ (-0.8 V)	L+ (-0.8 V)	L+ (-0.8 V)	L+ (-0.5 V)	M+ (0.5 V)	L+ (-0.8 to -1.6 V)
Output current						
• for signal *1* rated value	0.5 A	0.5 A	0.5 A	0.3 A	0.3 A	0.5 A
• for signal *1* permissible range, min.				2.4 mA	2.4 mA	
• for signal *1* permissible range, max.				0.36 A	0.36 A	
• for signal *1* permissible range for 0 to 40 °C, min.	5 mA	5 mA	5 mA			10 mA
• for signal *1* permissible range for 0 to 40 °C, max.	0.6 A	0.6 A	0.6 A			0.6 A
• for signal *1* permissible range for 40 to 60 °C, min.	5 mA	5 mA	5 mA			10 mA
• for signal *1* permissible range for 40 to 60 °C, max.	0.6 A	0.6 A	0.6 A			0.6 A
• for signal *1* minimum load current	5 mA	5 mA	5 mA			10 mA
• for signal *0* residual current, max.	0.5 mA	0.5 mA	0.5 mA	0.1 mA		0.5 mA

Technical specifications (continued)

Article number	6ES7322-1BH01-0AA0 SM322, 16DO 24V DC, 0,5A	6ES7322-1BH10-0AA0 SM322 HIGH SPEED, 16DO 24V DC, 0,5A	6ES7322-1BL00-0AA0 SM322, 32DO 24V DC, 0,5A	6ES7322-1BP00-0AA0 SM322 64DA, DC24V, 0,3A P-WRITE	6ES7322-1BP50-0AA0 SM322 64DO, DC24V, 0,3A M-WRITE	6ES7322-8BF00-0AB0 SM322, 8DO, 24V DC, 0,5A
Switching frequency						
• with resistive load, max.	100 Hz	1 000 Hz	100 Hz	100 Hz	100 Hz	100 Hz
• with inductive load, max.	0.5 Hz	0.5 Hz	0.5 Hz	0.5 Hz	0.5 Hz	2 Hz
• on lamp load, max.	10 Hz	10 Hz	10 Hz	10 Hz	10 Hz	10 Hz
Total current of the outputs (per group)						
horizontal installation						
- up to 40 °C, max.	4 A	4 A	4 A	1.6 A	1.6 A	4 A
- up to 60 °C, max.	3 A	3 A	3 A	1.2 A	1.2 A	3 A
vertical installation						
- up to 40 °C, max.	2 A	2 A	2 A	1.6 A	1.6 A	4 A
Total current of the outputs (per module)						
horizontal installation						
- up to 60 °C, max.				4.8 A	4.8 A	
all other mounting positions						
- up to 40 °C, max.				6.4 A	6.4 A	
Cable length						
• shielded, max.	1 000 m	1 000 m	1 000 m	1 000 m	1 000 m	1 000 m
• unshielded, max.	600 m	600 m	600 m	600 m	600 m	600 m
Interrupts/diagnostics/status information						
Diagnostic functions	No	No	No	No	No	Yes; Parameterizable
Alarms						
• Diagnostic alarm	No	No	No	No	No	Yes; Parameterizable
Potential separation						
Potential separation digital outputs						
• between the channels	Yes	Yes	Yes	No	No	8
• between the channels, in groups of	8	8	8	16	16	8
• between the channels and backplane bus	Yes; Optocoupler	Yes; Optocoupler	Yes; Optocoupler	Yes; Optocoupler	Yes; Optocoupler	Yes; Optocoupler
Isolation						
Isolation tested with	500 V DC	500 V DC	500 V DC	500 V DC	500 V DC	500 V DC
Connection method						
required front connector	20-pin	20-pin	40-pin	Cable: 6ES7392-4Bxx0-0AA0 terminal blocks: 6ES7392-1xN00-0AA0	Cable: 6ES7392-4Bxx0-0AA0 terminal blocks: 6ES7392-1xN00-0AA0	20-pin
Dimensions						
Width	40 mm	40 mm	40 mm	40 mm	40 mm	40 mm
Height	125 mm	125 mm	125 mm	125 mm	125 mm	125 mm
Depth	120 mm	120 mm	120 mm	112 mm	112 mm	120 mm
Weights						
Weight, approx.	190 g	200 g	260 g	230 g	230 g	210 g

SIMATIC S7-300 Advanced Controllers

I/O modules

Digital modules

SM 322 digital output modules

Technical specifications (continued)

Article number	6ES7322-5GH00-0A00 SM322, 16DO, AC/DC24-48V, 0,5A	6ES7322-1CF00-0AA0 SM322, 8DO, 48-125V DC, 1,5A	6ES7322-1BF01-0AA0 SM322, 8DO, 24V DC, 2A	6ES7322-1FF01-0AA0 SM322, 8DO, 120/230V AC, 1A	6ES7322-5FF00-0A00 SM322, 8DO, AC120/230V, 2A	6ES7322-1FH00-0AA0 SM322, 16DO, 120/230V AC, 1A
Supply voltage						
Load voltage L+						
• Rated value (DC)	24 V; 24 / 48	48 V; 48 V DC to 125 V DC	24 V			
Load voltage L1						
• Rated value (AC)				230 V; 120/230V AC	230 V; 120/230V AC	230 V; 120/230V AC
Input current						
from supply voltage L+, max.	200 mA					
from load voltage L+ (without load), max.		2 mA	60 mA			
from load voltage L1 (without load), max.				2 mA	2 mA	2 mA
from backplane bus 5 V DC, max.	100 mA	100 mA	40 mA	100 mA	100 mA	200 mA
Power loss						
Power loss, typ.	2.8 W	7.2 W	6.8 W	8.6 W	8.6 W	8.6 W
Digital outputs						
Number of digital outputs	16	8	8	8	8	16
Limitation of inductive shutdown voltage to		M (-1 V)	L+ (-48 V)			
Switching capacity of the outputs						
• on lamp load, max.	2.5 W	15 W; 15 W (48 V) or 40 W (125 V)	10 W	50 W	50 W	50 W
Load resistance range						
• lower limit			12 Ω			
• upper limit			4 kΩ			
Output voltage						
• for signal *1*, min.	L+ (-0.25 V)	L+ (-1.2 V)	L+ (-0.8 V)	L1 (-1.5 V)	L1 (-8.5 V)	
Output current						
• for signal *1* rated value	0.5 A	1.5 A	2 A	2 A	2 A	1 A
• for signal *1* permissible range for 0 to 40 °C, min.		10 mA	5 mA	10 mA	10 mA	10 mA
• for signal *1* permissible range for 0 to 40 °C, max.	0.5 A	1.5 A	2.4 A	2 A	2 A	1 A
• for signal *1* permissible range for 40 to 60 °C, min.		10 mA	5 mA	10 mA	10 mA	10 mA
• for signal *1* permissible range for 40 to 60 °C, max.	0.5 A	1.5 A	2.4 A	1 A	1 A	0.5 A
• for signal *1* minimum load current		10 mA	5 mA	10 mA	10 mA	10 mA
• for signal *1* permissible surge current, max.	1.5 A; for 50 ms, 1 A 2 s one-time	3 A; for 10 ms		20 A; max. 1 AC cycle	20 A; with 2 half waves	20 A; with 2 half waves
• for signal *0* residual current, max.	10 μA	0.5 mA	0.5 mA	2 mA	2 mA	2 mA
Switching frequency						
• with resistive load, max.	10 Hz	25 Hz	100 Hz	10 Hz	10 Hz	10 Hz
• with inductive load, max.	0.5 Hz	0.5 Hz	0.5 Hz	0.5 Hz	0.5 Hz	0.5 Hz
• on lamp load, max.	0.5 Hz	10 Hz	10 Hz	1 Hz	1 Hz	1 Hz

Technical specifications (continued)

Article number	6ES7322-5GH00-0AB0	6ES7322-1CF00-0AA0	6ES7322-1BF01-0AA0	6ES7322-1FF01-0AA0	6ES7322-5FF00-0AB0	6ES7322-1FH00-0AA0
	SM322, 16DO, AC/DC24-48V, 0,5A	SM322, 8DO, 48-125V DC, 1,5A	SM322, 8DO, 24V DC, 2A	SM322, 8DO, 120/230V AC, 1A	SM322, 8DO, AC120/230V, 2A	SM322, 16DO, 120/230V AC, 1A
Total current of the outputs (per group)						
horizontal installation						
- up to 40 °C, max.	0.5 A; 8 A per module	6 A	4 A	4 A	8 A	4 A
- up to 60 °C, max.	0.5 A; 8 A per module	3 A	4 A	2 A	4 A	2 A
vertical installation						
- up to 40 °C, max.	0.5 A; 8 A per module	4 A	4 A	2 A	4 A	2 A
Cable length						
• shielded, max.	1 000 m	1 000 m	1 000 m	1 000 m	1 000 m	1 000 m
• unshielded, max.	600 m	600 m	600 m	600 m	600 m	600 m
Interrupts/diagnostics/status information						
Diagnostic functions	Yes; Parameterizable	No	No	Yes; Fuse blown or load voltage missing	Yes; Parameterizable	Yes; Fuse blown or load voltage missing
Alarms						
• Diagnostic alarm	Yes; Parameterizable	No	No	No	Yes; Parameterizable	No
Potential separation						
Potential separation digital outputs						
• between the channels	Yes	Yes	Yes	Yes	Yes	
• between the channels, in groups of	1	4	4	4	1	8
• between the channels and backplane bus	Yes; Optocoupler	Yes; Optocoupler	Yes; Optocoupler	Yes; Optocoupler	Yes; Optocoupler	Yes; Optocoupler
Isolation						
Isolation tested with	1500 V AC	1500 V AC	500 V DC	1500 V AC	1500 V AC	4 000 V DC
Connection method						
required front connector	40-pin	20-pin	20-pin	20-pin	40-pin	20-pin
Dimensions						
Width	40 mm	40 mm	40 mm	40 mm	40 mm	40 mm
Height	125 mm	125 mm	125 mm	125 mm	125 mm	125 mm
Depth	120 mm	120 mm	120 mm	120 mm	120 mm	120 mm
Weights						
Weight, approx.	260 g	250 g	190 g	275 g	275 g	275 g

SIMATIC S7-300 Advanced Controllers

I/O modules

Digital modules

SM 322 digital output modules

Technical specifications (continued)

Article number	6ES7322-1FL00-0AA0 SM322, 32DO, 120/230V AC, 1A	6ES7322-1HF01-0AA0 SM322, 8DA, 24V DC/2A OR 230V AC/2A	6ES7322-1HF10-0AA0 SM322, 8DA, 24V DC/5A OR 230V AC/5A	6ES7322-5HF00-0AB0 SM322, 8DO RELAY, 24VDC, 120-230V AC, 5A	6ES7322-1HH01-0AA0 SM322, 16DO RELAY
Supply voltage					
Load voltage L+					
• Rated value (DC)		24 V	120 V	24 V	120 V
Load voltage L1					
• Rated value (AC)	120 V; 120/230V AC		230 V	230 V	230 V
Input current					
from supply voltage L+, max.		160 mA	125 mA	160 mA	250 mA
from load voltage L1 (without load), max.	10 mA				
from backplane bus 5 V DC, max.	190 mA	40 mA	40 mA	100 mA	100 mA
Power loss					
Power loss, typ.	25 W	3.2 W	3.2 W	3.5 W	4.5 W
Digital outputs					
Number of digital outputs	32	8; Relays	8; Relays	8; Relays	16; Relays
Switching capacity of the outputs					
• on lamp load, max.	50 W	50 W	1 500 W; 230 V AC	1 500 W; 230 V AC	50 W; 230 V AC
Output voltage					
• for signal "1", min.	L1 (-0.8 V)				
Output current					
• for signal "1" rated value	1 A	2 A	5 A	5 A	2 A
• for signal "1" permissible range for 0 to 40 °C, min.	10 mA				
• for signal "1" permissible range for 0 to 40 °C, max.	1 A				
• for signal "1" permissible range for 40 to 60 °C, min.	10 mA				
• for signal "1" permissible range for 40 to 60 °C, max.	1 A				
• for signal "1" minimum load current	10 mA	5 mA	5 mA	10 mA	10 mA
• for signal "1" permissible surge current, max.	10 A; per group (for 2 AC cycles)				
• for signal "0" residual current, max.	2 mA				
Switching frequency					
• with resistive load, max.	10 Hz	2 Hz	2 Hz	2 Hz	1 Hz
• with inductive load, max.	0.5 Hz	0.5 Hz	0.5 Hz	0.5 Hz	0.5 Hz
• on lamp load, max.	1 Hz	2 Hz	2 Hz	2 Hz	1 Hz
• mechanical, max.		10 Hz	10 Hz	10 Hz	10 Hz
Total current of the outputs (per group)					
horizontal installation					
- up to 40 °C, max.	4 A				
- up to 60 °C, max.	3 A		5 A	5 A	8 A
vertical installation					
- up to 40 °C, max.	4 A		5 A	5 A	8 A

Technical specifications (continued)

Article number	6ES7322-1FL00-0AA0 SM322, 32DO, 120/230V AC, 1A	6ES7322-1HF01-0AA0 SM322, 8DA, 24V DC/2A OR 230V AC/2A	6ES7322-1HF10-0AA0 SM322, 8DA, 24V DC/5A OR 230V AC/5A	6ES7322-5HF00-0AB0 SM322, 8DO RELAY, 24VDC, 120-230V AC, 5A	6ES7322-1HH01-0AA0 SM322, 16DO RELAY
Relay outputs					
• Rated supply voltage of relay coil L+ (DC)		24 V; 110 mA	24 V		24 V
• Number of operating cycles, max.		300 000; 230 V AC: 100 000; 120 V AC: 200 000; 24 V DC: 300 000 (at 2 A)	300 000; 300000 (24 V DC, at 2 A); 200000 (120 V AC, at 3 A); 100000 (230 V AC, at 3 A)	100 000; 100000 (24 V DC, at 5 A); 100000 (230 V AC, at 5 A)	100 000; 50000 (24 V DC, at 2 A); 700000 (120 V AC, at 2 A); 100000 (230 V AC, at 2 A)
Switching capacity of contacts					
- with inductive load, max.		2 A; 2 A (230 V AC), 2 A (24 V DC)	3 A; 3 A (230 V DC), 2 A (24 V AC)	5 A; 5 A (230 V DC), 5 A (24 V AC)	2 A; 2 A (230 V AC), 2 A (24 V DC)
- with resistive load, max.		2 A	8 A; 8 A (230 V DC), 5 A (24 V AC)	5 A; 5 A (230 V DC), 5 A (24 V AC)	2 A; 2 A (230 V AC), 2 A (24 V DC)
Cable length					
• shielded, max.	1 000 m	1 000 m	1 000 m	1 000 m	1 000 m
• unshielded, max.	600 m	600 m	600 m	600 m	600 m
Interrupts/diagnostics/status information					
Diagnostic functions	Yes; Fuse blown or load voltage missing	No	No	Yes; Parameterizable	No
Alarms					
• Diagnostic alarm	No	No	No	Yes; Parameterizable	No
Potential separation					
Potential separation digital outputs					
• between the channels	Yes	Yes	Yes	Yes	Yes
• between the channels, in groups of	8	2	1	1	8
• between the channels and backplane bus	Yes; Optocoupler	Yes; Optocoupler	Yes; Optocoupler	Yes; Optocoupler	Yes; Optocoupler
Isolation					
Isolation tested with	4 000 V DC	1500 V AC	2000 V AC	1500 V AC	1500 V AC
Connection method					
required front connector	20-pin	20-pin	40-pin	40-pin	20-pin
Dimensions					
Width	80 mm	40 mm	40 mm	40 mm	40 mm
Height	125 mm	125 mm	125 mm	125 mm	125 mm
Depth	117 mm	120 mm	120 mm	120 mm	120 mm
Weights					
Weight, approx.	500 g	190 g	320 g	320 g	250 g

SIMATIC S7-300 Advanced Controllers

I/O modules

Digital modules

SM 322 digital output modules

Ordering data

SM 322 digital output modules

incl. labeling strips, bus connector

8 outputs, 24 V DC, 2 A

6ES7322-1BF01-0AA0

16 outputs, 24 V DC, 0.5 A

6ES7322-1BH01-0AA016 outputs, 24 V DC, 0.5 A,
high speed**6ES7322-1BH10-0AA0**

32 outputs, 24 V DC, 0.5 A

6ES7322-1BL00-0AA0

64 outputs, 24 V DC, 0.3 A

6ES7322-1BP00-0AA0**Note:**6ES7392-4...0-0AA0 connecting
cable and 6ES7392-1.N00-0AA0
terminal blocks necessary.64 outputs, 24 V DC, 0.3 A,
sink output**6ES7322-1BP50-0AA0****Note:**6ES7392-4...0-0AA0 connecting
cable and 6ES7392-1.N00-0AA0
terminal blocks necessary.8 outputs, 24 V DC, 0.5 A,
diagnostics-capable**6ES7322-8BF00-0AB0**

16 outputs, 24/48 V DC, 0.5 A

6ES7322-5GH00-0AB0

8 outputs, 48 to 125 V DC, 1.5 A

6ES7322-1CF00-0AA0

8 outputs, 120/230 V AC, 1 A

6ES7322-1FF01-0AA0

8 outputs, 120/230 V AC, 2 A

6ES7322-5FF00-0AB0

16 outputs, 120/230 V AC, 1 A

6ES7322-1FH00-0AA0

32 outputs, 120 V AC, 1 A

6ES7322-1FL00-0AA0

8 outputs, relay contacts, 2 A

6ES7322-1HF01-0AA0

8 outputs, relay contacts, 5 A

6ES7322-1HF10-0AA08 outputs, relay contacts, 5 A, with
RC filter, overvoltage protection**6ES7322-5HF00-0AB0**

16 outputs, relay contacts, 8 A

6ES7322-1HH01-0AA0

Front connector

20-pin, with screw contacts

- 1 unit
- 100 units

6ES7392-1AJ00-0AA0**6ES7392-1AJ00-1AB0**

20-pin, with spring-loaded contacts

- 1 unit
- 100 units

6ES7392-1BJ00-0AA0**6ES7392-1BJ00-1AB0**

40-pin, with screw contacts

- 1 unit
- 100 units

6ES7392-1AM00-0AA0**6ES7392-1AM00-1AB0**

40-pin, with spring-loaded contacts

- 1 unit
- 100 units

6ES7392-1BM01-0AA0**6ES7392-1BM01-1AB0**

S7-300 connecting cable

For 64-channel modules; 2 units

1 m

6ES7392-4BB00-0AA0

2.5 m

6ES7392-4BC50-0AA0

5 m

6ES7392-4BF00-0AA0

Terminal block

For 64-channel modules; 2 units

With screw contacts

6ES7392-1AN00-0AA0

With spring-loaded contacts

6ES7392-1BN00-0AA0

Front door, elevated design

e.g. for 32-channel modules;
for connecting 1.3 mm²/16 AWG
conductors**6ES7328-0AA00-7AA0**

SIMATIC TOP connect

See page 5/248

Bus connectors

1 unit (spare part)

6ES7390-0AA00-0AA0

Set of fuses for SM 322

10 fuses 8 A quick-response, 2 fuse
holders; for 6ES7 322-1FF01-0AA0,
6ES7 322-1FH00-0AA0**6ES7973-1HD00-0AA0**10 fuses 6.3 A; for 6ES7 322-
1CF00-0AA0**6ES7973-1GC00-0AA0**

Labeling strips

10 units (spare part)

for modules with
20-pin front connector**6ES7392-2XX00-0AA0**for modules with
40-pin front connector**6ES7392-2XX10-0AA0**

Label cover

10 units (spare part)

for modules with
20-pin front connector**6ES7392-2XY00-0AA0**for modules with
40-pin front connector**6ES7392-2XY10-0AA0**

Labeling sheets for machine inscription

for modules with 20-pin front
connector, DIN A4, for printing
with laser printer; 10 units

Petrol

6ES7392-2AX00-0AA0

Light beige

6ES7392-2BX00-0AA0

Yellow

6ES7392-2CX00-0AA0

Red

6ES7392-2DX00-0AA0for modules with 40-pin front
connector, DIN A4, for printing
with laser printer; 10 units

Petrol

6ES7392-2AX10-0AA0

Light beige

6ES7392-2BX10-0AA0

Yellow

6ES7392-2CX10-0AA0

Red

6ES7392-2DX10-0AA0

SIMATIC Manual Collection

6ES7998-8XC01-8YE0Electronic manuals on DVD,
multilingual:
LOGO!, SIMADYN, SIMATIC bus
components, SIMATIC C7,
SIMATIC distributed I/O,
SIMATIC HMI, SIMATIC Sensors,
SIMATIC NET, SIMATIC PC Based
Automation, SIMATIC PCS 7,
SIMATIC PG/PC, SIMATIC S7,
SIMATIC Software, SIMATIC TDC

SIMATIC Manual Collection update service for 1 year

6ES7998-8XC01-8YE2Current "Manual Collection" DVD
and the three subsequent updates

Overview



- Digital inputs and outputs
- For connecting standard switches, two-wire proximity switches, solenoid valves, contactors, low-power motors, lamps and motor starters

Technical specifications

Article number	6ES7323-1BH01-0AA0 SM323, 8DI/8DO, DC24V, 0,5A	6ES7323-1BL00-0AA0 SM323, 16DI/DO, DC24V, 0,5A	6ES7327-1BH00-0AB0 SIMATIC S7-300, DIGITAL MODULE
Supply voltage			
Load voltage L+			
• Rated value (DC)	24 V	24 V	24 V
Input current			
from load voltage L+ (without load), max.	40 mA	80 mA	20 mA
from backplane bus 5 V DC, max.	40 mA	80 mA	60 mA
Power loss			
Power loss, typ.	3.5 W	6.5 W	3 W
Digital inputs			
Number of digital inputs	8	16	8; 8 hard-wired, 8 others individually parameterizable
Input characteristic curve in accordance with IEC 61131, type 1	Yes	Yes	Yes
Number of simultaneously controllable inputs			
horizontal installation			
- up to 60 °C, max.	8	8	16
vertical installation			
- up to 40 °C, max.	8	16	16
Input voltage			
• Type of input voltage	DC	DC	DC
• Rated value (DC)	24 V	24 V	24 V
• for signal "0"	-30 to +5V	-30 to +5V	-30 to +5V
• for signal "1"	13 to 30V	13 to 30V	+15 to +30V
Input current			
• for signal "1", typ.	7 mA	7 mA	6 mA
Input delay (for rated value of input voltage) for standard inputs			
- at "0" to "1", min.	1.2 ms	1.2 ms	1.2 ms
- at "0" to "1", max.	4.8 ms	4.8 ms	4.8 ms
Cable length			
• shielded, max.	1 000 m	1 000 m	1 000 m
• unshielded, max.	600 m	600 m	600 m

SIMATIC S7-300 Advanced Controllers

I/O modules

Digital modules

SM 323/SM 327 digital input/output modules**Technical specifications** (continued)

Article number	6ES7323-1BH01-0AA0 SM323, 8DI/8DO, DC24V, 0,5A	6ES7323-1BL00-0AA0 SM323, 16DI/DO, DC24V, 0,5A	6ES7327-1BH00-0AB0 SIMATIC S7-300, DIGITAL MODULE
Digital outputs			
Number of digital outputs	8	16	8; can also be parameterized individually as DI
Short-circuit protection	Yes	Yes	Yes
• Response threshold, typ.	1 A	1 A	1 A
Limitation of inductive shutdown voltage to	L+ (-53 V)	L+ (-48 V)	L+ (-54 V)
Controlling a digital input	Yes	Yes	Yes
Switching capacity of the outputs			
• on lamp load, max.	5 W	5 W	5 W
Load resistance range			
• lower limit	48 Ω	48 Ω	48 Ω
• upper limit	4 kΩ	4 kΩ	4 kΩ
Output voltage			
• for signal "1", min.	L+ (-0.8 V)	L+ (-0.8 V)	L+ (-1.5 V)
Output current			
• for signal "1" rated value	0.5 A	0.5 A	0.5 A
• for signal "1" permissible range, min.	5 mA	5 mA	5 mA
• for signal "1" permissible range, max.	0.6 A	0.6 A	0.6 A
• for signal "1" minimum load current	5 mA	5 mA	
• for signal "0" residual current, max.	0.5 mA	0.5 mA	0.5 mA
Output delay with resistive load			
• "0" to "1", max.	100 μs	100 μs	350 μs
• "1" to "0", max.	500 μs	500 μs	500 μs
Parallel switching of two outputs			
• for uprating	No	No	No
• for redundant control of a load	Yes; only outputs of the same group	Yes; only outputs of the same group	Yes; only outputs of the same group
Switching frequency			
• with resistive load, max.	100 Hz	100 Hz	100 Hz
• with inductive load, max.	0.5 Hz	0.5 Hz	0.5 Hz
• on lamp load, max.	10 Hz	100 Hz	10 Hz
Total current of the outputs (per group)			
horizontal installation			
- up to 40 °C, max.	4 A	4 A	4 A
- up to 60 °C, max.	4 A	3 A	3 A
vertical installation			
- up to 40 °C, max.	4 A	2 A	2 A
Cable length			
• shielded, max.	1 000 m	1 000 m	1 000 m
• unshielded, max.	600 m	600 m	600 m

Technical specifications (continued)

Article number	6ES7323-1BH01-0AA0 SM323, 8DI/8DO, DC24V, 0,5A	6ES7323-1BL00-0AA0 SM323, 16DI/DO, DC24V, 0,5A	6ES7327-1BH00-0AB0 SIMATIC S7-300, DIGITAL MODULE
Encoder			
Connectable encoders			
• 2-wire sensor	Yes	Yes	Yes
- permissible quiescent current (2-wire sensor), max.	2 mA	1.5 mA	1.5 mA
Isochronous mode			
Isochronous operation (application synchronized up to terminal)	No	No	No
Interrupts/diagnostics/status information			
Alarms	No	No	No
Diagnostic functions	No	No	No
Diagnostics indication LED			
• Status indicator digital input (green)	Yes	Yes	Yes
• Status indicator digital output (green)	Yes	Yes	Yes
Potential separation			
Potential separation digital inputs			
• between the channels	Yes	Yes	No
• between the channels, in groups of 8	8	16	
• between the channels and backplane bus	Yes; Optocoupler	Yes; Optocoupler	Yes; Optocoupler
Potential separation digital outputs			
• between the channels	Yes	Yes	No
• between the channels, in groups of 8	8	8	
• between the channels and backplane bus	Yes; Optocoupler	Yes; Optocoupler	Yes; Optocoupler
Isolation			
Isolation tested with	500 V DC	500 V DC	500 V DC
Connection method			
required front connector	20-pin	40-pin	20-pin
Dimensions			
Width	40 mm	40 mm	40 mm
Height	125 mm	125 mm	125 mm
Depth	120 mm	120 mm	120 mm
Weights			
Weight, approx.	220 g	260 g	200 g

SIMATIC S7-300 Advanced Controllers

I/O modules

Digital modules

SM 323/SM 327 digital input/output modules

Ordering data

Article No.

SM 323 digital input/output modules

incl. labeling strips, bus connector

8 inputs, 8 outputs

6ES7323-1BH01-0AA0

16 inputs, 16 outputs

6ES7323-1BL00-0AA0

SM 327 digital input/output modules

incl. labeling strips, bus connector

8 inputs, 8 inputs or outputs
(can be configured)**6ES7327-1BH00-0AB0**

Front connector

20-pin, with screw contacts

- 1 unit
- 100 units

6ES7392-1AJ00-0AA0
6ES7392-1AJ00-1AB0

20-pin, with spring-loaded contacts

- 1 unit
- 100 units

6ES7392-1BJ00-0AA0
6ES7392-1BJ00-1AB0

40-pin, with screw contacts

- 1 unit
- 100 units

6ES7392-1AM00-0AA0
6ES7392-1AM00-1AB0

40-pin, with spring-loaded contacts

- 1 unit
- 100 units

6ES7392-1BM01-0AA0
6ES7392-1BM01-1AB0

Front door, elevated design

6ES7328-0AA00-7AA0e.g. for 32 channel modules;
enables connection of
1.3 mm²/16 AWG wires

SIMATIC TOP connect

See page 5/248

Bus connectors

6ES7390-0AA00-0AA0

1 unit (spare part)

Labeling strips

10 units (spare part)

for modules with
20-pin front connector**6ES7392-2XX00-0AA0**for modules with
40-pin front connector**6ES7392-2XX10-0AA0**

Label cover

10 units (spare part)

for modules with
20-pin front connector**6ES7392-2XY00-0AA0**for modules with
40-pin front connector**6ES7392-2XY10-0AA0**

Article No.

Labeling sheets for machine inscription

for modules with 20-pin front
connector, DIN A4, for printing
with laser printer; 10 units

Petrol

6ES7392-2AX00-0AA0

Light beige

6ES7392-2BX00-0AA0

Yellow

6ES7392-2CX00-0AA0

Red

6ES7392-2DX00-0AA0for modules with 40-pin front
connector, DIN A4, for printing
with laser printer; 10 units

Petrol

6ES7392-2AX10-0AA0

Light beige

6ES7392-2BX10-0AA0

Yellow

6ES7392-2CX10-0AA0

Red

6ES7392-2DX10-0AA0

SIMATIC Manual Collection

6ES7998-8XC01-8YE0Electronic manuals on DVD,
multilingual:
LOGO!, SIMADYN, SIMATIC bus
components, SIMATIC C7,
SIMATIC distributed I/O,
SIMATIC HMI, SIMATIC Sensors,
SIMATIC NET, SIMATIC PC Based
Automation, SIMATIC PCS 7,
SIMATIC PG/PC, SIMATIC S7,
SIMATIC Software, SIMATIC TDC

SIMATIC Manual Collection update service for 1 year

6ES7998-8XC01-8YE2Current "Manual Collection" DVD
and the three subsequent updates

Overview



- Digital inputs
- For connection of switches and 2-wire proximity switches (BEROs)

Note:

SIPLUS extreme products are based on SIMATIC standard products. The contents listed here were taken from the respective standard products. SIPLUS extreme-specific information was added.

Technical specifications

Article number	6AG1321-1BH02-2AA0	6AG1321-1BL00-2AA0	6AG1321-1CH20-2AA0	6AG1321-1FF01-2AA0	6AG1321-1FF10-7AA0
Based on	6ES7321-1BH02-0AAA0	6ES7321-1BL00-0AAA0	6ES7321-1CH20-0AAA0	6ES7321-1FF01-0AAA0	6ES7321-1FF10-0AAA0
	SIPLUS SM321 16DE/24VDC	SIPLUS SM321 32DE/24VDC	SIPLUS SM 321 16DE/ DC 48-125 V	SIPLUS S7-300 SM321 8DE/120/230VAC	SIPLUS S7-300 SM321 8DI/120/230VAC
Ambient conditions					
Ambient temperature during operation					
• min.	-40 °C; = Tmin	-40 °C; = Tmin	-25 °C	-40 °C; = Tmin	-25 °C
• max.	70 °C; = Tmax; 60 °C @ UL/cUL, ATEX and FM use	70 °C; = Tmax; for use on railway vehicles according to EN50155, the rated temperature range -25 ... +55 °C (T1) or 60 °C @ UL/ ULhaz/ATEX/FM use applies	70 °C; = Tmax; for use on railway vehicles according to EN50155, the rated temperature range -25 ... +55 °C (T1) or 60 °C @ UL/ ULhaz/ATEX/FM use applies	70 °C; = Tmax; for use on railway vehicles according to EN50155, the rated temperature range -25 ... +55 °C (T1) or 60 °C @ UL/ ULhaz/ATEX/FM use applies	70 °C; = Tmax; 60 °C @ UL/cUL, ATEX and FM use
Ambient temperature during storage/transportation					
• min.	-40 °C	-40 °C	-40 °C	-40 °C	-40 °C
• max.	70 °C	70 °C	70 °C	70 °C	70 °C
Extended ambient conditions					
• relative to ambient temperature-atmospheric pressure-installation altitude	Tmin ... Tmax at 1080 hPa ... 795 hPa (-1000 m ... +2000 m) // Tmin ... (Tmax - 10K) at 795 hPa ... 658 hPa (+2000 m ... +3500 m) // Tmin ... (Tmax - 20K) at 658 hPa ... 540 hPa (+3500 m ... +5000 m)	Tmin ... Tmax at 1080 hPa ... 795 hPa (-1000 m ... +2000 m) // Tmin ... (Tmax - 10K) at 795 hPa ... 658 hPa (+2000 m ... +3500 m) // Tmin ... (Tmax - 20K) at 658 hPa ... 540 hPa (+3500 m ... +5000 m)	Tmin ... Tmax at 1080 hPa ... 795 hPa (-1000 m ... +2000 m) // Tmin ... (Tmax - 10K) at 795 hPa ... 658 hPa (+2000 m ... +3500 m) // Tmin ... (Tmax - 20K) at 658 hPa ... 540 hPa (+3500 m ... +5000 m)	Tmin ... Tmax at 1080 hPa ... 795 hPa (-1000 m ... +2000 m)	Tmin ... Tmax at 1080 hPa ... 795 hPa (-1000 m ... +2000 m)

SIMATIC S7-300 Advanced Controllers

I/O modules

SIPLUS S7-300 digital modules

SIPLUS S7-300 SM 321

Technical specifications (continued)

Article number	6AG1321-1BH02-2AA0	6AG1321-1BL00-2AA0	6AG1321-1CH20-2AA0	6AG1321-1FF01-2AA0	6AG1321-1FF10-7AA0
Based on	6ES7321-1BH02-0AA0 SIPLUS SM321 16DE/24VDC	6ES7321-1BL00-0AA0 SIPLUS SM321 32DE/24VDC	6ES7321-1CH20-0AA0 SIPLUS SM 321 16DE/ DC 48-125 V	6ES7321-1FF01-0AA0 SIPLUS S7-300 SM321 8DE/120/230VAC	6ES7321-1FF10-0AA0 SIPLUS S7-300 SM321 8DI/120/230VAC
Relative humidity	100 %; RH incl. condensation / frost (no commissioning in bedewed state), horizontal installation				
- With condensation, tested in accordance with IEC 60068-2-38, max.	100 %; RH incl. condensation / frost (no commissioning in bedewed state), horizontal installation				
Resistance	Yes; Class 3B2 mold, fungus and dry rot spores (with the exception of fauna). The supplied connector covers must remain on the unused interfaces during operation!				
- against biologically active substances / conformity with EN 60721-3-3	Yes; Class 3B2 mold, fungus and dry rot spores (with the exception of fauna). The supplied connector covers must remain on the unused interfaces during operation!				
- against chemically active substances / conformity with EN 60721-3-3	Yes; Class 3C4 (RH < 75%) incl. salt spray according to EN 60068-2-52 (degree of severity 3). The supplied connector covers must remain on the unused interfaces during operation!				
- against mechanically active substances / conformity with EN 60721-3-3	Yes; Class 3S4 incl. sand, dust. The supplied connector covers must remain on the unused interfaces during operation!				

Article number	6AG1321-1FH00-7AA0	6AG1321-7BH01-2AB0	6AG1321-7TH00-4AB0
Based on	6ES7321-1FH00-0AA0 SIPLUS S7-300 SM 321 16DI/120/230VAC	6ES7321-7BH01-0AB0 SIPLUS SM321 16DE/24VDC	6ES7321-7TH00-0AB0 SIPLUS PCS 7 SM321 16DE
Ambient conditions			
Ambient temperature during operation			
• min.	-40 °C; = Tmin	-25 °C	0 °C
• max.	70 °C; = Tmax; 60 °C @ UL/cUL, ATEX and FM use	70 °C; = Tmax; 60 °C @ UL/cUL, ATEX and FM use	60 °C
Ambient temperature during storage/transportation			
• min.	-40 °C	-40 °C	-40 °C
• max.	70 °C	70 °C	70 °C
Extended ambient conditions			
• relative to ambient temperature-atmospheric pressure-installation altitude	Tmin ... Tmax at 1080 hPa ... 795 hPa (-1000 m ... +2000 m)	Tmin ... Tmax at 1080 hPa ... 795 hPa (-1000 m ... +2000 m) // Tmin ... (Tmax - 10K) at 795 hPa ... 658 hPa (+2000 m ... +3500 m) // Tmin ... (Tmax - 20K) at 658 hPa ... 540 hPa (+3500 m ... +5000 m)	Tmin ... Tmax at 1080 hPa ... 795 hPa (-1000 m ... +2000 m) // Tmin ... (Tmax - 10K) at 795 hPa ... 658 hPa (+2000 m ... +3500 m) // Tmin ... (Tmax - 20K) at 658 hPa ... 540 hPa (+3500 m ... +5000 m)
• At cold restart, min.	0 °C		

Technical specifications (continued)

Article number	6AG1321-1FH00-7AA0	6AG1321-7BH01-2AB0	6AG1321-7TH00-4AB0
Based on	6ES7321-1FH00-0AA0 SIPLUS S7-300 SM 321 16DI/120/230VAC	6ES7321-7BH01-0AB0 SIPLUS SM321 16DE/24VDC	6ES7321-7TH00-0AB0 SIPLUS PCS 7 SM321 16DE
Relative humidity	100 %; RH incl. condensation / frost (no commissioning in bedewed state), horizontal installation	100 %; RH incl. condensation / frost (no commissioning in bedewed state), horizontal installation	100 %; RH incl. condensation / frost (no commissioning in bedewed state), horizontal installation
Resistance			
- With condensation, tested in accordance with IEC 60068-2-38, max.	100 %; RH incl. condensation / frost (no commissioning in bedewed state), horizontal installation	100 %; RH incl. condensation / frost (no commissioning in bedewed state), horizontal installation	100 %; RH incl. condensation / frost (no commissioning in bedewed state), horizontal installation
- against biologically active substances / conformity with EN 60721-3-3	Yes; Class 3B2 mold, fungus and dry rot spores (with the exception of fauna). The supplied connector covers must remain on the unused interfaces during operation!	Yes; Class 3B2 mold, fungus and dry rot spores (with the exception of fauna). The supplied connector covers must remain on the unused interfaces during operation!	Yes; Class 3B2 mold, fungus and dry rot spores (with the exception of fauna). The supplied connector covers must remain on the unused interfaces during operation!
- against chemically active substances / conformity with EN 60721-3-3	Yes; Class 3C4 (RH < 75%) incl. salt spray according to EN 60068-2-52 (degree of severity 3). The supplied connector covers must remain on the unused interfaces during operation!	Yes; Class 3C4 (RH < 75%) incl. salt spray according to EN 60068-2-52 (degree of severity 3). The supplied connector covers must remain on the unused interfaces during operation!	Yes; Class 3C4 (RH < 75%) incl. salt spray according to EN 60068-2-52 (degree of severity 3). The supplied connector covers must remain on the unused interfaces during operation!
- against mechanically active substances / conformity with EN 60721-3-3	Yes; Class 3S4 incl. sand, dust. The supplied connector covers must remain on the unused interfaces during operation!	Yes; Class 3S4 incl. sand, dust. The supplied connector covers must remain on the unused interfaces during operation!	Yes; Class 3S4 incl. sand, dust. The supplied connector covers must remain on the unused interfaces during operation!

Ordering data

SIPLUS S7-300 SM 321 digital input modules

For industrial applications with extended ambient conditions

Extended temperature range and exposure to media

16 inputs, 24 V DC
32 inputs, 24 V DC
16 inputs, 48 to 120 V DC
8 inputs, 120/230 V AC
8 inputs, 120/230 V AC, single root
16 inputs, 120/230 V AC
16 inputs, 24 V DC, diagnostics-capable

Exposure to media

16 inputs, NAMUR, redundant design possible

Article No.

6AG1321-1BH02-2AA0
6AG1321-1BL00-2AA0
6AG1321-1CH20-2AA0
6AG1321-1FF01-2AA0
6AG1321-1FF10-7AA0
6AG1321-1FH00-7AA0
6AG1321-7BH01-2AB0

6AG1321-7TH00-4AB0

Article No.

For rolling stock railway applications

Conforms to EN 50155

16 inputs, 24 V DC
32 inputs, 24 V DC
16 inputs, 48 to 120 V DC
8 inputs, 120/230 V AC
16 inputs, 24 V DC, diagnostics-capable

6AG1321-1BH02-2AA0
6AG1321-1BL00-2AA0
6AG1321-1CH20-2AA0
6AG1321-1FF01-2AA0
6AG1321-7BH01-2AB0

SIMATIC S7-300 Advanced Controllers

I/O modules

SIPLUS S7-300 digital modules

SIPLUS S7-300 SM 321

Ordering data	Article No.	Ordering data	Article No.
Accessories		<i>Documentation</i>	
<i>Mandatory</i>		SIMATIC Manual Collection	6ES7998-8XC01-8YE0
Front connector		Electronic manuals on DVD, multi-language: LOGO!, SIMADYN, SIMATIC bus components, SIMATIC C7, SIMATIC distributed I/O, SIMATIC HMI, SIMATIC Sensors, SIMATIC NET, SIMATIC PC Based Automation, SIMATIC PCS 7, SIMATIC PG/PC, SIMATIC S7, SIMATIC Software, SIMATIC TDC	
20-pin, with spring-loaded contacts			
• 1 unit	6ES7392-1BJ00-0AA0		
• 100 units	6ES7392-1BJ00-1AB0		
40-pin, with spring-loaded contacts			
• 1 unit	6ES7392-1BM01-0AA0		
• 100 units	6ES7392-1BM01-1AB0		
<i>Consumables</i>		SIMATIC Manual Collection update service for 1 year	6ES7998-8XC01-8YE2
Front door, elevated design	6ES7328-0AA00-7AA0	Current "Manual Collection" DVD and the three subsequent updates	
E.g. for 32-channel modules; for connecting 1.3 mm ² /16 AWG conductors; circuit diagram and nameplates in petrol			
Bus connectors	6ES7390-0AA00-0AA0		
1 unit (spare part)			
Labeling strips			
10 units; spare part			
For modules with 20-pin front connector	6ES7392-2XX00-0AA0		
For modules with 40-pin front connector	6ES7392-2XX10-0AA0		
Label cover			
10 units; spare part			
For modules with 20-pin front connector	6ES7392-2XY00-0AA0		
For modules with 40-pin front connector	6ES7392-2XY10-0AA0		

Overview



- Digital outputs
- For connecting solenoid valves, contactors, small-power motors, lamps and motor starters

Note:

SIPLUS extreme products are based on SIMATIC standard products. The contents listed here were taken from the respective standard products. SIPLUS extreme-specific information was added.

Technical specifications

Article number	6AG1322-1BF01-2XB0	6AG1322-8BF00-2AB0	6AG1322-1BH01-2AA0	6AG1322-1BL00-2AA0
Based on	6ES7322-1BF01-0AA0 SIPLUS S7-300 SM322 8DO/24VDC 2A	6ES7322-8BF00-0AB0 SIPLUS SM322 8DA/24VDC	6ES7322-1BH01-0AA0 SIPLUS S7-300 SM322 16DA/24VDC 0.5A	6ES7322-1BL00-0AA0 SIPLUS S7-300 SM322 32DO/24VDC 0.5A
Ambient conditions				
Ambient temperature during operation				
• min.	-25 °C	-25 °C; = Tmin	-25 °C	-25 °C; = Tmin
• max.	70 °C; = Tmax; 60 °C @ UL/cUL use	70 °C; = Tmax; 60 °C @ UL/cUL use	70 °C; = Tmax; for use on railway vehicles according to EN50155, the rated temperature range -25 ... +55 °C (T1) or 60 °C @ UL/ULhaz/ATEX/FM use applies	70 °C; = Tmax; for use on railway vehicles according to EN50155, the rated temperature range -25 ... +55 °C (T1) or 60 °C @ UL/ULhaz/ATEX/FM use applies
Ambient temperature during storage/transportation				
• min.	-40 °C		-40 °C	-40 °C
• max.	70 °C		70 °C	70 °C
Extended ambient conditions				
• relative to ambient temperature-atmospheric pressure-installation altitude	Tmin ... Tmax at 1080 hPa ... 795 hPa (-1000 m ... +2000 m) // Tmin ... (Tmax - 10K) at 795 hPa ... 658 hPa (+2000 m ... +3500 m) // Tmin ... (Tmax - 20K) at 658 hPa ... 540 hPa (+3500 m ... +5000 m)	Tmin ... Tmax at 1080 hPa ... 795 hPa (-1000 m ... +2000 m) // Tmin ... (Tmax - 10K) at 795 hPa ... 658 hPa (+2000 m ... +3500 m) // Tmin ... (Tmax - 20K) at 658 hPa ... 540 hPa (+3500 m ... +5000 m)	Tmin ... Tmax at 1080 hPa ... 795 hPa (-1000 m ... +2000 m) // Tmin ... (Tmax - 10K) at 795 hPa ... 658 hPa (+2000 m ... +3500 m) // Tmin ... (Tmax - 20K) at 658 hPa ... 540 hPa (+3500 m ... +5000 m)	Tmin ... Tmax at 1080 hPa ... 795 hPa (-1000 m ... +2000 m) // Tmin ... (Tmax - 10K) at 795 hPa ... 658 hPa (+2000 m ... +3500 m) // Tmin ... (Tmax - 20K) at 658 hPa ... 540 hPa (+3500 m ... +5000 m)
Relative humidity				
- With condensation, tested in accordance with IEC 60068-2-38, max.	100 %; RH incl. condensation/frost (no commissioning under condensation conditions)	100 %; RH incl. condensation/frost (no commissioning under condensation conditions)	100 %; RH incl. condensation/frost (no commissioning under condensation conditions)	100 %; RH incl. condensation/frost (no commissioning under condensation conditions)

SIMATIC S7-300 Advanced Controllers

I/O modules

SIPLUS S7-300 digital modules

SIPLUS S7-300 SM 322

Technical specifications (continued)

Article number	6AG1322-1BF01-2XB0	6AG1322-8BF00-2AB0	6AG1322-1BH01-2AA0	6AG1322-1BL00-2AA0
Based on	6ES7322-1BF01-0AA0 SIPLUS S7-300 SM322 8DO/24VDC 2A	6ES7322-8BF00-0AB0 SIPLUS SM322 8DA/24VDC	6ES7322-1BH01-0AA0 SIPLUS S7-300 SM322 16DA/24VDC 0.5A	6ES7322-1BL00-0AA0 SIPLUS S7-300 SM322 32DO/24VDC 0.5A
Resistance				
- against biologically active substances / conformity with EN 60721-3-3	Yes; Class 3B2 mold, fungus and dry rot spores (with the exception of fauna). The supplied connector covers must remain on the unused interfaces during operation!	Yes; Class 3B2 mold, fungus and dry rot spores (with the exception of fauna). The supplied connector covers must remain on the unused interfaces during operation!	Yes; Class 3B2 mold, fungus and dry rot spores (with the exception of fauna). The supplied connector covers must remain on the unused interfaces during operation!	Yes; Class 3B2 mold, fungus and dry rot spores (with the exception of fauna). The supplied connector covers must remain on the unused interfaces during operation!
- against chemically active substances / conformity with EN 60721-3-3	Yes; Class 3C4 (RH < 75%) incl. salt spray according to EN 60068-2-52 (degree of severity 3). The supplied connector covers must remain on the unused interfaces during operation!	Yes; Class 3C4 (RH < 75%) incl. salt spray according to EN 60068-2-52 (degree of severity 3). The supplied connector covers must remain on the unused interfaces during operation!	Yes; Class 3C4 (RH < 75%) incl. salt spray according to EN 60068-2-52 (degree of severity 3). The supplied connector covers must remain on the unused interfaces during operation!	Yes; Class 3C4 (RH < 75%) incl. salt spray according to EN 60068-2-52 (degree of severity 3). The supplied connector covers must remain on the unused interfaces during operation!
- against mechanically active substances / conformity with EN 60721-3-3	Yes; Class 3S4 incl. sand, dust. The supplied connector covers must remain on the unused interfaces during operation!	Yes; Class 3S4 incl. sand, dust. The supplied connector covers must remain on the unused interfaces during operation!	Yes; Class 3S4 incl. sand, dust. The supplied connector covers must remain on the unused interfaces during operation!	Yes; Class 3S4 incl. sand, dust. The supplied connector covers must remain on the unused interfaces during operation!
Article number	6AG1322-1CF00-7AA0	6AG1322-1HF10-2AA0	6AG1322-5HF00-4AB0	6AG1322-1FF01-7AA0
Based on	6ES7322-1CF00-0AA0 SIPLUS SM322 8DA/48-125VDC	6ES7322-1HF10-0AA0 SIPLUS SM322 8DA - Relais	6ES7322-5HF00-0AB0 SIPLUS_SM322_8RO	6ES7322-1FF01-0AA0 SIPLUS S7-300 SM322 8DA/120/220VAC 1A
Ambient conditions				
Ambient temperature during operation				
• min.	-25 °C	-25 °C	0 °C; = Tmin	-40 °C
• max.	70 °C; = Tmax; for use on railway vehicles according to EN50155, the rated temperature range -25 ... +55 °C (T1) or 60 °C @ UL/ULhaz/ATEX/FM use applies	60 °C	60 °C; = Tmax	70 °C; = Tmax; for use on railway vehicles according to EN 50155, the rated temperature range -25 ... +55 °C (T1) or 60 °C @ UL/UL hazardous use applies
Ambient temperature during storage/transportation				
• min.	-40 °C	-40 °C	-40 °C	-40 °C
• max.	70 °C	70 °C	70 °C	70 °C
Extended ambient conditions				
• relative to ambient temperature-atmospheric pressure-installation altitude	Tmin ... Tmax at 1080 hPa ... 795 hPa (-1000 m ... +2000 m)	Tmin ... Tmax at 1080 hPa ... 795 hPa (-1000 m ... +2000 m)	Tmin ... Tmax at 1080 hPa ... 795 hPa (-1000 m ... +2000 m)	Tmin ... Tmax at 1080 hPa ... 795 hPa (-1000 m ... +2000 m)
Relative humidity				
- With condensation, tested in accordance with IEC 60068-2-38, max.	100 %; RH incl. condensation/frost (no commissioning under condensation conditions)	100 %; RH incl. condensation/frost (no commissioning under condensation conditions)	100 %; RH incl. condensation/frost (no commissioning under condensation conditions)	100 %; RH incl. condensation/frost (no commissioning under condensation conditions)

Technical specifications (continued)

Article number	6AG1322-1CF00-7AA0	6AG1322-1HF10-2AA0	6AG1322-5HF00-4AB0	6AG1322-1FF01-7AA0
Based on	6ES7322-1CF00-0AA0 SIPLUS SM322 8DA/48-125VDC	6ES7322-1HF10-0AA0 SIPLUS SM322 8DA - Relais	6ES7322-5HF00-0AB0 SIPLUS_SM322_8RO	6ES7322-1FF01-0AA0 SIPLUS S7-300 SM322 8DA/120/220VAC 1A
Resistance				
- against biologically active substances / conformity with EN 60721-3-3	Yes; Class 3B2 mold, fungus and dry rot spores (with the exception of fauna). The supplied connector covers must remain on the unused interfaces during operation!	Yes; Class 3B2 mold, fungus and dry rot spores (with the exception of fauna). The supplied connector covers must remain on the unused interfaces during operation!	Yes; Class 3B2 mold, fungus and dry rot spores (with the exception of fauna). The supplied connector covers must remain on the unused interfaces during operation!	Yes; Class 3B2 mold, fungus and dry rot spores (with the exception of fauna). The supplied connector covers must remain on the unused interfaces during operation!
- against chemically active substances / conformity with EN 60721-3-3	Yes; Class 3C4 (RH < 75%) incl. salt spray according to EN 60068-2-52 (degree of severity 3). The supplied connector covers must remain on the unused interfaces during operation!	Yes; Class 3C4 (RH < 75%) incl. salt spray according to EN 60068-2-52 (degree of severity 3). The supplied connector covers must remain on the unused interfaces during operation!	Yes; Class 3C4 (RH < 75%) incl. salt spray according to EN 60068-2-52 (degree of severity 3). The supplied connector covers must remain on the unused interfaces during operation!	Yes; Class 3C4 (RH < 75%) incl. salt spray according to EN 60068-2-52 (degree of severity 3). The supplied connector covers must remain on the unused interfaces during operation!
- against mechanically active substances / conformity with EN 60721-3-3	Yes; Class 3S4 incl. sand, dust. The supplied connector covers must remain on the unused interfaces during operation!	Yes; Class 3S4 incl. sand, dust. The supplied connector covers must remain on the unused interfaces during operation!	Yes; Class 3S4 incl. sand, dust. The supplied connector covers must remain on the unused interfaces during operation!	Yes; Class 3S4 incl. sand, dust. The supplied connector covers must remain on the unused interfaces during operation!
Article number	6AG1322-5FF00-4AB0	6AG1322-1FH00-7AA0	6AG1322-1HH01-2AA0	
Based on	6ES7322-5FF00-0AB0 SIPLUS S7-300 SM322 8DO	6ES7322-1FH00-0AA0 SIPLUS S7-300 SM 322 16DO 120/ 230VAC 1A	6ES7322-1HH01-0AA0 SIPLUS SM322	
Ambient conditions				
Ambient temperature during operation				
• min.	0 °C; = Tmin	-40 °C; = Tmin	-40 °C	
• max.	60 °C; = Tmax	70 °C; = Tmax; 60 °C @ UL/cUL, ATEX and FM use	70 °C; = Tmax; 60 °C @ UL/cUL, ATEX and FM use	
Ambient temperature during storage/transportation				
• min.	-40 °C	-40 °C	-40 °C	
• max.	70 °C	70 °C	70 °C	
Extended ambient conditions				
• relative to ambient temperature-atmospheric pressure-installation altitude	Tmin ... Tmax at 1080 hPa ... 795 hPa (-1000 m ... +2000 m)	Tmin ... Tmax at 1080 hPa ... 795 hPa (-1000 m ... +2000 m)	Tmin ... Tma x at 1080 hPa ... 795 hPa (-1000 m ... +2000 m)	
Relative humidity				
- With condensation, tested in accordance with IEC 60068-2-38, max.	100 %; RH incl. condensation/frost (no commissioning under condensation conditions)		100 %; RH incl. condensation/frost (no commissioning under condensation conditions)	
Resistance				
- against biologically active substances / conformity with EN 60721-3-3	Yes; Class 3B2 mold, fungus and dry rot spores (with the exception of fauna). The supplied connector covers must remain on the unused interfaces during operation!	Yes; Class 3B2 mold, fungus and dry rot spores (with the exception of fauna). The supplied connector covers must remain on the unused interfaces during operation!	Yes; Class 3B2 mold, fungus and dry rot spores (with the exception of fauna). The supplied connector covers must remain on the unused interfaces during operation!	
- against chemically active substances / conformity with EN 60721-3-3	Yes; Class 3C4 (RH < 75%) incl. salt spray according to EN 60068-2-52 (degree of severity 3). The supplied connector covers must remain on the unused interfaces during operation!	Yes; Class 3C4 (RH < 75%) incl. salt spray according to EN 60068-2-52 (degree of severity 3). The supplied connector covers must remain on the unused interfaces during operation!	Yes; Class 3C4 (RH < 75%) incl. salt spray according to EN 60068-2-52 (degree of severity 3). The supplied connector covers must remain on the unused interfaces during operation!	
- against mechanically active substances / conformity with EN 60721-3-3	Yes; Class 3S4 incl. sand, dust. The supplied connector covers must remain on the unused interfaces during operation!	Yes; Class 3S4 incl. sand, dust. The supplied connector covers must remain on the unused interfaces during operation!	Yes; Class 3S4 incl. sand, dust. The supplied connector covers must remain on the unused interfaces during operation!	

SIMATIC S7-300 Advanced Controllers

I/O modules

SIPLUS S7-300 digital modules

SIPLUS S7-300 SM 322**Ordering data****Article No.****SIPLUS S7-300 SM 322 digital output modules***For industrial applications with extended ambient conditions*Extended temperature range and exposure to media

8 outputs, 24 V DC, 2 A

6AG1322-1BF01-2XB0

16 outputs, 24 V DC, 0.5 A

6AG1322-1BH01-2AA0

32 outputs, 24 V DC, 0.5 A

6AG1322-1BL00-2AA0

8 outputs, 48 to 125 V DC, 1.5 A

6AG1322-1CF00-7AA0

8 outputs, 120/230 V AC, 1 A

6AG1322-1FF01-7AA0

16 outputs, 120/230 V AC, 1 A

6AG1322-1FH00-7AA0

8 outputs, relay contacts, 5 A

6AG1322-1HF10-2AA0

16 outputs, relay contacts, 8 A

6AG1322-1HH01-2AA0

8 outputs, 24 V DC, 0.5 A, diagnostics-capable

6AG1322-8BF00-2AB0Exposure to media

8 outputs, 120/230 V AC, 2 A

6AG1322-5FF00-4AB0

8 outputs, relay contacts, 5 A, with RC filter, overvoltage protection

6AG1322-5HF00-4AB0*For rolling stock railway applications*Conforms to EN 50155

16 outputs, 24 V DC, 0.5 A, high speed

6AG1322-1BH01-2AA0

32 outputs, 24 V DC, 0.5 A

6AG1322-1BL00-2AA0

8 outputs, relay contacts, 5 A

6AG1322-1HF10-2AA0

16 outputs, relay contacts, 8 A

6AG1322-1HH01-2AA0

8 outputs, 24 V DC, 0.5 A, diagnostics-capable

6AG1322-8BF00-2AB0**Article No.****Accessories***Mandatory***Front connector**

20-pin, with spring-loaded contacts

- 1 unit
- 100 units

6ES7392-1BJ00-0AA0
6ES7392-1BJ00-1AB0

40-pin, with spring-loaded contacts

- 1 unit
- 100 units

6ES7392-1BM01-0AA0
6ES7392-1BM01-1AB0*Consumables***Front door, elevated design**E.g. for 32-channel modules; for connecting 1.3 mm²/16 AWG conductors; circuit diagram and nameplates in petrol**6ES7328-0AA00-7AA0****Bus connectors**

1 unit (spare part)

6ES7390-0AA00-0AA0**Labeling strips**

10 units; spare part

For modules with 20-pin front connector

6ES7392-2XX00-0AA0

For modules with 40-pin front connector

6ES7392-2XX10-0AA0**Label cover**

10 units; spare part

For modules with 20-pin front connector

6ES7392-2XY00-0AA0

For modules with 40-pin front connector

6ES7392-2XY10-0AA0*Documentation***SIMATIC Manual Collection**

Electronic manuals on DVD, multi-language: LOGO!, SIMADYN, SIMATIC bus components, SIMATIC C7, SIMATIC distributed I/O, SIMATIC HMI, SIMATIC Sensors, SIMATIC NET, SIMATIC PC Based Automation, SIMATIC PCS 7, SIMATIC PG/PC, SIMATIC S7, SIMATIC Software, SIMATIC TDC

6ES7998-8XC01-8YE0**SIMATIC Manual Collection update service for 1 year**

Current "Manual Collection" DVD and the three subsequent updates

6ES7998-8XC01-8YE2

Overview



- Digital inputs and outputs
- For connection of switches, 2-wire proximity switches (BEROs), solenoid valves, contactors, low-power motors, lamps and motor starters

Note:

SIPLUS extreme products are based on SIMATIC standard products. The contents listed here were taken from the respective standard products. SIPLUS extreme specific information was added.

Technical specifications

Article number	6AG1323-1BH01-2AA0
Based on	6ES7323-1BH01-0AA0 SIPLUS SM323 8DE/8DA
Ambient conditions	
Ambient temperature during operation	
• min.	-40 °C; = Tmin
• max.	70 °C; = Tmax; 60 °C @ UL/cUL, ATEX and FM use
Extended ambient conditions	
• relative to ambient temperature-atmospheric pressure-installation altitude	Tmin ... Tmax at 1080 hPa ... 795 hPa (-1000 m ... +2000 m) // Tmin ... (Tmax - 10K) at 795 hPa ... 658 hPa (+2000 m ... +3500 m) // Tmin ... (Tmax - 20K) at 658 hPa ... 540 hPa (+3500 m ... +5000 m)
Relative humidity	
- With condensation, tested in accordance with IEC 60068-2-38, max.	100 %; RH incl. condensation/frost (no commissioning under condensation conditions)
Resistance	
- against biologically active substances / conformity with EN 60721-3-3	Yes; Class 3B2 mold, fungus and dry rot spores (with the exception of fauna). The supplied connector covers must remain on the unused interfaces during operation!
- against chemically active substances / conformity with EN 60721-3-3	Yes; Class 3C4 (RH < 75%) incl. salt spray according to EN 60068-2-52 (degree of severity 3). The supplied connector covers must remain on the unused interfaces during operation!
- against mechanically active substances / conformity with EN 60721-3-3	Yes; Class 3S4 incl. sand, dust. The supplied connector covers must remain on the unused interfaces during operation!

SIMATIC S7-300 Advanced Controllers

I/O modules

SIPLUS S7-300 digital modules

SIPLUS S7-300 SM 323**Ordering data****Article No.****SIPLUS S7-300 SM 323
digital input/output module***For industrial applications with
extended ambient conditions*Extended temperature range
and exposure to media

8 inputs, 8 outputs

6AG1323-1BH01-2AA0*For rolling stock railway
applications*Conforms to EN 50155

8 inputs, 8 outputs

6AG1323-1BH01-2AA0**Accessories***Mandatory***Front connector**

20-pin, with spring-loaded contacts

- 1 unit
- 100 units

**6ES7392-1BJ00-0AA0
6ES7392-1BJ00-1AB0**

40-pin, with spring-loaded contacts

- 1 unit
- 100 units

**6ES7392-1BM01-0AA0
6ES7392-1BM01-1AB0***Consumables***Front door, elevated design**E.g. for 32-channel modules;
for connecting 1.3 mm²/16 AWG
conductors; circuit diagram and
nameplates in petrol**6ES7328-0AA00-7AA0****Bus connectors**

1 unit (spare part)

6ES7390-0AA00-0AA0**Labeling strips**

10 units; spare part

For modules with
20-pin front connector**6ES7392-2XX00-0AA0**For modules with
40-pin front connector**6ES7392-2XX10-0AA0****Article No.****Label cover**

10 units; spare part

For modules with
20-pin front connector**6ES7392-2XY00-0AA0**For modules with
40-pin front connector**6ES7392-2XY10-0AA0***Documentation***SIMATIC Manual Collection**Electronic manuals on DVD,
multi-language:
LOGO!, SIMADYN, SIMATIC bus
components, SIMATIC C7,
SIMATIC distributed I/O,
SIMATIC HMI, SIMATIC Sensors,
SIMATIC NET, SIMATIC PC Based
Automation, SIMATIC PCS 7,
SIMATIC PG/PC, SIMATIC S7,
SIMATIC Software, SIMATIC TDC**6ES7998-8XC01-8YE0****SIMATIC Manual Collection
update service for 1 year**Current "Manual Collection" DVD
and the three subsequent updates**6ES7998-8XC01-8YE2**

Overview



- Analog inputs
- For connection of voltage and current sensors, thermocouples, resistors and resistance thermometers

Technical specifications

Article number	6ES7331-7KF02-0AB0 SM331, 8AI, 9/12/14BIT	6ES7331-7HF01-0AB0 SIMATIC S7-300, ANALOG INPUT	6ES7331-1KF02-0AB0 SM331, 8AI, 13BIT	6ES7331-7KB02-0AB0 SM331, 2AI, 9/12/14BIT
Supply voltage				
Load voltage L+				
• Rated value (DC)	24 V	24 V		24 V
Input current				
from load voltage L+ (without load), max.	30 mA	50 mA		30 mA
from backplane bus 5 V DC, max.	50 mA	100 mA	90 mA	50 mA
Power loss				
Power loss, typ.	1 W	1.5 W	0.4 W	1 W
Analog inputs				
Number of analog inputs	8	8	8	2
• For resistance measurement	4		8	1
permissible input voltage for voltage input (destruction limit), max.	20 V; continuous; 75 V for max. 1 s (mark to space ratio 1:20)	20 V; 20 V DC permanent, 75 V DC for max. 1 s (duty factor 1:20)	30 V; 12 V continuous, 30 V for max. 1 s	20 V; continuous; 75 V for max. 1 s (mark to space ratio 1:20)
permissible input current for current input (destruction limit), max.	40 mA	40 mA	40 mA	40 mA
Input ranges (rated values), voltages				
• 0 to +10 V	No	No	Yes	No
• 1 V to 5 V	Yes	Yes	Yes	Yes
• 1 V to 10 V	No		No	No
• -1 V to +1 V	Yes	Yes	Yes	Yes
• -10 V to +10 V	Yes	Yes	Yes	Yes
• -2.5 V to +2.5 V	Yes		No	Yes
• -250 mV to +250 mV	Yes		No	Yes
• -5 V to +5 V	Yes	Yes	Yes	Yes
• -50 mV to +50 mV	No		Yes	No
• -500 mV to +500 mV	Yes	Yes	Yes	Yes
• -80 mV to +80 mV	Yes	Yes	No	Yes

SIMATIC S7-300 Advanced Controllers

I/O modules

Analog modules

SM 331 analog input modules

Technical specifications (continued)

Article number	6ES7331-7KF02-0AB0 SM331, 8AI, 9/12/14BIT	6ES7331-7HF01-0AB0 SIMATIC S7-300, ANALOG INPUT	6ES7331-1KF02-0AB0 SM331, 8AI, 13BIT	6ES7331-7KB02-0AB0 SM331, 2AI, 9/12/14BIT
Input ranges (rated values), currents				
• 0 to 20 mA	Yes	Yes	Yes	Yes
• -10 mA to +10 mA	Yes		No	Yes
• -20 mA to +20 mA	Yes	Yes	Yes	Yes
• -3.2 mA to +3.2 mA	Yes		No	Yes
• 4 mA to 20 mA	Yes	Yes	Yes	Yes
Input ranges (rated values), thermocouples				
• Type B	No		No	No
• Type C	No		No	
• Type E	Yes		No	Yes
• Type J	Yes		No	Yes
• Type K	Yes		No	Yes
• Type L	Yes		No	No
• Type N	Yes		No	Yes
• Type R	No		No	No
• Type S	No		No	No
• Type T	No		No	No
• Type U	No		No	No
• Type TXK/TXK(L) to GOST	No		No	No
Input ranges (rated values), resistance thermometer				
• Cu 10	No		No	No
• Ni 100	Yes; Standard		Yes; Standard/climate	Yes
• Ni 1000	No		Yes	No
• LG-Ni 1000	No		Yes; Standard/climate	No
• Ni 120	No		No	No
• Ni 200	No		No	No
• Ni 500	No		No	No
• Pt 100	Yes; Standard		Yes; Standard/climate	Yes
• Pt 1000	No		No	No
• Pt 200	No		No	No
• Pt 500	No		No	No
Input ranges (rated values), resistors				
• 0 to 150 ohms	Yes		No	Yes
• 0 to 300 ohms	Yes		No	Yes
• 0 to 600 ohms	Yes		Yes	Yes
• 0 to 6000 ohms	No		Yes	No
Thermocouple (TC)				
Temperature compensation				
- parameterizable	Yes		No	Yes
- internal temperature compensation	Yes		No	Yes
- external temperature compensation with compensations socket	Yes		No	Yes
Characteristic linearization				
• parameterizable	Yes		Yes	Yes
- for thermocouples	Type E, J, K, L, N		No	Type E, J, K, L, N
- for resistance thermometer	Pt100 (standard, climatic range), Ni100 (standard, climatic range)		yes; Pt100 standard/air con.; Ni100 standard/air con.; Ni1000 standard/air con.; LG-Ni1000 standard/air con.	Pt100 (standard, climatic range), Ni100 (standard, climatic range)
Cable length				
• shielded, max.	200 m; 50 m at 80 mV and thermocouples	200 m	200 m; max. 50 m at 50 mV	200 m; 50 m at 80 mV and thermocouples

Technical specifications (continued)

Article number	6ES7331-7KF02-0AB0 SM331, 8AI, 9/12/14BIT	6ES7331-7HF01-0AB0 SIMATIC S7-300, ANALOG INPUT	6ES7331-1KF02-0AB0 SM331, 8AI, 13BIT	6ES7331-7KB02-0AB0 SM331, 2AI, 9/12/14BIT
Analog value generation for the inputs				
Measurement principle	integrating	Actual value encryption	integrating	integrating
Integration and conversion time/resolution per channel				
<ul style="list-style-type: none"> Resolution with overrange (bit including sign), max. Integration time, parameterizable Basic conversion time (ms) Interference voltage suppression for interference frequency f1 in Hz 	15 bit; Unipolar: 9/12/12/14 bit; bipolar: 9 bit + sign/12 bit + sign/ 12 bit + sign/14 bit + sign Yes; 2,5 / 16,67 / 20 / 100 ms 3 / 17 / 22 / 102 ms 400 / 60 / 50 / 10 Hz	14 bit; Unipolar: 14 bit; bipolar: 13 bit + sign Yes 52 µs per channel none / 400 / 60 / 50 Hz	13 bit Yes; 60 / 50 ms 66 / 55 ms 50 / 60 Hz	15 bit; Unipolar: 9/12/12/14 bit; bipolar: 9 bit + sign/12 bit + sign/ 12 bit + sign/14 bit + sign Yes; 2,5 / 16,67 / 20 / 100 ms 3 / 17 / 22 / 102 ms 400 / 60 / 50 / 10 Hz
Encoder				
Connection of signal encoders				
<ul style="list-style-type: none"> for current measurement as 2-wire transducer for current measurement as 4-wire transducer for resistance measurement with two-wire connection for resistance measurement with three-wire connection for resistance measurement with four-wire connection 	Yes Yes Yes Yes Yes	Yes Yes	Yes; with external supply Yes Yes Yes Yes	Yes Yes Yes Yes Yes
Errors/accuracies				
Operational error limit in overall temperature range				
<ul style="list-style-type: none"> Voltage, relative to input range, (+/-) Current, relative to input range, (+/-) Resistance, relative to input range, (+/-) Resistance thermometer, relative to input range, (+/-) 	1 %; ±1% (80 mV); ±0.6% (250 mV to 1 000 mV); ±0.8% (2.5 V to 10 V)	0.4 % 0.3 %	0.6 %; +/-0.6% (+/-5 V, 10 V, 1 to 5 V, 0 to 10 V); +/-0.5% (+/-50 mV, 500 mV, 1 V)	1 %; ±1% (80 mV); ±0.6% (250 mV to 1 000 mV); ±0.8% (2.5 V to 10 V)
<ul style="list-style-type: none"> Resistance, relative to input range, (+/-) Resistance thermometer, relative to input range, (+/-) 	0.7 %; 150, 300, 600 Ohm 0.7 %; +/-0.7% (Pt100/ Ni100); +/-0.8% (Pt100 climate)	0.7 %; 150, 300, 600 Ohm 0.7 %; +/-0.7% (Pt100/ Ni100); +/-0.8% (Pt100 climate)	0.5 %; +/-20 mA, 0 to 20 mA, 4 to 20 mA 0.5 %; 0 to 6 kohms, 0 to 600 kohms 1 Kelvin (Pt100, Ni100, climatic; Ni1000, LG-Ni1000, standard; Ni1000, LG-Ni1000, climatic); 1,2 Kelvin (Pt100, Ni100, standard)	0.7 %; 150, 300, 600 Ohm 0.7 %; +/-0.7% (Pt100/ Ni100); +/-0.8% (Pt100 climate)
Basic error limit (operational limit at 25 °C)				
<ul style="list-style-type: none"> Voltage, relative to input range, (+/-) Current, relative to input range, (+/-) Resistance, relative to input range, (+/-) Resistance thermometer, relative to input range, (+/-) 	0.6 %; ±0.4 % (250 mV to 1 000 mV); ±0.6 % (2.5 mV to 10 mV); ±0.7 % (80 mV)	0.25 % 0.2 %	0.4 %; 0.4% (+/-5 V, 10 V, 1 to 5 V, 0 to 10 V); 0.3% (+/-50 mV, 500 mV, 1 V)	0.6 %; ±0.6% (80 mV, 2.5 V to 10 V); ±0.4% (250 mV to 1 000 mV)
<ul style="list-style-type: none"> Resistance, relative to input range, (+/-) Resistance thermometer, relative to input range, (+/-) 	0.5 %; 150, 300, 600 Ohm 0.6 %; ±0.5% (Pt100/ Ni100), ±0.6% (Pt100 climate)	0.5 %; 150, 300, 600 Ohm 0.6 %; ±0.5% (Pt100/ Ni100), ±0.6% (Pt100 climate)	0.3 %; +/-20 mA, 0 to 20 mA, 4 to 20 mA 0.3 %; 0 to 6 kohms, 0 to 600 kohms 1 Kelvin (Pt100, Ni100, standard); 0.8 Kelvin (Pt100, Ni100, climatic; Ni1000, LG-Ni1000, standard; Ni1000, LG-Ni1000, climatic)	0.5 %; 150, 300, 600 Ohm 0.6 %; ±0.5% (Pt100/ Ni100), ±0.6% (Pt100 climate)

SIMATIC S7-300 Advanced Controllers

I/O modules

Analog modules

SM 331 analog input modules

Technical specifications (continued)

Article number	6ES7331-7KF02-0AB0 SM331, 8AI, 9/12/14BIT	6ES7331-7HF01-0AB0 SIMATIC S7-300, ANALOG INPUT	6ES7331-1KF02-0AB0 SM331, 8AI, 13BIT	6ES7331-7KB02-0AB0 SM331, 2AI, 9/12/14BIT
Interrupts/diagnostics/ status information				
Alarms				
• Diagnostic alarm	Yes; Parameterizable, channels 0 and 2	Yes; Parameterizable	No	Yes
• Limit value alarm	Yes; Parameterizable	Yes; Parameterizable, channels 0 and 2	No	Yes; Parameterizable, channel 0
Diagnostic messages				
• Diagnostic information readable	Yes	Yes	No	Yes
Potential separation				
Potential separation analog inputs				
• between the channels and backplane bus	Yes	Yes	Yes	Yes
Isolation				
Isolation tested with	500 V DC	500 V DC	500 V DC	500 V DC
Connection method				
required front connector	20-pin	20-pin	40-pin	20-pin
Dimensions				
Width	40 mm	40 mm	40 mm	40 mm
Height	125 mm	125 mm	125 mm	125 mm
Depth	117 mm	117 mm	117 mm	120 mm
Weights				
Weight, approx.	250 g	230 g	250 g	250 g

Article number	6ES7331-7PF01-0AB0 SIMATIC S7-300, ANALOG INPUT	6ES7331-7PF11-0AB0 SIMATIC S7-300, ANALOG INPUT	6ES7331-7PE10-0AB0 SM331, 6AI, 16BIT, THERMOCOUPLE	6ES7331-7NF00-0AB0 SIMATIC S7-300, ANALOG INPUT	6ES7331-7NF10-0AB0 SIMATIC S7-300, ANALOG INPUT
Supply voltage					
Load voltage L+					
• Rated value (DC)	24 V	24 V	24 V		24 V
Input current					
from load voltage L+ (without load), max.	240 mA	240 mA	150 mA		200 mA
from backplane bus 5 V DC, max.	100 mA	100 mA	100 mA	130 mA	100 mA
Power loss					
Power loss, typ.	4.6 W	3 W	2.2 W	0.6 W	3 W
Analog inputs					
Number of analog inputs	8	8	6	8	8
• For resistance measurement	8				
permissible input voltage for voltage input (destruction limit), max.	75 V; 35 V continuous, 75 V for max. 1 s (mark to space ratio 1:20)	75 V; 20 V DC permanent, 75 V DC for max. 1 s (duty factor 1:20)	35 V; 35 V continuous, 75 V for max. 1 s (mark to space ratio 1:20)	50 V; Permanent	75 V; 35 V continuous, 75 V for max. 1 s (mark to space ratio 1:20)
permissible input current for current input (destruction limit), max.				32 mA	40 mA
Input ranges (rated values), voltages					
• 0 to +10 V	No	No	No	No	No
• 1 V to 5 V	No	No	No	Yes	Yes
• 1 V to 10 V	No	No	No	No	No
• -1 V to +1 V	No	No	Yes	No	No
• -10 V to +10 V	No	No	No	Yes	Yes
• -2.5 V to +2.5 V	No	No	No	No	No
• -250 mV to +250 mV	No	No	Yes	No	No
• -5 V to +5 V	No	No	No	Yes	Yes
• -50 mV to +50 mV	No	No	Yes	No	No
• -500 mV to +500 mV	No	No	Yes	No	No
• -80 mV to +80 mV	No	No	Yes	No	No

Technical specifications (continued)

Article number	6ES7331-7PF01-0AB0 SIMATIC S7-300, ANALOG INPUT	6ES7331-7PF11-0AB0 SIMATIC S7-300, ANALOG INPUT	6ES7331-7PE10-0AB0 SM331, 6AI, 16BIT, THERMOCOUPLE	6ES7331-7NF00-0AB0 SIMATIC S7-300, ANALOG INPUT	6ES7331-7NF10-0AB0 SIMATIC S7-300, ANALOG INPUT
Input ranges (rated values), currents					
• 0 to 20 mA	No	No	No	Yes	Yes
• -10 mA to +10 mA	No	No	No	No	No
• -20 mA to +20 mA	No	No	No	Yes	Yes
• -3.2 mA to +3.2 mA	No	No	No	No	No
• 4 mA to 20 mA	No	No	No	Yes	Yes
Input ranges (rated values), thermocouples					
• Type B	No	Yes	Yes	No	No
• Type C	No	Yes	Yes	No	No
• Type E	No	Yes	Yes	No	No
• Type J	No	Yes	Yes	No	No
• Type K	No	Yes	Yes	No	No
• Type L	No	Yes	Yes	No	No
• Type N	No	Yes	Yes	No	No
• Type R	No	Yes	Yes	No	No
• Type S	No	Yes	Yes	No	No
• Type T	No	Yes	Yes	No	No
• Type U	No	Yes	Yes	No	No
• Type TXK/TXK(L) to GOST	No	Yes	Yes	No	No
Input ranges (rated values), resistance thermometer					
• Cu 10	Yes	No	No	No	No
• Ni 100	Yes	No	No	No	No
• Ni 1000	Yes	No	No	No	No
• LG-Ni 1000	Yes	No	No	No	No
• Ni 120	Yes	No	No	No	No
• Ni 200	Yes	No	No	No	No
• Ni 500	Yes	No	No	No	No
• Pt 100	Yes	No	No	No	No
• Pt 1000	Yes	No	No	No	No
• Pt 200	Yes	No	No	No	No
• Pt 500	Yes	No	No	No	No
Input ranges (rated values), resistors					
• 0 to 150 ohms	Yes	No	No	No	No
• 0 to 300 ohms	Yes	No	No	No	No
• 0 to 600 ohms	Yes	No	No	No	No
• 0 to 6000 ohms		No	No	No	No
Thermocouple (TC)					
Temperature compensation					
- parameterizable		Yes	Yes		
- internal temperature compensation		Yes	Yes		
- external temperature compensation with compensations socket		Yes	Yes		
- external temperature compensation with Pt100		Yes	Yes		

SIMATIC S7-300 Advanced Controllers

I/O modules

Analog modules

SM 331 analog input modules

Technical specifications (continued)

Article number	6ES7331-7PF01-0AB0 SIMATIC S7-300, ANALOG INPUT	6ES7331-7PF11-0AB0 SIMATIC S7-300, ANALOG INPUT	6ES7331-7PE10-0AB0 SM331, 6AI, 16BIT, THERMOCOUPLE	6ES7331-7NF00-0AB0 SIMATIC S7-300, ANALOG INPUT	6ES7331-7NF10-0AB0 SIMATIC S7-300, ANALOG INPUT
Characteristic linearization					
• parameterizable	Yes	Yes	Yes		
- for thermocouples		Type B, E, J, K, L, N, R, S, T, U, C	Type B, E, J, K, L, N, R, S, T, U, C, TXK, XK(L)		
- for resistance thermometer	Pt100, Pt200, Pt500, Pt1000, Ni100, Ni120, Ni200, Ni500, Ni1000, Cu10; (standard/ climate)		No		
Cable length					
• shielded, max.	200 m	100 m	200 m	200 m	200 m
Analog value generation for the inputs					
Measurement principle	integrating	integrating	integrating	integrating	integrating
Integration and conversion time/resolution per channel					
• Resolution with overrange (bit including sign), max.	16 bit; Two's complement	16 bit; Two's complement	16 bit; Two's complement	16 bit; Unipolar: 15/15/15/15 bit; bipolar: 15 bit + sign/ 15 bit + sign/15 bit + sign/15 bit + sign	16 bit; Unipolar: 15/15/15/15 bit; bipolar: 15 bit + sign/ 15 bit + sign/15 bit + sign/15 bit + sign
• Integration time, parameterizable	Yes	Yes	Yes	Yes; 10/ 16.67/ 20/ 100 ms	Yes; 23 / 72 / 83 / 95 ms
• Basic conversion time (ms)	up to 4 channels: 10 ms per module, over 5 channels: 190 ms per module, 8 channels: 80 ms	Up to 4 channels: 10 ms per module, 5 channels upwards: 190 ms per module	30 / 50 / 60 / 300 ms		10 ms (4-channel mode); 95/83/72/23 ms (8-channel mode)
• Integration time (ms)			10/ 16.67/ 20/ 100 ms		
• Interference voltage suppression for interference frequency f1 in Hz	400 / 60 / 50 Hz	400 / 60 / 50 Hz	10 / 50 / 60 / 400 Hz	400 / 60 / 50 / 10 Hz	400 / 60 / 50 Hz, combinations of 400, 60, 50 Hz
Encoder					
Connection of signal encoders					
• for current measurement as 2-wire transducer				Yes; with external transmitter; possible with separate supply for transmitter	Yes; with external transmitter, current supply; possible with separate supply for transmitter
• for current measurement as 4-wire transducer				Yes	Yes
• for resistance measurement with two-wire connection	Yes; without resistance correction				
• for resistance measurement with three-wire connection	Yes				
• for resistance measurement with four-wire connection	Yes				
Errors/accuracies					
Operational error limit in overall temperature range					
• Voltage, relative to input range, (+/-)		+/- 1 K	Operating error at 0 ... 60 °C: ±0.12% @ ±25 mV, ±0.08% @ ±50 mV, ±0.6% @ ±80 mV, ±0.05% @ ±250 mV, ±0.05% @ 500 mV, ±0.05% @ ±1 V	0.1 %; At Ucm = 0 V or ±0.7 % at Ucm = 50 V	0.1 %
• Current, relative to input range, (+/-)				0.3 %; At Ucm = 0 V or ±0.9 % at Ucm = 50 V	0.1 %
• Resistance, relative to input range, (+/-)	0.1 %				
• Resistance thermometer, relative to input range, (+/-)	+/- 1 K				

Technical specifications (continued)

Article number	6ES7331-7PF01-0AB0 SIMATIC S7-300, ANALOG INPUT	6ES7331-7PF11-0AB0 SIMATIC S7-300, ANALOG INPUT	6ES7331-7PE10-0AB0 SM331, 6AI, 16BIT, THERMOCOUPLE	6ES7331-7NF00-0AB0 SIMATIC S7-300, ANALOG INPUT	6ES7331-7NF10-0AB0 SIMATIC S7-300, ANALOG INPUT
Basic error limit (operational limit at 25 °C)					
• Voltage, relative to input range, (+/-)			See manual for details	0.05 %	0.05 %
• Current, relative to input range, (+/-)				0.05 %	0.05 %
• Resistance, relative to input range, (+/-)	0.05 %				
• Resistance thermometer, relative to input range, (+/-)	+/- 0,5 K				
Interrupts/diagnostics/ status information					
Alarms					
• Diagnostic alarm	Yes; Parameterizable per group	Yes; Parameterizable per group	Yes; channel by channel	Yes; Parameterizable	Yes; Parameterizable
• Limit value alarm	Yes; Parameterizable	Yes; Parameterizable	Yes; Parameterizable	Yes; Parameterizable, channels 0 and 2	Yes; Parameterizable all channels (end of cycle interrupt is also supported across modules)
• Hardware interrupt	Yes; Parameterizable, channels 0 to 7	Yes; Parameterizable, channels 0 to 7	Yes; Parameterizable		Yes; Parameterizable, channels 0 to 7 (on exceeding limit value), at end of cycle
Diagnostic messages					
• Diagnostic information readable	Yes	Yes	Yes	Yes	Yes
Potential separation					
Potential separation analog inputs					
• between the channels and backplane bus	Yes	Yes	Yes	Yes	Yes
Isolation					
Isolation tested with	500 V DC	500 V DC	2500 V DC	500 V DC	500 V AC
Connection method					
required front connector	40-pin	40-pin	40-pin	40-pin	40-pin
Dimensions					
Width	40 mm	40 mm	40 mm	40 mm	40 mm
Height	125 mm	125 mm	125 mm	125 mm	125 mm
Depth	120 mm	120 mm	120 mm	117 mm	117 mm
Weights					
Weight, approx.	272 g	272 g	272 g	272 g	272 g

SIMATIC S7-300 Advanced Controllers

I/O modules

Analog modules

SM 331 analog input modules

Ordering data

SM 331 analog input modules

Including labeling strips, bus connector, measuring range modules

8 inputs, 13-bit resolution

6ES7331-1KF02-0AB0

8 inputs, resolution 9/12/14 bits

6ES7331-7KF02-0AB0

2 inputs, resolution 9/12/14 bits

6ES7331-7KB02-0AB0

8 inputs, enhanced resolution 16 bits

6ES7331-7NF00-0AB0

8 inputs, enhanced resolution 16 bits, 4-channel mode

6ES7331-7NF10-0AB0

8 inputs, resolution 14 bits, for isochronous mode

6ES7331-7HF01-0AB0

6 inputs, for thermal elements, resolution 16 bits

6ES7331-7PE10-0AB0

8 inputs, for thermal resistors

6ES7331-7PF01-0AB0

8 inputs, for thermoelements

6ES7331-7PF11-0AB0

Measuring range module for analog inputs

1 module for 2 analog inputs; 2 units (spare part)

6ES7974-0AA00-0AA0

Front connector

20-pin, with screw contacts

- 1 unit
- 100 units

6ES7392-1AJ00-0AA0
6ES7392-1AJ00-1AB0

20-pin, with spring-loaded contacts

- 1 unit
- 100 units

6ES7392-1BJ00-0AA0
6ES7392-1BJ00-1AB0

40-pin, with screw contacts

- 1 unit
- 100 units

6ES7392-1AM00-0AA0
6ES7392-1AM00-1AB0

40-pin, with spring-loaded contacts

- 1 unit
- 100 units

6ES7392-1BM01-0AA0
6ES7392-1BM01-1AB0

Front door, elevated design

e.g. for 32-channel modules; for connecting 1.3 mm²/16 AWG wires**6ES7328-0AA00-7AA0**

SIMATIC TOP connect

See page 5/248

Bus connectors

1 unit (spare part)

6ES7390-0AA00-0AA0

Shield connecting element

80 mm wide, with 2 rows for 4 shield connection clamps each

6ES7390-5AA00-0AA0

Shield connection clamps

2 units

For 2 cables with 2 mm to 6 mm diameter

6ES7390-5AB00-0AA0

For 1 cable with 3 mm to 8 mm diameter

6ES7390-5BA00-0AA0

For 1 cable with 4 mm to 13 mm diameter

6ES7390-5CA00-0AA0

Label cover

10 units (spare part), for modules with 20-pin front connector

6ES7392-2XY00-0AA0

Labeling strips

10 units (spare part), for modules with 20-pin front connector

6ES7392-2XX00-0AA0

Labeling sheets for machine labeling

for modules with 20-pin front connector, DIN A4, for printing with laser printer; 10 units

Petrol

6ES7392-2AX00-0AA0

Light beige

6ES7392-2BX00-0AA0

Yellow

6ES7392-2CX00-0AA0

Red

6ES7392-2DX00-0AA0

for modules with 40-pin front connector, DIN A4, for printing with laser printer; 10 units

Petrol

6ES7392-2AX10-0AA0

Light beige

6ES7392-2BX10-0AA0

Yellow

6ES7392-2CX10-0AA0

Red

6ES7392-2DX10-0AA0

SIMATIC Manual Collection

Electronic manuals on DVD, multilingual: LOGO!, SIMADYN, SIMATIC bus components, SIMATIC C7, SIMATIC distributed I/O, SIMATIC HMI, SIMATIC Sensors, SIMATIC NET, SIMATIC PC Based Automation, SIMATIC PCS 7, SIMATIC PG/PC, SIMATIC S7, SIMATIC Software, SIMATIC TDC

6ES7998-8XC01-8YE0

SIMATIC Manual Collection update service for 1 year

Current "Manual Collection" DVD and the three subsequent updates

6ES7998-8XC01-8YE2

Overview



- Analog outputs
- For the connection of analog actuators

Technical specifications

Article number	6ES7332-5HB01-0AB0 SIMATIC S7-300, ANALOG OUTPUT	6ES7332-5HD01-0AB0 SIMATIC S7-300, ANALOG OUTPUT	6ES7332-5HF00-0AB0 SIMATIC S7-300, ANALOG OUTPUT	6ES7332-7ND02-0AB0 SIMATIC S7, SM 332 ANALOG OUTPUT
Supply voltage				
Load voltage L+				
• Rated value (DC)	24 V	24 V	24 V	24 V
Input current				
from load voltage L+ (without load), max.	135 mA	240 mA	340 mA	290 mA
from backplane bus 5 V DC, max.	60 mA	60 mA	100 mA	120 mA
Power loss				
Power loss, typ.	3 W	3 W	6 W	3 W
Analog outputs				
Number of analog outputs	2	4	8	4; Isochronous mode
Voltage output, short-circuit protection	Yes	Yes	Yes	Yes
Voltage output, short-circuit current, max.	25 mA	25 mA	25 mA	40 mA
Current output, no-load voltage, max.	18 V	18 V	18 V	18 V
Output ranges, voltage				
• 0 to 10 V	Yes	Yes	Yes	Yes
• 1 V to 5 V	Yes	Yes	Yes	Yes
• -10 V to +10 V	Yes	Yes	Yes	Yes
Output ranges, current				
• 0 to 20 mA	Yes	Yes	Yes	Yes
• -20 mA to +20 mA	Yes	Yes	Yes	Yes
• 4 mA to 20 mA	Yes	Yes	Yes	Yes
Load impedance (in rated range of output)				
• with voltage outputs, min.	1 k Ω	1 k Ω	1 k Ω	1 k Ω
• with voltage outputs, capacitive load, max.	1 μ F	1 μ F	1 μ F	1 μ F
• with current outputs, max.	500 Ω	500 Ω	500 Ω	500 Ω
• with current outputs, inductive load, max.	10 mH	10 mH	10 mH	1 mH
Cable length				
• shielded, max.	200 m	200 m	200 m	200 m

SIMATIC S7-300 Advanced Controllers

I/O modules

Analog modules

SM 332 analog output modules

Technical specifications (continued)

Article number	6ES7332-5HB01-0AB0 SIMATIC S7-300, ANALOG OUTPUT	6ES7332-5HD01-0AB0 SIMATIC S7-300, ANALOG OUTPUT	6ES7332-5HF00-0AB0 SIMATIC S7-300, ANALOG OUTPUT	6ES7332-7ND02-0AB0 SIMATIC S7, SM 332 ANALOG OUTPUT
Analog value generation for the outputs				
Integration and conversion time/ resolution per channel				
• Resolution with overrange (bit including sign), max.	12 bit; ±10 V, ±20 mA, 4 mA to 20 mA, 1 V to 5 V; 11 bit + sign; 0 V to 10 V, 0 mA to 20 mA: 12 bit	12 bit; ±10 V, ±20 mA, 4 mA to 20 mA, 1 V to 5 V; 11 bit + sign; 0 V to 10 V, 0 mA to 20 mA: 12 bit	12 bit; ±10 V, ±20 mA, 4 mA to 20 mA, 1 V to 5 V; 11 bit + sign; 0 V to 10 V, 0 mA to 20 mA: 12 bit	16 bit
• Conversion time (per channel)	0.8 ms	0.8 ms	0.8 ms	200 µs; in isochronous mode 640 µs
Settling time				
• for resistive load	0.2 ms	0.2 ms	0.2 ms	0.2 ms
• for capacitive load	3.3 ms	3.3 ms	3.3 ms	3.3 ms
• for inductive load	0.5 ms; 0.5 ms (1 mH); 3.3 ms (10 mH)	0.5 ms; 0.5 ms (1 mH); 3.3 ms (10 mH)	0.5 ms; 0.5 ms (1 mH); 3.3 ms (10 mH)	0.5 ms
Errors/accuracies				
Operational error limit in overall temperature range				
• Voltage, relative to output range, (+/-)	0.5 %	0.5 %	0.5 %	0.12 %
• Current, relative to output range, (+/-)	0.6 %	0.6 %	0.6 %	0.18 %
Basic error limit (operational limit at 25 °C)				
• Voltage, relative to output range, (+/-)	0.4 %	0.4 %	0.4 %	0.02 %
• Current, relative to output range, (+/-)	0.5 %	0.5 %	0.5 %	0.02 %
Interrupts/diagnostics/ status information				
Substitute values connectable	Yes; Parameterizable	Yes; Parameterizable	Yes; Parameterizable	Yes; Parameterizable
Alarms				
• Diagnostic alarm	Yes; Parameterizable	Yes; Parameterizable	Yes; Parameterizable	Yes; Parameterizable
Diagnostic messages				
• Diagnostic information readable	Yes	Yes	Yes	Yes
Potential separation				
Potential separation analog outputs				
• between the channels and backplane bus	Yes	Yes	Yes	Yes
Isolation				
Isolation tested with	500 V DC	500 V DC	500 V DC	1500 V DC
Connection method				
required front connector	20-pin	20-pin	40-pin	20-pin
Dimensions				
Width	40 mm	40 mm	40 mm	40 mm
Height	125 mm	125 mm	125 mm	125 mm
Depth	117 mm	117 mm	117 mm	117 mm
Weights				
Weight, approx.	220 g	220 g	272 g	220 g

Ordering data	Article No.		Article No.
SM 332 analog output modules		Label cover	6ES7392-2XY00-0AA0
incl. labeling strips, bus connector		10 units (spare part), for modules with 20-pin front connector	
4 outputs, 11/12 bit	6ES7332-5HD01-0AB0	Labeling strips	6ES7392-2XX00-0AA0
4 outputs, 16 bit	6ES7332-7ND02-0AB0	10 units (spare part), for modules with 20-pin front connector	
2 outputs, 11/12 bit	6ES7332-5HB01-0AB0	Labeling sheets for machine labeling	
8 outputs, 11/12 bit	6ES7332-5HF00-0AB0	for modules with 20-pin front connector, DIN A4, for printing with laser printer; 10 units	
Front connector		Petrol	6ES7392-2AX00-0AA0
20-pin, with screw contacts		Light beige	6ES7392-2BX00-0AA0
• 1 unit	6ES7392-1AJ00-0AA0	Yellow	6ES7392-2CX00-0AA0
• 100 units	6ES7392-1AJ00-1AB0	Red	6ES7392-2DX00-0AA0
20-pin, with spring-loaded contacts		for modules with 40-pin front connector, DIN A4, for printing with laser printer; 10 units	
• 1 unit	6ES7392-1BJ00-0AA0	Petrol	6ES7392-2AX10-0AA0
• 100 units	6ES7392-1BJ00-1AB0	Light beige	6ES7392-2BX10-0AA0
40-pin, with screw contacts		Yellow	6ES7392-2CX10-0AA0
• 1 unit	6ES7392-1AM00-0AA0	Red	6ES7392-2DX10-0AA0
• 100 units	6ES7392-1AM00-1AB0	SIMATIC Manual Collection	6ES7998-8XC01-8YE0
40-pin, with spring-loaded contacts		Electronic manuals on DVD, multilingual: LOGO!, SIMADYN, SIMATIC bus components, SIMATIC C7, SIMATIC distributed I/O, SIMATIC HMI, SIMATIC Sensors, SIMATIC NET, SIMATIC PC Based Automation, SIMATIC PCS 7, SIMATIC PG/PC, SIMATIC S7, SIMATIC Software, SIMATIC TDC	
• 1 unit	6ES7392-1BM01-0AA0	SIMATIC Manual Collection update service for 1 year	6ES7998-8XC01-8YE2
• 100 units	6ES7392-1BM01-1AB0	Current "Manual Collection" DVD and the three subsequent updates	
Front door, elevated design	6ES7328-0AA00-7AA0		
e.g. for 32-channel modules; for connecting 1.3 mm ² /16 AWG wires			
SIMATIC TOP connect	See page 5/248		
Bus connectors			
1 unit (spare part)	6ES7390-0AA00-0AA0		
Shield connecting element	6ES7390-5AA00-0AA0		
80 mm wide, with 2 rows for 4 shield connection clamps each			
Shield connection clamps			
2 units			
For 2 cables with 2 mm to 6 mm diameter	6ES7390-5AB00-0AA0		
For 1 cable with 3 mm to 8 mm diameter	6ES7390-5BA00-0AA0		
For 1 cable with 4 mm to 13 mm diameter	6ES7390-5CA00-0AA0		

SIMATIC S7-300 Advanced Controllers

I/O modules

Analog modules

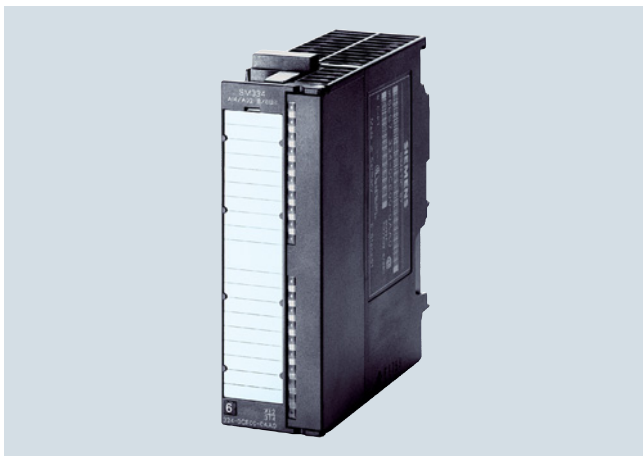
SM 334 analog input/output modules**Overview**

- Analog inputs and outputs
- For the connection of analog sensors and actuators

5

Technical specifications

Article number	6ES7334-0CE01-0AA0 SIMATIC S7, ANALOG INPUT MODULE	6ES7334-0KE00-0AB0 SIMATIC S7-300, ANALOG MODULE
Supply voltage		
Load voltage L+		
• Rated value (DC)	24 V	24 V
Input current		
from supply and load voltage L+ (without load), max.	110 mA	80 mA
from backplane bus 5 V DC, max.	55 mA	60 mA
Power loss		
Power loss, typ.	3 W	2 W
Analog inputs		
Number of analog inputs	4	4
• For voltage measurement	4	2
• For resistance measurement		4
permissible input voltage for voltage input (destruction limit), max.	20 V	20 V; continuous; 75 V for max. 1 s (mark to space ratio 1:20)
permissible input current for current input (destruction limit), max.	40 mA	
Cycle time (all channels) max.	5 ms	85 ms
Input ranges (rated values), voltages		
• 0 to +10 V	Yes	Yes
Input ranges (rated values), currents		
• 0 to 20 mA	Yes	
Input ranges (rated values), resistance thermometer		
• Pt 100		Yes; only climatic range
Input ranges (rated values), resistors		
• 0 to 10000 ohms		Yes
Analog outputs		
Number of analog outputs	2	2
Voltage output, short-circuit protection	Yes	Yes
Voltage output, short-circuit current, max.	11 mA	30 mA
Current output, no-load voltage, max.	15 V	

Technical specifications (continued)

Article number	6ES7334-0CE01-0AA0	6ES7334-0KE00-0AB0
	SIMATIC S7, ANALOG INPUT MODULE	SIMATIC S7-300, ANALOG MODULE
Output ranges, voltage		
• 0 to 10 V	Yes	Yes
Output ranges, current		
• 0 to 20 mA	Yes	
Load impedance (in rated range of output)		
• with voltage outputs, min.	5 kΩ	2.5 kΩ
• with voltage outputs, capacitive load, max.	1 μF	1 μF
• with current outputs, max.	300 Ω	
• with current outputs, inductive load, max.	1 mH	
Cable length		
• shielded, max.	200 m	100 m
Analog value generation for the inputs		
Integration and conversion time/resolution per channel		
• Resolution with overrange (bit including sign), max.	8 bit	12 bit
• Integration time (ms)		16,67 / 20 ms
Analog value generation for the outputs		
Integration and conversion time/resolution per channel		
• Resolution with overrange (bit including sign), max.	8 bit	12 bit
Settling time		
• for resistive load	0.3 ms	0.8 ms
• for capacitive load	3 ms	0.8 ms
• for inductive load	0.3 ms	
Encoder		
Connection of signal encoders		
• for current measurement as 2-wire transducer	No	
• for current measurement as 4-wire transducer	Yes	
• for resistance measurement with two-wire connection		Yes
• for resistance measurement with three-wire connection		Yes
• for resistance measurement with four-wire connection		Yes
Errors/accuracies		
Operational error limit in overall temperature range		
• Voltage, relative to input range, (+/-)	0.9 %	0.7 %; 0 to 10V
• Current, relative to input range, (+/-)	0.8 %	
• Resistance, relative to input range, (+/-)		3.5 %; 10 kOhm
• Resistance thermometer, relative to input range, (+/-)		1 %
• Voltage, relative to output range, (+/-)	0.6 %	1 %
• Current, relative to output range, (+/-)	1 %	

SIMATIC S7-300 Advanced Controllers

I/O modules

Analog modules

SM 334 analog input/output modules**Technical specifications** (continued)

Article number	6ES7334-0CE01-0AA0 SIMATIC S7, ANALOG INPUT MODULE	6ES7334-0KE00-0AB0 SIMATIC S7-300, ANALOG MODULE
Basic error limit (operational limit at 25 °C)		
• Voltage, relative to input range, (+/-)	0.7 %	0.5 %; 0 to 10V
• Current, relative to input range, (+/-)	0.6 %	
• Resistance, relative to input range, (+/-)		2.8 %; 10 kOhm
• Resistance thermometer, relative to input range, (+/-)		0.8 %
• Voltage, relative to output range, (+/-)	0.5 %	0.85 %
• Current, relative to output range, (+/-)	0.5 %	
Interrupts/diagnostics/ status information		
Alarms	No	No
Diagnostic functions	No	No
Potential separation		
Potential separation analog inputs		
• between the channels and backplane bus	No	Yes
Potential separation analog outputs		
• between the channels and backplane bus	No	Yes
Isolation		
Isolation tested with	500 V DC	500 V DC
Connection method		
required front connector	20-pin	20-pin
Dimensions		
Width	40 mm	40 mm
Height	125 mm	125 mm
Depth	117 mm	117 mm
Weights		
Weight, approx.	285 g	200 g

Ordering data	Article No.		Article No.
SM 334 analog input/output modules		Label cover	6ES7392-2XY00-0AA0
incl. Labeling strips, bus connector		10 units (spare part), for modules with 20-pin front connector	
4 inputs, 2 outputs	6ES7334-0CE01-0AA0	Labeling strips	6ES7392-2XX00-0AA0
4 inputs, 2 outputs, resistance measurement, Pt 100	6ES7334-0KE00-0AB0	10 units (spare part), for modules with 20-pin front connector	
Front connector		Labeling sheets for machine labeling	
20-pin, with screw contacts		for modules with 20-pin front connector, DIN A4, for printing with laser printer; 10 units	
• 1 unit	6ES7392-1AJ00-0AA0	Petrol	6ES7392-2AX00-0AA0
• 100 units	6ES7392-1AJ00-1AB0	Light beige	6ES7392-2BX00-0AA0
20-pin, with spring-loaded terminals		Yellow	6ES7392-2CX00-0AA0
• 1 unit	6ES7392-1BJ00-0AA0	Red	6ES7392-2DX00-0AA0
• 100 units	6ES7392-1BJ00-1AB0	SIMATIC Manual Collection	6ES7998-8XC01-8YE0
Front door, elevated design	6ES7328-0AA00-7AA0	Electronic manuals on DVD, multilingual: LOGO!, SIMADYN, SIMATIC bus components, SIMATIC C7, SIMATIC distributed I/O, SIMATIC HMI, SIMATIC Sensors, SIMATIC NET, SIMATIC PC Based Automation, SIMATIC PCS 7, SIMATIC PG/PC, SIMATIC S7, SIMATIC Software, SIMATIC TDC	
e.g. for 32-channel modules; for connecting 1.3 mm ² /16 AWG wires		SIMATIC Manual Collection update service for 1 year	6ES7998-8XC01-8YE2
SIMATIC TOP connect	See page 5/248	Current "Manual Collection" DVD and the three subsequent updates	
Bus connectors	6ES7390-0AA00-0AA0		
1 unit (spare part)			
Shield connecting element	6ES7390-5AA00-0AA0		
80 mm wide, with 2 rows for 4 shield connection clamps each			
Shield connection clamps			
2 units			
For 2 cables with 2 mm to 6 mm diameter	6ES7390-5AB00-0AA0		
For 1 cable with 3 mm to 8 mm diameter	6ES7390-5BA00-0AA0		
For 1 cable with 4 mm to 13 mm diameter	6ES7390-5CA00-0AA0		

SIMATIC S7-300 Advanced Controllers

I/O modules

SIPLUS S7-300 analog modules

SIPLUS S7-300 SM 331**Overview**

- Analog inputs
- For connecting voltage sensors and current sensors, thermocouples, resistors and resistance thermometers

Note:

SIPLUS extreme products are based on SIMATIC standard products. The contents listed here were taken from the respective standard products. SIPLUS extreme specific information was added.

Technical specifications

Article number	6AG1331-1KF02-7AB0	6AG1331-7KB02-2AB0	6AG1331-7KF02-2AB0
Based on	6ES7331-1KF02-0AB0 SIPLUS SM331 8AI	6ES7331-7KB02-0AB0 SIPLUS SM331 2AE	6ES7331-7KF02-0AB0 SIPLUS SM331 8AI
Ambient conditions			
Ambient temperature during operation			
• min.	-25 °C	-25 °C; = Tmin	-25 °C; = Tmin
• max.	70 °C; = Tmax; 60 °C @ UL/cUL, ATEX and FM use	70 °C; = Tmax; 60 °C @ UL/cUL, ATEX and FM use	70 °C; = Tmax; for use on railway vehicles according to EN50155, the rated temperature range -25 ... +55 °C (T1) or 60 °C @ UL/ULhaz/ATEX/FM use applies
Ambient temperature during storage/transportation			
• min.		-40 °C	-40 °C
• max.		70 °C	70 °C
Extended ambient conditions			
• relative to ambient temperature-atmospheric pressure-installation altitude	Tmin ... Tmax at 1080 hPa ... 795 hPa (-1000 m ... +2000 m) // Tmin ... (Tmax - 10K) at 795 hPa ... 658 hPa (+2000 m ... +3500 m) // Tmin ... (Tmax - 20K) at 658 hPa ... 540 hPa (+3500 m ... +5000 m)	Tmin ... Tmax at 1080 hPa ... 795 hPa (-1000 m ... +2000 m) // Tmin ... (Tmax - 10K) at 795 hPa ... 658 hPa (+2000 m ... +3500 m) // Tmin ... (Tmax - 20K) at 658 hPa ... 540 hPa (+3500 m ... +5000 m)	
Relative humidity			
- With condensation, tested in accordance with IEC 60068-2-38, max.	100 %; RH incl. condensation/frost (no commissioning under condensation conditions)	100 %; RH incl. condensation/frost (no commissioning under condensation conditions)	100 %; RH incl. condensation/frost (no commissioning under condensation conditions)
Resistance			
- against biologically active substances / conformity with EN 60721-3-3	Yes; Class 3B2 mold, fungus and dry rot spores (with the exception of fauna). The supplied connector covers must remain on the unused interfaces during operation!	Yes; Class 3B2 mold, fungus and dry rot spores (with the exception of fauna). The supplied connector covers must remain on the unused interfaces during operation!	Yes; Class 3B2 mold, fungus and dry rot spores (with the exception of fauna). The supplied connector covers must remain on the unused interfaces during operation!
- against chemically active substances / conformity with EN 60721-3-3	Yes; Class 3C4 (RH < 75%) incl. salt spray according to EN 60068-2-52 (degree of severity 3). The supplied connector covers must remain on the unused interfaces during operation!	Yes; Class 3C4 (RH < 75%) incl. salt spray according to EN 60068-2-52 (degree of severity 3). The supplied connector covers must remain on the unused interfaces during operation!	Yes; Class 3C4 (RH < 75%) incl. salt spray according to EN 60068-2-52 (degree of severity 3). The supplied connector covers must remain on the unused interfaces during operation!
- against mechanically active substances / conformity with EN 60721-3-3	Yes; Class 3S4 incl. sand, dust. The supplied connector covers must remain on the unused interfaces during operation!	Yes; Class 3S4 incl. sand, dust. The supplied connector covers must remain on the unused interfaces during operation!	Yes; Class 3S4 incl. sand, dust. The supplied connector covers must remain on the unused interfaces during operation!

Technical specifications (continued)

Article number	6AG1331-7NF00-2AB0	6AG1331-7NF10-2AB0	6AG1331-7PF01-4AB0	6AG1331-7PF11-4AB0
Based on	6ES7331-7NF00-0AB0 SIPLUS S7-300 SM331 8AI - 40pol	6ES7331-7NF10-0AB0 SIPLUS SM331 8AI - 40pol	6ES7331-7PF01-0AB0 SIPLUS SM331 8AI	6ES7331-7PF11-0AB0 SIPLUS S7-300 SM331 8AI 40pol
Ambient conditions				
Ambient temperature during operation				
• min.	-25 °C; = Tmin	-25 °C; = Tmin	0 °C; = Tmin	0 °C; = Tmin
• max.	70 °C; = Tmax; for use on railway vehicles according to EN 50155, the rated temperature range -25 ... +55 °C (T1) or 60 °C @ UL/UL hazardous use applies	60 °C; = Tmax	60 °C; = Tmax	60 °C; = Tmax
Ambient temperature during storage/transportation				
• min.	-40 °C	-40 °C	-40 °C	-40 °C
• max.	70 °C	70 °C	70 °C	70 °C
Extended ambient conditions				
• relative to ambient temperature-atmospheric pressure-installation altitude		Tmin ... Tmax at 1080 hPa ... 795 hPa (-1000 m ... +2000 m) // Tmin ... (Tmax - 10K) at 795 hPa ... 658 hPa (+2000 m ... +3500 m) // Tmin ... (Tmax - 20K) at 658 hPa ... 540 hPa (+3500 m ... +5000 m)	Tmin ... Tmax at 1080 hPa ... 795 hPa (-1000 m ... +2000 m) // Tmin ... (Tmax - 10K) at 795 hPa ... 658 hPa (+2000 m ... +3500 m) // Tmin ... (Tmax - 20K) at 658 hPa ... 540 hPa (+3500 m ... +5000 m)	Tmin ... Tmax at 1080 hPa ... 795 hPa (-1000 m ... +2000 m) // Tmin ... (Tmax - 10K) at 795 hPa ... 658 hPa (+2000 m ... +3500 m) // Tmin ... (Tmax - 20K) at 658 hPa ... 540 hPa (+3500 m ... +5000 m)
Relative humidity				
- With condensation, tested in accordance with IEC 60068-2-38, max.	100 %; RH incl. condensation/frost (no commissioning under condensation conditions)	100 %; RH incl. condensation/frost (no commissioning under condensation conditions)	100 %; RH incl. condensation/frost (no commissioning under condensation conditions)	100 %; RH incl. condensation/frost (no commissioning under condensation conditions)
Resistance				
- against biologically active substances / conformity with EN 60721-3-3	Yes; Class 3B2 mold, fungus and dry rot spores (with the exception of fauna). The supplied connector covers must remain on the unused interfaces during operation!	Yes; Class 3B2 mold, fungus and dry rot spores (with the exception of fauna). The supplied connector covers must remain on the unused interfaces during operation!	Yes; Class 3B2 mold, fungus and dry rot spores (with the exception of fauna). The supplied connector covers must remain on the unused interfaces during operation!	Yes; Class 3B2 mold, fungus and dry rot spores (with the exception of fauna). The supplied connector covers must remain on the unused interfaces during operation!
- against chemically active substances / conformity with EN 60721-3-3	Yes; Class 3C4 (RH < 75%) incl. salt spray according to EN 60068-2-52 (degree of severity 3). The supplied connector covers must remain on the unused interfaces during operation!	Yes; Class 3C4 (RH < 75%) incl. salt spray according to EN 60068-2-52 (degree of severity 3). The supplied connector covers must remain on the unused interfaces during operation!	Yes; Class 3C4 (RH < 75%) incl. salt spray according to EN 60068-2-52 (degree of severity 3). The supplied connector covers must remain on the unused interfaces during operation!	Yes; Class 3C4 (RH < 75%) incl. salt spray according to EN 60068-2-52 (degree of severity 3). The supplied connector covers must remain on the unused interfaces during operation!
- against mechanically active substances / conformity with EN 60721-3-3	Yes; Class 3S4 incl. sand, dust. The supplied connector covers must remain on the unused interfaces during operation!	Yes; Class 3S4 incl. sand, dust. The supplied connector covers must remain on the unused interfaces during operation!	Yes; Class 3S4 incl. sand, dust. The supplied connector covers must remain on the unused interfaces during operation!	Yes; Class 3S4 incl. sand, dust. The supplied connector covers must remain on the unused interfaces during operation!

SIMATIC S7-300 Advanced Controllers

I/O modules

SIPLUS S7-300 analog modules

SIPLUS S7-300 SM 331**Ordering data****Article No.****SIPLUS S7-300 SM 331
analog input modules***For industrial applications with
extended ambient conditions*Extended temperature range
and exposure to media

8 inputs, 13-bit resolution

6AG1331-1KF02-7AB0

2 inputs, 9/12/14-bit resolution

6AG1331-7KB02-2AB0

8 inputs, 9/12/14-bit resolution

6AG1331-7KF02-2AB0

8 inputs, enhanced 16-bit resolution

6AG1331-7NF00-2AB08 inputs, enhanced 16-bit
resolution, 4-channel mode**6AG1331-7NF10-2AB0**Exposure to media

8 inputs, for thermal resistors

6AG1331-7PF01-4AB0

8 inputs, for thermocouples

6AG1331-7PF11-4AB0*For rolling stock railway
applications*Conforms to EN 50155

8 inputs, 9/12/14-bit resolution

6AG1331-7KF02-2AB0

8 inputs, enhanced 16-bit resolution

6AG1331-7NF00-2AB0**Article No.****Accessories***Mandatory***Front connector**

20-pin, with spring-loaded contacts

- 1 unit
- 100 units

6ES7392-1BJ00-0AA0
6ES7392-1BJ00-1AB0

40-pin, with spring-loaded contacts

- 1 unit
- 100 units

6ES7392-1BM01-0AA0
6ES7392-1BM01-1AB0*Consumables***Front door, elevated design**E.g. for 32-channel modules;
for connecting 1.3 mm²/16 AWG
conductors; circuit diagram and
nameplates in petrol**6ES7328-0AA00-7AA0****Bus connectors**

1 unit (spare part)

6ES7390-0AA00-0AA0**Labeling strips**

10 units; spare part

For modules with
20-pin front connector**6ES7392-2XX00-0AA0**For modules with
40-pin front connector**6ES7392-2XX10-0AA0****Label cover**

10 units; spare part

For modules with
20-pin front connector**6ES7392-2XY00-0AA0**For modules with
40-pin front connector**6ES7392-2XY10-0AA0***Documentation***SIMATIC Manual Collection**Electronic manuals on DVD,
multi-language:
LOGO!, SIMADYN, SIMATIC bus
components, SIMATIC C7,
SIMATIC distributed I/O,
SIMATIC HMI, SIMATIC Sensors,
SIMATIC NET, SIMATIC PC Based
Automation, SIMATIC PCS 7,
SIMATIC PG/PC, SIMATIC S7,
SIMATIC Software, SIMATIC TDC**6ES7998-8XC01-8YE0****SIMATIC Manual Collection
update service for 1 year**Current "Manual Collection" DVD
and the three subsequent updates**6ES7998-8XC01-8YE2**

Overview

- Analog outputs
- For connection of analog actuators

Note:

SIPLUS extreme products are based on SIMATIC standard products. The contents listed here were taken from the respective standard products. SIPLUS extreme specific information was added.

Technical specifications

Article number	6AG1332-5HD01-7AB0	6AG1332-7ND02-4AB0	6AG1332-5HB01-2AB0	6AG1332-5HF00-2AB0
Based on	6ES7332-5HD01-0AB0 SIPLUS S7-300 SM332 4AA U/I	6ES7332-7ND02-0AB0 SIPLUS S7-300 SM332 4AA	6ES7332-5HB01-0AB0 SIPLUS S7-300 SM332 2AO	6ES7332-5HF00-0AB0 SIPLUS S7-300 SM 332 8AO - 40pol
Ambient conditions				
Ambient temperature during operation				
• min.	-25 °C; = Tmin	0 °C; = Tmin	-25 °C; = Tmin	-25 °C
• max.	70 °C; = Tmax; 60 °C @ UL/cUL, ATEX and FM use	60 °C; = Tmax	70 °C; = Tmax; for use on railway vehicles according to EN50155, the rated temperature range -25 ... +55 °C (T1) or 60 °C @ UL/ULhaz/ATEX/FM use applies	70 °C; = Tmax; 60 °C @ UL/cUL, ATEX and FM use
Ambient temperature during storage/transportation				
• min.	-40 °C	-40 °C	-40 °C	-40 °C
• max.	70 °C	70 °C	70 °C	70 °C
Extended ambient conditions				
• relative to ambient temperature-atmospheric pressure-installation altitude	Tmin ... Tmax at 1080 hPa ... 795 hPa (-1000 m ... +2000 m) // Tmin ... (Tmax - 10K) at 795 hPa ... 658 hPa (+2000 m ... +3500 m) // Tmin ... (Tmax - 20K) at 658 hPa ... 540 hPa (+3500 m ... +5000 m)	Tmin ... Tmax at 1080 hPa ... 795 hPa (-1000 m ... +2000 m) // Tmin ... (Tmax - 10K) at 795 hPa ... 658 hPa (+2000 m ... +3500 m) // Tmin ... (Tmax - 20K) at 658 hPa ... 540 hPa (+3500 m ... +5000 m)	Tmin ... Tmax at 1080 hPa ... 795 hPa (-1000 m ... +2000 m) // Tmin ... (Tmax - 10K) at 795 hPa ... 658 hPa (+2000 m ... +3500 m) // Tmin ... (Tmax - 20K) at 658 hPa ... 540 hPa (+3500 m ... +5000 m)	Tmin ... Tmax at 1080 hPa ... 795 hPa (-1000 m ... +2000 m) // Tmin ... (Tmax - 10K) at 795 hPa ... 658 hPa (+2000 m ... +3500 m) // Tmin ... (Tmax - 20K) at 658 hPa ... 540 hPa (+3500 m ... +5000 m)
Relative humidity				
- With condensation, tested in accordance with IEC 60068-2-38, max.	100 %; RH incl. condensation/frost (no commissioning under condensation conditions)	100 %; RH incl. condensation/frost (no commissioning under condensation conditions)	100 %; RH incl. condensation/frost (no commissioning under condensation conditions)	100 %; RH incl. condensation/frost (no commissioning under condensation conditions)

SIMATIC S7-300 Advanced Controllers

I/O modules

SIPLUS S7-300 analog modules

SIPLUS S7-300 SM 332

Technical specifications (continued)

Article number	6AG1332-5HD01-7AB0	6AG1332-7ND02-4AB0	6AG1332-5HB01-2AB0	6AG1332-5HF00-2AB0
Based on	6ES7332-5HD01-0AB0 SIPLUS S7-300 SM332 4AA U/I	6ES7332-7ND02-0AB0 SIPLUS S7-300 SM332 4AA	6ES7332-5HB01-0AB0 SIPLUS S7-300 SM332 2AO	6ES7332-5HF00-0AB0 SIPLUS S7-300 SM 332 8AO - 40pol
Resistance				
- against biologically active substances / conformity with EN 60721-3-3	Yes; Class 3B2 mold, fungus and dry rot spores (with the exception of fauna). The supplied connector covers must remain on the unused interfaces during operation!	Yes; Class 3B2 mold, fungus and dry rot spores (with the exception of fauna). The supplied connector covers must remain on the unused interfaces during operation!	Yes; Class 3B2 mold, fungus and dry rot spores (with the exception of fauna). The supplied connector covers must remain on the unused interfaces during operation!	Yes; Class 3B2 mold, fungus and dry rot spores (with the exception of fauna). The supplied connector covers must remain on the unused interfaces during operation!
- against chemically active substances / conformity with EN 60721-3-3	Yes; Class 3C4 (RH < 75%) incl. salt spray according to EN 60068-2-52 (degree of severity 3). The supplied connector covers must remain on the unused interfaces during operation!	Yes; Class 3C4 (RH < 75%) incl. salt spray according to EN 60068-2-52 (degree of severity 3). The supplied connector covers must remain on the unused interfaces during operation!	Yes; Class 3C4 (RH < 75%) incl. salt spray according to EN 60068-2-52 (degree of severity 3). The supplied connector covers must remain on the unused interfaces during operation!	Yes; Class 3C4 (RH < 75%) incl. salt spray according to EN 60068-2-52 (degree of severity 3). The supplied connector covers must remain on the unused interfaces during operation!
- against mechanically active substances / conformity with EN 60721-3-3	Yes; Class 3S4 incl. sand, dust. The supplied connector covers must remain on the unused interfaces during operation!	Yes; Class 3S4 incl. sand, dust. The supplied connector covers must remain on the unused interfaces during operation!	Yes; Class 3S4 incl. sand, dust. The supplied connector covers must remain on the unused interfaces during operation!	Yes; Class 3S4 incl. sand, dust. The supplied connector covers must remain on the unused interfaces during operation!

5

Ordering data

SIPLUS S7-300 SM 332 analog output modules

For industrial applications with extended ambient conditions

Extended temperature range and exposure to media

2 outputs, 11/12-bit

6AG1332-5HB01-2AB0

4 outputs, 11/12-bit

6AG1332-5HD01-7AB0

8 outputs, 11/12-bit

6AG1332-5HF00-2AB0

Exposure to media

4 outputs, 16-bit; only medial exposure

6AG1332-7ND02-4AB0

For rolling stock railway applications

Conforms to EN 50155

2 outputs, 11/12-bit

6AG1332-5HB01-2AB0

Accessories

Mandatory

Front connector

20-pin, with spring-loaded contacts

- 1 unit
- 100 units

6ES7392-1BJ00-0AA0
6ES7392-1BJ00-1AB0

40-pin, with spring-loaded contacts

- 1 unit
- 100 units

6ES7392-1BM01-0AA0
6ES7392-1BM01-1AB0

Article No.

Consumables

Front door, elevated design

E.g. for 32-channel modules; for connecting 1.3 mm²/16 AWG conductors; circuit diagram and nameplates in petrol

6ES7328-0AA00-7AA0

Bus connectors

1 unit (spare part)

6ES7390-0AA00-0AA0

Labeling strips

10 units; spare part

For modules with 20-pin front connector

6ES7392-2XX00-0AA0

For modules with 40-pin front connector

6ES7392-2XX10-0AA0

Label cover

10 units; spare part

For modules with 20-pin front connector

6ES7392-2XY00-0AA0

For modules with 40-pin front connector

6ES7392-2XY10-0AA0

Documentation

SIMATIC Manual Collection

Electronic manuals on DVD, multi-language: LOGO!, SIMADYN, SIMATIC bus components, SIMATIC C7, SIMATIC distributed I/O, SIMATIC HMI, SIMATIC Sensors, SIMATIC NET, SIMATIC PC Based Automation, SIMATIC PCS 7, SIMATIC PG/PC, SIMATIC S7, SIMATIC Software, SIMATIC TDC

6ES7998-8XC01-8YE0

Overview

- Analog inputs and outputs
- For connection of analog sensors and actuators

Note:

SIPLUS extreme products are based on SIMATIC standard products. The contents listed here were taken from the respective standard products. SIPLUS extreme specific information was added.

Technical specifications

Article number	6AG1334-0KE00-7AB0
Based on	6ES7334-0KE00-0AB0 SIPLUS S7-300 SM334 4AE 2AA
Ambient conditions	
Ambient temperature during operation	
• min.	-25 °C; = Tmin
• max.	70 °C; = Tmax; 60 °C @ UL/cUL, ATEX and FM use
Ambient temperature during storage/transportation	
• min.	-40 °C
• max.	70 °C
Extended ambient conditions	
Relative humidity	
- With condensation, tested in accordance with IEC 60068-2-38, max.	100 %; RH incl. condensation/frost (no commissioning under condensation conditions)
Resistance	
- against biologically active substances / conformity with EN 60721-3-3	Yes; Class 3B2 mold, fungus and dry rot spores (with the exception of fauna). The supplied connector covers must remain on the unused interfaces during operation!
- against chemically active substances / conformity with EN 60721-3-3	Yes; Class 3C4 (RH < 75%) incl. salt spray according to EN 60068-2-52 (degree of severity 3). The supplied connector covers must remain on the unused interfaces during operation!
- against mechanically active substances / conformity with EN 60721-3-3	Yes; Class 3S4 incl. sand, dust. The supplied connector covers must remain on the unused interfaces during operation!

SIMATIC S7-300 Advanced Controllers

I/O modules

SIPLUS S7-300 analog modules

SIPLUS S7-300 SM 334**Ordering data****Article No.****SIPLUS S7-300 SM 334
analog input/output modules***For industrial applications with
extended ambient conditions*Extended temperature range
and exposure to media4 inputs, 2 outputs;
resistance measurement, Pt 100**6AG1334-0KE00-7AB0****Accessories***Mandatory***Front connector**

20-pin, with spring-loaded contacts

- 1 unit
- 100 units

6ES7392-1BJ00-0AA0**6ES7392-1BJ00-1AB0**

40-pin, with spring-loaded contacts

- 1 unit
- 100 units

6ES7392-1BM01-0AA0**6ES7392-1BM01-1AB0***Consumables***Front door, elevated design**E.g. for 32-channel modules;
for connecting 1.3 mm²/16 AWG
conductors; circuit diagram and
nameplates in petrol**6ES7328-0AA00-7AA0****Article No.****Bus connectors**

1 unit (spare part)

6ES7390-0AA00-0AA0**Labeling strips**

10 units; spare part

For modules with
20-pin front connector**6ES7392-2XX00-0AA0**For modules with
40-pin front connector**6ES7392-2XX10-0AA0****Label cover**

10 units; spare part

For modules with
20-pin front connector**6ES7392-2XY00-0AA0**For modules with
40-pin front connector**6ES7392-2XY10-0AA0***Documentation***SIMATIC Manual Collection**Electronic manuals on DVD,
multi-language:
LOGO!, SIMADYN, SIMATIC bus
components, SIMATIC C7,
SIMATIC distributed I/O,
SIMATIC HMI, SIMATIC Sensors,
SIMATIC NET, SIMATIC PC Based
Automation, SIMATIC PCS 7,
SIMATIC PG/PC, SIMATIC S7,
SIMATIC Software, SIMATIC TDC**6ES7998-8XC01-8YE0****SIMATIC Manual Collection
update service for 1 year**Current "Manual Collection" DVD
and the three subsequent updates**6ES7998-8XC01-8YE2**

Overview



- Digital inputs for the fail-safe SIMATIC S7 systems
- For connecting:
 - Switches and 2-wire proximity switches
 - Sensors according to NAMUR and mechanical contacts, also for signals from hazardous areas
- With integral safety functions for fail-safe operation
- Can be used in fail-safe operation
 - Centrally: with S7-31xF-2 DP
 - Distributed in ET 200M: with SIMATIC IM 151-7 F-CPU, S7-31xF-2 DP, S7-416F-2 and S7-400F/FH
- In standard operation can be used in the same way as S7-300 modules

Technical specifications

Article number	6ES7326-1RF01-0AB0	6ES7326-1BK02-0AB0
	SM326, 8DE, DC24V, FAIL-SAFE	SM326, F-DI 24 X DC24V, FAIL-SAFE
General information		
Product type designation	F-DI 8x24VDC Namur	
Supply voltage		
Rated value (DC)	24 V	
Input current		
from load voltage L+ (without load), max.	160 mA	450 mA
from backplane bus 5 V DC, max.	90 mA	100 mA
Encoder supply		
Number of outputs	8	4; Isolated
Type of output voltage	8.2 V DC	
Output current		
• Rated value	400 mA	
Power loss		
Power loss, typ.	4.5 W	10 W
Digital inputs		
Number of digital inputs	8	24
Number of simultaneously controllable inputs		
all mounting positions		
- up to 40 °C, max.	8	24
- up to 60 °C, max.	8	24; (at 24 V) or 18 (at 28.8 V)
Input voltage		
• Type of input voltage	DC	
• Rated value (DC)	24 V	
• for signal "0"	-30 to +5V	
• for signal "1"	+11 to +30V	
Input current		
• for signal "0", max. (permissible quiescent current)	0.35 to 1.2 mA	2 mA
• for signal "1", typ.	2.1 to 7 mA	10 mA
Input delay (for rated value of input voltage)		
for standard inputs		
- at "0" to "1", max.	3.4 ms	
- at "1" to "0", max.	3.4 ms	
for NAMUR inputs		
- at "0" to "1", max.	1.2 to 3 ms	
- at "1" to "0", max.	1.2 to 3 ms	

SIMATIC S7-300 Advanced Controllers

I/O modules

F digital/analog modules

SM 326 F digital input modules - Safety Integrated

Technical specifications (continued)

Article number	6ES7326-1RF01-0AB0 SM326, 8DE, DC24V, FAIL-SAFE	6ES7326-1BK02-0AB0 SM326, F-DI 24 X DC24V, FAIL-SAFE
Cable length		
• shielded, max.	200 m	200 m
• unshielded, max.	100 m	100 m
Encoder		
Connectable encoders		
• 2-wire sensor		Yes; if short-circuit test is deactivated
- permissible quiescent current (2-wire sensor), max.		2 mA
Interrupts/diagnostics/status information		
Alarms		
• Diagnostic alarm	Yes; Parameterizable	Yes
Diagnostic messages		
• Diagnostic information readable		Yes
Ex(i) characteristics		
Module for Ex(i) protection	Yes	
Maximum values of input circuits (per channel)		
• Co (permissible external capacity), max.	3 µF	
• Io (short-circuit current), max.	13.9 mA	
• Lo (permissible external inductivity), max.	80 mH	
• Po (power of load), max.	33.1 mW	
• Uo (output no-load voltage), max.	10 V	
• Um (fault voltage), max.	60 V DC/30 V AC	
• Ta (permissible ambient temperature), max.	60 °C	60 °C
Potential separation		
Potential separation digital inputs		
• between the channels	Yes	Yes
• between the channels, in groups of		12
• between the channels and backplane bus	Yes	Yes
• between the channels and the power supply of the electronics	Yes	
Isolation		
Isolation tested with		500 V DC/350 V AC
Highest safety class achievable in safety mode		
• acc. to DIN VDE 0801		AK 6
• acc. to EN 954	Cat. 4	Cat. 4
• SIL acc. to IEC 61508	SIL 2 (single-channel), SIL 3 (two-channel)	SIL 3
Use in hazardous areas		
• Test number KEMA	99 ATEX 2671 X	
Connection method		
required front connector	1x 40-pin	40-pin
Dimensions		
Width	80 mm	80 mm
Height	125 mm	125 mm
Depth	120 mm	120 mm
Weights		
Weight, approx.	482 g	442 g

Ordering data	Article No.	Ordering data	Article No.
SM 326 F digital input module		Active bus module	6ES7195-7HC00-0XA0
24 inputs, 24 V DC	6ES7326-1BK02-0AB0	BM 1 x 80 for 1 module with 80 mm width	
8 inputs, 24 V DC, NAMUR	6ES7326-1RF01-0AB0	SITOP power supply module	6ES7307-1EA01-0AA0
S7 Distributed Safety V5.4 programming tool		for ET 200M; 120/230 V AC, 24 V DC, 5 A; Type PS 307-1E	
Task: Configuration software for configuring fail-safe user programs for SIMATIC S7-300F, S7-400F, WinAC RTX F, ET 200S, ET 200M, ET 200iSP, ET 200pro, ET 200eco		Front connectors	
Requirement: STEP 7 V5.3 SP3 and higher		40-pin, with screw contacts	
Floating license	6ES7833-1FC02-0YA5	• 1 unit	6ES7392-1AM00-0AA0
Floating license for 1 user, license key download without software or documentation ¹⁾ ; email address required for delivery	6ES7833-1FC02-0YH5	• 100 units	6ES7392-1AM00-1AB0
S7 Distributed Safety upgrade		40-pin, with spring-loaded contacts	
From V5.x to V5.4; floating license for 1 user	6ES7833-1FC02-0YE5	• 1 unit	6ES7392-1BM01-0AA0
STEP 7 Safety Advanced V14 SP1		• 100 units	6ES7392-1BM01-1AB0
Task: Engineering tool for configuring and programming fail-safe user programs for SIMATIC S7-1200 FC, S7-1500F, S7-1500F Software Controller, S7-300F, S7-400F, WinAC RTX F, ET 200SP F Controller and the fail-safe ET 200SP, ET 200S, ET 200M, ET 200iSP, ET 200pro and ET 200eco I/O		Front door, higher version, for F-modules	6ES7328-7AA10-0AA0
Requirement: STEP 7 Professional V14 SP1		For F-modules; for connecting 1.3 mm ² /16 AWG wires; wiring diagram and labels in yellow	
Floating license for 1 user, software and documentation on DVD; license key on USB flash drive	6ES7833-1FA14-0YA5	Labeling strips	6ES7392-2XX20-0AA0
Floating license for 1 user, software, documentation and license key for download ¹⁾ ; email address required for delivery	6ES7833-1FA14-0YH5	For F-modules (spare part); 10 units	
DIN rail for active bus modules		Label cover	6ES7392-2XY20-0AA0
for max. 5 active bus modules for hot swapping function		For F-modules (spare part); 10 units	
• 483 mm (19") long	6ES7195-1GA00-0XA0	LK 393 cable guide	6ES7393-4AA10-0AA0
• 530 mm long	6ES7195-1GF30-0XA0	For F-modules; L+ and M connections; 5 units	
• 620 mm long	6ES7195-1GG30-0XA0	SIMATIC Manual Collection	6ES7998-8XC01-8YE0
• 2000 mm long	6ES7195-1GC00-0XA0	Electronic manuals on DVD, multilingual: LOGO!, SIMADYN, SIMATIC bus components, SIMATIC C7, SIMATIC distributed I/O, SIMATIC HMI, SIMATIC Sensors, SIMATIC NET, SIMATIC PC Based Automation, SIMATIC PCS 7, SIMATIC PG/PC, SIMATIC S7, SIMATIC Software, SIMATIC TDC	
		SIMATIC Manual Collection update service for 1 year	6ES7998-8XC01-8YE2
		Current "Manual Collection" DVD and the three subsequent updates	

¹⁾ For up-to-date information and download availability, see:
<http://www.siemens.com/tia-online-software-delivery>

SIMATIC S7-300 Advanced Controllers

I/O modules

F digital/analog modules

SM 326 F digital output modules - Safety Integrated

Overview



- Digital outputs for the fail-safe SIMATIC S7 systems
- Two versions (1 x current sourcing, 1 x current sinking)
- For connecting solenoid valves, DC contactors and indicator lights
- With integral safety functions for fail-safe operation
- Can be used in fail-safe operation
 - Centrally: with S7-31xF DP, S7-31xF PN/DP
 - Distributed in ET 200M: with SIMATIC IM 151-7 F-CPU, S7-31xF-2 DP, S7-41xF-2 and S7-400F/FH

Technical specifications

Article number	6ES7326-2BF10-0AB0 SM326, F-DO10XDC24V/2A PP, FAIL-SAFE	6ES7326-2BF41-0AB0 SM 326, F-DO 8 X DC 24V/2A PM
Supply voltage		
Rated value (DC)	24 V; 1L+	24 V; 1L+
Load voltage L+		
• Rated value (DC)	24 V; 2L+, 3L+	24 V; 2L+, 3L+
Input current		
from supply voltage 1L+, max.	100 mA	75 mA
from load voltage 2L+ (without load), max.	100 mA	100 mA
from load voltage 3L+ (without load), max.	100 mA	100 mA
from backplane bus 5 V DC, max.	100 mA	100 mA
Power loss		
Power loss, typ.	6 W	12 W
Digital outputs		
Number of digital outputs	10	8
Short-circuit protection	Yes	Yes
Limitation of inductive shutdown voltage to		L+ (-33 V)
Switching capacity of the outputs		
• on lamp load, max.	5 W	5 W
Output voltage		
• for signal *1* without series diode, min.		L+ (-1.0 V)
Output current		
• for signal *1* rated value	2 A	2 A
• for signal *1* permissible range for 0 to 40 °C, min.	7 mA	7 mA
• for signal *1* permissible range for 0 to 40 °C, max.	2.4 A	2 A; 2 A for horizontal installation, 1 A for vertical installation
• for signal *1* permissible range for 40 to 60 °C, min.	7 mA	7 mA
• for signal *1* permissible range for 40 to 60 °C, max.	2.4 A	1 A; for horizontal installation
• for signal *0* residual current, max.	0.5 mA	0.5 mA
Switching frequency		
• with resistive load, max.	25 Hz	30 Hz
• with inductive load, max.	25 Hz	2 Hz
• on lamp load, max.	10 Hz	10 Hz

Technical specifications (continued)

Article number	6ES7326-2BF10-0AB0	6ES7326-2BF41-0AB0
	SM326, F-DO10XDC24V/2A PP, FAIL-SAFE	SM 326, F-DO 8 X DC 24V/2A PM
Total current of the outputs (per group)		
horizontal installation		
- up to 40 °C, max.	10 A	7.5 A
- up to 60 °C, max.	6 A	5 A
vertical installation		
- up to 40 °C, max.	5 A	5 A
Cable length		
• shielded, max.	1 000 m	200 m; 200 m for SIL3, AK 6, Cat 4
• unshielded, max.	600 m	200 m
Interrupts/diagnostics/status information		
Alarms		
• Diagnostic alarm	Yes	Yes; Parameterizable
Diagnostic messages		
• Diagnostic information readable	Yes	Yes
Potential separation		
Potential separation digital outputs		
• between the channels	Yes	Yes
• between the channels, in groups of	5	4
• between the channels and backplane bus	Yes	Yes
• between the channels and the power supply of the electronics	Yes	Yes
Isolation		
Isolation tested with	370V for 1 min	500 V DC/350 V AC
Highest safety class achievable in safety mode		
• acc. to DIN VDE 0801	AK 5 and 6	
• acc. to EN 954	Cat. 4	Cat. 4
• SIL acc. to IEC 61508	SIL 3	SIL 3
Connection method		
required front connector	40-pin	40-pin
Dimensions		
Width	40 mm	80 mm
Height	125 mm	125 mm
Depth	120 mm	120 mm
Weights		
Weight, approx.	330 g	465 g

SIMATIC S7-300 Advanced Controllers

I/O modules

F digital/analog modules

SM 326 F digital output modules - Safety Integrated

Ordering data

SM 326 F digital output module

10 outputs, 24 V DC, 2 A PP;
width 40 mm

6ES7326-2BF10-0AB0

8 outputs, 24 V DC, 2 A PM;
width 80 mm

6ES7326-2BF41-0AB0

S7 Distributed Safety V5.4 programming tool

Task:

Configuration software for configuring fail-safe user programs for SIMATIC S7-300F, S7-400F, WinAC RTX F, ET 200S, ET 200M, ET 200iSP, ET 200pro, ET 200eco

Requirement:

STEP 7 V5.3 SP3 and higher

Floating license

6ES7833-1FC02-0YA5

Floating license for 1 user, license key download without software or documentation¹⁾; email address required for delivery

6ES7833-1FC02-0YH5

S7 Distributed Safety upgrade

From V5.x to V5.4; floating license for 1 user

6ES7833-1FC02-0YE5

STEP 7 Safety Advanced V14 SP1

Task:

Engineering tool for configuring and programming fail-safe user programs for SIMATIC S7-1200 FC, S7-1500F, S7-1500F Software Controller, S7-300F, S7-400F, WinAC RTX F, ET 200SP F Controller and the fail-safe ET 200SP, ET 200S, ET 200M, ET 200iSP, ET 200pro and ET 200eco I/O

Requirement:

STEP 7 Professional V14 SP1

Floating license for 1 user, software and documentation on DVD; license key on USB flash drive

6ES7833-1FA14-0YA5

Floating license for 1 user, software, documentation and license key for download¹⁾; email address required for delivery

6ES7833-1FA14-0YH5

DIN rail for active bus modules

for max. 5 active bus modules, for function "Insertion and removal"

- 483 mm (19") long
- 530 mm long
- 620 mm long
- 2000 mm long

6ES7195-1GA00-0XA0

6ES7195-1GF30-0XA0

6ES7195-1GG30-0XA0

6ES7195-1GC00-0XA0

Article No.

Active bus modules

BM 2 x 40 for accepting
2 I/O modules each 40 mm wide

6ES7195-7HB00-0XA0

BM 1 x 80 for accepting
1 I/O module 80 mm wide

6ES7195-7HC00-0XA0

SITOP power supply module

6ES7307-1EA01-0AA0

for ET 200M; 120/230 V AC,
24 V DC, 5 A; Type PS 307-1E

Front connectors

40-pin, with screw contacts

- 1 unit
- 100 units

6ES7392-1AM00-0AA0

6ES7392-1AM00-1AB0

40-pin, with spring-loaded contacts

- 1 unit
- 100 units

6ES7392-1BM01-0AA0

6ES7392-1BM01-1AB0

Front door, higher version, for F-modules

6ES7328-7AA10-0AA0

For F-modules; for connecting
1.3 mm²/16 AWG wires;
wiring diagram and labels in yellow

Labeling strips

6ES7392-2XX20-0AA0

For F-modules (spare part), 10 units

Label cover

6ES7392-2XY20-0AA0

For F-modules (spare part), 10 units

LK 393 cable guide

6ES7393-4AA10-0AA0

For F-modules;
L+ and M connections, 5 units

SIMATIC Manual Collection

6ES7998-8XC01-8YE0

Electronic manuals on DVD, multilingual:
LOGO!, SIMADYN, SIMATIC bus components, SIMATIC C7, SIMATIC distributed I/O, SIMATIC HMI, SIMATIC Sensors, SIMATIC NET, SIMATIC PC Based Automation, SIMATIC PCS 7, SIMATIC PG/PC, SIMATIC S7, SIMATIC Software, SIMATIC TDC

SIMATIC Manual Collection update service for 1 year

6ES7998-8XC01-8YE2

Current "Manual Collection" DVD and the three subsequent updates

¹⁾ For up-to-date information and download availability, see:
<http://www.siemens.com/tia-online-software-delivery>

Overview



- Analog inputs for the fail-safe SIMATIC S7 systems
- Applicable in the ET 200M distributed I/O device with IM 153-2 HF as well as centrally with SIMATIC S7-31xF-2 DP
- Properties of the SM 336; F-AI 6 x 0/4 - 20 mA HART:
 - 6 analog inputs with galvanic isolation between channels and backplane bus
 - Input ranges: 0 to 20 mA, 4 to 20 mA
 - Short-circuit proof power supply from 2 or 4-wire transducer via the module
 - External encoder supply possible
 - Applicable in safety mode
 - HART communication
 - Firmware update using HW Config
 - Identification data

Technical specifications

Article number	6ES7336-4GE00-0AB0 SM 336, F-AI 6 X 0/4 ... 20MA HART
General information	
Product type designation	SM 336 F-AI 6x0/4 to 20 mA HART
Supply voltage	
Rated value (DC)	24 V
Reverse polarity protection	Yes
Input current	
From power supply L+, typ.	150 mA
from backplane bus 5 V DC, max.	90 mA
Power loss	
Power loss, typ.	4.5 W
Analog inputs	
Number of analog inputs	6
permissible input current for current input (destruction limit), max.	40 mA
Input ranges (rated values), currents	
• 0 to 20 mA	Yes
• 4 mA to 20 mA	Yes
Cable length	
• shielded, max.	1 000 m
Analog value generation for the inputs	
Integration and conversion time/resolution per channel	
• Resolution with overrange (bit including sign), max.	16 bit; 15 bit + sign
• Integration time (ms)	20 ms @ 50 Hz, 16.7 ms @ 60 Hz
• Interference voltage suppression for interference frequency f1 in Hz	f=n x (f1±0.5%)
Encoder	
Connection of signal encoders	
• for current measurement as 2-wire transducer	Yes
• for current measurement as 4-wire transducer	Yes

Article number	6ES7336-4GE00-0AB0 SM 336, F-AI 6 X 0/4 ... 20MA HART
Errors/accuracies	
Operational error limit in overall temperature range	
• Current, relative to input range, (+/-) 0.2 %; 40 µA	
Basic error limit (operational limit at 25 °C)	
• Current, relative to input range, (+/-) 0.1 %	
Interrupts/diagnostics/status information	
Alarms	
• Diagnostic alarm	Yes
Diagnostic messages	
• Diagnostic information readable	Yes
Potential separation	
Potential separation analog inputs	
• between the channels	Yes
• between the channels and backplane bus	Yes
• between the channels and the power supply of the electronics	Yes
Isolation	
Isolation tested with	370V for 1 min
Standards, approvals, certificates	
Highest safety class achievable in safety mode	
• acc. to EN 954	4
• SIL acc. to IEC 61508	SIL 3
Connection method	
required front connector	20-pin
Dimensions	
Width	40 mm
Height	125 mm
Depth	120 mm
Weights	
Weight, approx.	350 g

SIMATIC S7-300 Advanced Controllers

I/O modules

F digital/analog modules

SM 336 F analog input modules - Safety Integrated**Ordering data****Article No.****SM 336 F analog input module**

6 inputs, 15 bit, 0/4 - 20 mA HART

6ES7336-4GE00-0AB0**S7 Distributed Safety V5.4 programming tool**

Task:

Configuration software for configuring fail-safe user programs for SIMATIC S7-300F, S7-400F, WinAC RTX F, ET 200S, ET 200M, ET 200iSP, ET 200pro, ET 200eco

Requirement:

STEP 7 V5.3 SP3 and higher

Floating license

6ES7833-1FC02-0YA5Floating license for 1 user, license key download without software or documentation¹⁾; email address required for delivery**6ES7833-1FC02-0YH5****S7 Distributed Safety upgrade**

From V5.x to V5.4; floating license for 1 user

6ES7833-1FC02-0YE5**STEP 7 Safety Advanced V14 SP1**

Task:

Engineering tool for configuring and programming fail-safe user programs for SIMATIC S7-1200 FC, S7-1500F, S7-1500F Software Controller, S7-300F, S7-400F, WinAC RTX F, ET 200SP F Controller and the fail-safe ET 200SP, ET 200S, ET 200M, ET 200iSP, ET 200pro and ET 200eco I/O

Requirement:

STEP 7 Professional V14 SP1

Floating license for 1 user, software and documentation on DVD; license key on USB flash drive

6ES7833-1FA14-0YA5Floating license for 1 user, software, documentation and license key for download¹⁾; email address required for delivery**6ES7833-1FA14-0YH5****DIN rail for active bus modules**

for max. 5 active bus modules for hot swapping function

- 483 mm long
- 530 mm long
- 620 mm long
- 2000 mm long

6ES7195-1GA00-0XA0
6ES7195-1GF30-0XA0
6ES7195-1GG30-0XA0
6ES7195-1GC00-0XA0

Article No.**Active bus module BM 2x40****6ES7195-7HB00-0XA0**

Bus module for accepting 2 I/O modules each 40 mm wide

SITOP power supply module**6ES7307-1EA01-0AA0**

for ET 200M; 120/230 V AC, 24 V DC, 5 A; Type PS 307-1E

Front connectors

20-pin, with screw contacts

- 1 unit
- 100 units

6ES7392-1AJ00-0AA0**6ES7392-1AJ00-1AB0**

20-pin, with spring-loaded contacts

- 1 unit
- 100 units

6ES7392-1BJ00-0AA0**6ES7392-1BJ00-1AB0****Front door, higher version, for F-modules****6ES7328-7AA10-0AA0**For F-modules; for connecting 1.3 mm²/16 AWG wires; wiring diagram and labels in yellow**Labeling strips****6ES7392-2XX20-0AA0**

For F-modules (spare part), 10 units

Label cover**6ES7392-2XY20-0AA0**

For F-modules (spare part), 10 units

LK 393 cable guide**6ES7393-4AA10-0AA0**

For F-modules; L+ and M connections, 5 units

SIMATIC Manual Collection**6ES7998-8XC01-8YE0**

Electronic manuals on DVD, multilingual: LOGO!, SIMADYN, SIMATIC bus components, SIMATIC C7, SIMATIC distributed I/O, SIMATIC HMI, SIMATIC Sensors, SIMATIC NET, SIMATIC PC Based Automation, SIMATIC PCS 7, SIMATIC PG/PC, SIMATIC S7, SIMATIC Software, SIMATIC TDC

SIMATIC Manual Collection update service for 1 year**6ES7998-8XC01-8YE2**

Current "Manual Collection" DVD and the three subsequent updates

¹⁾ For up-to-date information and download availability, see: <http://www.siemens.com/tia-online-software-delivery>

Overview



- Supports mixed operation of fail-safe signal modules in safety mode and S7-300 standard modules in an ET 200M when Cat. 4 or SIL 3 has to be achieved.
- The isolation module is not required if the safety class or safety category to be achieved is less than SIL 3 or Cat. 4, respectively.

When Cat. 4/SIL 3 is required, the isolation module must be implemented in the following situations:

Application	Isolation module must be used
Central use after CPU 31xF-2 DP or CPU 31xF-2 PN/DP <ul style="list-style-type: none"> • Only F-modules in the tier • Standard and F-modules in the tier 	Yes, behind the CPU Yes, after the last standard module and before the first F-module
Central use after CPU 31xF-2 DP or CPU 31xF-2 PN/DP in an expansion rack <ul style="list-style-type: none"> • Only F-modules in the tier • Standard and F-modules in the tier 	Yes, after the IM 36x Yes, after the last standard module and before the first F-module
Distributed behind the IM 153-2 with copper connection <ul style="list-style-type: none"> • Only F-modules in the station • Standard and F-modules in the station 	Yes, after the IM 153-2 Yes, after the last standard module and before the first F-module
Distributed behind the IM 153-2 with fiber-optic connection <ul style="list-style-type: none"> • Only F-modules in the station • Standard and F-modules in the station 	No Yes, after the last standard module and before the first F-module

Technical specifications

Article number	6ES7195-7KF00-0XA0 ISOLATION MODULE BETW. F- AND STD-MOD.
Weights	
Weight, approx.	10 g

Ordering data

Article No.

Isolation module	6ES7195-7KF00-0XA0
For simultaneous operation of fail-safe and standard modules in the same ET 200M	
Bus isolation module	6ES7195-7HG00-0XA0
For holding the isolation module in an ET 200M	

SIMATIC S7-300 Advanced Controllers

I/O modules

SIPLUS S7-300 F digital/analog modules

SIPLUS S7-300 SM 326 - Safety Integrated**Overview**

- Digital inputs for the fail-safe SIPLUS S7 systems
- For connecting:
 - Switches and 2-wire proximity switches
 - Sensors according to NAMUR and mechanical contacts, also for signals from hazardous areas
- With integral safety functions for fail-safe operation
- Can be used in fail-safe operation
 - Centrally: With S7-31xF-2 DP
 - Distributed in ET 200M: With SIMATIC IM 151-7 F-CPU, S7-31xF-2 DP, S7-416F-2 and S7-400F/FH
- In standard operation can be used in the same way as S7-300 modules

Note:

SIPLUS extreme products are based on SIMATIC standard products. The contents listed here were taken from the respective standard products. SIPLUS extreme specific information was added.

Technical specifications

Article number	6AG1326-1BK02-2AB0	6AG1326-1BK02-2AY0	6AG1326-1RF01-4AB0
Based on	6ES7326-1BK02-0AB0 SIPLUS S7-300 SM326F DI24	6ES7326-1BK02-0AB0 SIPLUS S7-300 SM326F DI24	6ES7326-1RF01-0AB0 SIPLUS S7-300 SM326F DI8 NAMUR
Ambient conditions			
Ambient temperature during operation			
• min.	-25 °C; = Tmin	-25 °C; = Tmin	0 °C; = Tmin
• max.	60 °C; = Tmax; *+70 °C where forced convection with a minimum air velocity of 0.7 m/s through the modules and rated voltage of 24 V ±5 % are ensured. If in the course of maintenance or automatic diagnosis it is determined that the admissible specified parameters have been exceeded, the modules should be subjected to a proof test (function check) by the manufacturer.	60 °C; = Tmax; the rated temperature range of -25 ... +55 °C (T1) applies for the use on railway vehicles according to EN50155	60 °C; = Tmax
Extended ambient conditions			
• relative to ambient temperature-atmospheric pressure-installation altitude	Tmin ... Tmax at 1080 hPa ... 795 hPa (-1000 m ... +2000 m)	Tmin ... Tmax at 1080 hPa ... 795 hPa (-1000 m ... +2000 m)	Tmin ... Tmax at 1080 hPa ... 795 hPa (-1000 m ... +2000 m)
Relative humidity			
- With condensation, tested in accordance with IEC 60068-2-38, max.	100 %; RH incl. condensation/frost (no commissioning under condensation conditions)		100 %; RH incl. condensation/frost (no commissioning under condensation conditions)
Resistance			
- against biologically active substances / conformity with EN 60721-3-3	Yes; Class 3B2 mold, fungus and dry rot spores (with the exception of fauna). The supplied connector covers must remain on the unused interfaces during operation!		Yes; Class 3B2 mold, fungus and dry rot spores (with the exception of fauna). The supplied connector covers must remain on the unused interfaces during operation!
- against chemically active substances / conformity with EN 60721-3-3	Yes; Class 3C4 (RH < 75%) incl. salt spray according to EN 60068-2-52 (degree of severity 3). The supplied connector covers must remain on the unused interfaces during operation!		Yes; Class 3C4 (RH < 75%) incl. salt spray according to EN 60068-2-52 (degree of severity 3). The supplied connector covers must remain on the unused interfaces during operation!
- against mechanically active substances / conformity with EN 60721-3-3	Yes; Class 3S4 incl. sand, dust. The supplied connector covers must remain on the unused interfaces during operation!		Yes; Class 3S4 incl. sand, dust. The supplied connector covers must remain on the unused interfaces during operation!

Ordering data	Article No.	Article No.
SIPLUS S7-300 SM 326 F digital input <i>For industrial applications with extended ambient conditions</i> <u>Extended temperature range and exposure to media</u> 24 inputs, 24 V DC, fail-safe, with diagnostics interrupt 8 inputs, 24 V DC, NAMUR, fail-safe <i>For rolling stock railway applications</i> Conforms to EN 50155 24 inputs, 24 V DC, fail-safe, with diagnostics interrupt	6AG1326-1BK02-2AB0 6AG1326-1RF01-4AB0 6AG1326-1BK02-2AY0	<i>Programming tools and documentation</i> S7 Distributed Safety programming tool V5.4 Task: Configuration software for configuring fail-safe user programs for SIMATIC S7-300F, S7-400F, WinAC RTX F, ET 200S, ET 200M, ET 200iSP, ET 200pro, ET 200eco Requirement: STEP 7 V5.3 SP3 and higher Floating license Floating license for 1 user, license key download without software or documentation ¹⁾ ; email address required for delivery
Accessories <i>Mandatory</i> Front connector 40-pin, with spring-loaded contacts <ul style="list-style-type: none"> 1 unit 100 units 	6ES7392-1BM01-0AA0 6ES7392-1BM01-1AB0	S7 Distributed Safety upgrade From V5.x to V5.4; floating license for 1 user
<i>Accessories for hot swapping function</i> Active bus module BM 1 x 80 for 1 module, 80 mm wide	6AG1195-7HC00-2XA0	STEP 7 Safety Advanced V14 SP1 Task: Engineering tool for configuring and programming fail-safe user programs for SIMATIC S7-1200 FC, S7-1500F, S7-1500F Software Controller, S7-300F, S7-400F, WinAC RTX F, ET 200SP F Controller and the fail-safe ET 200SP, ET 200S, ET 200M, ET 200iSP, ET 200pro and ET 200eco I/O Requirement: STEP 7 Professional V14 SP1 Floating license for 1 user, software and documentation on DVD; license key on USB flash drive
<i>Consumables</i> DIN rail for active bus modules For max. 5 active bus modules for hot swapping function <ul style="list-style-type: none"> Length 483 mm (19") Length 530 mm Length 620 mm Length 2000 mm 	6ES7195-1GA00-0XA0 6ES7195-1GF30-0XA0 6ES7195-1GG30-0XA0 6ES7195-1GC00-0XA0	Floating license for 1 user, software, documentation and license key for download ¹⁾ ; email address required for delivery
Front door, elevated design, for F-modules For F-modules; for connecting 1.3 mm ² /16 AWG wires; wiring diagram and labels in yellow	6ES7328-7AA10-0AA0	SIMATIC Manual Collection Electronic manuals on DVD, multi-language: LOGO!, SIMADYN, SIMATIC bus components, SIMATIC C7, SIMATIC distributed I/O, SIMATIC HMI, SIMATIC Sensors, SIMATIC NET, SIMATIC PC Based Automation, SIMATIC PCS 7, SIMATIC PG/PC, SIMATIC S7, SIMATIC Software, SIMATIC TDC
Labeling strips For F-modules (spare part); 10 units	6ES7392-2XX20-0AA0	SIMATIC Manual Collection update service for 1 year Current "Manual Collection" DVD and the three subsequent updates
Label cover For F-modules (spare part); 10 units	6ES7392-2XY20-0AA0	
LK 393 cable guide For F-modules; L+ and M connections; 5 units	6ES7393-4AA10-0AA0	

¹⁾ For up-to-date information and download availability, see: <http://www.siemens.com/tia-online-software-delivery>

SIMATIC S7-300 Advanced Controllers

I/O modules

SIPLUS S7-300 F digital/analog modules

SIPLUS S7-300 SM 326 - Safety Integrated**Overview**

- Digital outputs for the fail-safe SIMATIC S7 systems
- For connection of solenoid valves, DC contactors and indicator lights
- With integral safety functions for fail-safe operation
- Can be used in fail-safe mode
 - Centrally: With S7-31xF-2 DP
 - Distributed in ET 200M: With SIMATIC IM 151-7 F-CPU, S7-31xF-2 DP, S7-416F-2 and S7-400F/FH

Note:

SIPLUS extreme products are based on SIMATIC standard products. The contents listed here were taken from the respective standard products. SIPLUS extreme specific information was added.

Technical specifications

Article number	6AG1326-2BF10-2AB0	6AG1326-2BF10-2AY0	6AG1326-2BF41-2AB0	6AG1326-2BF41-2AY0
Based on	6ES7326-2BF10-0AB0 SIPLUS S7-300 SM326F 10 DO	6ES7326-2BF10-0AB0 SIPLUS S7-300 SM326 10F-DO	6ES7326-2BF41-0AB0 SIPLUS S7-300 SM326F DO8	6ES7326-2BF41-0AB0 SIPLUS S7-300 SM326 F DO8 EN50155
Ambient conditions				
Ambient temperature during operation				
• min.	-25 °C	-25 °C; = Tmin	-25 °C	-25 °C; = Tmin
• max.	60 °C; = Tmax; *+70 °C when forced convection at a minimum air speed of 0.3 m/s through the modules is ensured. If in the course of maintenance or automatic diagnosis it is determined that the admissible specified parameters have been exceeded, the modules should be subjected to a proof test (function check) by the manufacturer.	60 °C; = Tmax; the rated temperature range of -25 ... +55 °C (T1) applies for the use on railway vehicles according to EN50155	60 °C	60 °C; = Tmax; the rated temperature range of -25 ... +55 °C (T1) applies for the use on railway vehicles according to EN50155
Extended ambient conditions				
• relative to ambient temperature-atmospheric pressure-installation altitude	Tmin ... Tmax at 1080 hPa ... 795 hPa (-1000 m ... +2000 m)	Tmin ... Tmax at 1080 hPa ... 795 hPa (-1000 m ... +2000 m)	Tmin ... Tmax at 1080 hPa ... 795 hPa (-1000 m ... +2000 m)	Tmin ... Tmax at 1080 hPa ... 795 hPa (-1000 m ... +2000 m)
Relative humidity				
- With condensation, tested in accordance with IEC 60068-2-38, max.	100 %; RH incl. condensation/frost (no commissioning under condensation conditions)		100 %; RH incl. condensation/frost (no commissioning under condensation conditions)	
Resistance				
- against biologically active substances / conformity with EN 60721-3-3	Yes; Class 3B2 mold, fungus and dry rot spores (with the exception of fauna). The supplied connector covers must remain on the unused interfaces during operation!		Yes; Class 3B2 mold, fungus and dry rot spores (with the exception of fauna). The supplied connector covers must remain on the unused interfaces during operation!	
- against chemically active substances / conformity with EN 60721-3-3	Yes; Class 3C4 (RH < 75%) incl. salt spray according to EN 60068-2-52 (degree of severity 3). The supplied connector covers must remain on the unused interfaces during operation!		Yes; Class 3C4 (RH < 75%) incl. salt spray according to EN 60068-2-52 (degree of severity 3). The supplied connector covers must remain on the unused interfaces during operation!	
- against mechanically active substances / conformity with EN 60721-3-3	Yes; Class 3S4 incl. sand, dust. The supplied connector covers must remain on the unused interfaces during operation!		Yes; Class 3S4 incl. sand, dust. The supplied connector covers must remain on the unused interfaces during operation!	

Ordering data	Article No.	Article No.
SIPLUS S7-300 SM 326 F digital output <i>For industrial applications with extended ambient conditions</i> <u>Extended temperature range and exposure to media</u> 10 outputs, 24 V DC, 2 A, fail-safe 8 outputs, 24 V DC, 2 A, fail-safe, source-sinking output <i>For rolling stock railway applications</i> <u>Conforms to EN 50155</u> 10 outputs, 24 V DC, 2 A, fail-safe 8 outputs, 24 V DC, 2 A, fail-safe, source-sinking output	6AG1326-2BF10-2AB0 6AG1326-2BF41-2AB0 6AG1326-2BF10-2AY0 6AG1326-2BF41-2AY0	<i>Programming tools and documentation</i> S7 Distributed Safety programming tool V5.4 Task: Configuration software for configuring fail-safe user programs for SIMATIC S7-300F, S7-400F, WinAC RTX F, ET 200S, ET 200M, ET 200iSP, ET 200pro, ET 200eco Requirement: STEP 7 V5.3 SP3 and higher Floating license Floating license for 1 user, license key download without software or documentation ¹⁾ ; email address required for delivery
Accessories <i>Mandatory</i> Front connector 40-pin, with spring-loaded contacts <ul style="list-style-type: none"> • 1 unit • 100 units <i>Accessories for hot swapping function</i> Active bus module BM 2 x 40 for accepting 2 I/O modules each 40 mm wide BM 1 x 80 for 1 module, 80 mm wide <i>Consumables</i> DIN rail for active bus modules For max. 5 active bus modules for hot swapping function <ul style="list-style-type: none"> • Length 483 mm (19") • Length 530 mm • Length 620 mm • Length 2000 mm Front door, elevated design, for F-modules For F-modules; for connecting 1.3 mm ² /16 AWG wires; wiring diagram and labels in yellow Labeling strips For F-modules (spare part); 10 units Label cover For F-modules (spare part); 10 units LK 393 cable guide For F-modules; L+ and M connections; 5 units	6ES7392-1BM01-0AA0 6ES7392-1BM01-1AB0 6AG1195-7HB00-7XA0 6AG1195-7HC00-2XA0 6ES7195-1GA00-0XA0 6ES7195-1GF30-0XA0 6ES7195-1GG30-0XA0 6ES7195-1GC00-0XA0 6ES7328-7AA10-0AA0 6ES7392-2XX20-0AA0 6ES7392-2XY20-0AA0 6ES7393-4AA10-0AA0	S7 Distributed Safety upgrade From V5.x to V5.4; floating license for 1 user STEP 7 Safety Advanced V14 SP1 Task: Engineering tool for configuring and programming fail-safe user programs for SIMATIC S7-1200 FC, S7-1500F, S7-1500F Software Controller, S7-300F, S7-400F, WinAC RTX F, ET 200SP F Controller and the fail-safe ET 200SP, ET 200S, ET 200M, ET 200iSP, ET 200pro and ET 200eco I/O Requirement: STEP 7 Professional V14 SP1 Floating license for 1 user, software and documentation on DVD; license key on USB flash drive Floating license for 1 user, software, documentation and license key for download ¹⁾ ; email address required for delivery SIMATIC Manual Collection Electronic manuals on DVD, multi-language: LOGO!, SIMADYN, SIMATIC bus components, SIMATIC C7, SIMATIC distributed I/O, SIMATIC HMI, SIMATIC Sensors, SIMATIC NET, SIMATIC PC Based Automation, SIMATIC PCS 7, SIMATIC PG/PC, SIMATIC S7, SIMATIC Software, SIMATIC TDC SIMATIC Manual Collection update service for 1 year Current "Manual Collection" DVD and the three subsequent updates
		6ES7833-1FC02-0YA5 6ES7833-1FC02-0YH5 6ES7833-1FC02-0YE5 6ES7833-1FA14-0YA5 6ES7833-1FA14-0YH5 6ES7998-8XC01-8YE0 6ES7998-8XC01-8YE2

¹⁾ For up-to-date information and download availability, see: <http://www.siemens.com/tia-online-software-delivery>

SIMATIC S7-300 Advanced Controllers

I/O modules

SIPLUS S7-300 F digital/analog modules

SIPLUS S7-300 SM 336 - Safety Integrated**Overview**

- Analog inputs for fail-safe SIPLUS S7 systems
- Applicable in the ET 200M distributed I/O device with IM 153-2 HF as well as centrally with SIPLUS S7-31xF-2 DP
- Properties of the SM 336; F-AI 6 x 0/4 ... 20 mA HART:
 - 6 analog inputs with galvanic isolation between channels and backplane bus
 - Input ranges: 0 mA to 20 mA, 4 mA to 20 mA
 - Short-circuit proof power supply of 2 or 4-wire transmitter via the module
 - External encoder supply possible
 - Applicable in safety mode
 - HART communication
 - Firmware update using HW Config
 - Identification data
 - Temperature range -25 ... +70 °C; (+70 °C when ensuring a forced convection with a minimal air velocity of 0.3 m/s through the module. If a violation of the permissible, specified parameters is detected during maintenance or by automatic diagnostics, the modules must be proof-tested by the manufacturer. Without this measure the temperature range is -25...60 °C)

Note:

SIPLUS extreme products are based on SIMATIC standard products. The contents listed here were taken from the respective standard products. SIPLUS extreme specific information was added.

Technical specifications

Article number	6AG1336-4GE00-2AB0
Based on	6ES7336-4GE00-0AB0 SIPLUS S7-300 SM336 F 6AI 15BIT
Ambient conditions	
Ambient temperature during operation	
• min.	-25 °C; = Tmin; Startup @ -25 °C
• max.	60 °C; = T max; *+70 °C when forced convection at a minimum air speed of 0.3 m/s through the modules is ensured. If in the course of maintenance or automatic diagnosis it is determined that the admissible specified parameters have been exceeded, the modules should be subjected to a proof test (function check) by the manufacturer.
Ambient temperature during storage/transportation	
• min.	-40 °C
• max.	70 °C
Extended ambient conditions	
• relative to ambient temperature-atmospheric pressure-installation altitude	Tmin ... Tmax at 1080 hPa ... 795 hPa (-1000 m ... +2000 m)
• At cold restart, min.	-25 °C

Article number	6AG1336-4GE00-2AB0
Based on	6ES7336-4GE00-0AB0 SIPLUS S7-300 SM336 F 6AI 15BIT
Relative humidity	
- With condensation, tested in accordance with IEC 60068-2-38, max.	100 %; incl. condensation / frost permitted (no commissioning under condensation conditions)
Resistance	
- against biologically active substances / conformity with EN 60721-3-3	Yes; Class 3B2 mold, fungus and dry rot spores (with the exception of fauna). The supplied connector covers must remain on the unused interfaces during operation!
- against chemically active substances / conformity with EN 60721-3-3	Yes; Class 3C4 incl. salt spray according to EN 60068-2-52 (degree of severity 3). The supplied connector covers must remain on the unused interfaces during operation!
- against mechanically active substances / conformity with EN 60721-3-3	Yes; Class 3S4 incl. sand, dust The supplied connector covers must remain on the unused interfaces during operation!

SIMATIC S7-300 Advanced Controllers

I/O modules

SIPLUS S7-300 F digital/analog modules

SIPLUS S7-300 SM 336 - Safety Integrated

Ordering data	Article No.	Article No.
SIPLUS S7-300 SM 336 F analog input module <i>For industrial applications with extended ambient conditions</i> <u>Extended temperature range and exposure to media</u> 6 inputs, 15 bit, 0/4 - 20 mA HART	6AG1336-4GE00-2AB0	<i>Programming tools and documentation</i> S7 Distributed Safety programming tool V5.4 Task: Configuration software for configuring fail-safe user programs for SIMATIC S7-300F, S7-400F, WinAC RTX F, ET 200S, ET 200M, ET 200iSP, ET 200pro, ET 200eco Requirement: STEP 7 V5.3 SP3 and higher Floating license
Accessories <i>Mandatory</i> Front connector 20-pin, with spring-loaded contacts <ul style="list-style-type: none"> • 1 unit • 100 units 	6ES7392-1BJ00-0AA0 6ES7392-1BJ00-1AB0	Floating license for 1 user, license key download without software or documentation ¹⁾ ; email address required for delivery 6ES7833-1FC02-0YA5 6ES7833-1FC02-0YH5
<i>Accessories for hot swapping function</i> Active bus module BM 2 x 40 for accepting 2 I/O modules, each 40 mm wide	6AG1195-7HB00-7XA0	S7 Distributed Safety upgrade From V5.x to V5.4; floating license for 1 user 6ES7833-1FC02-0YE5
<i>Consumables</i> DIN rail for active bus modules For max. 5 active bus modules for hot swapping function <ul style="list-style-type: none"> • Length 483 mm (19") • Length 530 mm • Length 620 mm • Length 2000 mm 	6ES7195-1GA00-0XA0 6ES7195-1GF30-0XA0 6ES7195-1GG30-0XA0 6ES7195-1GC00-0XA0	STEP 7 Safety Advanced V14 SP1 Task: Engineering tool for configuring and programming fail-safe user programs for SIMATIC S7-1200 FC, S7-1500F, S7-1500F Software Controller, S7-300F, S7-400F, WinAC RTX F, ET 200SP F Controller and the fail-safe ET 200SP, ET 200S, ET 200M, ET 200iSP, ET 200pro and ET 200eco I/O Requirement: STEP 7 Professional V14 SP1 Floating license for 1 user, software and documentation on DVD; license key on USB flash drive
Front door, elevated design, for F-modules For F-modules; for connecting 1.3 mm ² /16 AWG wires; wiring diagram and labels in yellow	6ES7328-7AA10-0AA0	6ES7833-1FA14-0YA5 6ES7833-1FA14-0YH5
Labeling strips For F-modules (spare part); 10 units	6ES7392-2XX20-0AA0	Floating license for 1 user, software, documentation and license key for download ¹⁾ ; email address required for delivery 6ES7833-1FA14-0YH5
Label cover For F-modules (spare part); 10 units	6ES7392-2XY20-0AA0	SIMATIC Manual Collection 6ES7998-8XC01-8YE0
LK 393 cable guide For F-modules; L+ and M connections; 5 units	6ES7393-4AA10-0AA0	Electronic manuals on DVD, multi-language: LOGO!, SIMADYN, SIMATIC bus components, SIMATIC C7, SIMATIC distributed I/O, SIMATIC HMI, SIMATIC Sensors, SIMATIC NET, SIMATIC PC Based Automation, SIMATIC PCS 7, SIMATIC PG/PC, SIMATIC S7, SIMATIC Software, SIMATIC TDC SIMATIC Manual Collection update service for 1 year 6ES7998-8XC01-8YE2 Current "Manual Collection" DVD and the three subsequent updates

¹⁾ For up-to-date information and download availability, see: <http://www.siemens.com/tia-online-software-delivery>

SIMATIC S7-300 Advanced Controllers

I/O modules

SIPLUS S7-300 F digital/analog modules

SIPLUS S7-300 isolation module**Overview**

- Permits combined operation of fail-safe signal modules in safety mode and standard S7-300 modules in the same ET 200M system.
- The isolation module is not required if the safety class SIL 3 or safety category < Cat. 4 is to be achieved.

Note:

SIPLUS extreme products are based on SIMATIC standard products. The contents listed here were taken from the respective standard products. SIPLUS extreme specific information was added.

Technical specifications

Article number	6AG1195-7KF00-2XA0
Based on	6ES7195-7KF00-0XA0 SIPLUS S7-300 ISOLATION MODULE
Standards, approvals, certificates	
CE mark	Yes
UL approval	Yes; File E239877
FM approval	Yes; CofC 3028431
Ambient conditions	
Ambient temperature during operation	
• min.	-25 °C; = Tmin
• max.	60 °C; = Tmax
Ambient temperature during storage/transportation	
• min.	-40 °C
• max.	70 °C

Article number	6AG1195-7KF00-2XA0
Based on	6ES7195-7KF00-0XA0 SIPLUS S7-300 ISOLATION MODULE
Extended ambient conditions	
• relative to ambient temperature-atmospheric pressure-installation altitude	Tmin ... Tmax at 1080 hPa ... 795 hPa (-1000 m ... +2000 m)
Relative humidity	
- With condensation, tested in accordance with IEC 60068-2-38, max.	100 %; RH incl. condensation/frost (no commissioning under condensation conditions)
Resistance	
- against biologically active substances / conformity with EN 60721-3-3	Yes
- against chemically active substances / conformity with EN 60721-3-3	Yes
- against mechanically active substances / conformity with EN 60721-3-3	Yes

Ordering data

SIPLUS F isolation module
for simultaneous operation of fail-safe and standard modules in the same ET 200M
For industrial applications with extended ambient conditions
Extended temperature range and exposure to media

Article No.**6AG1195-7KF00-2XA0****Article No.****Accessories**

SIPLUS ET 200M bus safety protector F
For the simultaneous operation of fail-safe and standard modules in an ET200 M for the hot swapping function
Extended temperature range and exposure to media

6AG1195-7HG00-2XA0

Overview



- Digital inputs for signals from the Ex field
- For the connection of intrinsically safe digital equipment from the Ex field
- 4 DI NAMUR
- 4 digital inputs in 4 channel modules (single-channel isolation)
- Connectable encoder in accordance with EN 60947-5-6 and NAMUR, optionally with wired or unwired mechanical contacts
- Diagnostics and diagnostics alarm programmable

Technical specifications

Article number	6ES7321-7RD00-0AB0 SM321, 4DI, DC24V, HAZARDOUS AREAS
Supply voltage	
Load voltage L+	
• Rated value (DC)	24 V
Input current	
from load voltage L+ (without load), max.	50 mA
from backplane bus 5 V DC, max.	80 mA
Encoder supply	
Type of output voltage	via the inputs
Power loss	
Power loss, typ.	1.1 W
Digital inputs	
Number of NAMUR inputs	4
Input voltage	
• Rated value (DC)	8.2 V; from internal power circuit supply
Input current	
• on wire-break, max.	0.1 mA
• on short-circuit, max.	8.5 mA
for NAMUR encoders	
- for signal "0"	0.35 to 1.2 mA
- for signal "1"	2.1 to 7 mA
Input delay (for rated value of input voltage)	
• Input frequency (with a time delay of 0.1 ms), max.	2 kHz
for NAMUR inputs	
- Parameterizable	Yes; 0.1 / 0.5 / 3 / 15 / 20 ms (plus 0.25 ms preparation time)
Cable length	
• unshielded, max.	200 m
Encoder	
Connectable encoders	
• NAMUR encoder	Yes; Two-wire connection

Article number	6ES7321-7RD00-0AB0 SM321, 4DI, DC24V, HAZARDOUS AREAS
Interrupts/diagnostics/status information	
Diagnostic messages	
• Diagnostic information readable	Yes
Ex(i) characteristics	
Maximum values of input circuits (per channel)	
• Co (permissible external capacity), max.	3 µF
• Io (short-circuit current), max.	14.1 mA
• Lo (permissible external inductivity), max.	100 mH
• Po (power of load), max.	33.7 mW
• Uo (output no-load voltage), max.	10 V
Potential separation	
Potential separation digital inputs	
• Potential separation digital inputs	Yes
• between the channels, in groups of	1
Standards, approvals, certificates	
Use in hazardous areas	
• Type of protection acc. to EN 50020 (CENELEC)	[EEx ib] IIC
• Type of protection acc. to FM	Class II, Division 2, Group A, B, C, D T4
• Test number PTB	Ex-96.D.2094X
Ambient conditions	
Ambient temperature during operation	
• max.	60 °C
Connection method	
required front connector	20-pin
Weights	
Weight, approx.	230 g

SIMATIC S7-300 Advanced Controllers

I/O modules

Ex digital modules

Ex digital input modules

Ordering data	Article No.		Article No.
Ex digital input module 4 inputs, isolated, NAMUR	6ES7321-7RD00-0AB0	Labeling sheets for machine inscription for modules with 20-pin front connector, DIN A4, for printing with laser printer; 10 units	
Front connector 20-pin, with screw contacts • 1 unit • 100 units	6ES7392-1AJ00-0AA0 6ES7392-1AJ00-1AB0	Petrol	6ES7392-2AX00-0AA0
Front door, elevated design e.g. for 32 channel modules; enables connection of 1.3 mm ² /16 AWG wires	6ES7328-0AA00-7AA0	Light beige	6ES7392-2BX00-0AA0
LK 393 cable guide Mandatory for operation in hazardous areas	6ES7393-4AA00-0AA0	Yellow	6ES7392-2CX00-0AA0
Labeling strips 10 units (spare part), for modules with 20-pin front connector	6ES7392-2XX00-0AA0	Red	6ES7392-2DX00-0AA0
Label cover 10 units (spare part), for modules with 20-pin front connector	6ES7392-2XY00-0AA0	SIMATIC Manual Collection Electronic manuals on DVD, multilingual: LOGO!, SIMADYN, SIMATIC bus components, SIMATIC C7, SIMATIC distributed I/O, SIMATIC HMI, SIMATIC Sensors, SIMATIC NET, SIMATIC PC Based Automation, SIMATIC PCS 7, SIMATIC PG/PC, SIMATIC S7, SIMATIC Software, SIMATIC TDC	6ES7998-8XC01-8YE0
		SIMATIC Manual Collection update service for 1 year Current "Manual Collection" DVD and the three subsequent updates	6ES7998-8XC01-8YE2

Overview



- Digital outputs for signals from the Ex field
- For the connection of intrinsically safe digital equipment from the Ex field
- 4 DO 24 V DC/10mA or 4 DO 15 V DC/20 mA
- 4 digital outputs in 4 channel modules (single-channel isolation)
- Diagnostics and diagnostics alarm programmable
- Substitute value behavior programmable

Technical specifications

Article number	6ES7322-5SD00-0AB0	6ES7322-5RD00-0AB0
	SM322, 4DO, 15V DC, 10MA, HAZARDOUS AREAS	SM322, 4DO, 15V DC, 20MA, HAZARDOUS AREAS
Supply voltage		
Load voltage L+		
• Rated value (DC)	24 V	24 V
Input current		
from load voltage L+ (without load), max.	160 mA	160 mA
from backplane bus 5 V DC, max.	85 mA	85 mA
Power loss		
Power loss, typ.	3 W	3 W
Digital outputs		
Number of digital outputs	4	4
Short-circuit protection	Yes; Electronic	Yes; Electronic
• Response threshold, typ.	Output current with short-circuit protection, min. 10 mA + 10 %	Output current with short-circuit protection, min. 20.5 mA + 10 %
Load resistance range		
• upper limit	390 Ω; Two-wire connection	200 Ω; Two-wire connection
Output voltage		
• Rated value (DC)	24 V	15 V
Output current		
• for signal "1" permissible range for 0 to 60 °C, max.	10 mA; +/- 10 %	20 mA; +/- 10 %
Switching frequency		
• with resistive load, max.	100 Hz	100 Hz
Cable length		
• unshielded, max.	200 m	200 m
Interrupts/diagnostics/status information		
Diagnostic messages		
• Diagnostic information readable	Yes	Yes
• Short-circuit	Yes	Yes
Ex(i) characteristics		
Maximum values of output circuits (per channel)		
• Co (permissible external capacity), max.	90 nF	500 nF
• Io (short-circuit current), max.	70 mA	85 mA
• Lo (permissible external inductivity), max.	6.7 mH	5 mH
• Po (power of load), max.	440 mW	335 mW
• Uo (output no-load voltage), max.	25.2 V	15.75 V

SIMATIC S7-300 Advanced Controllers

I/O modules

Ex digital modules

Ex digital output modules

Technical specifications (continued)

Article number	6ES7322-5SD00-0AB0	6ES7322-5RD00-0AB0
	SM322, 4DO, 15V DC, 10MA, HAZARDOUS AREAS	SM322, 4DO, 15V DC, 20MA, HAZARDOUS AREAS
Potential separation		
Potential separation digital outputs		
• Potential separation digital outputs	Yes	Yes
• between the channels, in groups of	1	1
Standards, approvals, certificates		
Use in hazardous areas		
• Type of protection acc. to EN 50020 (CENELEC)	[EEx ib] IIC	[EEx ib] IIC
• Type of protection acc. to FM	Class I, Division 2, Group A, B, C, D T4	AIS CL.1, DIV 1, GP A, B, C, D; CL.I, DIV 2, GP A, B, C, D T4
• Test number PTB	Ex-96.D.2093X	Ex-96.D.2102X
Ambient conditions		
Ambient temperature during operation		
• max.	60 °C	60 °C
Connection method		
required front connector	20-pin	20-pin
Weights		
Weight, approx.	230 g	230 g

Ordering data

Article No.	Article No.
Ex digital output modules	Labeling sheets for machine inscription
4 outputs, isolated, 24 V DC, 10 mA	6ES7322-5SD00-0AB0
4 outputs, isolated, 15 V DC, 20 mA	6ES7322-5RD00-0AB0
Front connector	for modules with 40-pin front connector, DIN A4, for printing with laser printer; 10 units
20-pin, with screw contacts	Petrol
• 1 unit	Light beige
• 100 units	Yellow
Front door, elevated design	Red
e.g. for 32 channel modules; enables connection of 1.3 mm ² /16 AWG wires	SIMATIC Manual Collection
LK 393 cable guide	6ES7322-5SD00-0AB0
Mandatory for operation in hazardous areas	6ES7322-5RD00-0AB0
Labeling strips	6ES7392-2AX00-0AA0
10 units (spare part), for modules with 20-pin front connector	6ES7392-2BX00-0AA0
Label cover	6ES7392-2CX00-0AA0
10 units (spare part), for modules with 20-pin front connector	6ES7392-2DX00-0AA0
	SIMATIC Manual Collection update service for 1 year
	6ES7998-8XC01-8YE0
	Current "Manual Collection" DVD and the three subsequent updates
	6ES7998-8XC01-8YE2

Overview

- Digital inputs for signals from the Ex field
- For the connection of intrinsically safe digital equipment from the Ex field
- 4 DI NAMUR
- 4 digital inputs in 4 channel modules (single-channel isolation)
- Connectable encoder in accordance with EN 60947-5-6 and NAMUR, optionally with wired or unwired mechanical contacts
- Programmable diagnostics and diagnostic interrupt

Note:

SIPLUS extreme products are based on SIMATIC standard products. The contents listed here were taken from the respective standard products. SIPLUS extreme specific information was added.

Technical specifications

Article number	6AG1321-7RD00-4AB0
Based on	6ES7321-7RD00-0AB0 SIPLUS S7-300 SM 321 4DI NAMUR
Ambient conditions	
Ambient temperature during operation	
• min.	0 °C; = Tmin
• max.	60 °C; = Tmax
Ambient temperature during storage/transportation	
• min.	-40 °C
• max.	70 °C
Extended ambient conditions	
• relative to ambient temperature-atmospheric pressure-installation altitude	Tmin ... Tmax at 1080 hPa ... 795 hPa (-1000 m ... +2000 m) // Tmin ... (Tmax - 10K) at 795 hPa ... 658 hPa (+2000 m ... +3500 m) // Tmin ... (Tmax - 20K) at 658 hPa ... 540 hPa (+3500 m ... +5000 m)
Relative humidity	
- With condensation, tested in accordance with IEC 60068-2-38, max.	100 %; RH incl. condensation / frost (no commissioning in bedewed state), horizontal installation

Article number	6AG1321-7RD00-4AB0
Based on	6ES7321-7RD00-0AB0 SIPLUS S7-300 SM 321 4DI NAMUR
Resistance	
- against biologically active substances / conformity with EN 60721-3-3	Yes; Class 3B2 mold, fungus and dry rot spores (with the exception of fauna). The supplied connector covers must remain on the unused interfaces during operation!
- against chemically active substances / conformity with EN 60721-3-3	Yes; Class 3C4 (RH < 75%) incl. salt spray according to EN 60068-2-52 (degree of severity 3). The supplied connector covers must remain on the unused interfaces during operation!
- against mechanically active substances / conformity with EN 60721-3-3	Yes; Class 3S4 incl. sand, dust. The supplied connector covers must remain on the unused interfaces during operation!

SIMATIC S7-300 Advanced Controllers

I/O modules

SIPLUS S7-300 Ex digital modules

SIPLUS S7-300 Ex digital input modules

Ordering data	Article No.	Ordering data	Article No.
SIPLUS S7-300 Ex digital input module <u>Exposure to media</u> 4 inputs, isolated, NAMUR	6AG1321-7RD00-4AB0	Label cover 10 units (spare part), for modules with 20-pin front connector	6ES7392-2XY00-0AA0
Accessories <i>Mandatory</i> Front connector 20-pin, with spring-loaded contacts <ul style="list-style-type: none"> • 1 unit • 100 units 	6ES7392-1BJ00-0AA0 6ES7392-1BJ00-1AB0	Labeling sheets for machine inscription For modules with 20-pin front connector, DIN A4, for printing with laser printer; 10 units Petrol Light beige Yellow Red	6ES7392-2AX00-0AA0 6ES7392-2BX00-0AA0 6ES7392-2CX00-0AA0 6ES7392-2DX00-0AA0
<i>Consumables</i> DIN rail for active bus modules For max. 5 active bus modules for hot swapping function <ul style="list-style-type: none"> • Length 483 mm (19") • Length 530 mm • Length 620 mm • Length 2000 mm 	6ES7195-1GA00-0XA0 6ES7195-1GF30-0XA0 6ES7195-1GG30-0XA0 6ES7195-1GC00-0XA0	<i>Documentation</i> SIMATIC Manual Collection Electronic manuals on DVD, multi-language: LOGO!, SIMADYN, SIMATIC bus components, SIMATIC C7, SIMATIC distributed I/O, SIMATIC HMI, SIMATIC Sensors, SIMATIC NET, SIMATIC PC Based Automation, SIMATIC PCS 7, SIMATIC PG/PC, SIMATIC S7, SIMATIC Software, SIMATIC TDC	6ES7998-8XC01-8YE0
Front door, elevated design E.g. for 32-channel modules; for connecting 1.3 mm ² /16 AWG conductors; circuit diagram and nameplates in petrol	6ES7328-0AA00-7AA0	SIMATIC Manual Collection update service for 1 year Current "Manual Collection" DVD and the three subsequent updates	6ES7998-8XC01-8YE2
LK 393 cable guide Mandatory for operation in hazardous areas	6ES7393-4AA00-0AA0		
Labeling strips 10 units (spare part), for modules with 20-pin front connector	6ES7392-2XX00-0AA0		

Overview



- Analog inputs for signals from the Ex field
- For the connection of intrinsically safe analog equipment from the Ex field
- 8 or 4 analog inputs in 4 channel groups (single-channel isolation)
- Measurement type and range can be selected for each channel
- Diagnostics and diagnostics alarm programmable
- Programmable threshold alarm
- HART-compatible inputs (only 6ES7331-7RD00-0AB0)

Technical specifications

Article number	6ES7331-7RD00-0AB0	6ES7331-7SF00-0AB0
	SIMATIC S7, SM 331 ANALOG INPUT	SIMATIC S7, SM 331 ANALOG INPUT
Supply voltage		
Load voltage L+		
• Rated value (DC)	24 V	24 V
Input current		
from load voltage L+ (without load), max.	250 mA	
from backplane bus 5 V DC, max.	60 mA	120 mA
Output voltage		
Power supply to the transmitters		
• Rated value (DC)	13 V; at 22 mA	
• No-load voltage (DC)	25.2 V	
Power loss		
Power loss, typ.	3 W	0.6 W
Analog inputs		
Number of analog inputs	4	8; 8x thermocouples; 4x RTD thermoresistors
permissible input current for current input (destruction limit), max.	40 mA	
Input ranges (rated values), currents		
• 0 to 20 mA	Yes	
• 4 mA to 20 mA	Yes	
Input ranges (rated values), thermocouples		
• Type B		Yes
• Type E		Yes
• Type J		Yes
• Type K		Yes
• Type L		Yes
• Type N		Yes
• Type R		Yes
• Type S		Yes
• Type T		Yes
• Type U		Yes

SIMATIC S7-300 Advanced Controllers

I/O modules

Ex analog modules

Ex analog input modules

Technical specifications (continued)

Article number	6ES7331-7RD00-0AB0 SIMATIC S7, SM 331 ANALOG INPUT	6ES7331-7SF00-0AB0 SIMATIC S7, SM 331 ANALOG INPUT
Input ranges (rated values), resistance thermometer		
• Ni 100		Yes
• Pt 100		Yes
• Pt 200		Yes
Cable length		
• shielded, max.	200 m	200 m; TC: 50 m
Analog value generation for the inputs		
Measurement principle	Sigma Delta	Sigma Delta
Integration and conversion time/ resolution per channel		
• Resolution with overrange (bit including sign), max.	16 bit; 10 bit to 15 bit + sign	16 bit; 10 bit to 15 bit + sign
• Integration time, parameterizable	Yes; 2.5 to 100 ms	Yes; 2.5 to 100 ms
• Interference voltage suppression for interference frequency f1 in Hz	10 to 400 Hz	10 to 400 Hz
Encoder		
Connection of signal encoders		
• for current measurement as 2-wire transducer	Yes	Yes
• for current measurement as 4-wire transducer	Yes	Yes
Errors/accuracies		
Temperature error (relative to input range), (+/-)		0.001 %/K; Temperature error: 0.001 to 0.002 %/K
Operational error limit in overall temperature range		
• Current, relative to input range, (+/-)	0.45 %	
• Resistance thermometer, relative to input range, (+/-)		0.04 %; 0.09 to 0.04%
Basic error limit (operational limit at 25 °C)		
• Current, relative to input range, (+/-)	0.1 %	
• Resistance thermometer, relative to input range, (+/-)		0.008 %; 0.018 ... 0.008%
Interference voltage suppression for $f = n \times (f1 \pm 1 \%)$, f1 = interference frequency		
• Series mode interference (peak value of interference < rated value of input range), min.	60 dB	60 dB
• Common mode interference, min.	130 dB	130 dB
Interrupts/diagnostics/ status information		
Diagnostic messages		
• Diagnostic information readable	Yes	Yes
• Overrange	Yes	Yes
• Wire-break in signal transmitter cable	Yes	Yes
• Short-circuit of the signal encoder cable	Yes	Yes
Ex(i) characteristics		
Maximum values of input circuits (per channel)		
• Co (permissible external capacity), max.	90 nF	43 µF
• Io (short-circuit current), max.	68.5 mA	28.8 mA
• Lo (permissible external inductivity), max.	7.5 mH	40 mH
• Po (power of load), max.	431 mW	41.4 mW
• Ri, max.	50 Ω	
• Uo (output no-load voltage), max.	25.2 V	5.9 V

Technical specifications (continued)

Article number	6ES7331-7RD00-0AB0	6ES7331-7SF00-0AB0
	SIMATIC S7, SM 331 ANALOG INPUT	SIMATIC S7, SM 331 ANALOG INPUT
Potential separation		
Potential separation analog inputs		
• Potential separation analog inputs	Yes	Yes
Permissible potential difference		
between the inputs (UCM)	60 V DC/30 V AC when used in the hazardous area; 400 V DC/250 V AC when used in NON-hazardous area	60 V DC/30 V AC when used in the hazardous area; 400 V DC/250 V AC when used in NON-hazardous area
Between the inputs and MANA (UCM)	60 V DC/30 V AC when used in the hazardous area; 400 V DC/250 V AC when used in NON-hazardous area	60 V DC/30 V AC when used in the hazardous area; 400 V DC/250 V AC when used in NON-hazardous area
Use in hazardous areas		
• Type of protection acc. to EN 50020 (CENELEC)	[Ex ib] IIC	[Ex ib] IIC
• Type of protection acc. to FM	Class I, Division 2, Group A, B, C, D T4	Class I, Division 2, Group A, B, C, D T4
• Test number PTB	Ex-96.D.2092X	Ex-96.D.2108X
Ambient conditions		
Ambient temperature during operation		
• max.	60 °C	60 °C
Connection method		
required front connector	20-pin	20-pin
Weights		
Weight, approx.	290 g	210 g

Ordering data

Ordering data	Article No.	Ordering data	Article No.
Ex analog input modules		Labeling sheets for machine inscription	
4 inputs, isolated, 0/4 to 20 mA, 15 bit	6ES7331-7RD00-0AB0	for modules with 20-pin front connector, DIN A4, for printing with laser printer; 10 units	
8/4 inputs, isolated, for thermo-couples and Pt100, Pt200, Ni100	6ES7331-7SF00-0AB0	Petrol	6ES7392-2AX00-0AA0
Front connector		Light beige	6ES7392-2BX00-0AA0
20-pin, with screw contacts		Yellow	6ES7392-2CX00-0AA0
• 1 unit	6ES7392-1AJ00-0AA0	Red	6ES7392-2DX00-0AA0
• 100 units	6ES7392-1AJ00-1AB0	SIMATIC Manual Collection	6ES7998-8XC01-8YE0
Front door, elevated design		Electronic manuals on DVD, multilingual: LOGO!, SIMADYN, SIMATIC bus components, SIMATIC C7, SIMATIC distributed I/O, SIMATIC HMI, SIMATIC Sensors, SIMATIC NET, SIMATIC PC Based Automation, SIMATIC PCS 7, SIMATIC PG/PC, SIMATIC S7, SIMATIC Software, SIMATIC TDC	
e.g. for 32 channel modules; enables connection of 1.3 mm ² /16 AWG wires	6ES7328-0AA00-7AA0	SIMATIC Manual Collection update service for 1 year	6ES7998-8XC01-8YE2
LK 393 cable guide		Current "Manual Collection" DVD and the three subsequent updates	
Mandatory for operation in hazardous areas	6ES7393-4AA00-0AA0		
Labeling strips			
10 units (spare part), for modules with 20-pin front connector	6ES7392-2XX00-0AA0		
Label cover			
10 units (spare part), for modules with 20-pin front connector	6ES7392-2XY00-0AA0		

SIMATIC S7-300 Advanced Controllers

I/O modules

Ex analog modules

Ex analog output modules

Overview



- Analog outputs for signals from the Ex field
- For the connection of intrinsically safe analog equipment from the Ex field
- 4 analog outputs in 4 channel modules (single-channel isolation)
- Diagnostics and diagnostics alarm programmable

Technical specifications

Article number	6ES7332-5RD00-0AB0 SIMATIC S7, SM 332 ANALOG OUTPUT
Supply voltage	
Load voltage L+	
• Rated value (DC)	24 V
Input current	
from load voltage L+ (without load), max.	200 mA
from backplane bus 5 V DC, max.	80 mA
Power loss	
Power loss, typ.	4 W
Analog outputs	
Number of analog outputs	4
Voltage output, short-circuit protection	Yes
Voltage output, short-circuit current, max.	70 mA
Current output, no-load voltage, max.	14 V
Output ranges, current	
• 0 to 20 mA	Yes
• 4 mA to 20 mA	Yes
Connection of actuators	
• for current output two-wire connection	Yes
Load impedance (in rated range of output)	
• with current outputs, max.	500 Ω
Cable length	
• shielded, max.	200 m

Article number	6ES7332-5RD00-0AB0 SIMATIC S7, SM 332 ANALOG OUTPUT
Analog value generation for the outputs	
Integration and conversion time/ resolution per channel	
• Resolution with overrange (bit including sign), max.	15 bit
• Basic conversion time (ms)	2.5 ms
Errors/accuracies	
Operational error limit in overall temperature range	
• Current, relative to output range, (+/-)	0.55 %
Basic error limit (operational limit at 25 °C)	
• Current, relative to output range, (+/-)	0.2 %
Interrupts/diagnostics/ status information	
Diagnostic messages	
• Diagnostic information readable	Yes
• Overrange	Yes
• Wire-break in actuator cable	Yes
Ex(i) characteristics	
Maximum values of output circuits (per channel)	
• Co (permissible external capacity), max.	850 nF
• Io (short-circuit current), max.	70 mA
• Lo (permissible external inductivity), max.	6.6 mH
• Po (power of load), max.	440 mW
• Uo (output no-load voltage), max.	14 V

Technical specifications (continued)

Article number	6ES7332-5RD00-0AB0 SIMATIC S7, SM 332 ANALOG OUTPUT
Potential separation	
Potential separation analog outputs	
• Potential separation analog outputs	Yes
Permissible potential difference	
between the outputs (UCM)	60 V DC/30 V AC when used in the hazardous area; 400 V DC/250 V AC when used in NON-hazardous area
Between the outputs and MANA (UCM)	60 V DC/30 V AC when used in the hazardous area; 400 V DC/250 V AC when used in NON-hazardous area

Article number	6ES7332-5RD00-0AB0 SIMATIC S7, SM 332 ANALOG OUTPUT
Standards, approvals, certificates	
Use in hazardous areas	
• Type of protection acc. to EN 50020 (CENELEC)	[EEx ib] IIC
• Type of protection acc. to FM	Class I, Division 2, Group A, B, C, D T4
• Test number PTB	Ex-96.D.2026X
Ambient conditions	
Ambient temperature during operation	
• max.	60 °C
Connection method	
required front connector	20-pin
Weights	
Weight, approx.	280 g

Ordering data

	Article No.
Ex analog output module	
4 outputs, isolated, 0/4 to 20 mA	6ES7332-5RD00-0AB0
Front connector	
20-pin, with screw contacts	
• 1 unit	6ES7392-1AJ00-0AA0
• 100 units	6ES7392-1AJ00-1AB0
Front door, elevated design	
e.g. for 32 channel modules; enables connection of 1.3 mm ² /16 AWG wires	6ES7328-0AA00-7AA0
LK 393 cable guide	
Mandatory for operation in hazardous areas	6ES7393-4AA00-0AA0
Labeling strips	
10 units (spare part), for modules with 20-pin front connector	6ES7392-2XX00-0AA0
Label cover	
10 units (spare part), for modules with 20-pin front connector	6ES7392-2XY00-0AA0

Article No.

Labeling sheets for machine inscription	
for modules with 20-pin front connector, DIN A4, for printing with laser printer; 10 units	
Petrol	6ES7392-2AX00-0AA0
Light beige	6ES7392-2BX00-0AA0
Yellow	6ES7392-2CX00-0AA0
Red	6ES7392-2DX00-0AA0
SIMATIC Manual Collection	6ES7998-8XC01-8YE0
Electronic manuals on DVD, multilingual: LOGO!, SIMADYN, SIMATIC bus components, SIMATIC C7, SIMATIC distributed I/O, SIMATIC HMI, SIMATIC Sensors, SIMATIC NET, SIMATIC PC Based Automation, SIMATIC PCS 7, SIMATIC PG/PC, SIMATIC S7, SIMATIC Software, SIMATIC TDC	
SIMATIC Manual Collection update service for 1 year	6ES7998-8XC01-8YE2
Current "Manual Collection" DVD and the three subsequent updates	

SIMATIC S7-300 Advanced Controllers

I/O modules

SIPLUS S7-300 Ex analog modules

SIPLUS S7-300 Ex analog input modules**Overview**

- Analog inputs for signals from the Ex field
- For the connection of intrinsically safe analog equipment from the Ex field
- 4 analog inputs in 4 channel groups (single-channel isolation)
- Measurement type and range can be selected for each channel
- Programmable diagnostics and diagnostic interrupt
- Programmable threshold alarm
- HART-compatible inputs (6AG1 331-7RD00-2AB0 only)

Note:

SIPLUS extreme products are based on SIMATIC standard products. The contents listed here were taken from the respective standard products. SIPLUS extreme specific information was added.

Technical specifications

Article number	6AG1331-7RD00-2AB0	6AG1331-7SF00-4AB0
Based on	6ES7331-7RD00-0AB0 SIPLUS S7-300 SM331 4AE	6ES7331-7SF00-0AB0 SIPLUS S7-300 SM331 20pol
Ambient conditions		
Ambient temperature during operation		
• min.	-25 °C; = Tmin	0 °C; = Tmin
• max.	60 °C; = Tmax; 60 °C @ UL/cUL, ATEX and FM use, 70 °C only 4 wire	60 °C; = Tmax
Ambient temperature during storage/transportation		
• min.	-40 °C	-40 °C
• max.	70 °C	70 °C
Extended ambient conditions		
• relative to ambient temperature-atmospheric pressure-installation altitude		Tmin ... Tmax at 1080 hPa ... 795 hPa (-1000 m ... +2000 m) // Tmin ... (Tmax - 10K) at 795 hPa ... 658 hPa (+2000 m ... +3500 m) // Tmin ... (Tmax - 20K) at 658 hPa ... 540 hPa (+3500 m ... +5000 m)
Relative humidity		
- With condensation, tested in accordance with IEC 60068-2-38, max.	100 %; RH incl. condensation/frost (no commissioning under condensation conditions)	100 %; RH incl. condensation/frost (no commissioning under condensation conditions)
Resistance		
- against biologically active substances / conformity with EN 60721-3-3	Yes; Class 3B2 mold, fungus and dry rot spores (with the exception of fauna). The supplied connector covers must remain on the unused interfaces during operation!	Yes; Class 3B2 mold, fungus and dry rot spores (with the exception of fauna). The supplied connector covers must remain on the unused interfaces during operation!
- against chemically active substances / conformity with EN 60721-3-3	Yes; Class 3C4 (RH < 75%) incl. salt spray according to EN 60068-2-52 (degree of severity 3). The supplied connector covers must remain on the unused interfaces during operation!	Yes; Class 3C4 (RH < 75%) incl. salt spray according to EN 60068-2-52 (degree of severity 3). The supplied connector covers must remain on the unused interfaces during operation!
- against mechanically active substances / conformity with EN 60721-3-3	Yes; Class 3S4 incl. sand, dust. The supplied connector covers must remain on the unused interfaces during operation!	Yes; Class 3S4 incl. sand, dust. The supplied connector covers must remain on the unused interfaces during operation!

Ordering data	Article No.	Ordering data	Article No.
SIPLUS S7-300 Ex analog input modules <u>Extended temperature range and exposure to media</u> 4 inputs, isolated, 0/4 to 20 mA, 15 bit <u>Exposure to media</u> 8/4 inputs, isolated, for thermocouples and Pt100, Pt200, Ni100; medial exposure only	6AG1331-7RD00-2AB0 6AG1331-7SF00-4AB0	Label cover 10 units (spare part), for modules with 20-pin front connector	6ES7392-2XY00-0AA0
Accessories <i>Mandatory</i> Front connector 20-pin, with spring-loaded contacts <ul style="list-style-type: none"> • 1 unit • 100 units 	6ES7392-1BJ00-0AA0 6ES7392-1BJ00-1AB0	Labeling sheets for machine inscription For modules with 20-pin front connector, DIN A4, for printing with laser printer; 10 units Petrol Light beige Yellow Red	6ES7392-2AX00-0AA0 6ES7392-2BX00-0AA0 6ES7392-2CX00-0AA0 6ES7392-2DX00-0AA0
<i>Consumables</i> DIN rail for active bus modules For max. 5 active bus modules for hot swapping function <ul style="list-style-type: none"> • Length 483 mm (19") • Length 530 mm • Length 620 mm • Length 2000 mm 	6ES7195-1GA00-0XA0 6ES7195-1GF30-0XA0 6ES7195-1GG30-0XA0 6ES7195-1GC00-0XA0	<i>Documentation</i> SIMATIC Manual Collection Electronic manuals on DVD, multi-language: LOGO!, SIMADYN, SIMATIC bus components, SIMATIC C7, SIMATIC distributed I/O, SIMATIC HMI, SIMATIC Sensors, SIMATIC NET, SIMATIC PC Based Automation, SIMATIC PCS 7, SIMATIC PG/PC, SIMATIC S7, SIMATIC Software, SIMATIC TDC	6ES7998-8XC01-8YE0
Front door, elevated design E.g. for 32-channel modules; for connecting 1.3 mm ² /16 AWG conductors; circuit diagram and nameplates in petrol	6ES7328-0AA00-7AA0	SIMATIC Manual Collection update service for 1 year Current "Manual Collection" DVD and the three subsequent updates	6ES7998-8XC01-8YE2
LK 393 cable guide Mandatory for operation in hazardous areas	6ES7393-4AA00-0AA0		
Labeling strips 10 units (spare part), for modules with 20-pin front connector	6ES7392-2XX00-0AA0		

SIMATIC S7-300 Advanced Controllers

I/O modules

Function modules

FM 350-1 counter module

Overview



- One-channel intelligent counter module for simple counting tasks
- For direct connection of incremental encoders
- Comparison function with 2 specifiable comparison values
- Integrated digital outputs to output the response upon reaching the comparison value.
- Operating modes:
 - Continuous counting
 - Single counting
 - Periodic counting
- Special functions:
 - Set counter
 - Latch counter
- Start/stop counter with gate function

Note:

Incremental encoders and pre-assembled connecting cables for counting and positioning functions are offered under SIMODRIVE Sensor or Motion Connect 500.

<http://www.siemens.com/simatic-technology>

Technical specifications

Article number	6ES7350-1AH03-0AE0 SIMATIC S7-300, COUNTER MODULE
Supply voltage	
Auxiliary voltage 1L+, load voltage 2L+	
• Rated value (DC)	24 V
non-periodic skip	
- Duration	500 ms
- Recovery time	50 s
- Value	35 V
Input current	
from load voltage 1L+ (without load), max.	40 mA
from backplane bus 5 V DC, max.	160 mA
5 V encoder supply	
• 5 V	Yes; 5.2 V +/-2%
• Output current, max.	300 mA
24 V encoder supply	
• 24 V	Yes; 1L+ (-3 V)
• Output current, max.	400 mA

Article number	6ES7350-1AH03-0AE0 SIMATIC S7-300, COUNTER MODULE
Power loss	
Power loss, typ.	4.5 W
Digital inputs	
Number of digital inputs	3
Functions	1 for gate start, 1 for gate stop, 1 for setting the counter
Input voltage	
• for signal "0"	-28.8 ... +5V
• for signal "1"	+11 to +28.8V
Input current	
• for signal "1", typ.	9 mA
Digital outputs	
Number of digital outputs	2
Short-circuit protection	Yes; Clocked electronically
Limitation of inductive shutdown voltage to	2L+ (-39 V)
Output voltage	
• for signal "0", max.	3 V
• for signal "1", min.	2L+ (-1.5 V)
Output current	
• for signal "1" rated value	0.5 A
• for signal "1" permissible range for 0 to 60 °C, min.	5 mA
• for signal "1" permissible range for 0 to 60 °C, max.	0.6 A
Output delay with resistive load	
• "0" to "1", max.	300 µs

Technical specifications (continued)

Article number	6ES7350-1AH03-0AE0 SIMATIC S7-300, COUNTER MODULE
Encoder	
Connectable encoders	
• Incremental encoder (symmetrical)	Yes; With 2 pulse trains offset by 90°
• Incremental encoder (asymmetrical)	Yes
• 24 V initiator	Yes
• 24 V directional element	Yes; 1 pulse train, 1 direction level
Counter	
Number of counter inputs	1
Counting range, description	32 bit or ± 31 bit
Minimum pulse width, adjustable	Yes; 2.5 or 25 μ s
Counter input 5 V	
• Type	RS 422
• Terminating resistor	220 Ω
• Differential input voltage	1,3 V
• Counting frequency, max.	500 kHz
Counter input 24 V	
• Input voltage for signal "0"	-28.8 ... +5V
• Input voltage for signal "1"	+11 to +28.8V
• Input current for signal "1", typ.	9 mA
• Counting frequency, max.	200 kHz
• Minimum pulse width	2.5 μ s

Article number	6ES7350-1AH03-0AE0 SIMATIC S7-300, COUNTER MODULE
Potential separation	
Potential separation digital inputs	
• between the channels and backplane bus	Yes; Optocoupler
Potential separation digital outputs	
• between the channels and backplane bus	Yes; Optocoupler
Potential separation counter	
• between the channels and backplane bus	Yes; Optocoupler
Isolation	
Isolation tested with	500 V
Connection method	
required front connector	1x 20-pin
Dimensions	
Width	40 mm
Height	125 mm
Depth	120 mm
Weights	
Weight, approx.	250 g

SIMATIC S7-300 Advanced Controllers

I/O modules

Function modules

FM 350-1 counter module**Ordering data****Article No.**

FM 350-1 counter module with 1 channel, max. 500 kHz; for incremental encoder	6ES7350-1AH03-0AE0
Coding plug - range card for analog inputs Spare part	6ES7974-0AA00-0AA0
Front connector 20-pin, with screw contacts • 1 unit • 100 units 20-pin, with spring-loaded contacts • 1 unit • 100 units	6ES7392-1AJ00-0AA0 6ES7392-1AJ00-1AB0 6ES7392-1BJ00-0AA0 6ES7392-1BJ00-1AB0
Bus connectors 1 unit (spare part)	6ES7390-0AA00-0AA0
Labeling strips 10 units (spare part)	6ES7392-2XX00-0AA0
Labeling sheets for machine inscription	See under "Accessories", page 5/264
Slot number label Spare part	6ES7912-0AA00-0AA0
Shield connection element 80 mm wide, with 2 rows for 4 terminals each	6ES7390-5AA00-0AA0
Shield connection clamps 2 units For 2 cables with 2 mm to 6 mm diameter For 1 cable with 3 mm to 8 mm diameter For 1 cable with 4 mm to 13 mm diameter	6ES7390-5AB00-0AA0 6ES7390-5BA00-0AA0 6ES7390-5CA00-0AA0
Connectable incremental encoders 6FX2 001-2...	Refer to the Industry Mail under SIMODRIVE Sensor or Motion Connect 500 (see also http://www.siemens.com/ simatic-technology)

Article No.

Signal cable Pre-assembled for HTL and TTL encoder, without sub D connector, UL/DESINA Length code: 0 m 100 m 200 m 0 m 10 m 20 m 30 m 40 m 50 m 60 m 70 m 80 m 90 m 0 m 1 m 2 m 3 m 4 m 5 m 6 m 7 m 8 m 9 m	6FX5002-2CA12- ■ ■ ■ 0 1 2 3 A B C D E F G H J K A B C D E F G H J K
--	--

Overview



- 8-channel intelligent counter module for universal counting and measuring
- To directly connect 24 V incremental encoders, direction sensors, initiators or NAMUR encoders.
- Check function with preselectable set points (number depends on mode)
- Integrated digital outputs to output the response when the setpoint is reached
- Modes:
 - Continuous/single/periodic counting
 - Frequency/speed measurement
 - Cycle duration measurement
 - Dosing

Note:

Incremental encoder and prefabricated connecting cables for counter and positioning function are offered under SIMODRIVE Sensor and Motion Connect 500.

<http://www.siemens.com/simatic-technology>

Technical specifications

Article number	6ES7350-2AH01-0AE0 FM350-2, COUNTER MOD., 8 CHANNELS, 20KHZ
Supply voltage	
Auxiliary voltage 1L+, load voltage 2L+	
• Rated value (DC)	24 V
Input current	
from load voltage L+ (without load), max.	150 mA
from backplane bus 5 V DC, max.	100 mA
Encoder supply	
Type of output voltage	NAMUR-encoder supply: 8.2 V +/-2%
Short-circuit protection	Yes
Output current	
• Rated value	200 mA
Power loss	
Power loss, typ.	10 W
Digital inputs	
Number of digital inputs	8
Number of NAMUR inputs	8
Functions	1 each for gate start/ gate stop
Input voltage	
• for signal "0"	-3 to +5V
• for signal "1"	11 to 30.2 V
Input current	
• for signal "0", max. (permissible quiescent current)	2 mA
• for signal "1", typ.	9 mA
Input delay (for rated value of input voltage) for standard inputs	
- at "0" to "1", max.	50 µs

Article number	6ES7350-2AH01-0AE0 FM350-2, COUNTER MOD., 8 CHANNELS, 20KHZ
Cable length	
• shielded, max.	100 m
Digital outputs	
Number of digital outputs	8
Short-circuit protection	Yes
Limitation of inductive shutdown voltage to	L+ (-40 V)
Output voltage	
• for signal "1", min.	L+ (-0.8 V)
Output current	
• for signal "1" rated value	0.5 A
• for signal "0" residual current, max.	0.5 mA
Output delay with resistive load	
• "0" to "1", max.	300 µs
Switching frequency	
• with resistive load, max.	500 Hz
• with inductive load, max.	0.5 Hz
Total current of the outputs (per group)	
horizontal installation	
- up to 40 °C, max.	4 A
- up to 60 °C, max.	2 A
all other mounting positions	
- up to 40 °C, max.	2 A
Cable length	
• shielded, max.	600 m
• unshielded, max.	100 m
Encoder	
Connectable encoders	
• Incremental encoder (asymmetrical)	Yes
• 24 V initiator	Yes
• 24 V directional element	Yes
• NAMUR encoder	Yes
• 2-wire sensor	Yes

SIMATIC S7-300 Advanced Controllers

I/O modules

Function modules

FM 350-2 counter module

Technical specifications (continued)

Article number	6ES7350-2AH01-0AE0 FM350-2, COUNTER MOD., 8 CHANNELS, 20KHZ
NAMUR encoder	
• Input signal	to DIN 19 234
• Input current for signal "0", max.	1.2 mA
• Input current for signal "1", min.	2.1 mA
• Input delay, max.	50 µs
• Input frequency, max.	20 kHz
• Cable length, shielded, max.	100 m
Interrupts/diagnostics/ status information	
Diagnostic functions	Yes; Diagnostic information readable
Alarms	
• Diagnostic alarm	Yes; Parameterizable
• Hardware interrupt	Yes; Parameterizable
Counter input 24 V	
• Number	8; 32 bit or ±31 bit
• Input voltage for signal "0"	-3 to +5V
• Input voltage for signal "1"	11 to 30.2 V
• Input current for signal "0", max. (permissible quiescent current)	2 mA
• Input current for signal "1", typ.	9 mA
• Input delay, max.	50 µs
• Counting frequency, max.	20 kHz; Incremental encoder: 10 kHz
• Cable length, max.	100 m

Article number	6ES7350-2AH01-0AE0 FM350-2, COUNTER MOD., 8 CHANNELS, 20KHZ
Potential separation	
Potential separation digital inputs	
• between the channels and backplane bus	Yes; and shielding
Potential separation digital outputs	
• between the channels and backplane bus	Yes; and shielding
Potential separation counter	
• between the channels and backplane bus	Yes; and shielding
Connection method	
required front connector	1x 40-pin
Dimensions	
Width	80 mm
Height	125 mm
Depth	120 mm
Weights	
Weight, approx.	460 g

Ordering data

	Article No.
FM 350-2 counter module	6ES7350-2AH01-0AE0
With 8 channels, max. 20 kHz; for 24 V incremental encoders and NAMUR encoders; incl. configuration package and electronic documentation on CD	
Front connector	
40-pin, with screw contacts	
• 1 unit	6ES7392-1AM00-0AA0
• 100 units	6ES7392-1AM00-1AB0
40-pin, with spring-loaded contacts	
• 1 unit	6ES7392-1BM01-0AA0
• 100 units	6ES7392-1BM01-1AB0
Bus connectors	6ES7390-0AA00-0AA0
1 unit (spare part)	
Labeling strips	6ES7392-2XX10-0AA0
10 units (spare part)	
Labeling sheets for machine inscription	See under "Accessories", page 5/248
Slot number label	6ES7912-0AA00-0AA0
Spare part	

	Article No.
Shield connection element	6ES7390-5AA00-0AA0
80 mm wide, with 2 rows for 4 terminals each	
Shield connection clamps	
2 units	
For 2 cables with 2 mm to 6 mm diameter	6ES7390-5AB00-0AA0
For 1 cable with 3 mm to 8 mm diameter	6ES7390-5BA00-0AA0
For 1 cable with 4 mm to 13 mm diameter	6ES7390-5CA00-0AA0
Signal cable	
Pre-assembled for HTL and TTL encoder, without sub D connector, UL/DESINA	6FX5002-2CA12- ■ ■ ■ 0
Length code:	See FM 350-1, page 5/138

Overview



- Two-channel positioning module for rapid-traverse/creep-speed drives
- 4 digital outputs per channel for motor control
- Incremental or synchro-serial position decoding

Note:

SIMODRIVE Sensor/Motion Connect 500 feature position-measuring systems and pre-assembled connecting cables for counting and positioning functions.

<http://www.siemens.com/simatic-technology>

Technical specifications

Article number	6ES7351-1AH02-0AE0 FM351 POSITIONING MOD. RAPID/CREEP FEED
Supply voltage	
Rated value (DC)	
• 24 V DC	Yes
Load voltage L+	
• Rated value (DC)	24 V
Input current	
Current consumption, max.	350 mA
from backplane bus 5 V DC, max.	150 mA
Encoder supply	
5 V encoder supply	
• 5 V	Yes
• Output current, max.	350 mA
• Cable length, max.	32 m
24 V encoder supply	
• 24 V	Yes
• Output current, max.	400 mA; Per channel
• Cable length, max.	100 m
Power loss	
Power loss, typ.	7.9 W

Article number	6ES7351-1AH02-0AE0 FM351 POSITIONING MOD. RAPID/CREEP FEED
Digital inputs	
Number of digital inputs	8
Functions	Reference cams, reversing cams, flying actual value setting, start/stop positioning
Input voltage	
• Rated value (DC)	24 V
• for signal "0"	-3 to +5V
• for signal "1"	+11 to +30V
Input current	
• for signal "0", max. (permissible quiescent current)	2 mA
• for signal "1", typ.	6 mA
Digital outputs	
Number of digital outputs	8
Functions	Rapid traverse, creep, run right, run left
Short-circuit protection	Yes
Output voltage	
• Rated value (DC)	24 V
• for signal "1", min.	UP - 0.8 V
Output current	
• for signal "1" permissible range for 0 to 60 °C, min.	5 mA; with UPmax
• for signal "1" permissible range for 0 to 60 °C, max.	600 mA; with UPmax
• for signal "0" residual current, max.	0.5 mA

SIMATIC S7-300 Advanced Controllers

I/O modules

Function modules

FM 351 positioning module**Technical specifications (continued)**

Article number	6ES7351-1AH02-0AE0 FM351 POSITIONING MOD. RAPID/CREEP FEED
Encoder	
Connectable encoders	
• Incremental encoder (symmetrical)	Yes
• Incremental encoder (asymmetrical)	Yes
• Absolute encoder (SSI)	Yes
• 2-wire sensor	Yes
- permissible quiescent current (2-wire sensor), max.	2 mA; on signal "0", max. 2 mA; on signal "1", max. 6 mA
Encoder signals, incremental encoder (symmetrical)	
• Trace mark signals	A, notA, B, notB
• Zero mark signal	N, notN
• Input signal	5 V difference signal (phys. RS 422)
• Input frequency, max.	0.5 MHz
Encoder signals, incremental encoder (asymmetrical)	
• Trace mark signals	A, B
• Zero mark signal	N
• Input voltage	24 V
• Input frequency, max.	50 kHz; 50 kHz for 25 m cable length; 25 kHz for 100 m cable length

Article number	6ES7351-1AH02-0AE0 FM351 POSITIONING MOD. RAPID/CREEP FEED
Encoder signals, absolute encoder (SSI)	
• Input signal	5 V difference signal (phys. RS 422)
• Data signal	DATA, notDATA
• Clock signal	CL, notCL
• Telegram length, parameterizable	13 or 25 bit
• Clock frequency, max.	1.5 MHz
• Gray code	Yes
• Cable length, shielded, max.	200 m; At max. 188 kHz
Potential separation	
Potential separation digital inputs	
• Potential separation digital inputs	Yes
Potential separation digital outputs	
• Potential separation digital outputs	Yes
Connection method	
required front connector	1x 20-pin
Dimensions	
Width	80 mm
Height	125 mm
Depth	120 mm
Weights	
Weight, approx.	550 g

Ordering data	Article No.	Article No.
FM 351 positioning module for rapid traverse and creep speed drives	6ES7351-1AH02-0AE0	
Front connector 20-pin, with screw contacts • 1 unit • 100 units	6ES7392-1AJ00-0AA0 6ES7392-1AJ00-1AB0	
20-pin, with spring-loaded contacts • 1 unit • 100 units	6ES7392-1BJ00-0AA0 6ES7392-1BJ00-1AB0	
Bus connectors 1 unit (spare part)	6ES7390-0AA00-0AA0	
Labeling strips 10 units (spare part)	6ES7392-2XX00-0AA0	
Slot number label Labeling sheets for machine inscription Spare part	6ES7912-0AA00-0AA0 See under "Accessories", page 5/264	
Shield connection element 80 mm wide, with 2 rows for 4 terminals each	6ES7390-5AA00-0AA0	
Shield connection clamps 2 units For 2 cables with 2 mm to 6 mm diameter For 1 cable with 3 mm to 8 mm diameter For 1 cable with 4 mm to 13 mm diameter	6ES7390-5AB00-0AA0 6ES7390-5BA00-0AA0 6ES7390-5CA00-0AA0	
		Signal cables
		Pre-assembled for SSI absolute encoder, UL/DESINA
		Pre-assembled for TTL encoder 6FX2001-1, UL/DESINA
		Pre-assembled for TTL encoder 24 V, UL/DESINA
		Not crimped
		Module end crimped, connector case supplied
		Motor end crimped, connector case supplied
		0 m
		100 m
		200 m
		0 m
		10 m
		20 m
		30 m
		40 m
		50 m
		60 m
		70 m
		80 m
		90 m
		0 m
		1 m
		2 m
		3 m
		4 m
		5 m
		6 m
		7 m
		8 m
		9 m
		0.0 m
		0.1 m
		0.2 m
		0.3 m
		0.4 m
		0.5 m
		0.6 m
		0.7 m
		0.8 m
		0
		1
		2
		3
		4
		5
		6
		7
		8
		A
		B
		C
		D
		E
		F
		G
		H
		J
		K

SIMATIC S7-300 Advanced Controllers

I/O modules

Function modules

FM 352 cam controller

Overview



- Extremely high-speed electronic cam controller
- Low-cost alternative to mechanical cam controllers
- 32 cam tracks, 13 onboard digital outputs for direct output of actions
- Incremental or synchro-serial position decoding

Note:

SIMODRIVE Sensor/Motion Connect 500 feature position-measuring systems and pre-assembled connecting cables for counting and positioning functions.

<http://www.siemens.com/simatic-technology>

Technical specifications

Article number	6ES7352-1AH02-0AE0 FM352 ELECTRON. CAM CONTROLLER
Supply voltage	
Rated value (DC)	
• 24 V DC	Yes
Input current	
from load voltage L+ (without load), max.	200 mA
from backplane bus 5 V DC, max.	100 mA
Encoder supply	
5 V encoder supply	
• 5 V	Yes
• Output current, max.	300 mA
• Cable length, max.	32 m
24 V encoder supply	
• 24 V	Yes
• Output current, max.	300 mA
• Cable length, max.	100 m
Power loss	
Power loss, typ.	8.1 W
Digital inputs	
Number of digital inputs	4
Functions	Reference point switch, set floating actual value/length measurement, brake release, enable track output no. 3
Input voltage	
• Rated value (DC)	24 V
• for signal "0"	-30 to +5V
• for signal "1"	+11 to +30V
Input current	
• for signal "0", max. (permissible quiescent current)	2 mA
• for signal "1", typ.	9 mA
Digital outputs	
Number of digital outputs	13
Functions	Cam track
Short-circuit protection	Yes
Output voltage	
• Rated value (DC)	24 V
• for signal "1", min.	UP - 0.8 V

Article number	6ES7352-1AH02-0AE0 FM352 ELECTRON. CAM CONTROLLER
Output current	
• for signal "1" permissible range for 0 to 60 °C, min.	5 mA; with UPmax
• for signal "1" permissible range for 0 to 60 °C, max.	600 mA; with UPmax
• for signal "0" residual current, max.	0.5 mA
Encoder	
Connectable encoders	
• Incremental encoder (symmetrical)	Yes
• Incremental encoder (asymmetrical)	Yes
• Absolute encoder (SSI)	Yes
• 2-wire sensor	Yes
- permissible quiescent current (2-wire sensor), max.	2 mA
Encoder signals, incremental encoder (symmetrical)	
• Trace mark signals	A, notA, B, notB
• Zero mark signal	N, notN
• Input signal	5 V difference signal (phys. RS 422)
• Input frequency, max.	1 MHz
Encoder signals, incremental encoder (asymmetrical)	
• Trace mark signals	A, B
• Zero mark signal	N
• Input voltage	24 V
• Input frequency, max.	50 kHz; 50 kHz for 25 m cable length; 25 kHz for 100 m cable length
Encoder signals, absolute encoder (SSI)	
• Data signal	DATA, notDATA
• Clock signal	CL, notCL
• Telegram length, parameterizable	13 or 25 bit
• Clock frequency, max.	1 MHz
• Gray code	1
• Cable length, shielded, max.	320 m; at max. 125 kHz
Potential separation	
Potential separation digital inputs	
• Potential separation digital inputs	No
Potential separation digital outputs	
• Potential separation digital outputs	No

Technical specifications (continued)

Article number	6ES7352-1AH02-0AE0 FM352 ELECTRON. CAM CONTROLLER
Connection method	
required front connector	1x 20-pin
Dimensions	
Width	80 mm
Height	125 mm
Depth	120 mm

Article number	6ES7352-1AH02-0AE0 FM352 ELECTRON. CAM CONTROLLER
Weights	
Weight, approx.	550 g

Ordering data

Ordering data	Article No.
FM352 electronic cam controller	6ES7352-1AH02-0AE0
Front connectors	
20-pin, with screw contacts	
• 1 unit	6ES7392-1AJ00-0AA0
• 100 units	6ES7392-1AJ00-1AB0
20-pin, with spring-loaded contacts	
• 1 unit	6ES7392-1BJ00-0AA0
• 100 units	6ES7392-1BJ00-1AB0
Bus connectors	6ES7390-0AA00-0AA0
1 unit (spare part)	
Labeling strips	6ES7392-2XX00-0AA0
10 units (spare part)	
Labeling sheets for machine inscription	See under "Accessories", page 5/264
Slot number label	6ES7912-0AA00-0AA0
Spare part	
Shield connection element	6ES7390-5AA00-0AA0
80 mm wide, with 2 rows for 4 terminals each	
Shield connection clamps	
2 units	
For 2 cables with 2 mm to 6 mm diameter	6ES7390-5AB00-0AA0
For 1 cable with 3 mm to 8 mm diameter	6ES7390-5BA00-0AA0
For 1 cable with 4 mm to 13 mm diameter	6ES7390-5CA00-0AA0

Signal cable	Article No.
Pre-assembled for SSI absolute encoder, UL/DESINA	6FX50 2-2CC11-
Pre-assembled for TTL encoder 6FX2001-1, UL/DESINA	6FX50 2-2CD01-
Pre-assembled for TTL encoder 24 V, UL/DESINA	6FX50 2-2CD24-
Not crimped	0
Module end crimped, connector case supplied	1
Motor end crimped, connector case supplied	4
0 m	1
100 m	2
200 m	3
0 m	A
10 m	B
20 m	C
30 m	D
40 m	E
50 m	F
60 m	G
70 m	H
80 m	J
90 m	K
0 m	A
1 m	B
2 m	C
3 m	D
4 m	E
5 m	F
6 m	G
7 m	H
8 m	J
9 m	K
0.0 m	0
0.1 m	1
0.2 m	2
0.3 m	3
0.4 m	4
0.5 m	5
0.6 m	6
0.7 m	7
0.8 m	8

SIMATIC S7-300 Advanced Controllers

I/O modules

Function modules

FM 352-5 high-speed Boolean processor

Overview



- The FM 352-5 high-speed Boolean processor provides extremely fast binary control and also some of the fastest switching processes ever possible (cycle time: 1 μ s).
- Programming is possible with LAD or FBD.
- The available set of statements comprises bit statements (partial statement set of STEP 7), timers, counters, frequency dividers, frequency generators, shift registers.
- 12 integral DI / 8 integral DO.
- 2 versions: Current sinking or current sourcing digital outputs.
- 1 channel for connection of a 24-V incremental encoder, a 5-V incremental encoder (RS 422) or an SSI absolute encoder.

Micro Memory Card required for use of the FM 352-5

Note:

Displacement measuring systems and pre-cut/pre-assembled cables for counting and positioning functions are available under SIMODRIVE Sensor or Motion Connect 500.

<http://www.siemens.com/simatic-technology>

Technical specifications

Article number	6ES7352-5AH01-0AE0 FM 352-5, BOOLEAN PROCESSOR 12DE/8DA	6ES7352-5AH11-0AE0 FM 352-5 PNP, BOOLEAN PROCESSOR 12DI/8DO
Supply voltage		
Rated value (DC)		
• 24 V DC	Yes	Yes
Load voltage L+		
• Rated value (DC)	24 V	24 V
• Reverse polarity protection	Yes	Yes
Input current		
from load voltage 1L+, max.	150 mA; typ. 60 mA	150 mA; typ. 60 mA
from load voltage 2L+ (without load), max.	200 mA; typ. 60 mA, DI/DO supply	200 mA; typ. 60 mA, DI/DO supply
from load voltage 3L+ (with encoder), max.	600 mA; typ. 80 mA plus encoder supply	600 mA; typ. 80 mA plus encoder supply
from load voltage 3L+ (without encoder), max.	200 mA; typ. 80 mA	200 mA; typ. 80 mA
from backplane bus 5 V DC, typ.	135 mA	135 mA
Encoder supply		
5 V encoder supply		
• 5 V	Yes	Yes
• short-circuit protection	Yes; Electronic overload protection; no protection on applying a normal or counter voltage.	Yes; Electronic overload protection; no protection on applying a normal or counter voltage.
• Output current, max.	250 mA	250 mA
24 V encoder supply		
• 24 V	Yes	Yes
• Short-circuit protection	Yes; Overvoltage and overheating protection if overloaded; diagnostics if output reaches temperature limit; no protection on applying a normal or counter voltage	Yes; Overvoltage and overheating protection if overloaded; diagnostics if output reaches temperature limit; no protection on applying a normal or counter voltage
• Output current, max.	400 mA	400 mA

Technical specifications (continued)

Article number	6ES7352-5AH01-0AE0	6ES7352-5AH11-0AE0
	FM 352-5, BOOLEAN PROCESSOR 12DE/8DA	FM 352-5 PNP, BOOLEAN PROCESSOR 12DI/8DO
Power loss		
Power loss, typ.	6.5 W	6.5 W
Memory		
Type of memory	RAM	RAM
Memory size	128 kbyte; required for operation, MMC	128 kbyte; required for operation, MMC
Digital inputs		
Number of digital inputs	8; Standard and up to 12 with 24 V DC encoder inputs as digital inputs	8; Standard and up to 12 with 24 V DC encoder inputs as digital inputs
Input voltage		
• Rated value (DC)	24 V	24 V
• for signal "0"	-30 to +5V	-30 to +5V
• for signal "1"	+11 to +30V	+11 to +30V
Input current		
• for signal "0", max. (permissible quiescent current)	1.5 mA	1.5 mA
• for signal "1", typ.	3.8 mA	3.8 mA
Input delay (for rated value of input voltage)		
• Input frequency (with a time delay of 0.1 ms), max.	200 kHz	200 kHz
• programmable digital filter delay	None, 5 µs, 10 µs, 15 µs, 20 µs, 50 µs, 1.6 ms	None, 5 µs, 10 µs, 15 µs, 20 µs, 50 µs, 1.6 ms
• Minimum pulse width for program reactions	1 µs, 5 µs, 10 µs, 15 µs, 20 µs, 50 µs, 1.6 ms	1 µs, 5 µs, 10 µs, 15 µs, 20 µs, 50 µs, 1.6 ms
for standard inputs		
- at "0" to "1", max.	3 µs; typ. 1.5 µs	3 µs; typ. 1.5 µs
Cable length		
• shielded, max.	600 m	600 m
• unshielded, max.	100 m; Shielded cable recommended if filtering delay is set to less than 1.6 ms	100 m; Shielded cable recommended if filtering delay is set to less than 1.6 ms
Digital outputs		
Number of digital outputs	8	8
Current-sinking	Yes	No
Current-sourcing	No	Yes
Short-circuit protection	Yes; Overvoltage protection, thermal protection	Yes; Overvoltage protection, thermal protection
• Response threshold, typ.	1.7 to 3.5 A	1.7 to 3.5 A
Limitation of inductive shutdown voltage to	2M -45 V typ., (-40 V to -55 V); comment: no protection against inductive kickback >55 mJ	2M -45 V typ., (-40 V to -55 V); comment: no protection against inductive kickback >55 mJ
Controlling a digital input	No	Yes
Switching capacity of the outputs		
• on lamp load, max.	5 W	5 W
Output voltage		
• Rated value (DC)	24 V	24 V
• for signal "0", max.	28.8 V	28.8 V
• for signal "1", max.	0.5 V	0.5 V
Output current		
• for signal "1" rated value	0.5 A; At 60 °C	0.5 A; At 60 °C
• for signal "1" permissible range for 0 to 60 °C, min.	5 mA	5 mA
• for signal "1" permissible range for 0 to 60 °C, max.	600 mA	600 mA
• for signal "0" residual current, max.	1 mA	1 mA
Output delay with resistive load		
• "0" to "1", max.	1 µs; 0.6 µs 50 mA / 1.0 µs 0.5 A	1 µs; 0.6 µs 50 mA / 1.0 µs 0.5 A
• "1" to "0", max.	1.5 µs; 1.7 µs 50 mA / 1.5 µs 0.5 A	1.5 µs; 1.7 µs 50 mA / 1.5 µs 0.5 A

SIMATIC S7-300 Advanced Controllers

I/O modules

Function modules

FM 352-5 high-speed Boolean processor

Technical specifications (continued)

Article number	6ES7352-5AH01-0AE0 FM 352-5, BOOLEAN PROCESSOR 12DE/8DA	6ES7352-5AH11-0AE0 FM 352-5 PNP, BOOLEAN PROCESSOR 12DI/8DO
Parallel switching of two outputs		
• for uprating	Yes; 2	Yes; 2
Switching frequency		
• with resistive load, max.	100 kHz; 20 kHz at 0.5 A; 100 kHz at 0.25 A	100 kHz; 20 kHz at 0.5 A; 100 kHz at 0.25 A
• with inductive load, max.	2 Hz; 2 Hz at 0.5 A with external commutator diodes; 0.5 Hz at 0.5 A without external commutator diodes	2 Hz; 2 Hz at 0.5 A with external commutator diodes; 0.5 Hz at 0.5 A without external commutator diodes
• on lamp load, max.	10 Hz	10 Hz
Cable length		
• shielded, max.	600 m	600 m
• unshielded, max.	100 m	100 m
Encoder		
Connectable encoders		
• Incremental encoder (symmetrical)	Yes	Yes
• Incremental encoder (asymmetrical)	Yes	Yes
• Absolute encoder (SSI)	Yes	Yes
• 2-wire sensor	Yes	Yes
- permissible quiescent current (2-wire sensor), max.	1.5 mA	1.5 mA
Encoder signals, incremental encoder (symmetrical)		
• Trace mark signals	A, notA, B, notB	A, notA, B, notB
• Zero mark signal	N, notN	N, notN
• Input signal	5 V difference signal (phys. RS 422)	5 V difference signal (phys. RS 422)
• Input frequency, max.	500 kHz	500 kHz
• Cable length, shielded, max.	100 m; 100 m with 24 V supply and 500 kHz; 32 m with 5 V supply and 500 kHz	100 m; 100 m with 24 V supply and 500 kHz; 32 m with 5 V supply and 500 kHz
Encoder signals, incremental encoder (asymmetrical)		
• Trace mark signals	A, B	A, B
• Zero mark signal	N	N
• Input voltage	24 V	24 V
• Input frequency, max.	200 kHz	200 kHz
• Cable length, shielded, max.	50 m; Cable length, HTL incremental encoder, Siemens, type 6FX2001-4: 50 kHz, 25 m shielded, max., 25 kHz, 50 m shielded, max.	50 m; Cable length, HTL incremental encoder, Siemens, type 6FX2001-4: 50 kHz, 25 m shielded, max., 25 kHz, 50 m shielded, max.
Encoder signals, absolute encoder (SSI)		
• Data signal	DATA, notDATA	DATA, notDATA
• Clock signal	CK, notCK	CK, notCK
• Telegram length, parameterizable	13 or 25 bit	13 or 25 bit
• Clock frequency, max.	1 MHz; 125 kHz, 250 kHz, 500 kHz or 1 MHz	1 MHz; 125 kHz, 250 kHz, 500 kHz or 1 MHz
• Cable length, shielded, max.	320 m; At 125 kHz	320 m; At 125 kHz
• Monoflop time	settable: 16/32/48/64 µs	settable: 16/32/48/64 µs
• Listening mode	Yes; one or two stations	Yes; one or two stations
• Multiturn	Yes; 25 bit message frame	Yes; 25 bit message frame
Encoder signal evaluation		
• Counting direction, forward	Yes	Yes
• Counting direction, backward	Yes	Yes
Response times		
Input- to output response time	5 V input to 24 V output, 0 filter: 1 to 4 µs (typ.); 24 V input to 24 V output, 0 filter: 2 to 6 µs (typ.)	5 V input to 24 V output, 0 filter: 1 to 4 µs (typ.); 24 V input to 24 V output, 0 filter: 2 to 6 µs (typ.)
Interfaces		
Point-to-point		
• Updating times	PLC interface: 1.7 ms	PLC interface: 1.7 ms

Technical specifications (continued)

Article number	6ES7352-5AH01-0AE0	6ES7352-5AH11-0AE0
	FM 352-5, BOOLEAN PROCESSOR 12DE/8DA	FM 352-5 PNP, BOOLEAN PROCESSOR 12DI/8DO
Interrupts/diagnostics/ status information		
Alarms		
• Diagnostic alarm	Yes; 1L, 2L, 3L missing; MMC error; output overload (8); encoder supply overload; differential wire break; parameterization error; SSI message frame overflow	Yes; 1L, 2L, 3L missing; MMC error; output overload (8); encoder supply overload; differential wire break; parameterization error; SSI message frame overflow
• Hardware interrupt	Yes; 8 available; for generation by user program	Yes; 8 available; for generation by user program
Diagnostic messages		
• Wire-break in signal transmitter cable	Yes	Yes
• Overflow/underflow	Yes	Yes
• missing load voltage	Yes	Yes
Counter		
Counting range, description	Counting range (16-bit counters): -32,768 to 32,767 (user-specific within this range); counting range (32-bit counters): -2,147,483,648 to 2,147,483,647 (user-specific within this range)	Counting range (16-bit counters): -32,768 to 32,767 (user-specific within this range); counting range (32-bit counters): -2,147,483,648 to 2,147,483,647 (user-specific within this range)
Counting range, lower limit	-2 147 483 648	-2 147 483 648
Counting range, upper limit	2 147 483 647	2 147 483 647
Counting mode		
• Counting mode, individual	Yes	Yes
• Counting mode, continuous	Yes	Yes
• Counting mode, periodic	Yes	Yes
Potential separation		
between 1L and 2L and 3L	Yes	Yes
Potential separation digital inputs		
• Potential separation digital inputs	Yes; Yes CPU, I/O and sensor units are isolated	Yes; Yes CPU, I/O and sensor units are isolated
Configuration		
Programming		
• Program cycle time (scan)	1 µs	1 µs
Connection method		
required front connector	1x 40-pin	1x 40-pin
Dimensions		
Width	80 mm	80 mm
Height	125 mm	125 mm
Depth	120 mm	120 mm
Weights		
Weight, approx.	434 g; Module weight: approx. 434 g (with 1L connection and without I/O connection or MMC); shipping weight: approx. 500 g (with bus and 1L connection and without I/O connection or MMC)	434 g; Module weight: approx. 434 g (with 1L connection and without I/O connection or MMC); shipping weight: approx. 500 g (with bus and 1L connection and without I/O connection or MMC)

SIMATIC S7-300 Advanced Controllers

I/O modules

Function modules

FM 352-5 high-speed Boolean processor**Ordering data****Article No.****FM 352-5 high-speed Boolean processor**

with current sinking digital outputs

6ES7352-5AH01-0AE0

with current sourcing digital outputs

6ES7352-5AH11-0AE0**Micro Memory Card**

128 KB

6ES7953-8LG31-0AA0

512 KB

6ES7953-8LJ31-0AA0

2 MB

6ES7953-8LL31-0AA0**Front connector**

40-pin, with screw contacts

- 1 unit
- 100 units

6ES7392-1AM00-0AA0**6ES7392-1AM00-1AB0**

40-pin, with spring-loaded contacts

- 1 unit
- 100 units

6ES7392-1BM01-0AA0**6ES7392-1BM01-1AB0****Signal cables**

To HTL and TTL encoders, pre-assembled, without Sub-D connector

6FX5002-2CA12-

■ ■ ■ 0

To SSI absolute encoders 6FX2 001-5, pre-assembled, without Sub-D connector

6FX5002-2CC12-

■ ■ ■ ■

Length code:

0 m

1

100 m

2

200 m

3

0 m

A

10 m

B

20 m

C

30 m

D

40 m

E

50 m

F

60 m

G

70 m

H

80 m

J

90 m

K

0 m

A

1 m

B

2 m

C

3 m

D

4 m

E

5 m

F

6 m

G

7 m

H

8 m

J

9 m

K

0.0 m

0

0.1 m

1

0.2 m

2

0.3 m

3

0.4 m

4

0.5 m

5

0.6 m

6

0.7 m

7

0.8 m

8

Overview



- Positioning module for stepper motors in machines with high clock-pulse rates
- Can be used for simple point-to-point positioning and for complex traversing profiles

Technical specifications

Article number	6ES7353-1AH01-0AE0 Positioning control FM 353 (FM step)
Supply voltage	
Rated value (DC)	
• 24 V DC	Yes
permissible range, lower limit (DC)	20.4 V
permissible range, upper limit (DC)	28.8 V
Input current	
Current consumption, max.	300 mA
Power loss	
Power loss, typ.	7 W
Digital inputs	
Number of digital inputs	4; + 1 input for message signal
Functions	Reference cams, flying actual value setting, flying measurement, start/stop positioning, external block change
Input voltage	
• Rated value (DC)	24 V
• for signal "0"	-3 to +5V
• for signal "1"	+11 to +30V
Input current	
• for signal "0", max. (permissible quiescent current)	2 mA
• for signal "1", typ.	6 mA; 6 to 15 mA
Digital outputs	
Number of digital outputs	4
Functions	Position reached: stop, axis travels forward, axis travels back, change M-function M97, change M-function M98, start enable, direct output via data record
Short-circuit protection	Yes

Article number	6ES7353-1AH01-0AE0 Positioning control FM 353 (FM step)
Output voltage	
• Rated value (DC)	24 V
• for signal "1", min.	UP -3 V
Output current	
• for signal "1" permissible range for 0 to 55 °C, max.	0.6 A; with UPmax
• for signal "0" residual current, max.	2 mA
Drive interface	
Signal Input	
• Function	"Power section ready"
Stepper drive	
• Differential output voltage, min.	2 V; RL = 100 Ohm
• Differential output voltage for signal "0", max.	1 V; I _o = 20 mA
• Differential output voltage for signal "1", min.	3.7 V; I _o = -20 mA
• Cable length, shielded, max.	35 m
Potential separation	
Potential separation digital inputs	
• Potential separation digital inputs	No
Potential separation digital outputs	
• Potential separation digital outputs	No
Connection method	
required front connector	1x 20-pin
Dimensions	
Width	80 mm
Height	125 mm
Depth	118 mm
Weights	
Weight, approx.	500 g

SIMATIC S7-300 Advanced Controllers

I/O modules

Function modules

FM 353 positioning module**Ordering data****Article No.****FM 353 positioning module****6ES7353-1AH01-0AE0**

For stepper motors;
incl. configuration package on
CD-ROM (Ge, En, Fr, It) comprising

- FM 353 manual, electronic
- Standard function blocks
(STEP 7 interface software)
- Screen form-based configuration
software for FM 353
- Standard interactive screen forms
for OP7/OP17

FM 353 manual

German

6ES7353-1AH01-8AG0

English

6ES7353-1AH01-8BG0

French

6ES7353-1AH01-8CG0

Italian

6ES7353-1AH01-8EG0**Edit FM****6FC5263-1AA03-5AB0**

Program editor for editing, loading
and saving NC programs with the
standard programming device/PC;
German/English, on CD-ROM

Connecting cables and encodersSee catalog NC 60, CA 01
or in the Industry Mall**Front connectors**

20-pin, with screw contacts

- 1 unit
- 100 units

6ES7392-1AJ00-0AA0**6ES7392-1AJ00-1AB0**

20-pin, with spring-loaded contacts

- 1 unit
- 100 units

6ES7392-1BJ00-0AA0**6ES7392-1BJ00-1AB0****Article No.****Bus connectors****6ES7390-0AA00-0AA0**

1 unit (spare part)

Labeling strips**6ES7392-2XX00-0AA0**

10 units (spare part)

**Labeling sheets for machine
inscription**See under "Accessories",
page 5/264**Slot number label****6ES7912-0AA00-0AA0**

Spare part

Shield connection element**6ES7390-5AA00-0AA0**80 mm wide, with 2 rows
for 4 terminals each**Shield connection clamps**

2 units

For 2 cables with 2 mm to 6 mm
diameter**6ES7390-5AB00-0AA0**For 1 cable with 3 mm to 8 mm
diameter**6ES7390-5BA00-0AA0**For 1 cable with 4 mm to 13 mm
diameter**6ES7390-5CA00-0AA0**

Overview



- 4-channel closed-loop controller module for universal control tasks
- Can be used for temperature, pressure, flow and level controls
- Convenient online self-optimization for temperature controls
- Predefined controller structures
- 2 control algorithms
- 2 versions:
 - FM 355 C as continuous controller;
 - FM 355 S as step or pulse controller
- With 4 analog outputs (FM 355 C) or 8 digital outputs (FM 355 S) for direct control of the most common actuators
- Continuation of control mode also possible with CPU stop or failure

Technical specifications

Article number	6ES7355-0VH10-0AE0 SIMATIC S7-300, CONTROL MODULE	6ES7355-1VH10-0AE0 SIMATIC S7-300, CONTROL MODULE
Supply voltage		
Load voltage L+		
• Rated value (DC)	24 V	24 V
Input current		
from load voltage L+ (without load), max.	310 mA; Typ. 260 mA	270 mA; typ. 220 mA
from backplane bus 5 V DC, max.	75 mA; typ. 50 mA	75 mA; typ. 50 mA
Power loss		
Power loss, typ.	6.5 W	5.5 W
Power loss, max.	7.8 W	6.9 W
Digital inputs		
Number of digital inputs	8	8
Input characteristic curve in accordance with IEC 61131, type 2	Yes	Yes
Input voltage		
• Rated value (DC)	24 V	24 V
• for signal "0"	-3 to +5V	-3 to +5V
• for signal "1"	13 to 30V	13 to 30V
Input current		
• for signal "1", typ.	7 mA	7 mA
Cable length		
• shielded, max.	1 000 m	1 000 m
• unshielded, max.	600 m	600 m
Digital outputs		
Number of digital outputs		8
Short-circuit protection		Yes; Electronic
Limitation of inductive shutdown voltage to		L+ (-1.5 V)
Controlling a digital input		Yes
Switching capacity of the outputs		
• on lamp load, max.		5 W
Load resistance range		
• lower limit		240 Ω
• upper limit		4 kΩ

SIMATIC S7-300 Advanced Controllers

I/O modules

Function modules

FM 355 controller module**Technical specifications (continued)**

Article number	6ES7355-0VH10-0AEO SIMATIC S7-300, CONROL MODULE	6ES7355-1VH10-0AEO SIMATIC S7-300, CONTROL MODULE
Output voltage		
• for signal "1", min.		L+ (-2.5 V)
Output current		
• for signal "1" rated value		100 mA
• for signal "1" permissible range for 0 to 60 °C, min.		5 mA
• for signal "1" permissible range for 0 to 60 °C, max.		150 mA
• for signal "0" residual current, max.		0.5 mA
Parallel switching of two outputs		
• for logic links		Yes
Switching frequency		
• with resistive load, max.		100 Hz
• with inductive load, max.		0.5 Hz
• on lamp load, max.		100 Hz
Total current of the outputs (per group)		
all mounting positions		
- up to 60 °C, max.		400 mA
Cable length		
• shielded, max.		1 000 m
• unshielded, max.		600 m
Analog inputs		
Number of analog inputs	4	4
permissible input voltage for voltage input (destruction limit), max.	30 V	30 V
permissible input current for current input (destruction limit), max.	40 mA	40 mA
Input ranges (rated values), voltages		
• 0 to +10 V	Yes	Yes
• -1.75 V to +11.75 V	Yes	Yes
• -80 mV to +80 mV	Yes	Yes
Input ranges (rated values), currents		
• 0 to 20 mA	Yes	Yes
• 0 to 23.5 mA	Yes	Yes
• -3.5 mA to +23.5 mA	Yes	Yes
• 4 mA to 20 mA	Yes	Yes
Input ranges (rated values), thermocouples		
• Type B	Yes	Yes
• Type J	Yes	Yes
• Type K	Yes	Yes
• Type R	Yes	Yes
• Type S	Yes	Yes
Input ranges (rated values), resistance thermometer		
• Pt 100	Yes	Yes
Thermocouple (TC)		
Temperature compensation		
- internal temperature compensation	Yes	Yes
- external temperature compensation with Pt100	Yes	Yes
Characteristic linearization		
• parameterizable	Yes	Yes
- for thermocouples	Type B, J, K, R, S	Type B, J, K, R, S
- for resistance thermometer	Pt100 (standard)	Pt100 (standard)

Technical specifications (continued)

Article number	6ES7355-0VH10-0AEO	6ES7355-1VH10-0AEO
	SIMATIC S7-300, CONROL MODULE	SIMATIC S7-300, CONTROL MODULE
Cable length		
• shielded, max.	200 m; 50 m at 80 mV and thermocouples	200 m; 50 m at 80 mV and thermocouples
Analog outputs		
Number of analog outputs	4	
Voltage output, short-circuit protection	Yes	
Voltage output, short-circuit current, max.	25 mA	
Current output, no-load voltage, max.	18 V	
Output ranges, voltage		
• 0 to 10 V	Yes	
• -10 V to +10 V	Yes	
Output ranges, current		
• 0 to 20 mA	Yes	
• 4 mA to 20 mA	Yes	
Connection of actuators		
• for voltage output two-wire connection	Yes	
• for current output two-wire connection	Yes	
Load impedance (in rated range of output)		
• with voltage outputs, min.	1 k Ω	
• with voltage outputs, capacitive load, max.	1 μ F	
• with current outputs, max.	500 Ω	
• with current outputs, inductive load, max.	1 mH	
Cable length		
• shielded, max.	200 m; 50 m at 80 mV and thermocouples	
Analog value generation for the inputs		
Measurement principle	integrating	integrating
Integration and conversion time/resolution per channel		
• Resolution with overrange (bit including sign), max.	14 bit; 12 bit or 14 bit, parameterizable	14 bit; 12 bit or 14 bit, parameterizable
• Conversion time (per channel)	16.67 ms; for 12 bit: 16 2/3 ms for 60 Hz, 20 ms for 50 Hz; for 14 bit: 100 ms for 50 Hz and 60 Hz	16.67 ms; for 12 bit: 16 2/3 ms for 60 Hz, 20 ms for 50 Hz; for 14 bit: 100 ms for 50 Hz and 60 Hz
Analog value generation for the outputs		
Settling time		
• for resistive load	0.1 ms	
• for capacitive load	3.3 ms	
• for inductive load	0.5 ms	
Encoder		
Connection of signal encoders		
• for voltage measurement	Yes	Yes
• for current measurement as 4-wire transducer	Yes	Yes
Connectable encoders		
• 2-wire sensor	Yes	Yes
- permissible quiescent current (2-wire sensor), max.	1.5 mA	1.5 mA
Errors/accuracies		
Linearity error (relative to input range), (+/-)	0.05 %	0.05 %
Temperature error (relative to input range), (+/-)	0.005 %/K	0.005 %/K
Linearity error (relative to output range), (+/-)	0.05 %	
Temperature error (relative to output range), (+/-)	0.02 %/K	

SIMATIC S7-300 Advanced Controllers

I/O modules

Function modules

FM 355 controller module

Technical specifications (continued)

Article number	6ES7355-0VH10-0AE0 SIMATIC S7-300, CONROL MODULE	6ES7355-1VH10-0AE0 SIMATIC S7-300, CONTROL MODULE
Operational error limit in overall temperature range		
<ul style="list-style-type: none"> Voltage, relative to input range, (+/-) Current, relative to input range, (+/-) Resistance thermometer, relative to input range, (+/-) Voltage, relative to output range, (+/-) Current, relative to output range, (+/-) 	0.6 %; +/-0.6 to +/-1% 0.6 %; +/-0.6 to +/-1% 0.6 %; +/-0.6 to +/-1% 0.5 % 0.6 %	0.6 %; +/-0.6 to +/-1% 0.6 %; +/-0.6 to +/-1% 0.6 %; +/-0.6 to +/-1%
Basic error limit (operational limit at 25 °C)		
<ul style="list-style-type: none"> Voltage, relative to input range, (+/-) Current, relative to input range, (+/-) Resistance thermometer, relative to input range, (+/-) Voltage, relative to output range, (+/-) Current, relative to output range, (+/-) 	0.4 %; 80 mV: +/-0.6%; 250 to 1000 mV: +/-0.4%; 2.5 to 10 V: +/-0.6%; 3.2 to 20 mA: +/-0.5% 0.4 %; +/-0.4 to +/-0.6 % 0.4 %; +/-0.4 to +/-0.6 % 0.3 % 0.5 %	0.4 %; 80 mV: +/-0.6%; 250 to 1000 mV: +/-0.4%; 2.5 to 10 V: +/-0.6%; 3.2 to 20 mA: +/-0.5% 0.4 %; +/-0.4 to +/-0.6 % 0.4 %; +/-0.4 to +/-0.6 %
Interference voltage suppression for $f = n \times (f1 \pm 1 \%)$, $f1 =$ interference frequency		
<ul style="list-style-type: none"> Series mode interference (peak value of interference < rated value of input range), min. Common mode interference (USS < 2.5 V), min. 	40 dB 70 dB	40 dB 70 dB
Interrupts/diagnostics/status information		
Substitute values connectable	Yes; Parameterizable	Yes; Parameterizable
Integrated Functions		
Control technology		
<ul style="list-style-type: none"> Number of closed-loop controllers 	4	4
Potential separation		
Potential separation controller		
<ul style="list-style-type: none"> between the channels between the channels and backplane bus 	No Yes; Optocoupler	No Yes; Optocoupler
Permissible potential difference		
Between the inputs and MANA (UCM)	2.5 V DC	2.5 V DC
Isolation		
Isolation tested with	500 V DC	500 V DC
Connection method		
required front connector	2x 20-pin	2x 20-pin
Dimensions		
Width	80 mm	80 mm
Height	125 mm	125 mm
Depth	120 mm	120 mm
Weights		
Weight, approx.	470 g	470 g

Ordering data	Article No.		Article No.
FM 355 C controller module with 4 analog outputs for 4 continuous-action controllers	6ES7355-0VH10-0AE0	Labeling sheets for machine inscription	See under "Accessories", page 5/264
FM 355 S controller module with 8 digital outputs for 4 step or pulse controllers	6ES7355-1VH10-0AE0	Slot number label	6ES7912-0AA00-0AA0
Front connector 20-pin, with screw contacts • 1 unit • 100 units	6ES7392-1AJ00-0AA0 6ES7392-1AJ00-1AB0	Spare part	
20-pin, with spring-loaded contacts • 1 unit • 100 units	6ES7392-1BJ00-0AA0 6ES7392-1BJ00-1AB0	Shield connection element	6ES7390-5AA00-0AA0
Bus connectors 1 unit (spare part)	6ES7390-0AA00-0AA0	80 mm wide, with 2 rows for 4 terminals each	
Labeling strips 10 units (spare part)	6ES7392-2XX00-0AA0	Shield connection clamps	
		2 units	
		For 2 cables with 2 mm to 6 mm diameter	6ES7390-5AB00-0AA0
		For 1 cable with 3 mm to 8 mm diameter	6ES7390-5BA00-0AA0
		For 1 cable with 4 mm to 13 mm diameter	6ES7390-5CA00-0AA0

SIMATIC S7-300 Advanced Controllers

I/O modules

Function modules

FM 355-2 temperature controller module

Overview



- 4-channel closed-loop controller module specifically for temperature controls
- Including integrated and easy-to-use online self-optimization
- Heating and cooling controllers as well as combined controllers with heating and active cooling function feasible
- Ready-to-use controller structures
- 2 versions:
 - FM 355-2 C as a continuous controller;
 - FM 355-2 S as step or pulse controllers
- With 4 analog outputs (FM 355-2 C) or 8 digital inputs (FM 355-2 S) to directly control the most common final control elements
- Continuation of control mode also possible with CPU stop or failure

Technical specifications

Article number	6ES7355-2CH00-0AE0 TEMPERATURE CONTROL MOD. FM355-2C	6ES7355-2SH00-0AE0 SIMATIC S7-300, TEMPERATURE
Supply voltage		
Load voltage L+		
• Rated value (DC)	24 V	24 V
Input current		
from load voltage L+ (without load), max.	310 mA; Typ. 260 mA	270 mA; typ. 220 mA
from backplane bus 5 V DC, max.	75 mA; typ. 50 mA	75 mA; typ. 50 mA
Power loss		
Power loss, typ.	6.5 W	5.5 W
Power loss, max.	7.8 W	6.9 W
Digital inputs		
Number of digital inputs	8	8
Input characteristic curve in accordance with IEC 61131, type 2	Yes	Yes
Input voltage		
• Rated value (DC)	24 V	24 V
• for signal "0"	-3 to +5V	-3 to +5V
• for signal "1"	13 to 30V	13 to 30V
Input current		
• for signal "1", typ.	7 mA	7 mA
Cable length		
• shielded, max.	1 000 m	1 000 m
• unshielded, max.	600 m	600 m
Digital outputs		
Number of digital outputs		8
Short-circuit protection		Yes; Electronic
Limitation of inductive shutdown voltage to		L+ (-1.5 V)
Controlling a digital input		Yes
Switching capacity of the outputs		
• on lamp load, max.		5 W
Load resistance range		
• lower limit		240 Ω
• upper limit		4 kΩ
Output voltage		
• for signal "1", min.		L+ (-2.5 V)

Technical specifications (continued)

Article number	6ES7355-2CH00-0AE0 TEMPERATURE CONTROL MOD. FM355-2C	6ES7355-2SH00-0AE0 SIMATIC S7-300, TEMPERATURE
Output current		
• for signal "1" rated value		0.1 A
• for signal "1" permissible range for 0 to 60 °C, min.		5 mA
• for signal "1" permissible range for 0 to 60 °C, max.		150 mA
• for signal "0" residual current, max.		0.5 mA
Parallel switching of two outputs		
• for logic links		Yes
Switching frequency		
• with resistive load, max.		100 Hz
• with inductive load, max.		0.5 Hz
• on lamp load, max.		100 Hz
Total current of the outputs (per group)		
all mounting positions		
- up to 60 °C, max.		400 mA
Cable length		
• shielded, max.		1 000 m
• unshielded, max.		600 m
Analog inputs		
Number of analog inputs	4	4
permissible input voltage for voltage input (destruction limit), max.	20 V	20 V
permissible input current for current input (destruction limit), max.	40 mA	40 mA
Input ranges (rated values), voltages		
• 0 to +10 V	Yes	Yes
• -1.75 V to +11.75 V	Yes	Yes
Input ranges (rated values), currents		
• 0 to 20 mA	Yes	Yes
• 0 to 23.5 mA	Yes	Yes
• -3.5 mA to +23.5 mA	Yes	Yes
• 4 mA to 20 mA	Yes	Yes
Input ranges (rated values), thermocouples		
• Type B	Yes	Yes
• Type E	Yes	Yes
• Type J	Yes	Yes
• Type K	Yes	Yes
• Type R	Yes	Yes
• Type S	Yes	Yes
Input ranges (rated values), resistance thermometer		
• Pt 100	Yes	Yes
Thermocouple (TC)		
Temperature compensation		
- internal temperature compensation	Yes	Yes
- external temperature compensation with Pt100	Yes	Yes
Characteristic linearization		
• parameterizable	Yes	Yes
- for thermocouples	Type B, E, J, K, R, S	Type B, E, J, K, R, S
- for resistance thermometer	Pt100 (standard)	Pt100 (standard)
Cable length		
• shielded, max.	200 m; 50 m at 80 mV and thermocouples	200 m; 50 m at 80 mV and thermocouples

SIMATIC S7-300 Advanced Controllers

I/O modules

Function modules

FM 355-2 temperature controller module

Technical specifications (continued)

Article number	6ES7355-2CH00-0AEO	6ES7355-2SH00-0AEO
	TEMPERATURE CONTROL MOD. FM355-2C	SIMATIC S7-300, TEMPERATURE
Analog outputs		
Number of analog outputs	4	
Voltage output, short-circuit protection	Yes	
Voltage output, short-circuit current, max.	25 mA	
Current output, no-load voltage, max.	18 V	
Output ranges, voltage		
• 0 to 10 V	Yes	
• -10 V to +10 V	Yes	
Output ranges, current		
• 0 to 20 mA	Yes	
• 4 mA to 20 mA	Yes	
Connection of actuators		
• for voltage output two-wire connection	Yes	
• for current output two-wire connection	Yes	
Load impedance (in rated range of output)		
• with voltage outputs, min.	1 kΩ	
• with voltage outputs, capacitive load, max.	1 μF	
• with current outputs, max.	500 Ω	
• with current outputs, inductive load, max.	1 mH	
Cable length		
• shielded, max.	200 m; 50 m at 80 mV and thermocouples	
Analog value generation for the inputs		
Measurement principle	integrating	integrating
Integration and conversion time/ resolution per channel		
• Resolution with overrange (bit including sign), max.	14 bit	14 bit
• Conversion time (per channel)	100 ms; At 50/60 Hz	100 ms; At 50/60 Hz
Analog value generation for the outputs		
Settling time		
• for resistive load	0.1 ms	
• for capacitive load	3.3 ms	
• for inductive load	0.5 ms	
Encoder		
Connection of signal encoders		
• for voltage measurement	Yes	Yes
• for current measurement as 4-wire transducer	Yes	Yes
Connectable encoders		
• 2-wire sensor	Yes	Yes
- permissible quiescent current (2-wire sensor), max.	1.5 mA	1.5 mA
Errors/accuracies		
Linearity error (relative to input range), (+/-)	0.05 %	0.05 %
Temperature error (relative to input range), (+/-)	0.005 %/K	0.005 %/K
Linearity error (relative to output range), (+/-)	0.05 %	
Temperature error (relative to output range), (+/-)	0.02 %/K	

Technical specifications (continued)

Article number	6ES7355-2CH00-0AE0 TEMPERATURE CONTROL MOD. FM355-2C	6ES7355-2SH00-0AE0 SIMATIC S7-300, TEMPERATURE
Operational error limit in overall temperature range		
• Voltage, relative to input range, (+/-)	0.6 %; +/-0.6 to +/-0.7%	0.06 %; +/-0.06 to +/-0.7%
• Current, relative to input range, (+/-)	0.6 %; +/-0.6 to +/-0.7%	0.06 %; +/-0.06 to +/-0.7%
• Resistance thermometer, relative to input range, (+/-)	0.6 %; +/-0.6 to +/-0.7%	0.06 %; +/-0.06 to +/-0.7%
• Voltage, relative to output range, (+/-)	0.5 %	
• Current, relative to output range, (+/-)	0.6 %	
Basic error limit (operational limit at 25 °C)		
• Voltage, relative to input range, (+/-)	0.04 %; +/-0.04 to +/-0.5%	0.04 %; +/-0.04 to +/-0.5%
• Current, relative to input range, (+/-)	0.04 %; +/-0.04 to +/-0.5%	0.04 %; +/-0.04 to +/-0.5%
• Resistance thermometer, relative to input range, (+/-)	0.04 %; +/-0.04 to +/-0.5%	0.04 %; +/-0.04 to +/-0.5%
• Voltage, relative to output range, (+/-)	0.4 %	
• Current, relative to output range, (+/-)	0.5 %	
Interference voltage suppression for $f = n \times (f_1 \pm 1 \%)$, $f_1 =$ interference frequency		
• Series mode interference (peak value of interference < rated value of input range), min.	40 dB	40 dB
• Common mode interference (USS < 2.5 V), min.	70 dB	70 dB
Interrupts/diagnostics/status information		
Substitute values connectable	Yes; Parameterizable	Yes; Parameterizable
Integrated Functions		
Control technology		
• Number of closed-loop controllers	4	4
Potential separation		
Potential separation controller		
• between the channels	No	No
• between the channels and backplane bus	Yes; Optocoupler	Yes; Optocoupler
Permissible potential difference		
Between the inputs and MANA (UCM)	2.5 V DC	2.5 V DC
Isolation		
Isolation tested with	500 V DC	500 V DC
Connection method		
required front connector	2x 20-pin	2x 20-pin
Dimensions		
Width	80 mm	80 mm
Height	125 mm	125 mm
Depth	120 mm	120 mm
Weights		
Weight, approx.	470 g	470 g

SIMATIC S7-300 Advanced Controllers

I/O modules

Function modules

FM 355-2 temperature controller module**Ordering data****Article No.****FM 355-2 C temperature controller module****6ES7355-2CH00-0AE0**with 4 analog outputs for
4 continuous-action controllers**FM 355-2 S temperature controller module****6ES7355-2SH00-0AE0**with 8 digital outputs
for 4 step or pulse controllers**Front connector**

20-pin, with screw contacts

- 1 unit
- 100 units

6ES7392-1AJ00-0AA0
6ES7392-1AJ00-1AB0

20-pin, with spring-loaded contacts

- 1 unit
- 100 units

6ES7392-1BJ00-0AA0
6ES7392-1BJ00-1AB0**Bus connectors****6ES7390-0AA00-0AA0**

1 unit (spare part)

Article No.**Labeling strips****6ES7392-2XX00-0AA0**

10 units (spare part)

Labeling sheets for machine inscriptionSee under "Accessories",
page 5/264**Slot number label****6ES7912-0AA00-0AA0**

Spare part

Shield connection element**6ES7390-5AA00-0AA0**80 mm wide, with 2 rows
for 4 terminals each**Shield connection clamps**

2 units

For 2 cables with 2 mm to 6 mm
diameter**6ES7390-5AB00-0AA0**For 1 cable with 3 mm to 8 mm
diameter**6ES7390-5BA00-0AA0**For 1 cable with 4 mm to 13 mm
diameter**6ES7390-5CA00-0AA0**

Overview



- Interface between max. 3 absolute encoders (SSI) and the CPU
- For provision of the displacement encoder values for further processing in STEP 7 programs
- Enables direct response of controller to encoder values in moving systems

Note:

Displacement measuring systems and precut/pre-assembled cables for counting and positioning functions are available under SIMODRIVE Sensor or Motion Connect 500.

<http://www.siemens.com/simatic-technology>

Technical specifications

Article number	6ES7338-4BC01-0AB0 SM 338, F. 3 SSI ENCODERS
Supply voltage	
Load voltage L+	
• Rated value (DC)	24 V
Input current	
from load voltage L+ (without load), max.	100 mA
from backplane bus 5 V DC, max.	160 mA
24 V encoder supply	
• 24 V	Yes; L+ (-0.8 V)
• Output current, max.	900 mA
Power loss	
Power loss, typ.	3 W
Digital inputs	
Input voltage	
• for signal *0*	-3 to +5V
• for signal *1*	11 to 30.2 V
Input current	
• for signal *0*, max. (permissible quiescent current)	2 mA
• for signal *1*, typ.	9 mA
Input delay (for rated value of input voltage)	
for standard inputs	
- at *0* to *1*, min.	300 µs
Cable length	
• shielded, max.	600 m

Article number	6ES7338-4BC01-0AB0 SM 338, F. 3 SSI ENCODERS
Encoder	
Number of connectable encoders, max.	3
Connectable encoders	
• Absolute encoder (SSI)	Yes
• 2-wire sensor	Yes
Encoder signals, absolute encoder (SSI)	
• Cable length, shielded, max.	320 m; 320 m at 125 kHz; 160 m at 250 kHz; 60 m at 500 kHz; 20 m at 1 MHz
Interrupts/diagnostics/status information	
Alarms	
• Diagnostic alarm	Yes
Potential separation	
Potential separation exists	No
Connection method	
required front connector	20-pin
Dimensions	
Width	40 mm
Height	125 mm
Depth	120 mm
Weights	
Weight, approx.	235 g

SIMATIC S7-300 Advanced Controllers

I/O modules

Function modules

SM 338 POS input module

Ordering data

Article No.

SM 338 POS input module

6ES7338-4BC01-0AB0

For position sensing
with 3 SSI encoders

Front connector

20-pin, with screw contacts

- 1 unit
- 100 units

6ES7392-1AJ00-0AA0

6ES7392-1AJ00-1AB0

20-pin, with spring-loaded contacts

- 1 unit
- 100 units

6ES7392-1BJ00-0AA0

6ES7392-1BJ00-1AB0

Front door, elevated design

6ES7328-0AA00-7AA0

e.g. for 32-channel modules;
for connecting 1.3 mm²/16 AWG
conductors

SIMATIC Manual Collection

6ES7998-8XC01-8YE0

Electronic manuals on DVD,
multilingual:
LOGO!, SIMADYN, SIMATIC bus
components, SIMATIC C7,
SIMATIC distributed I/O,
SIMATIC HMI, SIMATIC Sensors,
SIMATIC NET, SIMATIC PC Based
Automation, SIMATIC PCS 7,
SIMATIC PG/PC, SIMATIC S7,
SIMATIC Software, SIMATIC TDC

SIMATIC Manual Collection

6ES7998-8XC01-8YE2

update service for 1 year
Current "Manual Collection" DVD
and the three subsequent updates

Signal cable

Pre-assembled for SSI absolute
encoder 6FX2001-5, without
Sub-D connector, UL/DESINA

Article No.

6FX5002-2CC12-

0 m

1

100 m

2

200 m

3

0 m

A

10 m

B

20 m

C

30 m

D

40 m

E

50 m

F

60 m

G

70 m

H

80 m

J

90 m

K

0 m

A

1 m

B

2 m

C

3 m

D

4 m

E

5 m

F

6 m

G

7 m

H

8 m

J

9 m

K

0.0 m

0

0.1 m

1

0.2 m

2

0.3 m

3

0.4 m

4

0.5 m

5

0.6 m

6

0.7 m

7

0.8 m

8

5

Overview



- For connecting up to 4 drives with analog setpoint interface or pulse-direction interface to a controller
- Operation with isochronous PROFIBUS DP
- Connectable drives:
 - Electrical drives
 - Hydraulic drives
 - Stepper drives
- Can be used with:
 - SIMATIC CPU 41x-2 DP, CPU 31x-2 DP, CPU 31xT-2 DP, WinAC RTX 2008
 - SIMOTION C2xx, SIMOTION P350, SIMOTION D4x5
- Can also be used with external encoders

5

Technical specifications

Article number	6ES7174-0AA10-0AA0 IM 174 FOR CONNECTING ANALOG DRIVES
Supply voltage	
Rated value (DC)	
• 24 V DC	Yes
Input current	
Current consumption, max.	500 mA
from backplane bus 5 V DC, max.	100 mA
Encoder supply	
5 V encoder supply	
• 5 V	Yes
• Output current, max.	1.2 A
• Cable length, max.	25 m
24 V encoder supply	
• 24 V	Yes
• Output current, max.	1.4 A
• Cable length, max.	100 m
Absolute encoder (SSI) encoder supply	
• Absolute encoder (SSI)	Yes
• short-circuit protection	Yes
Power loss	
Power loss, typ.	12 W
Digital inputs	
Number of digital inputs	10
Input voltage	
• for signal "0"	-3 to +5V
• for signal "1"	+11 to +30V
Input current	
• for signal "0", max. (permissible quiescent current)	2 mA
• for signal "1", typ.	8 mA
Input delay (for rated value of input voltage) for standard inputs	
- at "0" to "1", min.	15 µs

Article number	6ES7174-0AA10-0AA0 IM 174 FOR CONNECTING ANALOG DRIVES
Cable length	
• shielded, max.	100 m
Digital outputs	
Number of digital outputs	8
Short-circuit protection	Yes
Switching capacity of the outputs	
• with resistive load, max.	1 A
• on lamp load, max.	30 W
Output voltage	
• Rated value (DC)	24 V; L+
• for signal "1", min.	L+ (-3 V)
• for signal "1", max.	3 V
Output current	
• for signal "1" permissible range for 0 to 55 °C, min.	5 mA
• for signal "1" permissible range for 0 to 55 °C, max.	300 mA
• for signal "0" residual current, max.	0.4 mA
Output delay with resistive load	
• "0" to "1", max.	500 µs
Switching frequency	
• with resistive load, max.	500 Hz
• with inductive load, max.	0.5 Hz
Relay outputs	
• Number of relay outputs	4
• Number of operating cycles, max.	50 000
Switching capacity of contacts	
- with resistive load, max.	1 A
Cable length	
• shielded, max.	600 m
Analog outputs	
Number of analog outputs	4
Output ranges, voltage	
• -10 V to +10 V	Yes

SIMATIC S7-300 Advanced Controllers

I/O modules

Function modules

IM 174 PROFIBUS module

Technical specifications (continued)

Article number	6ES7174-0AA10-0AA0 IM 174 FOR CONNECTING ANALOG DRIVES
Analog value generation for the outputs	
Integration and conversion time/resolution per channel	
• Resolution with overrange (bit including sign), max.	15 bit
Encoder	
Number of connectable encoders, max.	4
Connectable encoders	
• Incremental encoder (symmetrical)	Yes
• Absolute encoder (SSI)	Yes
• 2-wire sensor	Yes
- permissible quiescent current (2-wire sensor), max.	2 mA
Encoder signals, incremental encoder (symmetrical)	
• Trace mark signals	A, notA, B, notB
• Zero mark signal	N, notN
• Input signal	5 V difference signal (phys. RS 422)
• Input frequency, max.	1 MHz
• Cable length, shielded, max.	35 m; 35 m at max. 500 kHz; 10 m at max. 1 MHz
Encoder signals, absolute encoder (SSI)	
• Input signal	5 V difference signal (phys. RS 422)
• Data signal	DATA, notDATA
• Clock signal	CL, notCL
• Telegram length, parameterizable	13, 21, 24 bit
• Clock frequency, max.	1.5 MHz; 187.5 KHz 1.5 MHz (parameterizable)
• Binary code	Yes
• Gray code	Yes
• Cable length, shielded, max.	250 m; 250 m at 187.5 kHz, 10 m at 1.5 MHz
Isochronous mode	
Isochronous operation (application synchronized up to terminal) shortest clock pulse	Yes 1.5 ms

Article number	6ES7174-0AA10-0AA0 IM 174 FOR CONNECTING ANALOG DRIVES
Interrupts/diagnostics/status information	
Alarms	
• Diagnostic alarm	Yes
Drive interface	
Number of drive interfaces	4
Analog drive	
Setpoint signal	
- Short-circuit proof	Yes; max. 45 mA, min. 3.3 kOhm load impedance
- Rated voltage range	-10.5 V to +10.5 V
- Output current	-3 to +3 mA
Output controller enable	
- Number of relay contacts	4
- Switching voltage, max.	30 V
- Switching current, max.	1 A
- Switching capacity, max.	30 V·A
- Number of switching cycles, min.	50 000; at 30 V DC, 1 A
- Cable length, shielded, max.	35 m
Stepper drive	
• Differential output voltage, min.	2 V; R = 100 Ohm
• Differential output voltage for signal "0", max.	1 V; For I = -20 mA
• Differential output voltage for signal "1", min.	3.7 V; 3.7 V at I = -20 mA; 4.5 V at I = -100 µA,
• Load resistance, min.	55 Ω
• Output current, max.	60 mA
• Pulse frequency	750 kHz
• Cable length, shielded, max.	50 m; in hybrid operation with analog axes 35 m, in asymmetrical transmission 10 m
Potential separation	
Potential separation digital inputs	
• Potential separation digital inputs	Yes; to encoders, analog outputs, DP interface; no to other DI/DOs
Potential separation digital outputs	
• Potential separation digital outputs	Yes; to encoders, analog outputs, DP interface; no to other DI/DOs
Connection method	
required front connector	40-pin
Dimensions	
Width	160 mm
Height	125 mm
Depth	118 mm
Weights	
Weight, approx.	1 kg

Ordering data**Article No.****Article No.****IM 174 PROFIBUS module**

PROFIBUS module for connecting analog drives and stepper drives to a controller

6ES7174-0AA10-0AA0**Setpoint cable**

for the connection between IM 174 and SIMODRIVE 611-A

6FX2002-3AD01-

0 m
100 m
200 m

1
2
3

0 m
10 m
20 m
30 m
40 m
50 m
60 m
70 m
80 m
90 m

A
B
C
D
E
F
G
H
J
K

0 m
1 m
2 m
3 m
4 m
5 m
6 m
7 m
8 m
9 m

A
B
C
D
E
F
G
H
J
K

0.0 m
0.1 m
0.2 m
0.3 m
0.4 m
0.5 m
0.6 m
0.7 m
0.8 m

0
1
2
3
4
5
6
7
8

SIMATIC S7-300 Advanced Controllers

I/O modules

Function modules

SIWAREX U

Overview



SIWAREX U is a versatile weighing module for all simple weighing and force measuring tasks. The compact module can be integrated into SIMATIC automation systems without any problems. Complete data access is possible via the SIMATIC.

5

Technical specifications

SIWAREX U	
Integration in automation systems	
<ul style="list-style-type: none"> • S7-300 • S7-1500 • S7-400 (H) • PCS 7 (H) • Automation systems from other vendors • Stand-alone (without SIMATIC CPU) 	Direct integration Through ET 200M Through ET 200M Through ET 200M Through ET 200M Possible with IM 153-1
Communication interfaces	
	<ul style="list-style-type: none"> • SIMATIC S7 (P bus) • RS 232 • TTY
Connection of remote displays (through TTY serial interface)	
	Gross, channel 1, 2 or default value 1, 2
Adjustment of scales settings	
	Through SIMATIC (P bus) or PC using SIWATOOL U (RS 232)
Measuring properties	
Error limit to DIN 1319-1 of full-scale value at 20 °C ± 10 K (68 °F ± 10 K)	0.05%
Internal resolution ADC	65535
Data format of weight values	2 byte (fixed-point)
Number of measurements/second	
	50
Digital filter	
	0.05 ... 5 Hz (in 7 steps), mean value filter
Weighing functions	
Weight values	Gross
Limit values	2 (min./max.)
Zero setting function	Per command
Load cells	
	Strain gages in 4-wire or 6-wire system

SIWAREX U	
Load cell powering	
Supply voltage U_s (rated value)	6 V DC ¹⁾
Max. supply current	≤ 150 mA per channel
Permissible load resistance	
• R_{Lmin}	> 40 Ω per channel
• R_{Lmax}	< 4010 Ω
With Ex(i) interface	
• R_{Lmin}	> 87 Ω per channel
• R_{Lmax}	< 4010 Ω
Permissible load cell characteristic	
	Up to 4 mV/V
Max. distance of load cells	
	500 m ²⁾ 150/500 m for gas group IIC 500 m ²⁾ for gas group IIB (see SIWAREX IS Manual)
Intrinsically-safe load cell powering	
	Optional (Ex interface) with SIWAREX IS
Auxiliary power supply	
Rated voltage	24 V DC
Max. power consumption	150 mA (single-channel) / 240 mA (dual-channel)
Current consumption on backplane bus	≤ 100 mA
Certification	
	ATEX 95, FM, cUL _{US} Haz. Loc.
IP degree of protection to DIN EN 60529; IEC 60529	
	IP20
Climatic requirements	
T_{min} (IND) to T_{max} (IND) (operating temperature)	
• Horizontal installation	0 ... +60 °C (32 ... 140 °F)
• Vertical installation	0 ... +40 °C (32 ... 104 °F)
EMC requirements according to	
	according to NAMUR NE21, Part 1; EN 61326
Dimensions	
	40 x 125 x 130 mm (1.58 x 4.92 x 5.12 in)

¹⁾ Load cell supply changed to 6 V DC as compared to 7MH4601-1AA01 and ... 1BA01.

²⁾ Possible up to 1000 m under certain conditions when using the recommended cable (accessories).

Ordering data	Article No.	Ordering data	Article No.
SIWAREX U For SIMATIC S7 and ET 200M, incl. bus connector, weight 0.3 kg (0.661 lb)		Installation material (mandatory)	
Single-channel version ¹⁾ for connecting one scale	7MH4950-1AA01	20-pin front plug with screw contacts Required for each SIWAREX module	6ES7392-1AJ00-0AA0
Two-channel version ²⁾ for connecting two scales	7MH4950-2AA01	Shield connection element Sufficient for two SIWAREX U modules	6ES7390-5AA00-0AA0
SIWAREX U manual Available in a range of languages Free download from the Internet at: http://www.siemens.com/weighing-technology		Shield connection clamp	6ES7390-5CA00-0AA0
SIWAREX U configuration package for TIA Portal and STEP 7 On CD-ROM <ul style="list-style-type: none"> • SIWATOOL U PC software (available in a range of languages), new design • Sample program "Getting started" – ready to use application for SIMATIC S7 and TIA Portal • SIWAREX U manual on CD (in a range of languages), new design • HSP Hardware Support Package for integrating SIWAREX U in STEP 7 	7MH4950-1AK02	Contents: 2 units (suitable for cable with diameter 4 ... 13 mm) (0.16 ... 0.51 in) Note: one shield connection clamp each is required for: <ul style="list-style-type: none"> • Scale connection • RS 485 interface • RS 232 interface 	
SIWAREX U configuration package for PCS7 S7, version 7.0 and V7.1 Suitable for 7MH4950-1AA01 and 7MH4950-2AA01 On CD-ROM <ul style="list-style-type: none"> • Function block for the CFC • Faceplate • SIWATOOL U commissioning software • Manual 	7MH4950-3AK61	S7 DIN rail <ul style="list-style-type: none"> • 160 mm (6.30 in) • 480 mm (18.90 in) • 530 mm (20.87 in) • 830 mm (32.68 in) • 2000 mm (78.74 in) 	6ES7390-1AB60-0AA0 6ES7390-1AE80-0AA0 6ES7390-1AF30-0AA0 6ES7390-1AJ30-0AA0 6ES7390-1BC00-0AA0
SIWAREX U configuration package for PCS7, version 8.0 Suitable for 7MH4950-xAA01 <ul style="list-style-type: none"> • Function block for the CFC • Faceplate • SIWATOOL U commissioning software • Manual 	7MH4950-3AK62	Accessories (optional)	
SIWAREX U APL configuration package for PCS7, version 8.0, Update 1 Suitable for 7MH4950-xAA01 <ul style="list-style-type: none"> • Function block for the CFC • APL-style faceplate • SIWATOOL U commissioning software • Manual 	7MH4950-3AK65	Labeling strips (10 units, spare part)	6ES7392-2XX00-0AA0
SIWATOOL connecting cable From SIWAREX U/CS with serial PC interface, for 9-pin PC interfaces (RS 232), length 3 m (9.84 ft)	7MH4607-8CA	Remote displays (option) The digital remote displays can be connected directly to SIWAREX U through a TTY interface. The following remote displays can be used: S102, S302 Siebert Industrieelektronik GmbH Postfach 1180 D-66565 Eppelborn, Germany Tel.: +49 6806/980-0 Fax: +49 6806/980-999 Internet: http://www.siebert.de Detailed information is available from the manufacturer.	
		SIWAREX JB junction box, aluminum housing	7MH4710-1BA
		For connecting up to 4 load cells in parallel, and for connecting several junction boxes	
		SIWAREX JB junction box, stainless steel housing	7MH4710-1EA
		For connecting up to 4 load cells in parallel.	
		SIWAREX JB junction box, stainless steel housing (ATEX)	7MH4710-1EA01
		For parallel connection of up to 4 load cells (for zone allocation, see manual or type examination certificate).	

SIMATIC S7-300 Advanced Controllers

I/O modules

Function modules

SIWAREX U**Ordering data****Article No.****Article No.****Ex interface SIWAREX IS**

For intrinsically-safe connection of load cells. With ATEX approval (not UL/FM). Suitable for SIWAREX electronic weighing system. Compatibility of load cells must be checked.

- With short-circuit current < 199 mA DC
- With short-circuit current < 137 mA DC

7MH4710-5BA**7MH4710-5CA****Cable (optional)****Cable Li2Y 1 x 2 x 0.75 ST + 2 x (2 x 0.34 ST) – CY**

For connecting SIWAREX electronic weighing systems to junction box (JB), extension box (EB) and Ex interface or between two JB's. For permanent installation. Occasional bending is possible.

External diameter: approx. 10.8 mm (0.43 inch)

Permissible ambient temperature -40 ... +80 °C (-40 ... +176 °F).

Sold by the meter.

- Sheath color: orange
- For potentially explosive atmospheres. Sheath color: blue

7MH4702-8AG**7MH4702-8AF**

- 1) Compatible with 7MH4601-1AA01; supply of load cells changed to 6 V DC.
- 2) Compatible with 7MH4601-1BA01; supply of load cells changed to 6 V DC.

Overview



SIWAREX FTA (Flexible Technology, Automatic Weighing Instrument) is a versatile and flexible weighing module for industrial use. It can be used in both non-automatic and automatic weighing operation, for example the production of mixtures, and for filling, loading, monitoring and bag filling.

It has the corresponding scale approvals and is also suitable for legal-for-trade weighing systems.

The SIWAREX FTA function module is integrated in SIMATIC S7/PCS7, and uses the features of this modern automation system, such as integrated communication, diagnostics and configuration tools.

Technical specifications

SIWAREX FTA	
Use in automation systems	
S7-300	Directly or through ET 200M
S7-1500	Through ET 200M
S7-400 (H)	Through ET 200M
PCS 7 (H)	Through ET 200M
Communication interfaces	
S7	Through backplane bus
RS 232	For SIWATOOL or printer connection
RS 485	For remote display or digital load cell
Module parameterization	
	Using SIMATIC S7
	Using SIWATOOL FTA software (RS 232)
Measuring properties	
EU type approval as non-automatic weighing machine, trade class III	3 x 6 000 d ≥ 0.5 μV/e
Internal resolution	16 million parts
Internal/external updating rate	400/100 Hz
Several parameterizable digital filters	Critically damped, Bessel, Butterworth (0.05 ... 20 Hz), mean-value filter
Weighing functions	
Non-automatic weighing machine	OIML R76
Automatic weighing machine	OIML R51, R61, R107
Load cells	
	Strain gages in 4-wire or 6-wire system
3 characteristic value ranges	1, 2 or 4 mV/V
Load cell powering	
Supply voltage U_S (rated value)	10.3 V DC
Max. supply current	184 mA
Permissible load cell resistance	
• R_{Lmin}	> 56 Ω
	> 87 Ω with Ex interface
• R_{Lmax}	≤ 4 010 Ω

SIWAREX FTA	
Max. distance of load cells	
When using the recommended cable:	
Standard	1 000 m (3 280 ft)
In hazardous area ¹⁾	
• For gases of group IIC	300 m (984 ft)
• For gases of group IIB	1000 m (3 280 ft)
Connection to load cells in Ex zone 1	Optionally via SIWAREX IS Ex interface
Ex approvals zone 2 and safety	ATEX 95, FM, cUL _{US} Haz. Loc.
Auxiliary power supply	
Rated voltage	24 V DC
Max. power consumption	500 mA
Current consumption from backplane bus	typ. 55 mA
Inputs/outputs	
Digital inputs	7 DI electrically isolated
Digital outputs	8 DO electrically isolated
Counter input	Up to 10 kHz
Analog output	
• Current range	0/4 ... 20 mA
• Updating rate	100 Hz
Approvals	
	EU type approval (CE, OIML R76)
	EU prototype test to MID (OIML R51, R61, R107)
Degree of protection according to EN 60529; IEC 60529	IP20
Climatic requirements	
T_{min} (IND) ... T_{max} (IND) (operating temperature)	
• Horizontal installation	-10 ... 60 °C (14 ... 140 °F)
• Vertical installation	-10 ... 40 °C (14 ... 104 °F)
EMC requirements	EN 61326, EN 45501, NAMUR NE21, Part 1
Dimensions	80 x 125 x 130 mm (3.15 x 4.92 x 5.12 in)
Weight	600 g (0.44 lb)

¹⁾ For further details, see Ex interface, type SIWAREX IS

SIMATIC S7-300 Advanced Controllers

I/O modules

Function modules

SIWAREX FTA

Ordering data

Article No.

Article No.

SIWAREX FTA

Legal-for-trade weighing electronics for automatic scales for S7-300 and ET 200M. EU type approval 3 x 6000 d. Applications: proportioning, filling, bagging, loading. Note: Observe approval conditions for applications with obligation of verification. We recommend using our calibration set and contacting our SIWAREX hotline.

7MH4900-2AA01

SIWAREX FTA manual

Available in a range of languages. Free download from the Internet at: <http://www.siemens.com/weighing-technology>

SIWAREX FTA "Getting started"

Sample software shows beginners how to program the scales in STEP 7.

Free download from the Internet at: <http://www.siemens.com/weighing-technology>

SIWAREX FTA configuration package on CD-ROM, for TIA Portal and STEP 7

- HSP Hardware Support Package for integrating SIWAREX FTA/FTC in STEP 7
- SIWAREX FTA "Getting started"
- SIWATOOL FTA commissioning software
- Flexible software for legal-for-trade display in WinCC
- Manual

7MH4900-2AK02

SIWAREX FTA configuration package for PCS 7 V7.0 on CD-ROM

- HSP Hardware Support Package for integrating SIWAREX FTA/FTC in STEP 7
- Function block for CFC
- Faceplate
- SIWATOOL FTA commissioning software
- Manual

7MH4900-2AK62

SIWAREX FTA configuration package for SIMATIC PCS 7, Version 8.0 on CD-ROM

- HSP Hardware Support Package for integrating SIWAREX FTA/FTC in STEP 7
- Function block for CFC
- Faceplate
- SIWATOOL FTA commissioning software
- Manual

7MH4900-2AK63

SIWAREX FTA APL configuration package for SIMATIC PCS 7, Version 8.0, Update 1 on CD-ROM

- HSP Hardware Support Package for integrating SIWAREX FTA/FTC in STEP 7
- Function block for CFC
- APL-style faceplate
- SIWATOOL FTA commissioning software
- Manual

7MH4900-2AK65

Calibration set for SIWAREX FTA

For verification of up to 5 scales comprising:

- 3 x inscription foil for labeling
- 1 x protection foil
- Guidelines for verification, verification certificates and approvals, adaptable label, SIWAREX FTA manual on CD-ROM

7MH4900-2AY10

SIWATOOL connecting cable

From SIWAREX FTA with serial PC interface, for 9-pin PC interfaces (RS 232)

- 2 m long (6.56 ft)
- 5 m long (16.40 ft)

7MH4702-8CA
7MH4702-8CB**Front connector, 40-pin**

Required for each SIWAREX module

- With screw contacts
- With spring-loaded terminals

6ES7392-1AM00-0AA0
6ES7392-1BM01-0AA0**Shield connection element**

Sufficient for one SIWAREX FTA module

6ES7390-5AA00-0AA0

Shield connection clamp

Contents: 2 units (suitable for cable with diameter 4 ... 13 mm (0.16 ... 0.51 in))

Note: one shield connection clamp each is required for:

- Scale connection
- RS 485 interface
- RS 232 interface

6ES7390-5CA00-0AA0

S7 DIN rail

- 160 mm (6.30 in)
- 480 mm (18.90 in)
- 530 mm (20.87 in)
- 830 mm (32.68 in)
- 2000 mm (78.74 in)

6ES7390-1AB60-0AA0
6ES7390-1AE80-0AA0
6ES7390-1AF30-0AA0
6ES7390-1AJ30-0AA0
6ES7390-1BC00-0AA0**MMC memory**

For data recording up to 32 MB, only for legal-for-trade applications R76, R51 and R107

7MH4900-2AY21

Ordering data	Article No.	Article No.	
<p>Remote displays (option)</p> <p>The Siebert S102 and S302 remote digital displays can be directly connected to the SIWAREX FTA via an RS 485 interface.</p> <p>Siebert Industrieelektronik GmbH Postfach 1180 D-66565 Eppelborn, Germany Tel.: +49 6806/980-0 Fax: +49 6806/980-999 Internet: http://www.siebert.de</p> <p>Detailed information is available from the manufacturer.</p>			
<p>SIWAREX JB junction box, aluminum housing</p> <p>For connecting up to 4 load cells in parallel, and for connecting several junction boxes</p>	7MH4710-1BA		
<p>SIWAREX JB junction box, stainless steel housing</p> <p>For connecting up to 4 load cells in parallel</p>	7MH4710-1EA		
<p>SIWAREX JB junction box, stainless steel housing (ATEX)</p> <p>For parallel connection of up to 4 load cells (for zone allocation, see manual or type examination certificate).</p>	7MH4710-1EA01		
<p>Ex interface SIWAREX IS</p> <p>For intrinsically-safe connection of load cells. With ATEX approval (not UL/FM). Suitable for SIWAREX electronic weighing system. Compatibility of load cells must be checked.</p> <ul style="list-style-type: none"> • With short-circuit current < 199 mA DC • With short-circuit current < 137 mA DC 	<p>7MH4710-5BA</p> <p>7MH4710-5CA</p>		
		<p>Cable (optional)</p> <p>Cable Li2Y 1 x 2 x 0.75 ST + 2 x (2 x 0.34 ST) – CY</p> <p>For connecting SIWAREX electronic weighing systems to junction box (JB), extension box (EB) and Ex interface or between two JB's. For permanent installation. Occasional bending is possible.</p> <p>External diameter: approx. 10.8 mm (0.43 in)</p> <p>Permissible ambient temperature -40 ... +80 °C (-40 ... +176 °F).</p> <p>Sold by the meter.</p> <ul style="list-style-type: none"> • Sheath color: orange • For potentially explosive atmospheres. Sheath color: blue 	<p>7MH4702-8AG</p> <p>7MH4702-8AF</p>

SIMATIC S7-300 Advanced Controllers

I/O modules

Function modules

SIWAREX FTC

Overview



The SIWAREX FTC (Flexible Technology for Continuous Weighing) is a versatile and flexible weighing module for belt scales, loss-in-weight scales and bulk flow meters. It can also be used to record weights and measure force. The SIWAREX FTC function module is integrated in SIMATIC S7/PCS7, and uses the features of this modern automation system, such as integral communication, diagnostics and configuration tools.

5

Technical specifications

SIWAREX FTC	
Use in automation systems	
S7-300	Directly or via ET 200M
S7-1500	Through ET 200M
S7-400 (H)	Through ET 200M
PCS 7 (H)	Through ET 200M
Communication interfaces	
S7	Through backplane bus
RS 232	For SIWATOOL or printer connection
RS 485	For remote display or digital load cell
Module parameterization	
	Using SIMATIC S7
	Using SIWATOOL FTC software (RS 232)
Measuring properties	
Accuracy to EN 45501	$3 \times 6\,000 d \geq 0.5 \mu\text{V/e}$
Internal resolution	+/- 8 million parts
Internal/external updating rate	400/100 Hz
Several parameterizable digital filters	
	Critically dampened, Bessel, Butterworth (0.05 ... 20 Hz), mean-value filter
Weighing functions	
	<ul style="list-style-type: none"> • Non-automatic weighing machine, force measurement • Conveyor scale • Differential proportioning weigher • Bulk flow meter
Load cells	
	Strain gages in 4-wire or 6-wire system
3 characteristic value ranges	1, 2 or 4 mV/V
Load cell powering	
Supply voltage U_S (rated value)	10.3 V DC
Max. supply current	184 mA
Permissible load cell resistance	
• R_{Lmin}	$> 56 \Omega$
	$> 87 \Omega$ with Ex interface
• R_{Lmax}	$\leq 4\,010 \Omega$

SIWAREX FTC	
Max. distance of load cells	
When using the recommended cable:	
Standard	1 000 m (3 280 ft)
In hazardous area ¹⁾	
• For gases of group IIC	300 m (984 ft)
• For gases of group IIB	1 000 m (3 280 ft)
Connection to load cells in Ex zone 1	
	Optionally via SIWAREX IS Ex interface
Ex approvals zone 2 and safety	
	ATEX 95, FM, cUL _{US} Haz. Loc.
Auxiliary power supply	
Rated voltage	24 V DC
Max. power consumption	500 mA
Current consumption from backplane bus	typ. 55 mA
Inputs/outputs	
Digital inputs	7, electrically isolated
Digital outputs	8, electrically isolated
Counter input	Up to 10 kHz
Analog output	
• Current range	0/4 ... 20 mA
• Updating rate	100 Hz
Degree of protection according to EN 60529; IEC 60529	
	IP20
Climatic requirements	
$T_{min}(\text{IND}) \dots T_{max}(\text{IND})$ (operating temperature)	
• Horizontal installation	-10 ... 60 °C (14 ... 140 °F)
• Vertical installation	-10 ... 40 °C (14 ... 104 °F)
EMC requirements	
	EN 61326, EN 45501, NAMUR NE21, Part 1
Dimensions	
	80 x 125 x 130 mm (3.15 x 4.92 x 5.12 in)
Weight	
	600 g (0.44 lb)

¹⁾ For further details, see Ex interface, type SIWAREX IS

Ordering data	Article No.	Article No.
SIWAREX FTC Weighing electronics for S7-300 and ET 200M. Applications: Belt scales, force measurement, loss-in-weight scales and solids flowmeters	7MH4900-3AA01	SIWAREX FTC_B configuration package for PCS 7 Version V7.0 and V7.1 on CD-ROM (conveyor scale) <ul style="list-style-type: none"> HSP Hardware Support Package for integrating SIWAREX FTA/FTC in STEP 7 Function block for CFC Faceplate Commissioning software SIWATOOL FTC_B for conveyor scales Manual
SIWAREX FTC_B manual for belt scales Available in a range of languages Free download from the Internet at: http://www.siemens.com/weighing-technology		SIWAREX FTC_B configuration package for PCS 7 Version V8.0 on CD-ROM (conveyor scale) <ul style="list-style-type: none"> HSP Hardware Support Package for FTA/FTC package Function block for the CFC Faceplate SIWATOOL commissioning software Manual
SIWAREX FTC_L manual for solids flowmeters and loss-in-weight scales Available in a range of languages Free download from the Internet at: http://www.siemens.com/weighing-technology		Configuration package SIWAREX FTC_L for PCS 7 V8.0 on CD-ROM (loss-in-weight scales) <ul style="list-style-type: none"> HSP Hardware Support Package for integrating SIWAREX FTA/FTC in STEP 7 Function block for the CFC Faceplate Commissioning software SIWATOOL FTC_L for solids flowmeters and loss-in-weight scales Manual
SIWAREX FTC "Getting started" for belt scales Sample software shows beginners how to program the scales in STEP 7 for conveyor scale mode Free download from the Internet at: http://www.siemens.com/weighing-technology		SIWAREX FTC_L configuration package for PCS 7 V7.0 and V7.1 on CD-ROM (loss-in-weight scales) <ul style="list-style-type: none"> HSP Hardware Support Package for integrating SIWAREX FTA/FTC in STEP 7 Function block for the CFC Faceplate Commissioning software SIWATOOL FTC_L for bulk flow meters and loss-in-weight scales Manual
SIWAREX FTC "Getting started" for solids flowmeters Sample software shows beginners how to program the scales in STEP 7 for bulk flow meter mode Free download from the Internet at: http://www.siemens.com/weighing-technology		SIWAREX FTC_L configuration package for PCS 7 V7.0 and V7.1 on CD-ROM (loss-in-weight scales) <ul style="list-style-type: none"> HSP Hardware Support Package for integrating SIWAREX FTA/FTC in STEP 7 Function block for the CFC Faceplate Commissioning software SIWATOOL FTC_L for bulk flow meters and loss-in-weight scales Manual
SIWAREX FTC "Getting started" for loss-in-weight scales Sample software shows beginners how to program scales in STEP 7 for differential proportioning weigher mode Free download from the Internet at: http://www.siemens.com/weighing-technology		SIWATOOL connecting cable from SIWAREX FTC with serial PC interface, for 9-pin PC interfaces (RS 232) <ul style="list-style-type: none"> 2 m long (6.56 ft) 5 m long (16.40 ft)
Configuration package SIWAREX FTC_B for the TIA Portal and STEP 7 on CD-ROM (belt scales) <ul style="list-style-type: none"> HSP Hardware Support Package for integrating SIWAREX FTA/FTC in STEP 7 "Getting started" for conveyor scales Commissioning software SIWATOOL FTC_B for conveyor scales Manual 	7MH4900-3AK03	40-pin front plug with screw contacts Required for each SIWAREX module <ul style="list-style-type: none"> With screw contacts With spring-loaded terminals
Configuration package SIWAREX FTC_L for the TIA Portal and STEP 7 on CD-ROM (solids flowmeters, loss-in-weight scales) <ul style="list-style-type: none"> HSP Hardware Support Package for integrating SIWAREX FTA/FTC in STEP 7 "Getting started" for solids flowmeters "Getting started" for loss-in-weight scales Commissioning software SIWATOOL_L for bulk flow meters and loss-in-weight scales Manual 	7MH4900-3AK04	6ES7392-1AM00-0AA0 6ES7392-1BM01-0AA0

SIMATIC S7-300 Advanced Controllers

I/O modules

Function modules

SIWAREX FTC

Ordering data	Article No.	Article No.
Shield connection element Sufficient for one SIWAREX FTC module	6ES7390-5AA00-0AA0	
Shield connection clamp Contents: 2 units (suitable for cable with diameter 4 ... 13 mm) Note: one shield connection clamp each is required for: <ul style="list-style-type: none"> • Scale connection • RS 485 interface • RS 232 interface 	6ES7390-5CA00-0AA0	
S7 DIN rail <ul style="list-style-type: none"> • 160 mm (6.30 inch) • 480 mm (18.90 inch) • 530 mm (20.87 inch) • 830 mm (32.68 inch) • 2000 mm (78.74 inch) 	6ES7390-1AB60-0AA0 6ES7390-1AE80-0AA0 6ES7390-1AF30-0AA0 6ES7390-1AJ30-0AA0 6ES7390-1BC00-0AA0	
MMC memory For data recording up to 16 MB	7MH4900-2AY20	
Remote display (optional) The Siebert S102 and S302 remote digital displays can be directly connected to the SIWAREX FTC via an RS 485 interface. (Not suitable for belt scale mode) Siebert Industrieelektronik GmbH Postfach 1180 D-66565 Eppelborn, Germany Tel.: +49 6806/980-0 Fax: +49 6806/980-999 Internet: http://www.siebert.de Detailed information available from manufacturer.		
SIWAREX JB junction box, aluminum housing For connecting up to 4 load cells in parallel, and for connecting several junction boxes	7MH4710-1BA	
SIWAREX JB junction box, stainless steel housing For connecting up to 4 load cells in parallel.	7MH4710-1EA	
SIWAREX JB junction box, stainless steel housing (ATEX) For parallel connection of up to 4 load cells (for zone allocation, see manual or type examination certificate).	7MH4710-1EA01	
		Ex interface SIWAREX IS For intrinsically-safe connection of load cells. With ATEX approval (not UL/FM). Suitable for SIWAREX electronic weighing system. Compatibility of load cells must be checked. <ul style="list-style-type: none"> • With short-circuit current < 199 mA DC • With short-circuit current < 137 mA DC
		7MH4710-5BA 7MH4710-5CA
		Cable (optional) Cable Li2Y 1 x 2 x 0.75 ST + 2 x (2 x 0.34 ST) – CY For connecting SIWAREX electronic weighing systems to junction box (JB), extension box (EB) and Ex interface or between two JB's. For permanent installation. Occasional bending is possible. External diameter: approx. 10.8 mm (0.43 inch) Permissible ambient temperature -40 ... +80 °C (-40 ... +176 °F). Sold by the meter. <ul style="list-style-type: none"> • Sheath color: orange • For potentially explosive atmospheres. Sheath color: blue
		7MH4702-8AG 7MH4702-8AF

Overview



SIFLOW FC070 is based on the latest developments within the digital processing technology – engineered for high performance, fast flow step response, immunity against process generated noise, easy to install, commission and maintain.

SIFLOW FC070 is available in two versions:

- SIFLOW FC070 Standard
- SIFLOW FC070 Ex CT

The SIFLOW FC070 transmitter delivers true multi-parameter measurements i.e. mass flow, volume flow, density, temperature and fraction.

SIFLOW FC070 is designed for integration in a variety of automation systems, i.e.:

- Central mounted in S7-300, C7
- Decentralized in ET 200M for use with S7-300 and S7-400 as PROFIBUS DP/PROFINET masters
- Decentralized in ET 200M for use with any automation system using standardized PROFIBUS DP/PROFINET masters
- Stand-alone via a Modbus RTU master, i.e. SIMATIC PDM

The SIFLOW FC070 transmitter can be connected to all sensors of types MASS 2100, MC2, FCS200 and FC300.

Technical specifications

Measurement of	Mass flow, volume flow, density, sensor temperature, fraction A flow, fraction B flow, fraction A in %
Measurement functions	
• Totalizer 1	Totalization of mass flow, volume flow, fraction A, fraction B
• Totalizer 2	Totalization of mass flow, volume flow, fraction A, fraction B
• Single and 2-stage batch function	Batching function with the use of one or two outputs for dosing in high and low speed
• 4 programmable limits	4 programmable high/low limits for mass flow, volume flow, density, sensor temperature, fraction A flow, fraction B flow, fraction A in %. Limits will generate an alarm if reached.
Digital input	
Functions	Start batch, stop batch, start/stop batch, hold/continue batch, reset totalizer 1, reset totalizer 2, reset totalizer 1 and 2, zero adjust, force frequency output, freeze frequency output
High signal	<ul style="list-style-type: none"> • Nominal voltage: 24 V DC • Lower limit: 15 V DC • Upper limit: 30 V DC • Current: 2 ... 15 mA
Low signal	<ul style="list-style-type: none"> • Nominal voltage: 0 V DC • Lower limit: -3 V DC • Upper limit: 5 V DC • Current: -15 ... +15 mA
Input	Approx. 10 kΩ
Switching	Max. 100 Hz

Digital output 1 and 2	
Functions	<ul style="list-style-type: none"> • Output 1: Pulse, frequency, redundancy pulse, redundancy frequency 2-stage batch, batch • Output 2: Redundancy pulse, redundancy frequency, 2-stage batch
Voltage supply	3 ... 30 V DC (passive output)
Switching current	Max. 30 mA at 30 V DC
Voltage drop	≤ 3 V DC at max. current
Leakage current	≤ 0.4 mA at max. voltage 30 V DC
Load resistance	1 ... 10 kΩ
Switching frequency	0 ... 12 kHz 50 % duty cycle
Functions	Pulse, frequency, redundancy pulse, redundancy frequency 2-stage batch, batch
Communication	
Modbus RS 232C	<ul style="list-style-type: none"> • Max. baud rate: 115 200 baud • Max. line length: 15 m at 115 200 baud • Signal level: according to EIA-RS 232C
Modbus RS 485	<ul style="list-style-type: none"> • Max. baud rate: 115 200 baud • Max. line length: 1200 m at 115 200 baud • Signal level: according to EIA-RS 485 • Bus termination: Integrated. Can be enabled by inserting wire jumpers.
Galvanic isolation	All inputs, outputs and communication interfaces are galvanically isolated. Isolation voltage: 500 V.

SIMATIC S7-300 Advanced Controllers

I/O modules

Function modules

SIFLOW FC070**Technical specifications** (continued)

Power	
Supply	24 V DC nominal
Tolerance	20.4 V DC ... 28.8 V DC
Consumption	Max. 7.2 W
Fuse	T1 A/125 V, not replaceable by operator
Environment	
Ambient temperature	<ul style="list-style-type: none"> Storage -40 °C ... +70 °C (-40 °F ... +158 °F)
Operation conditions	Horizontally mounted rail. For SIFLOW FC070 Std.: 0 ... 60 °C (32 ... 140 °F) For SIFLOW FC070 Ex CT: -40 ... +60 °C (-40 ... +140 °F) Vertically mounted rail For SIFLOW FC070 Std.: 0 ... 45 °C (32 ... 113 °F) For SIFLOW FC070 Ex CT: -40 ... +45 °C (-40 ... +113 °F)
Altitude	<ul style="list-style-type: none"> Operation: -1000 ... 2000 m (pressure 795 ... 1080 hPa)
Enclosure	
Material	Noryl, color: anthracite
Rating	IP20/NEMA 2 according to IEC 60529
Mechanical load	According to SIMATIC standards (S7-300 devices)
Ex approvals	
SIFLOW FC070 Standard	ATEX: II 3G Ex nA II T4
SIFLOW FC070 Ex CT	ATEX, IECEx, EAC Ex, FM, CSA, NEPSI, INMETRO: <ul style="list-style-type: none"> Zone 2: Ex nA [ia] IIC T4 FM: <ul style="list-style-type: none"> Class I, Div. 2: Grp. A, B, C, D (interface to Class I+II+III, Div. 1)

Custody transfer approvals	
SIFLOW FC070 Ex CT	PTB Germany approval no.: 5.4.11/11.22 OIML R 139 - Compressed gaseous fuel measuring systems for vehicles NTEP for USA and Canada, approval no: 97-111A3
EMC performance	
Emission	EN 55011/CISPR-11
Immunity	EN/IEC 61326-1
NAMUR	
	Within the limits according to "General recommendations" with error criteria A in accordance with NE 21
Programming tools	
SIMATIC S7	Configuration through backplane P-BUS, PLC program and WinCC flexible
SIMATIC PCS7	Configuration through backplane P-BUS and PLC/WinCC faceplates, certified driver
SIMATIC PDM	Through Modbus port RS 232C and RS 485, certified driver

Ordering data	Article No.	Ordering data	Article No.
SIFLOW FC070 flow transmitter Remember to order 40-pin front connector	7ME4120-2DH20-0EA0	Accessories	
40-pin front connector with screw contacts	6ES7392-1AM00-0AA0	Cable with multiplug for connecting MASS 2100, FCS200 and FC300 sensors, 5 x 2 x 0.34 mm ² twisted and screened in pairs. Temperature range -20 °C ... +110 °C (-4 °F ... +230 °F)	
40-pin front connector with spring contacts	6ES7392-1BM01-0AA0	<ul style="list-style-type: none"> • 5 m (16.4 ft) • 10 m (32.8 ft) • 25 m (82 ft) • 50 m (164 ft) • 75 m (246 ft) • 150 m (492 ft) 	FDK:083H3015 FDK:083H3016 FDK:083H3017 FDK:083H3018 FDK:083H3054 FDK:083H3055
SIFLOW FC070 Ex flow transmitter Remember to order 20-pin front connector.	7ME4120-2DH21-0EA0	Cable without multiplug for connecting MC2 sensors, 5 x 2 x 0.34 mm ² twisted and screened in pairs. Temperature range -20 °C ... +110 °C (-4 °F ... +230 °F)	
20-pin front connector with screw contacts	6ES7392-1AJ00-0AA0	<ul style="list-style-type: none"> • 10 m (32.8 ft) • 25 m (82 ft) • 75 m (246 ft) • 150 m (492 ft) 	FDK:083H3001 FDK:083H3002 FDK:083H3003 FDK:083H3004
20-pin front connector with spring contacts	6ES7392-1BJ00-0AA0	SIMATIC S7-300 rail The mechanical mounting rack of the SIMATIC S7-300	
Operating instructions for SITRANS F C SIFLOW FC070		<ul style="list-style-type: none"> • 160 mm (6.3") • 482 mm (18.9") • 530 mm (20.8") • 830 mm (32.7") • 2000 mm (78.7") 	6ES7390-1AB60-0AA0 6ES7390-1AE80-0AA0 6ES7390-1AF30-0AA0 6ES7390-1AJ30-0AA0 6ES7390-1BC00-0AA0
This device is shipped with Safety Notes and a DVD containing further SITRANS F literature. All literature is available to download for free, in a range of languages, at http://www.siemens.com/ processinstrumentation/ documentation		SIFLOW FC070 Demo suitcase with MASS 2100 DI 1.5 sensor and SIMATIC HMI TP 177B touch panel	A5E01075465
SIFLOW FC070 system manual • English • German	A5E00924779 A5E00924776	SIMATIC S7-300, stabilized power supply PS307 Input: 120/230 V AC Output: 24 V DC/2 A	6ES7307-1BA01-0AA0
SIFLOW FC070 with S7 • English • German	A5E02254228 A5E02665536		
SIFLOW FC070 with PCS 7 • English	A5E03694109		

SIMATIC S7-300 Advanced Controllers

I/O modules

SIPLUS S7-300 function modules

SIPLUS S7-300 FM 350-1**Overview**

- Single-channel, intelligent counter module for simple counting tasks
- For direct connection of incremental encoders
- Comparison function with 2 definable comparison values
- Integrated digital outputs for output of the response on reaching the comparison value
- Operating modes:
 - Continuous counting
 - Single counting
 - Periodic counting
- Special functions:
 - Set counter
 - Latch counter
- Start/stop counter by gate function

Note:

SIPLUS extreme products are based on SIMATIC standard products. The contents listed here were taken from the respective standard products. SIPLUS extreme specific information was added.

Technical specifications

Article number	6AG1350-1AH03-2AE0	6AG1350-1AH03-2AY0
Based on	6ES7350-1AH03-0AE0 SIPLUS S7-300 FM350-1	6ES7350-1AH03-0AE0 SIPLUS S7-300 FM350-1
Ambient conditions		
Ambient temperature during operation		
• min.	-25 °C; = Tmin	-25 °C; = Tmin
• max.	60 °C; = Tmax	60 °C; = Tmax; the rated temperature range of -25 ... +55 °C (T1) applies for the use on railway vehicles according to EN50155
Extended ambient conditions		
• relative to ambient temperature-atmospheric pressure-installation altitude	Tmin ... Tmax at 1080 hPa ... 795 hPa (-1000 m ... +2000 m) // Tmin ... (Tmax - 10K) at 795 hPa ... 658 hPa (+2000 m ... +3500 m) // Tmin ... (Tmax - 20K) at 658 hPa ... 540 hPa (+3500 m ... +5000 m)	
Relative humidity		
- With condensation, tested in accordance with IEC 60068-2-38, max.	100 %; RH incl. condensation/frost (no commissioning under condensation conditions)	100 %; RH incl. condensation/frost (no commissioning under condensation conditions)
Resistance		
- against biologically active substances / conformity with EN 60721-3-3	Yes; Class 3B2 mold, fungus and dry rot spores (with the exception of fauna). The supplied connector covers must remain on the unused interfaces during operation!	Yes; Class 3B2 mold, fungus and dry rot spores (with the exception of fauna). The supplied connector covers must remain on the unused interfaces during operation!
- against chemically active substances / conformity with EN 60721-3-3	Yes; Class 3C4 (RH < 75%) incl. salt spray according to EN 60068-2-52 (degree of severity 3). The supplied connector covers must remain on the unused interfaces during operation!	Yes; Class 3C4 (RH < 75%) incl. salt spray according to EN 60068-2-52 (degree of severity 3). The supplied connector covers must remain on the unused interfaces during operation!
- against mechanically active substances / conformity with EN 60721-3-3	Yes; Class 3S4 incl. sand, dust. The supplied connector covers must remain on the unused interfaces during operation!	Yes; Class 3S4 incl. sand, dust. The supplied connector covers must remain on the unused interfaces during operation!

Ordering data	Article No.	Documentation	Article No.
SIPLUS S7-300 FM 350-1 counter module with 1 channel, max. 500 kHz; for incremental encoder <i>For industrial applications with extended ambient conditions</i> <u>Extended temperature range and exposure to media</u> <i>For rolling stock railway applications</i> <u>Conforms to EN 50155</u>	6AG1350-1AH03-2AE0 6AG1350-1AH03-2AY0	SIMATIC Manual Collection Electronic manuals on DVD, multi-language: LOGO!, SIMADYN, SIMATIC bus components, SIMATIC C7, SIMATIC distributed I/O, SIMATIC HMI, SIMATIC Sensors, SIMATIC NET, SIMATIC PC Based Automation, SIMATIC PCS 7, SIMATIC PG/PC, SIMATIC S7, SIMATIC Software, SIMATIC TDC	6ES7998-8XC01-8YE0
Accessories <i>Mandatory</i> Front connector 20-pin, with spring-loaded contacts <ul style="list-style-type: none"> • 1 unit • 100 units 	6ES7392-1BJ00-0AA0 6ES7392-1BJ00-1AB0	SIMATIC Manual Collection update service for 1 year Current "Manual Collection" DVD and the three subsequent updates	6ES7998-8XC01-8YE2
<i>Consumables</i> Bus connectors 1 unit (spare part)	6ES7390-0AA00-0AA0		
Shield connecting element 80 mm wide, with 2 rows for 4 shield connection clamps each	6ES7390-5AA00-0AA0		
Shield connection clamps 2 units For 1 cable, diameter 3 mm to 8 mm For 1 cable, diameter 4 mm to 13 mm	6ES7390-5BA00-0AA0 6ES7390-5CA00-0AA0		
Label cover 10 units (spare part), for modules with 20-pin front connector	6ES7392-2XY00-0AA0		
Labeling strips 10 units (spare part), for modules with 20-pin front connector	6ES7392-2XX00-0AA0		
Slot number plates	6ES7912-0AA00-0AA0		

SIMATIC S7-300 Advanced Controllers

I/O modules

SIPLUS S7-300 function modules

SIPLUS S7-300 FM 350-2**Overview**

- 8-channel intelligent counter module for universal counting and measuring tasks
- For the direct connection of 24 V incremental encoders, directional encoders, initiators or NAMUR encoders
- Comparison function with predefined comparison values (number depending on operating mode)
- Integrated digital outputs for output of the response on reaching the comparison value
- Operating modes:
 - Continuous / single / periodic counting
 - Frequency and speed control
 - Period measurement
 - Dosing

Note:

SIPLUS extreme products are based on SIMATIC standard products. The contents listed here were taken from the respective standard products. SIPLUS extreme specific information was added.

Technical specifications

Article number	6AG1350-2AH01-4AE0
Based on	6ES7350-2AH01-0AE0 SIPLUS S7-300 FM350-2
Ambient conditions	
Ambient temperature during operation	
• min.	0 °C; = Tmin
• max.	60 °C; = Tmax
Extended ambient conditions	
• relative to ambient temperature-atmospheric pressure-installation altitude	Tmin ... Tmax at 1080 hPa ... 795 hPa (-1000 m ... +2000 m) // Tmin ... (Tmax - 10K) at 795 hPa ... 658 hPa (+2000 m ... +3500 m) // Tmin ... (Tmax - 20K) at 658 hPa ... 540 hPa (+3500 m ... +5000 m)
Relative humidity	
- With condensation, tested in accordance with IEC 60068-2-38, max.	100 %; RH incl. condensation/frost (no commissioning under condensation conditions)

Article number	6AG1350-2AH01-4AE0
Based on	6ES7350-2AH01-0AE0 SIPLUS S7-300 FM350-2
Resistance	
- against biologically active substances / conformity with EN 60721-3-3	Yes; Class 3B2 mold, fungus and dry rot spores (with the exception of fauna). The supplied connector covers must remain on the unused interfaces during operation!
- against chemically active substances / conformity with EN 60721-3-3	Yes; Class 3C4 (RH < 75%) incl. salt spray according to EN 60068-2-52 (degree of severity 3). The supplied connector covers must remain on the unused interfaces during operation!
- against mechanically active substances / conformity with EN 60721-3-3	Yes; Class 3S4 incl. sand, dust. The supplied connector covers must remain on the unused interfaces during operation!

Ordering data	Article No.	Ordering data	Article No.
SIPLUS S7-300 FM 350-2 counter module With 8 channels, max. 20 kHz; for 24 V incremental encoders and NAMUR encoders; includes configuration package and electronic documentation on CD Exposure to media	6AG1350-2AH01-4AE0	<i>Documentation</i> SIMATIC Manual Collection Electronic manuals on DVD, multi-language: LOGO!, SIMADYN, SIMATIC bus components, SIMATIC C7, SIMATIC distributed I/O, SIMATIC HMI, SIMATIC Sensors, SIMATIC NET, SIMATIC PC Based Automation, SIMATIC PCS 7, SIMATIC PG/PC, SIMATIC S7, SIMATIC Software, SIMATIC TDC	6ES7998-8XC01-8YE0
Accessories <i>Mandatory</i> Front connector 40-pin, with spring-loaded contacts <ul style="list-style-type: none"> • 1 unit • 100 units 	6ES7392-1BM01-0AA0 6ES7392-1BM01-1AB0	SIMATIC Manual Collection update service for 1 year Current "Manual Collection" DVD and the three subsequent updates	6ES7998-8XC01-8YE2
<i>Consumables</i> Bus connectors 1 unit (spare part)	6ES7390-0AA00-0AA0		
Shield connection clamps 2 units For 2 cables, diameter 2 mm to 6 mm For 1 cable, diameter 3 mm to 8 mm For 1 cable, diameter 4 mm to 13 mm	6ES7390-5AB00-0AA0 6ES7390-5BA00-0AA0 6ES7390-5CA00-0AA0		
Label cover 10 units (spare part), for modules with 40-pin front connector	6ES7392-2XY10-0AA0		
Labeling strips 10 units (spare part), for modules with 40-pin front connector	6ES7392-2XX10-0AA0		
Slot number plates	6ES7912-0AA00-0AA0		

SIMATIC S7-300 Advanced Controllers

I/O modules

SIPLUS S7-300 function modules

SIPLUS SIWAREX U**Overview**

SIPLUS SIWAREX U electronic weighing system	
Article No.	6AG1 950-2AA01-4AA0
Article No. based on	7MH4 950-2AA01
Range of ambient temperature	0 ... +60 °C
Conformal coating	Coating of the printed circuit boards and the electronic components
Technical data	The technical data of the standard product applies except for the ambient conditions.
Ambient conditions	
Relative humidity	100%, condensation/frost permitted. No commissioning in bedewed state.

For technical documentation on SIPLUS, see:

<http://www.siemens.com/siplus-extreme>**SIPLUS electronic weighing system SIWAREX U**

SIPLUS SIWAREX U is a flexible weighing module for all simple weighing and force measuring tasks. The compact module can be integrated into SIPLUS automation systems without any problems.

Note:

SIPLUS extreme products are based on SIMATIC standard products. The contents listed here were taken from the respective standard products. SIPLUS extreme specific information was added.

Ordering data**Article No.****SIPLUS SIWAREX U**

Electronic weighing system for SIPLUS S7 and ET 200M, incl. bus connector

Exposure to media

6AG1950-2AA01-4AA0**Accessories***Mandatory***Front connector**

20-pin, with spring-loaded contacts

- 1 unit
- 100 units

6ES7392-1BJ00-0AA0**6ES7392-1BJ00-1AB0***Consumables***Bus connectors**

1 unit (spare part)

6ES7390-0AA00-0AA0**Shield connection clamps**

2 units

For 2 cables, diameter 2 mm to 6 mm

6ES7390-5AB00-0AA0

For 1 cable, diameter 3 mm to 8 mm

6ES7390-5BA00-0AA0

For 1 cable, diameter 4 mm to 13 mm

6ES7390-5CA00-0AA0**Article No.****Labeling strips**

10 units; spare part

6ES7392-2XX00-0AA0**Label cover**

10 units; spare part

6ES7392-2XY00-0AA0**Slot number plates****6ES7912-0AA00-0AA0****SIWAREX JB junction box, aluminum housing**

For connecting up to 4 load cells in parallel, and for connecting multiple junction boxes

7MH4710-1BA**Ex interface, type SIWAREX IS**

With ATEX approval, but without UL and FM approvals, for intrinsically-safe connection of load cells

Incl. manual

Suitable for SIWAREX U, CS, MS, FTA, FTC and CF weighing modules

Approved for use in the EU

- With short-circuit current < 199 mA DC
- With short-circuit current < 137 mA DC

7MH4710-5BA**7MH4710-5CA**

Ordering data	Article No.	Article No.	
Cables (optional) Cable Li2Y 1 x 2 x 0.75 ST + 2 x (2 x 0.34 ST) – CY, orange sheath For connecting SIWAREX U, CS, MS, FTA, FTC and CF to the junction box (JB), extension box (EB) or Ex interface (Ex-I) or between two JB's; for fixed laying, occasional bending permitted, 10.8 mm (0.43 inch) outer diameter, for ambient temperature -40 ... +80 °C (-40 ... +176 °F)	7MH4702-8AG	SIWAREX U configuration package for PCS7 S7, version 7.0 and V7.1 Suitable for 7MH4950-1AA01 and 7MH4950-2AA01 On CD-ROM <ul style="list-style-type: none"> • Function block for the CFC • Faceplate • SIWATOOL U commissioning software • Manual 	7MH4950-3AK61
Cable Li2Y 1 x 2 x 0.75 ST + 2 x (2 x 0.34 ST) – CY, blue sheath For connecting the junction box (JB) or extension box (EB) in a potentially explosive atmosphere to the Ex interface (Ex I), for fixed laying, occasional bending permitted, blue PVC insulating sheath, approx. 10.8 mm (0.43 inch) outer diameter, for ambient temperature -40 ... +80 °C (-40 ... +176 °F)	7MH4702-8AF	SIWAREX U configuration package for PCS7, version 8.0 Suitable for 7MH4950-xAA01 <ul style="list-style-type: none"> • Function block for the CFC • Faceplate • SIWATOOL U commissioning software • Manual 	7MH4950-3AK62
<i>Configuration software</i> SIWAREX U configuration package for SIMATIC S7 version 5.4 or higher On CD-ROM <ul style="list-style-type: none"> • SIWATOOL U PC software (in a range of languages), new design • Sample program "Getting started" – ready to use application for SIMATIC S7 • SIWAREX U manual on CD (in a range of languages), new design • HSP Hardware Support Package for integrating SIWAREX U in STEP 7 	7MH4950-1AK02	SIWAREX U APL configuration package for PCS7, version 8.0, Update 1 Suitable for 7MH4950-xAA01 <ul style="list-style-type: none"> • Function block for the CFC • APL-style faceplate • SIWATOOL U commissioning software • Manual 	7MH4950-3AK65
		<i>Documentation</i> SIMATIC Manual Collection Electronic manuals on DVD, multi-language: LOGO!, SIMADYN, SIMATIC bus components, SIMATIC C7, SIMATIC distributed I/O, SIMATIC HMI, SIMATIC Sensors, SIMATIC NET, SIMATIC PC Based Automation, SIMATIC PCS 7, SIMATIC PG/PC, SIMATIC S7, SIMATIC Software, SIMATIC TDC	6ES7998-8XC01-8YE0
		SIMATIC Manual Collection update service for 1 year Current "Manual Collection" DVD and the three subsequent updates	6ES7998-8XC01-8YE2

SIMATIC S7-300 Advanced Controllers

I/O modules

SIPLUS S7-300 function modules

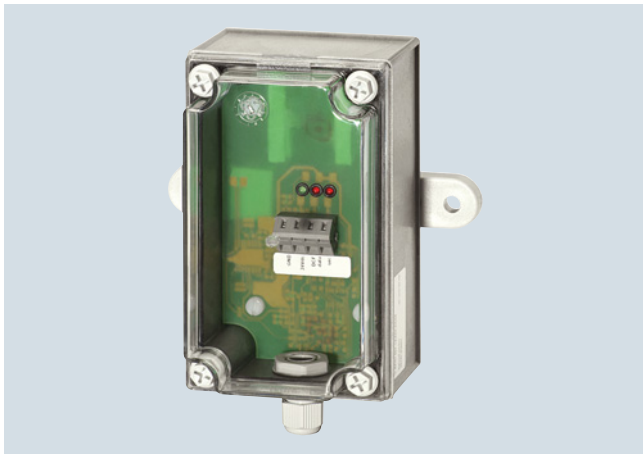
SIPLUS DCF 77 radio clock module**Overview**

This module can be used to synchronize the real-time clock of the SIMATIC/SIPLUS S7-200, S7-300 and S7-400 automation systems with the official time of the DCF 77 time signal transmitter of the Physikalisch-Technische Bundesanstalt Braunschweig, Germany.

The time is received by means of a DCF receiver (antenna with electronics) which is connected via two digital inputs on the SIMATIC PLC and SIPLUS together with a software driver available as a download (function block FB):

<http://www.siemens.com/siplus> - Support - Tools and Downloads!

Technical specifications

Radio clock module SIPLUS DCF 77	
Radio frequency	77.5 Hz
Power supply	24 V DC (20.4 to 28.8 DC)
Power consumption, typ.	50 mA
Dimensions (W x H x D)	75 mm x 125 mm ¹⁾ x 75 mm

¹⁾ Additionally 25 mm (0.98 in) for heavy duty threaded joint and bending radius for cables

Ordering data**Article No.****SIPLUS DCF 77
radio clock module****6AG1057-1AA03-0AA0**

For synchronizing SIMATIC S7-200, S7-300 and S7-400 with the official time of the DCF 77 time signal transmitter of the Physikalisch-Technische Bundesanstalt Braunschweig

Overview

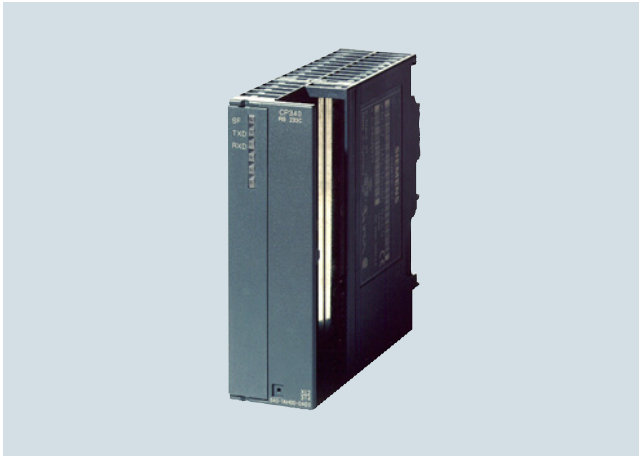

- The economical complete solution for serial communication via point-to-point links.
- 3 versions with different transmission interfaces:
 - RS 232C (V.24)
 - 20 mA (TTY)
 - RS 422/RS 485 (X.27)
- Implemented protocols:
 - ASCII
 - 3964 (R) (not for RS 485)
 - Printer driver
- Simple parameterization via a parameterization tool integrated into STEP 7

Technical specifications

Article number	6ES7340-1AH02-0AE0	6ES7340-1BH02-0AE0	6ES7340-1CH02-0AE0
	CP 340 W. RS 232C INTERFACE (V.24)	CP 340 W. 20MA INTERFACE (TTY)	CP 340 W. RS 422/485 INTERFACE
Supply voltage			
Rated value (DC)			
• 24 V DC	No; Power supply via backplane bus 5V	No; Power supply via backplane bus 5V	No; Power supply via backplane bus 5V
Input current			
from backplane bus 5 V DC, max.	165 mA	190 mA	165 mA
Power loss			
Power loss, typ.	0.6 W	0.85 W	0.6 W
Power loss, max.	0.85 W	0.95 W	0.85 W
Interfaces			
Number of interfaces	1; Isolated	1; Isolated	1; Isolated
Interface physics, 20 mA (TTY)		Yes	
Interface physics, RS 232C (V.24)	Yes		
Interface (physical) RS 422/485 (X.27)			Yes
Transmission rate, min.	2.4 kbit/s	2.4 kbit/s	2.4 kbit/s
Transmission rate, max.	19.2 kbit/s	19.2 kbit/s	19.2 kbit/s
Point-to-point			
• Cable length, max.	15 m	1 000 m; 100 m active, 1000 m passive	1 200 m
• supported printers	HP-Deskjet, HP-Laserjet, IBM-Proprinter, user-defined	HP-Deskjet, HP-Laserjet, IBM-Proprinter, user-defined	HP-Deskjet, HP-Laserjet, IBM-Proprinter, user-defined
• Connector type	9-pin sub D connector	9-pin sub D socket	15-pin sub D socket
Integrated protocol driver			
- 3964 (R)	Yes	Yes	Yes
- ASCII	Yes	Yes	Yes
- RK512	No	No	No
- customer-specific drivers reloadable	No	No	No
Telegram length, max.			
- 3964 (R)	1 024 byte	1 024 byte	1 024 byte
- ASCII	1 024 byte	1 024 byte	1 024 byte
Transmission rate, 20 mA (TTY)			
- with 3964 (R) protocol, max.		19.2 kbit/s	
- with ASCII protocol, max.		9.6 kbit/s	
- with printer driver, max.		9.6 kbit/s	

SIMATIC S7-300 Advanced Controllers

I/O modules

Communication

CP 340

Technical specifications (continued)

Article number	6ES7340-1AH02-0AE0	6ES7340-1BH02-0AE0	6ES7340-1CH02-0AE0
	CP 340 W. RS 232C INTERFACE (V.24)	CP 340 W. 20MA INTERFACE (TTY)	CP 340 W. RS 422/485 INTERFACE
Transmission rate, RS 422/485			
- with 3964 (R) protocol, max.			19.2 kbit/s
- with ASCII protocol, max.			9.6 kbit/s
- with printer driver, max.			9.6 kbit/s
Transmission speed, RS 232			
- with 3964 (R) protocol, max.	19.2 kbit/s		
- with ASCII protocol, max.	9.6 kbit/s		
- with printer driver, max.	9.6 kbit/s		
Ambient conditions			
Ambient temperature during operation			
• min.	0 °C	0 °C	0 °C
• max.	60 °C	60 °C	60 °C
Ambient temperature during storage/transportation			
• min.	-40 °C	-40 °C	-40 °C
• max.	70 °C	70 °C	70 °C
Software			
Block			
• FB length in RAM, max.	2 700 byte; Data communication, sending and receiving	2 700 byte; Data communication, sending and receiving	2 700 byte; Data communication, sending and receiving
Connection method			
Power supply	Over backplane bus	Over backplane bus	Over backplane bus
Dimensions			
Width	40 mm	40 mm	40 mm
Height	125 mm	125 mm	125 mm
Depth	120 mm	120 mm	120 mm
Weights			
Weight, approx.	300 g	300 g	300 g

Ordering data

Article No.

Article No.

CP 340 communications processor

With one RS 232 C (V.24) interface

RS 232 connecting cable

For linking to SIMATIC S7

5 m

10 m

15 m

CP 340 communications processor

With one 20 mA (TTY) interface

20 mA (TTY) connecting cable

For linking to SIMATIC S7

5 m

10 m

50 m

CP 340 communications processor

With one RS 422/485 (X.27) interface

RS 422/485 connecting cable

For linking to SIMATIC S7

5 m

10 m

50 m

6ES7340-1AH02-0AE0
6ES7902-1AB00-0AA0
6ES7902-1AC00-0AA0
6ES7902-1AD00-0AA0
6ES7340-1BH02-0AE0

6ES7902-2AB00-0AA0
6ES7902-2AC00-0AA0
6ES7902-2AG00-0AA0
6ES7340-1CH02-0AE0
6ES7902-3AB00-0AA0
6ES7902-3AC00-0AA0
6ES7902-3AG00-0AA0

Overview



- For quick, high-performance data exchange via point-to-point coupling
- 3 versions with different transmission physics:
 - RS 232C (V.24),
 - 20 mA (TTY),
 - RS 422/RS 485 (X.27)
- Implemented protocols: ASCII, 3964 (R), RK 512
- The following protocols can also be loaded: Modbus RTU
- Easy configuration using a parameterizing tool integrated in STEP 7

Technical specifications

Article number	6ES7341-1AH02-0AE0 CP 341 RS 232C (V.24)	6ES7341-1BH02-0AE0 CP341 20MA-INTERFACE (TTY)	6ES7341-1CH02-0AE0 CP341 RS 422/485-INTERFACE
General information			
Product type designation	CP341 V2 RS232	CP341 V2 TTY	CP341 V2 RS422/485
Supply voltage			
Rated value (DC)			
• 24 V DC	Yes	Yes	Yes
Input current			
from supply voltage L+, max.	100 mA	100 mA	100 mA
from backplane bus 5 V DC, max.	70 mA	70 mA	70 mA
Power loss			
Power loss, typ.	1.6 W	1.6 W	1.6 W
Power loss, max.	2.4 W	2.4 W	2.4 W
Interfaces			
Number of interfaces	1; Isolated	1; Isolated	1; Isolated
Interface physics, 20 mA (TTY)		Yes	
Interface physics, RS 232C (V.24)	Yes		
Interface (physical) RS 422/485 (X.27)			Yes
Transmission rate, min.	0.3 kbit/s	0.3 kbit/s	0.3 kbit/s
Transmission rate, max.	115.2 kbit/s	19.2 kbit/s	115.2 kbit/s
Point-to-point			
• Cable length, max.	15 m	1 000 m	1 200 m
• supported printers	Serial printers	Serial printers	Serial printers
• Connector type	9-pin sub D connector	9-pin sub D socket	15-pin sub D socket
Integrated protocol driver			
- 3964 (R)	Yes	Yes	Yes; not with RS 485
- ASCII	Yes	Yes	Yes
- RK512	Yes	Yes	Yes; not with RS 485
Telegram length, max.			
- 3964 (R)	4 096 byte	4 096 byte	4 096 byte
- ASCII	4 096 byte	4 096 byte	4 096 byte
- RK 512	4 096 byte	4 096 byte	4 096 byte
Transmission rate, 20 mA (TTY)			
- with 3964 (R) protocol, max.		19.2 kbit/s	
- with ASCII protocol, max.		19.2 kbit/s	
- with printer driver, max.		19.2 kbit/s	
- with RK 512 protocol, max.		19.2 kbit/s	

SIMATIC S7-300 Advanced Controllers

I/O modules

Communication

CP 341

Technical specifications (continued)

Article number	6ES7341-1AH02-0AE0 CP 341 RS 232C (V.24)	6ES7341-1BH02-0AE0 CP341 20MA-INTERFACE (TTY)	6ES7341-1CH02-0AE0 CP341 RS 422/485-INTERFACE
Transmission rate, RS 422/485			
- with 3964 (R) protocol, max.			115.2 kbit/s
- with ASCII protocol, max.			115.2 kbit/s
- with printer driver, max.			115.2 kbit/s
- with RK 512 protocol, max.			115.2 kbit/s
Transmission speed, RS 232			
- with 3964 (R) protocol, max.	115.2 kbit/s		
- with ASCII protocol, max.	115.2 kbit/s		
- with printer driver, max.	115.2 kbit/s		
- with RK 512 protocol, max.	115.2 kbit/s		
Ambient conditions			
Ambient temperature during operation			
• min.	0 °C	0 °C	0 °C
• max.	60 °C	60 °C	60 °C
Ambient temperature during storage/transportation			
• min.	-40 °C	-40 °C	-40 °C
• max.	70 °C	70 °C	70 °C
Software			
Block			
• FB length in RAM, max.	6 100 byte; Data communication, sending and receiving	6 100 byte; Data communication, sending and receiving	6 100 byte; Data communication, sending and receiving
Connection method			
Power supply	3 screw-type terminals: L+, M, GND	3 screw-type terminals: L+, M, GND	3 screw-type terminals: L+, M, GND
Dimensions			
Width	40 mm	40 mm	40 mm
Height	125 mm	125 mm	125 mm
Depth	120 mm	120 mm	120 mm
Weights			
Weight, approx.	300 g	300 g	300 g

Ordering data

Ordering data	Article No.	Ordering data	Article No.
CP 341 communications processor	6ES7341-1AH02-0AE0	CP 341 communications processor	6ES7341-1CH02-0AE0
With one RS 232 C (V.24) interface		With one RS 422/485 (X.27) interface	
RS 232 connecting cable		RS 422/485 connecting cable	
For linking to SIMATIC S7		For linking to SIMATIC S7	
5 m	6ES7902-1AB00-0AA0	5 m	6ES7902-3AB00-0AA0
10 m	6ES7902-1AC00-0AA0	10 m	6ES7902-3AC00-0AA0
15 m	6ES7902-1AD00-0AA0	50 m	6ES7902-3AG00-0AA0
CP 341 communications processor	6ES7341-1BH02-0AE0	Loadable drivers for CP 341	
With one 20 mA (TTY) interface		Modbus master (RTU format)	
20 mA (TTY) connecting cable		• Single license	6ES7870-1AA01-0YA0
For linking to SIMATIC S7		• Single license, without software or documentation	6ES7870-1AA01-0YA1
5 m	6ES7902-2AB00-0AA0	Modbus slave (RTU format)	
10 m	6ES7902-2AC00-0AA0	• Single license	6ES7870-1AB01-0YA0
50 m	6ES7902-2AG00-0AA0	• Single license, without software or documentation	6ES7870-1AB01-0YA1

Overview

- Drivers for Modbus protocol with RTU message format; communication as master or slave
- Downloadable onto CP 341 and CP 441-2 (6ES7441-2AA05-0AE0)

Technical specifications

Parameterization software	Loadable drivers for CP 441-2 and CP 341		Modbus slave
Type of license	Simple license, copy license		
Target system	SIMATIC CP 341, SIMATIC CP 441-2		
Technical specifications	Modbus Master <ul style="list-style-type: none"> • Modbus protocol with RTU format • Master/slave coupling: SIMATIC S7 is master • Function codes implemented: 01, 02, 03, 04, 05, 06, 07, 08, 11, 12, 15, 16 • No V.24 control and signal lines • CRC polynomial: $x^{16} + x^{15} + x^2 + 1$ • Interfaces: TTY (20 mA); V.24 (RS 232 C); X.27 (RS 422/485) 2-wire or 4-wire • Receive mailbox specified on BRCV • Character delay time 3.5 characters or multiple thereof • Broadcast message possible • Transmission rate 300 bit/s up to 76800 bit/s (TTY up to 19200 bit/s) • Character frame • With/without RS 485 operation for 2-wire connections • With/without modem operation (ignore smudge characters) • Response monitoring time 100 ms to 25.5 s in steps of 100 ms • Factor for the character delay time 1-10 • Default setting of receive line when using the X.27 interface module 	Adjustable parameters	Modbus slave <ul style="list-style-type: none"> • Modbus protocol with RTU format • Master/slave coupling: SIMATIC S7 is slave • Function codes implemented: 01, 02, 03, 04, 05, 06, 08, 15, 16 • No V.24 control and signal line • CRC polynomial: $x^{16} + x^{15} + x^2 + 1$ • Interfaces: TTY (20 mA), V.24 (RS 232C), X.27 (RS 422/485) 2-wire or 4-wire • Communications FB 180, instance DB 180 (use of a multi-instance) • Conversion of the Modbus data address to S7 data areas. Data areas which can be processed: DB, bit memories, outputs, inputs, timers, counters • Character delay time 3.5 characters or multiple thereof • Transmission rate 300 bit/s up to 76800 bit/s (TTY up to 19200 bit/s) • Character frame • Slave address of CP (1 to 255) • With/without RS 485 operation for 2-wire connection • With/without modem operation (ignore smudge characters) • Factor for the character delay time 1-10 • Number of work DB (for FB processing) • Enabling of memory areas for writing by the master • Default setting of receive line when using the X.27 interface module • Conversion of Modbus addresses to S7 data areas
Adjustable parameters			

SIMATIC S7-300 Advanced Controllers

I/O modules

Communication

Loadable drivers for CP 441-2 and CP 341**Ordering data****Article No.****Modbus Master V3.1**

Task:

Communication
via Modbus protocol
with RTU format,
SIMATIC S7 as master

Requirement:

CP 341 or CP 441-2;
STEP 7 V4.02 and higher

Delivery package:

Driver program/documentation,
English, German, French

Single license

6ES7870-1AA01-0YA0

Single license, without software
and documentation

6ES7870-1AA01-0YA1**Modbus Slave V3.1**

Task:

Communication
via Modbus protocol
with RTU format,
SIMATIC S7 as slave

Requirement:

CP 341 or CP 441-2;
STEP 7 V4.02 and higher

Delivery package:

Driver program/documentation,
English, German, French

Single license

6ES7870-1AB01-0YA0

Single license, without software
and documentation

6ES7870-1AB01-0YA1**Article No.****SIMATIC Manual Collection****6ES7998-8XC01-8YE0**

Electronic manuals on DVD,
multilingual:

LOGO!, SIMADYN, SIMATIC bus
components, SIMATIC C7,
SIMATIC distributed I/O,
SIMATIC HMI, SIMATIC Sensors,
SIMATIC NET, SIMATIC PC Based
Automation, SIMATIC PCS 7,
SIMATIC PG/PC, SIMATIC S7,
SIMATIC Software, SIMATIC TDC

**SIMATIC Manual Collection
update service for 1 year****6ES7998-8XC01-8YE2**

Current "Manual Collection" DVD
and the three subsequent updates

Overview



CP 343-2P / CP 343-2

The CP 343-2P communications processor is the AS-Interface master for the SIMATIC S7-300 and the ET 200M distributed I/O station, with user-friendly parameterizing options.

The CP 343-2 is the basic version of the module.

The CP 343-2P / CP 343-2 has the following characteristics:

- As many as 62 AS-Interface slaves can be connected
- Integrated analog value transmission
- Supports all AS-Interface master functions according to the AS-Interface Specification V3.0
- Status displays of operating states and indication of the readiness for operation of connected slaves by means of LEDs in the front panel
- Fault indications (including AS-Interface voltage fault, configuration fault) by means of LEDs in the front panel.
- Compact enclosure in the design of the SIMATIC S7-300
- Suitable for AS-i Power24V (from product version 2/firmware version 3.1) and for Standard AS-i with 30-V-voltage.
- Additionally for CP 343-2P: Supports the configuration of the AS-Interface network with STEP 7 V5.2 and higher

Benefits

- Shorter start-up times through simple configuration at the press of a button
- Design of flexible machine-related structures using the ET 200M distributed I/O system
- Enables diagnostics of the AS-Interface network
- Well suited also for complex applications thanks to connection options for 62 slaves and integral analog value processing
- Reduction of standstill and servicing times in the event of a fault thanks to the LED indicators:
 - Status of the AS-Interface network
 - Slaves connected and their readiness for operation
 - Monitoring of the AS-Interface mains voltage

- Lower costs for stock keeping and spare parts inventory because the CP can be used for the SIMATIC S7-300 and also for the ET 200M
- With CP 343-2P additionally: Improved plant documentation and support for service assignments thanks to a description of the AS-Interface configuration in the STEP 7 project
- No need for the AS-i power supply unit with AS-i Power24V: The AS-Interface cable is powered through an existing 24-V-DC-PELV power supply unit. For decoupling, an AS-i data decoupling module S22.5 is required (e.g. 3RK1901-1DE12-1AA0), see [Catalog IC10, Chapter 2 "Industrial Communication" → "AS-Interface" → "Power supply units and data decoupling modules"](#)
- Operation with AS-Interface power supply unit IP20 (see [Catalog IC10, Chapter 2 "Industrial Communication" → "AS-Interface" → "Power supply units and data decoupling modules"](#)) is also possible without restrictions.

Application

The CP 343-2P/CP 343-2 is the AS-Interface master connection for the SIMATIC S7-300 und ET 200M.

By connecting an AS-Interface, a max. of 248 DI/248 DO can be accessed per CP when using 62 A/B slaves with 4DI/4DO respectively.

The integrated analog processing function can be used to easily transfer analog signals (up to 62 A/B analog slaves with a max. of 2 channels each or up to 31 standard analog slaves, each with a max. of 4 channels per CP).

The CP 343-2P is an enhancement to the CP 343-2 and has exactly the same functions. An existing STEP 7 user program for a CP 343-2 can be used for a CP 343-2P without limitations. The two assemblies are merely configured differently in STEP 7 HW Config, whereby the CP 343-2P offers additional possibilities. We recommend the CP 343-2P for these reasons.

Design

The CP 343-2P / CP 343-2 is connected like an I/O module to the S7-300. It has:

- Two terminal connections for connecting the AS-Interface cable directly.
- LEDs in the front panel for indicating the operating state and functional readiness of all connected and active slaves
- Pushbuttons for switching over the master operating state and for adopting the existing ACTUAL configuration of the AS-i slave as the TARGET configuration

Function

The CP 343-2P / CP 343-2 supports all specified functions of the extended AS-Interface Specification V3.0.

The CP 343-2P / CP 343-2 each occupy 16 bytes in the I/O address area of the SIMATIC S7-300. The digital I/O data of the standard slaves and A slaves is saved in this area. The digital I/O data of the B slaves and the analog I/O data can be accessed with the S7 system functions for read/write data records.

If required, master calls can be performed with the command interface, e.g. read/write parameters, read/write configuration.

For more information see

<https://support.industry.siemens.com/cs/ww/en/view/51678777>.

SIMATIC S7-300 Advanced Controllers

I/O modules

Communication

CP 343-2P / CP 343-2

Overview (continued)

Notes on safety

In order to protect plants, systems, machines and networks against cyber threats, it is necessary to implement – and continuously maintain – a holistic, state-of-the-art industrial security concept. Siemens products and solutions only represent one component of such a concept.

For more information on the topic of Industrial Security, see <http://www.siemens.com/industrialsecurity>.

Configuration

All connected AS-Interface slaves are configured at the press of a button. No further configuration of the CP is required.

Additionally for CP 343-2P

The CP 343-2P also supports configuring of the AS-Interface network with STEP 7 V5.2 and higher. Specifying the AS-i configuration in HW-Config facilitates the setting of slave parameters and documentation of the plant. Uploading the ACTUAL configuration of an already configured AS-Interface network is also supported. The saved configuration cannot be overwritten at the press of a button and is therefore tamper-proof.

Ordering data

Article No.

CP 343-2P communications processor <ul style="list-style-type: none"> For connection of SIMATIC S7-300 and ET 200M to AS-Interface Configuration of the AS-i network using the SET key or STEP 7 (V5.2 and higher) Without front connector Corresponds to AS-Interface Specification V3.0 Dimensions (W x H x D / mm): 40 x 125 x 120 	6GK7343-2AH11-0XA0
CP 343-2 communications processor <ul style="list-style-type: none"> Basic version for connection of SIMATIC S7-300 and ET 200M to AS-Interface Configuration of the AS-i network using the SET key Without front connector Corresponds to AS-Interface Specification V3.0 Dimensions (W x H x D / mm): 40 x 125 x 120 	6GK7343-2AH01-0XA0
Accessories	
Front connector, 20-pin <ul style="list-style-type: none"> With screw-type terminals With spring-loaded terminals 	6ES7392-1AJ00-0AA0 6ES7392-1BJ00-0AA0
AS-interface addressing unit V3.0 <ul style="list-style-type: none"> For AS-Interface modules and sensors and actuators with integrated AS-Interface according to AS-i Specification V3.0 For setting the AS-i address of standard slaves, and slaves with extended addressing mode (A/B slaves) With input/output test function and many other commissioning functions Battery operation with four type AA batteries (IEC LR6, NEDA 15) Degree of protection IP40 Dimensions (W x H x D / mm): 84 x 195 x 35 Scope of supply: <ul style="list-style-type: none"> - Addressing unit with 4 batteries - Addressing cable, with M12 plug to addressing plug (hollow plug), length 1.5 m 	3RK1904-2AB02

Article No.

More information For manuals, see https://support.industry.siemens.com/cs/ww/en/ps/15754/man .	
For diagnostics during operation, diagnostics blocks with clearly arranged visualization on the SIMATIC HMI panel are available or can be downloaded free of charge via a web browser, see https://support.industry.siemens.com/cs/ww/en/view/61892138 .	
AS-Interface function block library for SIMATIC PCS 7 for easy connection of AS-Interface to PCS 7, see Catalog IC 10, Chapter 14, "Parameterization, Configuration and Visualization with SIRIUS".	

5

Overview



- PROFIBUS DP master or slave with electrical interface for connecting the SIMATIC S7-300 to PROFIBUS at up to 12 Mbps (including 45.45 Kbit/s)
- Communication services:
 - PROFIBUS DP
 - PG/OP communication (OP multiplexing)
 - S7 communication (client, server)
 - Open communication (SEND/RECEIVE)
- Easy configuration and programming over PROFIBUS
- Cross-network programming device communication through S7 routing
- Modules can be replaced without the need for a PG

DP-M	DP-S	FMS	PG/OP	S7/S5	
●	●		●	●	

Technical specifications

Article number	6GK7342-5DA03-0XE0
Product type designation	CP 342-5
Transmission rate	
Transfer rate	
• at the 1st interface acc. to PROFIBUS	9.6 kbit/s ... 12 Mbit/s
Interfaces	
Number of interfaces acc. to Industrial Ethernet	0
Number of electrical connections	
• at the 1st interface acc. to PROFIBUS	1
• for power supply	1
Type of electrical connection	
• at the 1st interface acc. to PROFIBUS	9-pin Sub-D socket (RS485)
• for power supply	4-pole terminal block
Supply voltage, current consumption, power loss	
Type of voltage of the supply voltage	DC
Supply voltage 1 from backplane bus	5 V
Supply voltage external	24 V
Supply voltage external at DC Rated value	24 V
Relative positive tolerance at DC at 24 V	20 %
Relative negative tolerance at DC at 24 V	15 %
Consumed current	
• from backplane bus at DC at 5 V typical	0.15 A
• from external supply voltage at DC at 24 V typical	0.25 A
Power loss [W]	6.75 W

Article number	6GK7342-5DA03-0XE0
Product type designation	CP 342-5
Permitted ambient conditions	
Ambient temperature	
• during operation	0 ... 60 °C
• during storage	-40 ... +70 °C
• during transport	-40 ... +70 °C
Relative humidity at 25 °C without condensation during operation maximum	95 %
Protection class IP	IP20
Design, dimensions and weight	
Module format	Compact module S7-300 single width
Width	40 mm
Height	125 mm
Depth	120 mm
Net weight	0.3 kg
Product properties, functions, components general	
Number of units	
• per CPU maximum	4
Performance data open communication	
Number of possible connections for open communication by means of SEND/RECEIVE blocks maximum	16
Amount of data	
• as user data per connection for open communication by means of SEND/RECEIVE blocks maximum	240 byte

SIMATIC S7-300 Advanced Controllers

I/O modules

Communication

CP 342-5

Technical specifications (continued)

Article number	6GK7342-5DA03-0XE0
Product type designation	CP 342-5
Performance data PROFIBUS DP	
Service as DP master	
• DPV0	Yes
Number of DP slaves on DP master usable	124
Amount of data	
• of the address area of the inputs as DP master total	2 160 byte
• of the address area of the outputs as DP master total	2 160 byte
• of the address area of the inputs per DP slave	244 byte
• of the address area of the outputs per DP slave	244 byte
• of the address area of the diagnostic data per DP slave	240 byte
Service as DP slave	
• DPV0	Yes
Amount of data	
• of the address area of the inputs as DP slave total	240 byte
• of the address area of the outputs as DP slave total	240 byte

Article number	6GK7342-5DA03-0XE0
Product type designation	CP 342-5
Performance data S7 communication	
Number of possible connections for S7 communication	
• maximum	16
Performance data multi-protocol mode	
Number of active connections with multi-protocol mode	
• without DP maximum	32
• with DP maximum	28
Performance data telecontrol	
Protocol is supported	
• TCP/IP	No
Configuration software	
• required	STEP 7 V5.1 SP2 or higher / STEP 7 Professional V12 (TIA Portal) or higher

Ordering data

Article No.	Article No.
CP 342-5 communications processor	6GK7342-5DA03-0XE0
Communications processor for electrical connection of SIMATIC S7-300 to PROFIBUS at up to 12 Mbps, with electronic manual on CD-ROM	
Accessories	
PROFIBUS FastConnect RS 485 connection plug	
With 90° cable outlet; insulation displacement technology, max. transmission rate 12 Mbps	
• Without PG interface	6ES7972-0BA52-0XA0
• With PG interface	6ES7972-0BB52-0XA0
PROFIBUS bus connector IP20	
With connection to PPI, MPI, PROFIBUS	
• Without PG interface	6ES7972-0BA12-0XA0
• With PG interface	6ES7972-0BB12-0XA0

Article No.

PROFIBUS FC Standard Cable	6XV1830-0EH10
2-wire bus cable, shielded, special design for fast mounting, delivery unit: max. 1000 m, minimum order 20 m, sold by the meter	
PROFIBUS bus terminal 12M	6GK1500-0AA10
Bus terminal for connection of PROFIBUS nodes up to 12 Mbps with connecting cable	
SIMATIC S7-300 DM 370	6ES7370-0AA01-0AA0
Dummy module; used for module replacement	

Note:

You can find order information for software for communication with PC systems in the IK PI catalog or in the Industry Mall.

Overview



DP-M	DP-S	FMS	PG/OP	S7/S5	
●	●		●	●	

- PROFIBUS DP master or slave with optical interface for connecting the SIMATIC S7-300 to PROFIBUS at up to 12 Mbps (including 45.45 Kbit/s)
- Direct connection to the optical PROFIBUS network over the integrated fiber-optic interface for plastic and PCF fiber-optic cables
- Communication services:
 - PROFIBUS DP
 - PG/OP communication (OP multiplexing)
 - S7 communication (client, server)
 - Open communication (SEND/RECEIVE)
- Easy configuration and programming over PROFIBUS
- Cross-network programming device communication through S7 routing
- Modules can be replaced without the need for a PG

5

Technical specifications

Article number	6GK7342-5DF00-0XE0
Product type designation	CP 342-5 FO
Transmission rate	
Transfer rate	
• at the 1st interface acc. to PROFIBUS	9.6 kbit/s ... 12 Mbit/s
Interfaces	
Number of interfaces acc. to Industrial Ethernet	0
Number of electrical connections	
• for power supply	1
Number of optical interfaces at the 1st interface acc. to PROFIBUS	2
Design of the optical interface at the 1st interface acc. to PROFIBUS	Duplex socket
Type of electrical connection	
• for power supply	4-pole terminal block
Supply voltage, current consumption, power loss	
Type of voltage of the supply voltage	DC
Supply voltage 1 from backplane bus	5 V
Supply voltage	24 V
Supply voltage external	24 V
Supply voltage external at DC Rated value	24 V
Relative positive tolerance at DC at 24 V	20 %
Relative negative tolerance at DC at 24 V	15 %
Consumed current	
• from backplane bus at DC at 5 V typical	0.15 A
• from external supply voltage at DC at 24 V typical	0.25 A
Power loss [W]	6 W

Article number	6GK7342-5DF00-0XE0
Product type designation	CP 342-5 FO
Permitted ambient conditions	
Ambient temperature	
• during operation	0 ... 60 °C
• during storage	-40 ... +70 °C
• during transport	-40 ... +70 °C
Relative humidity at 25 °C without condensation during operation maximum	95 %
Protection class IP	IP20
Design, dimensions and weight	
Module format	Compact module
Width	40 mm
Height	125 mm
Depth	120 mm
Net weight	0.3 kg
Mounting type	
• S7-300 rail mounting	Yes
Product properties, functions, components general	
Number of units	
• per CPU maximum	4
Wire length	
• for PCF FOC maximum	300 m
• for POF FOC maximum	50 m
Performance data open communication	
Number of possible connections for open communication by means of SEND/RECEIVE blocks maximum	16
Amount of data	
• as user data per connection for open communication by means of SEND/RECEIVE blocks maximum	240 byte

SIMATIC S7-300 Advanced Controllers

I/O modules

Communication

CP 342-5 FO

Technical specifications (continued)

Article number	6GK7342-5DF00-0XE0
Product type designation	CP 342-5 FO
Performance data PROFIBUS DP	
Service as DP master	
• DPV0	Yes
Number of DP slaves on DP master usable	124
Amount of data	
• of the address area of the inputs as DP master total	2 160 byte
• of the address area of the outputs as DP master total	2 160 byte
• of the address area of the inputs per DP slave	244 byte
• of the address area of the outputs per DP slave	244 byte
• of the address area of the diagnostic data per DP slave	240 byte
Service as DP slave	
• DPV0	Yes
Amount of data	
• of the address area of the inputs as DP slave total	240 byte
• of the address area of the outputs as DP slave total	240 byte

Article number	6GK7342-5DF00-0XE0
Product type designation	CP 342-5 FO
Performance data S7 communication	
Number of possible connections for S7 communication	
• maximum	16
Performance data multi-protocol mode	
Number of active connections with multi-protocol mode	
• without DP maximum	32
• with DP maximum	28
Performance data telecontrol	
Protocol is supported	
• TCP/IP	No
Configuration software	
• required	STEP 7 V5.1 SP2 or higher / STEP 7 Professional V12 (TIA Portal) or higher

Ordering data

Article No.

CP 342-5 FO communications processor

Communications processor for optical connection of SIMATIC S7-300 to PROFIBUS to 12 Mbps with electronic manual on CD-ROM

6GK7342-5DF00-0XE0

Accessories

PROFIBUS plastic fiber-optic, simplex connector/polishing set

100 simplex connectors and 5 polishing sets for assembling PROFIBUS plastic fiber optic cables for the optical PROFIBUS DP

6GK1901-0FB00-0AA0

Article No.

PROFIBUS plastic fiber-optic, stripping tool set

Tools for removing the outer sheath or core sheath of plastic fiber optic cables

6GK1905-6PA10

Note:

You can find order information for software for communication with PC systems in the Catalog IK PI or in the Industry Mall

Overview



Connection of SIMATIC S7-300 to PROFIBUS at up to 12 Mbps (including 45.45 Kbit/s)

- Communication services:
 - PG/OP communication
 - S7 communication
 - Open communication (SEND/RECEIVE)
 - PROFIBUS FMS
- Easy configuration and programming over PROFIBUS
- Can be easily integrated into the S7-300 system
- Cross-network programming device communication through S7 routing
- Modules can be replaced without the need for a PG

DP-M	DP-S	FMS	PG/OP	S7/S5	
		●	●	●	

Technical specifications

Article number	6GK7343-5FA01-0XE0
Product type designation	CP 343-5
Transmission rate	
Transfer rate	
• at the 1st interface acc. to PROFIBUS	9.6 kbit/s ... 12 Mbit/s
Interfaces	
Number of interfaces acc. to Industrial Ethernet	0
Number of electrical connections	
• at the 1st interface acc. to PROFIBUS	1
• for power supply	1
Type of electrical connection	
• at the 1st interface acc. to PROFIBUS	9-pin Sub-D socket (RS485)
• for power supply	4-pole terminal block
Supply voltage, current consumption, power loss	
Type of voltage of the supply voltage	DC
Supply voltage 1 from backplane bus	5 V
Supply voltage	24 V
Supply voltage external	24 V
Supply voltage external at DC Rated value	24 V
Relative positive tolerance at DC at 24 V	20 %
Relative negative tolerance at DC at 24 V	15 %
Consumed current	
• from backplane bus at DC at 5 V typical	0.15 A
• from external supply voltage at DC at 24 V typical	0.25 A
Power loss [W]	5 W

Article number	6GK7343-5FA01-0XE0
Product type designation	CP 343-5
Permitted ambient conditions	
Ambient temperature	
• during operation	0 ... 60 °C
• during storage	-40 ... +70 °C
• during transport	-40 ... +70 °C
Relative humidity at 25 °C without condensation during operation maximum	95 %
Protection class IP	IP20
Design, dimensions and weight	
Module format	Compact module S7-300 single width
Width	40 mm
Height	125 mm
Depth	120 mm
Net weight	0.3 kg
Mounting type	
• S7-300 rail mounting	Yes
Product properties, functions, components general	
Number of units	
• per CPU maximum	4
Performance data open communication	
Number of possible connections for open communication by means of SEND/RECEIVE blocks maximum	16
Amount of data	
• as user data per connection for open communication by means of SEND/RECEIVE blocks maximum	240 byte

SIMATIC S7-300 Advanced Controllers

I/O modules

Communication

CP 343-5**Technical specifications** (continued)

Article number	6GK7343-5FA01-0XE0
Product type designation	CP 343-5
Performance data FMS functions	
Number of possible connections for FMS connection maximum	16
Amount of data of the variables	
• for READ job maximum	237 byte
• for WRITE and REPORT job maximum	233 byte
Number of variables	
• Configurable from server to FMS partner	256
• Loadable from server to FMS partner	256
Performance data S7 communication	
Number of possible connections for S7 communication	
• maximum	16

Article number	6GK7343-5FA01-0XE0
Product type designation	CP 343-5
Performance data multi-protocol mode	
Number of active connections with multi-protocol mode	48
Performance data telecontrol	
Protocol is supported	
• TCP/IP	No
Configuration software	
• required	STEP 7 V5.1 SP3 or higher and NCM S7 for PROFIBUS

5

Ordering data**Article No.**

CP 343-5 communications processor
 Communications processor for connection of S7-300 to PROFIBUS, FMS, open communication, PG/OP and S7 communication; with electronic manual on CD-ROM

6GK7343-5FA01-0XE0**Accessories****STEP 7 Version 5.5**

See Chapter 11, page 11/17

PROFIBUS FastConnect RS 485 bus connector

With 90° cable outlet; insulation displacement technology, max. transfer rate 12 Mbps (1 unit)

- Without PG interface
- With PG interface

6ES7972-0BA52-0XA0
6ES7972-0BB52-0XA0
Article No.**PROFIBUS bus connector IP20**

With connection to PPI, MPI, PROFIBUS

- Without PG interface
- With PG interface

6ES7972-0BA12-0XA0
6ES7972-0BB12-0XA0
PROFIBUS bus terminal 12M

Bus terminal for connection of PROFIBUS nodes at up to 12 Mbps with connecting cable

6GK1500-0AA10**SIMATIC S7-300 DM 370**

Dummy module; used for module replacement

6ES7370-0AA01-0AA0

Overview



Communications processor for connecting a SIMATIC S7-300 to Industrial Ethernet networks, also as PROFINET IO device.

The CP supports:

- PG/OP communication
- S7 communication
- Open communication (SEND/RECEIVE)
- PROFINET communication

ISO	TCP/UDP	PN	MRP	IT	IP-R	PG/OP	S7/S5
	●	●	●			●	●

Technical specifications

Article number	6GK7343-1CX10-0XE0
Product type designation	CP 343-1 Lean
Transmission rate	
Transfer rate	
• at the 1st interface	10 ... 100 Mbit/s
Interfaces	
Number of interfaces acc. to Industrial Ethernet	2
Number of electrical connections	
• at the 1st interface acc. to Industrial Ethernet	2
• for power supply	1
Type of electrical connection	
• at the 1st interface acc. to Industrial Ethernet	RJ45 port
• of Industrial Ethernet interface	RJ45 port
• for power supply	2-pole plugable terminal block
Supply voltage, current consumption, power loss	
Type of voltage of the supply voltage	DC
Supply voltage 1 from backplane bus	5 V
Supply voltage	24 V
Supply voltage external	24 V
Supply voltage external at DC Rated value	24 V
Relative positive tolerance at DC at 24 V	20 %
Relative negative tolerance at DC at 24 V	15 %
Consumed current	
• from backplane bus at DC at 5 V typical	0.2 A
• from external supply voltage at DC at 24 V typical	0.16 A
• from external supply voltage at DC at 24 V maximum	0.2 A
Power loss [W]	5.8 W

Article number	6GK7343-1CX10-0XE0
Product type designation	CP 343-1 Lean
Permitted ambient conditions	
Ambient temperature	
• for vertical installation during operation	0 ... 40 °C
• for horizontally arranged busbars during operation	0 ... 60 °C
• during storage	-40 ... +70 °C
• during transport	-40 ... +70 °C
Relative humidity at 25 °C without condensation during operation maximum	95 %
Protection class IP	IP20
Design, dimensions and weight	
Module format	Compact module S7-300 single width
Width	40 mm
Height	125 mm
Depth	120 mm
Net weight	0.22 kg
Mounting type	
• S7-300 rail mounting	Yes

SIMATIC S7-300 Advanced Controllers

I/O modules

Communication

CP 343-1 Lean

Technical specifications (continued)

Article number	6GK7343-1CX10-0XE0
Product type designation	CP 343-1 Lean
Performance data open communication	
Number of possible connections for open communication by means of SEND/RECEIVE blocks maximum	8
Amount of data	
• as user data per ISO on TCP connection for open communication by means of SEND/RECEIVE blocks maximum	8 Kibyte
• as user data per TCP connection for open communication by means of SEND/RECEIVE blocks maximum	8 Kibyte
• as user data per UDP connection for open IE communication by means of SEND/RECEIVE blocks maximum	2 Kibyte
Number of Multicast stations	8
Performance data S7 communication	
Number of possible connections for S7 communication	
• maximum	4
Service	
• of SIMATIC communication as server	Yes
Performance data multi-protocol mode	
Number of active connections with multi-protocol mode	12
Performance data PROFINET communication as PN IO-Controller	
Product function PROFINET IO controller	No
Performance data PROFINET communication as PN IO-Device	
Product function PROFINET IO device	Yes
Amount of data	
• as user data for input variables as PROFINET IO device maximum	512 byte
• as user data for input variables as PROFINET IO device maximum	512 byte
• as user data for input variables for each sub-module as PROFINET IO device	240 byte
• as user data for input variables for each sub-module as PROFINET IO device	240 byte
• as user data for the consistency area for each sub-module	240 byte
Number of submodules per PROFINET IO-Device	32

Article number	6GK7343-1CX10-0XE0
Product type designation	CP 343-1 Lean
Performance data telecontrol	
Protocol is supported	
• TCP/IP	Yes
Product function MIB support	Yes
Protocol is supported	
• SNMP v1	Yes
• DCP	Yes
• LLDP	Yes
Configuration software	
• required	STEP 7 V5.4 or higher / STEP 7 Professional V11 (TIA Portal) or higher
Identification & maintenance function	
• I&M0 - device-specific information	Yes
• I&M1 - higher-level designation/location designation	Yes
Product functions Diagnosis	
Product function Web-based diagnostics	Yes
Product functions switch	
Product feature Switch	Yes
Product function	
• switch-managed	No
• with IRT PROFINET IO switch	No
• Configuration with STEP 7	Yes
Product functions Redundancy	
Product function	
• Ring redundancy	Yes
• Redundancy manager	No
• Parallel Redundancy Protocol (PRP) operation in the PRP-network	Yes
Protocol is supported Media Redundancy Protocol (MRP)	Yes
Product functions Security	
Product function	
• password protection for Web applications	No
• ACL - IP-based	Yes
• ACL - IP-based for PLC/routing	No
• switch-off of non-required services	Yes
• Blocking of communication via physical ports	Yes
• log file for unauthorized access	No
Product functions Time	
Product function SICLOCK support	Yes
Product function pass on time synchronization	Yes
Protocol is supported	
• NTP	Yes

Ordering data	Article No.	Accessories	Article No.
<p>CP 343-1 Lean communications processor</p> <p>For connecting SIMATIC S7-300 to Industrial Ethernet through TCP/IP and UDP, Multicast, S7 communication, open communication (SEND/RECEIVE), FETCH/WRITE, PROFINET IO device, MRP, integrated 2-port switch ERTEC, comprehensive diagnostics facilities, module replacement without PG, SNMP, initial commissioning over LAN; with electronic manual on CD-ROM</p>	<p>6GK7343-1CX10-0XE0</p>	<p>IE FC RJ45 Plug 145</p> <p>RJ45 plug connector 2 x 2 for Industrial Ethernet with a rugged metal enclosure and integrated insulation displacement contacts for connecting Industrial Ethernet FC installation cables; with 145° cable outlet</p> <ul style="list-style-type: none"> • 1 pack = 1 unit • 1 pack = 10 units • 1 pack = 50 units <p>IE FC TP Standard Cable GP 2 x 2 (Type A)</p> <p>4-wire, shielded TP installation cable for connection to IE FC Outlet RJ45/IE FC RJ45 Plug; PROFINET-compatible; with UL approval; sold by the meter; max. length 1000 m, minimum order quantity 20 m</p> <p>IE FC Stripping Tool</p> <p>Preadjusted stripping tool for fast stripping of the Industrial Ethernet FC cables</p> <p>CSM 377 Compact Switch Module</p> <p>Unmanaged switch for connection of a SIMATIC S7-300 CPU, ET 200M, and up to three further nodes to Industrial Ethernet operating at 10/100 Mbps; 4 x RJ45 ports; external 24 V DC power supply, LED diagnostics, S7-300 module including electronic manual on CD-ROM</p>	<p>6GK1901-1BB30-0AA0</p> <p>6GK1901-1BB30-0AB0</p> <p>6GK1901-1BB30-0AE0</p> <p>6XV1840-2AH10</p> <p>6GK1901-1GA00</p> <p>6GK7377-1AA00-0AA0</p>

Note:

You can find order information for software for communication with PC systems in the Catalog IK PI or in the Industry Mall.

SIMATIC S7-300 Advanced Controllers

I/O modules

Communication

CP 343-1

Overview



Communications processor for connecting a SIMATIC S7-300/SINUMERIK 840D powerline to Industrial Ethernet networks, also as PROFINET IO controller or IO device.

The CP supports:

- PG/OP communication
- S7 communication
- Open communication (SEND/RECEIVE)
- PROFINET communication

ISO	TCP/UDP	PN	MRP	IT	IP-R	PG/OP	S7/S5
●	●	●	●			●	●

Technical specifications

Article number	6GK7343-1EX30-0XE0
Product type designation	CP 343-1
Transmission rate	
Transfer rate	
• at the 1st interface	10 ... 100 Mbit/s
Interfaces	
Number of interfaces acc. to Industrial Ethernet	2
Number of electrical connections	
• at the 1st interface acc. to Industrial Ethernet	2
• for power supply	1
Type of electrical connection	
• at the 1st interface acc. to Industrial Ethernet	RJ45 port
• of Industrial Ethernet interface	RJ45 port
• for power supply	2-pole plugable terminal block
Supply voltage, current consumption, power loss	
Type of voltage of the supply voltage	DC
Supply voltage 1 from backplane bus	5 V
Supply voltage	24 V
Supply voltage external	24 V
Supply voltage external at DC Rated value	24 V
Relative positive tolerance at DC at 24 V	20 %
Relative negative tolerance at DC at 24 V	15 %
Consumed current	
• from backplane bus at DC at 5 V typical	0.2 A
• from external supply voltage at DC at 24 V typical	0.16 A
• from external supply voltage at DC at 24 V maximum	0.2 A
Power loss [W]	5.8 W

Article number	6GK7343-1EX30-0XE0
Product type designation	CP 343-1
Permitted ambient conditions	
Ambient temperature	
• for vertical installation during operation	0 ... 40 °C
• for horizontally arranged busbars during operation	0 ... 60 °C
• during storage	-40 ... +70 °C
• during transport	-40 ... +70 °C
Relative humidity at 25 °C without condensation during operation maximum	95 %
Protection class IP	IP20
Design, dimensions and weight	
Module format	Compact module S7-300 single width
Width	40 mm
Height	125 mm
Depth	120 mm
Net weight	0.22 kg
Mounting type	
• S7-300 rail mounting	Yes
Performance data open communication	
Number of possible connections for open communication by means of SEND/RECEIVE blocks maximum	16
Amount of data	
• as user data per ISO connection for open communication by means of SEND/RECEIVE blocks maximum	8 Kibyte
• as user data per ISO on TCP connection for open communication by means of SEND/RECEIVE blocks maximum	8 Kibyte
• as user data per TCP connection for open communication by means of SEND/RECEIVE blocks maximum	8 Kibyte
• as user data per UDP connection for open IE communication by means of SEND/RECEIVE blocks maximum	2 Kibyte
Number of Multicast stations	16

Technical specifications (continued)

Article number	6GK7343-1EX30-0XE0
Product type designation	CP 343-1
Performance data S7 communication	
Number of possible connections for S7 communication	
• maximum	16
Performance data multi-protocol mode	
Number of active connections with multi-protocol mode	32
Performance data PROFINET communication as PN IO-Controller	
Number of PN IO devices on PROFINET IO controller usable total	32
Number of external PN IO lines with PROFINET per rack	1
Amount of data	
• as user data for input variables as PROFINET IO controller maximum	1 Kibyte
• as user data for input variables as PROFINET IO controller maximum	1 Kibyte
• as user data for input variables per PN IO device as PROFINET IO controller maximum	1 433 byte
• as user data for output variables per PN IO device as PROFINET IO controller maximum	1 433 byte
• as user data for input variables per PN IO device for each sub-module as PROFINET IO controller maximum	240 byte
• as user data for output variables per PN IO device for each sub-module as PROFINET IO controller maximum	240 byte
Performance data PROFINET communication as PN IO-Device	
Product function PROFINET IO device	Yes
Amount of data	
• as user data for input variables as PROFINET IO device maximum	512 byte
• as user data for input variables as PROFINET IO device maximum	512 byte
• as user data for input variables for each sub-module as PROFINET IO device	240 byte
• as user data for input variables for each sub-module as PROFINET IO device	240 byte
• as user data for the consistency area for each sub-module	240 byte
Number of submodules per PROFINET IO-Device	32

Article number	6GK7343-1EX30-0XE0
Product type designation	CP 343-1
Performance data telecontrol	
Protocol is supported	
• TCP/IP	Yes
Product function MIB support	Yes
Protocol is supported	
• SNMP v1	Yes
• DCP	Yes
• LLDP	Yes
Configuration software	
• required	STEP 7 V5.4 SP2 or higher / STEP 7 Professional V11 (TIA Portal) or higher
Identification & maintenance function	
• I&M0 - device-specific information	Yes
• I&M1 - higher-level designation/location designation	Yes
Product functions Diagnosis	
Product function Web-based diagnostics	Yes
Product functions switch	
Product feature Switch	Yes
Product function	
• switch-managed	No
• with IRT PROFINET IO switch	Yes
• Configuration with STEP 7	Yes
Product functions Redundancy	
Product function	
• Ring redundancy	Yes
• Redundancy manager	No
• Parallel Redundancy Protocol (PRP) operation in the PRP-network	Yes
Protocol is supported Media Redundancy Protocol (MRP)	Yes
Product functions Security	
Product function	
• password protection for Web applications	No
• ACL - IP-based	Yes
• ACL - IP-based for PLC/routing	No
• switch-off of non-required services	Yes
• Blocking of communication via physical ports	Yes
• log file for unauthorized access	No
Product functions Time	
Product function SICLOCK support	Yes
Product function pass on time synchronization	Yes
Protocol is supported	
• NTP	Yes

SIMATIC S7-300 Advanced Controllers

I/O modules

Communication

CP 343-1

Ordering data**Article No.****Article No.****CP 343-1 communications processor**

For connection of SIMATIC S7-300 to Industrial Ethernet over ISO and TCP/IP; PROFINET IO controller or PROFINET IO device, MRP, integrated 2-port switch ERTEC; S7 communication, open communication (SEND/RECEIVE), FETCH/WRITE, with and without RFC 1006, multicast, DHCP, CPU clock synchronization via SIMATIC procedure and NTP, diagnostics, SNMP, access protection through IP access list, initialization over LAN 10/100 Mbps; with electronic manual on DVD

6GK7343-1EX30-0XE0**IE FC TP Standard Cable GP 2 x 2 (Type A)**

4-wire, shielded TP installation cable for connection to IE FC Outlet RJ45/IE FC RJ45 Plug; PROFINET-compatible; with UL approval; sold by the meter; max. length 1000 m, minimum order quantity 20 m

6XV1840-2AH10**Accessories****IE FC RJ45 Plug 180 2 x 2**

RJ45 plug connector for Industrial Ethernet with a rugged metal enclosure and integrated insulation displacement contacts for connecting Industrial Ethernet FC installation cables; with 180° cable outlet; for network components and CPs/CPUs with Industrial Ethernet interface

- 1 pack = 1 unit
- 1 pack = 10 units
- 1 pack = 50 units

6GK1901-1BB10-2AA0
6GK1901-1BB10-2AB0
6GK1901-1BB10-2AE0

IE FC Stripping Tool

Preadjusted stripping tool for fast stripping of the Industrial Ethernet FC cables

6GK1901-1GA00**CSM 377 Compact Switch Module**

Unmanaged switch for connection of a SIMATIC S7-300 CPU, ET 200M, and up to three further nodes to Industrial Ethernet operating at 10/100 Mbps; 4 x RJ45 ports; external 24 V DC power supply, LED diagnostics, S7-300 module including electronic manual on CD-ROM

6GK7377-1AA00-0AA0**SCALANCE X204-2 Industrial Ethernet switch**

Industrial Ethernet switches with integral SNMP access, web diagnostics, copper cable diagnostics and PROFINET diagnostics for configuring line, star and ring topologies; four 10/100 Mbps RJ45 ports and two FO ports

6GK5204-2BB10-2AA3**IE FC RJ45 Plug 145**

RJ45 plug connector 2 x 2 for Industrial Ethernet with a rugged metal enclosure and integrated insulation displacement contacts for connecting Industrial Ethernet FC installation cables; with 145° cable outlet

- 1 pack = 1 unit
- 1 pack = 10 units
- 1 pack = 50 units

6GK1901-1BB30-0AA0
6GK1901-1BB30-0AB0
6GK1901-1BB30-0AE0

Note:

You can find order information for software for communication with PC systems in the Catalog IK PI or in the Industry Mall.

5

Overview



ISO	TCP/UDP	PN	MRP	IT	IP-R	PG/OP	S7/S5
●	●	●	●	●	●	●	●

Communications processor for connecting the SIMATIC S7-300/SINUMERIK 840D powerline to Industrial Ethernet networks, also as PROFINET IO controller and IO device.

The CP supports:

- PG/OP communication
- S7 communication
- Open communication (SEND/RECEIVE)
- PROFINET communication
- IT communication
- Security functionality, firewall and VPN

In addition, the CP 343-1 Advanced provides email functions and allows users to create their own Web pages - ideal support for maintenance and quality assurance. The Internet functions such as FTP even allow connection to the most diverse PC-based systems. This CP is therefore the bridge between the field level and the management level for the S7-300. The CP 343-1 Advanced connects seamlessly to the security structures of the office and IT world.

Technical specifications

Article number	6GK7343-1GX31-0XE0
Product type designation	CP 343-1 Advanced
Transmission rate	
Transfer rate	
• at the 1st interface	10 ... 1 000 Mbit/s
• at the 2nd interface	10 ... 100 Mbit/s
Interfaces	
Number of interfaces acc. to Industrial Ethernet	3
Number of electrical connections	
• at the 1st interface acc. to Industrial Ethernet	1
• at the 2nd interface acc. to Industrial Ethernet	2
• for power supply	1
Type of electrical connection	
• at the 1st interface acc. to Industrial Ethernet	RJ45 port
• at the 2nd interface acc. to Industrial Ethernet	RJ45 port
• for power supply	2-pole plugable terminal block design of the removable storage C-PLUG
Yes	
Supply voltage, current consumption, power loss	
Type of voltage of the supply voltage	DC
Supply voltage 1 from backplane bus	5 V
Supply voltage external	24 V
Supply voltage external at DC Rated value	24 V
Relative positive tolerance at DC at 24 V	20 %
Relative negative tolerance at DC at 24 V	15 %

Article number	6GK7343-1GX31-0XE0
Product type designation	CP 343-1 Advanced
Consumed current	
• from backplane bus at DC at 5 V typical	0.14 A
• from external supply voltage at DC at 24 V typical	0.48 A
• from external supply voltage at DC at 24 V maximum	0.62 A
Power loss [W]	14.7 W
Permitted ambient conditions	
Ambient temperature	
• for vertical installation during operation	0 ... 40 °C
• for horizontally arranged busbars during operation	0 ... 60 °C
• during storage	-40 ... +70 °C
• during transport	-40 ... +70 °C
Relative humidity at 25 °C without condensation during operation maximum	95 %
Protection class IP	IP20
Design, dimensions and weight	
Module format	Compact module
Width	80 mm
Height	125 mm
Depth	120 mm
Net weight	0.8 kg
Mounting type	
• S7-300 rail mounting	Yes

SIMATIC S7-300 Advanced Controllers

I/O modules

Communication

CP 343-1 Advanced

Technical specifications (continued)

Article number	6GK7343-1GX31-0XE0
Product type designation	CP 343-1 Advanced
Performance data open communication	
Number of possible connections for open communication by means of SEND/RECEIVE blocks maximum	16
Amount of data	
• as user data per ISO connection for open communication by means of SEND/RECEIVE blocks maximum	8 Kibyte
• as user data per ISO on TCP connection for open communication by means of SEND/RECEIVE blocks maximum	8 Kibyte
• as user data per TCP connection for open communication by means of SEND/RECEIVE blocks maximum	8 Kibyte
• as user data per UDP connection for open IE communication by means of SEND/RECEIVE blocks maximum	2 Kibyte
Number of Multicast stations	16
Performance data S7 communication	
Number of possible connections for S7 communication	
• maximum	16
Performance data multi-protocol mode	
Number of active connections with multi-protocol mode	48
Performance data IT functions	
Number of possible connections	
• as client by means of FTP maximum	10
• as server by means of FTP maximum	2
• as server by means of HTTP maximum	4
• as e-mail client maximum	1
Amount of data as user data for email maximum	8 Kibyte
Storage capacity of the user memory	
• as flash memory file system	28 Mibyte
• as RAM	30 Mibyte
Number of possible write cycles of the flash memory cells	100 000
Performance data PROFINET communication as PN IO-Controller	
Product function PROFINET IO controller	Yes
Number of PN IO devices on PROFINET IO controller usable total	128
Number of PN IO IRT devices on PROFINET IO controller usable	128
Number of external PN IO lines with PROFINET per rack	1
Amount of data	
• as user data for input variables as PROFINET IO controller maximum	4 Kibyte
• as user data for input variables as PROFINET IO controller maximum	4 Kibyte
• as user data for input variables per PN IO device as PROFINET IO controller maximum	1 433 byte
• as user data for output variables per PN IO device as PROFINET IO controller maximum	1 433 byte
• as user data for input variables per PN IO device for each sub-module as PROFINET IO controller max.	240 byte
• as user data for output variables per PN IO device for each sub-module as PROFINET IO controller max.	240 byte

Article number	6GK7343-1GX31-0XE0
Product type designation	CP 343-1 Advanced
Performance data PROFINET communication as PN IO-Device	
Product function PROFINET IO device	Yes
Amount of data	
• as user data for input variables as PROFINET IO device maximum	1 024 byte
• as user data for input variables as PROFINET IO device maximum	1 024 byte
• as user data for input variables for each sub-module as PROFINET IO device	240 byte
• as user data for input variables for each sub-module as PROFINET IO device	240 byte
• as user data for the consistency area for each sub-module	240 byte
Number of submodules per PROFINET IO-Device	32
Performance data PROFINET CBA	
Number of remote connection partners with PROFINET CBA	64
Number of connections with PROFINET CBA total	1 000
Amount of data	
• as user data for digital inputs with PROFINET CBA maximum	8 Kibyte
• as user data for digital outputs with PROFINET CBA maximum	8 Kibyte
• as user data for arrays and data types in the case of acyclic transmission with PROFINET CBA maximum	8 Kibyte
• as user data for arrays and data types with PROFINET CBA with cyclical transfer maximum	250 byte
• as user data for arrays and data types with PROFINET CBA in the case of local interconnection maximum	2 400 byte
Performance data PROFINET CBA remote connection with acyclic transmission	
Refresh time of the remote interconnections in the case of acyclic transmission with PROFINET CBA	100 ms
Number of remote connections to input variables in the case of acyclic transmission with PROFINET CBA maximum	128
Number of remote connections to output variables in the case of acyclic transmission with PROFINET CBA maximum	128
Amount of data	
• as user data for remote interconnections with input variables in the case of acyclic transmission with PROFINET CBA	8 Kibyte
• as user data for remote interconnections with output variables in the case of acyclic transmission with PROFINET CBA	8 Kibyte

Technical specifications (continued)

Article number	6GK7343-1GX31-0XE0	Article number	6GK7343-1GX31-0XE0
Product type designation	CP 343-1 Advanced	Product type designation	CP 343-1 Advanced
Performance data PROFINET CBA remote connection with cyclic transmission		Performance data telecontrol	
Refresh time of the remote interconnections with PROFINET CBA with cyclical transfer	8 ms	Protocol is supported	
Number of remote connections to input variables with PROFINET CBA with cyclical transfer maximum	200	• TCP/IP	Yes
Number of remote connections to output variables with PROFINET CBA with cyclical transfer maximum	200	Product function MIB support	Yes
Amount of data		Protocol is supported	
• as user data for remote interconnections with input variables with PROFINET CBA with cyclical transfer maximum	2 000 byte	• SNMP v1	Yes
• as user data for remote interconnections with output variables with PROFINET CBA with cyclical transfer maximum	2 000 byte	• SNMP v3	Yes
		• DCP	Yes
		• LLDP	Yes
		Configuration software	
		• required	STEP7 V5.5 SP2 HF1 or higher / STEP 7 Professional V12 (TIA Portal) or higher
		• for PROFINET CBA required	SIMATIC iMap V3.0 SP4 and higher
Performance data PROFINET CBA HMI variables via PROFINET acyclic		Identification & maintenance function	
Number of connectable HMI stations for HMI variables in the case of acyclic transmission with PROFINET CBA	3	• I&MO - device-specific information	Yes
Refresh time of the HMI variables in the case of acyclic transmission with PROFINET CBA	500 ms	• I&M1 - higher-level designation/ location designation	Yes
Number of HMI variables in the case of acyclic transmission with PROFINET CBA maximum	200		
Amount of data as user data for HMI variables in the case of acyclic transmission with PROFINET CBA maximum	8 Kibyte	Product functions Diagnosis	
		Product function Web-based diagnostics	Yes
Performance data PROFINET CBA device-internal connections		Product functions switch	
Number of internal connections with PROFINET CBA maximum	256	Product feature Switch	Yes
Amount of data of the internal connections with PROFINET CBA maximum	2 400 byte	Product function	
		• switch-managed	No
		• with IRT PROFINET IO switch	Yes
		• Configuration with STEP 7	Yes
Performance data PROFINET CBA connections to constants		Product functions Redundancy	
Number of connections with constants with PROFINET CBA maximum	200	Product function	
Amount of data as user data for interconnections with constants with PROFINET CBA maximum	4 096 byte	• Ring redundancy	Yes
		• Redundancy manager	Yes
		• Parallel Redundancy Protocol (PRP)/ operation in the PRP-network	Yes
		Protocol is supported Media Redundancy Protocol (MRP)	Yes
Performance data PROFINET CBA PROFIBUS proxy functionality		Product functions Security	
Product function with PROFINET CBA PROFIBUS proxy functionality	No	Firewall version	stateful inspection
		Product function with VPN connection	IPSec
		Type of encryption algorithms with VPN connection	AES-256, AES-192, AES-128, 3DES-168, DES-56
		Type of authentication procedure with VPN connection	Preshared key (PSK), X.509v3 certificates
		Type of hashing algorithms with VPN connection	MD5, SHA-1
		Number of possible connections with VPN connection	32
		Product function	
		• password protection for Web applications	Yes
		• ACL - IP-based	Yes
		• ACL - IP-based for PLC/routing	Yes
		• switch-off of non-required services	Yes
		• Blocking of communication via physical ports	Yes
		• log file for unauthorized access	No
		Product functions Time	
		Product function SICLOCK support	Yes
		Product function pass on time synchronization	Yes
		Protocol is supported	
		• NTP	Yes

SIMATIC S7-300 Advanced Controllers

I/O modules

Communication

CP 343-1 Advanced

Ordering data

CP 343-1 Advanced communications processor

For connecting the SIMATIC S7-300 CPU to Industrial Ethernet; 1 x 10/100/1000 Mbps; 2 x 10/100 Mbps (IE switch); RJ 45 ports; TCP; UDP; ISO; PROFINET IO controller and device; S7 communication (client + server); open communication (SEND/RECEIVE); S7 routing; IP configuration via DHCP/block; extended web diagnostics; time synchronization; IP Access Control List; IP routing; FTP; email; PROFINET CBA; C-Plug

- With Security (Firewall + VPN) and PROFinergy (Controller + Device)

Article No.

6GK7343-1GX31-0XE0

Accessories**IE FC RJ45 Plug 180 2 x 2**

RJ45 plug connector for Industrial Ethernet with a rugged metal enclosure and integrated insulation displacement contacts for connecting Industrial Ethernet FC installation cables; with 180° cable outlet; for network components and CPs/CPUs with Industrial Ethernet interface

- 1 pack = 1 unit
- 1 pack = 10 units
- 1 pack = 50 units

6GK1901-1BB10-2AA0
6GK1901-1BB10-2AB0
6GK1901-1BB10-2AE0

IE FC RJ45 Plug 145

RJ45 plug connector 2 x 2 for Industrial Ethernet with a rugged metal enclosure and integrated insulation displacement contacts for connecting Industrial Ethernet FC installation cables; with 145° cable outlet

- 1 pack = 1 unit
- 1 pack = 10 units
- 1 pack = 50 units

6GK1901-1BB30-0AA0
6GK1901-1BB30-0AB0
6GK1901-1BB30-0AE0

IE FC RJ45 Plug 4 x 2

RJ45 plug connector for Industrial Ethernet (10/100/1000 Mbps) with a sturdy metal enclosure and integrated insulation displacement contacts for connecting Industrial Ethernet FC installation cables; 180° cable outlet; for network components and CPs/CPUs with Industrial Ethernet interface

- 1 pack = 1 unit
- 1 pack = 10 units
- 1 pack = 50 units

6GK1901-1BB11-2AA0
6GK1901-1BB11-2AB0
6GK1901-1BB11-2AE0

Article No.

IE FC TP Standard Cable GP 2 x 2 (Type A)

4-wire, shielded TP installation cable for connection to IE FC Outlet RJ45/IE FC RJ45 Plug; PROFINET-compatible; with UL approval; sold by the meter; max. length 1000 m, minimum order quantity 20 m

6XV1840-2AH10

IE FC TP Standard Cable GP 4 x 2

8-wire, shielded TP installation cable for connection to IE FC RJ45 Modular Outlet for universal applications; with UL approval; sold by the meter; max. quantity 1000 m, minimum order 20 m

6XV1870-2E

- AWG22, for connection to IE FC RJ45 Modular Outlet
- AWG24, for connection to IE FC RJ45 Plug 4 x 2

6XV1878-2A

IE FC Stripping Tool

Preadjusted stripping tool for fast stripping of the Industrial Ethernet FC cables

6GK1901-1GA00

CSM 377 Compact Switch Module

Unmanaged switch for connection of a SIMATIC S7-300 CPU, ET 200M, and up to three further nodes to Industrial Ethernet operating at 10/100 Mbps; 4 x RJ45 ports; external 24 V DC power supply, LED diagnostics, S7-300 module including electronic manual on CD-ROM

6GK7377-1AA00-0AA0

Industrial Ethernet switch SCALANCE X204-2

Industrial Ethernet switches with integral SNMP access, web diagnostics, copper cable diagnostics and PROFINET diagnostics for configuring line, star and ring topologies; four 10/100 Mbps RJ45 ports and two FO ports

6GK5204-2BB10-2AA3

Industrial Ethernet switch SCALANCE X308-2

2 x 1000 Mbps SC ports, optical (multimode, glass), up to 750 m 1 x 10/100/1000 Mbps RJ45 port, electrical 7 x 10/100 Mbps RJ45 ports, electrical

6GK5308-2FL10-2AA3

Note:

You can find order information for software for communication with PC systems in the Catalog IK PI or in the Industry Mall.

Overview



ERPC	TCP/UDP	PN	MRP	IT	IP-R	PG/OP	S7/S5
●	●					●	●

The CP 343-1 ERPC (Enterprise Connect) communications processor for connecting a SIMATIC S7-300 to Industrial Ethernet networks.

The CP supports:

- PG/OP communication
- S7 communication
- Open communication (SEND/RECEIVE)
- ERPC communication

Connection of the SIMATIC S7-300 to various database systems for vertical integration is supported by means of a firmware expansion from ILS-Technology to be ordered separately.

Technical specifications

Article number	6GK7343-1FX00-0XE0
Product type designation	CP 343-1 ERPC
Transmission rate	
Transfer rate	
• at the 1st interface	10 ... 1 000 Mbit/s
Interfaces	
Number of interfaces acc. to Industrial Ethernet	1
Number of electrical connections	
• at the 1st interface acc. to Industrial Ethernet	1
• for power supply	1
Type of electrical connection	
• at the 1st interface acc. to Industrial Ethernet	RJ45 port
• for power supply	2-pole plugable terminal block
design of the removable storage C-PLUG	Yes
Supply voltage, current consumption, power loss	
Type of voltage of the supply voltage	DC
Supply voltage 1 from backplane bus	5 V
Supply voltage external	24 V
Supply voltage external at DC Rated value	24 V
Relative positive tolerance at DC at 24 V	20 %
Relative negative tolerance at DC at 24 V	15 %
Consumed current	
• from backplane bus at DC at 5 V typical	0.3 A
• from external supply voltage at DC at 24 V typical	0.16 A
• from external supply voltage at DC at 24 V maximum	0.6 A
Power loss [W]	14.7 W

Article number	6GK7343-1FX00-0XE0
Product type designation	CP 343-1 ERPC
Permitted ambient conditions	
Ambient temperature	
• for vertical installation during operation	0 ... 40 °C
• for horizontally arranged busbars during operation	0 ... 60 °C
• during storage	-40 ... +70 °C
• during transport	-40 ... +70 °C
Relative humidity at 25 °C without condensation during operation maximum	95 %
Protection class IP	IP20
Design, dimensions and weight	
Module format	Compact module S7-300 double width
Width	80 mm
Height	125 mm
Depth	120 mm
Net weight	0.8 kg
Mounting type	
• S7-300 rail mounting	Yes
Performance data open communication	
Number of possible connections for open communication by means of SEND/RECEIVE blocks maximum	8
Amount of data	
• as user data per ISO on TCP connection for open communication by means of SEND/RECEIVE blocks maximum	8 Kibyte
• as user data per TCP connection for open communication by means of SEND/RECEIVE blocks maximum	8 Kibyte
• as user data per UDP connection for open IE communication by means of SEND/RECEIVE blocks maximum	2 Kibyte
Number of Multicast stations	8

SIMATIC S7-300 Advanced Controllers

I/O modules

Communication

CP 343-1 ERPC

Technical specifications (continued)

Article number	6GK7343-1FX00-0XE0
Product type designation	CP 343-1 ERPC
Performance data S7 communication	
Number of possible connections for S7 communication	8
<ul style="list-style-type: none"> • maximum • Note 	also 2 PG/OP connections and 1 diagnostics connection
Performance data multi-protocol mode	
Number of active connections with multi-protocol mode	32
Performance data IT functions	
Number of possible connections	4
<ul style="list-style-type: none"> • as server by means of HTTP maximum 	
Number of possible write cycles of the flash memory cells	100 000
Performance data ERPC functions	
Number of possible connections for communication with ERP or MES stations maximum	8
Number of possible logical triggers per CP maximum	8
Number of configurable ERPC symbols for database access	
<ul style="list-style-type: none"> • per CPU maximum • per logical trigger maximum 	2 000 255
Amount of data as user data and header information per logical trigger	8 Kibyte
Performance data telecontrol	
Protocol is supported	
<ul style="list-style-type: none"> • TCP/IP 	Yes
Product function MIB support	Yes
Protocol is supported	
<ul style="list-style-type: none"> • SNMP v1 • DCP • LLDP 	Yes Yes Yes
Configuration software	
<ul style="list-style-type: none"> • required 	STEP 7 V5.4 SP5 + HSP or higher
Identification & maintenance function	
<ul style="list-style-type: none"> • I&MO - device-specific information • I&M1 – higher-level designation/location designation 	Yes Yes

Article number	6GK7343-1FX00-0XE0
Product type designation	CP 343-1 ERPC
Product functions Diagnosis	
Product function Web-based diagnostics	Yes
Product functions switch	
Product feature Switch	No
Product functions Redundancy	
Product function	
<ul style="list-style-type: none"> • Ring redundancy 	No
Product functions Security	
Product function	
<ul style="list-style-type: none"> • password protection for Web applications • ACL - IP-based • ACL - IP-based for PLC/routing • switch-off of non-required services • Blocking of communication via physical ports • log file for unauthorized access 	No Yes No Yes Yes No
Product functions Time	
Product function SICLOCK support	Yes
Product function pass on time synchronization	Yes
Protocol is supported	
<ul style="list-style-type: none"> • NTP 	Yes

5

Ordering data	Article No.	Article No.
<p>CP 343-1 ERPC (Enterprise Connect) communications processor</p> <p>For the connection of SIMATIC S7-300 to Industrial Ethernet and for the support of the database connection of the SIMATIC S7-300 to various databases; TCP/UDP, S7 communication, open communication (SEND/RECEIVE), with and without RFC 1006, multicast, web server, setting of CPU's clock using SIMATIC procedures and NTP, access protection via IP access list, SNMP, DHCP, initialization over LAN 10/100/1000 Mbps; with electronic manual on DVD, C-PLUG included in scope of delivery</p>	<p>6GK7343-1FX00-0XE0</p>	<p>Accessories</p> <p>IE FC RJ45 Plug 4 x 2</p> <p>RJ45 plug connector for Industrial Ethernet (10/100/1000 Mbps) with a sturdy metal enclosure and integrated insulation displacement contacts for connecting Industrial Ethernet FC installation cables; 180° cable outlet; for network components and CPs/CPU's with Industrial Ethernet interface</p> <ul style="list-style-type: none"> • 1 pack = 1 unit • 1 pack = 10 units • 1 pack = 50 units <p>6GK1901-1BB11-2AA0 6GK1901-1BB11-2AB0 6GK1901-1BB11-2AE0</p>
<p>deviceWISE Embedded Edition for SIMATIC S7</p> <p>Firmware expansion for database connection of the SIMATIC S7-300 complete with CP 343-1 ERPC to various ERP or MES systems</p>	<p>See Catalog IK PI 2015, Partner solutions / deviceWISE Embedded Edition for SIMATIC S7</p>	<p>IE FC TP Standard Cable GP 4 x 2</p> <p>8-wire, shielded TP installation cable for connection to IE FC RJ45 Modular Outlet for universal applications; with UL approval; sold by the meter; max. quantity 1000 m, minimum order 20 m</p> <ul style="list-style-type: none"> • AWG22, for connection to IE FC RJ45 Modular Outlet • AWG24, for connection to IE FC RJ45 Plug 4 x 2 <p>6XV1870-2E 6XV1878-2A</p> <p>IE FC Stripping Tool</p> <p>Preadjusted stripping tool for fast stripping of the Industrial Ethernet FC cables</p> <p>6GK1901-1GA00</p> <p>Industrial Ethernet switch SCALANCE X308-2</p> <p>2 x 1000 Mbps SC ports, optical (multimode, glass), up to 750 m, 1 x 10/100/1000 Mbps RJ45 port, electrical 7 x 10/100 Mbps RJ45 ports, electrical</p> <p>6GK5308-2FL10-2AA3</p>

Note:

You can find order information for software for communication with PC systems in the Catalog IK PI or in the Industry Mall.

SIMATIC S7-300 Advanced Controllers

I/O modules

Communication

CSM 377 unmanaged

Overview



- Unmanaged switch for the connection of a SIMATIC S7-300 with integral PROFINET interface or with an Industrial Ethernet CP or ET 200M to an Industrial Ethernet in an electrical linear, tree or star structure
- As many as three additional nodes can be connected
- As an unmanaged switch, the CSM 377 is used for integrating small machines into existing automation networks or for the stand-alone operation of the machines
- Simple, space-saving attachment to S7-300 DIN rail due to design as single-width module in S7-300 format
- Low-cost solution for implementing small, local Ethernet networks
- Rugged, industry-standard node connections with PROFINET-compliant RJ45 connectors that latch onto the enclosure to offer additional strain and bending relief

Technical specifications

Article number	6GK7377-1AA00-0AA0
Product type designation	CSM 377
Transmission rate	
Transfer rate	10 Mbit/s, 100 Mbit/s
Interfaces for communication integrated	
Number of electrical connections	4
• for network components or terminal equipment	
Number of 100 Mbit/s SC ports	0
• for multimode	
Number of 1000 Mbit/s LC ports	0
• for multimode	
• for single mode (LD)	0
Interfaces others	
Number of electrical connections	1
• for power supply	
Type of electrical connection	2-pole terminal block
Supply voltage, current consumption, power loss	
Type of voltage of the supply voltage	DC
Supply voltage	24 V
• external	19.2 ... 28.8 V
Product component fusing at power supply input	Yes
Fuse protection type at input for supply voltage	0.5 A / 60 V
Consumed current maximum	0.07 A
Power loss [W]	1.6 W
• at DC at 24 V	
Permitted ambient conditions	
Ambient temperature	0 ... 60 °C
• during operation	
• during storage	-40 ... +70 °C
• during transport	-40 ... +70 °C
Relative humidity	95 %
• at 25 °C without condensation during operation maximum	
Protection class IP	IP20

Article number	6GK7377-1AA00-0AA0
Product type designation	CSM 377
Design, dimensions and weight	
Design	SIMATIC S7-300 device design
Width	40 mm
Height	125 mm
Depth	118 mm
Net weight	0.2 kg
Mounting type	
• 35 mm DIN rail mounting	No
• wall mounting	No
• S7-300 rail mounting	Yes
• S7-1500 rail mounting	No
Product functions management, configuration	
Product function	
• multiport mirroring	No
• switch-managed	No
Product functions Redundancy	
Product function	
• Parallel Redundancy Protocol (PRP)/ operation in the PRP-network	Yes
• Parallel Redundancy Protocol (PRP)/ Redundant Network Access (RNA)	No

Technical specifications (continued)

Article number	6GK7377-1AA00-0AA0
Product type designation	CSM 377
Standards, specifications, approvals	
Standard	
• for FM	FM3611: Class 1, Division 2, Group A, B, C, D / T..., CL.1, Zone 2, GP, IIC, T, Ta
• for hazardous zone	EN 60079-15, II 3 G Ex nA II T., KEMA 06 ATEX 0021 X
• for safety from CSA and UL	UL 508, CSA C22.2 No. 142
• for hazardous zone from CSA and UL	UL 1604 and UL 2279-15 (Hazardous Location)
• for emitted interference	EN 61000-6-4:2001
• for interference immunity	EN 61000-6-2:2001
Certificate of suitability CE marking	Yes

Article number	6GK7377-1AA00-0AA0
Product type designation	CSM 377
Certificate of suitability	EN 61000-6-2:2001, EN 61000-6-4:2001
• C-Tick	Yes
• KC approval	No
Marine classification association	
• American Bureau of Shipping Europe Ltd. (ABS)	Yes
• Bureau Veritas (BV)	Yes
• Det Norske Veritas (DNV)	Yes
• Germanische Lloyd (GL)	No
• Lloyds Register of Shipping (LRS)	Yes
• Nippon Kaiji Kyokai (NK)	Yes
• Polski Rejestr Statkow (PRS)	No
• Royal Institution of Naval Architects (RINA)	No
MTBF at 40 °C	144 y

Ordering data

**Compact Switch Module
CSM 377**

Unmanaged switch for connecting a SIMATIC S7-300, ET200 M and up to three further nodes to Industrial Ethernet with 10/100 Mbps; 4 x RJ45 ports; external 24 V DC power supply, diagnostics on LEDs, S7-300 module including electronic manual on CD-ROM

Article No.

6GK7377-1AA00-0AA0

Article No.

Accessories**IE FC TP Standard Cable GP 2 x 2
(Type A)**

4-wire, shielded TP installation cable for connection to IE FC outlet RJ45/ IE FC RJ45 plug; PROFINET-compliant; with UL approval; sold by the meter; max. quantity 1000 m, minimum order 20 m

6XV1840-2AH10**IE FC RJ45 Plug 180 2 x 2**

RJ45 plug connector for Industrial Ethernet with a rugged metal housing and integrated insulation displacement contacts for connecting Industrial Ethernet FC installation cables; 180° cable outlet; for network components and CPs/CPUs with Industrial Ethernet interface

- 1 pack = 1 unit
- 1 pack = 10 units
- 1 pack = 50 units

6GK1901-1BB10-2AA0
6GK1901-1BB10-2AB0
6GK1901-1BB10-2AE0

IE FC Stripping Tool

Preadjusted stripping tool for fast stripping of the Industrial Ethernet FC cables

6GK1901-1GA00

SIMATIC S7-300 Advanced Controllers

I/O modules

Communication

TIM 3V-IE Advanced (for S7-300)**Overview**

- SINAUT communication module TIM for SIMATIC S7-300 for use in wide area network (WAN) as station, node station, and control center
- IP communication via secure VPN (virtual private network) using the Internet
- Wireless communication via GPRS router, GPRS modem or radio devices
- Wired communication via Ethernet, DSL, dial-up modems or dedicated line modem
- Complete migration of existing wireless, dedicated line and dial-up technology to IP-based network
- Message frame memory for complete recording of data and support of redundant communication paths
- Simple configuration and operation without specialist IT knowledge

Technical specifications

Article number	6NH7800-3CA00
Product type designation	TIM 3V-IE Advanced
Transmission rate	
Transfer rate	
• for Industrial Ethernet	10 ... 100 Mbit/s
• acc. to RS 232	50 ... 38 400 bit/s
Interfaces	
Number of interfaces acc. to Industrial Ethernet	1
Number of electrical connections	
• for external data transmission acc. to RS 232	1
• for power supply	1
Type of electrical connection	
• of Industrial Ethernet interface	RJ45 port
• at interface 1 for external data transmission	9 pin Sub-D-connector (RS232)
• for power supply	2-pole plugable terminal block
design of the removable storage C-PLUG	No
Supply voltage, current consumption, power loss	
Type of voltage of the supply voltage	DC
Supply voltage	24 V
Supply voltage	20.4 ... 28.8 V
Supply voltage external at DC Rated value	24 V
Supply voltage external at DC rated value	20.4 ... 28.8 V
Relative symmetrical tolerance at DC	
• at 5 V	5 %
Relative positive tolerance at DC at 24 V	5 %
Relative negative tolerance at DC at 24 V	5 %
Consumed current	
• from backplane bus at DC at 24 V maximum	0.2 A
• from external supply voltage at DC at 24 V maximum	0.2 A
Power loss [W]	5.8 W
Product extension optional	No
Backup battery	

Article number	6NH7800-3CA00
Product type designation	TIM 3V-IE Advanced
Permitted ambient conditions	
Ambient temperature	
• during operation	0 ... 60 °C
• during storage	-40 ... +70 °C
• during transport	-40 ... +70 °C
Relative humidity at 25 °C without condensation during operation maximum	95 %
Protection class IP	IP20
Design, dimensions and weight	
Module format	Compact module S7-300 single width
Width	40 mm
Height	125 mm
Depth	120 mm
Net weight	0.25 kg
Product properties, functions, components general	
Number of units	
• Note	Number of TIMs per S7-300: multiple, number depends on the connection resources of the S7-300 CPU
Wire length	
• with RS 232 interface maximum	6 m
Performance data S7 communication	
Number of possible connections for S7 communication	
• maximum	24
• with PG connections maximum	4
• with OP connections maximum	20
Service	
• SINAUT ST7 via S7 communication	Yes
• PG/OP communication	Yes
Performance data multi-protocol mode	
Number of active connections with multi-protocol mode	24

Technical specifications (continued)

Article number	6NH7800-3CA00	Article number	6NH7800-3CA00
Product type designation	TIM 3V-IE Advanced	Product type designation	TIM 3V-IE Advanced
Performance data telecontrol		Performance data telecontrol	
Suitability for use		Operating mode for scanning of data transmission	
• Node station	Yes	• with dedicated line/radio link with SINAUT ST1 protocol	Polling, polling with time slot procedure
• substation	Yes	• with dedicated line/radio link with SINAUT ST7 protocol	Polling, polling with time slot procedure, multi-master polling with time slot procedure
• TIM control center	Yes	• with dial-up network with SINAUT ST1 protocol	spontaneous
• Note	RS232 and Industrial Ethernet can be operated in parallel	• with dial-up network with SINAUT ST7 protocol	spontaneous
Protocol is supported		Hamming distance	
• TCP/IP	Yes	• for SINAUT ST1 protocol	4
• DNP3	No	• for SINAUT ST7 protocol	4
• SINAUT ST1 protocol	Yes	Configuration software	
• SINAUT ST7 protocol	Yes	• required	SINAUT ST7 ES
Product function data buffering if connection is aborted	Yes; 32,000 data messages	• for CPU configuring required SINAUT TD7 block library for CPU	Yes
Storage capacity		• for PG configuring required SINAUT ST7 configuration software for PG	Yes
• of S7 CPU RAM for TD7onCPU mode data blocks on CPU required	20 Kibyte	Storage location of TIM configuration data	on the TIM
• of S7 CPU RAM for TD7onTIM mode data blocks on TIM required	0 Kibyte	Product functions Security	
• Note	TD7onCPU: at least 20 KB, actual requirement determined by data volume and functional scope TD7onTIM: 0 bytes in most favorable case	Suitability for operation Virtual Private Network	Yes
Product feature Buffered message frame memory	No	Type of authentication with Virtual Private Network PSK	Yes
Transmission format		Product function	
• for SINAUT ST1 protocol with polling 11 bit	Yes	• password protection for VPN	Yes
• for SINAUT ST1 protocol with spontaneous 10-bit or 11-bit	Yes	• MSC client via GPRS modem with MSC capability	Yes
• for SINAUT ST7 protocol with multi-master polling 10-bit	Yes	Protocol	
• for SINAUT ST7 protocol with polling or spontaneous 10-bit or 11-bit	Yes	• is supported MSC protocol	Yes
		• with Virtual Private Network MSC is supported	TCP/IP
		Key length for MSC with Virtual Private Network	128 bit
		Number of possible connections	
		• as MSC client with VPN connection	1
		• as MSC server with VPN connection	0

SIMATIC S7-300 Advanced Controllers

I/O modules

Communication

TIM 3V-IE Advanced (for S7-300)

Ordering data	Article No.	Ordering data	Article No.
TIM 3V-IE Advanced communications module With an RS 232 interface and an RJ45 interface for SINAUT communication via a conventional WAN and an IP-based network (WAN or LAN)	6NH7800-3CA00	IE FC Stripping Tool Preadjusted stripping tool for fast stripping of the Industrial Ethernet FC cables	6GK1901-1GA00
SINAUT Engineering Software V5.5 On CD-ROM, comprising <ul style="list-style-type: none"> • SINAUT ST7 Engineering Software V5.5 for the PG • SINAUT TD7 block library • Electronic manual in German and English 	6NH7997-0CA55-0AA0	Connecting cable For connecting a TIM (RS 232) with a SINAUT ST7 MD2, MD3 or MD4 (RS 232) modem; cable length 1.5 m	6NH7701-4AL
Accessories		Connecting cable For connecting a TIM (RS 232) with the GSM modem MD720-3; also suitable for third-party modems or radio equipment with standard RS 232 interface; cable length 2.5 m	6NH7701-5AN
IE FC TP Standard Cable GP 2 x 2 (Type A) 4-wire, shielded TP installation cable for connection to IE FC Outlet RJ45/IE FC RJ45 Plug; PROFINET-compatible; with UL approval; sold by the meter; max. length 1000 m, minimum order quantity 20 m	6XV1840-2AH10	Connecting cable with one end open for connecting a TIM (RS 232) to a third-party modem or radio unit (RS 232); cable length 2.5 m	6NH7701-4BN
IE FC RJ45 Plug 180 RJ45 plug connector for Industrial Ethernet with a rugged metal housing and integrated insulation displacement contacts for connecting Industrial Ethernet FC installation cables; with 180° cable outlet; for network components and CPs/CPUs with Industrial Ethernet interface <ul style="list-style-type: none"> • 1 pack = 1 unit • 1 pack = 10 units • 1 pack = 50 units 	6GK1901-1BB10-2AA0 6GK1901-1BB10-2AB0 6GK1901-1BB10-2AE0	Connecting cable For connecting two TIM modules via their RS 232 interface without modems ("null modem"); cable length 6 m	6NH7701-0AR

5

Overview



- SINAUT communications module TIM for SIMATIC S7-300 for use in a wide area network (WAN)
- IP communication via secure VPN (virtual private network) using the Internet
- Wireless communication via GPRS router, GPRS modem, or radio devices
- Wired communication via Ethernet, DSL, dial-up modems or dedicated line modem
- Complete migration of existing wireless, dedicated line and dial-up technology to IP-based network
- Message frame memory for complete recording of data
- Simple configuration and operation without specialist IT knowledge

5

Technical specifications

Article number	6NH7800-3BA00
Product type designation	TIM 3V-IE
Transmission rate	
Transfer rate	
• for Industrial Ethernet	10 ... 100 Mbit/s
• acc. to RS 232	50 ... 38 400 bit/s
Interfaces	
Number of interfaces acc. to Industrial Ethernet	1
Number of electrical connections	
• for external data transmission acc. to RS 232	1
• for power supply	1
Type of electrical connection	
• of Industrial Ethernet interface	RJ45 port
• at interface 1 for external data transmission	9 pin Sub-D-connector (RS232)
• for power supply	2-pole plugable terminal block
design of the removable storage C-PLUG	No
Supply voltage, current consumption, power loss	
Type of voltage of the supply voltage	DC
Supply voltage	24 V
Supply voltage	20.4 ... 28.8 V
Supply voltage external at DC Rated value	24 V
Supply voltage external at DC rated value	20.4 ... 28.8 V
Relative symmetrical tolerance at DC	
• at 5 V	5 %
Relative positive tolerance at DC at 24 V	5 %
Relative negative tolerance at DC at 24 V	5 %
Consumed current	
• from backplane bus at DC at 24 V maximum	0.2 A
• from external supply voltage at DC at 24 V maximum	0.2 A
Power loss [W]	5.8 W
Product extension optional Backup battery	No

Article number	6NH7800-3BA00
Product type designation	TIM 3V-IE
Permitted ambient conditions	
Ambient temperature	
• during operation	0 ... 60 °C
• during storage	-40 ... +70 °C
• during transport	-40 ... +70 °C
Relative humidity at 25 °C without condensation during operation maximum	95 %
Protection class IP	IP20
Design, dimensions and weight	
Module format	Compact module S7-300 single width
Width	40 mm
Height	125 mm
Depth	120 mm
Net weight	0.25 kg
Product properties, functions, components general	
Number of units	
• per CPU maximum	1
• Note	Number of TIMs per S7-300: 1
Wire length	
• with RS 232 interface maximum	6 m
Performance data S7 communication	
Number of possible connections for S7 communication	
• maximum	8
• with PG connections maximum	2
• with OP connections maximum	8
Service	
• SINAUT ST7 via S7 communication	Yes
• PG/OP communication	Yes
Performance data multi-protocol mode	
Number of active connections with multi-protocol mode	12

SIMATIC S7-300 Advanced Controllers

I/O modules

Communication

TIM 3V-IE (for S7-300)

Technical specifications (continued)

Article number	6NH7800-3BA00	Article number	6NH7800-3BA00
Product type designation	TIM 3V-IE	Product type designation	TIM 3V-IE
Performance data telecontrol		Performance data telecontrol	
Suitability for use		Hamming distance	
• Node station	No	• for SINAUT ST1 protocol	4
• substation	Yes	• for SINAUT ST7 protocol	4
• TIM control center	No	Configuration software	
• Note	RS232 and Industrial Ethernet can not be operated in parallel	• required	SINAUT ST7 ES
Protocol is supported		• for CPU configuring required SINAUT TD7 block library for CPU	Yes
• TCP/IP	Yes	• for PG configuring required SINAUT ST7 configuration software for PG	Yes
• DNP3	No	Storage location of TIM configuration data	on the TIM
• SINAUT ST1 protocol	Yes	Product functions Security	
• SINAUT ST7 protocol	Yes	Suitability for operation Virtual Private Network	Yes
Product function data buffering if connection is aborted	Yes; 16,000 data messages	Operating mode Virtual Private Network note	VPN operation as MSC client with MSC protocol and password protection only possible in conjunction with GPRS modem with MSC capability
Storage capacity		Type of authentication with Virtual Private Network PSK	Yes
• of S7 CPU RAM for TD7onCPU mode data blocks on CPU required	20 Kibyte	Product function	
• of S7 CPU RAM for TD7onTIM mode data blocks on TIM required	0 Kibyte	• password protection for VPN	Yes
• Note	TD7onCPU: at least 20 KB, actual requirement determined by data volume and functional scope TD7onTIM: 0 bytes in most favorable case	• MSC client via GPRS modem with MSC capability	Yes
Product feature Buffered message frame memory	No	Protocol	
Transmission format		• is supported MSC protocol	No
• for SINAUT ST1 protocol with polling 11 bit	Yes	Key length for MSC with Virtual Private Network	128 bit
• for SINAUT ST1 protocol with spontaneous 10-bit or 11-bit	Yes	Number of possible connections	
• for SINAUT ST7 protocol with multi-master polling 10-bit	Yes	• as MSC client with VPN connection	1
• for SINAUT ST7 protocol with polling or spontaneous 10-bit or 11-bit	Yes	• as MSC server with VPN connection	0
Operating mode for scanning of data transmission			
• with dedicated line/radio link with SINAUT ST1 protocol	Polling, polling with time slot procedure		
• with dedicated line/radio link with SINAUT ST7 protocol	Polling, polling with time slot procedure, multi-master polling with time slot procedure		
• with dial-up network with SINAUT ST1 protocol	spontaneous		
• with dial-up network with SINAUT ST7 protocol	spontaneous		

5

Ordering data	Article No.	Ordering data	Article No.
TIM 3V-IE communications module With an RS 232 interface for SINAUT communication via a conventional WAN or an IP-based network (WAN or LAN)	6NH7800-3BA00	IE FC Stripping Tool Preadjusted stripping tool for fast stripping of the Industrial Ethernet FC cables	6GK1901-1GA00
SINAUT Engineering Software V5.5 On CD-ROM, comprising <ul style="list-style-type: none"> • SINAUT Engineering Software V5.5 for the PG • SINAUT TD7 block library • Electronic manual in German and English 	6NH7997-0CA55-0AA0	Connecting cable For connecting a TIM (RS 232) with a SINAUT ST7 MD2, MD3 or MD4 (RS 232) modem; cable length 1.5 m	6NH7701-4AL
Accessories		Connecting cable For connecting a TIM (RS 232) with the GSM modem MD720-3; also suitable for third-party modems or radio equipment with standard RS 232 interface; cable length 2.5 m	6NH7701-5AN
IE FC TP Standard Cable GP 2 x 2 (Type A) 4-wire, shielded TP installation cable for connection to IE FC Outlet RJ45/IE FC RJ45 Plug; PROFINET-compatible; with UL approval; sold by the meter; max. length 1000 m, minimum order quantity 20 m	6XV1840-2AH10	Connecting cable with one end open for connecting a TIM (RS 232) to a third-party modem or radio unit (RS 232); cable length 2.5 m	6NH7701-4BN
IE FC RJ45 Plug 180 RJ45 plug connector for Industrial Ethernet with a rugged metal housing and integrated insulation displacement contacts for connecting Industrial Ethernet FC installation cables; with 180° cable outlet; for network components and CPs/CPUs with Industrial Ethernet interface <ul style="list-style-type: none"> • 1 pack = 1 unit • 1 pack = 10 units • 1 pack = 50 units 	6GK1901-1BB10-2AA0 6GK1901-1BB10-2AB0 6GK1901-1BB10-2AE0	Connecting cable For connecting two TIM modules via their RS 232 interface without modems ("null modem"); cable length 6 m	6NH7701-0AR

SIMATIC S7-300 Advanced Controllers

I/O modules

Communication

TIM 4R-IE (for S7-300/-400/PC)

Overview



- SINAUT communications module TIM with four interfaces for SIMATIC S7-300 or as self-contained unit for the S7-400 for use in the wide area network (WAN)
- For universal use in a SINAUT station, node station and control center
- Internet communication via integrated MSC-VPN tunnel with direct connection to DSL router or operation via IPsec VPN with additional SIMATIC NET components
- Wireless communication via GPRS router, GPRS modem, or radio devices
- Wired communication via Ethernet, DSL, dial-up modems or dedicated line modem
- Complete migration of existing wireless, dedicated line and dial-up technology to IP-based network
- Message frame memory for complete recording of data and support of redundant communication paths
- Simple configuration and operation without specialist IT knowledge

Technical specifications

Article number	6NH7800-4BA00
Product type designation	TIM 4R-IE
Transmission rate	
Transfer rate	
• for Industrial Ethernet	10 ... 100 Mbit/s
• acc. to RS 232	50 ... 38 400 bit/s
Interfaces	
Number of interfaces acc. to Industrial Ethernet	2
Number of electrical connections	
• for external data transmission acc. to RS 232	2
• for power supply	1
Type of electrical connection	
• of Industrial Ethernet interface	RJ45 port
• at interface 1 for external data transmission	9 pin Sub-D-connector, RS232 switchable to RS485
• at interface 2 for external data transmission	9-pole D-sub connector, RS232 can be switched to RS485
• for power supply	2-pole plugable terminal block
design of the removable storage C-PLUG	Yes
Supply voltage, current consumption, power loss	
Type of voltage of the supply voltage	DC
Supply voltage	24 V
Supply voltage	20.4 ... 28.8 V
Supply voltage external at DC Rated value	24 V
Supply voltage external at DC rated value	20.4 ... 28.8 V
Consumed current	
• from backplane bus at DC at 24 V maximum	0.2 A
• from external supply voltage at DC at 24 V maximum	0.17 A
Power loss [W]	4.6 W

Article number	6NH7800-4BA00
Product type designation	TIM 4R-IE
Product extension optional	Yes
Backup battery	
Type of battery	Lithium AA / 3.6 V / 2.3 Ah
Backup current	
• typical	100 µA
• maximum	160 µA
Permitted ambient conditions	
Ambient temperature	
• during operation	0 ... 60 °C
• during storage	-40 ... +70 °C
• during transport	-40 ... +70 °C
Relative humidity at 25 °C without condensation during operation maximum	95 %
Protection class IP	IP20
Design, dimensions and weight	
Module format	Compact module S7-300 double width
Width	80 mm
Height	125 mm
Depth	120 mm
Net weight	0.4 kg
Product properties, functions, components general	
Number of units	
• Note	Number of TIM 4R-IE per S7-300/S7-400: multiple, number depends on the connection resources of the CPU
Wire length	
• with RS 232 interface maximum	6 m
• with RS 485 interface maximum	30 m
Performance data	
S7 communication	
Number of possible connections for S7 communication	
• maximum	64
• with PG connections maximum	2
• with OP connections maximum	62
Service	
• SINAUT ST7 via S7 communication	Yes
• PG/OP communication	Yes

Technical specifications (continued)

Article number	6NH7800-4BA00	Article number	6NH7800-4BA00
Product type designation	TIM 4R-IE	Product type designation	TIM 4R-IE
Performance data multi-protocol mode		Hamming distance	
Number of active connections with multi-protocol mode	128	<ul style="list-style-type: none"> for SINAUT ST1 protocol for SINAUT ST7 protocol 	4 4
Performance data telecontrol		Configuration software	
Suitability for use		<ul style="list-style-type: none"> required for CPU configuring required SINAUT TD7 block library for CPU for PG configuring required SINAUT ST7 configuration software for PG 	SINAUT ST7 ES Yes Yes
<ul style="list-style-type: none"> Node station substation TIM control center 	Yes Yes Yes	Storage location of TIM configuration data	on internal TIM flash memory, or on TIM in optional C-PLUG, or on MMC of the S7-300 CPU if TIM installed in S7-300 controller
Protocol is supported		Product functions Security	
<ul style="list-style-type: none"> TCP/IP DNP3 SINAUT ST1 protocol SINAUT ST7 protocol 	Yes No Yes Yes	Suitability for operation Virtual Private Network	Yes
Product function data buffering if connection is aborted	Yes; 56,000 data messages	Type of authentication with Virtual Private Network PSK	Yes
Storage capacity		Product function	
<ul style="list-style-type: none"> of S7 CPU RAM for TD7onCPU mode data blocks on CPU required of S7 CPU RAM for TD7onTIM mode data blocks on TIM required Note 	20 Kibyte 0 Kibyte TD7onCPU: at least 20 KB, actual requirement determined by data volume and functional scope TD7onTIM: 0 bytes in most favorable case	<ul style="list-style-type: none"> password protection for VPN MSC client via GPRS modem with MSC capability 	Yes Yes
Product feature Buffered message frame memory	Yes	Protocol	
Transmission format		<ul style="list-style-type: none"> is supported MSC protocol with Virtual Private Network MSC is supported 	Yes TCP/IP
<ul style="list-style-type: none"> for SINAUT ST1 protocol with polling 11 bit for SINAUT ST1 protocol with spontaneous 10-bit or 11-bit for SINAUT ST7 protocol with multi-master polling 10-bit for SINAUT ST7 protocol with polling or spontaneous 10-bit or 11-bit 	Yes Yes Yes Yes	Key length for MSC with Virtual Private Network	128 bit
Operating mode for scanning of data transmission		Number of possible connections	
<ul style="list-style-type: none"> with dedicated line/radio link with SINAUT ST1 protocol with dedicated line/radio link with SINAUT ST7 protocol with dial-up network with SINAUT ST1 protocol with dial-up network with SINAUT ST7 protocol 	Polling, polling with time slot procedure Polling, polling with time slot procedure, multi-master polling with time slot procedure spontaneous spontaneous	<ul style="list-style-type: none"> as MSC client with VPN connection as MSC server with VPN connection 	1 128
		Product functions Time	
		Product component Hardware real-time clock	Yes
		Product feature Hardware real-time clock w. battery backup	Yes
		Accuracy of the hardware real-time clock per day maximum time synchronization	4 s
		<ul style="list-style-type: none"> from NTP-server 	Yes

SIMATIC S7-300 Advanced Controllers

I/O modules

Communication

TIM 4R-IE (for S7-300/-400/PC)

Ordering data

Ordering data	Article No.	Ordering data	Article No.
TIM 4R-IE communications module With two combined RS 232/RS 485 interfaces for SINAUT communication via conventional WANs and two RJ45 interfaces for SINAUT communication via IP-based networks (WAN or LAN)	6NH7800-4BA00	IE FC Stripping Tool Preadjusted stripping tool for fast stripping of the Industrial Ethernet FC cables	6GK1901-1GA00
SINAUT Engineering Software V5.5 On CD-ROM, comprising <ul style="list-style-type: none"> • SINAUT ST7 Engineering Software V5.5 for the PG • SINAUT TD7 block library • Electronic manual in German and English 	6NH7997-0CA55-0AA0	Connecting cable For connecting a TIM (RS 232) with a SINAUT ST7 MD2, MD3 or MD4 (RS 232) modem; cable length 1.5 m	6NH7701-4AL
Accessories		Connecting cable For connecting a TIM (RS 232) with the GSM modem MD720-3; also suitable for third-party modems or radio equipment with standard RS 232 interface; cable length 2.5 m	6NH7701-5AN
Backup battery 3.6 V/2.3 Ah for TIM 4R-IE	6ES7971-0BA00	Connecting cable with one end open for connecting a TIM (RS 232) to a third-party modem or radio unit (RS 232); cable length 2.5 m	6NH7701-4BN
IE FC TP Standard Cable GP 2 x 2 (Type A) 4-wire, shielded TP installation cable for connection to IE FC Outlet RJ45/IE FC RJ45 Plug; PROFINET-compatible; with UL approval; sold by the meter; max. length 1000 m, minimum order quantity 20 m	6XV1840-2AH10	Connecting cable For connecting two TIM modules via their RS 232 interface without modems ("null modem"); cable length 6 m	6NH7701-0AR
IE FC RJ45 Plug 180 RJ45 plug connector for Industrial Ethernet with a rugged metal housing and integrated insulation displacement contacts for connecting Industrial Ethernet FC installation cables; with 180° cable outlet; for network components and CPs/CPUs with Industrial Ethernet interface <ul style="list-style-type: none"> • 1 pack = 1 unit • 1 pack = 10 units • 1 pack = 50 units 	6GK1901-1BB10-2AA0 6GK1901-1BB10-2AB0 6GK1901-1BB10-2AE0	SITOP compact 24 V/0.6 A 1-phase power supply with wide-range input 85 ... 264 V AC/110 ... 300 V DC, stabilized output voltage 24 V, rated output current value 0.6 A, slim design	6EP1331-5BA00

Overview



In a station for the S7-CPU, the new communication module TIM 3V-IE DNP3 V3.0 (TeleControl Interface Module) handles the data exchange with the assigned master system SIMATIC PCS 7 TeleControl V8.0 using the open DNP3 protocol. In addition, the V3.0 module now also supports master and node functionality.

- With the S7-300 housing, the module can be fully integrated into the S7-300 system
- The module has an RS 232 interface for the connection of an external modem for data transmission via a conventional WAN or the connection of a Modbus RTU slave to an S7-300 system
- The RJ45 port is used for data transmission via IP-based networks

Technical specifications

Article number	6NH7803-3BA00-0AA0
Product type designation	TIM 3V-IE DNP3
Transmission rate	
Transfer rate	
• for Industrial Ethernet	10 ... 100 Mbit/s
• acc. to RS 232	9 600 ... 38 400 bit/s
Interfaces	
Number of interfaces acc. to Industrial Ethernet	1
Number of electrical connections	
• for external data transmission acc. to RS 232	1
• for power supply	1
Type of electrical connection	
• of Industrial Ethernet interface	RJ45 port
• at interface 1 for external data transmission	9 pin Sub-D-connector (RS232)
• for power supply	2-pole plugable terminal block
design of the removable storage C-PLUG	No
Supply voltage, current consumption, power loss	
Type of voltage of the supply voltage	DC
Supply voltage	24 V
Supply voltage	20.4 ... 28.8 V
Supply voltage external at DC Rated value	24 V
Supply voltage external at DC rated value	20.4 ... 28.8 V
Consumed current	
• from backplane bus at DC at 24 V maximum	0.2 A
• from external supply voltage at DC at 24 V maximum	0.2 A
Power loss [W]	5.8 W
Product extension optional Backup battery	No

Article number	6NH7803-3BA00-0AA0
Product type designation	TIM 3V-IE DNP3
Permitted ambient conditions	
Ambient temperature	
• during operation	0 ... 60 °C
• during storage	-40 ... +70 °C
• during transport	-40 ... +70 °C
Relative humidity at 25 °C without condensation during operation maximum	95 %
Protection class IP	IP20
Design, dimensions and weight	
Module format	Compact module S7-300 single width
Width	40 mm
Height	125 mm
Depth	120 mm
Net weight	0.25 kg
Product properties, functions, components general	
Number of units	
• Note	Number of TIMs per S7-300: 1
Wire length	
• with RS 232 interface maximum	6 m
Performance data S7 communication	
Number of possible connections for S7 communication	
• maximum	3
• with PG connections maximum	2
• with OP connections maximum	1
• Note	only via LAN
Service	
• PG/OP communication	Yes

SIMATIC S7-300 Advanced Controllers

I/O modules

Communication

TIM 3V-IE DNP3 (for S7-300)

Technical specifications (continued)

Article number	6NH7803-3BA00-0AA0
Product type designation	TIM 3V-IE DNP3
Performance data telecontrol	
Suitability for use	
• Node station	Yes
• substation	Yes
• TIM control center	Yes
Protocol is supported	
• TCP/IP	Yes
• DNP3	Yes
• SINAUT ST1 protocol	No
• SINAUT ST7 protocol	No
• Modbus RTU	Yes

Article number	6NH7803-3BA00-0AA0
Product type designation	TIM 3V-IE DNP3
Product function data buffering if connection is aborted	Yes; 64,000 data points with one master
Number of DNP3 masters	
• for Ethernet maximum	8
• with RS 232 interface maximum	1
Number of Modbus RTU slaves maximum	1
Configuration software	
• required	SINAUT ST7 ES
Storage location of TIM configuration data	on the CPU or TIM

5

Ordering data

Article No.

TIM 3V-IE DNP3 communications module	6NH7803-3BA00-0AA0
With an RS 232 interface for SINAUT communication via a conventional WAN and an IP-based network (WAN or LAN)	
SINAUT Engineering Software V5.5	6NH7997-0CA55-0AA0
On CD-ROM, comprising	
• SINAUT ST7 Engineering Software V5.5 for the PG	
• SINAUT TD7 block library	
• Electronic manual in German and English	
Accessories	
IE FC TP Standard Cable GP 2 x 2 (Type A)	6XV1840-2AH10
4-wire, shielded TP installation cable for connection to IE FC Outlet RJ45/IE FC RJ45 Plug; PROFINET-compatible; with UL approval; sold by the meter; max. length 1000 m, minimum order quantity 20 m	
IE FC RJ45 Plug 180	
RJ45 plug connector for Industrial Ethernet with a rugged metal housing and integrated insulation displacement contacts for connecting Industrial Ethernet FC installation cables; with 180° cable outlet; for network components and CPs/CPUs with Industrial Ethernet interface	
• 1 pack = 1 unit	6GK1901-1BB10-2AA0
• 1 pack = 10 units	6GK1901-1BB10-2AB0
• 1 pack = 50 units	6GK1901-1BB10-2AE0

Article No.

IE FC Stripping Tool	6GK1901-1GA00
Preadjusted stripping tool for fast stripping of the Industrial Ethernet FC cables	
Connecting cable	6NH7701-4AL
For connecting a TIM (RS 232) with a SINAUT ST7 MD2, MD3 or MD4 (RS 232) modem; cable length 1.5 m	
Connecting cable	6NH7701-5AN
For connecting a TIM (RS 232) with the GSM modem MD720-3; also suitable for third-party modems or radio equipment with standard RS 232 interface; cable length 2.5 m	
Connecting cable	6NH7701-4BN
with one end open for connecting a TIM (RS 232) to a third-party modem or radio unit (RS 232); cable length 2.5 m	
Connecting cable	6NH7701-0AR
For connecting two TIM modules via their RS 232 interface without modems ("null modem"); cable length 6 m	

Overview



In a station for the S7-CPU, the communication module TIM 4R-IE DNP3 (TeleControl Interface Module) handles the data exchange with the assigned SIMATIC PCS7 TeleControl V8.0 master system using the open DNP3 protocol. In addition, the V3.0 module now also supports master and node functionality.

- With the double-width S7-300 housing, the module can be fully integrated into the S7-300 system
- Can be connected as a stand-alone module to a SIMATIC S7-400 and SIMATIC S7-400 H System
- Two RS 232/RS 485 interfaces support connection of an external modem for data transmission via a conventional WAN or of a Modbus RTU slave to an S7-300 system
- The module has two RJ45 interfaces for data transmission via IP-based networks
- By using physically separate connection paths, the module permits media redundancy without loss of data during the switchover

5

Technical specifications

Article number	6NH7803-4BA00-0AA0
Product type designation	TIM 4R-IE DNP3
Transmission rate	
Transfer rate	
• for Industrial Ethernet	10 ... 100 Mbit/s
• acc. to RS 232	9 600 ... 115 200 bit/s
Interfaces	
Number of interfaces acc. to Industrial Ethernet	2
Number of electrical connections	
• for external data transmission acc. to RS 232	2
• for power supply	1
Type of electrical connection	
• of Industrial Ethernet interface	RJ45 port
• at interface 1 for external data transmission	9 pin Sub-D-connector, RS232 switchable to RS485
• at interface 2 for external data transmission	9-pole D-sub connector, RS232 can be switched to RS485
• for power supply	2-pole pluggable terminal block
design of the removable storage C-PLUG	Yes
Supply voltage, current consumption, power loss	
Type of voltage of the supply voltage	DC
Supply voltage	24 V
Supply voltage	20.4 ... 28.8 V
Supply voltage external at DC Rated value	24 V
Supply voltage external at DC rated value	20.4 ... 28.8 V
Consumed current	
• from backplane bus at DC at 24 V maximum	0.2 A
• from external supply voltage at DC at 24 V maximum	0.17 A
Power loss [W]	4.6 W
Product extension optional Backup battery	Yes
Type of battery	Lithium AA / 3.6 V / 2.3 Ah
Backup current	
• typical	100 µA
• maximum	160 µA

Article number	6NH7803-4BA00-0AA0
Product type designation	TIM 4R-IE DNP3
Permitted ambient conditions	
Ambient temperature	
• during operation	0 ... 60 °C
• during storage	-40 ... +70 °C
• during transport	-40 ... +70 °C
Relative humidity at 25 °C without condensation during operation maximum	95 %
Protection class IP	IP20
Design, dimensions and weight	
Module format	Compact module S7-300 double width
Width	80 mm
Height	125 mm
Depth	120 mm
Net weight	0.4 kg
Product properties, functions, components general	
Number of units	
• Note	Number of TIMs per S7-300 / S7-400: 1
Wire length	
• with RS 232 interface maximum	6 m
• with RS 485 interface maximum	30 m
Performance data S7 communication	
Number of possible connections for S7 communication	
• maximum	5
• with PG connections maximum	2
• with OP connections maximum	1
• Note	only via LAN
Service	
• PG/OP communication	Yes
Performance data telecontrol	
Suitability for use	
• Node station	Yes
• substation	Yes
• TIM control center	Yes

SIMATIC S7-300 Advanced Controllers

I/O modules

Communication

TIM 4R-IE DNP3 (for S7-300/-400)

Technical specifications (continued)

Article number	6NH7803-4BA00-0AA0
Product type designation	TIM 4R-IE DNP3
Protocol is supported	
• TCP/IP	Yes
• DNP3	Yes
• SINAUT ST1 protocol	No
• SINAUT ST7 protocol	No
• Modbus RTU	Yes
Product function data buffering if connection is aborted	Yes; 200,000 data points with one master
Number of DNP3 masters	
• for Ethernet maximum	8
• with RS 232 interface maximum	1
Number of Modbus RTU slaves maximum	1

Article number	6NH7803-4BA00-0AA0
Product type designation	TIM 4R-IE DNP3
Configuration software	
• required	SINAUT ST7 ES
Storage location of TIM configuration data	on the CPU or TIM
Product functions Time	
Product component Hardware real-time clock	Yes
Product feature Hardware real-time clock w. battery backup	Yes
Accuracy of the hardware real-time clock per day maximum time synchronization	4 s
• from NTP-server	Yes

Ordering data

Article No.

Article No.

TIM 4R-IE DNP3 communications module	6NH7803-4BA00-0AA0
With two combined RS 232/RS 485 interfaces for SINAUT communication via conventional WANs and two RJ45 interfaces for SINAUT communication via IP-based networks (WAN or LAN)	
SINAUT Engineering Software V5.5	6NH7997-0CA55-0AA0
On CD-ROM, comprising	
• SINAUT ST7 Engineering Software V5.5 for the PG	
• SINAUT TD7 block library	
• Electronic manual in German and English	
Accessories	
Backup battery	6ES7971-0BA00
3.6 V/2.3 Ah for TIM 4R-IE DNP3	
IE FC TP Standard Cable GP 2 x 2 (Type A)	6XV1840-2AH10
4-wire, shielded TP installation cable for connection to IE FC Outlet RJ45/IE FC RJ45 Plug; PROFINET-compatible; with UL approval; sold by the meter; max. length 1000 m, minimum order quantity 20 m	
IE FC RJ45 Plug 180	
RJ45 plug connector for Industrial Ethernet with a rugged metal housing and integrated insulation displacement contacts for connecting Industrial Ethernet FC installation cables; with 180° cable outlet; for network components and CPs/CPU with Industrial Ethernet interface	
• 1 pack = 1 unit	6GK1901-1BB10-2AA0
• 1 pack = 10 units	6GK1901-1BB10-2AB0
• 1 pack = 50 units	6GK1901-1BB10-2AE0

IE FC Stripping Tool	6GK1901-1GA00
Preadjusted stripping tool for fast stripping of the Industrial Ethernet FC cables	
Connecting cable	6NH7701-4AL
For connecting a TIM (RS 232) with a SINAUT ST7 MD2, MD3 or MD4 (RS 232) modem; cable length 1.5 m	
Connecting cable	6NH7701-5AN
For connecting a TIM (RS 232) with the GSM modem MD720-3; also suitable for third-party modems or radio equipment with standard RS 232 interface; cable length 2.5 m	
Connecting cable	6NH7701-4BN
with one end open for connecting a TIM (RS 232) to a third-party modem or radio unit (RS 232); cable length 2.5 m	
Connecting cable	6NH7701-0AR
For connecting two TIM modules via their RS 232 interface without modems ("null modem"); cable length 6 m	
SITOP compact 24 V/0.6 A	6EP1331-5BA00
1-phase power supply with wide-range input 85 to 264 V AC/110 to 300 V DC, stabilized output voltage 24 V, rated output current value 0.6 A, slim design	

Overview



The ASM 475 is a powerful communication module for connecting the MOBY D, SIMATIC RF200, RF300, RF600 and SIMATIC MV400 identification systems to the S7-300 and ET 200M.

Technical specifications

Article number	6GT2002-0GA10
Product type designation	ASM 475 communication module
Suitability for operation	SIMATIC S7-300, ET200M together with RF200/300/600, MV400, MOBY D/E/I/U
Transmission rate	
Transfer rate at the point-to-point connection serial maximum	115.2 kbit/s
Interfaces	
Design of the interface for point-to-point connection	RS422
Number of readers connectable	2
Type of electrical connection	
• of the backplane bus	S7-300 backplane bus
• of the PROFIBUS interface	(according to the head module)
• of Industrial Ethernet interface	(according to the head module)
• for supply voltage	Screw-type or spring-loaded terminals
Design of the interface to the reader for communication	Screw-type or spring-loaded terminals
Mechanical data	
Material	Noryl
Color	anthracite
Supply voltage, current consumption, power loss	
Supply voltage	
• at DC Rated value	24 V
• at DC	20 ... 30 V
Consumed current at DC at 24 V	
• without connected devices typical	0.1 A
• with connected devices maximum	1 A

Article number	6GT2002-0GA10
Product type designation	ASM 475 communication module
Permitted ambient conditions	
Ambient temperature	
• during operation	0 ... 60 °C
• during storage	-40 ... +70 °C
• during transport	-40 ... +70 °C
Protection class IP	IP20
Shock resistance	According to IEC 61131-2
Shock acceleration	150 m/s ²
Vibrational acceleration	10 m/s ²
Design, dimensions and weight	
Width	40 mm
Height	125 mm
Depth	120 mm
Net weight	0.2 kg
Mounting type	S7-300 rack
Cable length for RS 422 interface maximum	1 000 m
Product properties, functions, components general	
Display version	4 LEDs per reader connection, 2 LEDs for device status
Product function transponder file handler can be addressed	Yes
Protocol is supported	
• S7 communication	Yes
Type of parameterization	Object manager, GSD
Type of programming	FB 45, FB 55, FC 56 (FC 45/55 with limited functionality)
Type of computer-mediated communication	acyclic communication
Standards, specifications, approvals	
Certificate of suitability	CE, FCC, UL/CSA
Accessories	
accessories	Front connector with screw-type or spring-loaded terminals

SIMATIC S7-300 Advanced Controllers

I/O modules

Communication

ASM 475**Ordering data****Article No.****ASM 475 communication module****6GT2002-0GA10**

For SIMATIC S7-300 and ET 200M, parameterizable

Accessories**Front connector
(1 x per ASM 475)**

- with screw terminals
- with spring-loaded terminals

6ES7392-1AJ00-0AA0**6ES7392-1BJ00-0AA0****Shield connecting element
(80 mm wide for 2 x ASM 475)****6ES7390-5AA00-0AA0****Shield connection clamp
(1 x per reader cable)****6ES7390-5BA00-0AA0****MOBY D connecting cable**

pre-assembled, between ASM 475 and reader D1xS, 9-pole Sub-D plug, PUR material, CMG approved, suitable for cable carriers, in the following lengths:

5 m

6GT2491-4EH50

20 m

6GT2491-4EN20

50 m

6GT2491-4EN50**Article No.****Extension cable**

SIMATIC RF200 / RF300 / RF600 / MV400, PUR material, CMG approval, suitable for cable carriers, straight connector

2 m

6GT2891-4FH20

5 m

6GT2891-4FH50

10 m

6GT2891-4FN10

20 m

6GT2891-4FN20

50 m

6GT2891-4FN50**SIMATIC RF200 / RF300 / RF600 / MV400 connecting cable**pre-assembled, between the ASM 475 and RF200 / RF300 / RF600 / MV400, IP65, straight connector, PUR material, suitable for cable carriers, CMG approval, in the following lengths¹⁾:

2 m

6GT2891-4EH20

5 m

6GT2891-4EH50**DVD "RFID Systems Software & Documentation"****6GT2080-2AA20**

¹⁾ The connecting cables can be extended using RF300 connecting cables of type 6GT2891-4Fxxx. These connecting cables are available in the lengths 2 m, 5 m, 10 m, 20 m and 50 m.

Overview



- The low-cost, complete solution for serial communication over a point-to-point connection
- RS 232C (V.24) and RS 422/485 (X.27)
- Implemented protocols:
 - ASCII
 - 3964 (R) (not for RS 485)
 - Printer driver
- Simple parameterization using tool integrated in STEP 7

Note:

SIPLUS extreme products are based on SIMATIC standard products. The contents listed here were taken from the respective standard products. SIPLUS extreme specific information was added.

Technical specifications

Article number	6AG1340-1AH02-2AE0	6AG1340-1AH02-2AY0	6AG1340-1CH02-2AE0
Based on	6ES7340-1AH02-0AE0 SIPLUS S7-300 CP340 RS 232	6ES7340-1AH02-0AE0 SIPLUS S7-300 CP340 RS 232 EN50155	6ES7340-1CH02-0AE0 SIPLUS S7-300 CP340 RS 422/485
Ambient conditions			
Ambient temperature during operation			
• min.	-25 °C; = Tmin	-25 °C; = Tmin	-25 °C; = Tmin
• max.	70 °C; = Tmax; 60 °C @ UL/cUL, ATEX and FM use	60 °C; = Tmax; the rated temperature range of -25 ... +55 °C (T1) applies for the use on railway vehicles according to EN50155	60 °C; = Tmax
Ambient temperature during storage/transportation			
• min.	-40 °C	-40 °C	-40 °C
• max.	70 °C	70 °C	70 °C
Extended ambient conditions			
• relative to ambient temperature-atmospheric pressure-installation altitude	Tmin ... Tmax at 1080 hPa ... 795 hPa (-1000 m ... +2000 m) // Tmin ... (Tmax - 10K) at 795 hPa ... 658 hPa (+2000 m ... +3500 m) // Tmin ... (Tmax - 20K) at 658 hPa ... 540 hPa (+3500 m ... +5000 m)	Tmin ... Tmax at 1080 hPa ... 795 hPa (-1000 m ... +2000 m) // Tmin ... (Tmax - 10K) at 795 hPa ... 658 hPa (+2000 m ... +3500 m) // Tmin ... (Tmax - 20K) at 658 hPa ... 540 hPa (+3500 m ... +5000 m)	Tmin ... Tmax at 1080 hPa ... 795 hPa (-1000 m ... +2000 m) // Tmin ... (Tmax - 10K) at 795 hPa ... 658 hPa (+2000 m ... +3500 m) // Tmin ... (Tmax - 20K) at 658 hPa ... 540 hPa (+3500 m ... +5000 m)
Relative humidity			
- With condensation, tested in accordance with IEC 60068-2-38, max.	100 %; RH incl. condensation/frost (no commissioning under condensation conditions)	100 %; RH incl. condensation/frost (no commissioning under condensation conditions)	100 %; RH incl. condensation/frost (no commissioning under condensation conditions)
Resistance			
- against biologically active substances / conformity with EN 60721-3-3	Yes; Class 3B2 mold, fungus and dry rot spores (with the exception of fauna). The supplied connector covers must remain on the unused interfaces during operation!	Yes; Class 3B2 mold, fungus and dry rot spores (with the exception of fauna). The supplied connector covers must remain on the unused interfaces during operation!	Yes; Class 3B2 mold, fungus and dry rot spores (with the exception of fauna). The supplied connector covers must remain on the unused interfaces during operation!
- against chemically active substances / conformity with EN 60721-3-3	Yes; Class 3C4 (RH < 75%) incl. salt spray according to EN 60068-2-52 (degree of severity 3). The supplied connector covers must remain on the unused interfaces during operation!	Yes; Class 3C4 (RH < 75%) incl. salt spray according to EN 60068-2-52 (degree of severity 3). The supplied connector covers must remain on the unused interfaces during operation!	Yes; Class 3C4 (RH < 75%) incl. salt spray according to EN 60068-2-52 (degree of severity 3). The supplied connector covers must remain on the unused interfaces during operation!
- against mechanically active substances / conformity with EN 60721-3-3	Yes; Class 3S4 incl. sand, dust. The supplied connector covers must remain on the unused interfaces during operation!	Yes; Class 3S4 incl. sand, dust. The supplied connector covers must remain on the unused interfaces during operation!	Yes; Class 3S4 incl. sand, dust. The supplied connector covers must remain on the unused interfaces during operation!

SIMATIC S7-300 Advanced Controllers

I/O modules

SIPLUS S7-300 communication

SIPLUS S7-300 CP 340**Ordering data****Article No.****SIPLUS S7-300 CP 340
communications processor***For industrial applications with
extended ambient conditions*Extended temperature range
and exposure to media

with 1 RS 232C interface (V.24)

6AG1340-1AH02-2AE0

with 1 RS 422/485 (X.27) interface

6AG1340-1CH02-2AE0*For rolling stock railway
applications*Conforms to EN 50155

with 1 RS 232C interface (V.24)

6AG1340-1AH02-2AY0

Overview



- For fast, high-performance serial data exchange via point-to-point coupling
- Two versions with different physical transmission characteristics:
 - RS 232C (V.24),
 - RS 422/RS 485 (X.27)
- Implemented protocols: ASCII, 3964 (R), RK 512, customized protocols (can be reloaded)
- Simple parameter assignment using tool integrated in STEP 7

Note:

SIPLUS extreme products are based on SIMATIC standard products. The contents listed here were taken from the respective standard products. SIPLUS extreme specific information was added.

5

Technical specifications

Article number	6AG1341-1AH02-7AE0	6AG1341-1CH02-7AE0
Based on	6ES7341-1AH02-0AE0 SIPLUS S7-300 CP341 RS 232C	6ES7341-1CH02-0AE0 SIPLUS S7-300 CP341 RS 422/485
Ambient conditions		
Ambient temperature during operation		
• min.	-25 °C; = Tmin	-25 °C; = Tmin
• max.	70 °C; = Tmax; 60 °C @ UL/cUL, ATEX and FM use	70 °C; = Tmax; 60 °C @ UL/cUL, ATEX and FM use
Ambient temperature during storage/transportation		
• min.	-40 °C	-40 °C
• max.	70 °C	70 °C
Extended ambient conditions		
• relative to ambient temperature-atmospheric pressure-installation altitude	Tmin ... Tmax at 1080 hPa ... 795 hPa (-1000 m ... +2000 m) // Tmin ... (Tmax - 10K) at 795 hPa ... 658 hPa (+2000 m ... +3500 m) // Tmin ... (Tmax - 20K) at 658 hPa ... 540 hPa (+3500 m ... +5000 m)	
Relative humidity		
- With condensation, tested in accordance with IEC 60068-2-38, max.	100 %; RH incl. condensation/frost (no commissioning under condensation conditions)	100 %; RH incl. condensation/frost (no commissioning under condensation conditions)
Resistance		
- against biologically active substances / conformity with EN 60721-3-3	Yes; Class 3B2 mold, fungus and dry rot spores (with the exception of fauna). The supplied connector covers must remain on the unused interfaces during operation!	Yes; Class 3B2 mold, fungus and dry rot spores (with the exception of fauna). The supplied connector covers must remain on the unused interfaces during operation!
- against chemically active substances / conformity with EN 60721-3-3	Yes; Class 3C4 (RH < 75%) incl. salt spray according to EN 60068-2-52 (degree of severity 3). The supplied connector covers must remain on the unused interfaces during operation!	Yes; Class 3C4 (RH < 75%) incl. salt spray according to EN 60068-2-52 (degree of severity 3). The supplied connector covers must remain on the unused interfaces during operation!
- against mechanically active substances / conformity with EN 60721-3-3	Yes; Class 3S4 incl. sand, dust. The supplied connector covers must remain on the unused interfaces during operation!	Yes; Class 3S4 incl. sand, dust. The supplied connector covers must remain on the unused interfaces during operation!

SIMATIC S7-300 Advanced Controllers

I/O modules

SIPLUS S7-300 communication

SIPLUS S7-300 CP 341**Ordering data****Article No.****SIPLUS S7-300 CP 341
communications processor***For industrial applications with
extended ambient conditions*Extended temperature range
and exposure to media

with RS 232C interface (V.24)

with RS 422/485 (X.27) interface

6AG1341-1AH02-7AE0**6AG1341-1CH02-7AE0****Article No.****Accessories****Modbus Master V3.1**

Task:

Communication via
Modbus protocol with RTU format,
SIMATIC S7 as master

Requirement:

CP 341 or CP 441-2;
STEP 7 V4.02 and higher

Delivery package:

Driver program/documentation,
English, German, French

Single license

6ES7870-1AA01-0YA0Single license, without software and
documentation**6ES7870-1AA01-0YA1****Modbus Slave V3.1**

Task:

Communication via
Modbus protocol with RTU format,
SIMATIC S7 as slave

Requirement:

CP 341 or CP 441-2;
STEP 7 V4.02 and higher

Delivery package:

Driver program/documentation,
English, German, French

Single license

6ES7870-1AB01-0YA0Single license, without software and
documentation**6ES7870-1AB01-0YA1**

Overview



ISO	TCP/UDP	PN	MRP	IT	IP-R	PG/OP	S7/S5
	●	●	●			●	●

- Interface for the SIMATIC S7-300 to Industrial Ethernet (not for SINUMERIK)
 - 2 x RJ45 interface for 10/100 Mbps full/half duplex connection (with autosensing for automatic switchover and autocrossover function)
 - Integral 2-port real-time switch ERTEC
 - Multi-protocol operation with TCP and UDP transport protocol and PROFINET IO
 - Keep-alive function
- Communications services:
 - Open communication (TCP/IP and UDP)
 - PG/OP communication
 - S7 communication (server)
 - PROFINET IO device
- Multicast for UDP
- Remote programming and initial commissioning is possible over Industrial Ethernet
- IT communication
 - Web function
- Integration into network management through SNMP
- Configuration with STEP 7
- Cross-network PG/OP communication by means of S7 routing
- Diagnostics possibilities in STEP 7 and via web browser

Note:

SIPLUS extreme products are based on SIMATIC standard products. The contents listed here were taken from the respective standard products. SIPLUS extreme-specific information was added.

SIPLUS S7-300 CP 343-1 Lean		
Article No.	6AG1343-1CX10-2XE0	6AG1343-1CX10-4XE0
Article No. based on	6GK7343-1CX10-0XE0	6GK7343-1CX10-0XE0
Ambient temperature range	-25 ... +60 °C	0 ... +60 °C
Conformal coating	Coating of the printed circuit boards and the electronic components	
Technical data	The technical data of the standard product applies except for the ambient conditions.	
Ambient conditions		
Relative humidity	100%, condensation/frost permissible. No commissioning if condensation present.	
Biologically active substances, compliance with EN 60721-3-3	Class 3B2 mold and fungal spores (excluding fauna). The supplied plug covers must remain in place over the unused interfaces during operation!	
Chemically active substances, compliance with EN 60721-3-3	Class 3C4 incl. salt spray in accordance with EN60068-2-52 (degree of severity 3). The supplied plug covers must remain in place over the unused interfaces during operation!	
Mechanically active substances, compliance with EN 60721-3-3	Class 3S4 incl. sand, dust. The supplied plug covers must remain in place over the unused interfaces during operation!	
Air pressure (depending on the highest positive temperature range specified)	1 080 ... 795 hPa (-1 000 ... +2 000 m) see ambient temperature range 795 ... 658 hPa (+2 000 ... +3 500 m) derating 10 K 658 ... 540 hPa (+3 500 ... +5 000 m) derating 20 K	

For technical documentation on SIPLUS, see:

<http://www.siemens.com/siplus-extreme>

SIMATIC S7-300 Advanced Controllers

I/O modules

SIPLUS S7-300 communication

SIPLUS S7-300 CP 343-1 Lean**Ordering data****Article No.****SIPLUS CP 343-1 Lean communications processor**

For connecting SIMATIC S7-300 to Industrial Ethernet through TCP/IP and UDP, Multicast, S7 communication, open communication (SEND/RECEIVE), FETCH/WRITE, PROFINET IO device, integral 2-port switch ERTEC, comprehensive diagnostics facilities, module replacement without PG, SNMP, initial commissioning over LAN; with electronic manual on CD-ROM

For industrial applications with extended ambient conditions

Extended temperature range and exposure to media

6AG1343-1CX10-2XE0**Accessories***Consumables***IE FC RJ45 Plug 180**

(extended temperature range and exposure to media)

180° cable outlet

- 1 unit

6AG1901-1BB10-7AA0**Article No.****IE FC TP Standard Cable GP 2 x 2 (Type A)**

4-wire, shielded TP installation cable for connection to IE FC outlet RJ45/IE FC RJ45 plug; PROFINET-compliant; with UL approval; sold by the meter; max. length per delivery unit 1000 m, minimum order 20 m

6XV1840-2AH10**IE FC stripping tool**

Preadjusted stripping tool for fast stripping of Industrial Ethernet FC cables

6GK1901-1GA00*Programming tools***STEP 7 Version 5.5**

See Chapter 11

STEP 7 Professional V14 SP1

See Chapter 11

SOFTNET S7 for Industrial Ethernet

Software for S7 and open communication, incl. OPC server, PG/OP communication, and NCM PC/STEP 7 Professional V12, runtime software, software and electronic manual on CD-ROM, license key on USB stick, Class A

See Catalog IK PI

Overview



ISO	TCP/UDP	PN	MRP	IT	IP-R	PG/OP	S7/S5
●	●	●	●			●	●

- Connection of SIMATIC S7-300/SINUMERIK 840D powerline to Industrial Ethernet
 - 2 x RJ45 interface for 10/100 Mbps full/half-duplex connection with autosensing/autonegotiation and autocrossover function
 - Integrated 2-port real-time switch ERTEC
 - Multi-protocol operation with ISO, TCP, UDP transport protocol and PROFINET IO
 - Adjustable keep-alive function
- Communications services:
 - Open communication (ISO, TCP/IP, and UDP)
 - PROFINET IO controller or PROFINET IO device
 - PG/OP communication: Cross-network by means of S7 routing
 - S7 communication (client, server, multiplexing)
- Media redundancy (MRP); within an Ethernet network with ring topology, the CP supports the media redundancy procedure MRP (V2.2 or higher).
- Multicast for UDP
- IP address assignment via DHCP, simple PC tool or via the user program (e.g. HMI)
- Access protection via configurable access list
- Remote programming and commissioning via Industrial Ethernet
- Configuration with STEP 7
- Automatic setting of CPU clock setting over Ethernet with NTP or SIMATIC procedure
- Web diagnostics
- Integration in network management systems via SNMP (MIB2 diagnostics information)
- Diagnostics possibilities in STEP 7 and via web browser

Note:

SIPLUS extreme products are based on SIMATIC standard products. The contents listed here were taken from the respective standard products. SIPLUS extreme specific information was added.

SIPLUS CP 343-1	
Article No.	6AG1343-1EX30-7XE0
Article No. based on	6GK7343-1EX30-0XE0
Ambient temperature range	-25 ... +70 °C
Conformal coating	Coating of the printed circuit boards and the electronic components
Technical data	The technical data of the standard product applies except for the ambient conditions.
Ambient conditions	
Relative humidity	100%, condensation/frost permissible. No commissioning if condensation present.
Biologically active substances, compliance with EN 60721-3-3	Class 3B2 mold and fungal spores (excluding fauna). The supplied plug covers must remain in place over the unused interfaces during operation!
Chemically active substances, compliance with EN 60721-3-3	Class 3C4 incl. salt spray in accordance with EN60068-2-52 (degree of severity 3). The supplied plug covers must remain in place over the unused interfaces during operation!
Mechanically active substances, compliance with EN 60721-3-3	Class 3S4 incl. sand, dust. The supplied plug covers must remain in place over the unused interfaces during operation!
Air pressure (depending on the highest positive temperature range specified)	1 080 ... 795 hPa (-1 000 ... +2 000 m) see ambient temperature range 795 ... 658 hPa (+2000 ... +3500 m) derating 10 K 658 ... 540 hPa (+3 500 ... +5 000 m) derating 20 K

For further technical documentation on SIPLUS, see:

<http://www.siemens.com/siplus-extreme>

SIMATIC S7-300 Advanced Controllers

I/O modules

SIPLUS S7-300 communication

SIPLUS S7-300 CP 343-1**Ordering data****Article No.****Article No.****SIPLUS S7-300 CP 343-1 communications processor**

For connection of SIMATIC S7-300 to Industrial Ethernet over ISO and TCP/IP; PROFINET IO controller or PROFINET IO device, MRP, integrated 2-port switch ERTEC; S7 communication, open communication (SEND/RECEIVE), FETCH/WRITE, with and without RFC 1006, multicast, DHCP, CPU clock synchronization via SIMATIC procedure and NTP, diagnostics, SNMP, access protection through IP access list, initialization over LAN 10/100 Mbps; with electronic manual on DVD

For industrial applications with extended ambient conditions

Extended temperature range and exposure to media

6AG1343-1EX30-7XE0**Accessories***Consumables***IE FC RJ45 Plug 180**

(extended temperature range and exposure to media)

180° cable outlet

- 1 unit

6AG1901-1BB10-7AA0**C-PLUG****6AG1900-0AB00-7AA0**

Swap medium for simple replacement of devices in the event of a fault; for storing configuration or engineering and application data; can be used for SIMATIC NET products with C-PLUG slot, -40 ... +70 °C, medial exposure

IE FC TP Standard Cable GP 2 x 2 (Type A)**6XV1840-2AH10**

4-wire, shielded TP installation cable for connection to IE FC outlet RJ45/IE FC RJ45 plug; PROFINET-compliant; with UL approval; sold by the meter; max. length per delivery unit 1000 m, minimum order 20 m

IE FC stripping tool**6GK1901-1GA00**

Preadjusted stripping tool for fast stripping of Industrial Ethernet FC cables

Communication within the application

SIPLUS SCALANCE X-200 Industrial Ethernet switches

Industrial Ethernet switches with integral SNMP access, online diagnostics, copper cable diagnostics and PROFINET diagnostics for configuring line, star and ring topologies; with integrated redundancy manager (exception: SCALANCE X208PRO); incl. operating instructions, Industrial Ethernet network manual and configuration software on CD-ROM

- With electrical and optical ports for glass multimode FOC up to 3 km
- Extended temperature range and exposure to media
- **SIPLUS SCALANCE X204-2** with four 10/100 Mbps RJ45 ports and two fiber-optic ports

6AG1204-2BB10-4AA3

Programming tools

STEP 7 Version 5.5

See Chapter 11

STEP 7 Professional V14 SP1

See Chapter 11

SOFTNET S7 for Industrial Ethernet

See Catalog IK PI

Software for S7 and open communication, incl. OPC server, PG/OP communication, and NCM PC/STEP 7 Professional V12, runtime software, software and electronic manual on CD-ROM, license key on USB stick, Class A

Overview



ISO	TCP/UDP	PN	MRP	IT	IP-R	PG/OP	S7/S5
●	●	●	●	●	●	●	●

- Connection of SIMATIC S7-300/SINUMERIK 840D powerline to Industrial Ethernet
 - Multi-protocol operation with TCP and UDP transport protocol
 - Adjustable keep-alive function
- Two separate interfaces (integrated network separation):
 - Gigabit interface with one RJ45 port with 10/100/1 000 Mbps, full/half-duplex with autosensing capability
 - PROFINET interface with two RJ45 ports with 10/100 Mbps full/half-duplex with autosensing and autocrossover functionality via integrated 2-port switch
- Communications services via both interfaces:
 - Open communication (TCP/IP and UDP): Multicast with UDP, including routing between both interfaces
 - PG/OP communication:
 - Cross-network by means of S7 routing
 - S7 communication (client, server, multiplexing) including routing between both interfaces
 - IT communication:
 - HTTP communication supports access to process data via own web pages;
 - e-mail client function, sending of e-mails directly from user program;
 - FTP communication supports program-controlled FTP client communication;
 - access to data blocks through FTP server
- Communications services via PROFINET interfaces:
 - PROFINET IO controller and IO device with real-time properties (RT and IRT)¹⁾
 - PROFINET CBA
 - IP address assignment via DHCP, simple PC tool or via program block (e.g. for HMI)
 - Configuration with STEP 7

- Media redundancy (MRP); within an Ethernet network with ring topology, the CP supports the media redundancy procedure MRP (V2.2 or higher).
- Access protection by means of configurable IP access list
- Module replacement without programming device; all information is stored on the C-PLUG (also file system for IT functions)
- Extensive diagnostic functions for all modules in the rack
- IT communication
 - Web function
 - E-mail function
 - FTP
- Integration into network management systems through the support of SNMP V1 MIB-II

Note:

SIPLUS extreme products are based on SIMATIC standard products. The contents listed here were taken from the respective standard products. SIPLUS extreme-specific information was added.

SIPLUS S7-300 CP 343-1 Advanced

Article No.	6AG1343-1GX31-4XE0
Article No. based on	6GK7343-1GX31-0XE0
Ambient temperature range	0 ... +60 °C
Conformal coating	Coating of the printed circuit boards and the electronic components
Technical data	The technical data of the standard product applies, except for the ambient conditions.
Ambient conditions	
Relative humidity	100%, condensation/frost permissible. No commissioning if condensation present.
Biologically active substances, compliance with EN 60721-3-3	Class 3B2 mold and fungal spores (excluding fauna). The supplied plug covers must remain in place over the unused interfaces during operation!
Chemically active substances, compliance with EN 60721-3-3	Class 3C4 incl. salt spray in accordance with EN60068-2-52 (degree of severity 3). The supplied plug covers must remain in place over the unused interfaces during operation!
Mechanically active substances, compliance with EN 60721-3-3	Class 3S4 incl. sand, dust. The supplied plug covers must remain in place over the unused interfaces during operation!
Air pressure (depending on the highest positive temperature range specified)	1080 ... 795 hPa (-1 000 ... +2 000 m) see ambient temperature range 795 ... 658 hPa (+2 000 ... +3 500 m) derating 10 K 658 ... 540 hPa (+3 500 ... +5 000 m) derating 20 K

For technical documentation on SIPLUS, see:

<http://www.siemens.com/siplus-extreme>

¹⁾ possible combinations in parallel operation:
 - IO controller with IRT and IO device with RT
 - IO controller with RT and IO device using IRT

SIMATIC S7-300 Advanced Controllers

I/O modules

SIPLUS S7-300 communication

SIPLUS S7-300 CP 343-1 Advanced**Ordering data****Article No.****Article No.****SIPLUS S7-300 CP 343-1
Advanced communications
processor**

for connecting the SIMATIC S7-300 to Industrial Ethernet, PROFINET IO controller and IO device with RT and IRT, MRP, PROFINET CBA, TCP/IP and UDP, S7 communication, open communication (SEND/RECEIVE), FETCH/WRITE with or without RFC 1006, diagnostics extensions, multicast, web server, HTML diagnostics, FTP server, FTP client, e-mail client, CPU clock set via SIMATIC procedure and NTP, access control via IP access List, SNMP, DHCP, initialization over LAN 10/100 Mbps; with electronic manual on DVD; C-PLUG included

For industrial applications with extended ambient conditions

Exposure to media

6AG1343-1GX31-4XE0**Accessories***Consumables***IE FC RJ45 Plug 180**

(extended temperature range and exposure to media)

180° cable outlet

- 1 unit

6AG1901-1BB10-7AA0**C-PLUG****6AG1900-0AB00-7AA0**

Swap medium for simple replacement of devices in the event of a fault; for storing configuration or engineering and application data; can be used for SIMATIC NET products with C-PLUG slot, -40 ... +70 °C, medial exposure

**IE FC TP Standard Cable GP 2 x 2
(Type A)****6XV1840-2AH10**

4-wire, shielded TP installation cable for connection to IE FC outlet RJ45/IE FC RJ45 plug; PROFINET-compliant; with UL approval; sold by the meter; max. length per delivery unit 1000 m, minimum order 20 m

IE FC TP Standard Cable GP 4 x 2

8-wire, shielded TP installation cable for universal applications; with UL approval; sold by the meter; max. length per delivery unit 1000 m, minimum order 20 m

- AWG22, for connection to IE FC RJ45 Modular Outlet
- AWG24, for connecting to IE FC RJ45 Plug 4 x 2, IE FC M12 Plug PRO 4 x 2

6XV1870-2E**6XV1878-2A****IE FC stripping tool****6GK1901-1GA00**

Preadjusted stripping tool for fast stripping of Industrial Ethernet FC cables

Communication within the application

**SIPLUS SCALANCE X-200
Industrial Ethernet switches**

Industrial Ethernet switches with integral SNMP access, online diagnostics, copper cable diagnostics and PROFINET diagnostics for configuring line, star and ring topologies; with integrated redundancy manager (exception: SCALANCE X208PRO); incl. operating instructions, Industrial Ethernet network manual and configuration software on CD-ROM

- With electrical and optical ports for glass multimode FOC up to 3 km
- Extended temperature range and exposure to media
- SIPLUS SCALANCE X204-2 with four 10/100 Mbps RJ45 ports and two FO ports

6AG1204-2BB10-4AA3*Programming tools***STEP 7 Version 5.5**

See Chapter 11

STEP 7 Professional V14 SP1

See Chapter 11

**SOFTNET S7
for Industrial Ethernet**

See Catalog IK PI

Software for S7 and open communication, incl. OPC server, PG/OP communication, and NCM PC/STEP 7 Professional V12, runtime software, software and electronic manual on CD-ROM, license key on USB stick, Class A

SIMATIC iMap

See Chapter 11

Overview



- SINAUT communication module SIPLUS TIM for SIMATIC S7-300 for use in a wide area network (WAN)
- IP communication via secure VPN (virtual private network) using the Internet
- Wireless communication via GPRS router, GPRS modem, or radio devices
- Wired communication via Ethernet, DSL, dial-up modems or dedicated line modem
- Complete migration of existing wireless, dedicated line and dial-up technology to IP-based network
- Message frame memory for seamless recording of data
- Simple configuration and operation without specialist IT knowledge

Note:

SIPLUS extreme products are based on SIMATIC standard products. The contents listed here were adopted from the respective standard products. SIPLUS extreme specific information was added.

SIPLUS TIM 3V-IE	
Article No.	6AG1800-3BA00-7AA0
Article No. based on	6NH7800-3BA00
Ambient temperature range	-25 ... +70 °C; 60 °C @ UL/cUL, ATEX and FM use
Conformal coating	Coating of the printed circuit boards and the electronic components
Technical specifications	The technical data of the standard product applies except for the ambient conditions.
Ambient conditions	
Relative humidity	100%, condensation/frost permissible. No commissioning if condensation present.
Biologically active substances, compliance with EN 60721-3-3	Class 3B2 mold and fungal spores (excluding fauna). The supplied plug covers must remain in place over the unused interfaces during operation!
Chemically active substances, compliance with EN 60721-3-3	Class 3C4 incl. salt spray in accordance with EN60068-2-52 (degree of severity 3). The supplied plug covers must remain in place over the unused interfaces during operation!
Mechanically active substances, compliance with EN 60721-3-3	Class 3S4 incl. sand, dust. The supplied plug covers must remain in place over the unused interfaces during operation!
Air pressure (depending on the highest positive temperature range specified)	1 080 ... 795 hPa (-1 000 ... +2 000 m) 795 ... 658 hPa (+2000 ... +3500 m) derating 10 K 658 ... 540 hPa (+3500 ... +5000 m) derating 20 K

Technical documentation on SIPLUS can be found here:
<http://www.siemens.com/siplus-extreme>

Ordering data

Ordering data	Article No.	Ordering data	Article No.
SIPLUS ST7 TIM 3V-IE communication module With an RS 232 interface for SINAUT communication via a conventional WAN or an IP-based network (WAN or LAN)	6AG1800-3BA00-7AA0	IE FC RJ45 plug 180 RJ45 plug connector for Industrial Ethernet with a rugged metal housing and integrated insulation displacement contacts for connecting Industrial Ethernet FC installation cables; with 180° cable outlet; for network components and CPs/CPU's with Industrial Ethernet interface • 1 pack = 1 unit, -40 ... +70 °C, medial exposure	
Accessories <i>Consumables</i> IE FC TP Standard Cable GP 2 x 2 (Type A) 4-wire, shielded TP installation cable for connection to IE FC Outlet RJ45/IE FC RJ45 Plug; PROFINET-compliant; with UL approval; sold by the meter; max. length 1000 m, minimum order 20 m	6XV1840-2AH10	IE FC stripping tool Preadjusted stripping tool for fast stripping of the Industrial Ethernet FC cables	6AG1901-1BB10-7AA0 6GK1901-1GA00

SIMATIC S7-300 Advanced Controllers

I/O modules

SIPLUS S7-300 communication

SIPLUS TIM 4R-IE for WAN and Ethernet

Overview



- SINAUT communication module SIPLUS TIM with four interfaces for SIMATIC S7-300 or as self-contained unit for the S7-400 for use in a wide area network (WAN)
- For universal use in a SINAUT station, node station and control center
- Internet communication via integrated MSC-VPN tunnel with direct connection to DSL router or operation via IPsec VPN with additional SIMATIC NET components
- Wireless communication via GPRS router, GPRS modem, or radio devices
- Wired communication via Ethernet, DSL, dial-up modems or dedicated line modem
- Complete migration of existing wireless, dedicated line and dial-up technology to IP-based network
- Message frame memory for seamless recording of data and support of redundant communication paths
- Simple configuration and operation without specialist IT knowledge

Note:

SIPLUS extreme products are based on SIMATIC standard products. The contents listed here were adopted from the respective standard products. SIPLUS extreme specific information was added.

SIPLUS TIM 4R-IE	
Article No.	6AG1800-4BA00-7AA0
Article No. based on	6NH7800-4BA00
Ambient temperature range	-25 ... +70 °C; 60 °C @ UL/cUL, ATEX and FM use
Conformal coating	Coating of the printed circuit boards and the electronic components
Technical specifications	The technical data of the standard product applies except for the ambient conditions.
Ambient conditions	
Relative humidity	100%, condensation/frost permissible. No commissioning if condensation present.
Biologically active substances, compliance with EN 60721-3-3	Class 3B2 mold and fungal spores (excluding fauna). The supplied plug covers must remain in place over the unused interfaces during operation!
Chemically active substances, compliance with EN 60721-3-3	Class 3C4 incl. salt spray in accordance with EN60068-2-52 (degree of severity 3). The supplied plug covers must remain in place over the unused interfaces during operation!
Mechanically active substances, compliance with EN 60721-3-3	Class 3S4 incl. sand, dust. The supplied plug covers must remain in place over the unused interfaces during operation!
Air pressure (depending on the highest positive temperature range specified)	1 080 ... 795 hPa (-1 000 ... +2 000 m) see ambient temperature range 795 ... 658 hPa (+2000 ... +3500 m) derating 10 K 658 ... 540 hPa (+3500 ... +5000 m) derating 20 K

Technical documentation on SIPLUS can be found here:
<http://www.siemens.com/siplus-extreme>

Ordering data

Ordering data	Article No.	Ordering data	Article No.
SIPLUS ST7 TIM 4R-IE communication module With two combined RS 232/RS 485 interfaces for SINAUT communication via conventional WANs and two RJ45 interfaces for SINAUT communication via IP-based networks (WAN or LAN)	6AG1800-4BA00-7AA0	IE FC RJ45 plug 180 RJ45 plug connector for Industrial Ethernet with a rugged metal housing and integrated insulation displacement contacts for connecting Industrial Ethernet FC installation cables; with 180° cable outlet; for network components and CPs/CPU's with Industrial Ethernet interface • 1 pack = 1 unit; -40 ... +70 °C, medial exposure	6AG1901-1BB10-7AA0
Accessories <i>Consumables</i> IE FC TP Standard Cable GP 2 x 2 (Type A) 4-wire, shielded TP installation cable for connection to IE FC Outlet RJ45/IE FC RJ45 Plug; PROFINET-compliant; with UL approval; sold by the meter; max. length 1000 m, minimum order 20 m	6XV1840-2AH10	IE FC stripping tool Preadjusted stripping tool for fast stripping of the Industrial Ethernet FC cables	6GK1901-1GA00

Overview



- Simulator module for program testing during commissioning and ongoing operation
- For the simulation of sensor signals using switches
- For display of signal conditions on the outputs using LED
- Simulation of
 - 16 inputs or
 - 16 outputs or
 - 8 inputs and 8 outputs
- Function can be directly adjusted on the module using a screwdriver

Technical specifications

Article number	6ES7374-2XH01-0AA0 SM 374 SIMULATOR MODULE 16I/16O
Input current	
from backplane bus 5 V DC, max.	80 mA
Power loss	
Power loss, typ.	0.35 W
Digital inputs	
Number of digital inputs	16; Switch
Digital outputs	
Number of digital outputs	16; LEDs

Article number	6ES7374-2XH01-0AA0 SM 374 SIMULATOR MODULE 16I/16O
Potential separation	
Potential separation digital inputs	
• between the channels and backplane bus	No
Potential separation digital outputs	
• between the channels and backplane bus	No
Dimensions	
Width	40 mm
Height	125 mm
Depth	120 mm
Weights	
Weight, approx.	190 g

Ordering data

Ordering data	Article No.
SM 374 simulator module incl. bus connectors, labeling strips	6ES7374-2XH01-0AA0
Bus connectors 1 unit, spare part	6ES7390-0AA00-0AA0
Labeling strips 10 units (spare part)	6ES7392-2XX00-0AA0
Label cover 10 units (spare part)	6ES7392-2XY00-0AA0

Ordering data	Article No.
Labeling sheets for machine inscription for modules with 20-pin front connector, DIN A4, for printing with laser printer; 10 units	
Petrol	6ES7392-2AX00-0AA0
Light beige	6ES7392-2BX00-0AA0
Yellow	6ES7392-2CX00-0AA0
Red	6ES7392-2DX00-0AA0

SIMATIC S7-300 Advanced Controllers

I/O modules

Special modules

DM 370 dummy module**Overview**

- Dummy module for reserving slots for non-parameterized signal modules
- Structure and address allocation is retained when replaced with a signal module

Technical specifications

Article number	6ES7370-0AA01-0AA0 DM 370 DUMMY MODULE
Input current	
from backplane bus 5 V DC, max.	5 mA
Power loss	
Power loss, max.	0.03 W
Digital inputs	
Number of digital inputs	0
Digital outputs	
Number of digital outputs	0
Dimensions	
Width	40 mm
Height	125 mm
Depth	120 mm
Weights	
Weight, approx.	180 g

Ordering data**Article No.**

DM 370 dummy module	6ES7370-0AA01-0AA0
incl. bus connectors, labeling strips	
Bus connectors	6ES7390-0AA00-0AA0
1 unit, spare part	
Labeling strips	6ES7392-2XX00-0AA0
10 units (spare part)	
Label cover	6ES7392-2XY00-0AA0
10 units (spare part)	
Labeling sheets for machine inscription	
for modules with 20-pin front connector, DIN A4, for printing with laser printer; 10 units	
Petrol	6ES7392-2AX00-0AA0
Light beige	6ES7392-2BX00-0AA0
Yellow	6ES7392-2CX00-0AA0
Red	6ES7392-2DX00-0AA0

Overview



- Dummy module for reserving slots for unconfigured signal modules
- Retention of design and address assignment when replacing with a signal module

Note:

SIPLUS extreme products are based on SIMATIC standard products. The contents listed here were taken from the respective standard products. SIPLUS extreme-specific information was added.

Technical specifications

Article number	6AG1370-0AA01-7AA0
Based on	6ES7370-0AA01-0AA0 SIPLUS S7-300 Dummy module
Input current	
from backplane bus 5 V DC, max.	5 mA
Power loss	
Power loss, max.	0.03 W
Digital inputs	
Number of digital inputs	0
Digital outputs	
Number of digital outputs	0
Standards, approvals, certificates	
CE mark	Yes
Ambient conditions	
Ambient temperature during operation	
• min.	-40 °C; = Tmin
• max.	70 °C; = Tmax; 60 °C @ UL/cUL, ATEX and FM use
Extended ambient conditions	
• relative to ambient temperature-atmospheric pressure-installation altitude	Tmin ... Tmax at 1080 hPa ... 795 hPa (-1000 m ... +2000 m) // Tmin ... (Tmax - 10K) at 795 hPa ... 658 hPa (+2000 m ... +3500 m) // Tmin ... (Tmax - 20K) at 658 hPa ... 540 hPa (+3500 m ... +5000 m)
Relative humidity	
- With condensation, tested in accordance with IEC 60068-2-38, max.	100 %; RH incl. condensation/frost (no commissioning under condensation conditions)

Article number	6AG1370-0AA01-7AA0
Based on	6ES7370-0AA01-0AA0 SIPLUS S7-300 Dummy module
Resistance	
- against biologically active substances / conformity with EN 60721-3-3	Yes; Class 3B2 mold, fungus and dry rot spores (with the exception of fauna). The supplied connector covers must remain on the unused interfaces during operation!
- against chemically active substances / conformity with EN 60721-3-3	Yes; Class 3C4 (RH < 75%) incl. salt spray according to EN 60068-2-52 (degree of severity 3). The supplied connector covers must remain on the unused interfaces during operation!
- against mechanically active substances / conformity with EN 60721-3-3	Yes; Class 3S4 incl. sand, dust. The supplied connector covers must remain on the unused interfaces during operation!
Dimensions	
Width	40 mm
Height	125 mm
Depth	120 mm
Weights	
Weight, approx.	180 g

SIMATIC S7-300 Advanced Controllers

I/O modules

SIPLUS S7-300 special modules

SIPLUS S7-300 DM 370**Ordering data****Article No.****SIPLUS S7-300****DM 370 dummy module**

for use when replacing modules

Extended temperature range and exposure to media

6AG1370-0AA01-7AA0**Accessories***Consumables***Bus connectors**

1 unit (spare part)

6ES7390-0AA00-0AA0**Labeling strips**

10 units (spare part)

For modules with 20-pin front connector

6ES7392-2XX00-0AA0**Article No.****Label cover**

10 units (spare part)

For modules with 20-pin front connector

6ES7392-2XY00-0AA0**Labeling sheets for machine printing**

For modules with 20-pin front connector, DIN A4, for printing with laser printer; 10 units

Petrol

6ES7392-2AX00-0AA0

Light beige

6ES7392-2BX00-0AA0

Yellow

6ES7392-2CX00-0AA0

Red

6ES7392-2DX00-0AA0

Overview



- For the simple and user-friendly connection of sensors and actuators to the S7-300 I/O modules
- For maintaining the wiring when replacing modules ("permanent wiring")
- With mechanical coding to avoid errors when replacing modules

Ordering data

Article No.

Front connectors

20-pin, with screw contacts

- 1 unit
- 100 units

6ES7392-1AJ00-0AA0
6ES7392-1AJ00-1AB0

20-pin, with spring-loaded contacts

- 1 unit
- 100 units

6ES7392-1BJ00-0AA0
6ES7392-1BJ00-1AB0

40-pin, with screw contacts

- 1 unit
- 100 units

6ES7392-1AM00-0AA0
6ES7392-1AM00-1AB0

40-pin, with spring-loaded contacts

- 1 unit
- 100 units

6ES7392-1BM01-0AA0
6ES7392-1BM01-1AB0

Front door, elevated design

6ES7328-0AA00-7AA0

e.g. for 32 channel modules;
enables connection of
1.3 mm²/16 AWG wires

**Front door, higher version,
for F-modules**

6ES7328-7AA10-0AA0

For F-modules; for connecting
1.3 mm²/16 AWG wires;
wiring diagram and labels in yellow

SIMATIC S7-300 Advanced Controllers

I/O modules

Connection system

System cabling for SIMATIC S7-300/400 and ET 200M

Overview

Wiring of SIMATIC S7 I/O modules with the sensors/actuators is a significant factor with respect to time/cost overhead, configuring, control cabinet installation, procurement and ease of service.

With SIMATIC TOP connect system cabling, it is simple and quick to establish a reliable connection for your SIMATIC S7-300 or ET 200M.

With the TIA Selection Tool, a mouse click is all that is required to configure the connection from the SIMATIC S7 module to the I/O. The program automatically checks for plausibility and generates a parts list for the selected connection components that can then be ordered in the Industry Mall.

More information can be found on the Internet at

<http://www.siemens.com/tia-selection-tool>

Design

Two cabling variants are available for a wide range of control cabinet concepts:

Fully modular connection

Each component is individually inserted.

The system consists of:

- Front connector module
- Connecting cable
- Connection modules in the following versions: Basic module, signal module and function module

Connection errors are thus practically excluded and installation overhead is minimized. Systematic connection of the SIMATIC system. The assembly overhead for the connecting cables is drastically reduced thanks to the use of pre-assembled or easily assembled cables sold by the meter.

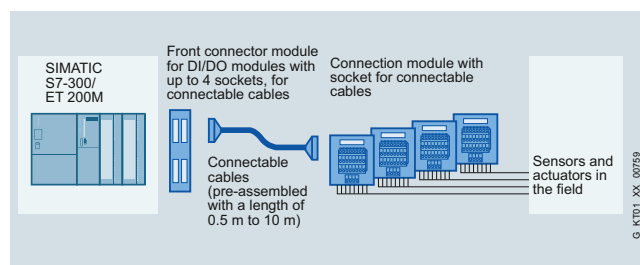

SIMATIC TOP connect for S7-300/ ET200M, fully modular connection

Flexible connection

Consisting of:

- Front connector with screw-type or crimp connection
- Front connector with fixed single cores
- Single cores also available with UL/CSA-certified cores

The blue wires are numbered sequentially and can be routed direct to each element in the control cabinet. The numbering of the single cores corresponds to the coding of the front connector contacts.

In comparison to conventional single wiring, there is a cost saving of 50% for assembly, since the single cores that have already been checked on the connector are fixed.

Thus no complex pre-assembly of up to two times 46 single cores per module is necessary.

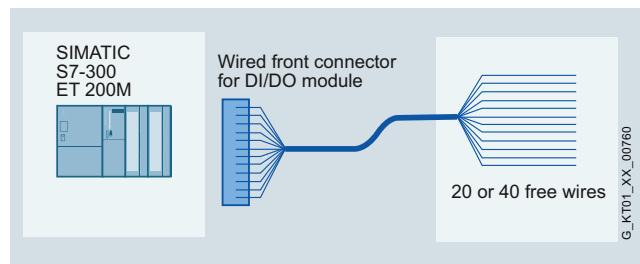

SIMATIC TOP connect for S7-300/ET200M, flexible connection

Overview



The fully modular connection for connecting to the digital I/O modules of the SIMATIC S7-1500 or ET 200MP consists of modified front connectors, called front connector modules, pre-assembled connecting cables of various lengths, and connection modules. Suitable components can be selected for the application in question and joined by means of simple plugs. The connection modules are used instead of conventional terminal blocks and act as the interface to the sensors and actuators.

Benefits

- Easy plugging in of front connector module, connecting cable and connection module
- Fast and low-cost wiring
- Supply voltage connectable to front connector module or connection module for digital and analog signals
- Reduction in wiring errors, clear control cabinet wiring
- Distribution of digital signals by byte or by double-byte
- Each component can be replaced individually.
- Every cable length can be configured without cutting, or pre-assembled cables can be used

Design

Front connector module

Modified front connectors, called front connector modules, are available for connecting to the module. These are plugged into the module to be wired instead of the front connector. The front connector modules are available in many different digital and analog versions. The connecting cables are plugged into these front connector modules.

Connecting cable

The connecting cable is available in two different versions.

As a pre-assembled 16-pole or 50-pole round cable (shielded or unshielded) up to a length of 10 m, or as a 16-pole round-sheath ribbon cable (with or without shield), which can be easily assembled by the user; or as 2 x 16-pole round-sheath ribbon cables (without shield).

When assembled, there are one or two insulation displacement connectors (female ribbon connectors) at both ends of the cable.

The round-sheath ribbon cable is assembled by the user with the aid of pliers (can be ordered separately). The cable transmits 8 or 2 x 8 channels over a distance of up to 30 m.

The connecting cable connects the front connector module with the connection module.

Connection module

The system has digital and analog connection modules for connecting the I/O signals. These are snapped onto the standard DIN rail. The connection modules with basic or signal functionality are available in 1-byte or 4-byte versions.

Connection modules are available for two different connection methods: with push-in or screw terminals. The potential can be fed in at the connection module or at the front connector module.

If other voltage or power levels are required in the field, the connection module for TPRo or TPOo output signals is used. For the TPRo connection module, relays are used for the implementation. For the TPOo connection module, optocouplers are used for the implementation. This converts the 24 V DC output signal simply and reliably to another voltage or power level. If 230 V AC or 110 V AC input signals have to be transmitted to the controller in the field, a connection module with relay TPRi is available that simply converts the 230/110 V AC signal to 24 V DC. This means that there is always the same voltage level on the module side.

Use with optocouplers for the TPRo relay modules

If higher switching frequencies of the relay connection module are required for the output signals, the relay can simply be replaced with an optocoupler (note technical specifications) in order to increase the switching frequency.

Shield plate

The shield plate is latched onto the connection module for 3-wire initiators or optionally onto the connection module for analog signals and then snapped onto the DIN rail with the connection module. With the shield connection clamps, optimal shield connection is achieved between the shielded round-sheath ribbon cable or the shielded field cables and the grounded DIN rail.

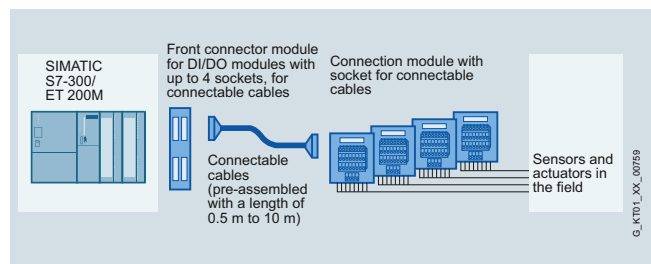

SIMATIC TOP connect for S7-300/ ET200 M, fully modular connection

SIMATIC S7-300 Advanced Controllers

I/O modules

Connection system

System cabling for SIMATIC S7-300/400 and ET 200M > Fully modular connection**Technical specifications front connector module**

Technical data of front connector module	
Rated operating voltage	24 VDC
Max. permissible operating voltage	60 V DC
Max. permissible continuous current • per connector pin	1 A
Max. permissible summation current	4 A/byte
Permissible ambient temperature	0 to + 60°C
Test voltage	0.5 kV, 50 Hz, 60 sec.
Air gaps and creepage distances	IEC 664 (1980), IEC 664 A (1981), in accordance with DIN VDE 0110 (01.89), overvoltage class II, pollution degree 2

Wiring rules for front connector modules

Front connector module SIMATIC TOP connect, connection for potential infeed	
Spring connection Screw connection	
Modules up to 4 connections	
Connectable cable cross-sections	
• solid cables	No
• flexible cables with/without wire end ferrule	0,25 to 1.5 mm ²
Number of wires per connection	1 or a combination of 2 conductors up to 1.5 mm ² (total) in a common wire end ferrule
Max. diameter of the cable insulation	3.1 mm
Stripping length of the cables	
• without insulating collar	6 mm
• with insulating collar	-
Wire-end ferrules in acc. with DIN 46228	
• without insulating collar	Form A; 5 to 7 mm long
• with insulating collar 0.25 to 1.0 mm ²	-
• with insulating collar 1.5 mm ²	-
Blade width of the screwdriver	3.5 mm (cylindrical shape)
Tightening torque for connecting the cables	- 0.4 to 0.7 Nm

**Front connector module
SIMATIC TOP connect,
connection for potential infeed**

Spring connection Screw connection

Modules up to 8 connections

Connectable cable cross-sections	
• solid cables	No
• flexible cables with/without wire end ferrule	0.25 to 0.75 mm ²
Number of cables per connection	1 or a combination of 2 wires up to 0.75 mm ² (total) in a common wire end ferrule
Max. diameter of the cable insulation	2.0 mm
Stripping length of the cables	
• without insulating collar	6 mm
• with insulating collar	-
Wire-end ferrules in acc. with DIN 46228	
• without insulating collar	Form A; 5 to 7 mm long
• with insulating collar 0.25 to 1.0 mm ²	-
• with insulating collar 1.5 mm ²	-
Blade width of the screwdriver	3.5 mm (cylindrical shape)
Tightening torque for connecting the cables	- 0.4 to 0.7 Nm

Technical specifications connecting cable

Technical specifications of connecting cable from SIMATIC S7 to connection module	
Operating voltage	60 V DC
Continuous current per signal conductor	1 A
Max. aggregate current	4 A/byte
Operating temperature	0 to +60 °C
Outer diameter of pre-assembled round cable in mm unshielded/shielded (16-pole)	Approx. 6.5/7.0
Outer diameter of round-sheath ribbon cable in mm 16-pole/2 x 16-pole	approx. 9.5/11.5

Ordering data	Article No.	Article No.
Front connection modules		
Front connector module (compact CPU 312C) Power supply via • Screw terminals	6ES7921-3AK20-0AA0	Front connector module (1 x 8 outputs) for 2 ampere digital outputs Power supply via • Spring-loaded terminals • Screw terminals
Front connector module (compact CPU 313C/314C-2PtP/314C-2DP), slot X1 Power supply via • Screw terminals	6ES7921-3AM20-0AA0	Front connector module 20-pin (analog) Power supply via • Spring-loaded terminals • Screw terminals
Front connector module (digital 2 x 8 I/O) Power supply via • Spring-loaded terminals • Screw terminals	6ES7921-3AA00-0AA0 6ES7921-3AB00-0AA0	Front connector module 40-pin (analog) Power supply via • Spring-loaded terminals • Screw terminals
Front connector module (digital 4 x 8 I/O) Power supply via • Spring-loaded terminals • Screw terminals	6ES7921-3AA20-0AA0 6ES7921-3AB20-0AA0	6ES7921-3AF00-0AA0 6ES7921-3AG00-0AA0 6ES7921-3AF20-0AA0 6ES7921-3AG20-0AA0
Connecting cables		
Pre-assembled round cable 16-pin, 0.14 mm ² Unshielded • 0.5 m • 1.0 m • 1.5 m • 2.0 m • 2.5 m • 3.0 m • 4.0 m • 5.0 m • 6.5 m • 8.0 m • 10.0 m Shielded • 1.0 m • 2.0 m • 2.5 m • 3.0 m • 4.0 m • 5.0 m • 6.5 m • 8.0 m • 10.0 m Version 4 x 16 to 1 x 50-pin, 0.14 mm ² Unshielded • 0.5 m • 1.0 m • 1.5 m • 2.0 m • 2.5 m • 3.0 m • 4.0 m • 5.0 m • 6.5 m • 8.0 m • 10.0 m	6ES7923-0BA50-0CB0 6ES7923-0BB00-0CB0 6ES7923-0BB50-0CB0 6ES7923-0BC00-0CB0 6ES7923-0BC50-0CB0 6ES7923-0BD00-0CB0 6ES7923-0BE00-0CB0 6ES7923-0BF00-0CB0 6ES7923-0BG50-0CB0 6ES7923-0BJ00-0CB0 6ES7923-0CB00-0CB0 6ES7923-0BB00-0DB0 6ES7923-0BC00-0DB0 6ES7923-0BC50-0DB0 6ES7923-0BD00-0DB0 6ES7923-0BE00-0DB0 6ES7923-0BF00-0DB0 6ES7923-0BG50-0DB0 6ES7923-0BJ00-0DB0 6ES7923-0CB00-0DB0 6ES7923-5BA50-0EB0 6ES7923-5BB00-0EB0 6ES7923-5BB50-0EB0 6ES7923-5BC00-0EB0 6ES7923-5BC50-0EB0 6ES7923-5BD00-0EB0 6ES7923-5BE00-0EB0 6ES7923-5BF00-0EB0 6ES7923-5BG50-0EB0 6ES7923-5BJ00-0EB0 6ES7923-5CB00-0EB0	Round-sheath ribbon cable 16-pin, 0.14 mm ² Unshielded • 30 m • 60 m Shielded • 30 m • 60 m Round-sheath ribbon cable 2 x 16-pin, 0.14 mm ² Unshielded • 30 m • 60 m Connector (female ribbon connector) 16-pin, insulation displacement system, with strain relief devices; packing unit: 8 connectors and 8 cable grips Accessories Manual pliers For preparing the connectors (female ribbon connector)
		6ES7923-0CD00-0AA0 6ES7923-0CG00-0AA0 6ES7923-0CD00-0BA0 6ES7923-0CG00-0BA0 6ES7923-2CD00-0AA0 6ES7923-2CG00-0AA0 6ES7921-3BE10-0AA0 6ES7928-0AA00-0AA0

SIMATIC S7-300 Advanced Controllers

I/O modules

Connection system

System cabling for SIMATIC S7-300/400 and ET 200M > Fully modular connection

Ordering data

Connection modules

Connection module TP1

For 1-wire connection, for 16-pin connecting cables

- Push-in terminals without LEDs
- Screw-type terminals without LEDs
- Push-in terminals with LEDs
- Screw-type terminals with LEDs

6ES7924-0AA20-0AC0
6ES7924-0AA20-0AA0

6ES7924-0AA20-0BC0
6ES7924-0AA20-0BA0

For 1-wire connection, for 50-pin connecting cables

- Push-in terminals without LEDs
- Screw-type terminals without LEDs
- Push-in terminals with LEDs
- Screw-type terminals with LEDs

6ES7924-2AA20-0AC0
6ES7924-2AA20-0AA0

6ES7924-2AA20-0BC0
6ES7924-2AA20-0BA0

Connection module TP3

For 3-wire connection, for 16-pin connecting cables

- Push-in terminals without LEDs
- Screw-type terminals without LEDs
- Push-in terminals with LEDs
- Screw-type terminals with LEDs
- Push-in terminals with LEDs and one isolating terminal per channel
- Screw-type terminals with LEDs and one isolating terminal per channel
- Push-in terminals with LED and fuse per channel
- Push-in terminals with LED and fuse per channel

6ES7924-0CA20-0AC0
6ES7924-0CA20-0AA0

6ES7924-0CA20-0BC0
6ES7924-0CA20-0BA0

6ES7924-0CH20-0BC0

6ES7924-0CH20-0BA0

6ES7924-0CL20-0BC0

6ES7924-0CL20-0BA0

For 3-wire connection, for 50-pin connecting cables

- Push-in terminals without LEDs
- Screw-type terminals without LEDs
- Push-in terminals with LEDs
- Screw-type terminals with LEDs

6ES7924-2CA20-0AC0
6ES7924-2CA20-0AA0

6ES7924-2CA20-0BC0
6ES7924-2CA20-0BA0

Connection module TPRo

Relay module for 8 outputs, relay as normally open contact

- Push-in terminals with LEDs
- Screw-type terminals with LEDs

6ES7924-0BD20-0BC0
6ES7924-0BD20-0BA0

Connection module TPRI

Relay module for 8 outputs (110 V AC), relay as normally open contact

- Push-in terminals with LEDs
- Screw-type terminals with LEDs

6ES7924-0BG20-0BC0
6ES7924-0BG20-0BA0

Connection module TPRI

Relay module for 8 outputs (230 V AC), relay as normally open contact

- Push-in terminals with LEDs
- Screw-type terminals with LEDs

6ES7924-0BE20-0BC0
6ES7924-0BE20-0BA0

Connection module TPOo

Optocoupler module for 8 outputs (max. 24 V DC/4 A)

- Push-in terminals with LEDs
- Screw-type terminals with LEDs

6ES7924-0BF20-0BC0
6ES7924-0BF20-0BA0

Connection module for digital output modules 2 A

Connection module TP2

- Push-in terminals without LEDs
- Screw-type terminals without LEDs

6ES7924-0BB20-0AC0
6ES7924-0BB20-0AA0

Connection module for analog modules (for S7-300 only)

Connection module TPA

- Push-in terminals without LEDs
- Screw-type terminals without LEDs

6ES7924-0CC21-0AC0
6ES7924-0CC21-0AA0

Accessories

ID labels for connection modules in S7-1500 design

ID labels, insertable
PU = 340 units

3RT1900-1SB20

Shield for analog connection module

PU = 4 units (for connection of 16-pin connecting cable)

6ES7928-1AA20-4AA0

PU = 4 units (for connection of 16-pin connecting cable) (for S7-1500 only)

6ES7928-1BA20-4AA0

Shield connection clamp

for shield plate at SIMATIC end, PU = 10 units

6ES7590-5BA00-0AA0

for shield plate at field end, 2 x 2 ... 6 mm

6ES7390-5AB00-0AA0

for shield plate at field end, 3 ... 8 mm

6ES7390-5BA00-0AA0

for shield plate at field end, 4 ... 13 mm

6ES7390-5CA00-0AA0

Overview



Flexible connection enables fast, direct connection of the SIMATIC S7-300/ET 200 M input/output modules to the individual elements in the control cabinet.

Attached single cores reduce the wiring outlay.

Wire cross-sections of 0.5 mm² allow higher currents, too.

Technical specifications

Front connector with single cores for 16 channels	
Rated operating voltage	24 V DC
Permissible continuous current with simultaneous load of all wires, max.	1.5 A
Permissible ambient temperature	0 to 60 °C
Core type	H05V-K or with UL 1007/1569; CSA TR64
Number of single cores	20
Core cross-section	0.5 mm ² ; Cu
Bundle diameter in mm	approx. 15
Core color	Blue, RAL 5010
Designation of cores	Numbered from 1 to 20 (front connector contact = core number)
Assembly	Screw-type or crimp contacts
Front connector with single cores for 32 channels	
Rated operating voltage	24 V DC
Permissible continuous current with simultaneous load of all wires, max.	1.5 A
Permissible ambient temperature	0 to 60 °C
Core type	H05V-K or with UL 1007/1569; CSA TR64
Number of single cores	40
Core cross-section	0.5 mm ² ; Cu
Bundle diameter in mm	approx. 17
Core color	Blue, RAL 5010
Designation of cores	Numbered from 1 to 40 (front connector contact = core number)
Assembly	Screw-type or crimp contacts

Ordering data

Article No.

Front connector with single cores for 16-channel digital modules SIMATIC S7-300, 20 x 0.5 mm²	
Core type H05V-K	
<u>Screw-type version</u>	
Packing unit: 1 unit	6ES7922-3BC50-0AB0 6ES7922-3BD20-0AB0 6ES7922-3BF00-0AB0 On request
Length:	
• 2.5 m	
• 3.2 m	
• 5 m	
• Custom lengths	
Packing unit: 5 units	6ES7922-3BC50-5AB0 6ES7922-3BD20-5AB0 6ES7922-3BF00-5AB0
Length:	
• 2.5 m	
• 3.2 m	
• 5.0 m	
• Custom lengths	
<u>Crimp version</u>	
Packing unit: 1 unit	6ES7922-3BC50-0AF0 6ES7922-3BD20-0AF0 6ES7922-3BF00-0AF0 On request
Length:	
• 2.5 m	
• 3.2 m	
• 5.0 m	
• Custom lengths	
Core type UL/CSA-certified	
<u>Screw-type version</u>	
Packing unit: 1 unit	6ES7922-3BD20-0UB0 6ES7922-3BF00-0UB0
Length:	
• 3.2 m	
• 5.0 m	
Front connector with single cores for 32-channel digital modules SIMATIC S7-300, 40 x 0.5 mm²	
Core type H05V-K	
<u>Screw-type version</u>	
Packing unit: 1 unit	6ES7922-3BC50-0AC0 6ES7922-3BD20-0AC0 6ES7922-3BF00-0AC0 On request
Length:	
• 2.5 m	
• 3.2 m	
• 5.0 m	
• Custom lengths	
Packing unit: 5 units	6ES7922-3BC50-5AC0 6ES7922-3BD20-5AC0 6ES7922-3BF00-5AC0
Length:	
• 2.5 m	
• 3.2 m	
• 5.0 m	
• Custom lengths	
<u>Crimp version</u>	
Packing unit: 1 unit	6ES7922-3BC50-0AG0 6ES7922-3BD20-0AG0 6ES7922-3BF00-0AG0 On request
Length:	
• 2.5 m	
• 3.2 m	
• 5.0 m	
• Custom lengths	
Core type UL/CSA-certified	
<u>Screw-type version</u>	
Packing unit: 1 unit	6ES7922-3BD20-0UC0 6ES7922-3BF00-0UC0
Length:	
• 3.2 m	
• 5.0 m	

SIMATIC S7-300 Advanced Controllers

I/O modules

Connection system

System cabling for SIMATIC S7-300/400 and ET 200M > Front connectors for S7-300 with crimp connections**Design*****The front connector is available in two designs***The 20-pole front connector contains:

- 20 connections for crimp contacts for connecting the wiring
- Strain relief for the cables
- Unlatching key; for unlatching the front connector when replacing the module
- Holder for coding element attachment; there are two coding elements with attachments on the modules. The attachments latch in when inserting into the front connector for the first time.

The 40-pole front connector contains:

- 40 connections for crimp contacts for connecting the wiring
- Strain relief for the cables
- Locking screw; for fixing and detaching the front connector when the module is replaced
- Holder for coding element attachment; there is a coding element with an attachment on the modules. The attachment latches in when inserting into the front connector for the first time.

IntegrationUse of the 20-pole front connector with

- 16-channel signal modules
- Function modules
- CPU 312 IFM

Use of the 40-pole front connector with

- 32-channel signal modules
- Compact CPUs

Ordering data**Article No.****Front connector 20-pole, crimp version without crimp contacts**

Packing unit (100 units)

6ES7921-3AH00-1AA0**Front connector 40-pole, crimp version without crimp contacts**

Packing unit (100 units)

6ES7921-3AH20-1AA0**Accessories****Crimp contacts for front connectors**

Packing unit (250 units)

6XX3070**Crimping tool**

for crimping the crimp contacts

6XX3071**Unlocking tool for crimp contacts****6ES5497-4UC11**

SIMATIC S7-300 Advanced Controllers

Power supplies

1-phase, 24 V DC (for S7-300 and ET200M)

Overview



The design and functionality of the SIMATIC PS 307 single-phase load power supply (system and load current supply) with automatic range switchover of the input voltage is an optimal match to the SIMATIC S7-300 PLC. By means of the connecting comb that is supplied with the system and load current supply, the supply to the CPU is quickly established. It is also possible to provide a 24 V supply to other S7-300 system components, input/output circuits of the input/output modules and, if necessary, the sensors and actuators. Comprehensive certifications, such as UL, ATEX or GL facilitate universal use (does not apply to outdoor use).

Technical specifications

Article number	6ES7307-1BA01-0AA0	6ES7305-1BA80-0AA0	6ES7307-1EA01-0AA0	6ES7307-1EA80-0AA0	6ES7307-1KA02-0AA0
Product	PS 307	PS 305 Outdoor	PS 307	PS 307 Outdoor	PS 307
Power supply, type	24 V/2 A	24 V/2 A	24 V/5 A	24 V/5 A	24 V/10 A
Input					
Input	1-phase AC	DC voltage	1-phase AC	1-phase AC	1-phase AC
Supply voltage					
• 1 at AC Rated value	120 V		120 V	120 V	120 V
• 2 at AC Rated value	230 V		230 V	230 V	230 V
• at DC		24 ... 110 V			
• Note	Automatic range selection		Automatic range selection	Set by means of selector switch on the device	Automatic range selection
Input voltage					
• 1 at AC	85 ... 132 V		85 ... 132 V	93 ... 132 V	85 ... 132 V
• 2 at AC	170 ... 264 V		170 ... 264 V	187 ... 264 V	170 ... 264 V
• at DC		16.8 ... 138 V			
Wide-range input	No	Yes	No	No	No
Overvoltage resistance	$2.3 \times V_{in \text{ rated}}, 1.3 \text{ ms}$	154 V; 0.1 s	$2.3 \times V_{in \text{ rated}}, 1.3 \text{ ms}$	$2.3 \times V_{in \text{ rated}}, 1.3 \text{ ms}$	$2.3 \times V_{in \text{ rated}}, 1.3 \text{ ms}$
Mains buffering at I _{out} rated, min.	20 ms; at $V_{in} = 93/187 \text{ V}$	10 ms; at $V_{in \text{ rated}}$	20 ms; at $V_{in} = 93/187 \text{ V}$	20 ms; at $V_{in} = 93/187 \text{ V}$	20 ms; at $V_{in} = 93/187 \text{ V}$
Rated line frequency 1	50 Hz		50 Hz	50 Hz	50 Hz
Rated line frequency 2	60 Hz		60 Hz	60 Hz	60 Hz
Rated line range	47 ... 63 Hz		47 ... 63 Hz	47 ... 63 Hz	47 ... 63 Hz
Input current					
• at rated input voltage 120 V	0.9 A		2.3 A	2.1 A	4.2 A
• at rated input voltage 230 V	0.5 A		1.2 A	1.2 A	1.9 A
• at rated input voltage 24 V		2.4 A			
• at rated input voltage 110 V		0.6 A			
Switch-on current limiting (+25 °C), max.	22 A	20 A	20 A	45 A	55 A
Duration of inrush current limiting at 25 °C					
• maximum	3 ms	10 ms	3 ms	3 ms	3 ms
I ² t, max.	1 A ² ·s	5 A ² ·s	1.2 A ² ·s	1.8 A ² ·s	3.3 A ² ·s
Built-in incoming fuse	T 1.6 A/250 V (not accessible)	T 6.3 A/250 V (not accessible)	T 3,15 A/250 V (not accessible)	T 3,15 A/250 V (not accessible)	T 6.3 A/250 V (not accessible)
Protection in the mains power input (IEC 898)	Recommended miniature circuit breaker: 3 A characteristic C	Recommended miniature circuit breaker: from 10 A characteristic C, suitable for DC	Recommended miniature circuit breaker: from 6 A characteristic C	Recommended miniature circuit breaker: from 10 A characteristic C or from 6 A characteristic D	Recommended miniature circuit breaker: from 10 A characteristic C

SIMATIC S7-300 Advanced Controllers

Power supplies

1-phase, 24 V DC (for S7-300 and ET200M)

Technical specifications (continued)

Article number	6ES7307-1BA01-0AA0	6ES7305-1BA80-0AA0	6ES7307-1EA01-0AA0	6ES7307-1EA80-0AA0	6ES7307-1KA02-0AA0
Product	PS 307	PS 305 Outdoor	PS 307	PS 307 Outdoor	PS 307
Power supply, type	24 V/2 A	24 V/2 A	24 V/5 A	24 V/5 A	24 V/10 A
Output					
Output	Controlled, isolated DC voltage	Controlled, isolated DC voltage	Controlled, isolated DC voltage	Controlled, isolated DC voltage	Controlled, isolated DC voltage
Rated voltage V_{out} DC	24 V	24 V	24 V	24 V	24 V
Total tolerance, static \pm	3 %	3 %	3 %	3 %	3 %
Static mains compensation, approx.	0.1 %	0.2 %	0.1 %	0.2 %	0.1 %
Static load balancing, approx.	0.2 %	0.4 %	0.5 %	0.4 %	0.5 %
Residual ripple peak-peak, max.	50 mV	150 mV	50 mV	150 mV	50 mV
Residual ripple peak-peak, typ.	5 mV	30 mV	10 mV	40 mV	15 mV
Spikes peak-peak, max. (bandwidth: 20 MHz)	150 mV	240 mV	150 mV	240 mV	150 mV
Spikes peak-peak, typ. (bandwidth: 20 MHz)	20 mV	150 mV	20 mV	90 mV	60 mV
Product function	No	No	No	No	No
Output voltage adjustable	-	-	-	-	-
Output voltage setting	-	-	-	-	-
Status display	Green LED for 24 V OK	Green LED for 24 V OK	Green LED for 24 V OK	Green LED for 24 V OK	Green LED for 24 V OK
On/off behavior	No overshoot of V_{out} (soft start)	No overshoot of V_{out} (soft start)	No overshoot of V_{out} (soft start)	No overshoot of V_{out} (soft start)	No overshoot of V_{out} (soft start)
Startup delay, max.	2 s	3 s	2 s	3 s	2 s
Voltage rise, typ.	10 ms	5 ms	10 ms	100 ms	10 ms
Rated current value I _{out} rated	2 A	2 A	5 A	5 A	10 A
Current range	0 ... 2 A	0 ... 3 A	0 ... 5 A	0 ... 5 A	0 ... 10 A
• Note		3 A up to +60°C at $V_{in} > 24$ V			
Supplied active power typical	48 W	48 W	120 W	120 W	240 W
Short-term overload current					
• on short-circuiting during the start-up typical	9 A	9 A	20 A	20 A	38 A
• at short-circuit during operation typical	9 A	9 A	20 A	20 A	38 A
Duration of overloading capability for excess current					
• on short-circuiting during the start-up	90 ms	270 ms	100 ms	180 ms	80 ms
• at short-circuit during operation	90 ms	270 ms	100 ms	80 ms	80 ms
Parallel switching for enhanced performance	Yes	Yes	Yes	No	Yes
Numbers of parallel switchable units for enhanced performance	2	2			
Efficiency					
Efficiency at V_{out} rated, I_{out} rated, approx.	84 %	75 %	87 %	84 %	90 %
Power loss at V_{out} rated, I_{out} rated, approx.	9 W	16 W	18 W	23 W	27 W
Closed-loop control					
Dynamic mains compensation (V_{in} rated ± 15 %), max.	0.1 %	0.3 %	0.1 %	0.3 %	0.1 %
Dynamic load smoothing (I_{out} : 50/100/50 %), $U_{out} \pm$ typ.	0.8 %	2.5 %	1 %	3 %	2 %
Load step setting time 50 to 100%, typ.	0.5 ms	2.5 ms	0.3 ms	0.2 ms	
Load step setting time 100 to 50%, typ.	0.5 ms	2.5 ms	0.3 ms	0.2 ms	
Setting time maximum	1 ms	5 ms		5 ms	0.1 ms

SIMATIC S7-300 Advanced Controllers

Power supplies

1-phase, 24 V DC (for S7-300 and ET200M)

Technical specifications (continued)

Article number	6ES7307-1BA01-0AA0	6ES7305-1BA80-0AA0	6ES7307-1EA01-0AA0	6ES7307-1EA80-0AA0	6ES7307-1KA02-0AA0
Product	PS 307	PS 305 Outdoor	PS 307	PS 307 Outdoor	PS 307
Power supply, type	24 V/2 A	24 V/2 A	24 V/5 A	24 V/5 A	24 V/10 A
Protection and monitoring					
Output overvoltage protection	Additional control loop, shutdown at < 28.8 V, automatic restart	Additional control loop, shutdown at approx. 30 V, automatic restart	Additional control loop, shutdown at < 28.8 V, automatic restart	Additional control loop, shutdown at approx. 30 V, automatic restart	Additional control loop, shutdown at < 28.8 V, automatic restart
Current limitation	2.2 ... 2.6 A	3.3 ... 3.9 A	5.5 ... 6.5 A	5.5 ... 6.5 A	11 ... 12 A
Property of the output	Yes	Yes	Yes	Yes	Yes
Short-circuit proof					
Short-circuit protection	Electronic shutdown, automatic restart	Electronic shutdown, automatic restart	Electronic shutdown, automatic restart	Electronic shutdown, automatic restart	Electronic shutdown, automatic restart
Enduring short circuit current RMS value					
• maximum	2 A	2 A	7 A	5 A	12 A
Overload/short-circuit indicator	-	-			-
Safety					
Primary/secondary isolation	Yes	Yes	Yes	Yes	Yes
Galvanic isolation	Safety extra-low output voltage U _{out} acc. to EN 60950-1 and EN 50178	Safety extra low output voltage V _{out} according to EN 60950-1 and EN 50178, creepage distances and clearances > 5 mm	Safety extra-low output voltage U _{out} acc. to EN 60950-1 and EN 50178	Safety extra low output voltage V _{out} according to EN 60950-1 and EN 50178, creepage distances and clearances > 5 mm	Safety extra-low output voltage U _{out} acc. to EN 60950-1 and EN 50178
Protection class	Class I	Class I	Class I	Class I	Class I
Leakage current					
• maximum	3.5 mA		3.5 mA	3.5 mA	3.5 mA
• typical	0.5 mA		0.5 mA	0.3 mA	0.6 mA
CE mark	Yes	Yes	Yes	Yes	Yes
UL/cUL (CSA) approval	cULus-Listed (UL 508, CSA C22.2 No. 142), File E143289	UL-Listed (UL 508), File E143289, CSA (CSA C22.2 No. 142)	cULus-Listed (UL 508, CSA C22.2 No. 142), File E143289	UL-Listed (UL 508), File E143289, CSA (CSA C22.2 No. 142)	cULus-Listed (UL 508, CSA C22.2 No. 142), File E143289
Explosion protection	ATEX (EX) II 3G Ex nA II T4; cULus (ISA 12.12.01, CSA C22.2 No.213) Class I, Div. 2, Group ABCD, T4, File E330455	-	ATEX (EX) II 3G Ex nA II T4; cULus (ISA 12.12.01, CSA C22.2 No.213) Class I, Div. 2, Group ABCD, T4, File E330455	-	ATEX (EX) II 3G Ex nA II T4; cULus (ISA 12.12.01, CSA C22.2 No.213) Class I, Div. 2, Group ABCD, T4, File E330455
FM approval	Class I, Div. 2, Group ABCD, T4	-	Class I, Div. 2, Group ABCD, T4	-	Class I, Div. 2, Group ABCD, T4
CB approval	No	No	No	No	No
Marine approval	In S7-300 system	-	In S7-300 system	-	In S7-300 system
Degree of protection (EN 60529)	IP20	IP20	IP20	IP20	IP20
EMC					
Emitted interference	EN 55022 Class B	EN 55011 Class A	EN 55022 Class B	EN 55011 Class A	EN 55022 Class B
Supply harmonics limitation	not applicable	not applicable	EN 61000-3-2	-	EN 61000-3-2
Noise immunity	EN 61000-6-2	EN 61000-6-2	EN 61000-6-2	EN 61000-6-2	EN 61000-6-2
Operating data					
Ambient temperature					
• during operation	0 ... 60 °C	-25 ... +70 °C	0 ... 60 °C	-25 ... +70 °C	0 ... 60 °C
- Note	with natural convection	with natural convection	with natural convection	with natural convection	with natural convection
• during transport	-40 ... +85 °C	-40 ... +85 °C	-40 ... +85 °C	-40 ... +85 °C	-40 ... +85 °C
• during storage	-40 ... +85 °C	-40 ... +85 °C	-40 ... +85 °C	-40 ... +85 °C	-40 ... +85 °C
Humidity class according to EN 60721	Climate class 3K3, no condensation	Climate class 3K5, transient condensation permitted	Climate class 3K3, no condensation	Climate class 3K5, transient condensation permitted	Climate class 3K3, no condensation

SIMATIC S7-300 Advanced Controllers

Power supplies

1-phase, 24 V DC (for S7-300 and ET200M)

Technical specifications (continued)

Article number	6ES7307-1BA01-0AA0	6ES7305-1BA80-0AA0	6ES7307-1EA01-0AA0	6ES7307-1EA80-0AA0	6ES7307-1KA02-0AA0
Product	PS 307	PS 305 Outdoor	PS 307	PS 307 Outdoor	PS 307
Power supply, type	24 V/2 A	24 V/2 A	24 V/5 A	24 V/5 A	24 V/10 A
Mechanics					
Connection technology	screw-type terminals	screw-type terminals	screw-type terminals	screw-type terminals	screw-type terminals
Connections					
• Supply input	L, N, PE: 1 screw terminal each for 0.5 ... 2.5 mm ² single-core/finely stranded	L+, M1, PE: 1 screw terminal each for 0.5 ... 2.5 mm ² single-core/finely stranded	L, N, PE: 1 screw terminal each for 0.5 ... 2.5 mm ² single-core/finely stranded	L, N, PE: 1 screw terminal each for 0.5 ... 2.5 mm ² single-core/finely stranded	L, N, PE: 1 screw terminal each for 0.5 ... 2.5 mm ² single-core/finely stranded
• Output	L+, M: 2 screw terminals each for 0.5 ... 2.5 mm ²	L+, M: 3 screw terminals each for 0.5 ... 2.5 mm ²	L+, M: 3 screw terminals each for 0.5 ... 2.5 mm ²	L+, M: 3 screw terminals each for 0.5 ... 2.5 mm ²	L+, M: 4 screw terminals each for 0.5 ... 2.5 mm ²
• Auxiliary	-	-	-	-	-
Width of the enclosure	40 mm	80 mm	60 mm	80 mm	80 mm
Height of the enclosure	125 mm	125 mm	125 mm	125 mm	125 mm
Depth of the enclosure	120 mm	120 mm	120 mm	120 mm	120 mm
Required spacing					
• top	40 mm	50 mm	40 mm	50 mm	40 mm
• bottom	40 mm	50 mm	40 mm	50 mm	40 mm
• left	0 mm	0 mm	0 mm	0 mm	0 mm
• right	0 mm	0 mm	0 mm	0 mm	0 mm
Weight, approx.	0.4 kg	0.57 kg	0.6 kg	0.57 kg	0.8 kg
Product feature of the enclosure housing for side-by-side mounting	Yes	Yes	Yes	Yes	Yes
Installation	Can be mounted onto S7 rail	Can be mounted onto S7 rail	Can be mounted onto S7 rail	Can be mounted onto S7 rail	Can be mounted onto S7 rail
Mechanical accessories	Mounting adapter for standard mounting rail (6EP1971-1BA00)	Mounting adapter for standard mounting rail (6ES7390-6BA00-0AA0)	Mounting adapter for standard mounting rail (6EP1971-1BA00)	Mounting adapter for standard mounting rail (6ES7390-6BA00-0AA0)	Mounting adapter for standard mounting rail (6EP1971-1BA00)
MTBF at 40 °C	2 320 078 h	964 506 h	2 480 589 h	2 231 610 h	1 504 280 h
Other information	Specifications at rated input voltage and ambient temperature +25 °C (unless otherwise specified)	Specifications at rated input voltage and ambient temperature +25 °C (unless otherwise specified)	Specifications at rated input voltage and ambient temperature +25 °C (unless otherwise specified)	Specifications at rated input voltage and ambient temperature +25 °C (unless otherwise specified)	Specifications at rated input voltage and ambient temperature +25 °C (unless otherwise specified)

Ordering data

	Article No.
PS 307 load current supply, 2A	6ES7307-1BA01-0AA0
incl. connecting comb Input: 120/230 V AC Output: 24 V DC/2 A	
SIMATIC S7-300 Outdoor, 2A	6ES7305-1BA80-0AA0
Stabilized power supply PS 305 Input: 24 ... 110 V DC Output: 24 V DC/2 A	
PS 307 load power supply, 5 A	6ES7307-1EA01-0AA0
incl. connecting comb Input: 120/230 V AC Output: 24 V DC/5 A	
SIMATIC S7-300 Outdoor, 5A	6ES7307-1EA80-0AA0
Stabilized power supply PS 307 Input: 120/230 V AC Output: 24 V DC/5 A	
PS 307 load power supply, 10 A	6ES7307-1KA02-0AA0
Input: 120/230 V AC Output: 24 V DC/10 A	

Article No.

Accessories

SIMATIC S7-300 mounting adapter	6EP1971-1BA00
For snapping the new PS 307 onto a 35 mm DIN rail (EN 60715)	
Spare part	
SIMATIC S7-300 mounting adapter	6ES7390-6BA00-0AA0
for snapping the PS 307 onto 35 mm DIN rails	

SIMATIC S7-300 Advanced Controllers

SIPLUS power supplies

1-phase, 24 V DC (for S7-300 and ET200M)

Overview



The design and functionality of the SIMATIC PS 305 and PS 307 single-phase load power supplies (system and load current supply) with automatic range switchover of the input voltage are an optimal match for the SIMATIC S7-300 PLC. By means of the connecting comb that is supplied with the system and load current supply, the supply to the CPU is quickly established. It is also possible to provide a 24 V supply to other S7-300 system components, input/output circuits of the input/output modules and, if necessary, the sensors and actuators. Comprehensive certifications, such as UL, ATEX or GL facilitate universal use (does not apply to outdoor use).

Note:

SIPLUS extreme products are based on Siemens standard products. The contents listed here were taken from the respective standard products. SIPLUS extreme specific information was added.

Technical specifications

Article number	6AG1305-1BA80-2AA0	6AG1307-1EA01-7AA0	6AG1307-1KA02-7AA0
Based on	6ES7305-1BA80-0AA0 SIPLUS PS S7-300 PS305 (EN50155)	6ES7307-1EA01-0AA0 SIPLUS PS307 AC 120/230V / DC 24 V/5 A	6ES7307-1KA02-0AA0 SIPLUS_PS307_10A
Ambient conditions			
Ambient temperature during operation			
• min.	-25 °C; = Tmin	-25 °C; = Tmin	-25 °C; = Tmin
• max.	70 °C; = Tmax; for use on railway vehicles according to EN 50155, the rated temperature range -25 ... +55 °C (T1) or 60 °C @ UL/UL hazardous use applies	70 °C; = Tmax; 60 °C @ UL/cUL, ATEX and FM use	70 °C; = Tmax; 60 °C @ UL/cUL, ATEX and FM use
Extended ambient conditions			
• relative to ambient temperature-atmospheric pressure-installation altitude	Tmin ... Tmax at 1080 hPa ... 795 hPa (-1000 m ... +2000 m) // Tmin ... (Tmax - 10K) at 795 hPa ... 658 hPa (+2000 m ... +3500 m) // Tmin ... (Tmax - 20K) at 658 hPa ... 540 hPa (+3500 m ... +5000 m)	Tmin ... Tmax at 1080 hPa ... 795 hPa (-1000 m ... +2000 m)	Tmin ... Tmax at 1080 hPa ... 795 hPa (-1000 m ... +2000 m)
Relative humidity			
- With condensation, tested in accordance with IEC 60068-2-38, max.	100 %; RH incl. condensation/frost (no commissioning under condensation conditions)	100 %; RH incl. condensation/frost (no commissioning under condensation conditions)	100 %; RH incl. condensation/frost (no commissioning under condensation conditions)
Resistance			
- against biologically active substances / conformity with EN 60721-3-3	Yes; Class 3B2 mold, fungus and dry rot spores (with the exception of fauna). The supplied connector covers must remain on the unused interfaces during operation!	Yes; Class 3B2 mold, fungus and dry rot spores (with the exception of fauna). The supplied connector covers must remain on the unused interfaces during operation!	Yes; Class 3B2 mold, fungus and dry rot spores (with the exception of fauna). The supplied connector covers must remain on the unused interfaces during operation!
- against chemically active substances / conformity with EN 60721-3-3	Yes; Class 3C4 (RH < 75%) incl. salt spray according to EN 60068-2-52 (degree of severity 3). The supplied connector covers must remain on the unused interfaces during operation!	Yes; Class 3C4 (RH < 75%) incl. salt spray according to EN 60068-2-52 (degree of severity 3). The supplied connector covers must remain on the unused interfaces during operation!	Yes; Class 3C4 (RH < 75%) incl. salt spray according to EN 60068-2-52 (degree of severity 3). The supplied connector covers must remain on the unused interfaces during operation!
- against mechanically active substances / conformity with EN 60721-3-3	Yes; Class 3S4 incl. sand, dust. The supplied connector covers must remain on the unused interfaces during operation!	Yes; Class 3S4 incl. sand, dust. The supplied connector covers must remain on the unused interfaces during operation!	Yes; Class 3S4 incl. sand, dust. The supplied connector covers must remain on the unused interfaces during operation!

SIMATIC S7-300 Advanced Controllers

SIPLUS power supplies

1-phase, 24 V DC (for S7-300 and ET200M)

Ordering data	Article No.	Accessories	Article No.
SIPLUS power supplies <i>For industrial applications with extended ambient conditions</i> SIPLUS S7-300 PS 305 (Extended temperature range and medial exposure) Input: 24 ... 110 V DC Output: 24 V DC/2 A	6AG1305-1BA80-2AA0	SIMATIC S7-300 mounting adapter For snapping the PS 307 onto a 35 mm DIN rail (EN 60715)	6EP1971-1BA00
SIPLUS S7-300 PS 307 5 A (Extended temperature range and medial exposure) Incl. connection bracket 120/230 V AC; 24 V DC Output current 5 A (dimensions 60 x 125 x 120)	6AG1307-1EA01-7AA0	Spare part SIMATIC S7-300 mounting adapter; for snapping the PS 307 onto 35 mm standard rails	6ES7390-6BA00-0AA0
SIPLUS S7-300 PS 307 10 A (Extended temperature range and medial exposure) Incl. connection bracket 120/230 V AC; 24 V DC Output current 10 A (dimensions 80 x 125 x 120)	6AG1307-1KA02-7AA0		
<i>For rolling stock railway applications</i> SIPLUS S7-300 PS 305 (Extended temperature range and medial exposure) <u>Conforms to EN 50155</u> Input: 24 ... 110 V DC Output: 24 V DC/2 A	6AG1305-1BA80-2AA0		

Overview



- For connecting mounting racks in multi-tier SIMATIC S7-300 configurations
- IM 365: For design of central controller and max. 1 expansion unit.
Limited use of modules in the expansion unit (e.g. no CPs or FMs)
- IM 360/IM 361: For design of central controller and max. 3 expansion units.
No limitation in selection of modules in the expansion unit

Technical specifications

Article number	6ES7360-3AA01-0AA0	6ES7361-3CA01-0AA0	6ES7365-0BA01-0AA0
	SIMATIC S7-300,INTERFACE MODULE	IM 361 NTERFACE MODULE IN ER, WITH K-BUS	SIMATIC S7-300,INTERFACE MODULE
Supply voltage			
Rated value (DC)			
• 24 V DC		Yes	
Input current			
from supply voltage L+, max.		500 mA	
from backplane bus 5 V DC, max.	350 mA		100 mA
Power loss			
Power loss, typ.	2 W	5 W	0.5 W
Hardware configuration			
Number of interfaces per CPU, max.	1	3	1; 1 pair
Dimensions			
Width	40 mm	80 mm	40 mm
Height	125 mm	125 mm	125 mm
Depth	120 mm	120 mm	120 mm
Weights			
Weight, approx.	225 g	505 g	580 g

Ordering data

Ordering data	Article No.	Ordering data	Article No.
IM 360 interface module	6ES7360-3AA01-0AA0	SIMATIC Manual Collection	6ES7998-8XC01-8YE0
for expanding the S7-300 with max. 3 EUs; can be plugged into CC		Electronic manuals on DVD, multilingual: LOGO!, SIMADYN, SIMATIC bus components, SIMATIC C7, SIMATIC distributed I/O, SIMATIC HMI, SIMATIC Sensors, SIMATIC NET, SIMATIC PC Based Automation, SIMATIC PCS 7, SIMATIC PG/PC, SIMATIC S7, SIMATIC Software, SIMATIC TDC	
IM 361 interface module	6ES7361-3CA01-0AA0	SIMATIC Manual Collection update service for 1 year	6ES7998-8XC01-8YE2
for expanding the S7-300 with max. 3 EUs; can be plugged into EU		Current "Manual Collection" DVD and the three subsequent updates	
Connecting cable			
between IM 360 and IM 361 or IM 361 and IM 361			
1 m	6ES7368-3BB01-0AA0		
2.5 m	6ES7368-3BC51-0AA0		
5 m	6ES7368-3BF01-0AA0		
10 m	6ES7368-3CB01-0AA0		
IM 365 interface module	6ES7365-0BA01-0AA0		
for expanding the S7-300 with max. 1 EU; 2 modules with permanent connecting cable (1 m)			

SIMATIC S7-300 Advanced Controllers

SIPLUS interface modules

SIPLUS S7-300 IM 365

Overview



- SIPLUS IM 365: For configuration of 1 central controller and max. 1 expansion unit

Note:

SIPLUS extreme products are based on SIMATIC standard products. The contents listed here were taken from the respective standard products. SIPLUS extreme specific information was added.

Technical specifications

Article number	6AG1365-0BA01-2AA0
Based on	6ES7365-0BA01-0AA0 SIPLUS S7-300 IM365
Ambient conditions	
Ambient temperature during operation	
• min.	-25 °C; = Tmin
• max.	60 °C; = Tmax
Extended ambient conditions	
• relative to ambient temperature-atmospheric pressure-installation altitude	Tmin ... Tmax at 1080 hPa ... 795 hPa (-1000 m ... +2000 m) // Tmin ... (Tmax - 10K) at 795 hPa ... 658 hPa (+2000 m ... +3500 m) // Tmin ... (Tmax - 20K) at 658 hPa ... 540 hPa (+3500 m ... +5000 m)
Relative humidity	
- With condensation, tested in accordance with IEC 60068-2-38, max.	100 %; RH incl. condensation/frost (no commissioning under condensation conditions)

Article number	6AG1365-0BA01-2AA0
Based on	6ES7365-0BA01-0AA0 SIPLUS S7-300 IM365
Resistance	
- against biologically active substances / conformity with EN 60721-3-3	Yes; Class 3B2 mold, fungus and dry rot spores (with the exception of fauna). The supplied connector covers must remain on the unused interfaces during operation!
- against chemically active substances / conformity with EN 60721-3-3	Yes; Class 3C4 (RH < 75%) incl. salt spray according to EN 60068-2-52 (degree of severity 3). The supplied connector covers must remain on the unused interfaces during operation!
- against mechanically active substances / conformity with EN 60721-3-3	Yes; Class 3S4 incl. sand, dust. The supplied connector covers must remain on the unused interfaces during operation!

Ordering data

Article No.

SIPLUS S7-300 IM 365 interface module

for expanding the S7-300 with max. 1 EU; 2 modules with permanent connecting cable (1 m)

Extended temperature range and exposure to media

6AG1365-0BA01-2AA0

Overview

- The mechanical SIMATIC S7-300 rack
- For accommodating the modules
- Can be attached to walls

Ordering data

DIN rail
160 mm
482 mm
530 mm
830 mm
2000 mm

Article No.

6ES7390-1AB60-0AA0
6ES7390-1AE80-0AA0
6ES7390-1AF30-0AA0
6ES7390-1AJ30-0AA0
6ES7390-1BC00-0AA0

SIMATIC S7-300 Advanced Controllers

Accessories

Labeling sheets

Overview

Label sheets

- Film sheets for the application-specific labeling of I/O modules of the SIMATIC S7-300 using standard laser printers
- Plain color films, tear-resistant, dirt-repellent
- Simple handling:
 - perforated label sheets in DIN A4 format for easy separation of the labeling strips.
 - the separated strips can be attached directly onto the I/O modules.
- Different colors to distinguish between different module types or preferred applications:
The label sheets are available in the following colors: petrol, light beige, red, and yellow. Yellow is reserved for fail-safe systems.

Label cover

- Petrol-colored film
- For sealing and fixing of custom labeling strips on normal paper
- Accessories, 10 units

Technical specifications

Labeling sheets for S7-300	
Dimensions	DIN A4
Labeling strips per sheet, pre-perforated	10
Weight, approx.	0.1 kg

Ordering data

Article No.

Label sheets

for modules with 20-pin front connector, DIN A4, for printing with laser printer; 10 units

Petrol	6ES7392-2AX00-0AA0
Light beige	6ES7392-2BX00-0AA0
Yellow	6ES7392-2CX00-0AA0
Red	6ES7392-2DX00-0AA0

for modules with 40-pin front connector, DIN A4, for printing with laser printer; 10 units

Petrol	6ES7392-2AX10-0AA0
Light beige	6ES7392-2BX10-0AA0
Yellow	6ES7392-2CX10-0AA0
Red	6ES7392-2DX10-0AA0

SIMATIC S7-400 Advanced Controllers



6/2
6/2

Overview
SIMATIC S7-400

Brochures

For brochures serving as selection guides for SIMATIC products, refer to:

[www.siemens.com/simatic/
printmaterial](http://www.siemens.com/simatic/printmaterial)

Siemens ST 70 · 2017

SIMATIC S7-400 Advanced Controllers

Overview

SIMATIC S7-400

Overview

SIMATIC S7-400:

The powerful controller for system solutions in the manufacturing and process industries

Within the controller family, the SIMATIC S7-400 is designed for system solutions in the manufacturing and process automation industry.

- The S7-400 is especially suitable for data-intensive tasks in the process industry. High processing speeds and deterministic response times guarantee short machine cycle times on high-speed machines in the manufacturing industry. The high-speed backplane bus of S7-400 ensures efficient linking of central I/O modules.
- The S7-400 is used preferably to coordinate complete plants and to control lower-level devices/stations; this is guaranteed by the high communication power and the integral interfaces.
- The performance is scalable thanks to a graded range of CPUs; the I/O capacity is almost unlimited.
- The power reserves of the CPUs enable new functions to be integrated without further hardware investment, e.g. processing of quality data, user-friendly diagnostics, integration into higher-level MES solutions or high-speed communication via bus systems.



SIMATIC S7-400, CPU	412-1 / 412-2	412-2 PN ⁴⁾	414-2 / 414-3	414-3 PN/DP ⁴⁾	416-2 / 416-3 ⁴⁾	416-3 PN/DP ⁴⁾	417-4 ⁴⁾
Work memory	512KB/ 1 ¹⁾ MB	1 MB	2/4 ²⁾ MB	4 MB	8/16 ³⁾ MB	16 MB	32 MB
Processing times (ns)							
Bit/word/fixed point/floating point	31.25/31.25/ 31.25/62.5	31.25/31.25/ 31.25/62.5	18.75/18.75/ 18.75/37.5	18.75/18.75/ 18.75/37.5	12.5/12.5/ 12.5/25	12.5/12.5/ 12.5/25	7.5/7.5/ 7.5/15
Timers/counters	2048/2048	2048/2048	2048/2048	2048/2048	2048/2048	2048/2048	2048/2048
Address range							
Digital inputs/outputs	32768 each	32768 each	65536 each	65536 each	131072 each	131072 each	131072 each
Analog inputs/outputs	2048 each	2048 each	4096 each	4096 each	8192 each	8192 each	8192 each
DP interfaces							
Number of MPI/DP interfaces	1	1	1	1	1	1	1
Number of DP interfaces	— / 1 ¹⁾	—	1	—	1	1	1
Number of DP slaves per MPI/DP	32	32	32	32	32	32	32
Number of DP slaves per DP	64	—	96 each	125 each	125 each	125 each	125 each
Plug-in interface modules	—	—	— / 1 x DP ²⁾	1 x DP	— / 1 x DP ³⁾	1 x DP	2 x DP
Data set gateway	●	●	●	●	●	●	●
PN interfaces							
Number of PN interfaces	—	1 (2 ports)	—	1 (2 ports)	—	1 (2 ports)	—
PROFINET IO	—	●	—	●	—	●	—
PROFINET with IRT	—	●	—	●	—	●	—
PROFINET CBA	—	●	—	●	—	●	—
TCP/IP	—	●	—	●	—	●	—
UDP	—	●	—	●	—	●	—
Web server	—	●	—	●	—	●	—
ISO-on-TCP (RFC 1006)	—	●	—	●	—	●	—
Mounting dimensions							
W x H x D (mm)	25 x 290 x 219	25 x 290 x 219	25 x 290 x 219 50 x 290 x 219 ²⁾	50 x 290 x 219	25 x 290 x 219 50 x 290 x 219 ³⁾	50 x 290 x 219	50 x 290 x 219

— = cannot be used/not available
● = can be used/available

¹⁾ CPU 412-2

²⁾ CPU 414-3

³⁾ CPU 416-3

⁴⁾ also as SIPLUSextreme component for corrosive atmosphere/condensation

Overview (continued)

- The S7-400 can be structured in a modular way without any slot rules; there is a wide range of modules available both for centralized configurations and distributed structures.
- The configuration of the distributed I/O of the S7-400 can be modified during operation. In addition signal modules can be removed and inserted while live (hot swapping). This makes it very easy to expand the system or replace modules in the event of a fault.
- Storage of the entire project data, including symbols and comments, on the CPU simplifies service and maintenance calls.
- Safety engineering and standard automation can be integrated into a single S7-400; plant availability can be increased through the redundant structure of the S7-400.
- Many S7-400 components are also available in a SIPLUS extreme version for extreme environmental conditions, e.g. for use where there is a corrosive atmosphere/condensation. For more detailed information, visit www.siemens.com/siplus-extreme

For more information, refer to:

www.siemens.com/simatic-s7-400

Detailed information on SIMATIC S7-400, see *Catalog ST 400* in the Information and Download Center or SIOS.



SIMATIC S7-400, CPU	412-5H ⁴⁾	414-5H ⁴⁾	416-5H ⁴⁾	417-5H ⁴⁾	414F-3 PN/DP	416F-2	416F-3 PN/DP
Work memory	1 MB	4 MB	16 MB	32 MB	4 MB	8 MB	16 MB
Processing times (ns)							
Bit/word/ fixed point/floating point	31.25/31.25/ 31.25/62.5	18.75/18.75/ 18.75/37.5	12.5/12.5/ 12.5/25	7.5/7.5/ 7.5/15	18.75/18.75/ 18.75/37.5	12.5/12.5/ 12.5/25	12.5/12.5/ 12.5/25
Timers/counters	2048/2048	2048/2048	2048/2048	2048/2048	2048/2048	2048/2048	2048/2048
Address ranges							
Digital inputs/outputs	65536 each	65536 each	131072 each	131072 each	65536 each	131072 each	131072 each
Analog inputs/outputs	4096 each	4096 each	8192 each	8192 each	4096 each	8192 each	8192 each
DP interfaces							
Number of MPI/DP interfaces	1	1	1	1	1	1	1
Number of DP interfaces	1	1	1	1	1	1	1
Number of DP slaves per MPI/DP	32	32	32	32	32	32	32
Number of DP slaves per DP	64	96	125	125	125 each	125	125 each
Plug-in interface modules	—	—	—	—	1 x DP	—	1 x DP
Data set gateway	●	●	●	●	●	●	●
PN interfaces							
Number of PN interfaces	1 (2 ports)	1 (2 ports)	1 (2 ports)	1 (2 ports)	1 (2 ports)	—	1 (2 ports)
PROFINET IO	●	●	●	●	●	—	●
PROFINET with IRT	—	—	—	—	●	—	●
PROFINET CBA	—	—	—	—	●	—	●
TCP/IP	●	●	●	●	●	—	●
UDP	●	●	●	●	●	—	●
Web server	—	—	—	—	●	—	●
ISO-on-TCP (RFC 1006)	●	●	●	●	●	—	●
Mounting dimensions							
W x H x D (mm)	50 x 290 x 219	50 x 290 x 219	50 x 290 x 219	50 x 290 x 219	50 x 290 x 219	25 x 290 x 219	50 x 290 x 219

— = cannot be used/not available
● = can be used/available

⁴⁾ also as SIPLUSextreme component for corrosive atmosphere/condensation

SIMATIC S7-400 Advanced Controllers

Notes

6

Distributed Controllers



7/2	based on ET 200SP
7/2	<u>Standard CPUs</u>
7/2	CPU 1510SP-1 PN
7/6	CPU 1512SP-1 PN
7/10	<u>SIPLUS standard CPUs</u>
7/10	SIPLUS CPU 1510SP-1 PN
7/12	SIPLUS CPU 1512SP-1 PN
7/14	<u>Fail-safe CPUs</u>
7/14	CPU 1510SP F-1 PN
7/18	CPU 1512SP F-1 PN
7/22	<u>SIPLUS fail-safe CPUs</u>
7/22	SIPLUS CPU 1510SP F-1 PN
7/23	SIPLUS CPU 1512SP F-1 PN
7/24	<u>ET 200SP Open Controllers</u>
	<u>standard and fail-safe</u>
7/24	CPU 1515SP PC (F)
7/35	ODK 1500S

7/36	based on ET 200Pro
7/36	<u>Standard CPUs</u>
7/36	IM 154-8 PN/DP CPU
7/40	CPU 1516pro-2 PN
7/45	<u>Fail-safe CPUs</u>
7/45	IM 154-8 F PN/DP CPU
7/50	CPU 1516pro F-2 PN

Brochures

For brochures serving as selection guides for SIMATIC products, refer to:
www.siemens.com/simatic/printmaterial

Distributed Controllers

based on ET 200SP

Standard CPUs

CPU 1510SP-1 PN

Overview



- CPU 1510SP-1 PN for SIMATIC ET 200SP based on S7-1500 CPU 1511-1 PN
- For high-performance control solutions using ET 200SP
- Increase in availability of systems and machines
- PROFINET IO controller for up to 64 IO devices
- PROFINET I-device for connecting the CPU as an intelligent PROFINET device with a SIMATIC or third-party PROFINET IO controller
- PROFINET shared I-device for 4 controllers
- PROFINET IO IRT interface with integrated 3-port switch
- Isochronous mode on PROFINET
- With multiple communication options: PG/OP communication, PROFINET IO, open IE communication (TCP, ISO-on-TCP and UDP), web server and S7 communication (with loadable FBs)
- OPC UA Server (Data Access) as runtime option for the easy connection of SIMATIC ET 200SP to third-party devices/systems
- Optional PROFIBUS DP master for 125 PROFIBUS DP slaves (with CM DP module 6ES7545-5DA00-0AB0)
- Optional PROFIBUS DP slave (with CM DP module 6ES7545-5DA00-0AB0)
- Configuration control (option handling)
- Integrated motion control functionalities for controlling speed-controlled and positioning axes, support for external encoders, cams/cam tracks and probes

Note

SIMATIC Memory Card required for operation of the CPU. The BusAdapter is not included in scope of delivery and is to be ordered separately.

Technical specifications

Article number	6ES7510-1DJ01-0AB0 CPU 1510SP-1 PN, 100KB PROG./750KB DATA
General information	
Product type designation	CPU 1510SP-1 PN
Engineering with	
• STEP 7 TIA Portal configurable/ integrated as of version	V14
Supply voltage	
Type of supply voltage	24 V DC
Power loss	
Power loss, typ.	5.6 W
Memory	
Work memory	
• integrated (for program)	100 kbyte
• integrated (for data)	750 kbyte
Load memory	
• Plug-in (SIMATIC Memory Card), max.	32 Gbyte
CPU processing times	
for bit operations, typ.	72 ns
for word operations, typ.	86 ns
for fixed point arithmetic, typ.	115 ns
for floating point arithmetic, typ.	461 ns
Counters, timers and their retentivity	
S7 counter	
• Number	2 048
IEC counter	
• Number	Any (only limited by the main memory)
S7 times	
• Number	2 048
IEC timer	
• Number	Any (only limited by the main memory)
Data areas and their retentivity	
Flag	
• Number, max.	16 kbyte
Address area	
I/O address area	
• Inputs	32 kbyte; All inputs are in the process image
• Outputs	32 kbyte; All outputs are in the process image
Address space per module	
• Address space per module, max.	288 byte; For input and output data respectively
Address space per station	
• Address space per station, max.	2 560 byte; for central inputs and outputs; depending on configuration; 2 048 bytes for ET 200SP modules + 512 bytes for ET 200AL modules
Time of day	
Clock	
• Type	Hardware clock

Technical specifications (continued)

Article number	6ES7510-1DJ01-0AB0 CPU 1510SP-1 PN, 100KB PROG./750KB DATA
1. Interface	
Interface types	
• Number of ports	3; 1. integr. + 2. via BusAdapter
• integrated switch	Yes
• RJ 45 (Ethernet)	Yes; X1 P3; opt. X1 P1 and X1 P2 via BusAdapter BA 2x RJ45
• BusAdapter (PROFINET)	Yes; Applicable BusAdapter: BA 2x RJ45, BA 2x FC
Functionality	
• PROFINET IO Controller	Yes
• PROFINET IO Device	Yes
• SIMATIC communication	Yes
• Open IE communication	Yes
• Web server	Yes
• Media redundancy	Yes
PROFINET IO Controller	
Services	
- PG/OP communication	Yes
- S7 routing	Yes
- Isochronous mode	Yes
- Open IE communication	Yes
- IRT	Yes
- MRP	Yes; As MRP redundancy manager and/or MRP client; max. number of devices in the ring: 50
- MRPD	Yes; Requirement: IRT
- PROFIenergy	Yes
- Prioritized startup	Yes; Max. 32 PROFINET devices
- Number of connectable IO Devices, max.	64; In total, up to 256 distributed I/O devices can be connected via AS-i, PROFIBUS or PROFINET
- Of which IO devices with IRT, max.	64
- Number of connectable IO Devices for RT, max.	64
- of which in line, max.	64
- Number of IO Devices that can be simultaneously activated/ deactivated, max.	8; in total across all interfaces
- Number of IO Devices per tool, max.	8
- Updating times	The minimum value of the update time also depends on communi- cation share set for PROFINET IO, on the number of IO devices, and on the quantity of configured user data
Update time for IRT	
- for send cycle of 250 µs	250 µs to 4 ms; Note: In the case of IRT with isochronous mode, the minimum update time of 625 µs of the isochronous OB is decisive
- for send cycle of 500 µs	500 µs to 8 ms; Note: In the case of IRT with isochronous mode, the minimum update time of 625 µs of the isochronous OB is decisive
- for send cycle of 1 ms	1 ms to 16 ms
- for send cycle of 2 ms	2 ms to 32 ms
- for send cycle of 4 ms	4 ms to 64 ms
- With IRT and parameterization of "odd" send cycles	Update time = set "odd" send clock (any multiple of 125 µs: 375 µs, 625 µs ... 3 875 µs)

Article number	6ES7510-1DJ01-0AB0 CPU 1510SP-1 PN, 100KB PROG./750KB DATA
Update time for RT	
- for send cycle of 250 µs	250 µs to 128 ms
- for send cycle of 500 µs	500 µs to 256 ms
- for send cycle of 1 ms	1 ms to 512 ms
- for send cycle of 2 ms	2 ms to 512 ms
- for send cycle of 4 ms	4 ms to 512 ms
PROFINET IO Device	
Services	
- PG/OP communication	Yes
- S7 routing	Yes
- Isochronous mode	No
- Open IE communication	Yes
- IRT	Yes
- MRP	Yes
- MRPD	Yes; Requirement: IRT
- PROFIenergy	Yes
- Shared device	Yes
- Number of IO Controllers with shared device, max.	4
2. Interface	
Interface types	
• Number of ports	1
• RS 485	Yes; Via CM DP module
Functionality	
• PROFIBUS DP master	Yes
• PROFIBUS DP slave	Yes
• SIMATIC communication	Yes
Protocols	
Number of connections	
• Number of connections, max.	96
PROFIBUS DP master	
Services	
- Number of DP slaves	125; In total, up to 256 distributed I/O devices can be connected via AS-i, PROFIBUS or PROFINET
Isochronous mode	
Isochronous operation (application synchronized up to terminal)	Yes; Only with PROFINET; with minimum OB 6x cycle of 625 µs
Supported technology objects	
Motion Control	Yes; Note: The number of axes affects the cycle time of the PLC program; selection guide via the TIA Selection Tool or SIZER
• Number of available Motion Control resources for technology objects (except cam disks)	800
• Required Motion Control resources	
- per speed-controlled axis	40
- per positioning axis	80
- per synchronous axis	160
- per external encoder	80
- per output cam	20
- per cam track	160
- per probe	40
Controller	
• PID_Compact	Yes; Universal PID controller with integrated optimization
• PID_3Step	Yes; PID controller with integrated optimization for valves
• PID-Temp	Yes; PID controller with integrated optimization for temperature
Counting and measuring	
• High-speed counter	Yes

Distributed Controllers

based on ET 200SP
Standard CPUs

CPU 1510SP-1 PN

Technical specifications (continued)

Article number	6ES7510-1DJ01-0AB0 CPU 1510SP-1 PN, 100KB PROG./750KB DATA
Ambient conditions	
Ambient temperature during operation	
• horizontal installation, min.	0 °C
• horizontal installation, max.	60 °C
• vertical installation, min.	0 °C
• vertical installation, max.	50 °C
Configuration	
Programming	
Programming language	
- LAD	Yes
- FBD	Yes
- STL	Yes
- SCL	Yes
- GRAPH	Yes

Article number	6ES7510-1DJ01-0AB0 CPU 1510SP-1 PN, 100KB PROG./750KB DATA
Know-how protection	
• User program protection/password protection	Yes
• Copy protection	Yes
• Block protection	Yes
Access protection	
• Protection level: Write protection	Yes
• Protection level: Read/write protection	Yes
• Protection level: Complete protection	Yes
Dimensions	
Width	100 mm
Height	117 mm
Depth	75 mm
Weights	
Weight, approx.	310 g

7

Ordering data

Ordering data	Article No.
CPU 1510SP-1 PN Work memory 100 KB for program, 750 KB for data, PROFINET I/O IRT interface; SIMATIC Memory Card required	6ES7510-1DJ01-0AB0
Accessories	
CM DP for ET 200SP CPU PROFIBUS DP master/slave with electrical interface for connecting the ET 200SP CPUs to PROFIBUS at up to 12 Mbit/s	6ES7545-5DA00-0AB0
SIMATIC Memory Card	
4 MB	6ES7954-8LC02-0AA0
12 MB	6ES7954-8LE02-0AA0
24 MB	6ES7954-8LF02-0AA0
256 MB	6ES7954-8LL02-0AA0
2 GB	6ES7954-8LP02-0AA0
32 GB	6ES7954-8LT03-0AA0
DIN rail 35 mm	
• Length: 483 mm for 19" cabinets	6ES5710-8MA11
• Length: 530 mm for 600 mm cabinets	6ES5710-8MA21
• Length: 830 mm for 900 mm cabinets	6ES5710-8MA31
• Length: 2 m	6ES5710-8MA41
PE connection element for DIN rail 2000 mm	6ES7590-5AA00-0AA0
BusAdapter BA 2xRJ45	6ES7193-6AR00-0AA0
BusAdapter BA 2xFC for increased vibration and EMC loads	6ES7193-6AF00-0AA0
BusAdapter BA 2xSCRJ	6ES7193-6AP00-0AA0
BusAdapter BA SCRJ/RJ45	6ES7193-6AP20-0AA0
BusAdapter BA SCRJ/FC	6ES7193-6AP40-0AA0
Reference identification label	6ES7193-6LF30-0AW0
10 sheets of 16 labels	

Article No.

Labeling strips	Article No.
500 labeling strips on roll, light gray, for inscription with thermal transfer roll printer	6ES7193-6LR10-0AA0
500 labeling strips on roll, yellow, for inscription with thermal transfer roll printer	6ES7193-6LR10-0AG0
1000 labeling strips DIN A4, light gray, card, for inscription with laser printer	6ES7193-6LA10-0AA0
1000 labeling strips DIN A4, yellow, card, for inscription with laser printer	6ES7193-6LA10-0AG0
IE FC RJ45 plugs	
RJ45 plug connector for Industrial Ethernet with a rugged metal enclosure and integrated insulation displacement contacts for connecting Industrial Ethernet FC installation cables	
IE FC RJ45 Plug 90	
90° cable outlet	
1 unit	6GK1901-1BB20-2AA0
10 units	6GK1901-1BB20-2AB0
50 units	6GK1901-1BB20-2AE0
IE FC RJ45 Plug 180	
180° cable outlet	
1 unit	6GK1901-1BB10-2AA0
10 units	6GK1901-1BB10-2AB0
50 units	6GK1901-1BB10-2AE0

Ordering data	Article No.	Ordering data	Article No.
IE FC TP Standard Cable GP 2x2 4-wire, shielded TP installation cable for connection to IE FC outlet RJ45/ IE FC RJ45 plug; PROFINET-compatible; with UL approval; sold by the meter; max. delivery unit 1000 m, minimum order quantity 20 m	6XV1840-2AH10	SIMATIC Manual Collection Electronic manuals on DVD, multi-language: LOGO!, SIMADYN, SIMATIC bus components, SIMATIC C7, SIMATIC distributed I/O, SIMATIC HMI, SIMATIC Sensors, SIMATIC NET, SIMATIC PC Based Automation, SIMATIC PCS 7, SIMATIC PG/PC, SIMATIC S7, SIMATIC Software, SIMATIC TDC	6ES7998-8XC01-8YE0
IE FC TP Trailing Cable 2 x 2 (Type C) 4-wire, shielded TP installation cable for connection to IE FC outlet RJ45/ IE FC RJ45 Plug 180/90 for use as trailing cable; PROFINET-compatible; with UL approval; sold by the meter; max. delivery unit 1000 m, minimum order quantity 20 m	6XV1840-3AH10	SIMATIC Manual Collection update service for 1 year Current "Manual Collection" DVD and the three subsequent updates	6ES7998-8XC01-8YE2
IE FC TP Marine Cable 2 x 2 (Type B) 4-wire, shielded TP installation cable for connection to IE FC outlet RJ45/ IE FC RJ45 Plug 180/90 with marine approval, sold by the meter; max. delivery unit 1000 m, minimum order quantity 20 m	6XV1840-4AH10	STEP 7 Professional V14 SP1 Target system: SIMATIC S7-1200, S7-1500, S7-300, S7-400, WinAC Requirement: Windows 7 Professional SP1 (64-bit), Windows 7 Enterprise SP1 (64-bit), Windows 7 Ultimate SP1 (64-bit), Windows 8.1 Professional (64-bit), Windows 8.1 Enterprise (64-bit), Windows 10 Professional Version 1607, Windows 10 Enterprise Version 1607, Windows 10 Enterprise 2016 LTSB, Windows 10 Enterprise 2015 LTSB, Windows Server 2008 R2 StdE (full installation), Windows Server 2012 StdE (full installation), Windows Server 2016 Standard (full installation); Type of delivery: German, English, Chinese, Italian, French, Spanish	
IE FC Stripping Tool Preadjusted stripping tool for fast stripping of Industrial Ethernet FC cables	6GK1901-1GA00	STEP 7 Professional V14 SP1, floating license STEP 7 Professional V14 SP1, floating license, software download incl. license key ¹⁾ Email address required for delivery	6ES7822-1AA04-0YA5 6ES7822-1AE04-0YA5
Manuals for ET 200SP distributed I/O system ET 200SP library: ET 200SP Manual Collection, comprising system manual, product information, and device manuals Manuals can be downloaded from the Internet as PDF files: http://www.siemens.com/simatic-docu		Spare parts Power supply connector Spare part; for connecting the 24 V DC supply voltage • With push-in terminals; 10 units Cover for bus adapter interface 5 units Server module	6ES7193-4JB00-0AA0 6ES7591-3AA00-0AA0 6ES7193-6PA00-0AA0

¹⁾ For up-to-date information and download availability, see:
<http://www.siemens.com/tia-online-software-delivery>

Distributed Controllers

based on ET 200SP
Standard CPUs

CPU 1512SP-1 PN

Overview

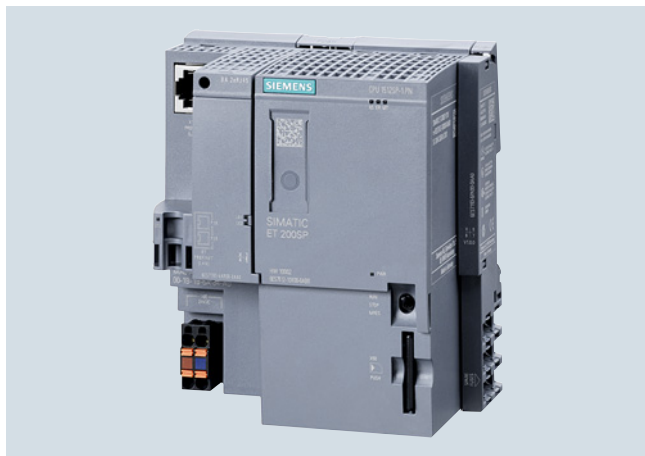

- CPU 1512SP-1 PN for SIMATIC ET 200SP based on S7-1500 CPU 1513-1 PN
- For applications with medium requirements regarding the program scope and processing speed, for distributed setup via PROFINET IO or PROFIBUS DP.
- Increase in availability of systems and machines
- PROFINET IO controller for up to 128 IO devices
- PROFINET I-Device for connecting the CPU as an intelligent PROFINET device with a SIMATIC or third-party PROFINET IO controller
- PROFINET shared I-device for 4 controllers
- PROFINET IO IRT interface with integrated 3-port switch
- Isochronous mode on PROFINET
- With multiple communication options: PG/OP communication, PROFINET IO, open IE communication (TCP, ISO-on-TCP and UDP), web server and S7 communication (with loadable FBs)
- OPC UA Server (Data Access) as runtime option for the easy connection of SIMATIC ET 200SP to third-party devices/systems
- Optional PROFIBUS DP master for 125 PROFIBUS DP slaves (with CM DP module 6ES7545-5DA00-0AB0)
- Optional PROFIBUS DP slave (with CM DP module 6ES7545-5DA00-0AB0)
- Configuration control (option handling)
- Integrated motion control functionalities for controlling speed-controlled and positioning axes, support for external encoders, cams/cam tracks and probes

Note

SIMATIC Memory Card required for operation of the CPU. BusAdapter is not included in scope of delivery and is to be ordered separately.

Technical specifications

Article number	6ES7512-1DK01-0AB0 CPU 1512SP-1 PN, 200KB PROG./1MB DATA
General information	
Product type designation	CPU 1512SP-1 PN
Engineering with	
• STEP 7 TIA Portal configurable/ integrated as of version	V14
Supply voltage	
Type of supply voltage	24 V DC
Power loss	
Power loss, typ.	5.6 W
Memory	
Work memory	
• integrated (for program)	200 kbyte
• integrated (for data)	1 Mbyte
Load memory	
• Plug-in (SIMATIC Memory Card), max.	32 Gbyte
CPU processing times	
for bit operations, typ.	48 ns
for word operations, typ.	58 ns
for fixed point arithmetic, typ.	77 ns
for floating point arithmetic, typ.	307 ns
Counters, timers and their retentivity	
S7 counter	
• Number	2 048
IEC counter	
• Number	Any (only limited by the main memory)
S7 times	
• Number	2 048
IEC timer	
• Number	Any (only limited by the main memory)
Data areas and their retentivity	
Flag	
• Number, max.	16 kbyte
Address area	
I/O address area	
• Inputs	32 kbyte; All inputs are in the process image
• Outputs	32 kbyte; All outputs are in the process image
Address space per module	
• Address space per module, max.	288 byte; For input and output data respectively
Address space per station	
• Address space per station, max.	2 560 byte; for central inputs and outputs; depending on configuration; 2 048 bytes for ET 200SP modules + 512 bytes for ET 200AL modules
Time of day	
Clock	
• Type	Hardware clock

Technical specifications (continued)

Article number	6ES7512-1DK01-0AB0 CPU 1512SP-1 PN, 200KB PROG./1MB DATA
1. Interface	
Interface types	
• Number of ports	3; 1. integr. + 2. via BusAdapter
• integrated switch	Yes
• RJ 45 (Ethernet)	Yes; X1 P3; opt. X1 P1 and X1 P2 via BusAdapter BA 2x RJ45
• BusAdapter (PROFINET)	Yes; Compatible BusAdapter: BA 2x RJ45, BA 2x FC, BA 2x SCRJ, BA SCRJ / RJ45, BA SCRJ / FC, BA 2x LC, BA LC / RJ45, BA LC / FC
Functionality	
• PROFINET IO Controller	Yes
• PROFINET IO Device	Yes
• SIMATIC communication	Yes
• Open IE communication	Yes
• Web server	Yes
• Media redundancy	Yes
PROFINET IO Controller	
Services	
- PG/OP communication	Yes
- S7 routing	Yes
- Isochronous mode	Yes
- Open IE communication	Yes
- IRT	Yes
- MRP	Yes; As MRP redundancy manager and/or MRP client; max. number of devices in the ring: 50
- MRPD	Requirement: IRT
- PROFIenergy	Yes
- Prioritized startup	Yes; Max. 32 PROFINET devices
- Number of connectable IO Devices, max.	128; In total, up to 512 distributed I/O devices can be connected via AS-i, PROFIBUS or PROFINET
- Of which IO devices with IRT, max.	64
- Number of connectable IO Devices for RT, max.	128
- of which in line, max.	128
- Number of IO Devices that can be simultaneously activated/ deactivated, max.	8; in total across all interfaces
- Number of IO Devices per tool, max.	8
- Updating times	The minimum value of the update time also depends on communi- cation share set for PROFINET IO, on the number of IO devices, and on the quantity of configured user data
Update time for IRT	
- for send cycle of 250 µs	250 µs to 4 ms; Note: In the case of IRT with isochronous mode, the minimum update time of 500 µs of the isochronous OB is decisive
- for send cycle of 500 µs	500 µs to 8 ms
- for send cycle of 1 ms	1 ms to 16 ms
- for send cycle of 2 ms	2 ms to 32 ms
- for send cycle of 4 ms	4 ms to 64 ms
- With IRT and parameterization of "odd" send cycles	Update time = set "odd" send clock (any multiple of 125 µs: 375 µs, 625 µs ... 3 875 µs)
Update time for RT	
- for send cycle of 250 µs	250 µs to 128 ms
- for send cycle of 500 µs	500 µs to 256 ms
- for send cycle of 1 ms	1 ms to 512 ms
- for send cycle of 2 ms	2 ms to 512 ms
- for send cycle of 4 ms	4 ms to 512 ms

Article number	6ES7512-1DK01-0AB0 CPU 1512SP-1 PN, 200KB PROG./1MB DATA
PROFINET IO Device	
Services	
- PG/OP communication	Yes
- S7 routing	Yes
- Isochronous mode	No
- Open IE communication	Yes
- IRT	Yes
- MRP	Yes
- MRPD	Yes; Requirement: IRT
- PROFIenergy	Yes
- Shared device	Yes
- Number of IO Controllers with shared device, max.	4
2. Interface	
Interface types	
• Number of ports	1
• RS 485	Yes; Via CM DP module
Functionality	
• PROFIBUS DP master	Yes
• PROFIBUS DP slave	Yes
• SIMATIC communication	Yes
Protocols	
Number of connections	
• Number of connections, max.	128
PROFIBUS DP master	
Services	
- Number of DP slaves	125; In total, up to 512 distributed I/O devices can be connected via AS-i, PROFIBUS or PROFINET
Isochronous mode	
Isochronous operation (application synchronized up to terminal)	Yes; Only with PROFINET; with minimum OB 6x cycle of 625 µs
Supported technology objects	
Motion Control	Yes; Note: The number of technology objects affects the cycle time of the PLC program; selection guide via the TIA Selection Tool or SIZER
• Number of available Motion Control resources for technology objects (except cam disks)	800
• Required Motion Control resources	
- per speed-controlled axis	40
- per positioning axis	80
- per synchronous axis	160
- per external encoder	80
- per output cam	20
- per cam track	160
- per probe	40
Controller	
• PID_Compact	Yes; Universal PID controller with integrated optimization
• PID_3Step	Yes; PID controller with integrated optimization for valves
• PID-Temp	Yes; PID controller with integrated optimization for temperature
Counting and measuring	
• High-speed counter	Yes

Distributed Controllers

based on ET 200SP
Standard CPUs

CPU 1512SP-1 PN

Technical specifications (continued)

Article number	6ES7512-1DK01-0AB0 CPU 1512SP-1 PN, 200KB PROG./1MB DATA
Ambient conditions	
Ambient temperature during operation	
• horizontal installation, min.	0 °C
• horizontal installation, max.	60 °C
• vertical installation, min.	0 °C
• vertical installation, max.	50 °C
Configuration	
Programming	
Programming language	
- LAD	Yes
- FBD	Yes
- STL	Yes
- SCL	Yes
- GRAPH	Yes

Article number	6ES7512-1DK01-0AB0 CPU 1512SP-1 PN, 200KB PROG./1MB DATA
Know-how protection	
• User program protection/password protection	Yes
• Copy protection	Yes
• Block protection	Yes
Access protection	
• Protection level: Write protection	Yes
• Protection level: Read/write protection	Yes
• Protection level: Complete protection	Yes
Dimensions	
Width	100 mm
Height	117 mm
Depth	75 mm
Weights	
Weight, approx.	310 g

7

Ordering data

Ordering data	Article No.
CPU 1512SP-1 PN Work memory 200 KB for program, 1 MB for data, PROFINET IO IRT interface; SIMATIC Memory Card required	6ES7512-1DK01-0AB0
Accessories	
CM DP for ET 200SP CPU PROFIBUS DP master/slave with electrical interface for connecting the ET 200SP CPUs to PROFIBUS at up to 12 Mbit/s	6ES7545-5DA00-0AB0
SIMATIC Memory Card	
4 MB	6ES7954-8LC02-0AA0
12 MB	6ES7954-8LE02-0AA0
24 MB	6ES7954-8LF02-0AA0
256 MB	6ES7954-8LL02-0AA0
2 GB	6ES7954-8LP02-0AA0
32 GB	6ES7954-8LT03-0AA0
DIN rail 35 mm	
• Length: 483 mm for 19" cabinets	6ES710-8MA11
• Length: 530 mm for 600 mm cabinets	6ES710-8MA21
• Length: 830 mm for 900 mm cabinets	6ES710-8MA31
• Length: 2 m	6ES710-8MA41
PE connection element for DIN rail 2000 mm	6ES7590-5AA00-0AA0

Article No.

BusAdapter BA 2xRJ45	6ES7193-6AR00-0AA0
BusAdapter BA 2xFC for increased vibration and EMC loads	6ES7193-6AF00-0AA0
BusAdapter BA 2xSCRJ	6ES7193-6AP00-0AA0
BusAdapter BA SCRJ/RJ45	6ES7193-6AP20-0AA0
BusAdapter BA SCRJ/FC	6ES7193-6AP40-0AA0
BusAdapter BA 2xLC	6ES7193-6AG00-0AA0
BusAdapter BA LC/RJ45	6ES7193-6AG20-0AA0
BusAdapter BA LC/FC	6ES7193-6AG40-0AA0
Reference identification label 10 sheets of 16 labels	6ES7193-6LF30-0AW0
Labeling strips	
500 labeling strips on roll, light gray, for inscription with thermal transfer roll printer	6ES7193-6LR10-0AA0
500 labeling strips on roll, yellow, for inscription with thermal transfer roll printer	6ES7193-6LR10-0AG0
1000 labeling strips DIN A4, light gray, card, for inscription with laser printer	6ES7193-6LA10-0AA0
1000 labeling strips DIN A4, yellow, card, for inscription with laser printer	6ES7193-6LA10-0AG0

Ordering data	Article No.	Article No.
IE FC RJ45 plugs RJ45 plug connector for Industrial Ethernet with a rugged metal enclosure and integrated insulation displacement contacts for connecting Industrial Ethernet FC installation cables		SIMATIC Manual Collection Electronic manuals on DVD, multi-language: LOGO!, SIMADYN, SIMATIC bus components, SIMATIC C7, SIMATIC distributed I/O, SIMATIC HMI, SIMATIC Sensors, SIMATIC NET, SIMATIC PC Based Automation, SIMATIC PCS 7, SIMATIC PG/PC, SIMATIC S7, SIMATIC Software, SIMATIC TDCATIC TDC
IE FC RJ45 Plug 90 90° cable outlet 1 unit 10 units 50 units	6GK1901-1BB20-2AA0 6GK1901-1BB20-2AB0 6GK1901-1BB20-2AE0	6ES7998-8XC01-8YE0 SIMATIC Manual Collection update service for 1 year Current "Manual Collection" DVD and the three subsequent updates
IE FC RJ45 Plug 180 180° cable outlet 1 unit/plug 10 units 50 units	6GK1901-1BB10-2AA0 6GK1901-1BB10-2AB0 6GK1901-1BB10-2AE0	STEP 7 Professional V14 SP1 Target system: SIMATIC S7-1200, S7-1500, S7-300, S7-400, WinAC Requirement: Windows 7 Professional SP1 (64-bit), Windows 7 Enterprise SP1 (64-bit), Windows 7 Ultimate SP1 (64-bit), Windows 8.1 Professional (64-bit), Windows 8.1 Enterprise (64-bit), Windows 10 Professional Version 1607, Windows 10 Enterprise Version 1607, Windows 10 Enterprise 2016 LTSB, Windows 10 Enterprise 2015 LTSB, Windows Server 2008 R2 StdE (full installation), Windows Server 2012 StdE (full installation), Windows Server 2016 Standard (full installation); Type of delivery: German, English, Chinese, Italian, French, Spanish
IE FC TP Standard Cable GP 2x2 4-wire, shielded TP installation cable for connection to IE FC outlet RJ45/ IE FC RJ45 plug; PROFINET-compatible; with UL approval; sold by the meter; max. delivery unit 1000 m, minimum order quantity 20 m	6XV1840-2AH10	6ES7998-8XC01-8YE2 STEP 7 Professional V14 SP1 Current "Manual Collection" DVD and the three subsequent updates
IE FC TP Trailing Cable 2 x 2 (Type C) 4-wire, shielded TP installation cable for connection to IE FC outlet RJ45/ IE FC RJ45 Plug 180/90 for use as trailing cable; PROFINET-compatible; with UL approval; sold by the meter; max. delivery unit 1000 m, minimum order quantity 20 m	6XV1840-3AH10	6ES7822-1AA04-0YA5 6ES7822-1AE04-0YA5
IE FC TP Marine Cable 2 x 2 (Type B) 4-wire, shielded TP installation cable for connection to IE FC outlet RJ45/ IE FC RJ45 Plug 180/90 with marine approval, sold by the meter; max. delivery unit 1000 m, minimum order quantity 20 m	6XV1840-4AH10	6ES7822-1AA04-0YA5 6ES7822-1AE04-0YA5 floating license, software download incl. license key ¹⁾ Email address required for delivery
IE FC Stripping Tool Preadjusted stripping tool for fast stripping of Industrial Ethernet FC cables	6GK1901-1GA00	Spare parts Power supply connector Spare part; for connecting the 24 V DC supply voltage • With push-in terminals; 10 units
Manuals for ET 200SP distributed I/O system ET 200SP library: ET 200SP Manual Collection, comprising system manual, product information, and device manuals Manuals can be downloaded from the Internet as PDF files: http://www.siemens.com/simatic-docu		Cover for bus adapter interface 5 units Server module
		6ES7193-4JB00-0AA0 6ES7591-3AA00-0AA0 6ES7193-6PA00-0AA0

¹⁾ For up-to-date information and download availability, see:
<http://www.siemens.com/tia-online-software-delivery>

Distributed Controllers

based on ET 200SP
SIPLUS standard CPUs

SIPLUS CPU 1510SP-1 PN

Overview

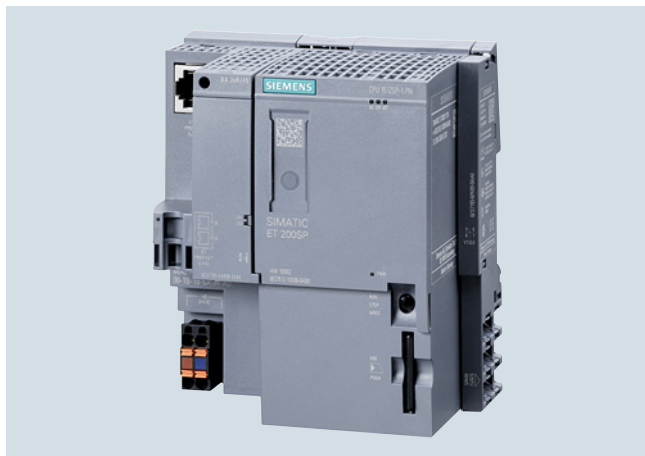

- SIPLUS CPU 1510SP-1 PN for SIPLUS ET 200SP based on SIPLUS-S7-1500 CPU 1511-1 PN
- For high-performance control solutions using ET 200SP
- Increase in availability of systems and machines
- PROFINET IO controller for up to 64 IO devices
- PROFINET I-Device for connecting the CPU as an intelligent PROFINET device with a SIMATIC or third-party PROFINET IO controller
- PROFINET shared I-device for 4 controllers
- PROFINET IO IRT interface with integrated 3-port switch
- Isochronous mode on PROFINET
- With multiple communication options: PG/OP communication, PROFINET IO, open IE communication (TCP, ISO-on-TCP and UDP), web server and S7 communication (with loadable FBs)
- Optional PROFIBUS DP master for 125 PROFIBUS DP slaves (with CM DP module 6ES7545-5DA00-0AB0)
- Optional PROFIBUS DP slave (with CM DP module 6ES7545-5DA00-0AB0)
- Configuration control (option handling)
- Integrated motion control functionalities for controlling speed-controlled and positioning axes, support for external encoders

Note

SIMATIC Memory Card required for operation of the CPU. The BusAdapter is not included in scope of delivery and is to be ordered separately.

SIPLUS extreme products are based on SIMATIC standard products. The contents listed here were taken from the respective standard products. SIPLUS extreme specific information was added.

Technical specifications

Article number	6AG1510-1DJ01-2AB0
Based on	6ES7510-1DJ01-0AB0 SIPLUS ET 200SP CPU 1510SP-1 PN
Ambient conditions	
Ambient temperature during operation	
• horizontal installation, min.	-40 °C; = Tmin; Startup @ -25 °C
• horizontal installation, max.	60 °C
• vertical installation, min.	0 °C
• vertical installation, max.	50 °C
Extended ambient conditions	
• relative to ambient temperature-atmospheric pressure-installation altitude	Tmin ... Tmax at 1080 hPa ... 795 hPa (-1000 m ... +2000 m) // Tmin ... (Tmax - 10K) at 795 hPa ... 658 hPa (+2000 m ... +3500 m) // Tmin ... (Tmax - 20K) at 658 hPa ... 540 hPa (+3500 m ... +5000 m)
Relative humidity	
- With condensation, tested in accordance with IEC 60068-2-38, max.	100 %; RH incl. condensation / frost (no commissioning in bedewed state), horizontal installation
Resistance	
- against biologically active substances / conformity with EN 60721-3-3	Yes; Class 3B2 mold, fungus and dry rot spores (with the exception of fauna). The supplied connector covers must remain on the unused interfaces during operation!
- against chemically active substances / conformity with EN 60721-3-3	Yes; Class 3C4 (RH < 75%) incl. salt spray according to EN 60068-2-52 (degree of severity 3). The supplied connector covers must remain on the unused interfaces during operation!
- against mechanically active substances / conformity with EN 60721-3-3	Yes; Class 3S4 incl. sand, dust. The supplied connector covers must remain on the unused interfaces during operation!

Ordering data	Article No.	Accessories	Article No.
SIPLUS CPU 1510SP-1 PN (Extended temperature range and exposure to media) Work memory 100 KB for program, 750 KB for data, PROFINET IO IRT interface; SIMATIC Memory Card required	6AG1510-1DJ01-2AB0	BusAdapter BA 2xRJ45 (Extended temperature range and exposure to media) BusAdapter BA 2xFC for increased vibration and EMC loads (Extended temperature range and exposure to media) IE FC RJ45 plugs RJ45 plug connector for Industrial Ethernet with a rugged metal enclosure and integrated insulation displacement contacts for connecting Industrial Ethernet FC installation cables IE FC RJ45 Plug 180 (Extended temperature range and exposure to media) 180° cable outlet 1 unit Additional accessories	6AG1193-6AR00-7AA0 6AG1193-6AF00-7AA0 6AG1901-1BB10-7AA0 see SIMATIC ET 200SP CPU 1510SP-1 PN, page 7/4

Distributed Controllers

based on ET 200SP
SIPLUS standard CPUs

SIPLUS CPU 1512SP-1 PN

Overview



- SIPLUS CPU 1512SP-1 PN for SIPLUS ET 200SP based on SIPLUS-S7-1500 CPU 1513-1 PN
- For applications with medium requirements regarding the program scope and processing speed, for distributed setup via PROFINET IO or PROFIBUS DP.
- Increase in availability of systems and machines
- PROFINET IO controller for up to 128 IO devices
- PROFINET I-Device for connecting the CPU as an intelligent PROFINET device with a SIMATIC or third-party PROFINET IO controller
- PROFINET shared I-device for 4 controllers
- PROFINET IO IRT interface with integrated 3-port switch
- Isochronous mode on PROFINET
- With multiple communication options: PG/OP communication, PROFINET IO, open IE communication (TCP, ISO-on-TCP and UDP), web server and S7 communication (with loadable FBs)
- Optional PROFIBUS DP master for 125 PROFIBUS DP slaves (with CM DP module 6ES7545-5DA00-0AB0)
- Optional PROFIBUS DP slave (with CM DP module 6ES7545-5DA00-0AB0)
- Configuration control (option handling)
- Integrated motion control functionalities for controlling speed-controlled and positioning axes, support for external encoders

Note

SIMATIC Memory Card required for operation of the CPU. BusAdapter is not included in scope of delivery and is to be ordered separately.

SIPLUS extreme products are based on SIMATIC standard products. The contents listed here were taken from the respective standard products. SIPLUS extreme specific information was added.

Technical specifications

Article number	6AG1512-1DK01-2AB0
Based on	6ES7512-1DK01-0AB0 SIPLUS ET 200SP CPU 1512SP-1 PN
Ambient conditions	
Ambient temperature during operation	
• horizontal installation, min.	-40 °C; = Tmin; Startup @ -25 °C
• horizontal installation, max.	60 °C
• vertical installation, min.	0 °C
• vertical installation, max.	50 °C
Extended ambient conditions	
• relative to ambient temperature-atmospheric pressure-installation altitude	Tmin ... Tmax at 1080 hPa ... 795 hPa (-1000 m ... +2000 m) // Tmin ... (Tmax - 10K) at 795 hPa ... 658 hPa (+2000 m ... +3500 m) // Tmin ... (Tmax - 20K) at 658 hPa ... 540 hPa (+3500 m ... +5000 m)
Relative humidity	
- With condensation, tested in accordance with IEC 60068-2-38, max.	100 %; RH incl. condensation / frost (no commissioning in bedewed state), horizontal installation
Resistance	
- against biologically active substances / conformity with EN 60721-3-3	Yes; Class 3B2 mold, fungus and dry rot spores (with the exception of fauna). The supplied connector covers must remain on the unused interfaces during operation!
- against chemically active substances / conformity with EN 60721-3-3	Yes; Class 3C4 (RH < 75%) incl. salt spray according to EN 60068-2-52 (degree of severity 3). The supplied connector covers must remain on the unused interfaces during operation!
- against mechanically active substances / conformity with EN 60721-3-3	Yes; Class 3S4 incl. sand, dust. The supplied connector covers must remain on the unused interfaces during operation!

Ordering data	Article No.		Article No.
<p>SIPLUS CPU 1512SP-1 PN</p> <p>(Extended temperature range and exposure to media)</p> <p>Work memory 200 KB for program, 1 MB for data, PROFINET IO IRT interface; SIMATIC Memory Card required</p>	<p>6AG1512-1DK01-2AB0</p>	<p>Accessories</p> <hr/> <p>BusAdapter BA 2xRJ45</p> <p>(Extended temperature range and exposure to media)</p> <hr/> <p>BusAdapter BA 2xFC for increased vibration and EMC loads</p> <p>(Extended temperature range and exposure to media)</p> <hr/> <p>IE FC RJ45 plugs</p> <p>RJ45 plug connector for Industrial Ethernet with a rugged metal enclosure and integrated insulation displacement contacts for connecting Industrial Ethernet FC installation cables</p> <hr/> <p>IE FC RJ45 Plug 180</p> <p>180° cable outlet</p> <p>1 unit</p> <hr/> <p>Additional accessories</p>	<p>6AG1193-6AR00-7AA0</p> <hr/> <p>6AG1193-6AF00-7AA0</p> <hr/> <p>6AG1901-1BB10-7AA0</p> <p>see SIMATIC ET 200SP, CPU 1512SP-1 PN, page 7/8</p>

Distributed Controllers

based on ET 200SP

Fail-safe CPUs

CPU 1510SP F-1 PN

Overview



- CPU 1510SP F-1 PN for SIMATIC ET 200SP based on S7-1500 CPU 1511F-1 PN
- For high-performance control solutions using ET 200SP
- Increase in availability of systems and machines
- Supports PROFIsafe in centralized and distributed configurations
- PROFINET IO controller for up to 64 IO devices
- PROFINET I-Device for connecting the CPU as an intelligent PROFINET device with a SIMATIC or third-party PROFINET IO controller
- PROFINET Shared I-Device for 4 controllers
- PROFINET IO IRT interface with integrated 3-port switch
- Isochronous mode on PROFINET
- With multiple communication options: PG/OP communication, PROFINET IO, open IE communication (TCP, ISO-on-TCP and UDP), web server and S7 communication (with loadable FBs)
- Optional PROFIBUS master for 125 PROFIBUS DP slaves (with CM DP module 6ES7545-5DA00-0AB0)
- Configuration control (option handling)
- Integrated motion control functionalities for controlling speed-controlled and positioning axes, support for external encoders

Note

SIMATIC Memory Card required for operation of the CPU.

The BusAdapter is not included in the scope of supply and must be ordered separately.

Technical specifications

Article number	6ES7510-1SJ01-0AB0 CPU1510SP F-1 PN, 150KB PROG./750KB DATA
General information	
Product type designation	CPU 1510SP F-1 PN
Engineering with	
• STEP 7 TIA Portal configurable/ integrated as of version	V14
Supply voltage	
Type of supply voltage	24 V DC
Power loss	
Power loss, typ.	5.6 W
Memory	
Work memory	
• integrated (for program)	150 kbyte
• integrated (for data)	750 kbyte
Load memory	
• Plug-in (SIMATIC Memory Card), max.	32 Gbyte
CPU processing times	
for bit operations, typ.	72 ns
for word operations, typ.	86 ns
for fixed point arithmetic, typ.	115 ns
for floating point arithmetic, typ.	461 ns
Counters, timers and their retentivity	
S7 counter	
• Number	2 048
IEC counter	
• Number	Any (only limited by the main memory)
S7 times	
• Number	2 048
IEC timer	
• Number	Any (only limited by the main memory)
Data areas and their retentivity	
Flag	
• Number, max.	16 kbyte
Address area	
I/O address area	
• Inputs	32 kbyte; All inputs are in the process image
• Outputs	32 kbyte; All outputs are in the process image
Address space per module	
• Address space per module, max.	288 byte; For input and output data respectively
Address space per station	
• Address space per station, max.	2 560 byte; for central inputs and outputs; depending on configuration; 2 048 bytes for ET 200SP modules + 512 bytes for ET 200AL modules
Time of day	
Clock	
• Type	Hardware clock

Technical specifications (continued)

Article number	6ES7510-1SJ01-0AB0 CPU 1510SP F-1 PN, 150KB PROG./750KB DATA
1. Interface	
Interface types	
• Number of ports	3; 1. integr. + 2. via BusAdapter
• integrated switch	Yes
• RJ 45 (Ethernet)	Yes; X1 P3; opt. X1 P1 and X1 P2 via BusAdapter BA 2x RJ45
• BusAdapter (PROFINET)	Yes; Applicable BusAdapter: BA 2x RJ45, BA 2x FC
Functionality	
• PROFINET IO Controller	Yes
• PROFINET IO Device	Yes
• SIMATIC communication	Yes
• Open IE communication	Yes
• Web server	Yes
• Media redundancy	Yes
PROFINET IO Controller	
Services	
- PG/OP communication	Yes
- S7 routing	Yes
- Isochronous mode	Yes
- Open IE communication	Yes
- IRT	Yes
- MRP	Yes; As MRP redundancy manager and/or MRP client; max. number of devices in the ring: 50
- MRPD	Yes; Requirement: IRT
- PROFIenergy	Yes
- Prioritized startup	Yes; Max. 32 PROFINET devices
- Number of connectable IO Devices, max.	64; In total, up to 256 distributed I/O devices can be connected via AS-i, PROFIBUS or PROFINET
- Of which IO devices with IRT, max.	64
- Number of connectable IO Devices for RT, max.	64
- of which in line, max.	64
- Number of IO Devices that can be simultaneously activated/ deactivated, max.	8; in total across all interfaces
- Number of IO Devices per tool, max.	8
- Updating times	The minimum value of the update time also depends on communi- cation share set for PROFINET IO, on the number of IO devices, and on the quantity of configured user data
Update time for IRT	
- for send cycle of 250 µs	250 µs to 4 ms; Note: In the case of IRT with isochronous mode, the minimum update time of 625 µs of the isochronous OB is decisive
- for send cycle of 500 µs	500 µs to 8 ms; Note: In the case of IRT with isochronous mode, the minimum update time of 625 µs of the isochronous OB is decisive
- for send cycle of 1 ms	1 ms to 16 ms
- for send cycle of 2 ms	2 ms to 32 ms
- for send cycle of 4 ms	4 ms to 64 ms
- With IRT and parameterization of "odd" send cycles	Update time = set "odd" send clock (any multiple of 125 µs: 375 µs, 625 µs ... 3 875 µs)
Update time for RT	
- for send cycle of 250 µs	250 µs to 128 ms
- for send cycle of 500 µs	500 µs to 256 ms
- for send cycle of 1 ms	1 ms to 512 ms
- for send cycle of 2 ms	2 ms to 512 ms
- for send cycle of 4 ms	4 ms to 512 ms

Article number	6ES7510-1SJ01-0AB0 CPU 1510SP F-1 PN, 150KB PROG./750KB DATA
PROFINET IO Device	
Services	
- PG/OP communication	Yes
- S7 routing	Yes
- Isochronous mode	No
- Open IE communication	Yes
- IRT	Yes
- MRP	Yes
- MRPD	Yes; Requirement: IRT
- PROFIenergy	Yes
- Shared device	Yes
- Number of IO Controllers with shared device, max.	4
2. Interface	
Interface types	
• Number of ports	1
• RS 485	Yes; Via CM DP module
Functionality	
• PROFIBUS DP master	Yes
• PROFIBUS DP slave	Yes
• SIMATIC communication	Yes
Protocols	
Number of connections	
• Number of connections, max.	96
PROFIBUS DP master	
Services	
- Number of DP slaves	125; In total, up to 256 distributed I/O devices can be connected via AS-i, PROFIBUS or PROFINET
Isochronous mode	
Isochronous operation (application synchronized up to terminal)	Yes; Only with PROFINET; with minimum OB 6x cycle of 625 µs
Supported technology objects	
Motion Control	Yes; Note: The number of axes affects the cycle time of the PLC program; selection guide via the TIA Selection Tool or SIZER
• Number of available Motion Control resources for technology objects (except cam disks)	1 600
• Required Motion Control resources	
- per speed-controlled axis	80
- per positioning axis	160
- per synchronous axis	160
- per external encoder	80
- per output cam	20
- per cam track	160
- per probe	40
Controller	
• PID_Compact	Yes; Universal PID controller with integrated optimization
• PID_3Step	Yes; PID controller with integrated optimization for valves
• PID-Temp	Yes; PID controller with integrated optimization for temperature
Counting and measuring	
• High-speed counter	Yes

Distributed Controllers

based on ET 200SP

Fail-safe CPUs

CPU 1510SP F-1 PN

Technical specifications (continued)

Article number	6ES7510-1SJ01-0AB0 CPU 1510SP F-1 PN, 150KB PROG./750KB DATA
Highest safety class achievable in safety mode	
Probability of failure (for service life of 20 years and repair time of 100 hours)	
- Low demand mode: PFDavg in accordance with SIL3	< 2.00E-05
- High demand/continuous mode: PFH in accordance with SIL3	< 1.00E-09 1/h
Ambient conditions	
Ambient temperature during operation	
• horizontal installation, min.	0 °C
• horizontal installation, max.	60 °C
• vertical installation, min.	0 °C
• vertical installation, max.	50 °C
Configuration	
Programming language	
- LAD	Yes; incl. failsafe
- FBD	Yes; incl. failsafe
- STL	Yes
- SCL	Yes
- GRAPH	Yes

Article number	6ES7510-1SJ01-0AB0 CPU 1510SP F-1 PN, 150KB PROG./750KB DATA
Know-how protection	
• User program protection/password protection	Yes
• Copy protection	Yes
• Block protection	Yes
Access protection	
• Protection level: Write protection	Yes
• Protection level: Read/write protection	Yes
• Protection level: Complete protection	Yes
Dimensions	
Width	100 mm
Height	117 mm
Depth	75 mm
Weights	
Weight, approx.	310 g

Ordering data

Ordering data	Article No.
CPU 1510SP F-1 PN Work memory 150 KB for program, 750 KB for data, PROFINET IO IRT interface; SIMATIC Memory Card required	6ES7510-1SJ01-0AB0
Accessories	
CM DP for ET 200SP CPU PROFIBUS DP master/slave with electrical interface for connecting the ET 200SP CPUs to PROFIBUS at up to 12 Mbit/s	6ES7545-5DA00-0AB0
SIMATIC Memory Card	
4 MB	6ES7954-8LC02-0AA0
12 MB	6ES7954-8LE02-0AA0
24 MB	6ES7954-8LF02-0AA0
256 MB	6ES7954-8LL02-0AA0
2 GB	6ES7954-8LP02-0AA0
32 GB	6ES7954-8LT03-0AA0
DIN rail 35 mm	
• Length: 483 mm for 19" cabinets	6ES5710-8MA11
• Length: 530 mm for 600 mm cabinets	6ES5710-8MA21
• Length: 830 mm for 900 mm cabinets	6ES5710-8MA31
• Length: 2 m	6ES5710-8MA41
PE connection element for DIN rail 2000 mm	6ES7590-5AA00-0AA0

Article No.

BusAdapter BA 2xRJ45	6ES7193-6AR00-0AA0
BusAdapter BA 2xFC for increased vibration and EMC loads	6ES7193-6AF00-0AA0
BusAdapter BA 2xSCRJ	6ES7193-6AP00-0AA0
BusAdapter BA SCRJ/RJ45	6ES7193-6AP20-0AA0
BusAdapter BA SCRJ/FC	6ES7193-6AP40-0AA0
Reference identification label 10 sheets of 16 labels	6ES7193-6LF30-0AW0
Labeling strips	
500 labeling strips on roll, light gray, for inscription with thermal transfer roll printer	6ES7193-6LR10-0AA0
500 labeling strips on roll, yellow, for inscription with thermal transfer roll printer	6ES7193-6LR10-0AG0
1000 labeling strips DIN A4, light gray, card, for inscription with laser printer	6ES7193-6LA10-0AA0
1000 labeling strips DIN A4, yellow, card, for inscription with laser printer	6ES7193-6LA10-0AG0
IE FC RJ45 plugs RJ45 plug connector for Industrial Ethernet with a rugged metal enclosure and integrated insulation displacement contacts for connecting Industrial Ethernet FC installation cables	

Ordering data	Article No.	Article No.
IE FC RJ45 Plug 90 90° cable outlet 1 unit 10 units 50 units	6GK1901-1BB20-2AA0 6GK1901-1BB20-2AB0 6GK1901-1BB20-2AE0	STEP 7 Professional V14 SP1 Target system: SIMATIC S7-1200, S7-1500, S7-300, S7-400, WinAC Requirement: Windows 7 Professional SP1 (64-bit), Windows 7 Enterprise SP1 (64-bit), Windows 7 Ultimate SP1 (64-bit), Windows 8.1 Professional (64-bit), Windows 8.1 Enterprise (64-bit), Windows 10 Professional Version 1607, Windows 10 Enterprise Version 1607, Windows 10 Enterprise 2016 LTSB, Windows 10 Enterprise 2015 LTSB, Windows Server 2008 R2 StdE (full installation), Windows Server 2012 StdE (full installation), Windows Server 2016 Standard (full installation); Type of delivery: German, English, Chinese, Italian, French, Spanish STEP 7 Professional V14 SP1, floating license STEP 7 Professional V14 SP1, floating license, software download incl. license key ¹⁾ Email address required for delivery
IE FC RJ45 Plug 180 180° cable outlet 1 unit 10 units 50 units	6GK1901-1BB10-2AA0 6GK1901-1BB10-2AB0 6GK1901-1BB10-2AE0	
IE FC TP Standard Cable GP 2x2 4-wire, shielded TP installation cable for connection to IE FC outlet RJ45/ IE FC RJ45 plug; PROFINET-compatible; with UL approval; sold by the meter; max. delivery unit 1000 m, minimum order quantity 20 m	6XV1840-2AH10	
IE FC TP Trailing Cable 2 x 2 (Type C) 4-wire, shielded TP installation cable for connection to IE FC outlet RJ45/ IE FC RJ45 Plug 180/90 for use as trailing cable; PROFINET-compatible; with UL approval; sold by the meter; max. delivery unit 1000 m, minimum order quantity 20 m	6XV1840-3AH10	
IE FC TP Marine Cable 2 x 2 (Type B) 4-wire, shielded TP installation cable for connection to IE FC outlet RJ45/ IE FC RJ45 Plug 180/90 with marine approval, sold by the meter; max. delivery unit 1000 m, minimum order quantity 20 m	6XV1840-4AH10	
IE FC Stripping Tool Preadjusted stripping tool for fast stripping of Industrial Ethernet FC cables	6GK1901-1GA00	
Manuals for ET 200SP distributed I/O system ET 200SP library: ET 200SP Manual Collection, comprising system manual, product information, and device manuals Manuals can be downloaded from the Internet as PDF files: http://www.siemens.com/simatic- docu		
SIMATIC Manual Collection Electronic manuals on DVD, multi-language: LOGO!, SIMADYN, SIMATIC bus components, SIMATIC C7, SIMATIC distributed I/O, SIMATIC HMI, SIMATIC Sensors, SIMATIC NET, SIMATIC PC Based Automation, SIMATIC PCS 7, SIMATIC PG/PC, SIMATIC S7, SIMATIC Software, SIMATIC TDCATIC TDC	6ES7998-8XC01-8YE0	
SIMATIC Manual Collection update service for 1 year Current "Manual Collection" DVD and the three subsequent updates	6ES7998-8XC01-8YE2	
		Spare parts
		Power supply connector Spare part; for connecting the 24 V DC supply voltage • With push-in terminals; 10 units
		Cover for bus adapter interface 5 units
		Server module

¹⁾ For up-to-date information and download availability, see:
<http://www.siemens.com/tia-online-software-delivery>

Distributed Controllers

based on ET 200SP

Fail-safe CPUs

CPU 1512SP F-1 PN

Overview



- CPU 1512SP F-1 PN for SIMATIC ET 200SP based on S7-1500 CPU 1513F-1 PN
- For applications with medium requirements in terms of program scope and processing speed, for distributed configurations via PROFINET IO or PROFIBUS DP.
- Increase in availability of systems and machines
- Supports PROFI-safe in centralized and distributed configurations
- PROFINET IO controller for up to 128 IO devices
- PROFINET I-Device for connecting the CPU as an intelligent PROFINET device with a SIMATIC or third-party PROFINET IO controller
- PROFINET Shared I-Device for 4 controllers
- PROFINET IO IRT interface with integrated 3-port switch
- Isochronous mode on PROFINET
- With multiple communication options: PG/OP communication, PROFINET IO, open IE communication (TCP, ISO-on-TCP and UDP), web server and S7 communication (with loadable FBs)
- Optional PROFIBUS master for 125 PROFIBUS DP slaves (with CM DP module 6ES7545-5DA00-0AB0)
- Configuration control (option handling)
- Integrated motion control functionalities for controlling speed-controlled and positioning axes, support for external encoders

Note

SIMATIC Memory Card required for operation of the CPU.

The BusAdapter is not included in the scope of supply and must be ordered separately.

Technical specifications

Article number	6ES7512-1SK01-0AB0 CPU 1512SP F-1 PN, 300KB PROG./1MB DATA
General information	
Product type designation	CPU 1512SP-1 PN
Engineering with	
• STEP 7 TIA Portal configurable/ integrated as of version	V14
Supply voltage	
Type of supply voltage	24 V DC
Power loss	
Power loss, typ.	5.6 W
Memory	
Work memory	
• integrated (for program)	300 kbyte
• integrated (for data)	1 Mbyte
Load memory	
• Plug-in (SIMATIC Memory Card), max.	32 Gbyte
CPU processing times	
for bit operations, typ.	48 ns
for word operations, typ.	58 ns
for fixed point arithmetic, typ.	77 ns
for floating point arithmetic, typ.	307 ns
Counters, timers and their retentivity	
S7 counter	
• Number	2 048
IEC counter	
• Number	Any (only limited by the main memory)
S7 times	
• Number	2 048
IEC timer	
• Number	Any (only limited by the main memory)
Data areas and their retentivity	
Flag	
• Number, max.	16 kbyte
Address area	
I/O address area	
• Inputs	32 kbyte; All inputs are in the process image
• Outputs	32 kbyte; All outputs are in the process image
Address space per module	
• Address space per module, max.	288 byte; For input and output data respectively
Address space per station	
• Address space per station, max.	2 560 byte; for central inputs and outputs; depending on configuration; 2 048 bytes for ET 200SP modules + 512 bytes for ET 200AL modules
Time of day	
Clock	
• Type	Hardware clock

Technical specifications (continued)

Article number	6ES7512-1SK01-0AB0 CPU 1512SP F-1 PN, 300KB PROG./1MB DATA
1. Interface	
Interface types	
• Number of ports	3; 1. integr. + 2. via BusAdapter
• integrated switch	Yes
• RJ 45 (Ethernet)	Yes; X1 P3; opt. X1 P1 and X1 P2 via BusAdapter BA 2x RJ45
• BusAdapter (PROFINET)	Yes; Applicable BusAdapter: BA 2x RJ45, BA 2x FC, BA 2x SCRJ, BA SCRJ / RJ45, BA SCRJ / FC
Functionality	
• PROFINET IO Controller	Yes
• PROFINET IO Device	Yes
• SIMATIC communication	Yes
• Open IE communication	Yes
• Web server	Yes
• Media redundancy	Yes
PROFINET IO Controller	
Services	
- PG/OP communication	Yes
- S7 routing	Yes
- Isochronous mode	Yes
- Open IE communication	Yes
- IRT	Yes
- MRP	Yes; As MRP redundancy manager and/or MRP client; max. number of devices in the ring: 50
- MRPD	Requirement: IRT
- PROFIenergy	Yes
- Prioritized startup	Yes; Max. 32 PROFINET devices
- Number of connectable IO Devices, max.	128; In total, up to 512 distributed I/O devices can be connected via AS-i, PROFIBUS or PROFINET
- Of which IO devices with IRT, max.	64
- Number of connectable IO Devices for RT, max.	128
- of which in line, max.	128
- Number of IO Devices that can be simultaneously activated/ deactivated, max.	8; in total across all interfaces
- Number of IO Devices per tool, max.	8
- Updating times	The minimum value of the update time also depends on communi- cation share set for PROFINET IO, on the number of IO devices, and on the quantity of configured user data
Update time for IRT	
- for send cycle of 250 µs	250 µs to 4 ms; Note: In the case of IRT with isochronous mode, the minimum update time of 500 µs of the isochronous OB is decisive
- for send cycle of 500 µs	500 µs to 8 ms
- for send cycle of 1 ms	1 ms to 16 ms
- for send cycle of 2 ms	2 ms to 32 ms
- for send cycle of 4 ms	4 ms to 64 ms
- With IRT and parameterization of "odd" send cycles	Update time = set "odd" send clock (any multiple of 125 µs: 375 µs, 625 µs ... 3 875 µs)
Update time for RT	
- for send cycle of 250 µs	250 µs to 128 ms
- for send cycle of 500 µs	500 µs to 256 ms
- for send cycle of 1 ms	1 ms to 512 ms
- for send cycle of 2 ms	2 ms to 512 ms
- for send cycle of 4 ms	4 ms to 512 ms

Article number	6ES7512-1SK01-0AB0 CPU 1512SP F-1 PN, 300KB PROG./1MB DATA
PROFINET IO Device	
Services	
- PG/OP communication	Yes
- S7 routing	Yes
- Isochronous mode	No
- Open IE communication	Yes
- IRT	Yes
- MRP	Yes
- MRPD	Yes; Requirement: IRT
- PROFIenergy	Yes
- Shared device	Yes
- Number of IO Controllers with shared device, max.	4
2. Interface	
Interface types	
• Number of ports	1
• RS 485	Yes; Via CM DP module
Functionality	
• PROFIBUS DP master	Yes
• PROFIBUS DP slave	Yes
• SIMATIC communication	Yes
Protocols	
Number of connections	
• Number of connections, max.	128
PROFIBUS DP master	
Services	
- Number of DP slaves	125; In total, up to 512 distributed I/O devices can be connected via AS-i, PROFIBUS or PROFINET
Isochronous mode	
Isochronous operation (application synchronized up to terminal)	Yes; Only with PROFINET; with minimum OB 6x cycle of 625 µs
Supported technology objects	
Motion Control	Yes; Note: The number of technology objects affects the cycle time of the PLC program; selection guide via the TIA Selection Tool or SIZER
• Number of available Motion Control resources for technology objects (except cam disks)	1 600
• Required Motion Control resources	
- per speed-controlled axis	80
- per positioning axis	160
- per synchronous axis	160
- per external encoder	80
- per output cam	20
- per cam track	160
- per probe	40
Controller	
• PID_Compact	Yes; Universal PID controller with integrated optimization
• PID_3Step	Yes; PID controller with integrated optimization for valves
• PID-Temp	Yes; PID controller with integrated optimization for temperature
Counting and measuring	
• High-speed counter	Yes

Distributed Controllers

based on ET 200SP

Fail-safe CPUs

CPU 1512SP F-1 PN

Technical specifications (continued)

Article number	6ES7512-1SK01-0AB0 CPU 1512SP F-1 PN, 300KB PROG./1MB DATA
Highest safety class achievable in safety mode	
Probability of failure (for service life of 20 years and repair time of 100 hours)	
- Low demand mode: PFDAvg in accordance with SIL3	< 2.00E-05
- High demand/continuous mode: PFH in accordance with SIL3	< 1.00E-09
Ambient conditions	
Ambient temperature during operation	
• horizontal installation, min.	0 °C
• horizontal installation, max.	60 °C
• vertical installation, min.	0 °C
• vertical installation, max.	50 °C
Configuration	
Programming	
Programming language	
- LAD	Yes; incl. failsafe
- FBD	Yes; incl. failsafe
- STL	Yes
- SCL	Yes
- GRAPH	Yes

Article number	6ES7512-1SK01-0AB0 CPU 1512SP F-1 PN, 300KB PROG./1MB DATA
Know-how protection	
• User program protection/password protection	Yes
• Copy protection	Yes
• Block protection	Yes
Access protection	
• Protection level: Write protection	Yes
• Protection level: Read/write protection	Yes
• Protection level: Complete protection	Yes
Dimensions	
Width	100 mm
Height	117 mm
Depth	75 mm
Weights	
Weight, approx.	310 g

Ordering data

Ordering data	Article No.
CPU 1512SP F-1 PN Work memory 300 KB for program, 1 MB for data, PROFINET IO IRT interface, SIMATIC Memory Card required	6ES7512-1SK01-0AB0
Accessories	
CM DP for ET 200SP CPU PROFIBUS DP master/slave with electrical interface for connecting the ET 200SP CPUs to PROFIBUS at up to 12 Mbit/s	6ES7545-5DA00-0AB0
SIMATIC Memory Card	
4 MB	6ES7954-8LC02-0AA0
12 MB	6ES7954-8LE02-0AA0
24 MB	6ES7954-8LF02-0AA0
256 MB	6ES7954-8LL02-0AA0
2 GB	6ES7954-8LP02-0AA0
32 GB	6ES7954-8LT03-0AA0
DIN rail 35 mm	
• Length: 483 mm for 19" cabinets	6ES5710-8MA11
• Length: 530 mm for 600 mm cabinets	6ES5710-8MA21
• Length: 830 mm for 900 mm cabinets	6ES5710-8MA31
• Length: 2 m	6ES5710-8MA41
PE connection element for DIN rail 2000 mm	6ES7590-5AA00-0AA0

Article No.

BusAdapter BA 2xRJ45	6ES7193-6AR00-0AA0
BusAdapter BA 2xFC for increased vibration and EMC loads	6ES7193-6AF00-0AA0
BusAdapter BA 2xSCRJ	6ES7193-6AP00-0AA0
BusAdapter BA SCRJ/RJ45	6ES7193-6AP20-0AA0
BusAdapter BA SCRJ/FC	6ES7193-6AP40-0AA0
Reference identification label 10 sheets of 16 labels	6ES7193-6LF30-0AW0
Labeling strips	
500 labeling strips on roll, light gray, for inscription with thermal transfer roll printer	6ES7193-6LR10-0AA0
500 labeling strips on roll, yellow, for inscription with thermal transfer roll printer	6ES7193-6LR10-0AG0
1000 labeling strips DIN A4, light gray, card, for inscription with laser printer	6ES7193-6LA10-0AA0
1000 labeling strips DIN A4, yellow, card, for inscription with laser printer	6ES7193-6LA10-0AG0

Ordering data	Article No.	Ordering data	Article No.
IE FC RJ45 plugs RJ45 plug connector for Industrial Ethernet with a rugged metal enclosure and integrated insulation displacement contacts for connecting Industrial Ethernet FC installation cables		SIMATIC Manual Collection update service for 1 year Current "Manual Collection" DVD and the three subsequent updates	6ES7998-8XC01-8YE2
IE FC RJ45 Plug 90 90° cable outlet 1 unit 10 units 50 units	6GK1901-1BB20-2AA0 6GK1901-1BB20-2AB0 6GK1901-1BB20-2AE0	STEP 7 Professional V14 SP1 Target system: SIMATIC S7-1200, S7-1500, S7-300, S7-400, WinAC Requirement: Windows 7 Professional SP1 (64-bit), Windows 7 Enterprise SP1 (64-bit), Windows 7 Ultimate SP1 (64-bit), Windows 8.1 Professional (64-bit), Windows 8.1 Enterprise (64-bit), Windows 10 Professional Version 1607, Windows 10 Enterprise Version 1607, Windows 10 Enterprise 2016 LTSC, Windows 10 Enterprise 2015 LTSC, Windows Server 2008 R2 StdE (full installation), Windows Server 2012 StdE (full installation), Windows Server 2016 Standard (full installation); Type of delivery: German, English, Chinese, Italian, French, Spanish	
IE FC RJ45 Plug 180 180° cable outlet 1 unit 10 units 50 units	6GK1901-1BB10-2AA0 6GK1901-1BB10-2AB0 6GK1901-1BB10-2AE0	STEP 7 Professional V14 SP1, floating license	6ES7822-1AA04-0YA5
IE FC TP Standard Cable GP 2x2 4-wire, shielded TP installation cable for connection to IE FC outlet RJ45/ IE FC RJ45 plug; PROFINET-compatible; with UL approval; sold by the meter; max. delivery unit 1000 m, minimum order quantity 20 m	6XV1840-2AH10	STEP 7 Professional V14 SP1, floating license, software download incl. license key ¹⁾ Email address required for delivery	6ES7822-1AE04-0YA5
IE FC TP Trailing Cable 2 x 2 (Type C) 4-wire, shielded TP installation cable for connection to IE FC outlet RJ45/ IE FC RJ45 Plug 180/90 for use as trailing cable; PROFINET-compatible; with UL approval; sold by the meter; max. delivery unit 1000 m, minimum order quantity 20 m	6XV1840-3AH10	STEP 7 Safety Advanced V14 SP1 Task: Engineering tool for configuring and programming fail-safe user programs for SIMATIC S7-1200 FC, S7-1500F, S7-1500F Software Controller, S7-300F, S7-400F, WinAC RTX F, ET 200SP F Controller and the fail-safe ET 200SP, ET 200S, ET 200M, ET 200iSP, ET 200pro and ET 200eco I/O Requirement: STEP 7 Professional V14 SP1	
IE FC TP Marine Cable 2 x 2 (Type B) 4-wire, shielded TP installation cable for connection to IE FC outlet RJ45/ IE FC RJ45 Plug 180/90 with marine approval, sold by the meter; max. delivery unit 1000 m, minimum order quantity 20 m	6XV1840-4AH10	Floating license for 1 user, software and documentation on DVD, license key on USB flash drive	6ES7833-1FA14-0YA5
IE FC Stripping Tool Preadjusted stripping tool for fast stripping of Industrial Ethernet FC cables	6GK1901-1GA00	Floating license for 1 user, software, documentation and license key for download ¹⁾ ; Email address required for delivery	6ES7833-1FA14-0YH5
Manuals for ET 200SP distributed I/O system ET 200SP library: ET 200SP Manual Collection, comprising system manual, product information, and device manuals Manuals can be downloaded from the Internet as PDF files: http://www.siemens.com/simatic-docu		Spare parts	
SIMATIC Manual Collection Electronic manuals on DVD, multi-language: LOGO!, SIMADYN, SIMATIC bus components, SIMATIC C7, SIMATIC distributed I/O, SIMATIC HMI, SIMATIC Sensors, SIMATIC NET, SIMATIC PC Based Automation, SIMATIC PCS 7, SIMATIC PG/PC, SIMATIC S7, SIMATIC Software, SIMATIC TDCATIC TDC	6ES7998-8XC01-8YE0	Power supply connector Spare part; for connecting the 24 V DC supply voltage • With push-in terminals; 10 units	6ES7193-4JB00-0AA0
		Cover for bus adapter interface 5 units	6ES7591-3AA00-0AA0
		Server module	6ES7193-6PA00-0AA0

¹⁾ For up-to-date information and download availability, see:
<http://www.siemens.com/tia-online-software-delivery>

Distributed Controllers

based on ET 200SP
SIPLUS fail-safe CPUs

SIPLUS CPU 1510SP F-1 PN

Overview



- SIPLUS CPU 1510SP F-1 PN for SIPLUS ET 200SP based on S7-1500 CPU 1511F-1 PN
- For high-performance control solutions using ET 200SP
- Increase in availability of systems and machines
- Supports PROFINET in centralized and distributed configurations
- PROFINET IO controller for up to 64 IO devices
- PROFINET I-Device for connecting the CPU as an intelligent PROFINET device with a SIMATIC or third-party PROFINET IO controller
- PROFINET Shared I-Device for 4 controllers
- PROFINET IO IRT interface with integrated 3-port switch
- Isochronous mode on PROFINET
- With multiple communication options: PG/OP communication, PROFINET IO, open IE communication (TCP, ISO-on-TCP and UDP), web server and S7 communication (with loadable FBs)
- Optional PROFIBUS master for 125 PROFIBUS DP slaves (with CM DP module 6ES7545-5DA00-0AB0)
- Configuration control (option handling)
- Integrated motion control functionalities for controlling speed-controlled and positioning axes, support for external encoders

Note

SIMATIC Memory Card required for operation of the CPU.

The BusAdapter is not included in the scope of supply and must be ordered separately.

SIPLUS extreme products are based on SIMATIC standard products. The contents listed here were taken from the corresponding standard products. SIPLUS extreme-specific information was added.

Technical specifications

Article number	6AG1510-1SJ01-2AB0
Based on	6ES7510-1SJ01-0AB0 SIPLUS ET 200SP CPU 1510SP F-1PN
Ambient conditions	
Ambient temperature during operation	
• horizontal installation, min.	-25 °C; = Tmin
• horizontal installation, max.	60 °C; = Tmax
• vertical installation, min.	-25 °C; = Tmin
• vertical installation, max.	50 °C; = Tmax
Extended ambient conditions	
• relative to ambient temperature-atmospheric pressure-installation altitude	Tmin ... Tmax at 1080 hPa ... 795 hPa (-1000 m ... +2000 m)
Relative humidity	
- With condensation, tested in accordance with IEC 60068-2-38, max.	100 %; RH incl. condensation / frost (no commissioning in bedewed state), horizontal installation
Resistance	
- against biologically active substances / conformity with EN 60721-3-3	Yes; Class 3B2 mold, fungus and dry rot spores (with the exception of fauna). The supplied connector covers must remain on the unused interfaces during operation!
- against chemically active substances / conformity with EN 60721-3-3	Yes; Class 3C4 (RH < 75%) incl. salt spray according to EN 60068-2-52 (degree of severity 3). The supplied connector covers must remain on the unused interfaces during operation!
- against mechanically active substances / conformity with EN 60721-3-3	Yes; Class 3S4 incl. sand, dust. The supplied connector covers must remain on the unused interfaces during operation!

Ordering data

Ordering data	Article No.
SIPLUS CPU 1510SP F-1 PN (Extended temperature range and environmental stress) Work memory 150 KB for program, 750 KB for data, PROFINET IO IRT interface; SIMATIC Memory Card required	6AG1510-1SJ01-2AB0
Accessories	
SIPLUS BusAdapter BA 2xRJ45	6AG1193-6AR00-7AA0
IE FC RJ45 plugs RJ45 plug connector for Industrial Ethernet with a rugged metal enclosure and integrated insulation displacement contacts for connecting Industrial Ethernet FC installation cables	
IE FC RJ45 Plug 180 (Extended temperature range and environmental stress) 180° cable outlet 1 unit	6AG1901-1BB10-7AA0
Other accessories	See SIMATIC ET 200SP, CPU 1510 F-1 PN, page 7/16

Overview



- SIPLUS CPU 1512SP F-1 PN for SIPLUS ET 200SP based on S7-1500 CPU 1513F-1 PN
- For applications with medium requirements in terms of program scope and processing speed, for distributed configurations via PROFINET IO or PROFIBUS DP.
- Increase in availability of systems and machines
- Supports PROFI-safe in centralized and distributed configurations
- PROFINET IO controller for up to 128 IO devices
- PROFINET I-Device for connecting the CPU as an intelligent PROFINET device with a SIMATIC or third-party PROFINET IO controller
- PROFINET Shared I-Device for 4 controllers
- PROFINET IO IRT interface with integrated 3-port switch
- Isochronous mode on PROFINET
- With multiple communication options: PG/OP communication, PROFINET IO, open IE communication (TCP, ISO-on-TCP and UDP), web server and S7 communication (with loadable FBs)
- Optional PROFIBUS master for 125 PROFIBUS DP slaves (with CM DP module 6ES7545-5DA00-0AB0)
- Configuration control (option handling)
- Integrated motion control functionalities for controlling speed-controlled and positioning axes, support for external encoders

Note

SIMATIC Memory Card required for operation of the CPU.

The BusAdapter is not included in the scope of supply and must be ordered separately.

SIPLUS extreme products are based on SIMATIC standard products. The contents listed here were taken from the corresponding standard products. SIPLUS extreme-specific information was added.

Technical specifications

Article number	6AG1512-1SK01-2AB0
Based on	6ES7512-1SK01-0AB0 SIPLUS ET 200SP CPU 1512SP F-1PN
Ambient conditions	
Ambient temperature during operation	
• horizontal installation, min.	-25 °C; = Tmin
• horizontal installation, max.	60 °C; = Tmax
• vertical installation, min.	-25 °C; = Tmin
• vertical installation, max.	50 °C; = Tmax
Extended ambient conditions	
• relative to ambient temperature-atmospheric pressure-installation altitude	Tmin ... Tmax at 1080 hPa ... 795 hPa (-1000 m ... +2000 m)
Relative humidity	
- With condensation, tested in accordance with IEC 60068-2-38, max.	100 %; RH incl. condensation / frost (no commissioning in bedewed state), horizontal installation
Resistance	
- against biologically active substances / conformity with EN 60721-3-3	Yes; Class 3B2 mold, fungus and dry rot spores (with the exception of fauna). The supplied connector covers must remain on the unused interfaces during operation!
- against chemically active substances / conformity with EN 60721-3-3	Yes; Class 3C4 (RH < 75%) incl. salt spray according to EN 60068-2-52 (degree of severity 3). The supplied connector covers must remain on the unused interfaces during operation!
- against mechanically active substances / conformity with EN 60721-3-3	Yes; Class 3S4 incl. sand, dust. The supplied connector covers must remain on the unused interfaces during operation!

Ordering data

Ordering data	Article No.
SIPLUS CPU 1512SP F-1 PN (Extended temperature range and environmental stress) Work memory 300 KB for program, 1 MB for data, PROFINET IO IRT interface, SIMATIC Memory Card required	6AG1512-1SK01-2AB0
Accessories	
SIPLUS BusAdapter BA 2xRJ45	6AG1193-6AR00-7AA0
IE FC RJ45 plugs RJ45 plug connector for Industrial Ethernet with a rugged metal enclosure and integrated insulation displacement contacts for connecting Industrial Ethernet FC installation cables	
IE FC RJ45 Plug 180 (Extended temperature range and environmental stress) 180° cable outlet 1 unit	6AG1901-1BB10-7AA0
Other accessories	See SIMATIC ET 200SP, CPU 1512 F-1 PN, page 7/20

Distributed Controllers

based on ET 200SP

ET 200SP Open Controllers standard and fail-safe

CPU 1515SP PC (F)

Overview



- Turnkey, all-in-one solution with pre-installed SIMATIC S7-1500 Software Controller or fail-safe, optionally pre-installed WinCC Runtime Advanced
- Fail-safe versions make it possible to control machines or plants in a fail-safe environment. This makes it possible to address applications which require an SIL3 (Safety Integrity Level) safety class according to IEC 61508 2nd Edition or a PL e (Performance Level) according to ISO 13849.
- Central expansion via ET 200SP modules (station width up to 1 m or up to 64 modules)
- SIMATIC Hypervisor: for separating Windows systems from control functions

- Dual-core processor for optimal use of the hypervisor
- Swappable flash memory (CFast card) for operating system, runtime and project data
- Integrated DVI-I graphics connection; 3x USB 2.0 connection
- 2 PROFINET interfaces: X1 via PN-IO bus adapter (RJ45 or FC) with 2 ports; X2: GB-Ethernet interface (RJ45)
- PROFINET IRT
- Open Ethernet communication (TCP/IP, UDP, Iso-on-TCP)
- Web server functionality for information, status, diagnostics and user-defined webpages
- PROFIBUS DP communication optionally via CM DP module as DP master
- Configuration control (option handling)
- Improved know-how and copy protection; Security Integrated
- Integrated system diagnostics
- Integrated motion control functionalities for controlling speed-controlled and positioning axes with support for external encoders.
- Trace function
- Especially suitable for high data volumes and user-specific, open applications
- Integration of control functions and applications implemented in C/C++ (using SIMATIC ODK-1500S Open Development Kit)

Technical specifications

Article number	6ES7677-2AA31-0EB0 CPU 1515SP PC 4GB	6ES7677-2AA41-0FB0 CPU 1515SP PC 4GB
General information		
Product type designation	CPU 1515SP PC	CPU 1515SP PC
Engineering with		
• STEP 7 TIA Portal configurable/ integrated as of version	V14	V14
PC configuration		
Processor	Dual-Core 1 GHz, AMD G Series APU T40E	Dual-Core 1 GHz, AMD G Series APU T40E
Main memory	4 GB RAM	4 GB RAM
Flash Disk	8 GB	16 GB
Operating systems	Windows Embedded Standard 7 E 32-bit	Windows Embedded Standard 7 P 64-bit
Installed software		
• Visualization	No	No
• Control	S7-1500 software controller CPU 1505SP V2.0	S7-1500 software controller CPU 1505SP V2.0
Supply voltage		
Type of supply voltage	24 V DC	24 V DC
Power loss		
Power loss, typ.	15 W; without ET 200SP modules and without using USB	15 W; without ET 200SP modules and without using USB
Memory		
Type of memory	DDR3-SDRAM	DDR3-SDRAM
CFast memory card	Yes; 8 GB flash memory	Yes; 16 GB flash memory
Work memory		
• integrated (for program)	1 Mbyte	1 Mbyte
• integrated (for data)	5 Mbyte	5 Mbyte
• Integrated (for ODK application)	10 Mbyte	10 Mbyte
Load memory		
• integrated (on PC mass storage)	320 Mbyte	320 Mbyte

Technical specifications (continued)

Article number	6ES7677-2AA31-0EB0 CPU 1515SP PC 4GB	6ES7677-2AA41-0FB0 CPU 1515SP PC 4GB
CPU processing times		
for bit operations, typ.	10 ns	10 ns
for word operations, typ.	12 ns	12 ns
for fixed point arithmetic, typ.	16 ns	16 ns
for floating point arithmetic, typ.	64 ns	64 ns
CPU-blocks		
Number of elements (total)	6 000; In addition to blocks such as DBs, FBs and FCs, UDTs, global constants, etc. are also regarded as elements	6 000; In addition to blocks such as DBs, FBs and FCs, UDTs, global constants, etc. are also regarded as elements
DB		
• Number, max.	5 999; Number range: 1 to 65535	5 999; Number range: 1 to 65535
• Size, max.	5 Mbyte	5 Mbyte
FB		
• Number, max.	5 998; Number range: 1 to 65535	5 998; Number range: 1 to 65535
• Size, max.	512 kbyte	512 kbyte
FC		
• Number, max.	5 999; Number range: 1 to 65535	5 999; Number range: 1 to 65535
• Size, max.	512 kbyte	512 kbyte
OB		
• Size, max.	1 048 kbyte	1 048 kbyte
Nesting depth		
• per priority class	24	24
Counters, timers and their retentivity		
S7 counter		
• Number	2 048	2 048
IEC counter		
• Number	Any (only limited by the main memory)	Any (only limited by the main memory)
S7 times		
• Number	2 048	2 048
IEC timer		
• Number	Any (only limited by the main memory)	Any (only limited by the main memory)
Data areas and their retentivity		
Flag		
• Number, max.	16 kbyte	16 kbyte
Address area		
I/O address area		
• Inputs	32 kbyte; All inputs are in the process image	32 kbyte; All inputs are in the process image
• Outputs	32 kbyte; All outputs are in the process image	32 kbyte; All outputs are in the process image
Hardware configuration		
Integrated power supply	Yes	Yes
Time of day		
Clock		
• Type	Hardware clock	Hardware clock
• Hardware clock (real-time)	Yes; Resolution: 1 s	Yes; Resolution: 1 s
Interfaces		
Number of industrial Ethernet interfaces	2	2
Number of PROFINET interfaces	1	1
Number of PROFIBUS interfaces	1	1
Number of RS 485 interfaces	1; Via CM DP module	1; Via CM DP module
Number of USB interfaces	3; 3x USB 2.0 on the front, 500 mA each – of which 2x 500 mA and 1x 100 mA simultaneously	3; 3x USB 2.0 on the front, 500 mA each – of which 2x 500 mA and 1x 100 mA simultaneously
Number of SD card slots	1	1
Video interfaces		
• Graphics interface	1x DVI-I	1x DVI-I
1. Interface		
Interface type	PROFINET	PROFINET
automatic detection of transmission rate	Yes	Yes
Autonegotiation	Yes	Yes
Autocrossing	Yes	Yes

Distributed Controllers

based on ET 200SP

ET 200SP Open Controllers standard and fail-safe

CPU 1515SP PC (F)

Technical specifications (continued)

Article number	6ES7677-2AA31-0EB0 CPU 1515SP PC 4GB	6ES7677-2AA41-0FB0 CPU 1515SP PC 4GB
Interface types		
• Number of ports	2	2
• integrated switch	Yes	Yes
• RJ 45 (Ethernet)	Yes; Via BusAdapter BA 2x RJ45	Yes; Via BusAdapter BA 2x RJ45
- Transmission rate, max.	100 Mbit/s	100 Mbit/s
- Industrial Ethernet status LED	Yes	Yes
• BusAdapter (PROFINET)	Yes; Applicable BusAdapter: BA 2x RJ45, BA 2x FC	Yes; Applicable BusAdapter: BA 2x RJ45, BA 2x FC
Functionality		
• Number of connections via this interface	88	88
• PROFINET IO Controller	Yes	Yes
• PROFINET IO Device	Yes	Yes
• SIMATIC communication	Yes	Yes
• Open IE communication	Yes	Yes
• Web server	Yes	Yes
PROFINET IO Controller		
Services		
- Isochronous mode	Yes	Yes
- shortest clock pulse	500 µs	500 µs
- IRT	Yes	Yes
- MRP	Yes	Yes
- MRPD	Yes	Yes
- Prioritized startup	Yes; Max. 32 PROFINET devices	Yes; Max. 32 PROFINET devices
- Number of connectable IO Devices, max.	128	128
- Of which IO devices with IRT, max.	64	64
- of which in line, max.	64	64
- Number of connectable IO Devices for RT, max.	128	128
- of which in line, max.	128	128
- Number of IO Devices that can be simultaneously activated/deactivated, max.	8	8
- IO Devices changing during operation (partner ports), supported	Yes	Yes
- Number of IO Devices per tool, max.	8	8
- Updating times	The minimum value of the update time also depends on communication share set for PROFINET IO, on the number of IO devices, and on the quantity of configured user data	The minimum value of the update time also depends on communication share set for PROFINET IO, on the number of IO devices, and on the quantity of configured user data
Update time for IRT		
- for send cycle of 500 µs	500 µs to 8 ms	500 µs to 8 ms
- for send cycle of 1 ms	1 ms to 16 ms	1 ms to 16 ms
- for send cycle of 2 ms	2 ms to 32 ms	2 ms to 32 ms
- for send cycle of 4 ms	4 ms to 64 ms	4 ms to 64 ms
- With IRT and parameterization of "odd" send cycles	Update time = set "odd" send clock (any multiple of 125 µs: 375 µs, 625 µs ... 3 875 µs)	Update time = set "odd" send clock (any multiple of 125 µs: 375 µs, 625 µs ... 3 875 µs)
Update time for RT		
- for send cycle of 500 µs	500 µs to 256 ms	500 µs to 256 ms
- for send cycle of 1 ms	1 ms to 512 ms	1 ms to 512 ms
- for send cycle of 2 ms	2 ms to 512 ms	2 ms to 512 ms
- for send cycle of 4 ms	4 ms to 512 ms	4 ms to 512 ms
PROFINET IO Device		
Services		
- Isochronous mode	No	No
- IRT	Yes	Yes
- MRP	Yes	Yes
- MRPD	Yes	Yes
- Prioritized startup	Yes	Yes
- Shared device	Yes	Yes
- Number of IO Controllers with shared device, max.	4	4

Technical specifications (continued)

Article number	6ES7677-2AA31-0EB0 CPU 1515SP PC 4GB	6ES7677-2AA41-0FB0 CPU 1515SP PC 4GB
2. Interface		
Interface type	Integrated Ethernet interface	Integrated Ethernet interface
automatic detection of transmission rate	Yes	Yes
Autonegotiation	Yes	Yes
Autocrossing	Yes	Yes
Interface types		
• Number of ports	1	1
• RJ 45 (Ethernet)	Yes; Integrated	Yes; Integrated
- Transmission rate, max.	1 000 Mbit/s	1 000 Mbit/s
- Industrial Ethernet status LED	No	No
3. Interface		
Interface type	PROFIBUS with CM DP	PROFIBUS with CM DP
Interface types		
• RS 485	Yes	Yes
Functionality		
• Number of connections via this interface	44	44
• PROFIBUS DP master	Yes	Yes
• PROFIBUS DP slave	Yes	Yes
• SIMATIC communication	Yes	Yes
DP master		
Services		
- Equidistance	No	No
- Isochronous mode	No	No
- Number of connectable DP slaves, max.	125	125
DP slave		
Services		
- Equidistance	No	No
- Isochronous mode	No	No
Protocols		
Number of connections		
• Number of connections, max.	88	88
Supported technology objects		
Motion Control	Yes	Yes
• Number of available Motion Control resources for technology objects (except cam disks)	2 400	
• Required Motion Control resources		
- per speed-controlled axis	40; per axis	40; per axis
- per positioning axis	80; per axis	80; per axis
- per synchronous axis	160; per axis	160; per axis
- per external encoder	80; per external encoder	80; per external encoder
- per output cam	20; per cam	20; per cam
- per cam track	160; per cam track	160; per cam track
- per probe	40; per probe	40; per probe
Controller		
• PID_Compact	Yes; Universal PID controller with integrated optimization	Yes; Universal PID controller with integrated optimization
• PID_3Step	Yes; PID controller with integrated optimization for valves	Yes; PID controller with integrated optimization for valves
• PID-Temp	Yes; PID controller with integrated optimization for temperature	Yes; PID controller with integrated optimization for temperature
Counting and measuring		
• High-speed counter	Yes	Yes

Distributed Controllers

based on ET 200SP

ET 200SP Open Controllers standard and fail-safe

CPU 1515SP PC (F)

Technical specifications (continued)

Article number	6ES7677-2AA31-0EB0 CPU 1515SP PC 4GB	6ES7677-2AA41-0FB0 CPU 1515SP PC 4GB
Ambient conditions		
Ambient temperature during operation		
• min.	0 °C	0 °C
• max.	Up to 60 °C with max. 32 ET 200SP modules and 3x 100 mA USB load; up to 55 °C with max. 64 ET 200SP modules and 2x max. 500 mA and 1x max. 100 mA USB load	Up to 60 °C with max. 32 ET 200SP modules and 3x 100 mA USB load; up to 55 °C with max. 64 ET 200SP modules and 2x max. 500 mA and 1x max. 100 mA USB load
• horizontal installation, min.	0 °C	0 °C
• horizontal installation, max.	60 °C	60 °C
• vertical installation, min.	0 °C	0 °C
• vertical installation, max.	50 °C; With max. 32 ET 200SP modules and 3x 100 mA USB load	50 °C; With max. 32 ET 200SP modules and 3x 100 mA USB load
Configuration		
Programming		
Programming language		
- LAD	Yes	Yes
- FBD	Yes	Yes
- STL	Yes	Yes
- SCL	Yes	Yes
- CFC	No	No
- GRAPH	Yes	Yes
Know-how protection		
• User program protection/password protection	Yes	Yes
• Copy protection	Yes	Yes
• Block protection	Yes	Yes
Access protection		
• Protection level: Write protection	Yes	Yes
• Protection level: Read/write protection	Yes	Yes
• Protection level: Complete protection	Yes	Yes
Open Development interfaces		
• Size of ODK SO file, max.	3.8 Mbyte	3.8 Mbyte
Peripherals/Options		
Peripherals		
• SD card	Optionally for additional mass storage	Optionally for additional mass storage
Dimensions		
Width	160 mm	160 mm
Height	117 mm	117 mm
Depth	75 mm	75 mm
Weights		
Weight, approx.	0.83 kg	0.83 kg

Technical specifications (continued)

Article number	6ES7677-2FA31-0EB0 CPU 1515SP PC F	6ES7677-2FA41-0FB0 CPU 1515SP PC F
General information		
Product type designation	CPU 1515SP PC F	CPU 1515SP PC F
Engineering with		
• STEP 7 TIA Portal configurable/ integrated as of version	V14	V14
PC configuration		
Processor	Dual-Core 1 GHz, AMD G Series APU T40E	Dual-Core 1 GHz, AMD G Series APU T40E
Main memory	4 GB RAM	4 GB RAM
Flash Disk	8 GB	16 GB
Operating systems	Windows Embedded Standard 7 E 32-bit	Windows Embedded Standard 7 P 64-bit
Installed software		
• Visualization	No	No
• Control	S7-1500 Software Controller CPU 1505SP F V2.0	S7-1500 Software Controller CPU 1505SP F V2.0
Supply voltage		
Type of supply voltage	24 V DC	24 V DC
Power loss		
Power loss, typ.	15 W; without ET 200SP modules and without using USB	15 W; without ET 200SP modules and without using USB
Memory		
Type of memory	DDR3-SDRAM	DDR3-SDRAM
CFast memory card	Yes; 8 GB flash memory	Yes; 16 GB flash memory
Work memory		
• integrated (for program)	1.5 Mbyte	1.5 Mbyte
• integrated (for data)	5 Mbyte	5 Mbyte
• Integrated (for ODK application)	10 Mbyte	10 Mbyte
Load memory		
• integrated (on PC mass storage)	320 Mbyte	320 Mbyte
CPU processing times		
for bit operations, typ.	10 ns	10 ns
for word operations, typ.	12 ns	12 ns
for fixed point arithmetic, typ.	16 ns	16 ns
for floating point arithmetic, typ.	64 ns	64 ns
CPU-blocks		
Number of elements (total)	6 000; In addition to blocks such as DBs, FBs and FCs, UDTs, global constants, etc. are also regarded as elements	6 000; In addition to blocks such as DBs, FBs and FCs, UDTs, global constants, etc. are also regarded as elements
DB		
• Number, max.	5 999; Number range: 1 to 65535	5 999; Number range: 1 to 65535
• Size, max.	5 Mbyte	5 Mbyte
FB		
• Number, max.	5 998; Number range: 1 to 65535	5 998; Number range: 1 to 65535
• Size, max.	512 kbyte	512 kbyte
FC		
• Number, max.	5 999; Number range: 1 to 65535	5 999; Number range: 1 to 65535
• Size, max.	512 kbyte	512 kbyte
OB		
• Size, max.	512 kbyte	512 kbyte
Nesting depth		
• per priority class	24; Up to 8 possible for F-blocks	24; Up to 8 possible for F-blocks
Counters, timers and their retentivity		
S7 counter		
• Number	2 048	2 048
IEC counter		
• Number	Any (only limited by the main memory)	Any (only limited by the main memory)
S7 times		
• Number	2 048	2 048
IEC timer		
• Number	Any (only limited by the main memory)	Any (only limited by the main memory)

Distributed Controllers

based on ET 200SP

ET 200SP Open Controllers standard and fail-safe

CPU 1515SP PC (F)

Technical specifications (continued)

Article number	6ES7677-2FA31-0EB0 CPU 1515SP PC F	6ES7677-2FA41-0FB0 CPU 1515SP PC F
Data areas and their retentivity		
Flag		
• Number, max.	16 kbyte	16 kbyte
Address area		
I/O address area		
• Inputs	32 kbyte; All inputs are in the process image	32 kbyte; All inputs are in the process image
• Outputs	32 kbyte; All outputs are in the process image	32 kbyte; All outputs are in the process image
Hardware configuration		
Integrated power supply	Yes	Yes
Time of day		
Clock		
• Type	Hardware clock	Hardware clock
• Hardware clock (real-time)	Yes; Resolution: 1 s	Yes; Resolution: 1 s
Interfaces		
Number of industrial Ethernet interfaces	2	2
Number of PROFINET interfaces	1	1
Number of PROFIBUS interfaces	1	1
Number of RS 485 interfaces	1; Via CM DP module	1; Via CM DP module
Number of USB interfaces	3; 3x USB 2.0 on the front, 500 mA each – of which 2x 500 mA and 1x 100 mA simultaneously	3; 3x USB 2.0 on the front, 500 mA each – of which 2x 500 mA and 1x 100 mA simultaneously
Number of SD card slots	1	1
Video interfaces		
• Graphics interface	1x DVI-I	1x DVI-I
1. Interface		
Interface type	PROFINET	PROFINET
automatic detection of transmission rate	Yes	Yes
Autonegotiation	Yes	Yes
Autocrossing	Yes	Yes
Interface types		
• Number of ports	2	2
• integrated switch	Yes	Yes
• RJ 45 (Ethernet)	Yes; Via BusAdapter BA 2x RJ45	Yes; Via BusAdapter BA 2x RJ45
- Transmission rate, max.	100 Mbit/s	100 Mbit/s
- Industrial Ethernet status LED	Yes	Yes
• BusAdapter (PROFINET)	Yes; Applicable BusAdapter: BA 2x RJ45, BA 2x FC	Yes; Applicable BusAdapter: BA 2x RJ45, BA 2x FC
Functionality		
• Number of connections via this interface	88	88
• PROFINET IO Controller	Yes	Yes
• PROFINET IO Device	Yes	Yes
• SIMATIC communication	Yes	Yes
• Open IE communication	Yes	Yes
• Web server	Yes	Yes

Technical specifications (continued)

Article number	6ES7677-2FA31-0EB0 CPU 1515SP PC F	6ES7677-2FA41-0FB0 CPU 1515SP PC F
PROFINET IO Controller		
Services		
- Isochronous mode	Yes	Yes
- shortest clock pulse	500 µs	500 µs
- IRT	Yes	Yes
- MRP	Yes	Yes
- MRPD	Yes	Yes
- Prioritized startup	Yes; Max. 32 PROFINET devices	Yes; Max. 32 PROFINET devices
- Number of connectable IO Devices, max.	128	128
- Of which IO devices with IRT, max.	64	64
- of which in line, max.	64	64
- Number of connectable IO Devices for RT, max.	128	128
- of which in line, max.	128	128
- Number of IO Devices that can be simultaneously activated/deactivated, max.	8	8
- IO Devices changing during operation (partner ports), supported	Yes	Yes
- Number of IO Devices per tool, max.	8	8
- Updating times	The minimum value of the update time also depends on communication share set for PROFINET IO, on the number of IO devices, and on the quantity of configured user data	The minimum value of the update time also depends on communication share set for PROFINET IO, on the number of IO devices, and on the quantity of configured user data
Update time for IRT		
- for send cycle of 500 µs	500 µs to 8 ms	500 µs to 8 ms
- for send cycle of 1 ms	1 ms to 16 ms	1 ms to 16 ms
- for send cycle of 2 ms	2 ms to 32 ms	2 ms to 32 ms
- for send cycle of 4 ms	4 ms to 64 ms	4 ms to 64 ms
- With IRT and parameterization of "odd" send cycles	Update time = set "odd" send clock (any multiple of 125 µs: 375 µs, 625 µs ... 3 875 µs)	Update time = set "odd" send clock (any multiple of 125 µs: 375 µs, 625 µs ... 3 875 µs)
Update time for RT		
- for send cycle of 500 µs	500 µs to 256 ms	500 µs to 256 ms
- for send cycle of 1 ms	1 ms to 512 ms	1 ms to 512 ms
- for send cycle of 2 ms	2 ms to 512 ms	2 ms to 512 ms
- for send cycle of 4 ms	4 ms to 512 ms	4 ms to 512 ms
PROFINET IO Device		
Services		
- Isochronous mode	No	No
- IRT	Yes	Yes
- MRP	Yes	Yes
- MRPD	Yes	Yes
- Prioritized startup	Yes	Yes
- Shared device	Yes	Yes
- Number of IO Controllers with shared device, max.	4	4
2. Interface		
Interface type	Integrated Ethernet interface	Integrated Ethernet interface
automatic detection of transmission rate	Yes	Yes
Autonegotiation	Yes	Yes
Autocrossing	Yes	Yes
Interface types		
• Number of ports	1	1
• RJ 45 (Ethernet)	Yes; Integrated	Yes; Integrated
- Transmission rate, max.	1 000 Mbit/s	1 000 Mbit/s
- Industrial Ethernet status LED	No	No

Distributed Controllers

based on ET 200SP

ET 200SP Open Controllers standard and fail-safe

CPU 1515SP PC (F)

Technical specifications (continued)

Article number	6ES7677-2FA31-0EB0 CPU 1515SP PC F	6ES7677-2FA41-0FB0 CPU 1515SP PC F
3. Interface		
Interface type	PROFIBUS with CM DP	PROFIBUS with CM DP
Interface types		
• RS 485	Yes	Yes
Functionality		
• Number of connections via this interface	44	44
• PROFIBUS DP master	Yes	Yes
• PROFIBUS DP slave	Yes	Yes
• SIMATIC communication	Yes	Yes
DP master		
Services		
- Equidistance	No	No
- Isochronous mode	No	No
- Number of connectable DP slaves, max.	125	125
DP slave		
Services		
- Equidistance	No	No
- Isochronous mode	No	No
Protocols		
Number of connections		
• Number of connections, max.	88	88
Supported technology objects		
Motion Control	Yes	Yes
• Number of available Motion Control resources for technology objects (except cam disks)	2 400	2 400
• Required Motion Control resources		
- per speed-controlled axis	40; per axis	40; per axis
- per positioning axis	80; per axis	80; per axis
- per synchronous axis	160; per axis	160; per axis
- per external encoder	80; per external encoder	80; per external encoder
- per output cam	20; per cam	20; per cam
- per cam track	160; per cam track	160; per cam track
- per probe	40; per probe	40; per probe
Controller		
• PID_Compact	Yes; Universal PID controller with integrated optimization	Yes; Universal PID controller with integrated optimization
• PID_3Step	Yes; PID controller with integrated optimization for valves	Yes; PID controller with integrated optimization for valves
• PID-Temp	Yes; PID controller with integrated optimization for temperature	Yes; PID controller with integrated optimization for temperature
Counting and measuring		
• High-speed counter	Yes	Yes
Standards, approvals, certificates		
Highest safety class achievable in safety mode		
Probability of failure (for service life of 20 years and repair time of 100 hours)		
- Low demand mode: PFDavg in accordance with SIL3	< 2.00E-05	< 2.00E-05
- High demand/continuous mode: PFH in accordance with SIL3	< 1.00E-09 1/h	< 1.00E-09 1/h

Technical specifications (continued)

Article number	6ES7677-2FA31-0EB0 CPU 1515SP PC F	6ES7677-2FA41-0FB0 CPU 1515SP PC F
Ambient conditions		
Ambient temperature during operation		
• min.	0 °C	0 °C
• max.	Up to 60 °C with max. 32 ET 200SP modules and 3x 100 mA USB load; up to 55 °C with max. 64 ET 200SP modules and 2x max. 500 mA and 1x max. 100 mA USB load	Up to 60 °C with max. 32 ET 200SP modules and 3x 100 mA USB load; up to 55 °C with max. 64 ET 200SP modules and 2x max. 500 mA and 1x max. 100 mA USB load
• horizontal installation, min.	0 °C	0 °C
• horizontal installation, max.	60 °C	60 °C
• vertical installation, min.	0 °C	0 °C
• vertical installation, max.	50 °C; With max. 32 ET 200SP modules and 3x 100 mA USB load	50 °C; With max. 32 ET 200SP modules and 3x 100 mA USB load
Configuration		
Programming		
Programming language		
- LAD	Yes; incl. failsafe	Yes; incl. failsafe
- FBD	Yes; incl. failsafe	Yes; incl. failsafe
- STL	Yes	Yes
- SCL	Yes	Yes
- CFC	No	No
- GRAPH	Yes	Yes
Know-how protection		
• User program protection/password protection	Yes	Yes
• Copy protection	Yes	Yes
• Block protection	Yes	Yes
Access protection		
• Protection level: Write protection	Yes	Yes
• Protection level: Read/write protection	Yes	Yes
• Protection level: Complete protection	Yes	Yes
Open Development interfaces		
• Size of ODK SO file, max.	3.8 Mbyte	3.8 Mbyte
Peripherals/Options		
Peripherals		
• SD card	Optionally for additional mass storage	Optionally for additional mass storage
Dimensions		
Width	160 mm	160 mm
Height	117 mm	117 mm
Depth	75 mm	75 mm
Weights		
Weight, approx.	0.83 kg	0.83 kg

Ordering data

Article No.

Article No.

SIMATIC ET 200SP Open Controller CPU 1515SP PC (F) (+ HMI)

ET 200SP CPU with Windows Embedded Standard 7 and pre-installed SIMATIC S7-1500 Software Controller (optionally with WinCC RT Advanced)

Type of delivery:
English, German, Chinese, Italian, French, Spanish

Windows embedded Standard 7 E 32-bit, 8 GB CFast card

- CPU 1515SP PC (4 GB RAM)
- CPU 1515SP PC F (4 GB RAM)

6ES7677-2AA31-0EB0
6ES7677-2FA31-0EB0

Windows embedded Standard 7 P 64-bit (Multitouch), 16 GB CFast card

- CPU 1515SP PC (4 GB RAM)
- CPU 1515SP PC + HMI 128PT (4 GB RAM)
- CPU 1515SP PC + HMI 512PT (4 GB RAM)
- CPU 1515SP PC + HMI 2048PT (4 GB RAM)
- CPU 1515SP PC F (4 GB RAM)
- CPU 1515SP PC F + HMI 128PT (4 GB RAM)
- CPU 1515SP PC F + HMI 512PT (4 GB RAM)
- CPU 1515SP PC F + HMI 2048PT (4 GB RAM)

6ES7677-2AA41-0FB0
6ES7677-2AA41-0FK0
6ES7677-2AA41-0FL0
6ES7677-2AA41-0FM0
6ES7677-2FA41-0FB0
6ES7677-2FA41-0FK0
6ES7677-2FA41-0FL0
6ES7677-2FA41-0FM0

Distributed Controllers

based on ET 200SP

ET 200SP Open Controllers standard and fail-safe

CPU 1515SP PC (F)

Ordering data	Article No.	Article No.
Accessories		
Upgrade from SIMATIC S7-1500 Software Controller CPU 1505SP to SIMATIC Open Controller From V 1.x to V 2.0; software download incl. documentation and license key. Email address required for delivery	6ES7672-5DC01-0YK0	
BusAdapter BA 2xRJ45	6ES7193-6AR00-0AA0	
BusAdapter BA 2xFC	6ES7193-6AF00-0AA0	
BusAdapter BA 2xSCRJ	6ES7193-6AP00-0AA0	
BusAdapter BA SCRJ/RJ45	6ES7193-6AP20-0AA0	
BusAdapter BA SCRJ/FC for increased vibration and EMC loads	6ES7193-6AP40-0AA0	
CM DP for ET 200SP CPU PROFIBUS DP master with electrical interface for connecting the ET 200SP CPUs to PROFIBUS at up to 12 Mbit/s	6ES7545-5DA00-0AB0	
Server module Spare parts	6ES7193-6PA00-0AA0	
Power supply connector Spare part; for connecting the 24 V DC supply voltage; with push-in terminals (10 units)	6ES7193-4JB00-0AA0	
Reference identification label 10 sheets of 16 labels	6ES7193-6LF30-0AW0	
Labeling strips 500 labeling strips on roll, light gray, for inscription with thermal transfer roll printer	6ES7193-6LR10-0AA0	
1000 labeling strips DIN A4, light gray, card, for inscription with laser printer	6ES7193-6LA10-0AA0	
STEP 7 Professional V14 SP1 Target system: SIMATIC S7-1200, S7-1500, S7-300, S7-400, WinAC Requirement: Windows 7 Professional SP1 (64-bit), Windows 7 Enterprise SP1 (64-bit), Windows 7 Ultimate SP1 (64-bit), Windows 8.1 Professional (64-bit), Windows 8.1 Enterprise (64-bit), Windows 10 Professional Version 1607, Windows 10 Enterprise Version 1607, Windows 10 Enterprise 2016 LTSB, Windows 10 Enterprise 2015 LTSB, Windows Server 2008 R2 StdE (full installation), Windows Server 2012 StdE (full installation), Windows Server 2016 Standard (full installation); Type of delivery: German, English, Chinese, Italian, French, Spanish STEP 7 Professional V14 SP1, floating license STEP 7 Professional V14 SP1, floating license, software download incl. license key ¹⁾ Email address required for delivery	6ES7822-1AA04-0YA5 6ES7822-1AE04-0YA5	
STEP 7 Safety Advanced V14 Task: Engineering tool for configuring and programming fail-safe user programs for SIMATIC S7-1200 FC, S7-1500F, S7-1500F Software Controller, S7-300F, S7-400F, WinAC RTX F, ET 200SP F Controller and the fail-safe ET 200SP, ET 200S, ET 200M, ET 200iSP, ET 200pro and ET 200eco I/O Requirement: STEP 7 Professional V14 Floating license for 1 user, software and documentation on DVD; license key on USB flash drive Floating license for 1 user, software, documentation and license key for download ¹⁾ ; email address required for delivery		6ES7833-1FA14-0YA5 6ES7833-1FA14-0YH5
SIMATIC ODK 1500S Open Development Kit for support in developing Windows and real-time library functions for S7-1500 Software Controllers; supplied on DVD Open Development Kit for support in developing Windows and real-time library functions for S7-1500 Software Controllers; software download including license key ¹⁾ Email address required for delivery		6ES7806-2CD02-0YA0 6ES7806-2CD02-0YG0
SIMATIC WinCC Advanced V14 Engineering software for the configuration and simulation of SIMATIC Panels; SIMATIC WinCC Runtime Advanced electronic documentation in English, German, French, Italian, Spanish, Chinese • Software and documentation on DVD, floating license, license key on USB flash drive • As download ¹⁾ , software and license key download, floating license, email address required for the delivery		6AV2102-0AA04-0AA5 6AV2102-0AA04-0AH5

¹⁾ For up-to-date information and download availability, see:
<http://www.siemens.com/tia-online-software-delivery>

Overview

- For developing dynamically loadable function libraries for S7-1500 Software Controller and S7-1500 CPU 1518 ODK:
 - Implementation of function libraries by means of high-level programming with C/C++.
 - Execution of the library functions under Windows or in the real-time context of the software controllers.
 - Calling the functions directly from the PLC program.
- Development environment for real-time library functions included in the scope of delivery
- Development of Windows library functions with MS Visual Studio.
- Automatic creation of function blocks for calling the library functions.
- Simple integration of the function blocks into STEP 7 by importing.
- Simple use of the library functions in the controller without specific high-level language know-how.

Ordering data**Article No.****SIMATIC ODK 1500S**

Open Development Kit for support in developing Windows and real-time library functions for S7-1500 Software Controllers; supplied on DVD

6ES7806-2CD02-0YA0

Open Development Kit for support in developing Windows and real-time library functions for S7-1500 Software Controllers; software download including license key ¹⁾

6ES7806-2CD02-0YG0

Email address required for delivery

¹⁾ For up-to-date information and download availability, see: <http://www.siemens.com/tia-online-software-delivery>

Distributed Controllers

based on ET 200Pro
Standard CPUs

IM 154-8 PN/DP CPU

Overview



- CPU with PLC functionality equivalent to S7-315-2 PN/DP provides distributed intelligence for preprocessing
- Interface module for exchanging pre-processed I/O data between the ET 200pro and a higher-level master/IO controller via PROFIBUS DP/PROFINET IO
- PROFINET IO controller to operate distributed I/Os on PROFINET
- Component Based Automation (CBA) on PROFINET
- PROFINET proxy for intelligent devices on PROFIBUS DP in Component Based Automation (CBA)
- PROFINET interface with 3-port switch
- Isochronous mode on PROFIBUS or PROFINET
- Integrated web server with the option of creating user-defined web pages
- CPU with PLC functionality equivalent to S7-315-2 PN/DP provides distributed intelligence for preprocessing
- Fast, simple and end-to-end programming of a system with modular programs via STEP 7
- Fail-safe IM 154-8F PN/DP CPU PROFIsafe available

Note

SIMATIC Micro Memory Card required for operation of CPU.

Technical specifications

Article number	6ES7154-8AB01-0AB0 ET200PRO: IM 154-8 PN/DP CPU, 384KB
General information	
Engineering with	
• Programming package	STEP 7 V5.5 or higher
Supply voltage	
Rated value (DC)	24 V
Power loss	
Power loss, typ.	8.5 W
Memory	
Work memory	
• integrated	384 kbyte
Load memory	
• Plug-in (MMC), max.	8 Mbyte
CPU processing times	
for bit operations, typ.	0.05 µs
for word operations, typ.	0.09 µs
for fixed point arithmetic, typ.	0.12 µs
for floating point arithmetic, typ.	0.45 µs
Counters, timers and their retentivity	
S7 counter	
• Number	256
IEC counter	
• present	Yes
S7 times	
• Number	256
IEC timer	
• present	Yes
Data areas and their retentivity	
Flag	
• Number, max.	2 048 byte
Address area	
I/O address area	
• Inputs	2 048 byte
• Outputs	2 048 byte
Process image	
• Inputs, adjustable	2 048 byte
• Outputs, adjustable	2 048 byte
Time of day	
Clock	
• Hardware clock (real-time)	Yes
Operating hours counter	
• Number	1
1. Interface	
Interface type	Integrated RS 485 interface
Physics	RS 485/connection: 2 x M12 b-coded
Functionality	
• MPI	Yes
• PROFIBUS DP master	Yes
• PROFIBUS DP slave	Yes
• Point-to-point connection	No
DP master	
• Number of DP slaves, max.	124

Technical specifications (continued)

Article number	6ES7154-8AB01-0AB0 ET200PRO: IM 154-8 PN/DP CPU, 384KB
2. Interface	
Interface type	PROFINET
Physics	Ethernet (2 x M12 d-coded; 1 x RJ45)
Interface types	
• Number of ports	3
Functionality	
• MPI	No
• PROFINET IO Controller	Yes; Also simultaneously with IO-Device functionality
• PROFINET IO Device	Yes; Also simultaneously with IO Controller functionality
• PROFINET CBA	Yes
• PROFIBUS DP master	No
• PROFIBUS DP slave	No
Isochronous mode	
Isochronous operation (application synchronized up to terminal)	Yes; Via PROFIBUS DP or PROFINET interface
Communication functions	
PG/OP communication	Yes
Global data communication	
• supported	Yes
S7 basic communication	
• supported	Yes
S7 communication	
• supported	Yes
Open IE communication	
• TCP/IP	Yes; via integrated PROFINET interface and loadable FBs
- Number of connections, max.	8
• ISO-on-TCP (RFC1006)	Yes
- Number of connections, max.	8
• UDP	Yes
- Number of connections, max.	8
Web server	
• supported	Yes
Configuration	
Programming	
Programming language	
- LAD	Yes
- FBD	Yes
- STL	Yes
- SCL	Yes
- CFC	Yes
- GRAPH	Yes
- HiGraph®	Yes
Know-how protection	
• User program protection/password protection	Yes
• Block encryption	Yes; With S7 block Privacy
Dimensions	
Width	135 mm
Height	130 mm
Depth	65 mm; 60 mm without cover for RJ45 socket; 65 mm with cover for RJ45 socket
Weights	
Weight, approx.	720 g

Ordering data

Article No.

IM 154-8 PN/DP CPU interface module, V3.2	6ES7154-8AB01-0AB0
PROFINET IO controller for operating distributed I/Os on PROFINET, with integrated PLC functionality.	
Accessories	
MMC 64 KB ¹⁾	6ES7953-8LF31-0AA0
For program backup.	
MMC 128 KB ¹⁾	6ES7953-8LG31-0AA0
For program backup.	
MMC 512 KB ¹⁾	6ES7953-8LJ31-0AA0
For program backup.	
MMC 2 MB ¹⁾	6ES7953-8LL31-0AA0
For program backup and/or firmware updates.	
MMC 4 MB ¹⁾	6ES7953-8LM31-0AA0
For program backup.	
MMC 8 MB ¹⁾	6ES7953-8LP31-0AA0
For program backup.	
Connection module	6ES7194-4AN00-0AA0
For CPU IM154-8 PN/DP, with 4 x M12 and 2 x 7/8", for connecting PROFINET and PROFIBUS DP.	
SCALANCE X-200 Industrial Ethernet switches	6GK5208-0HA10-2AA6
With integral SNMP access, web diagnostics, copper cable diagnostics and PROFINET diagnostics, for setting up linear, star and ring structures SCALANCE X208PRO, in degree of protection IP65, with eight 10/100 Mbit/s M12 ports, incl. eleven M12 dust caps.	
Industrial Ethernet FC RJ45 Plug 180	
RJ45 plug connector for Industrial Ethernet with a rugged metal enclosure and integrated insulation displacement contacts for connecting Industrial Ethernet FC installation cables; with 180° cable outlet	
• 1 unit	6GK1901-1BB10-2AA0
• 10 units	6GK1901-1BB10-2AB0
• 50 units	6GK1901-1BB10-2AE0
Industrial Ethernet Fast Connect installation cables	
• FastConnect Standard Cable	6XV1840-2AH10
• FastConnect Trailing Cable	6XV1840-3AH10
• FastConnect Marine Cable	6XV1840-4AH10
Industrial Ethernet FastConnect installation cables	
• IE FC TP Trailing Cable GP 2 x 2; sold by the meter, max. delivery unit 1 000 m; minimum order quantity 20 m.	6XV1870-2D
• IE TP Torsion Cable GP 2 x 2; sold by the meter, max. delivery unit 1 000 m; minimum order quantity 20 m.	6XV1870-2F
Industrial Ethernet Fast Connect	
Stripping Tool	6GK1901-1GA00

¹⁾ An MMC is essential for operating the CPU

Distributed Controllers

based on ET 200Pro
Standard CPUs

IM 154-8 PN/DP CPU

Ordering data	Article No.	Article No.
IE connecting cable M12-180/M12-180 <ul style="list-style-type: none"> • Preassembled IE FC TP Trailing Cable GP 2 x 2 (PROFINET Type C) with two 4-pin M12 plugs (4-pin, D-coded), degree of protection IP65/IP67, in various lengths: <ul style="list-style-type: none"> - 0.3 m - 0.5 m - 1.0 m - 1.5 m - 2.0 m - 3.0 m - 5.0 m - 10 m - 15 m • PROFINET M12 connecting cable, trailing cable preassembled at both ends with angled M12 connectors (male insert), in various lengths: <ul style="list-style-type: none"> - 3.0 m - 5.0 m - 10 m • PROFINET M12 connecting cable, trailing cable preassembled at one end with angled M12 connector (male insert at one end, other end open), in various lengths: <ul style="list-style-type: none"> - 3.0 m - 5.0 m - 10 m 	6XV1870-8AE30 6XV1870-8AE50 6XV1870-8AH10 6XV1870-8AH15 6XV1870-8AH20 6XV1870-8AH30 6XV1870-8AH50 6XV1870-8AN10 6XV1870-8AN15 3RK1902-2NB30 3RK1902-2NB50 3RK1902-2NC10 3RK1902-2HB30 3RK1902-2HB50 3RK1902-2HC10	7/8" connecting cable to power supply <p>5-wire, 5 x 1.5 mm², trailing type, preassembled with two 7/8" connectors (axial cable outlet), 5-pin, up to 50 m, in various lengths:</p> <ul style="list-style-type: none"> - 1.5 m - 2.0 m - 3.0 m - 5.0 m - 10 m - 15 m - Other special lengths with 90° or 180° cable outlet. <ul style="list-style-type: none"> • Power cable, can be trailed, 5 x 1.5 mm², preassembled at both ends with 7/8" angled connectors (female insert at one end, male insert at the other end), in various lengths: <ul style="list-style-type: none"> - 3.0 m - 5.0 m - 10 m • Power cable, can be trailed, 5 x 1.5 mm², preassembled at one end with 7/8" angled connector with female insert (female insert at one end, other end open), in various lengths: <ul style="list-style-type: none"> - 3.0 m - 5.0 m - 10 m
IE FC M12 Plug PRO <p>PROFINET M12 plug connector, D-coded with fast connection system, axial cable outlet.</p> <ul style="list-style-type: none"> • 1 unit • 8 units • PROFINET M12 plug connector, D-coded, angled. 	6GK1901-0DB20-6AA0 6GK1901-0DB20-6AA8 3RK1902-2DA00	Power line <p>5-wire, 5 x 1.5 mm², trailing type, sold by the meter, minimum order quantity 20 m, maximum order quantity 1 000 m.</p>
IE panel feed-through <p>Cabinet feedthrough for converting from the M12 connection system (D-coded, IP65/IP67) to the RJ45 connection system (IP20), 1 pack = 5 units.</p>	6GK1901-0DM20-2AA5	7/8" cable connector <p>For ET 200eco, with axial cable outlet</p> <ul style="list-style-type: none"> • with male insert, 5-pack • with female insert, 5-pack • angled, with female insert, 1 unit • angled, with male insert, 1 unit <p>7/8" cover cap, 10 per pack</p>
		6XV1822-5BH15 6XV1822-5BH20 6XV1822-5BH30 6XV1822-5BH50 6XV1822-5BN10 6XV1822-5BN15 <p>See http://support.automation.siemens.com/WW/view/en/26999294</p> 3RK1902-3NB30 3RK1902-3NB50 3RK1902-3NC10 3RK1902-3GB30 3RK1902-3GB50 3RK1902-3GC10 6XV1830-8AH10

Ordering data	Article No.		Article No.
Twisted Pair cables 4x2 with RJ45 connectors		M12 bus termination connector for PROFIBUS, female insert	6GK1905-0ED00
0.5 m	6XV1870-3QE50	M12 bus termination connector for PROFIBUS, male insert	6GK1905-0EC00
1 m	6XV1870-3QH10	M12 plug connector, axial outlet, with male insert	6GK1905-0EA00
2 m	6XV1870-3QH20	PROFIBUS FC Standard Cable GP	6XV1830-0EH10
6 m	6XV1870-3QH60	Standard type with special design for fast mounting, 2-wire, shielded.	
10 m	6XV1870-3QN10	Sold by the meter; max. delivery unit 1 000 m, minimum order quantity 20 m.	
Crossed Twisted Pair cables 4x2 with RJ45 connectors		PROFIBUS FC Trailing Cable	6XV1830-3EH10
0.5 m	6XV1870-3RE50	2-wire, shielded.	
1 m	6XV1870-3RH10	PROFIBUS FC Food Cable	6XV1830-0GH10
2 m	6XV1870-3RH20	2-wire, shielded.	
6 m	6XV1870-3RH60	Sold by the meter; max. delivery unit 1 000 m, minimum order quantity 20 m.	
10 m	6XV1870-3RN10	PROFIBUS FC Robust Cable	6XV1830-0JH10
M12 sealing cap	3RX9802-0AA00	2-wire, shielded.	
For protection of unused M12 connections with ET 200pro		Sold by the meter; max. delivery unit 1 000 m, minimum order quantity 20 m.	
M12 sealing caps with female thread	6ES7194-4JD60-0AA0	PROFIBUS M12 cable connector	
5 units		5-pole, B-coded, metal casing, 1 pack = 5 units.	
PROFIBUS M12 connecting cable		• Female insert	6GK1905-0EB00
Preassembled, with two 5-pole M12 connectors/sockets, up to 100 m, in various lengths:			
1.5 m	6XV1830-3DH15		
2.0 m	6XV1830-3DH20		
3.0 m	6XV1830-3DH30		
5.0 m	6XV1830-3DH50		
10 m	6XV1830-3DN10		
15 m	6XV1830-3DN15		
Other special lengths with 90° or 180° cable outlet	See http://support.automation.siemens.com/WW/view/en/26999294		

Distributed Controllers

based on ET 200Pro
Standard CPUs

CPU 1516pro-2 PN

Overview



- CPU 1516pro-2 PN for SIMATIC ET 200pro based on S7-1500 CPU 1516-3 PN/DP
- For applications with high requirements on the program scope and processing speed, for distributed setup via PROFINET IO
- PROFINET IO controller for operating distributed I/O on PROFINET
- PROFINET I-Device for connecting the CPU as an intelligent PROFINET device with a SIMATIC or third-party PROFINET IO controller
- PROFINET Shared I-Device for 4 controllers
- PROFINET IO RT/IRT interface with integrated 3-port switch
- Additional PROFINET IO RT interface with separate IP address
- Isochronous mode on PROFINET
- Integrated motion control functionalities for controlling speed-controlled and positioning axes, support for external encoders, cams/cam tracks and probes
- OPC UA Data Access Server
- Integrated web server with the option of creating user-defined web pages

Note

SIMATIC Memory Card required for operating the CPU

Technical specifications

Article number	6ES7516-2PN00-0AB0 ET 200pro: CPU 1516PRO-2 PN
General information	
Product type designation	CPU 1516pro-2 PN
Engineering with	
• STEP 7 TIA Portal configurable/ integrated as of version	V14
Supply voltage	
Type of supply voltage	24 V DC
Power loss	
Power loss, typ.	5.3 W
Memory	
Work memory	
• integrated (for program)	1 Mbyte
• integrated (for data)	5 Mbyte
Load memory	
• Plug-in (SIMATIC Memory Card), max.	32 Gbyte
CPU processing times	
for bit operations, typ.	10 ns
for word operations, typ.	12 ns
for fixed point arithmetic, typ.	16 ns
for floating point arithmetic, typ.	64 ns
Counters, timers and their retentivity	
S7 counter	
• Number	2 048
IEC counter	
• Number	Any (only limited by the main memory)
S7 times	
• Number	2 048
IEC timer	
• Number	Any (only limited by the main memory)
Data areas and their retentivity	
Flag	
• Number, max.	16 kbyte
Address area	
I/O address area	
• Inputs	32 kbyte; All inputs are in the process image
• Outputs	32 kbyte; All outputs are in the process image
Address space per module	
• Address space per module, max.	256 byte; For input and output data respectively
Address space per station	
• Address space per station, max.	4 096 byte; for central inputs and outputs; depending on configuration
Time of day	
Clock	
• Type	Hardware clock

Technical specifications (continued)

Article number	6ES7516-2PN00-0AB0 ET 200pro: CPU 1516PRO-2 PN
1. Interface	
Interface types	
• Number of ports	3; 2x M12 + 1x RJ45
• integrated switch	Yes
• RJ 45 (Ethernet)	Yes; X1 P3
Functionality	
• PROFINET IO Controller	Yes
• PROFINET IO Device	Yes
• SIMATIC communication	Yes
• Open IE communication	Yes
• Web server	Yes
• Media redundancy	Yes
PROFINET IO Controller	
Services	
- PG/OP communication	Yes
- S7 routing	Yes
- Isochronous mode	Yes
- Open IE communication	Yes
- IRT	Yes
- MRP	Yes; As MRP redundancy manager and/or MRP client; max. number of devices in the ring: 50
- MRPD	Yes; Requirement: IRT
- PROFlenergy	Yes
- Prioritized startup	Yes; Max. 32 PROFINET devices
- Number of connectable IO Devices, max.	256; In total, up to 1 000 distributed I/O devices can be connected via AS-i, PROFIBUS or PROFINET
- Of which IO devices with IRT, max.	64
- Number of connectable IO Devices for RT, max.	256
- of which in line, max.	256
- Number of IO Devices that can be simultaneously activated/deactivated, max.	8; in total across all interfaces
- Number of IO Devices per tool, max.	8
- Updating times	The minimum value of the update time also depends on communication share set for PROFINET IO, on the number of IO devices, and on the quantity of configured user data
Update time for IRT	
- for send cycle of 250 µs	250 µs to 4 ms; Note: In the case of IRT with isochronous mode, the minimum update time of 500 µs of the isochronous OB is decisive
- for send cycle of 500 µs	500 µs to 8 ms
- for send cycle of 1 ms	1 ms to 16 ms
- for send cycle of 2 ms	2 ms to 32 ms
- for send cycle of 4 ms	4 ms to 64 ms
- With IRT and parameterization of "odd" send cycles	Update time = set "odd" send clock (any multiple of 125 µs: 375 µs, 625 µs ... 3 875 µs)
Update time for RT	
- for send cycle of 250 µs	250 µs to 128 ms
- for send cycle of 500 µs	500 µs to 256 ms
- for send cycle of 1 ms	1 ms to 512 ms
- for send cycle of 2 ms	2 ms to 512 ms
- for send cycle of 4 ms	4 ms to 512 ms

Article number	6ES7516-2PN00-0AB0 ET 200pro: CPU 1516PRO-2 PN
PROFINET IO Device	
Services	
- PG/OP communication	Yes
- S7 routing	Yes
- Isochronous mode	No
- Open IE communication	Yes
- IRT	Yes
- MRP	Yes
- MRPD	Yes; Requirement: IRT
- PROFlenergy	Yes
- Prioritized startup	No
- Shared device	Yes
- Number of IO Controllers with shared device, max.	4
2. Interface	
Interface types	
• Number of ports	1; 1x M12
• integrated switch	No
• RJ 45 (Ethernet)	No
Functionality	
• PROFINET IO Controller	Yes
• PROFINET IO Device	Yes
• SIMATIC communication	Yes
• Open IE communication	Yes
• Web server	Yes
• Media redundancy	No
PROFINET IO Controller	
Services	
- PG/OP communication	Yes
- S7 routing	Yes
- Isochronous mode	No
- Open IE communication	Yes
- IRT	No
- MRP	No
- PROFlenergy	Yes
- Prioritized startup	No
- Number of connectable IO Devices, max.	32; In total, up to 1 000 distributed I/O devices can be connected via AS-i, PROFIBUS or PROFINET
- Number of connectable IO Devices for RT, max.	32
- of which in line, max.	32
- Number of IO Devices that can be simultaneously activated/deactivated, max.	8; in total across all interfaces
- Number of IO Devices per tool, max.	8
- Updating times	The minimum value of the update time also depends on communication share set for PROFINET IO, on the number of IO devices, and on the quantity of configured user data
Update time for RT	
- for send cycle of 1 ms	1 ms to 512 ms

Distributed Controllers

based on ET 200Pro
Standard CPUs

CPU 1516pro-2 PN

Technical specifications (continued)

Article number	6ES7516-2PN00-0AB0 ET 200pro: CPU 1516PRO-2 PN
PROFINET IO Device	
Services	
- PG/OP communication	Yes
- S7 routing	Yes
- Isochronous mode	No
- Open IE communication	Yes
- IRT	No
- MRP	No
- MRPD	No
- PROFinergy	Yes
- Prioritized startup	No
- Shared device	Yes
- Number of IO Controllers with shared device, max.	4
Protocols	
Number of connections	
• Number of connections, max.	128; Via integrated interfaces of the CPU
Isochronous mode	
Isochronous operation (application synchronized up to terminal)	Yes; Via X1, with minimum OB 6x cycle of 500 µs
Supported technology objects	
Motion Control	Yes; Note: The number of axes affects the cycle time of the PLC program; selection guide via the TIA Selection Tool or SIZER
• Number of available Motion Control resources for technology objects (except cam disks)	2 400
• Required Motion Control resources	
- per speed-controlled axis	40
- per positioning axis	80
- per synchronous axis	160
- per external encoder	80
- per output cam	20
- per cam track	160
- per probe	40
Controller	
• PID_Compact	Yes; Universal PID controller with integrated optimization
• PID_3Step	Yes; PID controller with integrated optimization for valves
• PID-Temp	Yes; PID controller with integrated optimization for temperature
Counting and measuring	
• High-speed counter	Yes

Article number	6ES7516-2PN00-0AB0 ET 200pro: CPU 1516PRO-2 PN
Ambient conditions	
Ambient temperature during operation	
• horizontal installation, min.	-25 °C
• horizontal installation, max.	55 °C
• vertical installation, min.	-25 °C
• vertical installation, max.	55 °C
Configuration	
Programming	
Programming language	
- LAD	Yes
- FBD	Yes
- STL	Yes
- SCL	Yes
- GRAPH	Yes
Know-how protection	
• User program protection/password protection	Yes
• Copy protection	Yes
• Block protection	Yes
Access protection	
• Protection level: Write protection	Yes
• Protection level: Read/write protection	Yes
• Protection level: Complete protection	Yes
Dimensions	
Width	135 mm
Height	130 mm
Depth	65 mm
Weights	
Weight, approx.	614 g

Ordering data	Article No.	Article No.
CPU 1516pro-2 PN Work memory 1 MB for program, 5 MB for data, PROFINET IO IRT interface, PROFINET/PROFIBUS interface; SIMATIC Memory Card required	6ES7516-2PN00-0AB0	
Accessories		
SIMATIC Memory Card		
4 MB ¹⁾	6ES7954-8LC02-0AA0	
12 MB ¹⁾	6ES7954-8LE02-0AA0	
24 MB ¹⁾	6ES7954-8LF02-0AA0	
256 MB ¹⁾	6ES7954-8LL02-0AA0	
2 GB ¹⁾	6ES7954-8LP02-0AA0	
32 GB ¹⁾	6ES7954-8LT03-0AA0	
Connection module	6ES7194-4AP00-0AA0	
CM CPU 2PN M12 / 7/8"; with 3 x M12 and 2 x 7/8", for connecting 2 x PROFINET		
Industrial Ethernet FC RJ45 Plug 180		
RJ45 plug connector for Industrial Ethernet with a rugged metal enclosure and integrated insulation displacement contacts for connecting Industrial Ethernet FC installation cables; with 180° cable outlet		
<ul style="list-style-type: none"> • 1 unit • 10 units • 50 units 	6GK1901-1BB10-2AA0 6GK1901-1BB10-2AB0 6GK1901-1BB10-2AE0	
Industrial Ethernet Fast Connect installation cables		
<ul style="list-style-type: none"> • FastConnect Standard Cable • FastConnect Trailing Cable • FastConnect Marine Cable 	6XV1840-2AH10 6XV1840-3AH10 6XV1840-4AH10	
Industrial Ethernet FastConnect installation cables		
<ul style="list-style-type: none"> • IE FC TP Trailing Cable GP 2 x 2; sold by the meter, max. delivery unit 1 000 m; minimum order quantity 20 m. • IE TP Torsion Cable GP 2 x 2; sold by the meter, max. delivery unit 1 000 m; minimum order quantity 20 m. 	6XV1870-2D 6XV1870-2F	
Industrial Ethernet FastConnect Stripping Tool	6GK1901-1GA00	
		IE Connecting Cable M12-180/M12-180 <ul style="list-style-type: none"> • Preassembled IE FC TP Trailing Cable GP 2 x 2 (PROFINET Type C) with two 4-pin M12 plugs (4-pin, D-coded), degree of protection IP65/IP67, in various lengths: <ul style="list-style-type: none"> • 0.3 m • 0.5 m • 1.0 m • 1.5 m • 2.0 m • 3.0 m • 5.0 m • 10 m • 15 m • PROFINET M12 connecting cable, trailing cable preassembled at both ends with angled M12 connectors (male insert), in various lengths: <ul style="list-style-type: none"> • 3.0 m • 5.0 m • 10 m • PROFINET M12 connecting cable, trailing cable preassembled at one end with angled M12 connector (male insert at one end, other end open), in various lengths: <ul style="list-style-type: none"> • 3.0 m • 5.0 m • 10 m
		6XV1870-8AE30 6XV1870-8AE50 6XV1870-8AH10 6XV1870-8AH15 6XV1870-8AH20 6XV1870-8AH30 6XV1870-8AH50 6XV1870-8AN10 6XV1870-8AN15
		3RK1902-2NB30 3RK1902-2NB50 3RK1902-2NC10
		3RK1902-2HB30 3RK1902-2HB50 3RK1902-2HC10
		IE FC M12 Plug PRO PROFINET M12 plug connector, D-coded with fast connection system, axial cable outlet. <ul style="list-style-type: none"> • 1 unit • 8 units • PROFINET M12 plug connector, D-coded, angled.
		6GK1901-0DB20-6AA0 6GK1901-0DB20-6AA8 3RK1902-2DA00
		IE panel feedthrough Cabinet feedthrough for converting from the M12 connection system (D-coded, IP65/IP67) to the RJ45 connection system (IP20), 1 pack = 5 units.
		6GK1901-0DM20-2AA5

¹⁾ An MMC is essential for operating the CPU

Distributed Controllers

based on ET 200Pro
Standard CPUs

CPU 1516pro-2 PN

Ordering data

Article No.

7/8" connecting cable to power supply

5-wire, 5 x 1.5 mm², trailing type, preassembled with two 7/8" connectors (axial cable outlet), 5-pin, up to 50 m, in various lengths:

- 1.5 m
- 2.0 m
- 3.0 m
- 5.0 m
- 10 m
- 15 m
- Other special lengths with 90° or 180° cable outlet.

- Power cable, can be trailed, 5 x 1.5 mm², preassembled at both ends with 7/8" angled connectors (female insert at one end, male insert at the other end), in various lengths:

- 3.0 m
- 5.0 m
- 10 m

- Power cable, can be trailed, 5 x 1.5 mm², preassembled at one end with 7/8" angled connector with female contact insert (female contact insert at one end, other end open), in various lengths:

- 3.0 m
- 5.0 m
- 10 m

Power line

5-wire, 5 x 1.5 mm², trailing type, sold by the meter, minimum order quantity 20 m, maximum order quantity 1 000 m.

7/8" cable connector

For ET 200eco, with axial cable outlet

- with male insert, 5-pack
- with female insert, 5-pack
- angled, with female insert, 1 unit
- angled, with male insert, 1 unit

7/8" cover cap, 10 per pack

6XV1822-5BH15
6XV1822-5BH20
6XV1822-5BH30
6XV1822-5BH50
6XV1822-5BN10
6XV1822-5BN15

See
<http://support.automation.siemens.com/WWW/view/en/26999294>

3RK1902-3NB30
3RK1902-3NB50
3RK1902-3NC10

3RK1902-3GB30
3RK1902-3GB50
3RK1902-3GC10

6XV1830-8AH10

6GK1905-0FA00
6GK1905-0FB00
3RK1902-3DA00
3RK1902-3BA00
6ES7194-3JA00-0AA0

Article No.

Twisted Pair cables 4x2 with RJ45 connectors

0.5 m	6XV1870-3QE50
1 m	6XV1870-3QH10
2 m	6XV1870-3QH20
6 m	6XV1870-3QH60
10 m	6XV1870-3QN10

Crossed Twisted Pair cables 4x2 with RJ45 connectors

0.5 m	6XV1870-3RE50
1 m	6XV1870-3RH10
2 m	6XV1870-3RH20
6 m	6XV1870-3RH60
10 m	6XV1870-3RN10

M12 sealing cap

For protection of unused M12 connections with ET 200pro

3RX9802-0AA00

M12 sealing caps with female thread

5 units

6ES7194-4JD60-0AA0

Overview



- Interface module for SIMATIC ET 200pro with integrated fail-safe CPU
- CPU with PLC functionality equivalent to CPU S7-315F PN/DP; with distributed intelligence for preprocessing

- For constructing a fail-safe automation system for plants with increased safety requirements
- Complies with safety requirements up to SIL 3 according to IEC 61508, IEC 62061 and PLe according to ISO 13849-1:2006
- For high-performance control solutions in ET 200pro
- Increase of the availability of systems and machines
- Integral web server with the option of creating user-defined Web sites
- Isochronous mode on PROFIBUS or PROFINET
- PROFINET IO controller for up to 128 IO devices
- PROFINET interface with integrated 3-port switch
- With many communication options: PG/OP communication, PROFINET IO, PROFINET CBA, open IE communication (TCP, ISO-on-TCP and UDP), web server and S7-communication (with loadable FBs)
- Fast, simple and end-to-end programming of a system with modular programs via STEP 7
- Compact SIMATIC Micro Memory Card (MMC)

Note:

SIMATIC Micro Memory Card required for operation of CPU.

Technical specifications

Article number	6ES7154-8FB01-0AB0	6ES7154-8FX00-0AB0
	ET200PRO: IM 154-8F PN/DP CPU, 512KB	ET200PRO: IM 154-8FX PN/DP CPU, 1,5MB
General information		
Engineering with		
• Programming package	STEP 7 V5.5 or higher, Distributed Safety V5.4 SP4	As of STEP 7 V5.5 with HSP 222 + Distributed Safety V5.4 SP4
Supply voltage		
Rated value (DC)	24 V	24 V
Power loss		
Power loss, typ.	8.5 W	8.5 W
Memory		
Work memory		
• integrated	512 kbyte	1 536 kbyte
Load memory		
• Plug-in (MMC), max.	8 Mbyte	8 Mbyte
CPU processing times		
for bit operations, typ.	0.05 µs	0.025 µs
for word operations, typ.	0.09 µs	0.03 µs
for fixed point arithmetic, typ.	0.12 µs	0.04 µs
for floating point arithmetic, typ.	0.45 µs	0.16 µs
Counters, timers and their retentivity		
S7 counter		
• Number	256	256
IEC counter		
• present	Yes	Yes
S7 times		
• Number	256	256
IEC timer		
• present	Yes	Yes
Data areas and their retentivity		
Flag		
• Number, max.	2 048 byte	2 048 byte

Distributed Controllers

based on ET 200Pro

Fail-safe CPUs

IM 154-8 F PN/DP CPU

Technical specifications (continued)

Article number	6ES7154-8FB01-0AB0 ET200PRO: IM 154-8F PN/DP CPU, 512KB	6ES7154-8FX00-0AB0 ET200PRO: IM 154-8FX PN/DP CPU, 1,5MB
Address area		
I/O address area		
• Inputs	2 048 byte	2 048 byte
• Outputs	2 048 byte	2 048 byte
Process image		
• Inputs, adjustable	2 048 byte	2 048 byte
• Outputs, adjustable	2 048 byte	2 048 byte
Time of day		
Clock		
• Hardware clock (real-time)	Yes	Yes
Operating hours counter		
• Number	1	1
1. Interface		
Interface type	Integrated RS 485 interface	Integrated RS 485 interface
Physics	RS 485/connection: 2 x M12 b-coded	RS 485/connection: 2 x M12 b-coded
Functionality		
• MPI	Yes	Yes
• PROFIBUS DP master	Yes	Yes
• PROFIBUS DP slave	Yes	Yes
• Point-to-point connection	No	No
DP master		
• Number of DP slaves, max.	124	124
2. Interface		
Interface type	PROFINET	PROFINET
Physics	Ethernet (2 x M12 d-coded; 1 x RJ45)	Ethernet (2 x M12 d-coded; 1 x RJ45)
Interface types		
• Number of ports	3	3
Functionality		
• MPI	No	No
• PROFINET IO Controller	Yes; Also simultaneously with IO-Device functionality	Yes; Also simultaneously with IO-Device functionality
• PROFINET IO Device	Yes; Also simultaneously with IO Controller functionality	Yes; Also simultaneously with IO Controller functionality
• PROFINET CBA	Yes	Yes
• PROFIBUS DP master	No	No
• PROFIBUS DP slave	No	No
Isochronous mode		
Isochronous operation (application synchronized up to terminal)	Yes; Via PROFIBUS DP or PROFINET interface	Yes; Via PROFIBUS DP or PROFINET interface
Communication functions		
PG/OP communication	Yes	Yes
Global data communication		
• supported	Yes	Yes
S7 basic communication		
• supported	Yes	Yes
S7 communication		
• supported	Yes	Yes
Open IE communication		
• TCP/IP	Yes; via integrated PROFINET interface and loadable FBs	Yes; via integrated PROFINET interface and loadable FBs
- Number of connections, max.	8	8
• ISO-on-TCP (RFC1006)	Yes	Yes
- Number of connections, max.	8	8
• UDP	Yes	Yes
- Number of connections, max.	8	8
Web server		
• supported	Yes	Yes

Technical specifications (continued)

Article number	6ES7154-8FB01-0AB0	6ES7154-8FX00-0AB0
	ET200PRO: IM 154-8F PN/DP CPU, 512KB	ET200PRO: IM 154-8FX PN/DP CPU, 1,5MB
Configuration		
Programming		
Programming language		
- LAD	Yes	Yes
- FBD	Yes	Yes
- STL	Yes	Yes
- SCL	Yes	Yes
- CFC	Yes	Yes
- GRAPH	Yes	Yes
- HiGraph®	Yes	Yes
Know-how protection		
• User program protection/password protection	Yes	Yes
• Block encryption	Yes; With S7 block Privacy	Yes; With S7 block Privacy
Dimensions		
Width	135 mm	135 mm
Height	130 mm	130 mm
Depth	65 mm; 60 mm without cover for RJ45 socket; 65 mm with cover for RJ45 socket	65 mm; 60 mm without cover for RJ45 socket; 65 mm with cover for RJ45 socket
Weights		
Weight, approx.	720 g	720 g

Ordering data
IM 154-8 F PN/DP CPU interface module, V3.2

Fail-safe PROFINET IO controller for operating distributed I/Os on PROFINET, with integrated PLC functionality.

- 512 KB work memory
- 1.5 MB work memory

6ES7154-8FB01-0AB0
6ES7154-8FX00-0AB0

Distributed Safety V5.4 programming tool

Task:
 Engineering tool for configuring fail-safe user programs for SIMATIC S7-300F, S7-400F, WinAC RTX F, ET 200S, ET 200M, ET 200iSP, ET 200pro, ET 200eco

Requirement:
 STEP 7 V5.3 SP3 and higher

Floating license

6ES7833-1FC02-0YA5

Floating license for 1 user, license key download without software or documentation¹⁾; email address required for delivery.

6ES7833-1FC02-0YH5

Distributed Safety Upgrade

From V5.x to V5.4;
 floating license for 1 user

6ES7833-1FC02-0YE5

STEP 7 Safety Advanced V14

Task:
 Engineering tool for configuring and programming fail-safe user programs for SIMATIC S7-1200 FC, S7-1500F, S7-1500F Software Controller, S7-300F, S7-400F, WinAC RTX F, ET 200SP F Controller and the fail-safe ET 200SP, ET 200S, ET 200M, ET 200iSP, ET 200pro and ET 200eco I/O

Requirement:
 STEP 7 Professional V14

Floating license for 1 user, software and documentation on DVD;
 license key on USB flash drive

6ES7833-1FA14-0YA5

Floating license for 1 user, software, documentation and license key for download¹⁾;
 email address required for delivery

6ES7833-1FA14-0YH5

¹⁾ For up-to-date information and download availability, see:
<http://www.siemens.com/tia-online-software-delivery>

Distributed Controllers

based on ET 200Pro

Fail-safe CPUs

IM 154-8 F PN/DP CPU

Ordering data	Article No.	Article No.
Accessories		
SIMATIC Micro Memory Cards		
MMC 64 KB ²⁾	6ES7953-8LF31-0AA0	
For program backup.		
MMC 128 KB ²⁾	6ES7953-8LG31-0AA0	
For program backup.		
MMC 512 KB ²⁾	6ES7953-8LJ31-0AA0	
For program backup.		
MMC 2 MB ²⁾	6ES7953-8LL31-0AA0	
For program backup and/or firmware updates.		
MMC 4 MB ²⁾	6ES7953-8LM31-0AA0	
For program backup.		
MMC 8 MB ²⁾	6ES7953-8LP31-0AA0	
For program backup.		
Connection module	6ES7194-4AN00-0AA0	
For CPU IM154-8 PN/DP, with 4 x M12 and 2 x 7/8", for connecting PROFINET and PROFIBUS DP.		
SCALANCE X-200 Industrial Ethernet switches	6GK5208-0HA10-2AA6	
With integral SNMP access, web diagnostics, copper cable diagnostics and PROFINET diagnostics, for setting up linear, star and ring structures SCALANCE X208PRO, in degree of protection IP65, with eight 10/100 Mbit/s M12 ports, incl. eleven M12 dust caps.		
Industrial Ethernet FC RJ45 Plug 90		
RJ45 plug connector for Industrial Ethernet with a rugged metal housing and integrated insulation displacement contacts for connecting Industrial Ethernet FC installation cables; with 90° cable outlet.		
<ul style="list-style-type: none"> • 1 unit • 10 units 	6GK1901-1BB20-2AA0 6GK1901-1BB20-2AB0	
Industrial Ethernet FC RJ45 Plug 180		
RJ45 plug connector for Industrial Ethernet with a rugged metal enclosure and integrated insulation displacement contacts for connecting Industrial Ethernet FC installation cables; with 180° cable outlet		
<ul style="list-style-type: none"> • 1 unit • 10 units • 50 units 	6GK1901-1BB10-2AA0 6GK1901-1BB10-2AB0 6GK1901-1BB10-2AE0	
Industrial Ethernet FastConnect installation cables		
<ul style="list-style-type: none"> • FastConnect Standard Cable • FastConnect Trailing Cable • FastConnect Marine Cable 	6XV1840-2AH10 6XV1840-3AH10 6XV1840-4AH10	
Industrial Ethernet FastConnect installation cables		
<ul style="list-style-type: none"> • IE FC TP Trailing Cable GP 2 x 2; sold by the meter, max. delivery unit 1 000 m; minimum order quantity 20 m. • IE TP Torsion Cable GP 2 x 2; sold by the meter, max. delivery unit 1 000 m; minimum order quantity 20 m. 		6XV1870-2D 6XV1870-2F
Industrial Ethernet FastConnect Stripping Tool		6GK1901-1GA00
IE Connecting Cable M12-180/M12-180		
<ul style="list-style-type: none"> • Preassembled IE FC TP Trailing Cable GP 2 x 2 (PROFINET Type C) with two 4-pin M12 plugs (4-pin, D-coded), degree of protection IP65/IP67, in various lengths: <ul style="list-style-type: none"> - 0.3 m - 0.5 m - 1.0 m - 1.5 m - 2.0 m - 3.0 m - 5.0 m - 10 m - 15 m • PROFINET M12 connecting cable, trailing cable preassembled at both ends with angled M12 connectors (male contact insert), in various lengths: <ul style="list-style-type: none"> - 3.0 m - 5.0 m - 10 m • PROFINET M12 connecting cable, trailing cable preassembled at one end with angled M12 connector (male contact insert at one end, other end open), in various lengths: <ul style="list-style-type: none"> - 3.0 m - 5.0 m - 10 m 		6XV1870-8AE30 6XV1870-8AE50 6XV1870-8AH10 6XV1870-8AH15 6XV1870-8AH20 6XV1870-8AH30 6XV1870-8AH50 6XV1870-8AN10 6XV1870-8AN15 3RK1902-2NB30 3RK1902-2NB50 3RK1902-2NC10 3RK1902-2HB30 3RK1902-2HB50 3RK1902-2HC10
IE FC M12 Plug PRO		
PROFINET M12 plug connector, D-coded with fast connection system, axial cable outlet.		
<ul style="list-style-type: none"> • 1 unit • 8 units • PROFINET M12 plug connector, D-coded, angled 		6GK1901-0DB20-6AA0 6GK1901-0DB20-6AA8 3RK1902-2DA00
IE panel feedthrough		
Cabinet feedthrough for converting from the M12 connection system (D-coded, IP65/IP67) to the RJ45 connection system (IP20), 1 pack = 5 units		6GK1901-0DM20-2AA5

²⁾ An MMC is essential for operating the CPU

Ordering data	Article No.	Article No.
7/8" connecting cable to power supply <ul style="list-style-type: none"> 5-wire, 5 x 1.5 mm², trailing type, preassembled with two 7/8" connectors (axial cable outlet), 5-pin, up to 50 m, in various lengths: <ul style="list-style-type: none"> - 1.5 m - 2.0 m - 3.0 m - 5.0 m - 10 m - 15 m - Other special lengths with 90° or 180° cable outlet Power cable, can be trailed, 5 x 1.5 mm², preassembled at both ends with 7/8" angled connectors (female contact insert at one end, male contact insert at the other end), in various lengths: <ul style="list-style-type: none"> - 3.0 m - 5.0 m - 10 m Power cable, can be trailed, 5 x 1.5 mm², preassembled at one end with 7/8" angled connector with female contact insert (female contact insert at one end, other end open), in various lengths: <ul style="list-style-type: none"> - 3.0 m - 5.0 m - 10 m 	6XV1822-5BH15 6XV1822-5BH20 6XV1822-5BH30 6XV1822-5BH50 6XV1822-5BN10 6XV1822-5BN15 See http://support.automation.siemens.com/WW/view/en/26999294 3RK1902-3NB30 3RK1902-3NB50 3RK1902-3NC10 3RK1902-3GB30 3RK1902-3GB50 3RK1902-3GC10	M12 sealing cap For protection of unused M12 connections with ET 200pro M12 sealing caps with female thread 5 units PROFIBUS M12 connecting cable Preassembled, with two 5-pole M12 connectors/sockets, up to 100 m, in various lengths: <ul style="list-style-type: none"> 1.5 m 2.0 m 3.0 m 5.0 m 10 m 15 m Additional special lengths with 90° or 180° cable outlet. See http://support.automation.siemens.com/WW/view/en/26999294
Power line 5-wire, 5 x 1.5 mm ² , trailing type, sold by the meter, minimum order quantity 20 m, maximum order quantity 1 000 m.	6XV1830-8AH10	3RX9802-0AA00
7/8" cable connector For ET 200eco, with axial cable outlet <ul style="list-style-type: none"> with male contact insert, 5-pack with female contact insert, 5-pack angled, with female contact insert, 1 unit angled, with male contact insert, 1 unit 7/8" cover cap, 10 per pack	6GK1905-0FA00 6GK1905-0FB00 3RK1902-3DA00 3RK1902-3BA00 6ES7194-3JA00-0AA0	6ES7194-4JD60-0AA0
Twisted Pair cables 4x2 with RJ45 connectors 0.5 m 1 m 2 m 6 m 10 m	6XV1870-3QE50 6XV1870-3QH10 6XV1870-3QH20 6XV1870-3QH60 6XV1870-3QN10	6GK1905-0ED00
Crossed Twisted Pair cables 4x2 with RJ45 connectors 0.5 m 1 m 2 m 6 m 10 m	6XV1870-3RE50 6XV1870-3RH10 6XV1870-3RH20 6XV1870-3RH60 6XV1870-3RN10	6GK1905-0EC00
		M12 bus termination connector for PROFIBUS, female contact insert M12 bus termination connector for PROFIBUS, male contact insert M12 plug connector, axial outlet, with male contact insert PROFIBUS FC Standard Cable GP Standard type with special design for fast mounting, 2-wire, shielded. Sold by the meter; max. delivery unit 1 000 m, minimum order quantity 20 m.
		6GK1905-0EA00
		PROFIBUS FC Trailing Cable 2-wire, shielded.
		6XV1830-0EH10
		PROFIBUS FC Food Cable 2-wire, shielded. Sold by the meter; max. delivery unit 1 000 m, minimum order quantity 20 m.
		6XV1830-0GH10
		PROFIBUS FC Robust Cable 2-wire, shielded. Sold by the meter; max. delivery unit 1 000 m, minimum order quantity 20 m.
		6XV1830-0JH10
		PROFIBUS M12 cable connector 5-pole, B-coded, metal casing, 1 pack = 5 units. <ul style="list-style-type: none"> Female contact insert
		6GK1905-0EB00

Distributed Controllers

based on ET 200Pro

Fail-safe CPUs

CPU 1516pro F-2 PN

Overview



- Fail-safe CPU 1516pro F-2 PN for SIMATIC ET 200pro based on S7-1500 CPU 1516F-3 PN/DP
- For applications with high requirements on the program scope and processing speed, for distributed setup via PROFINET IO
- Can be used for fail-safe functions up to SIL 3 according to IEC 61508 and up to PLe according to ISO 13849
- PROFINET IO controller for operating distributed I/O on PROFINET
- PROFINET I-Device for connecting the CPU as an intelligent PROFINET device with a SIMATIC or third-party PROFINET IO controller
- Supports PROFIsafe in centralized and distributed configurations
- PROFINET Shared I-Device for 4 controllers
- PROFINET IO RT/IRT interface with integrated 3-port switch
- Additional PROFINET IO RT interface with separate IP address
- Isochronous mode on PROFINET
- Integrated motion control functionalities for controlling speed-controlled and positioning axes, support for external encoders
- OPC UA Data Access Server
- Integrated web server with the option of creating user-defined web pages

Note

SIMATIC Memory Card required for operation of the CPU.

Technical specifications

Article number	6ES7516-2GN00-0AB0 ET 200pro: CPU 1516PRO F-2 PN
General information	
Product type designation	CPU 1516pro F-2 PN
Engineering with	
• STEP 7 TIA Portal configurable/ integrated as of version	V14
Supply voltage	
Type of supply voltage	24 V DC
Power loss	
Power loss, typ.	5.3 W
Memory	
Work memory	
• integrated (for program)	1.5 Mbyte
• integrated (for data)	5 Mbyte
Load memory	
• Plug-in (SIMATIC Memory Card), max.	32 Gbyte
CPU processing times	
for bit operations, typ.	10 ns
for word operations, typ.	12 ns
for fixed point arithmetic, typ.	16 ns
for floating point arithmetic, typ.	64 ns
Counters, timers and their retentivity	
S7 counter	
• Number	2 048
IEC counter	
• Number	Any (only limited by the main memory)
S7 times	
• Number	2 048
IEC timer	
• Number	Any (only limited by the main memory)
Data areas and their retentivity	
Flag	
• Number, max.	16 kbyte
Address area	
I/O address area	
• Inputs	32 kbyte; All inputs are in the process image
• Outputs	32 kbyte; All outputs are in the process image
Address space per module	
• Address space per module, max.	256 byte; For input and output data respectively
Address space per station	
• Address space per station, max.	4 096 byte; for central inputs and outputs; depending on configuration
Time of day	
Clock	
• Type	Hardware clock

Technical specifications (continued)

Article number	6ES7516-2GN00-0AB0 ET 200pro: CPU 1516PRO F-2 PN
1. Interface	
Interface types	
• Number of ports	3; 2x M12 + 1x RJ45
• integrated switch	Yes
• RJ 45 (Ethernet)	Yes; X1 P3
Functionality	
• PROFINET IO Controller	Yes
• PROFINET IO Device	Yes
• SIMATIC communication	Yes
• Open IE communication	Yes
• Web server	Yes
• Media redundancy	Yes
PROFINET IO Controller	
Services	
- PG/OP communication	Yes
- S7 routing	Yes
- Isochronous mode	Yes
- Open IE communication	Yes
- IRT	Yes
- MRP	Yes; As MRP redundancy manager and/or MRP client; max. number of devices in the ring: 50
- MRPD	Yes; Requirement: IRT
- PROFlenergy	Yes
- Prioritized startup	Yes; Max. 32 PROFINET devices
- Number of connectable IO Devices, max.	256; In total, up to 1 000 distributed I/O devices can be connected via AS-i, PROFIBUS or PROFINET
- Of which IO devices with IRT, max.	64
- Number of connectable IO Devices for RT, max.	256
- of which in line, max.	256
- Number of IO Devices that can be simultaneously activated/deactivated, max.	8; in total across all interfaces
- Number of IO Devices per tool, max.	8
- Updating times	The minimum value of the update time also depends on communication share set for PROFINET IO, on the number of IO devices, and on the quantity of configured user data
Update time for IRT	
- for send cycle of 250 µs	250 µs to 4 ms; Note: In the case of IRT with isochronous mode, the minimum update time of 500 µs of the isochronous OB is decisive
- for send cycle of 500 µs	500 µs to 8 ms
- for send cycle of 1 ms	1 ms to 16 ms
- for send cycle of 2 ms	2 ms to 32 ms
- for send cycle of 4 ms	4 ms to 64 ms
- With IRT and parameterization of "odd" send cycles	Update time = set "odd" send clock (any multiple of 125 µs: 375 µs, 625 µs ... 3 875 µs)
Update time for RT	
- for send cycle of 250 µs	250 µs to 128 ms
- for send cycle of 500 µs	500 µs to 256 ms
- for send cycle of 1 ms	1 ms to 512 ms
- for send cycle of 2 ms	2 ms to 512 ms
- for send cycle of 4 ms	4 ms to 512 ms

Article number	6ES7516-2GN00-0AB0 ET 200pro: CPU 1516PRO F-2 PN
PROFINET IO Device	
Services	
- PG/OP communication	Yes
- S7 routing	Yes
- Isochronous mode	No
- Open IE communication	Yes
- IRT	Yes
- MRP	Yes
- MRPD	Yes; Requirement: IRT
- PROFlenergy	Yes
- Prioritized startup	No
- Shared device	Yes
- Number of IO Controllers with shared device, max.	4
2. Interface	
Interface types	
• Number of ports	1; 1x M12
• integrated switch	No
• RJ 45 (Ethernet)	No
Functionality	
• PROFINET IO Controller	Yes
• PROFINET IO Device	Yes
• SIMATIC communication	Yes
• Open IE communication	Yes
• Web server	Yes
• Media redundancy	No
PROFINET IO Controller	
Services	
- PG/OP communication	Yes
- S7 routing	Yes
- Isochronous mode	No
- Open IE communication	Yes
- IRT	No
- MRP	No
- PROFlenergy	Yes
- Prioritized startup	No
- Number of connectable IO Devices, max.	32; In total, up to 1 000 distributed I/O devices can be connected via AS-i, PROFIBUS or PROFINET
- Number of connectable IO Devices for RT, max.	32
- of which in line, max.	32
- Number of IO Devices that can be simultaneously activated/deactivated, max.	8; in total across all interfaces
- Number of IO Devices per tool, max.	8
- Updating times	The minimum value of the update time also depends on communication share set for PROFINET IO, on the number of IO devices, and on the quantity of configured user data
Update time for RT	
- for send cycle of 1 ms	1 ms to 512 ms

Distributed Controllers

based on ET 200Pro

Fail-safe CPUs

CPU 1516pro F-2 PN

Technical specifications (continued)

Article number	6ES7516-2GN00-0AB0 ET 200pro: CPU 1516PRO F-2 PN
PROFINET IO Device	
Services	
- PG/OP communication	Yes
- S7 routing	Yes
- Isochronous mode	No
- Open IE communication	Yes
- IRT	No
- MRP	No
- MRPD	No
- PROFIenergy	Yes
- Prioritized startup	No
- Shared device	Yes
- Number of IO Controllers with shared device, max.	4
Protocols	
Number of connections	
• Number of connections, max.	128; Via integrated interfaces of the CPU
Isochronous mode	
Isochronous operation (application synchronized up to terminal)	Yes; Via X1, with minimum OB 6x cycle of 375 µs
Supported technology objects	
Motion Control	Yes; Note: The number of axes affects the cycle time of the PLC program; selection guide via the TIA Selection Tool or SIZER
• Number of available Motion Control resources for technology objects (except cam disks)	2 400
• Required Motion Control resources	
- per speed-controlled axis	40; per axis
- per positioning axis	80; per axis
- per synchronous axis	160; per axis
- per external encoder	80; per external encoder
- per output cam	20; per cam
- per cam track	160; per cam track
- per probe	40; per probe
Controller	
• PID_Compact	Yes; Universal PID controller with integrated optimization
• PID_3Step	Yes; PID controller with integrated optimization for valves
• PID-Temp	Yes; PID controller with integrated optimization for temperature
Counting and measuring	
• High-speed counter	Yes
Highest safety class achievable in safety mode	
Probability of failure (for service life of 20 years and repair time of 100 hours)	
- Low demand mode: PFDavg in accordance with SIL3	< 2.00E-05
- High demand/continuous mode: PFH in accordance with SIL3	< 1.00E-09

Article number	6ES7516-2GN00-0AB0 ET 200pro: CPU 1516PRO F-2 PN
Ambient conditions	
Ambient temperature during operation	
• horizontal installation, min.	-25 °C
• horizontal installation, max.	55 °C
• vertical installation, min.	-25 °C
• vertical installation, max.	55 °C
Configuration	
Programming	
Programming language	
- LAD	Yes; incl. failsafe
- FBD	Yes; incl. failsafe
- STL	Yes
- SCL	Yes
- GRAPH	Yes
Know-how protection	
• User program protection/password protection	Yes
• Copy protection	Yes
• Block protection	Yes
Access protection	
• Protection level: Write protection	Yes
• Protection level: Read/write protection	Yes
• Protection level: Complete protection	Yes
Dimensions	
Width	135 mm
Height	130 mm
Depth	65 mm
Weights	
Weight, approx.	614 g

Ordering data	Article No.	Article No.
CPU 1516pro F-2 PN Work memory 1.5 MB for program, 5 MB for data, PROFINET IO IRT interface, PROFINET/PROFIBUS interface; SIMATIC Memory Card required	6ES7516-2GN00-0AB0	
Accessories		
SIMATIC Memory Card 4 MB ¹⁾ 12 MB ¹⁾ 24 MB ¹⁾ 256 MB ¹⁾ 2 GB ¹⁾ 32 GB ¹⁾	6ES7954-8LC02-0AA0 6ES7954-8LE02-0AA0 6ES7954-8LF02-0AA0 6ES7954-8LL02-0AA0 6ES7954-8LP02-0AA0 6ES7954-8LT03-0AA0	
Connection module CM CPU 2PN M12 / 7/8"; with 3 x M12 and 2 x 7/8", for connecting 2 x PROFINET	6ES7194-4AP00-0AA0	
Industrial Ethernet FC RJ45 Plug 180 RJ45 plug connector for Industrial Ethernet with a rugged metal enclosure and integrated insulation displacement contacts for connecting Industrial Ethernet FC installation cables; with 180° cable outlet <ul style="list-style-type: none"> • 1 unit • 10 units • 50 units 	6GK1901-1BB10-2AA0 6GK1901-1BB10-2AB0 6GK1901-1BB10-2AE0	
Industrial Ethernet Fast Connect installation cables <ul style="list-style-type: none"> • FastConnect Standard Cable • FastConnect Trailing Cable • FastConnect Marine Cable 	6XV1840-2AH10 6XV1840-3AH10 6XV1840-4AH10	
Industrial Ethernet FastConnect installation cables <ul style="list-style-type: none"> • IE FC TP Trailing Cable GP 2 x 2; sold by the meter, max. delivery unit 1 000 m; minimum order quantity 20 m. • IE TP Torsion Cable GP 2 x 2; sold by the meter, max. delivery unit 1 000 m; minimum order quantity 20 m. 	6XV1870-2D 6XV1870-2F	
Industrial Ethernet Fast Connect Stripping Tool	6GK1901-1GA00	
		IE Connecting Cable M12-180/M12-180 Preassembled IE FC TP Trailing Cable GP 2 x 2 (PROFINET Type C) with two 4-pin M12 plugs (4-pin, D-coded), degree of protection IP65/IP67, in various lengths: <ul style="list-style-type: none"> • 0.3 m • 0.5 m • 1.0 m • 1.5 m • 2.0 m • 3.0 m • 5.0 m • 10 m • 15 m PROFINET M12 connecting cable, trailing cable preassembled at both ends with angled M12 connectors (male insert), in various lengths: <ul style="list-style-type: none"> • 3.0 m • 5.0 m • 10 m PROFINET M12 connecting cable, trailing cable preassembled at one end with angled M12 connector (male insert at one end, other end open), in various lengths: <ul style="list-style-type: none"> • 3.0 m • 5.0 m • 10 m
		6XV1870-8AE30 6XV1870-8AE50 6XV1870-8AH10 6XV1870-8AH15 6XV1870-8AH20 6XV1870-8AH30 6XV1870-8AH50 6XV1870-8AN10 6XV1870-8AN15
		3RK1902-2NB30 3RK1902-2NB50 3RK1902-2NC10
		3RK1902-2HB30 3RK1902-2HB50 3RK1902-2HC10
		IE FC M12 Plug PRO PROFINET M12 plug connector, D-coded with fast connection system, axial cable outlet. <ul style="list-style-type: none"> • 1 unit • 8 units • PROFINET M12 plug connector, D-coded, angled.
		6GK1901-0DB20-6AA0 6GK1901-0DB20-6AA8 3RK1902-2DA00
		IE panel feedthrough Cabinet feedthrough for converting from the M12 connection system (D-coded, IP65/IP67) to the RJ45 connection system (IP20), 1 pack = 5 units.
		6GK1901-0DM20-2AA5

¹⁾ An MMC is essential for operating the CPU

Distributed Controllers

based on ET 200Pro

Fail-safe CPUs

CPU 1516pro F-2 PN

Ordering data

Article No.

7/8" connecting cable to power supply

5-wire, 5 x 1.5 mm², trailing type, preassembled with two 7/8" connectors (axial cable outlet), 5-pin, up to 50 m, in various lengths:

- 1.5 m
- 2.0 m
- 3.0 m
- 5.0 m
- 10 m
- 15 m
- Other special lengths with 90° or 180° cable outlet.

Power cable, can be trailed, 5 x 1.5 mm², preassembled at both ends with 7/8" angled connectors (female insert at one end, male insert at the other end), in various lengths:

- 3.0 m
- 5.0 m
- 10 m

Power cable, can be trailed, 5 x 1.5 mm², preassembled at one end with 7/8" angled connector with female insert (female insert at one end, other end open), in various lengths:

- 3.0 m
- 5.0 m
- 10 m

Power line

5-wire, 5 x 1.5 mm², trailing type, sold by the meter, minimum order quantity 20 m, maximum order quantity 1 000 m.

6XV1822-5BH15
6XV1822-5BH20
6XV1822-5BH30
6XV1822-5BH50
6XV1822-5BN10
6XV1822-5BN15

See
<http://support.automation.siemens.com/WW/view/en/26999294>

3RK1902-3NB30
3RK1902-3NB50
3RK1902-3NC10

3RK1902-3GB30
3RK1902-3GB50
3RK1902-3GC10

6XV1830-8AH10

Article No.

7/8" cable connector

For ET 200eco, with axial cable outlet.

- with male insert, 5-pack
- with female insert, 5-pack
- angled, with female insert, 1 unit
- angled, with male insert, 1 unit

7/8" cover cap, 10 per pack

6GK1905-0FA00

6GK1905-0FB00

3RK1902-3DA00

3RK1902-3BA00

6ES7194-3JA00-0AA0

Twisted Pair cables 4x2 with RJ45 connectors

0.5 m

1 m

2 m

6 m

10 m

6XV1870-3QE50

6XV1870-3QH10

6XV1870-3QH20

6XV1870-3QH60

6XV1870-3QN10

Crossed Twisted Pair cables 4x2 with RJ45 connectors

0.5 m

1 m

2 m

6 m

10 m

6XV1870-3RE50

6XV1870-3RH10

6XV1870-3RH20

6XV1870-3RH60

6XV1870-3RN10

M12 sealing cap

For protection of unused M12 connections with ET 200pro

3RX9802-0AA00

M12 sealing caps with female thread

5 units

6ES7194-4JD60-0AA0

**8/2 SIMATIC S7-1500 Software Controllers**8/2 Standard CPUs

8/2 CPU 1507S

8/5 Fail-safe CPUs

8/5 CPU 1507S F

8/8 ODK 1500S8/9 Add-on applications

8/9 ODK 1500S SQL driver

8/9 ODK 1500S XML DataAccess driver

8/10 ODK 1500S FileServer

8/11 SIMATIC WinAC

8/11 SIMATIC WinAC RTX

8/17 SIMATIC WinAC RTX F

8/23 SIMATIC WinAC ODK

Brochures

For brochures serving as selection guides for SIMATIC products, refer to:

www.siemens.com/simatic/printmaterial

Software Controllers

SIMATIC S7-1500 Software Controllers Standard CPUs

CPU 1507S

Overview

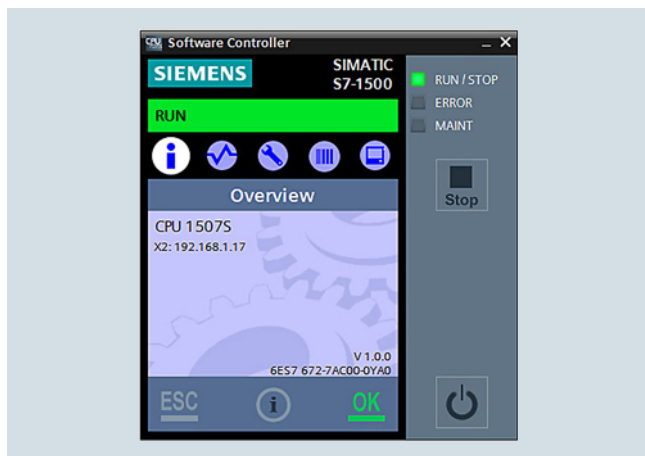

- Software Controller for implementing the functions of a SIMATIC S7-1500 Controller on a SIMATIC IPC
- Optimized for PC-based control tasks with the IPC427 Microbox PC and the IPC477D Panel PC.
- Can also be used on IPC227E, IPC627D, and IPC827D Box PCs, IPC277E and IPC677D Panel PCs, and IPC647D and IPC847D Rack PCs
- C/C++ Runtime for the execution of functions and algorithms implemented in C/C++ under Windows and locally in the CPU 1507S
- Used as a PC-based controller in machines with distributed I/O via PROFINET and PROFIBUS
- Use of the IPC onboard interfaces and PC plug-in cards for PROFINET and PROFIBUS connections
- Integrated motion control functionalities for controlling speed-controlled and positioning axes as well as synchronous operation, support for external encoders, precise position gearing between axes, cams/cam tracks and probes
- Integrated web server for diagnostics with the option of creating user-defined web pages

Technical specifications

Article number	6ES7672-7AC01-0YA0 SIMATIC Software Controller CPU 1507S
General information	
Product type designation	CPU 1507S
Software version	V2.0
Engineering with	
• STEP 7 TIA Portal configurable/ integrated as of version	V14
Memory	
Work memory	
• integrated (for program)	5 Mbyte
• integrated (for data)	20 Mbyte
• Integrated (for ODK application)	20 Mbyte
Load memory	
• integrated (on PC mass storage)	320 Mbyte
CPU processing times	
for bit operations, typ.	1 ns; on SIMATIC IPC427D, Intel Core i7 processor, 1.7 GHz
for word operations, typ.	2 ns; on SIMATIC IPC427D, Intel Core i7 processor, 1.7 GHz
for fixed point arithmetic, typ.	2 ns; on SIMATIC IPC427D, Intel Core i7 processor, 1.7 GHz
for floating point arithmetic, typ.	2 ns; on SIMATIC IPC427D, Intel Core i7 processor, 1.7 GHz
CPU-blocks	
Number of elements (total)	6 000; In addition to blocks such as DBs, FBs and FCs, UDTs, global constants, etc. are also regarded as elements
DB	
• Number, max.	5 999; Number range: 1 to 65535
• Size, max.	16 Mbyte
FB	
• Number, max.	5 998; Number range: 1 to 65535
• Size, max.	512 kbyte
FC	
• Number, max.	5 999; Number range: 1 to 65535
• Size, max.	512 kbyte
OB	
• Size, max.	512 kbyte

Article number	6ES7672-7AC01-0YA0 SIMATIC Software Controller CPU 1507S
Nesting depth	
• per priority class	24
Counters, timers and their retentivity	
S7 counter	
• Number	2 048
IEC counter	
• Number	Any (only limited by the main memory)
S7 times	
• Number	2 048
IEC timer	
• Number	Any (only limited by the main memory)
Data areas and their retentivity	
Flag	
• Number, max.	16 kbyte
Address area	
I/O address area	
• Inputs	32 kbyte
• Outputs	32 kbyte
Time of day	
Clock	
• Type	Software clock, synchronizable, no battery backup
Interfaces	
Number of interfaces	3
1. Interface	
Interface type	Onboard PROFINET / IE interface X2 of the SIMATIC IPC, Intel Springville i210T
Interface types	
• Number of ports	1
• integrated switch	No
• RJ 45 (Ethernet)	Yes
- Transmission rate, max.	100 Mbit/s
- Industrial Ethernet status LED	Yes

Technical specifications (continued)

Article number	6ES7672-7AC01-0YA0 SIMATIC Software Controller CPU 1507S
Functionality	
• Number of connections via this interface	128
• PROFINET IO Controller	Yes
• PROFINET IO Device	Yes
• SIMATIC communication	Yes
• Open IE communication	Yes
• Web server	Yes
PROFINET IO Controller	
Services	
- Isochronous mode	No
- IRT	No
- MRP	No
- MRPD	No
- Prioritized startup	Yes; Max. 32 PROFINET devices; if you want to use the "Prioritized startup" functionality in STEP 7 for the PROFINET interface of the CPU, the CPU and the device must be separated by means of a switch (e.g. SCALANCE X205)
- Number of connectable IO Devices, max.	128
- Number of connectable IO Devices for RT, max.	128
- of which in line, max.	128
- Number of IO Devices that can be simultaneously activated/deactivated, max.	8
- IO Devices changing during operation (partner ports), supported	Yes; The CPU and changing IO devices must be separated by a switch (e.g. SCALANCE X205)
- Number of IO Devices per tool, max.	8
- Updating times	The minimum value of the update time also depends on communication share set for PROFINET IO, on the number of IO devices, and on the quantity of configured user data
Update time for RT	
- for send cycle of 1 ms	1 ms to 512 ms
PROFINET IO Device	
Services	
- Isochronous mode	No
- IRT	No
- MRP	No
- Prioritized startup	Yes; If you want to use the "Prioritized startup" functionality in STEP 7 for the PROFINET interface of the CPU, the CPU and the device must be separated by means of a switch (e.g. SCALANCE X205)
- Shared device	Yes
- Number of IO Controllers with shared device, max.	4

Article number	6ES7672-7AC01-0YA0 SIMATIC Software Controller CPU 1507S
2. Interface	
Interface type	PROFIBUS with CP 5622, CP 5622 onboard
Interface types	
• RS 485	Yes
Functionality	
• Number of connections via this interface	44
• PROFIBUS DP master	Yes
• PROFIBUS DP slave	No
• SIMATIC communication	Yes; no PG/STEP 7 connection possible
DP master	
Services	
- Equidistance	No
- Isochronous mode	No
- Number of connectable DP slaves, max.	64
3. Interface	
Interface type	PROFIBUS with CP 5623
Interface types	
• RS 485	Yes
Functionality	
• Number of connections via this interface	44
• PROFIBUS DP master	Yes
• PROFIBUS DP slave	No
• SIMATIC communication	Yes; no PG/STEP 7 connection possible
DP master	
Services	
- Equidistance	No
- Isochronous mode	No
- Number of connectable DP slaves, max.	125
Protocols	
Number of connections	
• Number of connections, max.	128
Supported technology objects	
Motion Control	Yes; Note: The number of technology objects affects the cycle time of the PLC program; selection guide via the TIA Selection Tool or SIZER
• Number of available Motion Control resources for technology objects (except cam disks)	4 800
• Required Motion Control resources	
- per speed-controlled axis	40; per axis
- per positioning axis	80; per axis
- per synchronous axis	160; per axis
- per external encoder	80; per external encoder
- per output cam	20; per cam
- per cam track	160; per cam track
- per probe	40; per probe
Controller	
• PID_Compact	Yes; Universal PID controller with integrated optimization
• PID_3Step	Yes; PID controller with integrated optimization for valves
• PID-Temp	Yes; PID controller with integrated optimization for temperature
Counting and measuring	
• High-speed counter	Yes

Software Controllers

SIMATIC S7-1500 Software Controllers Standard CPUs

CPU 1507S

Technical specifications (continued)

Article number	6ES7672-7AC01-0YA0 SIMATIC Software Controller CPU 1507S
Hardware requirement	
Hardware required	SIMATIC IPC2x7E, IPC4x7D, IPC6x7D, IPC8x7D
Processor	
• Single-core processor	No
• Single-core processor with hyper-threading	No
• Multi-core processor	Yes
• Multi-core processor with hyper-threading	Yes
• occupied cores	1; For multicore processors with activated Hyper-Threading, one complete physical core is reserved for the CPU 1507S
Lifetime of module	
• Work memory, min.	4 Gbyte
• Hard disk memory required for installation	720 Mbyte
• Temporary hard disk memory for installation	230 Mbyte
• Hard disk memory required at runtime	400 Mbyte
Operating systems	
pre-installed operating system	
• Windows XP	No
• Windows 7	Yes; Professional, Enterprise, Ultimate (32 bits and 64 bits)
• Windows Embedded Standard 7	Yes; With the delivery image of the SIMATIC PC
• Windows 8	No
• Windows Embedded Standard 8	No
Configuration	
Programming	
Programming language	
- LAD	Yes
- FBD	Yes
- STL	Yes
- SCL	Yes
- CFC	No
- GRAPH	Yes
Know-how protection	
• User program protection/password protection	Yes
• Copy protection	Yes
• Block protection	Yes
Access protection	
• Protection level: Write protection	Yes
• Protection level: Read/write protection	Yes
• Protection level: Complete protection	Yes
Open Development interfaces	
• Size of ODK SO file, max.	5.8 Mbyte
Dimensions	
Width	18.2 cm; Packaging
Height	26.5 cm
Depth	3 cm
Weights	
Weight, approx.	200 g

Ordering data

Article No.

SIMATIC S7-1500 Software Controller CPU 1507S

For implementing the function of an
S7-1500 Controller on SIMATIC IPC

Target system:

Optimized for
Microbox PC IPC427E
Panel PC IPC477E;
can also be used with
Panel PC IPC277E,
Panel PC IPC477D,
Panel PC IPC677D,
Box PC IPC227E, Box PC IPC427D,
Box PC IPC627D, Box PC IPC827D,
Rack PC IPC647D,
Rack PC IPC847D

Requirement:

Windows 7

Type of delivery:

German, English, Chinese, Italian,
French, Spanish

• Single license for one installation;
software and documentation on
DVD, license key on USB flash
drive

6ES7672-7AC01-0YA0

• Single license for one installation;
software download including
license key ¹⁾

6ES7672-7AC01-0YG0

¹⁾ For up-to-date information and download availability, see:
<http://www.siemens.com/tia-online-software-delivery>

Overview

- Software Controller for implementing the functions of a SIMATIC S7-1500 Controller on a SIMATIC IPC
- Can be used for fail-safe functions up to SIL 3 according to IEC 61508 and up to PLe according to ISO 13849
- Optimized for PC-based control tasks with the IPC427E Microbox PC and the IPC477E Panel PC.
- Can also be used on IPC227E, IPC427D, IPC627D and IPC827D Box PCs, IPC277E, IPC477D and IPC677D Panel PCs, and IPC647D and IPC847D Rack PCs
- C/C++ Runtime for the execution of functions and algorithms implemented in C/C++ under Windows and locally in the CPU 1507S
- Used as a PC-based controller in machines with distributed I/O via PROFINET and PROFIBUS
- Supports PROFIsafe in centralized and distributed configurations
- Use of the IPC onboard interfaces and PC plug-in cards for PROFINET and PROFIBUS connections
- Integrated motion control functionalities for controlling speed-controlled and positioning axes as well as synchronous operation, support for external encoders, precise position gearing between axes, cams/cam tracks and probes
- Integrated web server for diagnostics with the option of creating user-defined web pages

Technical specifications

Article number	6ES7672-7FC01-0YA0 SIMATIC Fail-safe SW Ctrl CPU 1507S F
General information	
Product type designation	CPU 1507S F
Software version	V2.0
Engineering with	
• STEP 7 TIA Portal configurable/ integrated as of version	V14
Memory	
Work memory	
• integrated (for program)	7.5 Mbyte
• integrated (for data)	20 Mbyte
• Integrated (for ODK application)	20 Mbyte
Load memory	
• integrated (on PC mass storage)	320 Mbyte
CPU processing times	
for bit operations, typ.	1 ns; on SIMATIC IPC427D, Intel Core i7 processor, 1.7 GHz
for word operations, typ.	2 ns; on SIMATIC IPC427D, Intel Core i7 processor, 1.7 GHz
for fixed point arithmetic, typ.	2 ns; on SIMATIC IPC427D, Intel Core i7 processor, 1.7 GHz
for floating point arithmetic, typ.	2 ns; on SIMATIC IPC427D, Intel Core i7 processor, 1.7 GHz
CPU-blocks	
Number of elements (total)	6 000; In addition to blocks such as DBs, FBs and FCs, UDTs, global constants, etc. are also regarded as elements
DB	
• Number, max.	5 999; Number range: 1 to 65535
• Size, max.	16 Mbyte
FB	
• Number, max.	5 998; Number range: 1 to 65535
• Size, max.	512 kbyte
FC	
• Number, max.	5 999; Number range: 1 to 65535
• Size, max.	512 kbyte
OB	
• Size, max.	512 kbyte
Nesting depth	
• per priority class	24; Up to 8 possible for F-blocks

Article number	6ES7672-7FC01-0YA0 SIMATIC Fail-safe SW Ctrl CPU 1507S F
Counters, timers and their retentivity	
S7 counter	
• Number	2 048
IEC counter	
• Number	Any (only limited by the main memory)
S7 times	
• Number	2 048
IEC timer	
• Number	Any (only limited by the main memory)
Data areas and their retentivity	
Flag	
• Number, max.	16 kbyte
Address area	
I/O address area	
• Inputs	32 kbyte
• Outputs	32 kbyte
Time of day	
Clock	
• Type	Software clock, synchronizable, no battery backup
Interfaces	
Number of interfaces	3
1. Interface	
Interface type	Onboard PROFINET / IE interface X2 of the SIMATIC IPC, Intel Springville i210T
Interface types	
• Number of ports	1
• integrated switch	No
• RJ 45 (Ethernet)	Yes
- Transmission rate, max.	100 Mbit/s
- Industrial Ethernet status LED	Yes
Functionality	
• Number of connections via this interface	128
• PROFINET IO Controller	Yes
• PROFINET IO Device	Yes
• SIMATIC communication	Yes
• Open IE communication	Yes
• Web server	Yes
PROFINET IO Controller	
Services	
- Isochronous mode	No
- IRT	No
- MRP	No

Software Controllers

SIMATIC S7-1500 Software Controllers Fail-safe CPUs

CPU 1507S F

Technical specifications (continued)

Article number	6ES7672-7FC01-0YA0 SIMATIC Fail-safe SW Ctrl CPU 1507S F
Services (continued)	
- Prioritized startup	Yes; Max. 32 PROFINET devices; if you want to use the "Prioritized startup" functionality in STEP 7 for the PROFINET interface of the CPU, the CPU and the device must be separated by means of a switch (e.g. SCALANCE X205)
- Number of connectable IO Devices, max.	128
- Number of connectable IO Devices for RT, max.	128
- of which in line, max.	128
- Number of IO Devices that can be simultaneously activated/deactivated, max.	8
- IO Devices changing during operation (partner ports), supported	Yes
- Number of IO Devices per tool, max.	8
- Updating times	The minimum value of the update time also depends on communication share set for PROFINET IO, on the number of IO devices, and on the quantity of configured user data
Update time for RT	
- for send cycle of 1 ms	1 ms to 512 ms
PROFINET IO Device	
Services	
- Isochronous mode	No
- IRT	No
- MRP	No
- Prioritized startup	Yes; If you want to use the "Prioritized startup" functionality in STEP 7 for the PROFINET interface of the CPU, the CPU and the device must be separated by means of a switch (e.g. SCALANCE X205)
- Shared device	Yes
- Number of IO Controllers with shared device, max.	4
2. Interface	
Interface type	PROFIBUS with CP 5622, CP 5622 onboard
Interface types	
• RS 485	Yes
Functionality	
• Number of connections via this interface	44
• PROFIBUS DP master	Yes
• PROFIBUS DP slave	No
• SIMATIC communication	Yes; no PG/STEP 7 connection possible
DP master	
Services	
- Equidistance	No
- Isochronous mode	No
- Number of connectable DP slaves, max.	64
3. Interface	
Interface type	PROFIBUS with CP 5623
Interface types	
• RS 485	Yes

Article number	6ES7672-7FC01-0YA0 SIMATIC Fail-safe SW Ctrl CPU 1507S F
Functionality	
• Number of connections via this interface	44
• PROFIBUS DP master	Yes
• PROFIBUS DP slave	No
• SIMATIC communication	Yes; no PG/STEP 7 connection possible
DP master	
Services	
- Equidistance	No
- Isochronous mode	No
- Number of connectable DP slaves, max.	125
Protocols	
Number of connections	
• Number of connections, max.	128
Supported technology objects	
Motion Control	Yes; Note: The number of technology objects affects the cycle time of the PLC program; selection guide via the TIA Selection Tool or SIZER
• Number of available Motion Control resources for technology objects (except cam disks)	4 800
• Required Motion Control resources	
- per speed-controlled axis	40; per axis
- per positioning axis	80; per axis
- per synchronous axis	160; per axis
- per external encoder	80; per external encoder
- per output cam	20; per cam
- per cam track	160; per cam track
- per probe	40; per probe
Controller	
• PID_Compact	Yes; Universal PID controller with integrated optimization
• PID_3Step	Yes; PID controller with integrated optimization for valves
• PID-Temp	Yes; PID controller with integrated optimization for temperature
Counting and measuring	
• High-speed counter	Yes
Standards, approvals, certificates	
Highest safety class achievable in safety mode	
Probability of failure (for service life of 20 years and repair time of 100 hours)	
- Low demand mode: PFDavg in accordance with SIL3	< 2.00E-05
- High demand/continuous mode: PFH in accordance with SIL3	< 1.00E-09 1/h
Hardware requirement	
Hardware required	SIMATIC IPC227E, IPC277E, IPC427D, IPC477D
Processor	
• Single-core processor	No
• Single-core processor with hyper-threading	No
• Multi-core processor	Yes
• Multi-core processor with hyper-threading	Yes
• occupied cores	1; For multicore processors with activated Hyper-Threading, one complete physical core is reserved for the CPU 1507S

Technical specifications (continued)

Article number	6ES7672-7FC01-0YA0 SIMATIC Fail-safe SW Ctrl CPU 1507S F
Lifetime of module	
• Work memory, min.	4 Gbyte
• Hard disk memory required for installation	720 Mbyte
• Temporary hard disk memory for installation	230 Mbyte
• Hard disk memory required at runtime	400 Mbyte
Operating systems	
pre-installed operating system	
• Windows XP	No
• Windows 7	Yes; Professional, Enterprise, Ultimate (32 bits and 64 bits)
• Windows Embedded Standard 7	Yes; With the delivery image of the SIMATIC PC
• Windows 8	No
• Windows Embedded Standard 8	No
Configuration	
Programming	
Programming language	
- LAD	Yes; incl. failsafe
- FBD	Yes; incl. failsafe
- STL	Yes
- SCL	Yes
- GRAPH	Yes

Article number	6ES7672-7FC01-0YA0 SIMATIC Fail-safe SW Ctrl CPU 1507S F
Know-how protection	
• User program protection/password protection	Yes
• Copy protection	Yes
• Block protection	Yes
Access protection	
• Protection level: Write protection	Yes
• Protection level: Read/write protection	Yes
• Protection level: Write protection for Failsafe	Yes
• Protection level: Complete protection	Yes
Open Development interfaces	
• Size of ODK SO file, max.	5.8 Mbyte
Dimensions	
Width	18.2 cm; Packaging
Height	26.5 cm
Depth	3 cm
Weights	
Weight, approx.	200 g

Ordering data

	Article No.	Article No.
SIMATIC S7-1500 Software Controller CPU 1507S F For implementing the function of a fail-safe S7-1500 controller on SIMATIC IPC Target system: Optimized for Microbox PC IPC427E, Panel PC IPC477E; can also be used with Panel PC IPC277E, Panel PC IPC477D, Panel PC IPC677D, Box PC IPC227E, Box PC IPC427D, Box PC IPC627D, Box PC IPC827D, Rack PC IPC647D, Rack PC IPC847D Requirement: Windows 7 / Windows Embedded Standard 7 Type of delivery: German, English, Chinese, Italian, French, Spanish • Single license for one installation; software and documentation on DVD, license key on USB flash drive • Single license for one installation; software download including license key ¹⁾	6ES7672-7FC01-0YA0 6ES7672-7FC01-0YG0	SIMATIC IPC • SIMATIC IPC427E Microbox PC • SIMATIC IPC477E Panel PC • SIMATIC IPC427D Microbox PC • SIMATIC IPC227E Nanobox PC • SIMATIC IPC277E Panel PC • SIMATIC IPC477D Panel PC • SIMATIC IPC677D Panel PC • SIMATIC IPC627D Box PC • SIMATIC IPC827D Box PC • SIMATIC IPC647D Rack PC • SIMATIC IPC847D Rack PC For more information, see Catalog ST 80 / ST PC CP 5622 communications processor PCI Express x1 card (32-bit) for connection of a programming device or PC to PROFIBUS CP 5623 communications processor PCI Express x1 card (32-bit) for connection to PROFIBUS incl. DP-Base software with NCM PC; DP-RAM interface for DP master or DP slave, incl. PG and FDL protocols; single license for 1 installation, runtime software, software and electronic manual on CD-ROM, Class A, for operating system support see SIMATIC NET software; German/English
Accessories Upgrade of SIMATIC S7-1500 Software Controller CPU 1507S Upgrade from V 1.8 to V 2.1; software download incl. documentation and license key. ¹⁾ Email address required for delivery	6ES7672-7AC01-0YK0	6AG4141-.....-.... 6AV7241-.....-.... 6AG4140-.....-.... 6ES7647-8B.....-.... 6AV7882-0...0-...0 6AV7240-.....-.... 6AV7260-.....-.... 6AG4131-2.....-.... 6AG4132-2.....-.... 6AG4112-2.....-.... 6AG4114-2.....-.... 6GK1562-2AA00 6GK1562-3AA00

¹⁾ For up-to-date information and download availability, see: <http://www.siemens.com/tia-online-software-delivery>

Software Controllers

SIMATIC S7-1500 Software Controllers

ODK 1500S

Overview

- For developing dynamically loadable function libraries for S7-1500 Software Controller and S7-1500 CPU 1518 ODK:
 - Implementation of function libraries by means of high-level programming with C/C++.
 - Execution of the library functions under Windows or in the real-time context of the software controllers.
 - Calling the functions directly from the PLC program.
- Development environment for real-time library functions included in the scope of delivery
- Development of Windows library functions with MS Visual Studio.
- Automatic creation of function blocks for calling the library functions.
- Simple integration of the function blocks into STEP 7 by importing.
- Simple use of the library functions in the controller without specific high-level language know-how.

Technical specifications

System requirements

The SIMATIC ODK 1500S can be used on PC platforms with the following requirements:

- Operating systems Windows 7/8.1/10
- Min. 150 MB hard drive memory
- Min. 4 GB work memory
- Mouse, keyboard, monitor

Ordering data

SIMATIC ODK 1500S

Open Development Kit for support in developing Windows and real-time library functions for S7-1500 Software Controllers; supplied on DVD

Open Development Kit for support in developing Windows and real-time library functions for S7-1500 Software Controllers; software download including license key ¹⁾

Email address required for delivery

Article No.

6ES7806-2CD02-0YA0

6ES7806-2CD02-0YG0

¹⁾ For up-to-date information and download availability, see: <http://www.siemens.com/tia-online-software-delivery>

Overview

Note

This catalog entry contains non-binding information on a supplementary application software for the SIMATIC S7-1500 Software Controller and the SIMATIC ET 200SP Open Controller.

Overview

The ODK 1500S SQL driver enables direct access to an SQL database from the PLC program. In this case the database can be installed on the same computer as the S7-1500 Software Controller or in the network.

- Direct data exchange with SQL-based database by means of SQL commands from the PCL program
- Connection to SQL-based database on the same PC or to database servers in the network

Application

Generally the ODK1500S SQL driver can be used in all application scenarios in which an SQL database is required. Typical fields of application are warehouse management, message memory management or recipe management

Technical specifications

Supported SQL commands	<ul style="list-style-type: none"> • SELECT • INSERT • UPDATE • DELETE
Supported data types	All standard SQL data types
System requirements	SIMATIC IPC with S7-1500 Software Controller or SIMATIC ET 200SP Open Controller STEP 7 in the TIA Portal V13 SP1
<ul style="list-style-type: none"> • Runtime PC • Engineering 	

More information

If you are interested, please contact your sales representative:
<http://www.automation.siemens.com/partner/>

You can find Service and Support at:
<https://support.industry.siemens.com/cs/ww/en/view/109479140>

Overview

Note

This catalog entry contains non-binding information on a supplementary application software for the SIMATIC S7-1500 Software Controller and the SIMATIC ET 200SP Open Controller.

Overview

With the function blocks of the ODK 1500S XML Data Access driver it is possible to access specific information in XML files in the Windows file system from the PLC program.

XPath expressions are used for accessing XML file elements since they provide the highest possible flexibility for processing XML data. This means that extremely large XML files can be edited, too.

The driver offers the following functionality:

- XML data can be read into and processed in the PLC.
- XML data can be modified and written back to the XML file.

Application

- Reading in of parameters or recipes that have been made available as XML files by the control system.
- Return of production data which need to be made available in the form of an XML file.

Technical specifications

System requirements	SIMATIC IPC with S7-1500 Software Controller or SIMATIC ET 200SP Open Controller STEP 7 in the TIA Portal V13 SP1
<ul style="list-style-type: none"> • Runtime PC • Engineering 	

More information

If you are interested, please contact your sales representative:
<http://www.automation.siemens.com/partner/>

You can find Service and Support at:
<https://support.industry.siemens.com/cs/ww/en/view/109479496>

Software Controllers

SIMATIC S7-1500 Software Controllers

Add-on applications

ODK 1500S FileServer

Overview

Note

This catalog entry contains non-binding information on a supplementary application software for the SIMATIC S7-1500 Software Controller and the SIMATIC ET 200SP Open Controller.

Overview

The ODK 1500S FileServer enhances the file functions of the SIMATIC S7-1500 Software Controller with an option enabling direct access to the Windows file system of the PC from the STEP 7 program.

The driver enables reading and writing of data blocks in/from files in structured form. Various file formats are supported.

There are also FBs available for handling (e.g. renaming, deleting) files.

Application

Driver blocks enable file operations to be directly integrated in automation solutions, e.g.:

- Writing of measured values to CSV
- Writing of quality data to CSV
- Reading of parameters from INI file
- Reading of recipes from XML file

Technical specifications

Supported file formats	<ul style="list-style-type: none"> • CSV • ASCII • Windows-INI • XML¹⁾ • Binary
System requirements	SIMATIC IPC with S7-1500 Software Controller or SIMATIC ET 200SP Open Controller STEP 7 in the TIA Portal V13 SP1
<ul style="list-style-type: none"> • Runtime PC • Engineering 	

¹⁾ The XML format is predefined. A DB can be saved and read in as an XML file. It is not possible to parse any particular XML file.

More information

If you are interested, please contact your sales representative:
<http://www.automation.siemens.com/partner/>

You can find Service and Support at:
<https://support.industry.siemens.com/cs/ww/en/view/109479497>

Overview

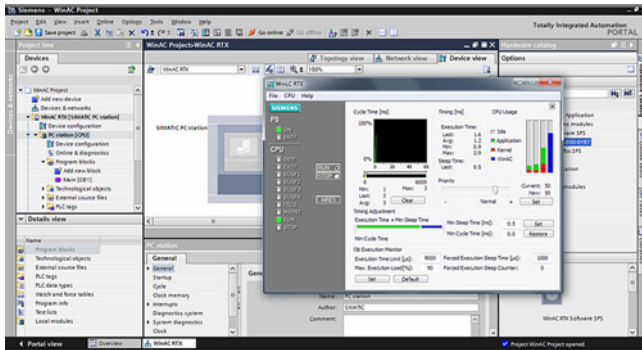

- SIMATIC WinAC RTX: Optimized for applications that require a high degree of flexibility and integration capability.
- The software solution for tasks that require hard deterministic behavior and high performance.
- With real-time expansion for assuring deterministic behavior for the control section.

Technical specifications

Article number	6ES7671-0RC08-0YA0 SIMATIC WINAC RTX 2010
General information	
Product type designation	SIMATIC WinAC RTX 2010
Firmware version	V4.6
Engineering with	
• Programming package	STEP 7 V5.5 or higher / iMAP V3.0 SP1; STEP 7 in TIA Portal V13 or higher
Memory	
Type of memory	RAM
Work memory	
• integrated (for program)	4 Mbyte; Adjustable; depends on Non Paged Memory Pool
• integrated (for data)	4 Mbyte; Adjustable; depends on Non Paged Memory Pool
Load memory	
• integrated RAM, max.	8 Mbyte; Adjustable; depends on Non Paged Memory Pool
CPU processing times	
for bit operations, typ.	0.004 µs; Typical
for fixed point arithmetic, typ.	0.003 µs; Typical
for floating point arithmetic, typ.	0.004 µs; Typical
Reference platform	Pentium 4, 2.4 GHz
CPU-blocks	
DB	
• Number, max.	65 535; Limited only by RAM set for data
• Size, max.	64 kbyte
FB	
• Number, max.	65 536; Limited only by RAM set for code
• Size, max.	64 kbyte
FC	
• Number, max.	65 536; Limited only by RAM set for code
• Size, max.	64 kbyte
OB	
• Size, max.	64 kbyte
Nesting depth	
• per priority class	24
• additional within an error OB	24

Article number	6ES7671-0RC08-0YA0 SIMATIC WINAC RTX 2010
Counters, timers and their retentivity	
S7 counter	
• Number	2 048
Retentivity	
- adjustable	Yes
- lower limit	0
- upper limit	2 047
- preset	8
Counting range	
- can be set	Yes
- lower limit	0
- upper limit	999
IEC counter	
• present	Yes
• Type	SFB
• Number	Unlimited (limited only by RAM capacity)
S7 times	
• Number	2 048
Retentivity	
- adjustable	Yes
- lower limit	0
- upper limit	2 047
- preset	0
Time range	
- lower limit	10 ms
- upper limit	9 990 s
IEC timer	
• present	Yes
• Type	SFB
• Number	Unlimited (limited only by RAM capacity)

Software Controllers

SIMATIC WinAC

SIMATIC WinAC RTX

Technical specifications (continued)

Article number	6ES7671-0RC08-0YA0 SIMATIC WINAC RTX 2010
Data areas and their retentivity	
Retentivity without UPS and PS Extension Board	128 kbyte with SIMATIC IPC427C and HMI IPC477C; further SIMATIC PCs on request
Retentivity with UPS	all data
Flag	
• Number, max.	16 kbyte
• Retentivity preset	MB 0 to MB 15
• Number of clock memories	8
Data blocks	
• Retentivity adjustable	Yes; via non-retain property on DB
• Retentivity preset	Yes
Local data	
• adjustable, max.	64 kbyte
• preset	32 kbyte
• per priority class, max.	61 440 byte
Address area	
I/O address area	
• Inputs	16 kbyte
• Outputs	16 kbyte
of which distributed	
- DP interface, inputs	16 kbyte
- DP interface, outputs	16 kbyte
- PROFINET interface, inputs	16 kbyte
- PROFINET interface, outputs	16 kbyte
Process image	
• Inputs, adjustable	8 kbyte; 16 KB with STEP 7 V5.5 SP3 or higher
• Outputs, adjustable	8 kbyte; 16 KB with STEP 7 V5.5 SP3 or higher
• Inputs, default	512 byte
• Outputs, default	512 byte
Subprocess images	
• Number of subprocess images, max.	15
Digital channels	
• Inputs	128 000
• Outputs	128 000
Analog channels	
• Inputs	8 000
• Outputs	8 000
Number of operable FMs and CPs (recommended)	
• FM	FM distributed: FM 350-1 / 350-2, FM 351, FM 352, FM 353, FM 355 / 355-2
• CP, PtP	2; CP 340, CP 341 distributed
• CP, LAN	Over PC CP
Submodules	
• Number of submodules, max	4
- of which PROFIBUS, max.	4; Supported interfaces: see 1st and 2nd interface
- of which Industrial Ethernet, max.	1; Supported interfaces: see 3rd and 4th interface

Article number	6ES7671-0RC08-0YA0 SIMATIC WINAC RTX 2010
Time of day	
Clock	
• Hardware clock (real-time)	Yes
• retentive and synchronizable	Yes
Operating hours counter	
• Number	8
Clock synchronization	
• supported	Yes
• to PC-CP, slave	Yes
• on Ethernet via NTP	Yes
1. Interface	
Interface type	CP 5611, CP 5611-A2, CP 5612, CP 5621, CP 5622, integrated PROFIBUS interface of the SIMATIC PC
Physics	RS 485 / PROFIBUS
Isolated	Yes
Number of simultaneously operable CPs, max.	1
Power supply to interface (15 to 30 V DC), max.	does not exist
Functionality	
• MPI	No
• PROFIBUS DP master	Yes
• PROFIBUS DP slave	No
DP master	
• Number of connections, max.	8
• Transmission rate, max.	12 Mbit/s
• Number of DP slaves, max.	64
Services	
- PG/OP communication	Yes
- Global data communication	No
- S7 basic communication	No
- S7 communication	Yes
- S7 communication, as client	Yes
- S7 communication, as server	Yes
- Equidistance	Yes; Only in conjunction with isochronous mode
- Isochronous mode	Yes
- SYNC/FREEZE	Yes
- Activation/deactivation of DP slaves	Yes
- Direct data exchange (slave-to-slave communication)	Yes
- DPV1	Yes
Address area	
- Inputs, max.	16 kbyte
- Outputs, max.	16 kbyte
User data per DP slave	
- Inputs, max.	244 byte
- Outputs, max.	244 byte

Technical specifications (continued)

Article number	6ES7671-0RC08-0YA0 SIMATIC WINAC RTX 2010
2. Interface	
Interface type	CP 5613, CP 5613-A2, CP 5613-A3, CP 5603, CP 5623
Physics	RS 485 / PROFIBUS
Isolated	Yes
Number of simultaneously operable CPs, max.	4
Functionality	
• MPI	No
• PROFIBUS DP master	Yes
• PROFIBUS DP slave	No
DP master	
• Number of connections, max.	50
• Transmission rate, max.	12 Mbit/s
• Number of DP slaves, max.	125
Services	
- PG/OP communication	Yes
- Global data communication	No
- S7 basic communication	No
- S7 communication	Yes
- S7 communication, as client	Yes
- S7 communication, as server	Yes
- Equidistance	Yes; Only in conjunction with isochronous mode
- Isochronous mode	Yes
- SYNC/FREEZE	Yes
- Activation/deactivation of DP slaves	Yes
- Direct data exchange (slave-to-slave communication)	Yes
- DPV1	Yes
Address area	
- Inputs, max.	16 kbyte
- Outputs, max.	16 kbyte
User data per DP slave	
- Inputs, max.	244 byte
- Outputs, max.	244 byte
3. Interface	
Interface type	PROFINET
Physics	Ethernet
Isolated	Yes
Number of simultaneously operable CPs, max.	1; Intel Pro/1000 (Intel 82571EB, 82573L, 82574L, 82541PI; non-shared IRQ required); Intel i210T; integrated IE interface SIMATIC PC IPC4x7C, IPC6x7C, IPC8x7C, IPC2x7D, IPC4x7D, IPC6x7D, IPC8x7D, IPC547E
automatic detection of transmission rate	Yes; 10/100 Mbit/s
Autonegotiation	Yes
Autocrossing	Yes
Interface types	
• Number of ports	1
• integrated switch	No
Media redundancy	
• supported	No
Functionality	
• PROFINET IO Controller	Yes
• PROFINET IO Device	No
• PROFINET CBA	Yes
• Open IE communication	Yes

Article number	6ES7671-0RC08-0YA0 SIMATIC WINAC RTX 2010
PROFINET IO Controller	
• Transmission rate, max.	100 Mbit/s
Services	
- PG/OP communication	Yes
- S7 routing	Yes
- S7 communication	Yes
- Isochronous mode	No
- Open IE communication	Yes
- IRT	No
- Prioritized startup	Yes
- Number of IO devices with prioritized startup, max.	32
- Number of connectable IO Devices for RT, max.	128
- of which in line, max.	128
- Activation/deactivation of IO Devices	Yes
- Number of IO Devices that can be simultaneously activated/deactivated, max.	8
- IO Devices changing during operation (partner ports), supported	Yes
- Device replacement without swap medium	Yes
- Send cycles	1 ms
- Updating time	1 to 512 ms (minimum value depends on communication share set for PROFINET I/O, on the number of I/O devices, and on the volume of configured user data)
Address area	
- Inputs, max.	16 kbyte
- Outputs, max.	16 kbyte
- User data per address area, max.	2 kbyte
- User data consistency, max.	256 byte
Open IE communication	
• Number of connections, max.	32
• Local port numbers used at the system end	0, 20, 21, 23, 25, 80, 102, 135, 161, 8080, 34962, 34963, 34964, 65532, 65533, 65534, 65535
• Keep-alive function, supported	Yes
4. Interface	
Interface type	PROFINET
Physics	Ethernet
Isolated	Yes
Number of simultaneously operable CPs, max.	1; CP 1616 (hardware release 8 or higher), CP 1604 (hardware release 7 or higher), integrated PROFINET interface of SIMATIC IPC and S7-mEC
automatic detection of transmission rate	Yes; 10/100 Mbit/s
Autonegotiation	Yes
Autocrossing	Yes
Change of IP address at runtime, supported	Yes
Interface types	
• Number of ports	3
• integrated switch	Yes
Media redundancy	
• supported	Yes
• Switchover time on line break, typ.	200 ms
• Number of stations in the ring, max.	50

Software Controllers

SIMATIC WinAC

SIMATIC WinAC RTX

Technical specifications (continued)

Article number	6ES7671-0RC08-0YA0 SIMATIC WINAC RTX 2010
Functionality	
• PROFINET IO Controller	Yes
• PROFINET IO Device	No
• PROFINET CBA	Yes
• Open IE communication	Yes
PROFINET IO Controller	
• Transmission rate, max.	100 Mbit/s
Services	
- PG/OP communication	Yes
- S7 routing	Yes
- S7 communication	Yes
- Isochronous mode	Yes
- Open IE communication	Yes
- IRT	Yes
- Prioritized startup	Yes
- Number of IO devices with prioritized startup, max.	32
- Number of connectable IO Devices, max.	256
- Of which IO devices with IRT, max.	64
- of which in line, max.	32
- Number of IO Devices with IRT and the option "high flexibility"	64
- of which in line, max.	32
- Number of connectable IO Devices for RT, max.	256
- of which in line, max.	256
- Activation/deactivation of IO Devices	Yes
- Number of IO Devices that can be simultaneously activated/deactivated, max.	8
- IO Devices changing during operation (partner ports), supported	Yes
- Device replacement without swap medium	Yes
- Send cycles	250 µs, 500 µs, 1 ms
- Updating time	0.25...512 depending on the send cycle
Address area	
- User data per address area, max.	2 kbyte
- User data consistency, max.	256 byte
Open IE communication	
• Number of connections, max.	32
• Local port numbers used at the system end	0, 20, 21, 25, 80, 102, 135, 161, 34962, 34963, 34964, 65532, 65533, 65534, 65535
Isochronous mode	
Isochronous operation (application synchronized up to terminal)	Yes
Number of DP masters with isochronous mode	2
User data per isochronous slave, max.	128 byte
Equidistance	Yes
shortest clock pulse	2.2 ms; 2.2 ms without partial process image; 2.2 ms with partial process image

Article number	6ES7671-0RC08-0YA0 SIMATIC WINAC RTX 2010
Communication functions	
PG/OP communication	Yes
Data record routing	Yes; only with CP 5611 or integrated PROFIBUS interface of the SIMATIC PC
Global data communication	
• supported	No
S7 basic communication	
• supported	No
S7 communication	
• supported	Yes
• as server	Yes
• as client	Yes
• User data per job, max.	64 kbyte; when using BSEND/USEND
Open IE communication	
• TCP/IP	Yes
- Number of connections, max.	32
- Data length for connection type 01H, max.	Not supported
- Data length for connection type 11H, max.	65 534 byte
- Data length, max.	65 534 byte
• ISO-on-TCP (RFC1006)	Yes
- Number of connections, max.	32
- Data length, max.	65 534 byte
• UDP	Yes
- Number of connections, max.	32
- Data length, max.	1 472 byte
Web server	
• supported	Yes
• Number of HTTP clients	2
• User-defined websites	No
PROFINET CBA (at set setpoint communication load)	
• Setpoint for the CPU communication load	20 %
• Number of remote interconnection partners	64
• Number of functions, master/slave	30
• Total of all master/slave connections	1 000
• Data length of all incoming connections master/slave, max.	6 800 byte
• Data length of all outgoing connections master/slave, max.	6 800 byte
• Number of device-internal and PROFIBUS interconnections	500
• Data length of device-internal und PROFIBUS interconnections, max.	4 000 byte
• Data length per connection, max.	1 400 byte
Remote interconnections with acyclic transmission	
- Sampling frequency: Sampling time, min.	500 ms
- Number of incoming interconnections	100
- Number of outgoing interconnections	100
- Data length of all incoming interconnections, max.	2 000 byte
- Data length of all outgoing interconnections, max.	2 000 byte
- Data length per connection, max.	1 400 byte

Technical specifications (continued)

Article number	6ES7671-0RC08-0YA0 SIMATIC WINAC RTX 2010
Remote interconnections with cyclic transmission	
- Transmission frequency: Transmission interval, min.	10 ms
- Number of incoming interconnections	200
- Number of outgoing interconnections	200
- Data length of all incoming interconnections, max.	4 800 byte
- Data length of all outgoing interconnections, max.	4 800 byte
- Data length per connection, max.	250 byte
HMI variables via PROFINET (acyclic)	
- Number of stations that can log on for HMI variables (PN OPC/IMap)	3
- HMI variable updating	500 ms
- Number of HMI variables	200
- Data length of all HMI variables, max.	2 000 byte
PROFIBUS proxy functionality	
- supported	Yes
- Number of linked PROFIBUS devices	16
- Data length per connection, max.	240 byte; Slave-dependent
Number of connections	
• overall	96
S7 message functions	
Number of login stations for message functions, max.	62
SCAN procedure	No
Process diagnostic messages	Yes; ALARM_S, ALARM_SQ, ALARM_D, ALARM_DQ
simultaneously active Alarm-S blocks, max.	20; of a total of 20 for all SFCs
Alarm 8-blocks	Yes
• Number of instances for alarm 8 and S7 communication blocks, max.	4 000
Process control messages	No
Test commissioning functions	
Status block	Yes
Single step	Yes
Number of breakpoints	20
Status/control	
• Status/control variable	Yes
Forcing	
• Forcing	No
Diagnostic buffer	
• present	Yes
• Number of entries, max.	
- adjustable	Yes
- preset	120

Article number	6ES7671-0RC08-0YA0 SIMATIC WINAC RTX 2010
Hardware requirement	
Hardware required	PC with color monitor, keyboard, mouse or pointing device for Windows
Processor	
• Processor	Intel Celeron M, 900 MHz or compatible
- Multi-processor system	Yes; Dual Pentium, CoreDuo, Core2Duo or compatible
- Hyper-threading	Yes
Lifetime of module	
• Main memory, min.	1 Gbyte; WES7: 2 GB
• Required memory on hard disk	100 Mbyte
Operating systems	
pre-installed operating system	
• Windows NT 4.0	No
• Windows 2000	No
• Windows Vista	No
• Windows XP	Yes; Professional, SP2 and SP3
• Windows XP Embedded	Yes; With the delivery image of the SIMATIC PC
- supported HAL types under Windows XP	ACPI uniprocessor PC, ACPI multiprocessor PC, MPS multiprocessor PC
• Windows 7	Yes; Professional, Enterprise, Ultimate (only 32 bits)
• Windows Embedded Standard 7	Yes; With delivery image of SIMATIC PC (only 32-bit)
Configuration	
Programming	
• Nesting levels	8
Programming language	
- LAD	Yes
- FBD	Yes
- STL	Yes
- SCL	Yes
- CFC	Yes
- GRAPH	Yes
- HiGraph®	Yes
Software libraries	
- Easy Motion Control	Yes
Know-how protection	
• User program protection/password protection	Yes
• Block encryption	No
Open Development interfaces	
• CCX (Custom Code Extension)	Yes; WinAC ODK V4.2 or higher
• CMI (Controller Management Interface)	Yes; WinAC ODK V4.2 or higher
• SMX (Shared Memory Extension)	Yes; WinAC ODK V4.2 or higher
- Inputs	4 kbyte
- Outputs	4 kbyte
Weights	
Weight, approx.	100 g; With packaging

Software Controllers

SIMATIC WinAC

SIMATIC WinAC RTX

Ordering data	Article No.	Article No.
<p>SIMATIC WinAC RTX 2010</p> <p>Software PLC for PC-based automation tasks with stringent deterministic requirements; PROFIBUS and PROFINET; CD-ROM with electronic documentation d, e, f; executable under Windows XP SP2 and SP3 as well as Windows 7 (32-bit)</p> <ul style="list-style-type: none"> • Single license for one installation; software and documentation on DVD, license key on USB flash drive • Single license for one installation; software download including license key ¹⁾ 	<p>6ES7671-0RC08-0YA0</p> <p>6ES7671-0RC08-0YG0</p>	<p>CP 5613 A3 communications processor</p> <p>PCI card (32-bit; 3.3 V/5 V) for connection to PROFIBUS incl. DP-Base software; DP-RAM interface for DP master, incl. PG and FDL protocols; single license for one installation, runtime software, software and electronic manual on CD-ROM, Class A, for operating system support see SIMATIC NET software V12; English/German</p>
<p>SIMATIC WinAC RTX 2010 Upgrade</p> <p>For upgrading from basic/RTX V3.x, V4.0, V4.1 2005, 2008 and 2009; single license, executable under Windows XP SP2 and SP3 and Windows 7 (32-bit)</p>	<p>6ES7671-0RC08-0YE0</p>	<p>CP 5623 communications processor</p> <p>PCI Express x1 card (32-bit) for connection to PROFIBUS incl. DP-Base software with NCM PC; DP-RAM interface for DP master or DP slave, incl. PG and FDL protocols; single license for 1 installation, runtime software, software and electronic manual on CD-ROM, Class A, for operating system support see SIMATIC NET software; German/English</p>
<p>CP 5612 communications processor</p> <p>PCI card (32-bit) for connection of a programming device or PC to PROFIBUS</p>	<p>6GK1561-2AA00</p>	<p>CP 1616 communications processor</p> <p>PCI card (32-bit; 3.3/5 V universal key) with ASIC ERTEC 400 for connecting PCs to PROFINET IO with 4-port real-time switch (RJ45); incl. IO-Base software for PROFINET IO controller (RT operation) and NCM PC; single license for one installation, runtime software, software and electronic manual on CD-ROM, Class A, for 32-bit Windows XP Professional; German/English</p>
<p>CP 5622 communications processor</p> <p>PCI Express x1 card (32-bit) for connection of a programming device or PC to PROFIBUS</p>	<p>6GK1562-2AA00</p>	<p>6GK1161-6AA02</p>
<p>CP 5603 Microbox Package</p> <p>Comprising CP 5603 module and Microbox expansion rack</p>	<p>6GK1560-3AU00</p>	

¹⁾ For up-to-date information and download availability, see: <http://www.siemens.com/tia-online-software-delivery>

Overview



- SIMATIC WinAC RTX F:
Optimized for applications that demand a high degree of flexibility and integration capability and that must also satisfy safety requirements up to SIL 3 (IEC 61508).
- The software solution for tasks that require hard deterministic behavior and high performance.
- With real-time expansion for assuring deterministic behavior for the control section.
- Distributed I/O can be connected over PROFIBUS and/or PROFINET, also safety-related over PROFI-safe.

Technical specifications

Article number	6ES7671-1RC08-0YA0 SIMATIC WINAC RTX F 2010
General information	
Product type designation	SIMATIC WinAC RTX F 2010
Firmware version	V4.6
Engineering with	
• Programming package	STEP 7 V5.5 or higher + S7 Distributed Safety V5.4 SP5 or higher + S7 F Configuration Pack V5.5 SP6 HF1 / iMap V3.0 SP1; STEP 7 in TIA Portal V13 or higher + STEP 7 Safety Advanced V13
Memory	
Type of memory	RAM
Work memory	
• integrated (for program)	4 Mbyte; Adjustable; depends on Non Paged Memory Pool
• integrated (for data)	4 Mbyte; Adjustable; depends on Non Paged Memory Pool
Load memory	
• integrated RAM, max.	Adjustable; depends on Non Paged Memory Pool
CPU processing times	
for bit operations, typ.	0.004 µs; Typical
for fixed point arithmetic, typ.	0.003 µs; Typical
for floating point arithmetic, typ.	0.004 µs; Typical
Reference platform	Pentium 4, 2.4 GHz
CPU-blocks	
DB	
• Number, max.	65 535; Limited only by RAM set for data
• Size, max.	64 kbyte
FB	
• Number, max.	65 536; Limited only by RAM set for code
• Size, max.	64 kbyte
FC	
• Number, max.	65 536; Limited only by RAM set for code
• Size, max.	64 kbyte
OB	
• Size, max.	64 kbyte

Article number	6ES7671-1RC08-0YA0 SIMATIC WINAC RTX F 2010
Nesting depth	
• per priority class	24
• additional within an error OB	24
Counters, timers and their retentivity	
S7 counter	
• Number	2 048
Retentivity	
- adjustable	Yes
- lower limit	0
- upper limit	2 047
- preset	8
Counting range	
- can be set	Yes
- lower limit	0
- upper limit	999
IEC counter	
• present	Yes
• Type	SFB
• Number	Unlimited (limited only by RAM capacity)
S7 times	
• Number	2 048
Retentivity	
- adjustable	Yes
- lower limit	0
- upper limit	2 047
- preset	0
Time range	
- lower limit	10 ms
- upper limit	9 990 s
IEC timer	
• present	Yes
• Type	SFB
• Number	Unlimited (limited only by RAM capacity)

Software Controllers

SIMATIC WinAC

SIMATIC WinAC RTX F

Technical specifications (continued)

Article number	6ES7671-1RC08-0YA0 SIMATIC WINAC RTX F 2010
Data areas and their retentivity	
Retentivity without UPS and PS Extension Board	128 kbyte with SIMATIC IPC427C and HMI IPC477C; further SIMATIC PCs on request
Retentivity with UPS	all data
Flag	
• Number, max.	16 kbyte
• Retentivity preset	MB 0 to MB 15
• Number of clock memories	8
Data blocks	
• Retentivity adjustable	Yes; via non-retain property on DB
• Retentivity preset	Yes
Local data	
• adjustable, max.	64 kbyte
• preset	32 kbyte
• per priority class, max.	61 440 byte
Address area	
I/O address area	
• Inputs	16 kbyte
• Outputs	16 kbyte
of which distributed	
- DP interface, inputs	16 kbyte
- DP interface, outputs	16 kbyte
- PROFINET interface, inputs	16 kbyte
- PROFINET interface, outputs	16 kbyte
Process image	
• Inputs, adjustable	8 kbyte
• Outputs, adjustable	8 kbyte
• Inputs, default	512 byte
• Outputs, default	512 byte
Subprocess images	
• Number of subprocess images, max.	15
Digital channels	
• Inputs	128 000
• Outputs	128 000
Analog channels	
• Inputs	8 000
• Outputs	8 000
Number of operable FMs and CPs (recommended)	
• FM	4; FM distributed: FM 350-1, FM 350-2, FM 351, FM 352 / FM 352-5, FM 353, FM 354, FM 355, FM 355-2
• CP, PtP	2; CP 340, CP 341 distributed
• CP, LAN	Over PC CP
Submodules	
• Number of submodules, max	4
- of which PROFIBUS, max.	4; Supported interfaces: see 1st and 2nd interface
- of which Industrial Ethernet, max.	1; Supported interfaces: see 3rd and 4th interface

Article number	6ES7671-1RC08-0YA0 SIMATIC WINAC RTX F 2010
Time of day	
Clock	
• Hardware clock (real-time)	Yes
• retentive and synchronizable	Yes
Operating hours counter	
• Number	8
Clock synchronization	
• supported	Yes
• to PC-CP, slave	Yes
• on Ethernet via NTP	Yes
1. Interface	
Interface type	CP 5611-A2, CP 5621, integrated PROFIBUS interface of the SIMATIC PC
Physics	RS 485 / PROFIBUS
Isolated	Yes
Number of simultaneously operable CPs, max.	1
Power supply to interface (15 to 30 V DC), max.	does not exist
Functionality	
• MPI	No
• PROFIBUS DP master	Yes
• PROFIBUS DP slave	No
DP master	
• Number of connections, max.	8
• Transmission rate, max.	12 Mbit/s
• Number of DP slaves, max.	64
Services	
- PG/OP communication	Yes
- Global data communication	No
- S7 basic communication	No
- S7 communication	Yes
- S7 communication, as client	Yes
- S7 communication, as server	Yes
- Equidistance	Yes; Only in conjunction with isochronous mode
- Isochronous mode	Yes
- SYNC/FREEZE	Yes
- Activation/deactivation of DP slaves	Yes
- Direct data exchange (slave-to-slave communication)	Yes
- DPV1	Yes
Address area	
- Inputs, max.	16 kbyte
- Outputs, max.	16 kbyte
User data per DP slave	
- Inputs, max.	244 byte
- Outputs, max.	244 byte
2. Interface	
Interface type	CP 5613, CP 5613-A2, CP 5603, CP 5623
Physics	RS 485 / PROFIBUS
Isolated	Yes
Number of simultaneously operable CPs, max.	4

Technical specifications (continued)

Article number	6ES7671-1RC08-0YA0 SIMATIC WINAC RTX F 2010
Functionality	
• MPI	No
• PROFIBUS DP master	Yes
• PROFIBUS DP slave	No
DP master	
• Number of connections, max.	50
• Transmission rate, max.	12 Mbit/s
• Number of DP slaves, max.	125
Services	
- PG/OP communication	Yes
- Global data communication	No
- S7 basic communication	No
- S7 communication	Yes
- S7 communication, as client	Yes
- S7 communication, as server	Yes
- Equidistance	Yes; Only in conjunction with isochronous mode
- Isochronous mode	Yes
- SYNC/FREEZE	Yes
- Activation/deactivation of DP slaves	Yes
- Direct data exchange (slave-to-slave communication)	Yes
- DPV1	Yes
Address area	
- Inputs, max.	16 kbyte
- Outputs, max.	16 kbyte
User data per DP slave	
- Inputs, max.	244 byte
- Outputs, max.	244 byte
3. Interface	
Interface type	PROFINET
Physics	Ethernet
Isolated	Yes
Number of simultaneously operable CPs, max.	1; Intel Pro/1000 (Intel 82571EB, 82573L, 82574L, 82541PI; non-shared IRQ required); integrated IE interface SIMATIC PC 4x7B, 6x7B, 8x7B, IPC4x7C, IPC6x7C, IPC8x7C
automatic detection of transmission rate	Yes; 10/100 Mbit/s
Autonegotiation	Yes
Autocrossing	Yes
Interface types	
• Number of ports	1
• integrated switch	No
Media redundancy	
• supported	No
Functionality	
• PROFINET IO Controller	Yes
• PROFINET IO Device	No
• PROFINET CBA	Yes
• Open IE communication	Yes

Article number	6ES7671-1RC08-0YA0 SIMATIC WINAC RTX F 2010
PROFINET IO Controller	
• Transmission rate, max.	100 Mbit/s
Services	
- PG/OP communication	Yes
- S7 routing	Yes
- S7 communication	Yes
- Isochronous mode	No
- Open IE communication	Yes
- IRT	No
- Prioritized startup	Yes
- Number of IO devices with prioritized startup, max.	32
- Number of connectable IO Devices, max.	128
- Number of connectable IO Devices for RT, max.	128
- of which in line, max.	128
- Activation/deactivation of IO Devices	Yes
- Number of IO Devices that can be simultaneously activated/deactivated, max.	8
- IO Devices changing during operation (partner ports), supported	Yes
- Device replacement without swap medium	Yes
- Send cycles	1 ms
- Updating time	1 to 512 ms (minimum value depends on communication share set for PROFINET I/O, on the number of I/O devices, and on the volume of configured user data)
Address area	
- Inputs, max.	16 kbyte
- Outputs, max.	16 kbyte
- User data per address area, max.	2 kbyte
- User data consistency, max.	254 byte
Open IE communication	
• Number of connections, max.	32
• Local port numbers used at the system end	0, 20, 21, 23, 25, 80, 102, 135, 161, 8080, 34962, 34963, 34964, 65532, 65533, 65534, 65535
• Keep-alive function, supported	Yes
4. Interface	
Interface type	PROFINET
Physics	Ethernet
Isolated	Yes
Number of simultaneously operable CPs, max.	1; CP 1616 (HW release 8 or above), CP 1604 (HW release 7 or higher), integrated PROFINET interface of SIMATIC PC and S7-mEC
automatic detection of transmission rate	Yes; 10/100 Mbit/s
Autonegotiation	Yes
Autocrossing	Yes
Change of IP address at runtime, supported	Yes
Interface types	
• Number of ports	3
• integrated switch	Yes

Software Controllers

SIMATIC WinAC

SIMATIC WinAC RTX F

Technical specifications (continued)

Article number	6ES7671-1RC08-0YA0 SIMATIC WINAC RTX F 2010
Media redundancy	
• supported	Yes
• Switchover time on line break, typ.	200 ms
• Number of stations in the ring, max.	50
Functionality	
• PROFINET IO Controller	Yes
• PROFINET IO Device	No
• PROFINET CBA	Yes
• Open IE communication	Yes
PROFINET IO Controller	
• Transmission rate, max.	100 Mbit/s
Services	
- PG/OP communication	Yes
- S7 routing	Yes
- S7 communication	Yes
- Isochronous mode	Yes
- Open IE communication	Yes
- IRT	Yes
- Prioritized startup	Yes
- Number of IO devices with prioritized startup, max.	32
- Number of connectable IO Devices, max.	256
- Of which IO devices with IRT, max.	64
- of which in line, max.	64
- Number of IO Devices with IRT and the option "high flexibility"	64
- of which in line, max.	32
- Number of connectable IO Devices for RT, max.	256
- of which in line, max.	256
- Activation/deactivation of IO Devices	Yes
- Number of IO Devices that can be simultaneously activated/deactivated, max.	8
- IO Devices changing during operation (partner ports), supported	Yes
- Device replacement without swap medium	Yes
- Send cycles	250 µs, 500 µs, 1 ms
- Updating time	0.25...512 depending on the send cycle
Address area	
- User data per address area, max.	2 kbyte
- User data consistency, max.	254 byte
Open IE communication	
• Number of connections, max.	32
• Local port numbers used at the system end	0, 20, 21, 25, 80, 102, 135, 161, 34962, 34963, 34964, 65532, 65533, 65534, 65535
Isochronous mode	
Isochronous operation (application synchronized up to terminal)	Yes
Number of DP masters with isochronous mode	2
User data per isochronous slave, max.	128 byte
Equidistance	Yes
shortest clock pulse	2.2 ms; 2.2 ms without partial process image; 2.2 ms with partial process image

Article number	6ES7671-1RC08-0YA0 SIMATIC WINAC RTX F 2010
Communication functions	
PG/OP communication	Yes
Data record routing	Yes; only with CP 5611 or integrated PROFIBUS interface of the SIMATIC PC
Global data communication	
• supported	No
S7 basic communication	
• supported	No
S7 communication	
• supported	Yes
• as server	Yes
• as client	Yes
• User data per job, max.	64 kbyte; Depends on which block is used: BSEND/USEND or PUT/GET
Open IE communication	
• TCP/IP	Yes
- Number of connections, max.	32
- Data length for connection type 01H, max.	Not supported
- Data length for connection type 11H, max.	65 534 byte
- Data length, max.	65 534 byte
• ISO-on-TCP (RFC1006)	Yes
- Number of connections, max.	32
- Data length, max.	65 534 byte
• UDP	Yes
- Number of connections, max.	32
- Data length, max.	1 472 byte
Web server	
• supported	Yes
• Number of HTTP clients	2
• User-defined websites	No
PROFINET CBA (at set setpoint communication load)	
• Setpoint for the CPU communication load	20 %
• Number of remote interconnection partners	64
• Number of functions, master/slave	30
• Total of all master/slave connections	1 000
• Data length of all incoming connections master/slave, max.	6 800 byte
• Data length of all outgoing connections master/slave, max.	6 800 byte
• Number of device-internal and PROFIBUS interconnections	500
• Data length of device-internal und PROFIBUS interconnections, max.	4 000 byte
• Data length per connection, max.	1 400 byte
Remote interconnections with acyclic transmission	
- Sampling frequency: Sampling time, min.	500 ms
- Number of incoming interconnections	100
- Number of outgoing interconnections	100
- Data length of all incoming interconnections, max.	2 000 byte
- Data length of all outgoing interconnections, max.	2 000 byte
- Data length per connection, max.	1 400 byte

Technical specifications (continued)

Article number	6ES7671-1RC08-0YA0 SIMATIC WINAC RTX F 2010
Remote interconnections with cyclic transmission	
- Transmission frequency: Transmission interval, min.	10 ms
- Number of incoming interconnections	200
- Number of outgoing interconnections	200
- Data length of all incoming interconnections, max.	4 800 byte
- Data length of all outgoing interconnections, max.	4 800 byte
- Data length per connection, max.	250 byte
HMI variables via PROFINET (acyclic)	
- Number of stations that can log on for HMI variables (PN OPC/IMap)	3
- HMI variable updating	500 ms
- Number of HMI variables	200
- Data length of all HMI variables, max.	2 000 byte
PROFIBUS proxy functionality	
- supported	Yes
- Number of linked PROFIBUS devices	16
- Data length per connection, max.	240 byte; Slave-dependent
Number of connections	
• overall	96
S7 message functions	
Number of login stations for message functions, max.	62
SCAN procedure	No
Process diagnostic messages	Yes; ALARM_S, ALARM_SQ, ALARM_D, ALARM_DQ
simultaneously active Alarm-S blocks, max.	20; of a total of 20 for all SFCs
Alarm 8-blocks	Yes
• Number of instances for alarm 8 and S7 communication blocks, max.	4 000
Process control messages	No
Test commissioning functions	
Status block	Yes
Single step	Yes
Number of breakpoints	20
Status/control	
• Status/control variable	Yes
Forcing	
• Forcing	No
Diagnostic buffer	
• present	Yes
• Number of entries, max.	
- adjustable	Yes
- preset	120
Hardware requirement	
Hardware required	PC with color monitor, keyboard, mouse or pointing device for Windows

Article number	6ES7671-1RC08-0YA0 SIMATIC WINAC RTX F 2010
Processor	
• Processor	Intel Celeron M 900 MHz or compatible (older PC systems with Programmable Interrupt Controllers (PIC) are not suitable for WinAC RTX F 2010.)
- Multi-processor system	No
- Hyper-threading	Yes
Lifetime of module	
• Main memory, min.	1 Gbyte
• Required memory on hard disk	100 Mbyte
Operating systems	
pre-installed operating system	
• Windows NT 4.0	No
• Windows 2000	No
• Windows Vista	No
• Windows XP	Yes; Professional, SP2 and SP3
• Windows XP Embedded	Yes; With the delivery image of the SIMATIC PC
- supported HAL types under Windows XP	ACPI uniprocessor PC, ACPI multiprocessor PC, MPS multiprocessor PC
• Windows 7	Yes; Professional, Enterprise, Ultimate (only 32 bits)
• Windows Embedded Standard 7	No
Configuration	
Programming	
• Nesting levels	8
Programming language	
- LAD	Yes
- FBD	Yes
- STL	Yes
- SCL	Yes
- CFC	Yes
- GRAPH	Yes
- HiGraph®	Yes
Software libraries	
- Easy Motion Control	Yes
Know-how protection	
• User program protection/password protection	Yes
• Block encryption	No
Open Development interfaces	
• CCX (Custom Code Extension)	Yes; WinAC ODK V4.2 or higher
• CMI (Controller Management Interface)	Yes; WinAC ODK V4.2 or higher
• SMX (Shared Memory Extension)	Yes; WinAC ODK V4.2 or higher
- Inputs	4 kbyte
- Outputs	4 kbyte
Weights	
Weight, approx.	100 g; With packaging

Software Controllers

SIMATIC WinAC

SIMATIC WinAC RTX F

Ordering data	Article No.	Ordering data	Article No.
<p>SIMATIC WinAC RTX F 2010</p> <p>Fail-safe software PLC for PC-based automation tasks with stringent deterministic requirements; PROFIBUS and PROFINET; DVD with electronic documentation d, e; executable under Windows XP SP2 and SP3 as well as Windows 7 (32-bit)</p> <ul style="list-style-type: none"> • Single license for one installation; software and documentation on DVD, license key on USB flash drive • Single license for one installation; software download including license key ¹⁾ 	<p>6ES7671-1RC08-0YA0</p> <p>6ES7671-1RC08-0YG0</p>	<p>CP 5613 A3 communications processor</p> <p>PCI card (32-bit; 3.3 V/5 V) for connection to PROFIBUS incl. DP-Base software; DP-RAM interface for DP master, incl. PG and FDL protocols; single license for one installation, runtime software, software and electronic manual on CD-ROM, Class A, for operating system support see SIMATIC NET software V12; English/German</p>	<p>6GK1561-3AA02</p>
<p>SIMATIC WinAC RTX F 2010 upgrade</p> <p>For upgrading from WinAC RTX F version 2009; single license, executable under Windows XP SP2 and SP3 and Windows 7 (32-bit)</p>	<p>6ES7671-1RC08-0YE0</p>	<p>CP 5623 communications processor</p> <p>PCI Express x1 card (32-bit) for connection to PROFIBUS incl. DP-Base software with NCM PC; DP-RAM interface for DP master or DP slave, incl. PG and FDL protocols; single license for 1 installation, runtime software, software and electronic manual on CD-ROM, Class A, for operating system support see SIMATIC NET software; German/English</p>	<p>6GK1562-3AA00</p>
<p>CP 5612 communications processor</p> <p>PCI card (32-bit) for connection of a programming device or PC to PROFIBUS</p>	<p>6GK1561-2AA00</p>	<p>CP 1616 communications processor</p> <p>PCI card (32-bit; 3.3/5 V universal key) with ASIC ERTEC 400 for connecting PCs to PROFINET IO with 4-port real-time switch (RJ45); incl. IO-Base software for PROFINET IO controller (RT operation) and NCM PC; single license for one installation, runtime software, software and electronic manual on CD-ROM, Class A, for 32-bit Windows XP Professional; German/English</p>	<p>6GK1161-6AA02</p>
<p>CP 5622 communications processor</p> <p>PCI Express x1 card (32-bit) for connection of a programming device or PC to PROFIBUS</p>	<p>6GK1562-2AA00</p>		
<p>CP 5603 Microbox Package</p> <p>Comprising CP 5603 module and Microbox expansion rack</p>	<p>6GK1560-3AU00</p>		

¹⁾ For up-to-date information and download availability, see: <http://www.siemens.com/tia-online-software-delivery>

Overview



- SIMATIC WinAC software PLCs support powerful interfaces which permit close meshing of the control task with PC-based applications.
- WinAC ODK allows the user to develop applications or to integrate already existing applications into the control task.

Technical specifications

Article number	6ES7806-1CC03-0BA0 SIMATIC WINAC ODK V4.2
General information	
Product type designation	SIMATIC WinAC ODK V4.2 SP1
Hardware requirement	
Hardware required	PC with color monitor, keyboard, mouse or pointing device for Windows
Processor	
• Processor	Intel Pentium 800 MHz
Lifetime of module	
• Main memory, min.	1 Gbyte
• Required memory on hard disk	30 Mbyte
Operating systems	
pre-installed operating system	
• Windows XP	Yes; Professional, SP2 and SP3
• Windows 7	Yes; Professional, Enterprise, Ultimate (only 32 bits)
Open Development interfaces	
• CCX (Custom Code Extension)	Yes; See product information: http://support.automation.siemens.com/WW/view/en/48207241
• CMI (Controller Management Interface)	Yes; See product information: http://support.automation.siemens.com/WW/view/en/48207241
• SMX (Shared Memory Extension)	Yes; See product information: http://support.automation.siemens.com/WW/view/en/48207241
Weights	
Weight, approx.	200 g

Ordering data

Article No.

SIMATIC WinAC ODK V4.2

For integration of C/C++ code in WinAC PLCs, executable under Windows XP SP2 or SP3; CD-ROM with electronic documentation

Single license

6ES7806-1CC03-0BA0

Software Controllers

Notes

I/O systems

**9/3 Introduction****9/4 SIMATIC ET 200 systems for the control cabinet****9/4 SIMATIC ET 200SP**Interface modules

9/7 IM 155-6

9/13 SIPLUS interface modules9/15 I/O modules

9/15 Digital input modules

9/24 Digital output modules

9/36 Analog input modules

9/51 Analog output modules

9/57 SIPLUS digital inputs

9/59 SIPLUS digital outputs

9/63 SIPLUS analog inputs

9/67 SIPLUS analog outputs

9/69 Technology modules

9/69 • TM Count 1x24V counter module

9/72 • TM PosInput 1 counting and position detection module

9/76 • TM Timer DIDQ 10x24V time-based I/O module

9/79 • TM Pulse 2x24V pulse output module

9/82 • SIWAREX WP321

9/84 Communication

9/84 • CM PtP serial interface

9/86 • CM 4x IO-Link

9/89 • CM AS-i Master ST for SIMATIC ET 200SP

9/92 • CM DP for ET 200SP CPU

9/94 • CP 1542SP-1

9/97 • CP 1543SP-1

9/100 • CP 1542SP-1 IRC

9/104 • SCALANCE W761 RJ45

for the control cabinet

9/107 • SCALANCE W722 RJ45

for the control cabinet

9/110 • SCALANCE W721 RJ45

for the control cabinet

9/113 • SIPLUS CM DP for ET 200SP CPU

9/114 Fail-safe I/O modules

9/114 • Digital F input modules

9/117 • Digital F output modules

9/120 • Digital F output module relay

9/122 • Fail-safe special modules

9/124 • SIPLUS digital F input modules

9/126 • SIPLUS digital F output modules

9/128 • SIPLUS fail-safe special modules

9/130 • Fail-safe communication

9/130 - F-CM AS-i Safety ST for SIMATIC ET 200SP

9/132 ET 200SP motor starters

9/140 BaseUnits9/143 SIPLUS BaseUnits9/147 BusAdapters9/150 SIPLUS BusAdapters9/152 Accessories**9/154 SIMATIC ET 200MP**Interface modules

9/155 IM 155-5 PN

9/160 IM 155-5 DP

9/162 SIPLUS IM 155-5 PN

9/163 I/O modules**9/164 SIMATIC ET 200M**Interface modules

9/165 IM 153-1/153-2

9/168 IM 153-4 PN

9/171 SIPLUS ET 200M IM 153-1/153-2

9/174 SIPLUS ET 200M IM 153-4 PN IO

I/O modules

9/175 Digital modules, Analog modules

9/176 Analog modules with HART

9/176 • Analog input module with HART

9/178 • Analog output module with HART

9/180 • Ex analog input module with HART

9/182 • Ex analog output module with HART

9/184 • SIPLUS S7-300 analog input module with HART

9/185 • SIPLUS S7-300 analog output module with HART

9/186 • SIPLUS S7-300 Ex analog input module with HART

9/187 F digital/analog modules

9/188 Function modules

9/190 Communication

9/191 Power supplies**9/192 SIMATIC ET 200iSP**

9/193 Power supply unit

9/195 Interface module

9/197 Digital electronics modules

9/205 Analog electronics modules

9/212 Safety-related electronics modules

9/217 Watchdog module

9/218 RS 485-iS coupler

9/220 Stainless steel wall enclosure

Brochures

For brochures serving as selection guides for SIMATIC products, refer to:

www.siemens.com/simatic/printmaterial

I/O systems

9/226 SIMATIC ET 200 systems without control cabinet
9/226 SIMATIC ET 200pro

- 9/227 Interface modules
- 9/227 IM 154-1 and IM 154-2
- 9/231 IM 154-4 PN
- 9/234 I/O modules
- 9/234 Digital expansion modules
- 9/241 Analog expansion modules
- 9/248 Communication
 - IO-Link master modules
- 9/249 Fail-safe expansion modules
 - Fail-safe digital expansion modules
- 9/251 PM-E power module
- 9/253 PM-O power module output
- 9/254 ET 200pro pneumatic interface
- 9/256 RF170C
- 9/258 Power supplies
- 9/258 3-phase, 24 V DC (ET 200pro PS, IP67)
- 9/260 ET 200pro motor starters
- 9/260 General data
- 9/265 Standard motor starters
- 9/266 High Feature motor starters
- 9/267 ET 200pro isolator modules
- 9/268 ET 200pro Safety motor starters
- Solutions local/PROFIsafe
- 9/268 Safety modules local
- 9/271 Safety modules PROFIsafe
- 9/272 Accessories for ET 200pro motor starters
- 9/277 SIMATIC ET 200pro FC-2 frequency converter
- 9/280 ET 200pro software
- 9/280 Motor Starter ES
- 9/283 Add-on products for ET 200pro
- 9/283 EtherNet/IP interface module

9/284 SIMATIC ET 200AL

- 9/285 Interface modules
- 9/285 IM 157-1 DP
- 9/287 IM 157-1 PN
- 9/289 I/O modules
- 9/289 Digital I/O modules
- 9/296 Analog I/O modules
- 9/300 Communication
 - CM IO-Link
- 9/303 Accessories
- 9/303 Cables and connectors
- 9/315 Labels

9/316 SIMATIC ET 200eco PN
9/330 ET 200eco PN IO-Link master
9/334 I/O systems for heating units
9/334 Introduction
9/335 with integrated power outputs – compact design

- 9/335 SIPLUS HCS3200 heating control system

9/338 with integrated power outputs – modular design

- 9/338 SIPLUS HCS4200 heating control system
- 9/339 Rack
- 9/341 Central Interface Module (CIM)
- 9/344 Power Output Module (POM)
- 9/348 SIPLUS HCS4300 heating control system
- 9/349 Central Interface Module (CIM)
- 9/352 Power Output Module (POM)

9/356 PROFIBUS components

- 9/356 Power Rail Booster
- 9/357 Diagnostics
 - Diagnostics repeater for PROFIBUS DP
 - SIPLUS diagnostics repeater for PROFIBUS
- 9/361 PROFIBUS DP ASICs
- 9/363 Connections/interfaces
- 9/364 Development kits

9/365 PROFINET components

- 9/365 Enhanced Real-Time Ethernet Controllers ERTEC
- 9/367 Development kits
- 9/368 PROFINET Driver

9/369 Network components for PROFIBUS Electrical networks (RS 485)

- 9/369 Active RS 485 terminating element
- 9/370 RS 485 repeater for PROFIBUS
- 9/371 SIPLUS DP active RS 485 terminating element
- 9/372 SIPLUS RS 485 repeater

9/373 Network transitions

- 9/373 PN/PN coupler
- 9/375 PN/CAN LINK
- 9/377 DP/DP coupler
- 9/378 IE/AS-i Link PN IO

Overview

**SIMATIC ET 200 offers the right solution for every application**

With SIMATIC ET 200 a wide range of distributed I/O systems is available - for solutions in the control cabinet or without a control cabinet directly at the machine, as well as for applications in hazardous areas. The modular design makes it possible to scale and expand the ET 200 systems simply and in small stages. Already integrated add-on modules reduce costs and at the same time offer a widely diverse range of possible applications. You can choose from many different combination options: digital and analog inputs/outputs, intelligent modules with CPU functionality, safety systems, motor starters, pneumatic devices, frequency converters, as well as various different technology modules (e.g. for counting, positioning).

Communication over PROFINET and PROFIBUS, uniform engineering, transparent diagnostic possibilities as well as optimal interfacing to SIMATIC controllers and HMI units prove the unique integration of Totally Integrated Automation.

PROFINET

PROFINET is the open, cross-vendor Industrial Ethernet standard (IEC 61158/61784) for automation.

Based on Industrial Ethernet, PROFINET enables direct communication between field devices (IO devices) and controllers (IO Controllers), up to and including the solution of isochronous drive controls for motion control applications.

As PROFINET is based on Standard Ethernet according to IEEE 802.3, any devices from the field level to the management level can be connected.

In this way, PROFINET enables system-wide communication, supports plant-wide engineering and applies IT standards, such as web server or FTP, right down to field level. Tried and tested fieldbus systems, such as PROFIBUS or AS-Interface, can be easily integrated without any modification to the existing devices.

PROFIBUS

PROFIBUS is the international standard (IEC 61158/61784) for the field level. It is the only fieldbus to allow communication both in manufacturing applications and in process-oriented applications.

PROFIBUS is used to connect field devices, e.g. distributed I/O devices or drives, to automation systems such as SIMATIC S7, SIMOTION, SINUMERIK, or PCs.

PROFIBUS is standardized in accordance with IEC 61158 and is a powerful, open and rugged fieldbus system with short response times. PROFIBUS is available in different forms for various applications.

PROFIBUS DP (Distributed I/O)

PROFIBUS DP is used for connecting distributed field devices, e.g. SIMATIC ET 200, or drives with extremely fast response times. PROFIBUS DP is used when sensors or actuators are distributed at the machine or in the plant (e.g. field level).

AS-Interface

AS-Interface is the international standard (IEC 62026/EN 50295) which, as an alternative to the cable harness, links especially cost-effective sensors and actuators by means of a two-wire line. This two-wire line is also used to supply the individual stations with power. This makes the AS-Interface the ideal partner for PROFINET and PROFIBUS DP. AS-i communication modules in the ET 200SP enable the flexible combination of AS-Interface and distributed I/Os. AS-Interface transmits standard data and safety data up to PL e / SIL 3 in the same AS-i network. AS-Interface is not only suitable for efficient transmission of digital and analog I/O signals but also ideal for the user-friendly connection of EMERGENCY STOP pushbuttons and protective doors.

IO-Link

The communication standard IO-Link permits the intelligent connection of sensors and switching devices to the control level. IO-Link facilitates the integration of all components in the control cabinet and on the field level - for maximum integration and seamless communication on the final meters to the process.

IO-Link solutions from Siemens ensure maximum precision and cost-effectiveness in any production system. IO-Link is completely integrated in Totally Integrated Automation (TIA) and offers many advantages.

- The open standard permits the networking of devices from different manufacturers
- Simple wiring facilitates the installation process
- Reduced wiring effort saves time and money during installation
- Efficient engineering facilitates configuration and commissioning
- High-speed diagnostics ensures short plant standstill times and high plant availability
- High process transparency permits, for example, efficient power management

I/O systems

SIMATIC ET 200 systems for the control cabinet

SIMATIC ET 200SP

Overview

SIMATIC ET 200SP



The scalable SIMATIC ET 200SP I/O system is a highly flexible, modular I/O system with IP20 degree of protection. Via an interface module with PROFINET or PROFIBUS interface it can exchange IO data of the connected I/O modules with a higher-level control system. Alternatively, as further head-end stations, various PLC, F-PLC and Open Controllers are available as compact S7-1500 controllers (distributed controllers). ET 200SP components are available as SIPLUS version for extreme requirements and a high degree of robustness.

Compact design

- Modular configuration with up to 64 modules
- System-integrated self-assembling load group supply without power module via light BaseUnits
- Small size and highly flexible due to the modular design and comprehensive product range
- Up to 16 channels per module
- Permanent wiring
- Hot swapping: Module replacement without tools in RUN
- Operation with gaps

Flexible connection system

- Push-in terminals for cross-sections up to 1.5 mm² with wire end ferrule, and up to 2.5 mm² without wire end ferrule
- BaseUnits for 1-wire or direct multi-wire connection
- Optimum accessibility for wiring due to spring release and measuring tap next to the conductor opening
- Flexible PROFINET connection via BusAdapter (RJ45, FastConnect, plastic or glass fiber-optic cables), also as integrated media converter

Safety Integrated

- Easy integration of fail-safe modules
- Easy F parameter assignment via software
- Group-by-group disconnection of non-fail-safe modules

High performance

- Isochronous PROFINET
- Internal data transfer with up to 100 Mbps
- Record analog values and output as of 50 µs
- Record digital values and output as of 1 µs

High-performance technology

- Modules for the functions Counting, Positioning, Weighing

Energy efficiency

- Energy meter for recording electrical variables
- System-integrated PROFenergy with interval substitute values

Advanced functions

- Configuration control: application-based adaptation of the actual configuration via user software (option handling)
- Time-based IO: time stamping of the signals to the µs
- MSI/MSO: Simultaneous access to I/O data from up to 4 PLCs
- Oversampling: n-fold acquisition or output of digital and analog signals within a PN cycle
- Adaptation of measuring range: increased resolution by adapting the measuring range to a limited section of a measuring range supported by the analog input module
- Scaling of measured values: permits the transmission of the analog value normalized to the required physical value as a REAL value (32-bit floating point)

Communication standards

- PROFINET IO
- PROFIBUS DP V0/V1
- ET connection for connecting the ET 200AL (IP67)
- IO-Link V1.1
- AS-Interface
- Point-to-point (RS 232, RS 485, RS 422)

CPU

- PROFINET connection with 3 ports
- IO controller and PN IO device
- Optional expansion as DP master/slave
- Also as fail-safe version and Open Controller

Labeling of I/O modules

- Meaningful labeling on the front of the I/O modules
- Optionally expandable with
 - Labeling strips
 - Equipment labeling plate

Overview (continued)

Overview of ET 200SP components

Basic components	Function
DIN rail according to EN 60715	The DIN rail is the module support of the ET 200SP. The ET 200SP is mounted on the DIN rail.
CPU	<p>The CPU:</p> <ul style="list-style-type: none"> • executes the user program • is used as IO controller, I-device on PROFINET IO, or as stand-alone CPU • connects the ET 200SP with the IO devices or the IO controller • exchanges data with the I/O modules via the backplane bus <p>Further functions of the CPU:</p> <ul style="list-style-type: none"> • Communication via PROFIBUS DP (in combination with the CM DP communication module, the CPU can be used as DP master or slave) • Integrated web server • Integrated technology • Integrated trace functionality • Integrated system diagnostics • Integrated safety
Open controller	<p>As the first controller of this type, the SIMATIC ET 200SP Open Controller combines the functions of a PC-based software controller with visualization, PC applications and central I/Os (inputs/outputs) in a single, compact device.</p> <ul style="list-style-type: none"> • All in one • High system availability • Compact and modular • Rugged • User-friendly design • Efficient engineering in the TIA Portal
Interface module for PROFINET IO (IM 155-6PN)	<p>The interface module:</p> <ul style="list-style-type: none"> • is used as IO device on the PROFINET IO • connects the ET 200SP with the IO controller • exchanges data with the I/O modules via the backplane bus
Interface module for PROFIBUS DP (IM 155-6DP)	<p>The interface module:</p> <ul style="list-style-type: none"> • is used as DP slave on the PROFIBUS DP • connects the ET 200SP with the DP master • exchanges data with the I/O modules via the backplane bus
BusAdapter (BA)	<p>BusAdapters permit the free selection of the connection method and connection technology for head-end stations with PROFINET interface.</p> <p>Various versions are available for the connection of copper cables or plastic and glass fiber-optic cables. Hybrid copper/fiber-optic versions are also available as integrated media converters.</p> <p>Cable length between 2 stations: max. 100 m (Cu), max. 50 m (POF), max. 100 m (PCF), max. 3 km (glass FOC).</p> <p>For expanding the station with the I/O systems ET 200AL via ET connection, the BA-Send BusAdapter is available.</p>

Basic components	Function
BaseUnit (BU)	<p>The BaseUnits provide the electrical and mechanical connection for the ET 200SP components.</p> <ul style="list-style-type: none"> • Bright BaseUnits permit a new potential group up to max. 10 A • Dark BaseUnits forward the self-assembling voltage busbars P1, P2 and AUX from the left to the right BaseUnit • Suitable BaseUnits with 12 to 28 terminals are available for different connection systems (single or direct multi-conductor connection) and functions • The I/O module is plugged onto the desired BaseUnit and determines the potential assignment of the terminals on the BaseUnit • For expanding the station with the I/O systems ET 200AL via ET connection, the BaseUnit BU-Send is available
I/O modules and fail-safe I/O modules	<p>The I/O module determines the function at the terminals. The controller detects the current process state via the connected sensors and triggers corresponding responses via the connected actuators.</p> <p>Some I/O modules feature extended functions, in part they are also designed as individual operating mode. I/O modules are divided into the following module types; the fail-safe versions are identified by a preceding "F-" and a yellow module enclosure.</p> <ul style="list-style-type: none"> • DI (digital input) • DQ (digital output) • AI (analog input) • AQ (analog output) • TM (technology modules) • CM (communication modules) • SM (special modules)
Protective cover (BU cover)	<p>The ET 200SP system can be operated with any number of slot gaps (BU slot without I/O module). Applications for this include:</p> <ul style="list-style-type: none"> • partial commissioning • pre-wired, and currently unequipped options <p>To protect against damage, such slot gaps must be covered by a BU cover. Within the BU cover, an equipment labeling plate can be kept for the possible later use of an I/O module.</p> <p>Versions:</p> <ul style="list-style-type: none"> • for BaseUnits with a width of 15 mm • for BaseUnits with a width of 20 mm
Server module	<p>The server module concludes the setup of an ET 200SP station. On the server module there are holders for 3 spare fuses (5 × 20 mm). The server module is included in the scope of delivery of all head-end stations.</p>

I/O systems

SIMATIC ET 200 systems for the control cabinet

SIMATIC ET 200SP

Overview (continued)

Basic components	Function
Coding element	<p>When plugging an I/O module onto a BaseUnit for the first time, the coding element moves from the I/O module to the BaseUnit. There it prevents the destruction of the ET 200SP components in the event of a subsequent module replacement with incorrectly selected I/O module.</p> <p>The coding element is available in two versions:</p> <ul style="list-style-type: none"> • Mechanical coding element • Electronic coding element: Additionally features an electronic, re-writable memory for the redundant storage of module-specific configuration data (e.g. F target address for fail-safe modules, parameter data for IO-Link master). Thus these data are automatically backed up during a module replacement
Shield connection	<p>The shield connection permits the connection of cable shields. Compared to external shield supports, the system offers the following advantages:</p> <ul style="list-style-type: none"> • Quick installation without tools by plugging the shield connection element onto the BaseUnit • Automatic low-impedance connection to the functional ground (DIN rail) • Optimized EMC properties by separating the supply voltage lines from the signal lines by means of the shield connection element and short, unshielded cable lengths • Low space requirements
Labeling strips	<p>Optionally, for system-specific marking the head-end stations and I/O modules can be equipped with labeling strips (13 x 31 mm). The labeling strips can be inscribed mechanically. Labeling strips are available in two versions in the colors light gray and yellow:</p> <ul style="list-style-type: none"> • 500 strips on the roll, for printing on thermal transfer printers. Core diameter 40 mm, external diameter 70 mm, width 62 mm • 10 DIN A4 sheets with 100 strips each, card 180 g/mm², perforated, for printing with a laser printer direct from TIA Portal or via print templates

Basic components	Function
Equipment labeling plate	<p>Optionally, one equipment labeling plate each can be plugged onto head-end stations, BusAdapters, BaseUnits, and I/O modules. Equipment labeling plates are supplied in packs of 10 sheets with 16 labels each. The labels can be printed with thermal transfer card printers or plotters, or stickers can be attached to them. Advantages compared to labels that are attached directly:</p> <ul style="list-style-type: none"> • The inscription on the front is not covered • Simple label replacement when replacing a module • No parallax errors when marking the BaseUnits on the mounting plate <p>The size of the inscribable area of the labels is 14.8 x 10.5 mm (W x H)</p>
Color-coded labels	<p>The I/O modules that are plugged onto the BaseUnits determine the potentials connected at the process terminals. The +/- potentials can optionally be identified using module-specific color-coded labels. The potentials of the AUX and add-on terminals can also be marked using color-coded labels. Advantages of the color-coded labels:</p> <ul style="list-style-type: none"> • Quick installation (one label for marking 16 terminals) • Avoidance of wiring errors • Simple detection of potentials during servicing

Overview



Thanks to their wide scope of functions, the interface modules of the scalable SIMATIC ET 200SP I/O system, even in their basic versions, cover a wide range of applications. The basic functions of the interface modules include:

- Short data update times of typically 1 ms
- Single Hot Swap (withdrawing and insertion of an I/O module during operation without impairing the communication with the remaining modules)
- Operation with gaps (empty BaseUnits)
- Complete diagnostic support, extending to channel-by-channel diagnostics
- Configuration control / option handling (adaptation of the actual configuration via user software)
- Device replacement without programming device
- I&M data 0 to 3 (electronic rating plate with non-volatile storage of plant data)
- Firmware update
- Pluggable 24 V DC supply connection
- Network / power failure bridging time of 5 ms
- Labeling option via optional labeling strips and equipment labeling plates

When using PROFINET interface modules, the following basic functions are also included:

- Media redundancy (MRP)
- Integrated 2-port switch
- Freely selectable connection system (Standard function class and above) and physical connection (High Feature function class and above) by means of SIMATIC BusAdapters, also as system-integrated media converter from fiber-optic to copper cable
- Reset button for simple return to factory settings without the need for programming device
- Replacement without programming device even in case of non-topological configuration with subsequent automatic launching
- Automatic synchronization of the backplane bus to the PROFINET cycle to minimize the response time fluctuations (jitter)

Listed below is a short overview of the interface modules available for the ET 200SP, showing the essential differences. A clear and more precise comparison of functions of the different interface modules is offered by the TIA Selection Tool.

SIMATIC IM155-6DP High Feature with PROFIBUS connection

- Max. 32 I/O modules, also PROFIsafe modules with complete diagnostic support
- Expansion option with max. 16 modules from the ET 200AL series using the BU-Send BaseUnit and the BA-Send BusAdapter
- Max. 244 bytes in each case for input and output data per module and per station
- Data update time: typ. 5 ms
- PROFIBUS connection via 9-pin sub D female connector
- Package inclusive of server module and PROFIBUS connector with programming device socket

SIMATIC IM155-6PN Basic with PROFINET access

- Max. 12 I/O modules, no PROFIsafe modules, with complete diagnostic support
- Max. 32 bytes in each case for input and output data per module and per station
- Data update time: typ. 1 ms
- PROFINET connection via 2 integrated RJ45 sockets (integrated 2-port switch)
- Package inclusive of server module

SIMATIC IM155-6PN Standard with PROFINET interface

- Max. 32 I/O modules, also PROFIsafe modules, with complete diagnostic support
- Expansion option with max. 16 modules from the ET 200AL series using the BU-Send BaseUnit and the BA-Send BusAdapter
- Max. 256 bytes in each case for input and output data per module and max. 512 bytes per station (depending on configuration)
- Data update time: typ. 1 ms
- Selection of the type of connection of the PROFINET by means of SIMATIC BusAdapter (BusAdapter for copper cables only)
- Two forms of delivery:
 - As package with IM155-6PN ST, with pre-assembled BA 2xRJ45 BusAdapter, including server module
 - As package with IM155-6PN ST, without BusAdapter, including server module

I/O systems

SIMATIC ET 200 systems for the control cabinet SIMATIC ET 200SP

Interface modules > IM 155-6

Overview (continued)

SIMATIC IM155-6PN High Feature with PROFINET interface

- Max. 64 I/O modules, also PROFIsafe modules, with complete diagnostic support
- Expansion option with max. 16 modules from the ET 200AL series using the BU-Send BaseUnit and the BA-Send BusAdapter
- Max. 288 bytes in each case for input and output data per module and max. 1440 bytes per station (depending on configuration)
- Fast data refresh time: isochronous mode from 250 µs
- S2 system redundancy
- Choice of connection type and physical connection of the PROFINET by means of SIMATIC BusAdapter. All BusAdapters with a connection for copper and/or fiber-optic cables can be used; BusAdapter must be ordered separately
- Package includes server module

SIMATIC IM155-6PN High Speed with PROFINET interface

- Max. 30 I/O modules, also PROFIsafe modules, with complete diagnostic support
- Max. 32 bytes in each case for input and output data per module and max. 968 bytes per station (depending on configuration)
- Fast data refresh time: isochronous mode from 125 µs
- Performance upgrade for PROFINET
- Choice of connection type and physical connection of the PROFINET by means of SIMATIC BusAdapter. All BusAdapters with a connection for copper and/or fiber-optic cables can be used; BusAdapter must be ordered separately
- Package inclusive of server module

Technical specifications

Article number	6ES7155-6AR00-0ANO ET 200SP, IM155-6PN BASIC	6ES7155-6AA00-0BNO ET 200SP, IM155-6PN ST INCL. BA 2XRJ45	6ES7155-6AU00-0BNO ET 200SP, IM155-6PN ST	6ES7155-6AU00-0CNO ET 200SP, IM155-6PN HF	6ES7155-6AU00-0DNO ET 200SP, IM155-6PN HS	6ES7155-6BA00-0CNO ET 200SP, IM155-6DP HF INCL. DP-CONNECT.
General information						
Product type designation	IM 155-6 PN BA with 2x RJ45 ports and server module	IM 155-6 PN ST with BA 2xRJ45 and server module	IM 155-6 PN ST with server module	IM 155-6 PN HF with server module	ET 200SP, IM 155-6 PN HS with server module	IM155-6DP HF with PROFIBUS connector and server module
Product function						
• I&M data	Yes; I&M0 to I&M3	Yes; I&M0 to I&M3	Yes; I&M0 to I&M3	Yes; I&M0 to I&M4	Yes; I&M0 to I&M3	Yes; I&M0 to I&M3
Engineering with						
• STEP 7 TIA Portal configurable/integrated as of version	V13 SP1	V13 SP1	V13 SP1	V13 SP1 Update 6	STEP 7 V14 or higher	V13 SP1
• STEP 7 configurable/integrated as of version	V5.5 SP4 and higher	V5.5 SP4 and higher	V5.5 SP4 and higher	V5.5 SP4 and higher	V5.5 SP4 and higher	V5.5 SP4 and higher
• PROFIBUS as of GSD version/GSD revision						One GSD file each, Revision 3 and 5 and higher
• PROFINET as of GSD version/GSD revision	V2.3 / -	V2.3 / -	V2.3 / -	- / V2.3	- / V2.3	
Supply voltage						
Type of supply voltage						DC
Rated value (DC)	24 V	24 V	24 V	24 V	24 V	24 V
Reverse polarity protection	Yes	Yes	Yes	Yes	Yes	Yes
Mains buffering						
• Mains/voltage failure stored energy time	5 ms	5 ms	5 ms	5 ms	5 ms	5 ms
Hardware configuration						
Rack						
• Modules per rack, max.	12	32; + 16 ET 200AL modules	32; + 16 ET 200AL modules	64; + 16 ET 200AL modules	30	32; + 16 ET 200AL modules
Submodules						
• Number of submodules per station, max.		256	256	256	125	
Interfaces						
Number of PROFINET interfaces	1; 2 ports (switch)	1; 2 ports (switch)	1; 2 ports (switch)	1; 2 ports (switch)	1; 2 ports (switch)	
Number of PROFIBUS interfaces						1

Technical specifications (continued)

Article number	6ES7155-6AR00-0A00 ET 200SP, IM155-6PN BASIC	6ES7155-6AA00-0B00 ET 200SP, IM155-6PN ST INCL. BA 2XRJ45	6ES7155-6AU00-0B00 ET 200SP, IM155-6PN ST	6ES7155-6AU00-0C00 ET 200SP, IM155-6PN HF	6ES7155-6AU00-0D00 ET 200SP, IM155-6PN HS	6ES7155-6BA00-0C00 ET 200SP, IM155-6DP HF INCL. DP-CONNECT.
1. Interface						
Interface types						
• Number of ports	2	2	2	2	2	
• integrated switch	Yes	Yes	Yes	Yes	Yes	
• RJ 45 (Ethernet)	Yes; 2 integrated RJ45 ports	Yes; Pre-assembled BusAdapter BA 2x RJ45				
• RS 485						Yes
• BusAdapter (PROFINET)	No	Yes; Applicable BusAdapter: BA 2x RJ45, BA 2x FC	Yes; Applicable BusAdapter: BA 2x RJ45, BA 2x FC	Yes; Compatible BusAdapter: BA 2x RJ45, BA 2x FC, BA 2x SCRJ (from FS03, V2.2), BA SCRJ / RJ45 (from FS03, V3.1), BA SCRJ / FC (from FS03, V3.1), BA 2x LC (from FS03, V3.3), BA LC / RJ45 (from FS03, V3.3), BA LC / FC (from FS03, V3.3)	Yes; Compatible BusAdapter: BA 2x RJ45, BA 2x FC, BA 2x SCRJ, BA SCRJ / RJ45, BA SCRJ / FC, BA 2x LC, BA LC / RJ45, BA LC / FC	
• Output current of the interface, max.						90 mA
Functionality						
• PROFINET IO Device	Yes	Yes	Yes	Yes	Yes	
• PROFIBUS DP slave						Yes
• Open IE communication	Yes	Yes	Yes	Yes	Yes	
• Media redundancy	Yes; PROFINET MRP	Yes; PROFINET MRP	Yes; PROFINET MRP	Yes; PROFINET MRP	Yes; As MRP or MRPD client; max. 50 or 30 devices in the ring	
Interface types						
RJ 45 (Ethernet)						
• Transmission procedure	PROFINET with 100 Mbit/s full duplex (100BASE-TX)	PROFINET with 100 Mbit/s full duplex (100BASE-TX)	PROFINET with 100 Mbit/s full duplex (100BASE-TX)	PROFINET with 100 Mbit/s full duplex (100BASE-TX)	PROFINET with 100 Mbit/s full duplex (100BASE-TX)	
• 10 Mbps	No	No	No	No	No	
• 100 Mbps	Yes; PROFINET with 100 Mbit/s full duplex (100BASE-TX)	Yes; PROFINET with 100 Mbit/s full duplex (100BASE-TX)	Yes; PROFINET with 100 Mbit/s full duplex (100BASE-TX)	Yes; PROFINET with 100 Mbit/s full duplex (100BASE-TX)	Yes; PROFINET with 100 Mbit/s full duplex (100BASE-TX)	
• Autonegotiation	Yes	Yes	Yes	Yes	Yes	
• Autocrossing	Yes	Yes	Yes	Yes	Yes	
RS 485						
• Transmission rate, max.						12 Mbit/s
PROFINET IO Device						
Services						
- Isochronous mode	No	No	No	Yes; Bus cycle time: min. 250 µs	Yes; Bus cycle time: min. 125 µs	
- Open IE communication	Yes	Yes	Yes	Yes	Yes	
- IRT	No	Yes; with send cycles of between 250 µs and 4 ms in increments of 125 µs	Yes; with send cycles of between 250 µs and 4 ms in increments of 125 µs	Yes; 250 µs, 500 µs, 1 ms, 2 ms, 4 ms additionally with IRT with high performance: 250 µs to 4 ms in 125 µs frame	Yes; 125 µs, 250 µs, 500 µs, 1 ms, 2 ms, 4 ms additionally with IRT with high performance: 250 µs to 4 ms in 125 µs frame	

I/O systemsSIMATIC ET 200 systems for the control cabinet
SIMATIC ET 200SP

Interface modules > IM 155-6

Technical specifications (continued)

Article number	6ES7155-6AR00-0ANO ET 200SP, IM155-6PN BASIC	6ES7155-6AA00-0BNO ET 200SP, IM155-6PN ST INCL. BA 2XRJ45	6ES7155-6AU00-0BNO ET 200SP, IM155-6PN ST	6ES7155-6AU00-0CNO ET 200SP, IM155-6PN HF	6ES7155-6AU00-0DNO ET 200SP, IM155-6PN HS	6ES7155-6BA00-0CNO ET 200SP, IM155-6DP HF INCL. DP-CONNECT.
Services (continued)						
- MRP	Yes	Yes	Yes	Yes	Yes	
- MRPD	No	No	No	No	Yes	
- PROFINET system redundancy	No	No	No	Yes; NAP S2	No	
- PROFenergy	No	Yes	Yes	Yes	Yes	
- Prioritized startup	No	Yes	Yes	Yes	Yes	
- Shared device	No	Yes	Yes	Yes	Yes	
- Number of IO Controllers with shared device, max.		2	2	4	4	
Open IE communication						
• TCP/IP	Yes	Yes	Yes	Yes	Yes	
• SNMP	Yes	Yes	Yes	Yes	Yes	
• LLDP	Yes	Yes	Yes	Yes	Yes	
PROFIBUS						
Services						
- SYNC capability						Yes
- FREEZE capability						Yes
- DPV0						Yes
- DPV1						Yes
Isochronous mode						
Isochronous operation (application synchronized up to terminal)	No	No	No	Yes	Yes	No
Equidistance	No	No	No	Yes	Yes	
shortest clock pulse				250 µs	125 µs	
max. cycle				4 ms	4 ms	
Bus cycle time (TDP), min.				250 µs	125 µs	
Interrupts/diagnostics/status information						
Status indicator	Yes	Yes	Yes	Yes	Yes	Yes
Alarms	Yes	Yes	Yes	Yes	Yes	Yes
Diagnostic functions	Yes	Yes	Yes	Yes	Yes	Yes
Diagnostics indication LED						
• RUN LED	Yes; Green LED	Yes; Green LED	Yes; Green LED	Yes; Green LED	Yes; Green LED	Yes; Green LED
• ERROR LED	Yes; Red LED	Yes; Red LED	Yes; Red LED	Yes; Red LED	Yes; Red LED	Yes; Red LED
• MAINT LED	Yes; yellow LED	Yes; yellow LED	Yes; yellow LED	Yes; yellow LED	Yes; yellow LED	Yes; yellow LED
• Monitoring of the supply voltage (PWR-LED)	Yes; green PWR LED	Yes; green PWR LED	Yes; green PWR LED	Yes; green PWR LED	Yes; green PWR LED	Yes; green PWR LED
• Connection display LINK TX/RX	Yes; 2x green LED	Yes; 2x green link LEDs on BusAdapter	Yes; 2x green link LEDs on BusAdapter	Yes; 2x green link LEDs on BusAdapter	Yes; 2x green link LEDs on BusAdapter	
• Connection display DP						Yes; Green DP LED
Isolation						
Isolation tested with		707 V DC between supply voltage and electronics; 1 500 V AC between Ethernet and electronics	707 V DC between supply voltage and electronics; 1 500 V AC between Ethernet and electronics	707 V DC between supply voltage and electronics (type test); 1 500 V AC between Ethernet and electronics (type test)	707 V DC between supply voltage and electronics (type test); 1 500 V AC between Ethernet and electronics (type test)	707 V DC (type test)
Standards, approvals, certificates						
Network loading class	2	2	2	3	3	
Security level		According to Security Level 1 Test Cases V1.1.1	According to Security Level 1 Test Cases V1.1.1	According to Security Level 1 Test Cases V1.1.1	According to Security Level 1 Test Cases V1.1.1	

Technical specifications (continued)

Article number	6ES7155-6AR00-0AN0 ET 200SP, IM155-6PN BASIC	6ES7155-6AA00-0BNO ET 200SP, IM155-6PN ST INCL. BA 2XRJ45	6ES7155-6AU00-0BNO ET 200SP, IM155-6PN ST	6ES7155-6AU00-0CNO ET 200SP, IM155-6PN HF	6ES7155-6AU00-0DNO ET 200SP, IM155-6PN HS	6ES7155-6BA00-0CNO ET 200SP, IM155-6DP HF INCL. DP-CONNECT.
Ambient conditions						
Ambient temperature during operation						
• horizontal installation, min.	0 °C	0 °C	0 °C	0 °C	0 °C	0 °C
• horizontal installation, max.	60 °C	60 °C	60 °C	60 °C	60 °C	60 °C
• vertical installation, min.	0 °C	0 °C	0 °C	0 °C	0 °C	0 °C
• vertical installation, max.	50 °C	50 °C	50 °C	50 °C	50 °C	50 °C
Dimensions						
Width	35 mm	50 mm	50 mm	50 mm	50 mm	50 mm
Height	117 mm	117 mm	117 mm	117 mm	117 mm	117 mm
Depth	74 mm	74 mm	74 mm	74 mm	74 mm	74 mm
Weights						
Weight, approx.	125 g	191 g; IM155PN ST with BA 2x RJ45 (mounted)	147 g; without BusAdapter	147 g; without BusAdapter	147 g; without BusAdapter	150 g

Ordering data

	Article No.	Article No.
IM155-6PN Basic PROFINET interface module With server module; two integrated RJ45 sockets	6ES7155-6AR00-0AN0	SIMATIC BA SCRJ/RJ45 BusAdapter For PROFINET interface modules from High Feature function class or above; with media converter FOC-Cu; for increased vibration and EMC loads; max. cable length 50 m (POF, copper) or 100 m (PCF)
IM155-6PN Basic PROFINET interface module With server module		SIMATIC BA SCRJ/FC BusAdapter For PROFINET interface modules from High Feature function class or above; with media converter FOC-Cu; for increased vibration and EMC loads; max. cable length 50 m (POF, copper) or 100 m (PCF)
• With attached SIMATIC BA 2xRJ45 BusAdapter	6ES7155-6AA00-0BNO	
• Without SIMATIC BusAdapter	6ES7155-6AU00-0BNO	
IM155-6PN High Feature PROFINET interface module With server module, without SIMATIC BusAdapter	6ES7155-6AU00-0CNO	
IM155-6PN High Speed PROFINET interface module With server module, without SIMATIC BusAdapter	6ES7155-6AU00-0DNO	SIMATIC BA 2XLC BusAdapter For PROFINET interface modules from High Feature function class or above; with LC fiber-optic connection; for increased vibration and EMC load capacity; max. cable length 2 km
IM155-6DP High Feature PROFIBUS interface module With server module, with PROFIBUS plug with PG socket	6ES7155-6BA00-0CNO	SIMATIC BA LC/RJ45 BusAdapter For PROFINET interface modules from High Feature function class or above; with media converter FOC-Cu; for increased vibration and EMC loads; max. cable length 2 km (glass) or 50 m (copper)
Accessories		SIMATIC BA LC/FC BusAdapter For PROFINET interface modules from High Feature function class or above; with media converter FOC-Cu; for increased vibration and EMC loads; max. cable length 2 km (glass) or 50 m (copper)
SIMATIC BA 2xRJ45 BusAdapter For PROFINET interface modules from Standard function class or above; max. cable length 50 m	6ES7193-6AR00-0AAA0	
SIMATIC BA 2xFC BusAdapter For PROFINET interface modules from Standard function class or above; for increased vibration and EMC loads; max. cable length 50 m	6ES7193-6AF00-0AAA0	
SIMATIC BA 2xSCRJ BusAdapter For PROFINET interface modules from High Feature function class or above; fiber-optic cable connection for POF or PCF; for increased vibration and EMC load capacity; max. cable length 50 m (POF) or 100 m (PCF)	6ES7193-6AP00-0AAA0	

I/O systems

SIMATIC ET 200 systems for the control cabinet
SIMATIC ET 200SP

Interface modules > IM 155-6

Ordering data	Article No.	Ordering data	Article No.
Station expansion with IP67 I/O system ET 200AL		SIMATIC Manual Collection	6ES7998-8XC01-8YE0
ET 200SP BA-Send 1 x FC BusAdapter	6ES7193-6AS00-0AA0	Electronic manuals on DVD, multi-language: LOGO!, SIMADYN, SIMATIC bus components, SIMATIC C7, SIMATIC distributed I/O, SIMATIC HMI, SIMATIC Sensors, SIMATIC NET, SIMATIC PC Based Automation, SIMATIC PCS 7, SIMATIC PG/PC, SIMATIC S7, SIMATIC Software, SIMATIC TDC	
BaseUnit BU-Send	6ES7193-6BN00-0NE0		
Additional accessories		SIMATIC Manual Collection update service for 1 year	6ES7998-8XC01-8YE2
Labeling strips		Current "Manual Collection" DVD and the three subsequent updates	
500 labeling strips on roll, light gray, for inscription with thermal transfer roll printer	6ES7193-6LR10-0AA0	Spare parts	
500 labeling strips on roll, yellow, for inscription with thermal transfer roll printer	6ES7193-6LR10-0AG0	Server module	6ES7193-6PA00-0AA0
1000 labeling strips DIN A4, light gray, card, perforated, for inscription with laser printer	6ES7193-6LA10-0AA0	Terminates an ET 200SP station; included in the scope of delivery of the interface modules	
1000 labeling strips DIN A4, yellow, card, perforated, for inscription with laser printer	6ES7193-6LA10-0AG0	Power supply connector for interface module	
Equipment labeling plate	6ES7193-6LF30-0AW0	For connecting the 24 V DC supply voltage	
10 sheets of 16 labels, for printing with thermal transfer card printer or plotter		with push-in terminals (10 units)	6ES7193-4JB00-0AA0
DIN rail 35 mm		with screw-type terminals (10 units)	6ES7193-4JB50-0AA0
Length: 483 mm for 19" cabinets	6ES5710-8MA11		
Length: 530 mm for 600 mm cabinets	6ES5710-8MA21		
Length: 830 mm for 900 mm cabinets	6ES5710-8MA31		
Length: 2 m	6ES5710-8MA41		
Manuals for ET 200SP distributed I/O system			
SIMATIC ET 200SP Manual Collection: PDF file with the following content:			
<ul style="list-style-type: none"> • Basic information System manual, product information, overview tables, correction information or manual supplements • Device-specific information Device manuals for the interface modules, PLC, OC and I/O modules, including fail-safe • Comprehensive information Function manuals 			
The Manual Collection can be downloaded from the Internet as a PDF file:			
https://support.industry.siemens.com/cs/de/en/view/84133942			

Overview



- Interface module for linking the I/O modules to a higher level controller with PROFINET or PROFIBUS
- Server module included in the scope of supply
- Station expansion with IP67 I/O system ET 200AL via ET connection to BU-Send / BA-Send
- PROFINET bus connection
 - 2 ports for line configuration
 - PN connection selected via BusAdapter (ST, HF)
 - Two integrated RJ45 sockets (BA)
- PROFIBUS bus connection
 - 9-pin sub D socket
 - PROFIBUS connector included in scope of delivery
 - Hot swapping (module replacement during operation)
 - Startup and operation with gaps
 - Dynamic re-parameterization in RUN mode
 - Configuration control (option handling)
 - Pluggable 24 V DC supply connector
 - Electronically readable rating plate (I&M data)

Note:

SIPLUS extreme products are based on SIMATIC standard products. The contents listed here were taken from the respective standard products. SIPLUS extreme-specific information was added.

Technical specifications

Article number	6AG1155-6AA00-7BN0	6AG1155-6AU00-4CN0	6AG1155-6BA00-7CN0
Based on	6ES7155-6AA00-0BN0 SIPLUS ET 200SP IM155-6PN ST	6ES7155-6AU00-0CN0 SIPLUS ET 200SP IM155-6PN HF	6ES7155-6BA00-0CN0 SIPLUS ET 200SP IM155-6DP HF
Ambient conditions			
Ambient temperature during operation			
• horizontal installation, min.	-40 °C; = Tmin; Startup @ -25 °C	0 °C	-40 °C; = Tmin; Startup @ -25 °C
• horizontal installation, max.	70 °C; = Tmax	60 °C	70 °C; = Tmax
• vertical installation, min.	-40 °C; = Tmin; Startup @ -25 °C	0 °C	-40 °C; = Tmin; Startup @ -25 °C
• vertical installation, max.	50 °C; = Tmax	50 °C	50 °C; = Tmax
Extended ambient conditions			
• relative to ambient temperature-atmospheric pressure-installation altitude	Tmin ... Tmax at 1080 hPa ... 795 hPa (-1000 m ... +2000 m) // Tmin ... (Tmax - 10K) at 795 hPa ... 658 hPa (+2000 m ... +3500 m) // Tmin ... (Tmax - 20K) at 658 hPa ... 540 hPa (+3500 m ... +5000 m)	Tmin ... Tmax at 1080 hPa ... 795 hPa (-1000 m ... +2000 m) // Tmin ... (Tmax - 10K) at 795 hPa ... 658 hPa (+2000 m ... +3500 m) // Tmin ... (Tmax - 20K) at 658 hPa ... 540 hPa (+3500 m ... +5000 m)	Tmin ... Tmax at 1080 hPa ... 795 hPa (-1000 m ... +2000 m) // Tmin ... (Tmax - 10K) at 795 hPa ... 658 hPa (+2000 m ... +3500 m) // Tmin ... (Tmax - 20K) at 658 hPa ... 540 hPa (+3500 m ... +5000 m)
Relative humidity			
- With condensation, tested in accordance with IEC 60068-2-38, max.	100 %; RH incl. condensation/frost (no commissioning under condensation conditions)	100 %; RH incl. condensation/frost (no commissioning under condensation conditions)	100 %; RH incl. condensation/frost (no commissioning under condensation conditions)
Resistance			
- against biologically active substances / conformity with EN 60721-3-3	Yes; Class 3B2 mold, fungus and dry rot spores (with the exception of fauna). The supplied connector covers must remain on the unused interfaces during operation!	Yes; Class 3B2 mold, fungus and dry rot spores (with the exception of fauna). The supplied connector covers must remain on the unused interfaces during operation!	Yes; Class 3B2 mold, fungus and dry rot spores (with the exception of fauna). The supplied connector covers must remain on the unused interfaces during operation!
- against chemically active substances / conformity with EN 60721-3-3	Yes; Class 3C4 (RH < 75%) incl. salt spray according to EN 60068-2-52 (degree of severity 3). The supplied connector covers must remain on the unused interfaces during operation!	Yes; Class 3C4 (RH < 75%) incl. salt spray according to EN 60068-2-52 (degree of severity 3). The supplied connector covers must remain on the unused interfaces during operation!	Yes; Class 3C4 (RH < 75%) incl. salt spray according to EN 60068-2-52 (degree of severity 3). The supplied connector covers must remain on the unused interfaces during operation!
- against mechanically active substances / conformity with EN 60721-3-3	Yes; Class 3S4 incl. sand, dust. The supplied connector covers must remain on the unused interfaces during operation!	Yes; Class 3S4 incl. sand, dust. The supplied connector covers must remain on the unused interfaces during operation!	Yes; Class 3S4 incl. sand, dust. The supplied connector covers must remain on the unused interfaces during operation!

I/O systems

SIMATIC ET 200 systems for the control cabinet
SIMATIC ET 200SP

Interface modules > SIPLUS interface modules

Ordering data	Article No.		Article No.
SIPLUS interface module Standard (Extended temperature range and exposure to media) <ul style="list-style-type: none"> IM 155-6PN ST, with server module and installed BA 2xRJ45 BusAdapter 	6AG1155-6AA00-7BN0	Accessories	See SIMATIC ET 200SP, IM 155-6 interface module, page 9/11
SIPLUS interface module High Feature (Extended temperature range and exposure to media) <ul style="list-style-type: none"> IM 155-6DP HF, with server module, with multi-hot-swap, incl. PROFIBUS connector 	6AG1155-6BA00-7CN0		
(Exposure to media) <ul style="list-style-type: none"> IM 155-6PN HF, incl. server module, without BusAdapter 	6AG1155-6AU00-4CN0		

Overview



- 4, 8 and 16-channel digital input (DI) modules
- Apart from the standard delivery form in an individual package, selected I/O modules and BaseUnits are also available in a pack of 10 units. The pack of 10 units enables the amount of waste to be reduced considerably, as well as saving the time of unpacking individual modules.

For different requirements, the digital input modules offer:

- Function classes Basic, Standard, High Feature and High-Speed as well as fail-safe DI
- BaseUnits for single or multiple-conductor connection with automatic slot coding
- Individual system-integrated load group formation with self-assembling voltage distribution bars (a separate power module is no longer required for ET 200SP)
- Connection option of sensors compliant with IEC 61131 Type 1, 2 or 3 (module-dependent) for rated voltages of up to 24 V DC or 230 V AC

- PNP (sink input) and NPN (source input) versions
- Clear labeling on front of module
- LEDs for diagnostics, status, power supply and faults
- Electronically readable and non-volatile writable rating plate (I&M data 0 to 3)
- Extended functions and additional operating modes in some cases
 - MSI operating mode (simultaneous reading of input data from as many as three other controllers)
 - Counting operating mode (multi-channel counter for pulse generators with 32-bit counting width and up to 10 kHz counting frequency)
 - Oversampling operating mode (n-fold equidistant acquisition of digital values within one PN cycle for increasing the time resolution for slow CPU cycles)
 - Parameterizable input delay time
 - Isochronous mode (simultaneous equidistant reading of all input channels)
 - Hardware interrupts
 - Pulse extension
 - Re-parameterization during operation
 - Firmware update
 - Diagnosis of wire break and short-circuit (on channel or module basis)
 - Value status (optional binary validity information of the input signal in the process image)
 - Supports the PROFlenergy profile
- Optional accessories
 - Labeling strips (film or card)
 - Equipment labeling plate
 - Color-coded label with module-specific CC Code
 - Shielding terminal

A quick and clear comparison of the functions of the different DI modules is offered by the TIA Selection Tool.

Overview of digital input modules

Digital input	PU	Article No.	CC Code	BU type
DI 16 x 24 V DC ST	1	6ES7131-6BH00-0BA0	CC00	A0
DI 16 x 24 V DC ST	10	6ES7131-6BH00-2BA0	CC00	A0
DI 8 x 24 V DC BA	1	6ES7131-6BF00-0AA0	CC01	A0
DI 8 x 24 V DC BA	10	6ES7131-6BF00-2AA0	CC01	A0
DI 8 x 24 V DC SRC BA	1	6ES7131-6BF60-0AA0	CC02	A0
DI 8 x 24 V DC ST	1	6ES7131-6BF00-0BA0	CC01	A0
DI 8 x 24 V DC ST	10	6ES7131-6BF00-2BA0	CC01	A0
DI 8 x 24 V DC HF	1	6ES7131-6BF00-0CA0	CC01	A0
DI 8 x NAMUR HF	1	6ES7131-6TF00-0CA0	CC01	A0
DI 8 x 24 V DC HS	1	6ES7131-6BF00-0DA0	CC01	A0
With three operating modes: • High-speed isochronous DI • 4 pulse counters, 32-bit, 10 kHz • Oversampling				
DI 4 x 120...230 V AC ST	1	6ES7131-6FD00-0BB1	CC41	B1

I/O systems

SIMATIC ET 200 systems for the control cabinet

SIMATIC ET 200SP

I/O modules > Digital input modules**Overview** (continued)

Overview of BaseUnits

BaseUnit	PU	Article No.	CC Codes for process terminals	CC Codes for AUX terminals
BU type A0 • New load group (light) • 16 process terminals • With 10 AUX terminals	1	6ES7193-6BP20-0DA0	CC01 to CC05	CC71 to CC73
BU type A0 • New load group (light) • 16 process terminals • With 10 AUX terminals	10	6ES7193-6BP20-2DA0	CC01 to CC05	CC71 to CC73
BU type A0 • New load group (light) • 16 process terminals • Without AUX terminals	1	6ES7193-6BP00-0DA0	CC01 to CC05	--
BU type A0 • New load group (light) • 16 process terminals • Without AUX terminals	10	6ES7193-6BP00-2DA0	CC01 to CC05	--
BU type A0 • Forwarding of load group (dark) • 16 process terminals • With 10 AUX terminals	1	6ES7193-6BP20-0BA0	CC01 to CC05	CC71 to CC73
BU type A0 • Forwarding of load group (dark) • 16 process terminals • With 10 AUX terminals	10	6ES7193-6BP20-2BA0	CC01 to CC05	CC71 to CC73
BU type A0 • Forwarding of load group (dark) • 16 process terminals • Without AUX terminals	1	6ES7193-6BP00-0BA0	CC01 to CC05	--
BU type A0 • Forwarding of load group (dark) • 16 process terminals • Without AUX terminals	10	6ES7193-6BP00-2BA0	CC01 to CC05	--
BU type B1 • Forwarding of load group (dark) • 12 process terminals • 2 x 2 (1L, 2L, 1N, 2N) direct infeed module • Without AUX terminals	1	6ES7193-6BP20-0BB1	CC41	--

Technical specifications

Article number	6ES7131-6BF00-0AA0 ET 200SP, DI 8x24VDC BASIC	6ES7131-6BF60-0AA0 ET 200SP, DI 8x24VDC SOURCE BA	6ES7131-6BF00-0BA0 ET 200SP, DI 8x24VDC ST	6ES7131-6BH00-0BA0 ET 200SP, DI 16x24VDC ST
General information				
Product type designation	ET 200SP, DI 8x 24 V DC BA, PU 1	ET 200SP, DI 8x 24 V DC SRC BA, PU 1	ET 200SP, DI 8x 24 V DC ST, PU 1	ET 200SP, DI 16x 24 V DC ST, PU 1
Product function				
• I&M data	Yes; I&M0 to I&M3	Yes; I&M0 to I&M3	Yes; I&M0 to I&M3	Yes; I&M0 to I&M3
Engineering with				
• STEP 7 TIA Portal configurable/integrated as of version	V13 SP1	V13 / V13	V11 SP2 / V13	V13 SP1
• STEP 7 configurable/integrated as of version	V5.5 SP3 / -	V5.5 SP3 / -	V5.5 SP3 / -	V5.5 / -
• PCS 7 configurable/integrated as of version			V8.1 SP1	V8.1 SP1
• PROFIBUS as of GSD version/GSD revision	GSD Revision 5	GSD Revision 5	GSD Revision 5	GSD Revision 5
• PROFINET as of GSD version/GSD revision	GSDML V2.3	GSDML V2.3	GSDML V2.3	GSDML V2.3
Operating mode				
• DI	Yes	Yes	Yes	Yes
• Counter	No	No	No	No
• Oversampling	No	No	No	No
• MSI	No	No	No	No
Supply voltage				
Type of supply voltage	DC	24 V DC	DC	DC
Rated value (DC)	24 V	24 V	24 V	24 V
Reverse polarity protection	Yes	Yes	Yes	Yes
Encoder supply				
Number of outputs	8		8	
Output voltage encoder supply, min.	19.2 V		19.2 V	
Short-circuit protection	No	No	Yes; per module	No
24 V encoder supply				
• 24 V	Yes		Yes	No
• Short-circuit protection	Yes		Yes	No
• Output current, max.	700 mA		700 mA; Total current of all encoders	
Digital inputs				
Number of digital inputs	8	8	8	16
Source/sink input	P-reading	Yes; m-reading	P-reading	P-reading
Input characteristic curve in accordance with IEC 61131, type 1	Yes	Yes	Yes	Yes
Input characteristic curve in accordance with IEC 61131, type 2	Yes	No	No	No
Input characteristic curve in accordance with IEC 61131, type 3	Yes	Yes	Yes	Yes
Pulse extension	No	No	No	No
Input voltage				
• Type of input voltage	DC	DC	DC	DC
• Rated value (DC)	24 V	24 V	24 V	24 V
• for signal "0"	-30 to +5V	30 V to -5 V (reference potential is L+)	-30 to +5V	-30 to +5V
• for signal "1"	+11 to +30V	-11 V to -30 V (reference potential is L+)	+11 to +30V	+11 to +30V
Input current				
• for signal "1", typ.	6.8 mA	6 mA	2.5 mA	2.5 mA

I/O systemsSIMATIC ET 200 systems for the control cabinet
SIMATIC ET 200SP**I/O modules > Digital input modules****Technical specifications (continued)**

Article number	6ES7131-6BF00-0AA0 ET 200SP, DI 8X24VDC BASIC	6ES7131-6BF60-0AA0 ET 200SP, DI 8X24VDC SOURCE BA	6ES7131-6BF00-0BA0 ET 200SP, DI 8X24VDC ST	6ES7131-6BH00-0BA0 ET 200SP, DI 16X24VDC ST
Input delay (for rated value of input voltage)				
for standard inputs				
- parameterizable	Yes; None / 0.05 / 0.1 / 0.4 / 0.8 / 1.6 / 3.2 / 12.8 / 20 ms (in each case + delay of 30 µs to 500 µs, depending on line length)	Yes; 0.05 / 0.1 / 0.4 / 0.8 / 1.6 / 3.2 / 12.8 / 20 ms (in each case + delay of 30 to 500 µs, depending on line length)	Yes; 0.05 / 0.1 / 0.4 / 0.8 / 1.6 / 3.2 / 12.8 / 20 ms (in each case + delay of 30 to 500 µs, depending on line length)	Yes; 0.05 / 0.1 / 0.4 / 0.8 / 1.6 / 3.2 / 12.8 / 20 ms (in each case + delay of 30 to 500 µs, depending on line length)
for interrupt inputs				
- parameterizable	No	No	No	No
for counter/technological functions				
- parameterizable	No	No	No	No
Cable length				
• shielded, max.	1 000 m	1 000 m	1 000 m	1 000 m
• unshielded, max.	600 m	200 m	600 m	600 m
Encoder				
Connectable encoders				
• 2-wire sensor	Yes	Yes	Yes	Yes
- permissible quiescent current (2-wire sensor), max.	2 mA	1.5 mA	1.5 mA	1.5 mA
Isochronous mode				
Isochronous operation (application synchronized up to terminal)	No	No	No	No
Interrupts/diagnostics/ status information				
Diagnostics function	Yes	Yes	Yes	Yes
Alarms				
• Diagnostic alarm	Yes	Yes	Yes	Yes
• Hardware interrupt		No		
Diagnostic messages				
• Diagnostic information readable	Yes	Yes	Yes	Yes
• Monitoring the supply voltage	Yes	Yes	Yes	Yes
- parameterizable	Yes	Yes	Yes	Yes
• Monitoring of encoder power supply	No	No	Yes; Module-wise	No
• Wire-break	No	No	Yes; Module-by-module, optional protective circuit for preventing wire-break diagnostics in the case of simple encoder contacts: 25 kOhm to 45 kOhm	Yes; Module-by-module, optional protective circuit for preventing wire-break diagnostics in the case of simple encoder contacts: 25 kOhm to 45 kOhm
• Short-circuit	No	No	Yes; Module-wise	No
• Group error		Yes		Yes
Diagnostics indication LED				
• Monitoring of the supply voltage (PWR-LED)	Yes; green PWR LED	Yes; green PWR LED	Yes; green PWR LED	Yes; green PWR LED
• Channel status display	Yes; Green LED	Yes; Green LED	Yes; Green LED	Yes; Green LED
• for channel diagnostics	No	No	No	No
• for module diagnostics	Yes; green/red DIAG LED	Yes; green/red DIAG LED	Yes; green/red DIAG LED	Yes; green/red DIAG LED
Potential separation				
Potential separation channels				
• between the channels and backplane bus	Yes	Yes	Yes	Yes
Isolation				
Isolation tested with	707 V DC (type test)	707 V DC (type test)	707 V DC (type test)	707 V DC (type test)
Standards, approvals, certificates				
Suitable for safety functions	No	No	No	No
Dimensions				
Width	15 mm	15 mm	15 mm	15 mm
Height	73 mm	73 mm	73 mm	73 mm
Depth	58 mm	58 mm	58 mm	58 mm
Weights				
Weight, approx.	28 g	28 g	28 g	28 g

Technical specifications (continued)

Article number	6ES7131-6BF00-0CA0 ET 200SP, DI 8x24VDC HF	6ES7131-6BF00-0DA0 ET 200SP, DI 8x24VDC HIGH SPEED	6ES7131-6TF00-0CA0 ET 200SP, DI 8xNAMUR HF	6ES7131-6FD00-0BB1 ET 200SP, DI 4x120...230VAC ST
General information				
Product type designation	ET 200SP, DI 8x 24 V DC HF, PU 1	ET 200SP, DI 8x 24 V DC High Speed, PU 1	DI 8xNAMUR HF	DI 4x120 ... 230VAC ST
Product function				
• I&M data	Yes; I&M0 to I&M3	Yes; I&M0 to I&M3	Yes; I&M0 to I&M3	Yes; I&M0 to I&M3
Engineering with				
• STEP 7 TIA Portal configurable/integrated as of version	V13 SP1 / -	V13 SP1	V13 / V13	V13 / V13
• STEP 7 configurable/integrated as of version	V5.5 / -	V5.5 SP3 / -	V5.5 SP3 / -	V5.5 SP3 / -
• PCS 7 configurable/integrated as of version	V8.1 SP1			
• PROFIBUS as of GSD version/GSD revision	GSD Revision 5	GSD Revision 5	GSD Revision 5	GSD Revision 5
• PROFINET as of GSD version/GSD revision	GSDML V2.3	GSDML V2.3	GSDML V2.3	GSDML V2.3
Operating mode				
• DI	Yes	Yes	Yes	Yes
• Counter	No	Yes	No	No
• Oversampling	No	Yes	No	No
• MSI	Yes	No	No	No
Supply voltage				
Type of supply voltage	DC	DC	24 V DC	100 - 240 V AC
Rated value (DC)	24 V	24 V	24 V	
Rated value (AC)				230 V
Reverse polarity protection	Yes	Yes	Yes	No
Encoder supply				
Number of outputs			8	4
Short-circuit protection			Yes	No; when using BU type B1, a fuse with 10 A tripping current must be provided
Output current				
• up to 60 °C, max.				10 A
24 V encoder supply				
• 24 V	Yes	Yes	No	No
• Short-circuit protection	Yes; per channel, electronic	Yes; per module, electronic	No	No
• Output current, max.	700 mA; Per channel	700 mA		
Digital inputs				
Number of digital inputs	8	8	8	4
Digital inputs, parameterizable			Yes	
Type			NAMUR	
Source/sink input	P-reading	P-reading		No
Input characteristic curve in accordance with IEC 61131, type 1	Yes			
Input characteristic curve in accordance with IEC 61131, type 2	No			
Input characteristic curve in accordance with IEC 61131, type 3	Yes			Yes
Pulse extension	Yes; Pulse duration from 4 µs	Yes	Yes; 0.5 s, 1 s, 2 s	No
• Length	2 s; 50 ms, 100 ms, 200 ms, 500 ms, 1 s, 2 s	2 s; 50 ms, 100 ms, 200 ms, 500 ms, 1 s, 2 s		
Edge evaluation	Yes; rising edge, falling edge, edge change		Yes; rising edge, falling edge, edge change	
Signal change flutter			Yes; 2 to 32 signal changes	
Flutter observation window			Yes; 0.5 s, 1 s to 100 s in 1-s steps	

I/O systems

SIMATIC ET 200 systems for the control cabinet

SIMATIC ET 200SP

I/O modules > Digital input modules**Technical specifications (continued)**

Article number	6ES7131-6BF00-0CA0 ET 200SP, DI 8X24VDC HF	6ES7131-6BF00-0DA0 ET 200SP, DI 8X24VDC HIGH SPEED	6ES7131-6TF00-0CA0 ET 200SP, DI 8XNAMUR HF	6ES7131-6FD00-0BB1 ET 200SP, DI 4X120..230VAC ST
Digital input functions, parameterizable				
• Gate start/stop		Yes		
• Freely usable digital input		Yes		
• Counter		Yes		
- Number, max.		4		
- Counting frequency, max.		10 kHz		
- Counting width		32 bit		
- Counting direction up/down		Yes		
• Digital input with oversampling		Yes		
- Number, max.		8		
- Values per cycle, max.		32		
- Resolution, min.		7.8125 µs		
Input voltage				
• Type of input voltage	DC	DC	DC	120/230V AC (47 Hz to 63 Hz)
• Rated value (DC)	24 V	24 V	8.2 V	
• Rated value (AC)				230 V
• for signal "0"	-30 to +5V	-30 to +5V		0V AC to 40V AC
• for signal "1"	+11 to +30V	+11 to +30V		74 V AC to 264 V AC
Input current				
• for signal "1", typ.	2.5 mA	6 mA		10.8 mA
for 10 k switched contact				
- for signal "0"			0.35 to 1.2 mA	
- for signal "1"			2.1 to 7 mA	
for unswitched contact				
- for signal "0", max. (permissible quiescent current)			0.5 mA	
- for signal "1"			typ. 8 mA	
for NAMUR encoders				
- for signal "0"			0.35 to 1.2 mA	
- for signal "1"			2.1 to 7 mA	
Input delay (for rated value of input voltage)				
• tolerated changeover time for changeover contacts			300 ms	
for standard inputs				
- parameterizable	Yes; 0.05 / 0.1 / 0.4 / 0.8 / 1.6 / 3.2 / 12.8 / 20 ms (in each case + delay of 30 to 500 µs, depending on line length)	Yes; none / 0.05 / 0.1 / 0.4 / 0.8 / 1.6 / 3.2 / 12.8 / 20 ms	No	No
for interrupt inputs				
- parameterizable	Yes	Yes		
for counter/technological functions				
- parameterizable	No	Yes		
for NAMUR inputs				
- at "0" to "1", max.			12 ms	
- at "1" to "0", max.			12 ms	
Cable length				
• shielded, max.	1 000 m	50 m	200 m	1 000 m
• unshielded, max.	600 m	50 m		600 m

Technical specifications (continued)

Article number	6ES7131-6BF00-0CA0 ET 200SP, DI 8X24VDC HF	6ES7131-6BF00-0DA0 ET 200SP, DI 8X24VDC HIGH SPEED	6ES7131-6TF00-0CA0 ET 200SP, DI 8XNAMUR HF	6ES7131-6FD00-0BB1 ET 200SP, DI 4X120..230VAC ST
Encoder				
Connectable encoders				
• NAMUR encoder/changeover contact according to EN 60947			Yes	
• Single contact / changeover contact unconnected			Yes	
• Single contact / changeover contact connected with 10 k Ω			Yes	
• 2-wire sensor	Yes	Yes		Yes
- permissible quiescent current (2-wire sensor), max.	1.5 mA	1.5 mA		
Isochronous mode				
Isochronous operation (application synchronized up to terminal)	Yes	Yes	No	No
Filtering and processing time (TCI), min.	420 μ s			
Bus cycle time (TDP), min.	500 μ s	125 μ s		
Interrupts/diagnostics/ status information				
Diagnostics function	Yes	Yes	Yes	
Alarms				
• Diagnostic alarm	Yes; channel by channel	Yes	Yes; channel by channel	No
• Hardware interrupt	Yes; Parameterizable, channels 0 to 7	Yes	Yes; Parameterizable, channels 0 to 7	No
Diagnostic messages				
• Diagnostic information readable	Yes	Yes	Yes	
• Monitoring the supply voltage	Yes	Yes	Yes	
- parameterizable	Yes	Yes	Yes	
• Monitoring of encoder power supply	Yes; channel by channel	Yes; Module-wise	Yes; channel by channel	
• Wire-break	Yes; Channel by channel, optional protective circuit for preventing wire-break diagnostics in the case of simple encoder contacts: 25 k Ω to 45 k Ω	No	Yes; channel by channel	No
• Short-circuit	Yes; channel by channel	Yes; Module-wise	Yes; channel by channel	No
• Group error			Yes	Yes
Diagnostics indication LED				
• Monitoring of the supply voltage (PWR-LED)	Yes; green PWR LED	Yes; green PWR LED	Yes; green PWR LED	Yes; green PWR LED
• Channel status display	Yes; Green LED	Yes; Green LED	Yes; Green LED	Yes; Green LED
• for channel diagnostics	Yes; Red LED	No	Yes; Red LED	No
• for module diagnostics	Yes; green/red DIAG LED	Yes; green/red DIAG LED	Yes; green/red DIAG LED	Yes; green/red DIAG LED
Potential separation				
Potential separation channels				
• between the channels and backplane bus	Yes	Yes	Yes	Yes
Isolation				
Isolation tested with	707 V DC (type test)	707 V DC (type test)	707 V DC (type test)	2 545 V DC/2 s (routine test)
Standards, approvals, certificates				
Suitable for safety functions	No	No	No	No
Dimensions				
Width	15 mm	15 mm	15 mm	20 mm
Height	73 mm	73 mm	73 mm	73 mm
Depth	58 mm	58 mm	58 mm	58 mm
Weights				
Weight, approx.	28 g	28 g	32 g	36 g

I/O systemsSIMATIC ET 200 systems for the control cabinet
SIMATIC ET 200SP**I/O modules > Digital input modules****Ordering data****Article No.****Article No.****Digital input modules**

Delivery options:

Apart from the standard delivery form in an individual package, selected I/O modules and BaseUnits are also available in a pack of 10 units. The pack of 10 units enables the amount of waste to be reduced considerably, as well as saving the time of unpacking individual modules.

The number of modules required is the number of modules ordered.

The type of packaging is chosen by selecting the article number. Packs of 10 can therefore only be ordered in integer multiples of 10.

Digital input module DI 8x24 V DC, Basic, BU type A0, color code CC01

- PU: 1 unit
- PU: 10 units

6ES7131-6BF00-0AA0
6ES7131-6BF00-2AA0

Digital input module DI 8x24 V DC Source Input, Basic, BU type A0, color code CC02; PU: 1 unit

6ES7131-6BF60-0AA0

Digital input module DI 8x24 V DC Standard, BU type A0, color code CC01

- PU: 1 unit
- PU: 10 units

6ES7131-6BF00-0BA0
6ES7131-6BF00-2BA0

Digital input module DI 16x24 V DC Standard, BU type A0, color code CC00

- PU: 1 unit
- PU: 10 units

6ES7131-6BH00-0BA0
6ES7131-6BH00-2BA0

Digital input module DI 8x24 V DC High Feature, BU type A0, color code CC01, channel-specific diagnostics, isochronous mode, shared input (MSI); PU: 1 unit

6ES7131-6BF00-0CA0

Digital input module DI 8x24 V DC High Speed, BU type A0, color code CC01; 3 operating modes (fast isochronous DI, 4 pulse counters 32-bit 10 kHz, oversampling); PU: 1 unit

6ES7131-6BF00-0DA0

Digital input module DI 8xNAMUR High Feature, BU type A0, color code CC01; PU: 1 unit

6ES7131-6TF00-0CA0

Digital input module DI 4x120 V AC - 230 V AC Standard, BU type B1, color code CC41; PU: 1 unit

6ES7131-6FD00-0BB1

Usable BaseUnits**BU15-P16+A10+2D**

BU type A0; BaseUnit (light) with 16 process terminals (1...16) to the module and an additional 10 internally jumpered AUX terminals (1 A to 10 A); for starting a new load group (max. 10 A)

- 1 unit
- 10 units

6ES7193-6BP20-0DA0
6ES7193-6BP20-2DA0

BU15-P16+A0+2D

BU type A0; BaseUnit (light) with 16 process terminals to the module; for starting a new load group (max. 10 A)

- 1 unit
- 10 units

6ES7193-6BP00-0DA0
6ES7193-6BP00-2DA0

BU15-P16+A10+2B

BU type A0; BaseUnit (dark) with 16 process terminals (1...16) to the module and an additional 10 internally jumpered AUX terminals (1 A to 10 A); for continuing the load group

- 1 unit
- 10 units

6ES7193-6BP20-0BA0
6ES7193-6BP20-2BA0

BU15-P16+A0+2B

BU type A0; BaseUnit (dark) with 16 process terminals to the module; for continuing the load group

- 1 unit
- 10 units

6ES7193-6BP00-0BA0
6ES7193-6BP00-2BA0

BU20-P12+A0+4B

BU type B1; BaseUnit (dark) with 12 process terminals to the module; for continuing the load group; 1 unit

6ES7193-6BP20-0BB1

Ordering data	Article No.	Article No.
Accessories		
Equipment labeling plate 10 sheets of 16 labels, for printing with thermal transfer card printer or plotter	6ES7193-6LF30-0AW0	Color-coded labels for 15 mm-wide BaseUnits Color code CC00, for 16 process terminals, for BU type A0, A1, gray (terminals 1 to 8), red (terminals 9 to 16); 10 units
Labeling strips 500 labeling strips on roll, light gray, for inscription with thermal transfer roll printer	6ES7193-6LR10-0AA0	6ES7193-6CP00-2MA0
500 labeling strips on roll, yellow, for inscription with thermal transfer roll printer	6ES7193-6LR10-0AG0	6ES7193-6CP01-2MA0
1000 labeling strips DIN A4, light gray, card, perforated, for inscription with laser printer	6ES7193-6LA10-0AA0	6ES7193-6CP02-2MA0
1000 labeling strips DIN A4, yellow, card, perforated, for inscription with laser printer	6ES7193-6LA10-0AG0	6ES7193-6CP71-2AA0
BU cover For covering empty slots (gaps); 5 units • 15 mm wide	6ES7133-6CV15-1AM0	6ES7193-6CP72-2AA0
Shield connection 5 shield supports and 5 shield terminals	6ES7193-6SC00-1AM0	6ES7193-6CP73-2AA0
		Color-coded labels for 20 mm-wide BaseUnits Color code CC41, for 16 push-in terminals; for BU type B1, gray (terminals 1 to 4), red (terminals 5 to 8), blue (terminals 9 to 12); 10 units
		6ES7193-6CP41-2MB0

I/O systems

SIMATIC ET 200 systems for the control cabinet
SIMATIC ET 200SP

I/O modules > Digital output modules

Overview



- 4, 8 and 16-channel digital output (DQ) modules
 - Apart from the standard delivery form in an individual package, selected I/O modules and BaseUnits are also available in a pack of 10 units. The pack of 10 units enables the amount of waste to be reduced considerably, as well as saving the time of unpacking individual modules.
- For different requirements, the digital output modules offer:
- Function classes Basic, Standard, High Feature and High-Speed as well as fail-safe DQ (see "Fail-safe I/O modules")
 - BaseUnits for single or multiple-conductor connection with automatic slot coding
 - Individual system-integrated load group formation with self-assembling voltage distribution bars (a separate power module is no longer required for ET 200SP)
 - Option of connecting actuators with rated load voltages of up to 120 V DC or 230 V AC and load currents of up to 5 A (depending on module)
 - Relay modules
 - NO contact or changeover contact
 - for load or signal voltages (coupling relay)
 - with manual operation (as simulation module for inputs and outputs, jog mode for commissioning or emergency operation on failure of controller)
 - PNP (source output) and NPN (sink output) versions
 - Clear labeling on front of module
 - LEDs for diagnostics, status, power supply and faults

- Electronically readable and non-volatile writable rating plate (I&M data 0 to 3)
- Extended functions and additional operating modes in some cases
 - MSO operating mode (simultaneous reading of input data from as many as three other controllers)
 - Pulse width modulation mode (output value as pulse-pause ratio of between 0.0% and 100.0% for controlling the output current)
 - Oversampling (n-fold equidistant output of digital values within a PN cycle for the precise time control of an output or a sequence of output values)
 - Isochronous mode (simultaneous equidistant output of all output channels)
 - Output of substitute value in the event of interruptions to communication (0, 1 or last value retained)
 - Re-parameterization during operation
 - Firmware update
 - Valve control (output signal does not switch automatically after a set pickup time to a current-saving PWM output)
 - Diagnosis of wire break and short-circuit (on channel or module basis)
 - Value status (optional binary validity information of the output signal in the process image)
 - Supports the PROFlenergy profile
- Optional accessories
 - Labeling strips (film or card)
 - Equipment labeling plate
 - Color-coded label with module-specific CC code
 - Shielding terminal

A quick and clear comparison of the functions of the different DQ modules is offered by the TIA Selection Tool.

Overview (continued)

Overview of digital output modules

Digital output	PU	Article No.	CC code	BU type
DQ 16 x 24 V DC/0.5 A ST	1	6ES7132-6BH00-0BA0	CC00	A0
DQ 16 x 24 V DC/0.5 A ST	10	6ES7132-6BH00-2BA0	CC00	A0
DQ 8 x 24 V DC/0.5 A SNK BA	1	6ES7132-6BF60-0AA0	CC01	A0
DQ 8 x 24 V DC/0.5 A BA	1	6ES7132-6BF00-0AA0	CC02	A0
DQ 8 x 24 V DC/0.5 A BA	10	6ES7132-6BF00-2AA0	CC02	A0
DQ 8 x 24 V DC/0.5 A ST	1	6ES7132-6BF00-0BA0	CC02	A0
DQ 8 x 24 V DC/0.5 A ST	10	6ES7132-6BF00-2BA0	CC02	A0
DQ 8 x 24 V DC/0.5 A HF	1	6ES7132-6BF00-0CA0	CC02	A0
DQ 4 x 24 V DC/2 A ST	1	6ES7132-6BD20-0BA0	CC02	A0
DQ 4 x 24 V DC/2 A ST	10	6ES7132-6BD20-2BA0	CC02	A0
DQ 4 x 24 V DC/2 A HF	1	6ES7132-6BD20-0CA0	CC02	A0
DQ 4 x 24 V DC/2 A HS	1	6ES7132-6BD20-0DA0	CC02	A0
With three operating modes: • Fast isochronous DQ with valve control • Pulse width modulation • Oversampling				
DQ 4 x 24...230 V AC/2 A ST	1	6ES7132-6FD00-0BB1	CC41	B0, B1
DQ 4 x 24 ... 230 V AC/2 A ST	10	6ES7132-6FD00-2BB1	CC41	B0, B1
RQ 4 x 24 V UC/2 A CO ST	1	6ES7132-6GD50-0BA0	--	A0
RQ 4 x 120 V DC-230 V AC/5 A NO ST	1	6ES7132-6HD00-0BB1	--	B0, B1
RQ 4 x 120 V DC-230 V AC/5 A NO ST	10	6ES7132-6HD00-2BB1	--	B0, B1
RQ MA 4 x 120 V DC...230 V AC/5 A NO ST	1	6ES7132-6MD00-0BB1	--	B0, B1

Overview of BaseUnits

BaseUnit	PU	Article No.	CC codes for process terminals	CC codes for AUX terminals
BU type A0 • New load group (light) • 16 process terminals • With 10 AUX terminals	1	6ES7193-6BP20-0DA0	CC01 to CC05	CC71 to CC73
BU type A0 • New load group (light) • 16 process terminals • With 10 AUX terminals	10	6ES7193-6BP20-2DA0	CC01 to CC05	CC71 to CC73
BU type A0 • New load group (light) • 16 process terminals • Without AUX terminals	1	6ES7193-6BP00-0DA0	CC01 to CC05	--
BU type A0 • New load group (light) • 16 process terminals • Without AUX terminals	10	6ES7193-6BP00-2DA0	CC01 to CC05	--
BU type A0 • Forwarding of load group (dark) • 16 process terminals • With 10 AUX terminals	1	6ES7193-6BP20-0BA0	CC01 to CC05	CC71 to CC73
BU type A0 • Forwarding of load group (dark) • 16 process terminals • With 10 AUX terminals	10	6ES7193-6BP20-2BA0	CC01 to CC05	CC71 to CC73

I/O systems

SIMATIC ET 200 systems for the control cabinet
SIMATIC ET 200SP

I/O modules > Digital output modules

Overview (continued)

BaseUnit	PU	Article No.	CC codes for process terminals	CC codes for AUX terminals
BU type A0 <ul style="list-style-type: none"> Forwarding of load group (dark) 16 process terminals Without AUX terminals 	1	6ES7193-6BP00-0BA0	CC01 to CC05	--
BU type A0 <ul style="list-style-type: none"> Forwarding of load group (dark) 16 process terminals Without AUX terminals 	10	6ES7193-6BP00-2BA0	CC01 to CC05	--
BU type B0 <ul style="list-style-type: none"> Forwarding of load group (dark) 12 process terminals With 4 AUX terminals 	1	6ES7193-6BP20-0BB0	CC41	CC81 to CC83
BU type B0 <ul style="list-style-type: none"> Forwarding of load group (dark) 12 process terminals With 4 AUX terminals 	10	6ES7193-6BP20-0BB0	CC41	CC81 to CC83
BU type B1 <ul style="list-style-type: none"> Forwarding of load group (dark) 12 process terminals 2 x 2 (1L, 2L, 1N, 2N) direct infeed module Without AUX terminals 	1	6ES7193-6BP20-0BB1	CC41	--

Technical specifications

Article number	6ES7132-6BH00-0BA0	6ES7132-6BF60-0AA0	6ES7132-6BF00-0AA0	6ES7132-6BF00-0BA0	6ES7132-6BF00-0CA0
	ET 200SP, DQ 16x24VDC/0,5A ST	ET 200SP, DQ 8x24VDC/0,5A SINK BASIC	ET 200SP, DQ 8x24VDC/0,5A BASIC, PU 1	ET 200SP, DQ 8x24VDC/0,5A ST	ET 200SP, DQ 8x24VDC/0,5A HF
General information					
Product type designation	ET 200SP, DQ 16x 24 V DC/0.5 A ST, PU 1	DQ 8x24VDC/0.5A SNK BA	ET 200SP, DQ 8x 24 V DC/0.5 A BA, PU 1	ET 200SP, DQ 8x 24 V DC/0.5 A ST, PU 1	ET 200SP, DQ 8x 24 V DC/0.5 A HF, PU 1
Product function					
• I&M data	Yes; I&M0 to I&M3	Yes; I&M0 to I&M3	Yes; I&M0 to I&M3	Yes; I&M0 to I&M3	Yes; I&M0 to I&M3
Engineering with					
• STEP 7 TIA Portal configurable/ integrated as of version	V11 SP2 / V13	V13 / V13	V13 SP1 / -	V11 SP2 / V13	V13 SP1 / -
• STEP 7 configurable/integrated as of version	V5.5 SP3 / -	V5.5 SP3 / -	V5.5 SP3 / -	V5.5 SP3 / -	V5.5 / -
• PCS 7 configurable/integrated as of version	V8.1 SP1			V8.1 SP1	V8.1 SP1
• PROFIBUS as of GSD version/ GSD revision	GSD Revision 5	GSD Revision 5	GSD Revision 5	GSD Revision 5	One GSD file each, Revision 3 and 5 and higher
• PROFINET as of GSD version/ GSD revision	GSDML V2.3	GSDML V2.3	GSDML V2.3	GSDML V2.3	GSDML V2.3
Operating mode					
• DQ	Yes	Yes	Yes	Yes	Yes
• DQ with energy-saving function	No	No	No	No	No
• PWM	No	No	No	No	No
• Oversampling	No	No	No	No	No
• MSO	No	No	No	No	Yes
Supply voltage					
Type of supply voltage	DC	DC	DC	DC	DC
Rated value (DC)	24 V	24 V	24 V	24 V	24 V
Reverse polarity protection	Yes		Yes	Yes	Yes

Technical specifications (continued)

Article number	6ES7132-6BH00-0BA0 ET 200SP, DQ 16X24VDC/0,5A ST	6ES7132-6BF60-0AA0 ET 200SP, DQ 8X24VDC/0,5A SINK BASIC	6ES7132-6BF00-0AA0 ET 200SP, DQ 8X24VDC/0,5A BASIC, PU 1	6ES7132-6BF00-0BA0 ET 200SP, DQ 8X24VDC/0,5A ST	6ES7132-6BF00-0CA0 ET 200SP, DQ 8X24VDC/0,5A HF
Digital outputs					
Type of digital output	Source output (PNP, current-sourcing)	Source output (PNP, current-sourcing)	Source output (PNP, current-sourcing)	Source output (PNP, current-sourcing)	Source output (PNP, current-sourcing)
Number of digital outputs	16	8	8	8	8
Current-sinking	No	Yes	No	No	No
Current-sourcing	Yes	No	Yes	Yes	Yes
Digital outputs, parameterizable	Yes	Yes	Yes	Yes	Yes
Short-circuit protection	Yes	Yes	Yes; per channel, electronic	Yes	Yes
Open-circuit detection		No			
Limitation of inductive shutdown voltage to	Typ. L+ (-50 V)	Typ. 47 V	Typ. L+ (-53 V)	Typ. L+ (-50 V)	Typ. L+ (-50 V)
Controlling a digital input	Yes	Yes	Yes	Yes	Yes
Switching capacity of the outputs					
• with resistive load, max.	0.5 A	0.5 A	0.5 A	0.5 A	0.5 A
• on lamp load, max.	5 W	5 W	5 W	5 W	5 W
Load resistance range					
• lower limit	48 Ω	48 Ω	48 Ω	48 Ω	48 Ω
• upper limit	12 kΩ	3 400 Ω	100 kΩ	12 kΩ	12 kΩ
Output voltage					
• Type of output voltage	DC	DC	DC	DC	DC
Output current					
• for signal "1" rated value	0.5 A	0.5 A	0.5 A	0.5 A	0.5 A
• for signal "0" residual current, max.	0.1 mA	5 μA	1 mA	0.1 mA	0.1 mA
Output delay with resistive load					
• "0" to "1", typ.	50 μs				50 μs
• "0" to "1", max.		300 μs	100 μs; at rated load	50 μs; at rated load	
• "1" to "0", typ.	100 μs				100 μs
• "1" to "0", max.		600 μs	150 μs; at rated load	100 μs; at rated load	
Parallel switching of two outputs					
• for uprating	No	No	No	No	No
• for redundant control of a load	Yes	Yes	Yes; per module	Yes	Yes
Switching frequency					
• with resistive load, max.	100 Hz	100 Hz	100 Hz	100 Hz	100 Hz
• with inductive load, max.	2 Hz	0.5 Hz	2 Hz	2 Hz	2 Hz
• on lamp load, max.	10 Hz	10 Hz	10 Hz	10 Hz	10 Hz
Total current of the outputs					
• Current per channel, max.	0.5 A	0.5 A	0.5 A	0.5 A	0.5 A
• Current per module, max.	8 A	4 A	4 A	4 A	4 A
Total current of the outputs (per module)					
horizontal installation					
- up to 30 °C, max.	8 A				
- up to 40 °C, max.	8 A				
- up to 50 °C, max.	6 A				
- up to 60 °C, max.	4 A	4 A	4 A	4 A	4 A
vertical installation					
- up to 30 °C, max.	8 A				
- up to 40 °C, max.	6 A				
- up to 50 °C, max.	4 A		4 A	4 A	4 A; in all other mounting positions
- up to 60 °C, max.	4 A	4 A			
Cable length					
• shielded, max.	1 000 m	1 000 m	1 000 m	1 000 m	1 000 m
• unshielded, max.	600 m	600 m	600 m	600 m	600 m

I/O systems

SIMATIC ET 200 systems for the control cabinet

SIMATIC ET 200SP

I/O modules > Digital output modules**Technical specifications** (continued)

Article number	6ES7132-6BH0-0BA0 ET 200SP, DQ 16X24VDC/0,5A ST	6ES7132-6BF60-0AA0 ET 200SP, DQ 8X24VDC/0,5A SINK BASIC	6ES7132-6BF00-0AA0 ET 200SP, DQ 8X24VDC/0,5A BASIC, PU 1	6ES7132-6BF00-0BA0 ET 200SP, DQ 8X24VDC/0,5A ST	6ES7132-6BF00-0CA0 ET 200SP, DQ 8X24VDC/0,5A HF
Isochronous mode					
Isochronous operation (application synchronized up to terminal)	No	No	No	No	Yes
Execution and activation time (TCO), min.					48 µs
Bus cycle time (TDP), min.					500 µs
Interrupts/diagnostics/status information					
Diagnostics function	Yes	Yes	Yes	Yes	Yes
Substitute values connectable	Yes	No	Yes	Yes	Yes
Alarms					
• Diagnostic alarm	Yes	Yes	Yes	Yes	Yes
Diagnostic messages					
• Monitoring the supply voltage	Yes	Yes	Yes	Yes	Yes
• Wire-break	Yes; Module-wise	No	No	Yes; Module-wise	Yes; channel by channel
• Short-circuit	Yes; Module-wise	No	No	Yes; Module-wise	Yes; channel by channel
• Group error	Yes	Yes	Yes	Yes	Yes
Diagnostics indication LED					
• Monitoring of the supply voltage (PWR-LED)	Yes; green PWR LED	Yes; green PWR LED	Yes; green PWR LED	Yes; green PWR LED	Yes; green PWR LED
• Channel status display	Yes; Green LED	Yes; Green LED	Yes; Green LED	Yes; Green LED	Yes; Green LED
• for channel diagnostics	No	No	No	No	Yes; Red LED
• for module diagnostics	Yes; green/red DIAG LED	Yes; green/red DIAG LED	Yes; green/red DIAG LED	Yes; green/red DIAG LED	Yes; green/red DIAG LED
Potential separation					
Potential separation channels					
• between the channels and backplane bus	Yes	Yes	Yes	Yes	Yes
Isolation					
Isolation tested with	707 V DC (type test)	707 V DC (type test)	707 V DC (type test)	707 V DC (type test)	707 V DC (type test)
Standards, approvals, certificates					
Suitable for safety functions	No	No	No	No	No
Dimensions					
Width	15 mm	15 mm	15 mm	15 mm	15 mm
Height	73 mm	73 mm	73 mm	73 mm	73 mm
Depth	58 mm	58 mm	58 mm	58 mm	58 mm
Weights					
Weight, approx.	28 g	30 g	28 g	28 g	30 g

Technical specifications (continued)

Article number	6ES7132-6BD20-0BA0 ET 200SP, DQ 4x24VDC/2A ST	6ES7132-6BD20-0CA0 ET 200SP, DQ 4x24VDC/2A HF	6ES7132-6BD20-0DA0 ET 200SP, DQ 4x24VDC/2A HIGH SPEED, PU 1	6ES7132-6FD00-0BB1 ET 200SP, DQ 4x24...230VAC/2A ST	6ES7132-6GD50-0BA0 ET 200SP, RQ 4x24VDC/2A CO ST
General information					
Product type designation	ET 200SP, DQ 4x 24 V DC/2 A ST, PU 1	ET 200SP, DQ 4x 24 V DC/2 A HF, PU 1	ET 200SP, DQ 4x 24 V DC/2 A High Speed, PU 1	ET 200SP, DQ 4x 24 ... 230 V AC/ 2 A ST, PU 1	RQ 4x24VDC/2A CO ST
Product function					
• I&M data	Yes; I&M0 to I&M3	Yes; I&M0 to I&M3	Yes; I&M0 to I&M3	Yes; I&M0 to I&M3	Yes; I&M0 to I&M3
Engineering with					
• STEP 7 TIA Portal configurable/ integrated as of version	V11 SP2 / V13	V13 / V13	V13 SP1	V13 / V13	V13 / V13
• STEP 7 configurable/integrated as of version	V5.5 SP3 / -	V5.5 SP3 / -	V5.5 SP3 / -	V5.5 SP3 / -	V5.5 SP3 / -
• PCS 7 configurable/integrated as of version	V8.1 SP1				
• PROFIBUS as of GSD version/ GSD revision	GSD Revision 5	GSD Revision 5	GSD Revision 5	GSD Revision 5	GSD Revision 5
• PROFINET as of GSD version/ GSD revision	GSDML V2.3	GSDML V2.3	GSDML V2.3	GSDML V2.3	GSDML V2.3
Operating mode					
• DQ	Yes	Yes	Yes	Yes	Yes
• DQ with energy-saving function	No	No	Yes; Valve control	No	No
• PWM	No	No	Yes	No	No
• Oversampling	No	No	Yes	No	No
• MSO	No	Yes	No	No	No
Supply voltage					
Type of supply voltage	DC	DC	DC	24V AC to 230V AC	DC
Rated value (DC)	24 V	24 V	24 V		24 V
Rated value (AC)				230 V	
Reverse polarity protection	Yes	Yes	Yes		
Digital outputs					
Type of digital output	Source output (PNP, current-sourcing)	Source output (PNP, current-sourcing)	Source output (PNP, current-sourcing)	Triac with zero point detection	Relays
Number of digital outputs	4	4	4	4	4
Current-sinking	No	No	No	No	
Current-sourcing	Yes	Yes	Yes; Push-pull output	Yes	
Digital outputs, parameterizable	Yes	Yes	Yes	No	
Short-circuit protection	Yes	Yes	Yes	No; When using BU type B1, a miniature, quick-response fuse with 10 A tripping current must be provided	No
Limitation of inductive shutdown voltage to	Typ. L+ (-50 V)	L+ -(37 to 41V)	M (-1 V)		
Controlling a digital input	Yes	Yes; Minimum current consumption 7 mA	No	Yes	
Digital output functions, parameterizable					
• PWM output			Yes		
- Number, max.			4		
- Cycle duration, parameterizable			Yes; 0 ms, 0.2 ms, 0.4 ms, 0.93 ms, 1.33 ms, 4.27 ms, 10.67 ms, 21.33 ms, 34.13 ms, 59.73 ms		
• Digital output with oversampling			Yes		
- Number, max.			4		
- Values per cycle, max.			32		
- Resolution, min.			100 µs		
Switching capacity of the outputs					
• with resistive load, max.	2 A	2 A	2 A	2 A	
• on lamp load, max.	10 W	10 W	10 W	100 W	

I/O systems

SIMATIC ET 200 systems for the control cabinet
SIMATIC ET 200SP

I/O modules > Digital output modules

Technical specifications (continued)

Article number	6ES7132-6BD20-0BA0 ET 200SP, DQ 4X24VDC/2A ST	6ES7132-6BD20-0CA0 ET 200SP, DQ 4X24VDC/2A HF	6ES7132-6BD20-0DA0 ET 200SP, DQ 4X24VDC/2A HIGH SPEED, PU 1	6ES7132-6FD00-0BB1 ET 200SP, DQ 4X24...230VAC/2A ST	6ES7132-6GD50-0BA0 ET 200SP, RQ 4X24VDC/2A CO ST
Load resistance range					
• lower limit	12 Ω	12 Ω	12 Ω		
• upper limit	3 400 Ω	3 400 Ω	3 400 Ω		
Output voltage					
• Type of output voltage	DC	DC	DC	24V AC to 230V AC	DC
• for signal "1", min.				20.4 V	
• permissible voltage at output, min.				20.4 V	
• permissible voltage at output, max.				264 V	
Output current					
• for signal "1" rated value	2 A	2 A	2 A	2 A	
• for signal "0" residual current, max.	0.1 mA	0.1 mA	0.1 mA	460 μA	
Output delay with resistive load					
• "0" to "1", typ.	50 μs	50 μs			
• "0" to "1", max.	50 μs		1 μs	10 ms	
• "1" to "0", typ.	100 μs	100 μs			
• "1" to "0", max.	100 μs		1 μs	10 ms	
Parallel switching of two outputs					
• for logic links				No	
• for uprating	No	No	No	No	
• for redundant control of a load	Yes			Yes	
Switching frequency					
• with resistive load, max.	100 Hz	100 Hz	5 kHz	10 Hz	2 Hz
• with inductive load, max.	2 Hz	2 Hz	5 kHz	0.5 Hz; Higher frequencies are possible, see Equipment Manual / Product Information	
• on lamp load, max.	10 Hz	10 Hz	5 kHz	1 Hz	
Total current of the outputs					
• Current per channel, max.	2 A	2 A	2 A	2 A	2 A
• Current per module, max.	8 A	8 A	8 A	8 A	8 A
Total current of the outputs (per module)					
horizontal installation					
- up to 30 °C, max.	8 A	8 A	8 A; DQ mode		
- up to 40 °C, max.	8 A	8 A	6.9 A; DQ mode	8 A	
- up to 50 °C, max.	6 A	6 A	4.7 A; DQ mode	6 A	
- up to 60 °C, max.	4 A	4 A	2.5 A; DQ mode	4 A	8 A
vertical installation					
- up to 30 °C, max.	8 A	8 A	7.2 A; DQ mode	8 A	
- up to 40 °C, max.	6 A	6 A	5.6 A; DQ mode	6 A	
- up to 50 °C, max.	4 A	4 A	4 A; DQ mode	4 A	
- up to 60 °C, max.	4 A	4 A	4 A; DQ mode		8 A
Relay outputs					
• Number of relay outputs					4
• Rated supply voltage of relay coil L+ (DC)					24 V
• Current consumption of relays (coil current of all relays), max.					40 mA
Switching capacity of contacts					
- with resistive load, max.					2 A
- Thermal continuous current, max.					2 A
- Switching current, min.					1 mA; 5 V DC
- Rated switching voltage (DC)					24 V
- Rated switching voltage (AC)					24 V

Technical specifications (continued)

Article number	6ES7132-6BD20-0BA0 ET 200SP, DQ 4X24VDC/2A ST	6ES7132-6BD20-0CA0 ET 200SP, DQ 4X24VDC/2A HF	6ES7132-6BD20-0DA0 ET 200SP, DQ 4X24VDC/2A HIGH SPEED, PU 1	6ES7132-6FD00-0BB1 ET 200SP, DQ 4X24...230VAC/2A ST	6ES7132-6GD50-0BA0 ET 200SP, RQ 4X24VDC/2A CO ST
Triac outputs					
• Size of motor starters according to NEMA, max.				5	
Cable length					
• shielded, max.	1 000 m	1 000 m	50 m	1 000 m	1 000 m
• unshielded, max.	600 m	600 m	50 m	600 m	200 m
Isochronous mode					
Isochronous operation (application synchronized up to terminal)	No	Yes	Yes; Operating modes DQ and OVS only	No	No
Bus cycle time (TDP), min.		500 µs	125 µs		
Interrupts/diagnostics/status information					
Diagnostics function	Yes	Yes	Yes	No	Yes
Substitute values connectable	Yes	Yes	Yes	Yes	Yes
Alarms					
• Diagnostic alarm	Yes	Yes	Yes	No	Yes
Diagnostic messages					
• Monitoring the supply voltage	Yes	Yes	Yes	No	Yes
• Wire-break	Yes; Module-wise	Yes; channel by channel	No	No	No
• Short-circuit	Yes; Module-wise	Yes; channel by channel	Yes; Module-wise	No	No
• Group error	Yes	Yes	Yes	Yes	Yes
Diagnostics indication LED					
• Monitoring of the supply voltage (PWR-LED)	Yes; green PWR LED	Yes; green PWR LED	Yes; green PWR LED	Yes; green PWR LED	Yes; green PWR LED
• Channel status display	Yes; Green LED	Yes; Green LED	Yes; Green LED	Yes; Green LED	Yes; Green LED
• for channel diagnostics	No	Yes; Red LED	No	No	No
• for module diagnostics	Yes; green/red DIAG LED	Yes; green/red DIAG LED	Yes; green/red DIAG LED	Yes; green/red DIAG LED	Yes; green/red DIAG LED
Potential separation					
Potential separation channels					
• between the channels and backplane bus	Yes	Yes	Yes	Yes	Yes
Isolation					
Isolation tested with	707 V DC (type test)	707 V DC (type test)	707 V DC (type test)	2 545 V DC/2 s (routine test)	707 V DC (type test)
Standards, approvals, certificates					
Suitable for safety functions	No	No	No	No	No
Dimensions					
Width	15 mm	15 mm	15 mm	20 mm	15 mm
Height	73 mm	73 mm	73 mm	73 mm	73 mm
Depth	58 mm	58 mm	58 mm	58 mm	58 mm
Weights					
Weight, approx.	30 g	30 g	31 g	50 g	30 g

I/O systemsSIMATIC ET 200 systems for the control cabinet
SIMATIC ET 200SP**I/O modules > Digital output modules****Technical specifications (continued)**

Article number	6ES7132-6HD00-0BB1 ET 200SP, RQ NO 4X120VDC..230VAC/5A ST	6ES7132-6MD00-0BB1 ET 200SP,RQ NO-MA 4X120VDC..230VAC/5A ST
General information		
Product type designation	ET 200SP, RQ 4x120VDC-230VAC/5A NO ST, PU 1	ET 200SP, RQ 4x120VDC-230VAC/5A NO MA ST
Product function		
• I&M data	Yes; I&M0 to I&M3	Yes; I&M0 to I&M3
Engineering with		
• STEP 7 TIA Portal configurable/ integrated as of version	V13 SP1	V13 SP1
• STEP 7 configurable/integrated as of version	V5.5 SP3 / -	V5.5 SP3 / -
• PROFIBUS as of GSD version/ GSD revision	GSD Revision 5	GSD Revision 5
• PROFINET as of GSD version/ GSD revision	GSDML V2.3	GSDML V2.3
Operating mode		
• DQ	Yes	Yes
• DQ with energy-saving function	No	No
• PWM	No	No
• Oversampling	No	No
• MSO	No	No
Supply voltage		
Type of supply voltage	DC	DC
Rated value (DC)	24 V	24 V
Reverse polarity protection	Yes	Yes
Digital outputs		
Type of digital output	Relays	Relays
Number of digital outputs	4	4
Short-circuit protection	No	No
Output voltage		
• Type of output voltage	AC/DC	AC/DC
Switching frequency		
• with resistive load, max.	2 Hz	2 Hz
• with inductive load, max.	0.5 Hz	0.5 Hz
• on lamp load, max.	2 Hz	2 Hz
Total current of the outputs		
• Current per channel, max.	5 A	5 A
• Current per module, max.	20 A	20 A
Total current of the outputs (per module)		
horizontal installation		
- up to 50 °C, max.		20 A
- up to 60 °C, max.	20 A	16 A
vertical installation		
- up to 40 °C, max.		20 A
- up to 50 °C, max.		16 A
- up to 60 °C, max.	20 A	
Relay outputs		
• Number of relay outputs	4	4
• Rated supply voltage of relay coil L+ (DC)	24 V	24 V
• Current consumption of relays (coil current of all relays), max.	40 mA	40 mA
• external protection for relay outputs	Yes, with 6A	Yes, with 6A
• Number of operating cycles, max.	7 000 000; see additional description in the manual	7 000 000; see additional description in the manual
Switching capacity of contacts		
- with inductive load, max.	2 A; see additional description in the manual	2 A; see additional description in the manual
- with resistive load, max.	5 A; see additional description in the manual	5 A; see additional description in the manual
- Thermal continuous current, max.	5 A; Max. 1 385 VA, 150 W	5 A
- Switching current, min.	100 mA; 5 V DC	100 mA; 5 V DC
- Rated switching voltage (DC)	24 V DC to 120 V DC	24 V DC to 120 V DC
- Rated switching voltage (AC)	24V AC to 230V AC	24V AC to 230V AC

Technical specifications (continued)

Article number	6ES7132-6HD00-0BB1 ET 200SP, RQ NO 4X120VDC..230VAC/5A ST	6ES7132-6MD00-0BB1 ET 200SP,RQ NO-MA 4X120VDC..230VAC/5A ST
Cable length		
• shielded, max.	1 000 m	1 000 m
• unshielded, max.	200 m	200 m
Isochronous mode		
Isochronous operation (application synchronized up to terminal)	No	No
Interrupts/diagnostics/status information		
Diagnostics function	Yes	Yes
Substitute values connectable	Yes	Yes
Alarms		
• Diagnostic alarm	Yes	Yes
Diagnostic messages		
• Monitoring the supply voltage	Yes	Yes
• Wire-break	No	No
• Short-circuit	No	No
• Group error	Yes	Yes
Diagnostics indication LED		
• Monitoring of the supply voltage (PWR-LED)	Yes; green PWR LED	Yes; green PWR LED
• Channel status display	Yes; Green LED	Yes; Green LED
• for channel diagnostics	No	No
• for module diagnostics	Yes; green/red DIAG LED	Yes; green/red DIAG LED
Potential separation		
Potential separation channels		
• between the channels and backplane bus	Yes	Yes
Isolation		
Isolation tested with	2 500 V DC (type test)	2 500 V DC (type test)
tested with		
• between channels and backplane bus/supply voltage	2500 V DC	2500 V DC
• between backplane bus and supply voltage	707 V DC (type test)	707 V DC (type test)
Standards, approvals, certificates		
Suitable for safety functions	No	No
Dimensions		
Width	20 mm	20 mm
Height	73 mm	73 mm
Depth	58 mm	58 mm
Weights		
Weight, approx.	40 g	45 g

I/O systemsSIMATIC ET 200 systems for the control cabinet
SIMATIC ET 200SP**I/O modules > Digital output modules****Ordering data****Article No.****Article No.****Digital output modules**

Delivery options:

Apart from the standard delivery form in an individual package, selected I/O modules and BaseUnits are also available in a pack of 10 units. The pack of 10 units enables the amount of waste to be reduced considerably, as well as saving the time of unpacking individual modules.

The number of modules required is the number of modules ordered. The type of packaging is chosen by selecting the article number. Packs of 10 can therefore only be ordered in integer multiples of 10.

Digital output module
DQ 16x24 V DC/0.5 A Standard,
BU type A0, color code CC00

- PU: 1 unit
- PU: 10 units

Digital output module
DQ 8x24 V DC/0.5 A sink output,
basic, BU type A0,
color code CC01; PU: 1 unit

Digital output module
DQ 8x24 V DC/0.5 A basic,
BU type A0, color code CC02

- PU: 1 unit
- PU: 10 units

Digital output module
DQ 8x24 V DC/0.5 A Standard,
BU type A0, color code CC02

- PU: 1 unit
- PU: 10 units

Digital output module
DQ 8x24 V DC/0.5 A High Feature,
BU type A0, color code CC02;
PU: 1 unit

Digital output module
DQ 4x24 V DC/2 A Standard,
BU type A0, color code CC02

- PU: 1 unit
- PU: 10 units

Digital output module
DQ 4x24 V DC/2 A High Feature,
BU type A0, color code CC02,
channel-precise diagnostics,
isochronous mode,
shared output (MSO); PU: 1 unit

Digital output module
DQ 4x24 V DC/2 A High Feature,
BU type A0, color code CC02,
3 operating modes
(fast isochronous DQ with valve
control, pulse width modulation,
oversampling); PU: 1 unit

Digital output module
DQ 4x24 V AC...230 V AC/2 A
Standard for BU type B1,
color code CC41

- PU: 1 unit
- PU: 10 units

6ES7132-6BH00-0BA0**6ES7132-6BH00-2BA0****6ES7132-6BF60-0AA0****6ES7132-6BF00-0AA0****6ES7132-6BF00-2AA0****6ES7132-6BF00-0BA0****6ES7132-6BF00-2BA0****6ES7132-6BF00-0CA0****6ES7132-6BD20-0BA0****6ES7132-6BD20-2BA0****6ES7132-6BD20-0CA0****6ES7132-6BD20-0DA0****6ES7132-6FD00-0BB1****6ES7132-6FD00-2BB1****Digital output modules
(continued)**

Signal relay module
RQ CO 4x24 V UC/2 A Standard,
changeover contact, BU type A0,
color code CC00; PU: 1 unit

Relay module
RQ NO 4x120 V DC-230 V AC/5 A
Standard, NO contact,
BU type B0, B1

- PU: 1 unit
- PU: 10 units

Relay module
RQ NO 4x120 V DC-230 V AC/5 A
Standard, NO contact, with manual
operation, BU type B0, B1

6ES7132-6GD50-0BA0**6ES7132-6HD00-0BB1****6ES7132-6HD00-2BB1****6ES7132-6MD00-0BB1****Usable BaseUnits****BU15-P16+A10+2D**

BU type A0; BaseUnit (light) with
16 process terminals (1...16) to the
module and an additional 10 inter-
nally jumpered AUX terminals
(1 A to 10 A); for starting a new load
group (max. 10 A)

- PU: 1 unit
- PU: 10 units

6ES7193-6BP20-0DA0**6ES7193-6BP20-2DA0****BU15-P16+A0+2D**

BU type A0; BaseUnit (light) with
16 process terminals to the module;
for starting a new load group
(max. 10 A)

- PU: 1 unit
- PU: 10 units

6ES7193-6BP00-0DA0**6ES7193-6BP00-2DA0****BU15-P16+A10+2B**

BU type A0; BaseUnit (dark) with
16 process terminals (1...16) to the
module and an additional
10 internally jumpered AUX termi-
nals (1 A to 10 A); for continuing
the load group

- PU: 1 unit
- PU: 10 units

6ES7193-6BP20-0BA0**6ES7193-6BP20-2BA0****BU15-P16+A0+2B**

BU type A0; BaseUnit (dark) with
16 process terminals to the module;
for continuing the load group

- PU: 1 unit
- PU: 10 units

6ES7193-6BP00-0BA0**6ES7193-6BP00-2BA0****BU20-P12+A4+0B**

BU type B0; BaseUnit (dark) with
12 process terminals (1...12) to the
module and an additional 4 inter-
nally jumpered AUX terminals
(1 A to 4 A); for continuing the load
group

- PU: 1 unit
- PU: 10 units

6ES7193-6BP20-0BB0**6ES7193-6BP20-2BB0****BU20-P12+A0+4B**

BU type B1; BaseUnit (dark) with
12 process terminals to the module;
for continuing the load group;
PU: 1 unit

6ES7193-6BP20-0BB1

Ordering data	Article No.	Article No.
Accessories		
Equipment labeling plate 10 sheets of 16 labels, for printing with thermal transfer card printer or plotter	6ES7193-6LF30-0AW0	
Labeling strips 500 labeling strips on roll, light gray, for inscription with thermal transfer roll printer	6ES7193-6LR10-0AA0	
500 labeling strips on roll, yellow, for inscription with thermal transfer roll printer	6ES7193-6LR10-0AG0	
1000 labeling strips DIN A4, light gray, card, perforated, for inscription with laser printer	6ES7193-6LA10-0AA0	
1000 labeling strips DIN A4, yellow, card, perforated, for inscription with laser printer	6ES7193-6LA10-0AG0	
BU cover for covering empty slots (gaps); 5 units		
• 15 mm wide	6ES7133-6CV15-1AM0	
• 20 mm wide	6ES7133-6CV20-1AM0	
Shield connection 5 shield supports and 5 shield terminals	6ES7193-6SC00-1AM0	
Color-coded labels for 15 mm-wide BaseUnits		
Color code CC00, for 16 process terminals, for BU type A0, A1, gray (terminals 1 to 8), red (terminals 9 to 16); 10 units	6ES7193-6CP00-2MA0	
Color code CC01, for 16 process terminals, for BU type A0, A1, gray (terminals 1 to 8), red (terminals 9 to 16); 10 units	6ES7193-6CP01-2MA0	
Color code CC02, for 16 process terminals, for BU type A0, A1, gray (terminals 1 to 8), blue (terminals 9 to 16); 10 units	6ES7193-6CP02-2MA0	
Color code CC71, for 10 AUX terminals, BU type A0, yellow/green (terminals 1 A to 10 A); 10 units	6ES7193-6CP71-2AA0	
Color code CC72, for 10 AUX terminals, BU type A0, red (terminals 1 A to 10 A); 10 units	6ES7193-6CP72-2AA0	
Color code CC73, for 10 AUX terminals, BU type A0, blue (terminals 1 A to 10 A); 10 units	6ES7193-6CP73-2AA0	
Color-coded labels for 20 mm-wide BaseUnits		
Color code CC41, for 16 push-in terminals; for BU type B1, gray (terminals 1 to 4), red (terminals 5 to 8), blue (terminals 9 to 12); 10 units	6ES7193-6CP41-2MB0	
Color code CC81, for 4 AUX terminals, BU type B0, yellow/green (terminals 1 A to 4 A); 10 units	6ES7193-6CP81-2AB0	
Color code CC82, for 4 AUX terminals, BU type B0, red (terminals 1 A to 4 A); 10 units	6ES7193-6CP82-2AB0	
Color code CC83, for 4 AUX terminals, BU type B0, blue (terminals 1 A to 4 A); 10 units	6ES7193-6CP83-2AB0	

I/O systems

SIMATIC ET 200 systems for the control cabinet
SIMATIC ET 200SP

I/O modules > Analog input modules

Overview



- 2, 4 and 8-channel analog input (AI) modules
- Apart from the standard delivery form in an individual package, selected I/O modules and BaseUnits are also available in a pack of 10 units. The pack of 10 units enables the amount of waste to be reduced considerably, as well as saving the time of unpacking individual modules.

For different requirements, the digital output modules offer:

- Function classes Basic, Standard, High Feature and High-Speed
- BaseUnits for single or multiple-conductor connection with automatic slot coding
- Individual system-integrated load group formation with self-assembling voltage distribution bars (a separate power module is no longer required for ET 200SP)
- Option of connecting current, voltage and resistance sensors, as well as thermocouples
- Energy Meter for recording up to 200 electrical variables
- Clear labeling on front of module
- LEDs for diagnostics, status, power supply and faults
- Electronically readable and non-volatile writable rating plate (I&M data 0 to 3)

- Extended functions and additional operating modes in some cases
 - MSI operating mode (simultaneous reading of input data from as many as three other controllers)
 - Oversampling operating mode (n-fold equidistant acquisition of analog values within one PN cycle for increasing the time resolution for slow CPU cycles)
 - Isochronous mode (simultaneous equidistant reading in of all analog values)
 - Scalable measuring range (adaptation of measuring range, increase of the 16-bit resolution by adapting the measuring range to a limited section)
 - Scaling of the measured values (transmission of the analog value normalized to the required physical value as a 32-bit floating point value)
 - Internal compensation of the line resistance for thermocouples by means of terminal temperature measurement in the BaseUnit for BU type A1
 - Internal compensation also for 2-conductor resistance measurement by means of adjustable line resistance
 - Calibration during runtime
 - Single-channel electrical isolation
 - HART communication
 - Re-parameterization during operation
 - Firmware update
 - Diagnosis of wire break, short circuit, overflow, underflow
 - Two upper and lower hardware interrupts in each case, interference frequency suppression, smoothing
 - Value status (optional binary validity information of the analog signal in the process image)
 - Supports the PROFlenergy profile
- Optional accessories
 - Labeling strips (film or card)
 - Equipment labeling plate
 - Color-coded label with module-specific CC code
 - Shielding terminal

A quick and clear comparison of the functions of the AI modules is offered by the TIA Selection Tool.

Overview (continued)Overview of analog input modules

Analog input	PU	Article No.	CC code	BU type
AI 8 x I 2/4-wire BA	1	6ES7134-6GF00-0AA1	CC01	A0, A1
AI 2 x U ST	1	6ES7134-6FB00-0BA1	CC00	A0, A1
AI 8 x U BA	1	6ES7134-6FF00-0AA1	CC02	A0, A1
AI 4 x U/I 2-wire ST	1	6ES7134-6HD00-0BA1	CC03	A0, A1
AI 4 x U/I 2-wire ST	10	6ES7134-6HD00-2BA1	CC03	A0, A1
AI 2 x I 2/4-wire ST	1	6ES7134-6GB00-0BA1	CC05	A0, A1
AI 4 x I 2/4-wire ST	1	6ES7134-6GD00-0BA1	CC03	A0, A1
AI 4 x I 2-wire 4...20 mA HART	1	6ES7134-6TD00-0CA1	CC03	A0, A1
AI 2 x U/I 2/4-wire HF	1	6ES7134-6HB00-0CA1	CC05	A0, A1
AI 2xU/I 2/4-wire HS	1	6ES7134-6HB00-0DA1	CC00	A0, A1
With two operating modes: • High-speed isochronous AI • Oversampling				
AI 8 x RTD/TC 2-wire HF	1	6ES7134-6JF00-0CA1	CC00	A0, A1
AI 8 x RTD/TC 2-wire HF	10	6ES7134-6JF00-2CA1	CC00	A0, A1
AI 4 x RTD/TC 2/3/4-wire HF	1	6ES7134-6JD00-0CA1	CC00	A0, A1
AI 4 x RTD/TC 2/3/4-wire HF	10	6ES7134-6JD00-2CA1	CC00	A0, A1
AI Energy Meter 400 V AC ST	1	6ES7134-6PA01-0BD0	--	D0
AI Energy Meter 480 V AC ST	1	6ES7134-6PA20-0BD0	--	D0

Overview of BaseUnits

BaseUnit	PU	Article No.	CC codes for process terminals	CC codes for AUX terminals
BU type A0 • New load group (light) • 16 process terminals • With 10 AUX terminals	1	6ES7193-6BP20-0DA0	CC01 to CC05	CC71 to CC73
BU type A0 • New load group (light) • 16 process terminals • With 10 AUX terminals	10	6ES7193-6BP20-2DA0	CC01 to CC05	CC71 to CC73
BU type A0 • New load group (light) • 16 process terminals • Without AUX terminals	1	6ES7193-6BP00-0DA0	CC01 to CC05	--
BU type A0 • New load group (light) • 16 process terminals • Without AUX terminals	10	6ES7193-6BP00-2DA0	CC01 to CC05	--
BU type A0 • Forwarding of load group (dark) • 16 process terminals • With 10 AUX terminals	1	6ES7193-6BP20-0BA0	CC01 to CC05	CC71 to CC73
BU type A0 • Forwarding of load group (dark) • 16 process terminals • With 10 AUX terminals	10	6ES7193-6BP20-2BA0	CC01 to CC05	CC71 to CC73
BU type A0 • Forwarding of load group (dark) • 16 process terminals • Without AUX terminals	1	6ES7193-6BP00-0BA0	CC01 to CC05	--
BU type A0 • Forwarding of load group (dark) • 16 process terminals • Without AUX terminals	10	6ES7193-6BP00-2BA0	CC01 to CC05	--

I/O systemsSIMATIC ET 200 systems for the control cabinet
SIMATIC ET 200SP**I/O modules > Analog input modules****Overview** (continued)

BaseUnit	PU	Article No.	CC codes for process terminals	CC codes for AUX terminals
BU type A1 • New load group (light) • With temperature sensor • 16 process terminals • With 2x5 additional terminals	1	6ES7193-6BP40-0DA1	CC01 to CC05	CC74
BU type A1 • New load group (light) • With temperature sensor • 16 process terminals • Without 2x5 additional terminals	1	6ES7193-6BP00-0DA1	CC01 to CC05	--
BU type A1 • Forwarding of load group (dark) • With temperature sensor • 16 process terminals • With 2x5 additional terminals	1	6ES7193-6BP40-0BA1	CC01 to CC05	CC74
BU type A1 • Forwarding of load group (dark) • With temperature sensor • 16 process terminals • Without 2x5 additional terminals	1	6ES7193-6BP00-0BA1	CC01 to CC05	--
BU type D0 • Forwarding of load group (dark) • 12 process terminals • Without AUX terminals	1	6ES7193-6BP00-0BD0	--	--

Technical specifications

Article number	6ES7134-6GF00-0AA1 ET 200SP, AI 8xI 2/4-WIRE BASIC	6ES7134-6FB00-0BA1 ET 200SP, AI 2xU STANDARD, PU 1	6ES7134-6FF00-0AA1 ET 200SP, AI 8xU BASIC	6ES7134-6HD00-0BA1 ET 200SP, AI 4xU/I 2-WIRE ST	6ES7134-6GB00-0BA1 ET 200SP, AI 2xI 2/4-WIRE ST, PU 1
General information					
Product type designation	ET 200SP, AI 8xI 2-/4-wire Basic	ET 200SP, AI 2xU Standard	ET 200SP, 8xU Basic	AI 4xU/I 2-wire ST	ET 200SP, AI 2xI 2-/4-wire ST, PU 1
Product function					
• I&M data	Yes; I&M0 to I&M3	Yes; I&M0 to I&M3	Yes; I&M0 to I&M3	Yes; I&M0 to I&M3	Yes; I&M0 to I&M3
• Measuring range scalable	No	No	No	No	No
Engineering with					
• STEP 7 TIA Portal configurable/integrated as of version	V13 SP1	V13 SP1	V13 SP1	V11 SP2 / V13	V13 SP1
• STEP 7 configurable/integrated as of version	V5.5 SP3 / -	V5.5 SP3 / -	V5.5 SP3 / -	V5.5 SP3 / -	V5.5 SP3
• PCS 7 configurable/integrated as of version				V8.1 SP1	
• PROFIBUS as of GSD version/ GSD revision	GSD Revision 5	GSD Revision 5	GSD Revision 5	GSD Revision 5	GSD Revision 5
• PROFINET as of GSD version/ GSD revision	GSDML V2.3	GSDML V2.3	GSDML V2.3	GSDML V2.3	V2.3 / -
Operating mode					
• Oversampling	No	No	No	No	No
• MSI	No	No	No	No	No
CiR – Configuration in RUN					
Reparameterization possible in RUN	Yes	Yes	Yes	Yes	Yes
Calibration possible in RUN	No	No	No	No	No
Supply voltage					
Type of supply voltage	DC	DC	DC	DC	DC
Rated value (DC)	24 V	24 V	24 V	24 V	24 V
Reverse polarity protection	Yes	Yes	Yes	Yes	Yes

Technical specifications (continued)

Article number	6ES7134-6GF00-0AA1 ET 200SP, AI 8XI 2/4-WIRE BASIC	6ES7134-6FB00-0BA1 ET 200SP, AI 2XU STANDARD, PU 1	6ES7134-6FF00-0AA1 ET 200SP, AI 8XU BASIC	6ES7134-6HD00-0BA1 ET 200SP, AI 4XU/I 2-WIRE ST	6ES7134-6GB00-0BA1 ET 200SP, AI 2XI 2/4-WIRE ST, PU 1
Analog inputs					
Number of analog inputs	8; Single-ended	2	8; Single-ended	4; Differential inputs	2
permissible input voltage for voltage input (destruction limit), max.		30 V	30 V	30 V	
permissible input current for current input (destruction limit), max.	50 mA			50 mA	50 mA
Cycle time (all channels), min.	1 ms; per channel	500 µs	1 ms; per channel	Sum of the basic conversion times and additional processing times (depending on the parameterization of the active channels)	500 µs
Input ranges (rated values), voltages					
• 0 to +10 V		Yes; 15 bit	Yes; 15 bit	Yes; 15 bit	
• 1 V to 5 V		Yes; 15 bit		Yes; 15 bit	
• -10 V to +10 V		Yes; 16 bit incl. sign	Yes; 16 bit incl. sign	Yes; 16 bit incl. sign	
• -5 V to +5 V		Yes; 16 bit incl. sign		Yes; 16 bit incl. sign	
Input ranges (rated values), currents					
• 0 to 20 mA	Yes			Yes; 15 bit	Yes; 15 bit
• -20 mA to +20 mA	Yes				Yes; 16 bit incl. sign
• 4 mA to 20 mA	Yes			Yes; 15 bit	Yes; 15 bit
Cable length					
• shielded, max.	200 m	200 m	200 m	1 000 m; 200 m for voltage measurement	1 000 m
Analog value generation for the inputs					
Integration and conversion time/resolution per channel					
• Resolution with overrange (bit including sign), max.	16 bit	16 bit	16 bit	16 bit	16 bit
• Integration time, parameterizable	Yes	Yes	Yes	Yes	Yes
• Interference voltage suppression for interference frequency f1 in Hz	16.67 / 50 / 60 / 4 800 (16.67 / 50 / 60)	16.6 / 50 / 60 Hz / off	16.67 / 50 / 60 / 4 800 (16.67 / 50 / 60)	16.6 / 50 / 60 Hz	16.6 / 50 / 60 Hz / off
• Conversion time (per channel)	180 / 60 / 50 / 0.625 (67.5 / 22.5 / 18.75) ms	50 ms @ 60 Hz, 60 ms @ 50 Hz, 180 ms @ 16.6 Hz, 250 µs without filter	180 / 60 / 50 / 0.625 (67.5 / 22.5 / 18.75) ms	180 / 60 / 50 ms	50 ms @ 60 Hz, 60 ms @ 50 Hz, 180 ms @ 16.6 Hz, 250 µs without filter
Smoothing of measured values					
• Number of smoothing levels	4; None; 4/8/16 times	4	4; None; 4/8/16 times	4; None; 4/8/16 times	4
• parameterizable	Yes	Yes	Yes	Yes	Yes
Encoder					
Connection of signal encoders					
• for voltage measurement	No	Yes	Yes	Yes	
• for current measurement as 2-wire transducer	Yes			Yes	Yes
- Burden of 2-wire transmitter, max.	650 Ω			650 Ω	650 Ω
• for current measurement as 4-wire transducer	Yes		No	No	Yes
Errors/accuracies					
Basic error limit (operational limit at 25 °C)					
• Voltage, relative to input range, (+/-)		0.3 %	0.3 %	0.3 %	0.3 %
• Current, relative to input range, (+/-)	0.3 %			0.3 %	0.3 %

I/O systems

SIMATIC ET 200 systems for the control cabinet
SIMATIC ET 200SP

I/O modules > Analog input modules

Technical specifications (continued)

Article number	6ES7134-6GF00-0AA1 ET 200SP, AI 8XI 2/4-WIRE BASIC	6ES7134-6FB00-0BA1 ET 200SP, AI 2XU STANDARD, PU 1	6ES7134-6FF00-0AA1 ET 200SP, AI 8XU BASIC	6ES7134-6HD00-0BA1 ET 200SP, AI 4XU/I 2-WIRE ST	6ES7134-6GB00-0BA1 ET 200SP, AI 2XI 2/4-WIRE ST, PU 1
Interference voltage suppression for $f = n \times (f_1 \pm 1 \%)$, $f_1 =$ interference frequency					
<ul style="list-style-type: none"> Series mode interference (peak value of interference < rated value of input range), min. Common mode voltage, max. Common mode interference, min. 	70 dB; With conversion time 67.5 / 22.5 / 18.75 ms: 40 dB	70 dB 10 V 90 dB	70 dB; With conversion time 67.5 / 22.5 / 18.75 ms: 40 dB	70 dB 10 V 90 dB	70 dB 10 V 90 dB
Isochronous mode					
Isochronous operation (application synchronized up to terminal)	No	No	No	No	No
Interrupts/diagnostics/status information					
Diagnostics function	Yes	Yes	Yes		Yes
Alarms					
<ul style="list-style-type: none"> Diagnostic alarm Limit value alarm 	Yes No	Yes No	Yes No	Yes No	Yes No
Diagnostic messages					
<ul style="list-style-type: none"> Monitoring the supply voltage Wire-break Short-circuit 	Yes Yes; at 4 to 20 mA Yes; Sensor supply to M; module by module	Yes No Yes; at 1 to 5 V	Yes No No	Yes Yes; at 4 to 20 mA Yes; with 1 to 5 V or 2-wire mode: Short-circuit of the encoder supply to ground or of an input to the encoder supply	Yes Yes; at 4 to 20 mA Yes; Short-circuit of the encoder supply
<ul style="list-style-type: none"> Group error Overflow/underflow 	Yes Yes	Yes Yes	Yes Yes	Yes Yes	Yes Yes
Diagnostics indication LED					
<ul style="list-style-type: none"> Monitoring of the supply voltage (PWR-LED) Channel status display for channel diagnostics for module diagnostics 	Yes; Green LED Yes; Green LED No Yes; green/red DIAG LED	Yes; green PWR LED Yes; Green LED No Yes; green/red DIAG LED	Yes; green PWR LED Yes; Green LED No Yes; green/red DIAG LED	Yes; Green LED Yes; Green LED No Yes; Green/red LED	Yes; green PWR LED Yes; Green LED No Yes; green/red DIAG LED
Potential separation					
Potential separation channels					
between the channels and backplane bus	Yes	Yes	Yes	Yes	Yes
Isolation					
Isolation tested with	707 V DC (type test)	707 V DC (type test)	707 V DC (type test)	707 V DC (type test)	707 V DC (type test)
Standards, approvals, certificates					
Suitable for safety functions	No	No	No	No	No
Dimensions					
Width	15 mm	15 mm	15 mm	15 mm	15 mm
Height	73 mm	73 mm	73 mm	73 mm	73 mm
Depth	58 mm	58 mm	58 mm	58 mm	58 mm
Weights					
Weight, approx.	31 g	31 g	31 g	31 g	32 g

Technical specifications (continued)

Article number	6ES7134-6GD00-0BA1 ET 200SP, AI 4xI 2/4-WIRE ST	6ES7134-6TD00-0CA1 ET 200SP, AI 4xI 2-WIRE 4...20mA HART	6ES7134-6HB00-0CA1 ET 200SP AI 2 X U/I 2, 4-WIRE HF	6ES7134-6HB00-0DA1 ET 200SP AI 2 X U/I 2, 4-WIRE HS
General information				
Product type designation	ET 200SP, AI 4xI 2-/4-wire ST, PU 1	AI 4xI 2-wire 4 ... 20 mA HART	ET 200SP, AI 2x U/I 2-/4-wire High Feature, PU 1	ET 200SP, AI 2xU/I 2-/4-wire High Speed
Product function				
• I&M data	Yes; I&M0 to I&M3	Yes; I&M0 to I&M3	Yes; I&M0 to I&M3	Yes; I&M0 to I&M3
• Measuring range scalable	No	No	No	No
• Scalable measured values				No
• Adjustment of measuring range				No
Engineering with				
• STEP 7 TIA Portal configurable/integrated as of version	V11 SP2 / V13	V13 SP1	V13	V13 SP1
• STEP 7 configurable/integrated as of version	V5.5 SP3 / -	V5.5 SP4 and higher	V5.5 / -	V5.5 SP3 / -
• PCS 7 configurable/integrated as of version	V8.1 SP1	V8.1 SP1	V8.1 SP1	
• PROFIBUS as of GSD version/GSD revision	GSD Revision 5	GSD Revision 5	GSD Revision 5	GSD Revision 5
• PROFINET as of GSD version/GSD revision	GSDML V2.3	GSDML V2.3	GSDML V2.3	GSDML V2.3
Operating mode				
• Oversampling	No	No	No	Yes; 2 channels per module
• MSI	No	No	Yes	No
CiR – Configuration in RUN				
Reparameterization possible in RUN	Yes	Yes	Yes	Yes
Calibration possible in RUN	No	No	Yes	No
Supply voltage				
Type of supply voltage	DC	DC	DC	DC
Rated value (DC)	24 V	24 V	24 V	24 V
Reverse polarity protection	Yes	Yes	Yes	Yes
Analog inputs				
Number of analog inputs	4; Differential inputs	4; Differential inputs	2; Differential inputs	2; Differential inputs
permissible input voltage for voltage input (destruction limit), max.			30 V	30 V
permissible input current for current input (destruction limit), max.	50 mA	50 mA	50 mA	50 mA
Cycle time (all channels), min.	Sum of the basic conversion times and additional processing times (depending on the parameterization of the active channels)			125 µs
Analog input with oversampling			No	Yes
• Values per cycle, max.				16
• Resolution, min.				50 µs
Standardization of measured values			Yes	
Input ranges (rated values), voltages				
• 0 to +10 V			Yes; 15 bit	Yes; 15 bit
• 1 V to 5 V			Yes; 15 bit	Yes; 13 bit
• -10 V to +10 V			Yes; 16 bit incl. sign	Yes; 16 bit incl. sign
• -5 V to +5 V			Yes; 16 bit incl. sign	Yes; 15 bit incl. sign
Input ranges (rated values), currents				
• 0 to 20 mA	Yes	No	Yes; 15 bit	Yes; 15 bit
• -20 mA to +20 mA	Yes	No	Yes; 16 bit incl. sign	Yes; 16 bit incl. sign
• 4 mA to 20 mA	Yes	Yes; 15 bit + sign	Yes; 15 bit	Yes; 14 bit
Cable length				
• shielded, max.	1 000 m	800 m	1 000 m; 200 m for voltage measurement	1 000 m; 200 m for voltage measurement

I/O systems

SIMATIC ET 200 systems for the control cabinet

SIMATIC ET 200SP

I/O modules > Analog input modules**Technical specifications (continued)**

Article number	6ES7134-6GD00-0BA1 ET 200SP, AI 4XI 2/4-WIRE ST	6ES7134-6TD00-0CA1 ET 200SP, AI 4XI 2-WIRE 4...20MA HART	6ES7134-6HB00-0CA1 ET 200SP AI 2 X U/I 2, 4-WIRE HF	6ES7134-6HB00-0DA1 ET 200SP AI 2 X U/I 2, 4-WIRE HS
Analog value generation for the inputs				
Integration and conversion time/resolution per channel				
• Resolution with overrange (bit including sign), max.	16 bit	16 bit	16 bit	16 bit
• Integration time, parameterizable	Yes	Yes; channel by channel	Yes	
• Integration time (ms)			67.5 / 22.5 / 18.75 / 10 / 5 / 2.5 / 1.25 / 0.625 ms	
• Basic conversion time, including integration time (ms)			68.03 / 22.83 / 19.03 / 10.28 / 5.23 / 2.68 / 1.43 / 0.730 ms	
• Interference voltage suppression for interference frequency f1 in Hz	16.6 / 50 / 60 Hz	10 / 50 / 60 Hz	16.6 / 50 / 60 / 300 / 600 / 1 200 / 2 400 / 4 800	No
• Conversion time (per channel)	180 / 60 / 50 ms			10 µs
• Basic execution time of the module (all channels released)			1 ms	
Smoothing of measured values				
• Number of smoothing levels	4; None; 4/8/16 times	4; None; 4/8/16 times	6; none; 2-/4-/8-/16-/32-fold	7; none; 2-/4-/8-/16-/32-/64-fold
• parameterizable	Yes	Yes	Yes	Yes
Encoder				
Connection of signal encoders				
• for voltage measurement	No	No	Yes	Yes
• for current measurement as 2-wire transducer	Yes	Yes	Yes	Yes
- Burden of 2-wire transmitter, max.	650 Ω		650 Ω	650 Ω
• for current measurement as 4-wire transducer	Yes		Yes	Yes
Errors/accuracies				
Basic error limit (operational limit at 25 °C)				
• Voltage, relative to input range, (+/-)			0.05 %; 0.1 % at SFU 4.8 kHz	0.2 %
• Current, relative to input range, (+/-)	0.3 %	0.3 %	0.05 %; 0.1 % at SFU 4.8 kHz	0.2 %
Interference voltage suppression for $f = n \times (f1 \pm 1 \%)$, $f1 =$ interference frequency				
• Series mode interference (peak value of interference < rated value of input range), min.	70 dB	60 dB		
• Common mode voltage, max.	10 V		35 V	35 V
• Common mode interference, min.	90 dB		90 dB	90 dB
Isochronous mode				
Isochronous operation (application synchronized up to terminal)	No	No	Yes	Yes
Filtering and processing time (TCI), min.			800 µs	80 µs
Bus cycle time (TDP), min.			1 ms	125 µs; Starting from firmware Version V2.0.1
Interrupts/diagnostics/status information				
Diagnostics function	Yes	Yes	Yes	
Alarms				
• Diagnostic alarm	Yes	Yes	Yes	Yes
• Limit value alarm	No	Yes	Yes; two upper and two lower limit values in each case	Yes; two upper and two lower limit values in each case

Technical specifications (continued)

Article number	6ES7134-6GD00-0BA1 ET 200SP, AI 4XI 2/4-WIRE ST	6ES7134-6TD00-0CA1 ET 200SP, AI 4XI 2-WIRE 4...20MA HART	6ES7134-6HB00-0CA1 ET 200SP AI 2 X U/I 2, 4-WIRE HF	6ES7134-6HB00-0DA1 ET 200SP AI 2 X U/I 2, 4-WIRE HS
Diagnostic messages				
• Monitoring the supply voltage	Yes	Yes	Yes	Yes
• Wire-break	Yes; at 4 to 20 mA	Yes; channel by channel	Yes; Measuring range 4 to 20 mA only	Yes; channel-by-channel, at 4 to 20 mA only
• Short-circuit	Yes; 2-wire mode: Short-circuit of the encoder supply to ground or of an input to the encoder supply	Yes; Channel-by-channel, short-circuit of the encoder supply to ground or of an input to the encoder supply	Yes; channel-by-channel, at 1 to 5 V or for short-circuit in encoder supply	Yes; channel-by-channel, at 1 to 5 V or for current measuring ranges short- circuit in encoder supply
• Group error	Yes	Yes	Yes	Yes
• Overflow/underflow	Yes	Yes; channel by channel	Yes	Yes
Diagnostics indication LED				
• Monitoring of the supply voltage (PWR-LED)	Yes; Green LED	Yes; green PWR LED	Yes; green PWR LED	Yes; green PWR LED
• Channel status display	Yes; Green LED	Yes; Green LED	Yes; Green LED	Yes; Green LED
• for channel diagnostics	No	Yes; Red LED	Yes; Red LED	Yes; Red LED
• for module diagnostics	Yes; Green/red LED	Yes; green/red DIAG LED	Yes; green/red DIAG LED	Yes; green/red DIAG LED
Potential separation				
Potential separation channels				
• between the channels and backplane bus	Yes	Yes	Yes	Yes
Isolation				
Isolation tested with	707 V DC (type test)	707 V DC (type test)	707 V DC (type test)	707 V DC (type test)
Standards, approvals, certificates				
Suitable for safety functions	No		No	No
Dimensions				
Width	15 mm	15 mm	15 mm	15 mm
Height	73 mm	73 mm	73 mm	73 mm
Depth	58 mm	58 mm	58 mm	58 mm
Weights				
Weight, approx.	31 g	31 g	32 g	32 g
Article number	6ES7134-6JF00-0CA1 ET 200SP, AI 8XRTD/TC 2-WIRE HF		6ES7134-6JD00-0CA1 ET 200SP, AI 4XRTD/TC 2/3/4-WIRE HF	
General information				
Product type designation	ET 200SP, AI 8x RTD/TC 2-wire HF, PU 1		ET 200SP, AI 4x RTD/TC 2-/3-/4-wire HF, PU 1	
Product function				
• I&M data	Yes; I&M0 to I&M3		Yes; I&M0 to I&M3	
Engineering with				
• STEP 7 TIA Portal configurable/ integrated as of version	V13		V12 SP1 / V13	
• STEP 7 configurable/integrated as of version	V5.5 / -		V5.5 SP3 / V5.5 SP4	
• PCS 7 configurable/integrated as of version			V8.1 SP1	
• PROFIBUS as of GSD version/ GSD revision	GSD Revision 5		GSD Revision 5	
• PROFINET as of GSD version/ GSD revision	GSDML V2.3		GSDML V2.3	
Operating mode				
• Oversampling	No		No	
• MSI	No		No	
CiR – Configuration in RUN				
Reparameterization possible in RUN	Yes		Yes	
Calibration possible in RUN	Yes		Yes	
Supply voltage				
Type of supply voltage	DC		DC	
Rated value (DC)	24 V		24 V	
Reverse polarity protection	Yes		Yes	

I/O systemsSIMATIC ET 200 systems for the control cabinet
SIMATIC ET 200SP**I/O modules > Analog input modules****Technical specifications** (continued)

Article number	6ES7134-6JF00-0CA1 ET 200SP, AI 8XRTD/TC 2-WIRE HF	6ES7134-6JD00-0CA1 ET 200SP, AI 4XRTD/TC 2/3/4-WIRE HF
Analog inputs		
Number of analog inputs	8	4
permissible input voltage for voltage input (destruction limit), max.	30 V	30 V
Constant measurement current for resistance-type transmitter, typ.	2 mA	0.7 mA; 1.7 mA for Cu10 sensors
Cycle time (all channels), min.	Sum of the basic conversion times and additional processing times (depending on the parameterization of the active channels)	Sum of the basic conversion times and additional processing times (depending on the parameterization of the active channels); for line compensation in case of a three-wire connection, an additional cycle is necessary
Technical unit for temperature measurement adjustable	Yes; °C/°F/K	Yes; °C/°F/K
Input ranges (rated values), voltages		
• -1 V to +1 V	Yes; 16 bit incl. sign	Yes; 16 bit incl. sign
• -250 mV to +250 mV	Yes; 16 bit incl. sign	Yes; 16 bit incl. sign
• -50 mV to +50 mV	Yes; 16 bit incl. sign	Yes; 16 bit incl. sign
• -80 mV to +80 mV	Yes; 16 bit incl. sign	Yes; 16 bit incl. sign
Input ranges (rated values), thermocouples		
• Type B	Yes; 16 bit incl. sign	Yes; 16 bit incl. sign
• Type C	Yes; 16 bit incl. sign	Yes; 16 bit incl. sign
• Type E	Yes; 16 bit incl. sign	Yes; 16 bit incl. sign
• Type J	Yes; 16 bit incl. sign	Yes; 16 bit incl. sign
• Type K	Yes; 16 bit incl. sign	Yes; 16 bit incl. sign
• Type L	Yes; 16 bit incl. sign	Yes; 16 bit incl. sign
• Type N	Yes; 16 bit incl. sign	Yes; 16 bit incl. sign
• Type R	Yes; 16 bit incl. sign	Yes; 16 bit incl. sign
• Type S	Yes; 16 bit incl. sign	Yes; 16 bit incl. sign
• Type T	Yes; 16 bit incl. sign	Yes; 16 bit incl. sign
• Type U	Yes; 16 bit incl. sign	Yes; 16 bit incl. sign
• Type TXK/TXK(L) to GOST	Yes; 16 bit incl. sign	Yes; 16 bit incl. sign
Input ranges (rated values), resistance thermometer		
• Cu 10		Yes; 16 bit incl. sign
• Ni 100	Yes; 16 bit incl. sign	Yes; 16 bit incl. sign
• Ni 1000	Yes; 16 bit incl. sign	Yes; 16 bit incl. sign
• LG-Ni 1000	Yes; 16 bit incl. sign	Yes; 16 bit incl. sign
• Ni 120	Yes; 16 bit incl. sign	Yes; 16 bit incl. sign
• Ni 200	Yes; 16 bit incl. sign	Yes; 16 bit incl. sign
• Ni 500	Yes; 16 bit incl. sign	Yes; 16 bit incl. sign
• Pt 100	Yes; 16 bit incl. sign	Yes; 16 bit incl. sign
• Pt 1000	Yes; 16 bit incl. sign	Yes; 16 bit incl. sign
• Pt 200	Yes; 16 bit incl. sign	Yes; 16 bit incl. sign
• Pt 500	Yes; 16 bit incl. sign	Yes; 16 bit incl. sign
Input ranges (rated values), resistors		
• 0 to 150 ohms	Yes; 15 bit	Yes; 15 bit
• 0 to 300 ohms	Yes; 15 bit	Yes; 15 bit
• 0 to 600 ohms	Yes; 15 bit	Yes; 15 bit
• 0 to 3000 ohms	Yes; 15 bit	Yes; 15 bit
• 0 to 6000 ohms	Yes; 15 bit	Yes; 15 bit
• PTC	Yes; 15 bit	Yes; 15 bit
Thermocouple (TC)		
Temperature compensation		
- parameterizable	Yes	Yes
Cable length		
• shielded, max.	200 m; 50 m with thermocouples	200 m; 50 m with thermocouples

Technical specifications (continued)

Article number	6ES7134-6JF00-0CA1 ET 200SP, AI 8XRTD/TC 2-WIRE HF	6ES7134-6JD00-0CA1 ET 200SP, AI 4XRTD/TC 2/3/4-WIRE HF
Analog value generation for the inputs		
Integration and conversion time/resolution per channel		
• Resolution with overrange (bit including sign), max.	16 bit	16 bit
• Integration time, parameterizable	Yes	Yes
• Basic conversion time, including integration time (ms)		
- additional processing time for wire-break check	2 ms; In the ranges resistance thermometers, resistors and thermocouples	2 ms; In the ranges resistance thermometers, resistors and thermocouples
- additional power line wire-break check		2 ms; for 3/4 wire transducer (resistance thermometer and resistor)
• Interference voltage suppression for interference frequency f_1 in Hz	16.6 / 50 / 60 Hz	16.6 / 50 / 60 Hz
• Conversion time (per channel)	180 / 60 / 50 ms	180 / 60 / 50 ms
Smoothing of measured values		
• Number of smoothing levels	4; None; 4/8/16 times	4; None; 4/8/16 times
• parameterizable	Yes	Yes
Encoder		
Connection of signal encoders		
• for voltage measurement	Yes	Yes
• for resistance measurement with two-wire connection	Yes	Yes
• for resistance measurement with three-wire connection	No	Yes
• for resistance measurement with four-wire connection	No	Yes
Errors/accuracies		
Basic error limit (operational limit at 25 °C)		
• Voltage, relative to input range, (+/-)	0.05 %	0.05 %
• Resistance, relative to input range, (+/-)	0.05 %	0.05 %
Interference voltage suppression for $f = n \times (f_1 \pm 1 \%)$, $f_1 =$ interference frequency		
• Series mode interference (peak value of interference < rated value of input range), min.	70 dB	70 dB
• Common mode voltage, max.	10 V	10 V
• Common mode interference, min.	90 dB	90 dB
Isochronous mode		
Isochronous operation (application synchronized up to terminal)	No	No
Interrupts/diagnostics/status information		
Diagnostics function	Yes	Yes
Alarms		
• Diagnostic alarm	Yes	Yes
• Limit value alarm	Yes; two upper and two lower limit values in each case	Yes; two upper and two lower limit values in each case
Diagnostic messages		
• Monitoring the supply voltage	Yes	Yes
• Wire-break	Yes; channel by channel	Yes; channel by channel
• Group error	Yes	Yes
• Overflow/underflow	Yes; channel by channel	Yes; channel by channel
Diagnostics indication LED		
• Monitoring of the supply voltage (PWR-LED)	Yes; green PWR LED	Yes; green PWR LED
• Channel status display	Yes; Green LED	Yes; Green LED
• for channel diagnostics	Yes; Red LED	Yes; Red LED
• for module diagnostics	Yes; green/red DIAG LED	Yes; green/red DIAG LED

I/O systemsSIMATIC ET 200 systems for the control cabinet
SIMATIC ET 200SP**I/O modules > Analog input modules****Technical specifications** (continued)

Article number	6ES7134-6JF00-0CA1	6ES7134-6JD00-0CA1
	ET 200SP, AI 8XRTD/TC 2-WIRE HF	ET 200SP, AI 4XRTD/TC 2/3/4-WIRE HF
Potential separation		
Potential separation channels		
• between the channels and backplane bus	Yes	Yes
Isolation		
Isolation tested with	707 V DC (type test)	707 V DC (type test)
Standards, approvals, certificates		
Suitable for safety functions	No	No
Dimensions		
Width	15 mm	15 mm
Height	73 mm	73 mm
Depth	58 mm	58 mm
Weights		
Weight, approx.	32 g	30 g
Article number	6ES7134-6PA01-0BD0	6ES7134-6PA20-0BD0
	ET 200SP AI ENERGY METER 400VAC ST	ET 200SP AI ENERGY METER 480VAC ST
General information		
Product type designation	ET 200SP, AI Energy Meter 400 V AC ST, PU 1	ET 200SP, AI Energy Meter 480 V AC ST, PU 1
Product function		
• Voltage measurement	Yes	Yes
• Voltage measurement with voltage transformers	No	Yes
• Current measurement	Yes	Yes
• Phase current measurement without current transformers	No	No
• Phase current measurement with current transformers	Yes	Yes
• Energy measurement	Yes	Yes
• Frequency measurement	Yes	Yes
• Power measurement	Yes	Yes
• Active power measurement	Yes	Yes
• Reactive power measurement	Yes	Yes
• I&M data	Yes; I&M0 to I&M3	Yes; I&M0 to I&M3
• Isochronous mode	No	No
Engineering with		
• STEP 7 TIA Portal configurable/integrated as of version	V13 SP1	V13 SP1
• STEP 7 configurable/integrated as of version	V5.5 SP4 and higher	V5.5 SP4 and higher
• PROFIBUS as of GSD version/GSD revision	GSD Revision 5	GSD Revision 5
• PROFINET as of GSD version/GSD revision	V2.3	V2.3
Operating mode		
• cyclic measurement	Yes	Yes
• acyclic measurement	Yes	Yes
• Acyclic measured value access	Yes	Yes
• Fixed measured value sets	Yes	Yes
• Freely definable measured value sets	No	Yes
CiR – Configuration in RUN		
Reparameterization possible in RUN	Yes	Yes
Calibration possible in RUN	No	Yes
Installation type/mounting		
Mounting position	Any	Any

Technical specifications (continued)

Article number	6ES7134-6PA01-0BD0 ET 200SP AI ENERGY METER 400VAC ST	6ES7134-6PA20-0BD0 ET 200SP AI ENERGY METER 480VAC ST
Supply voltage		
Design of the power supply	Supply via voltage measurement channel L1	Supply via voltage measurement channel L1
Type of supply voltage	100 - 240 V AC	AC 100 - 277 V
permissible range, lower limit (AC)	90 V	90 V
permissible range, upper limit (AC)	264 V	293 V
Line frequency		
• permissible range, lower limit	47 Hz	47 Hz
• permissible range, upper limit	63 Hz	63 Hz
Address area		
Address space per module		
• Address space per module, max.	44 byte; 32 byte input / 12 byte output	268 byte; 256 byte input / 12 byte output
Analog inputs		
Cycle time (all channels), typ.	50 ms; Time for consistent update of all measured and calculated values (cyclic und acyclic data)	50 ms; Time for consistent update of all measured and calculated values (cyclic und acyclic data)
Interrupts/diagnostics/ status information		
Alarms		
• Diagnostic alarm	Yes	Yes
• Limit value alarm	No	Yes
• Hardware interrupt	No	Yes; Monitoring of up to 16 freely selectable process values (exceeding or undershooting of value)
Diagnostics indication LED		
• Monitoring of the supply voltage (PWR-LED)	Yes	Yes
• Channel status display	Yes; Green LED	Yes; Green LED
• for channel diagnostics	Yes; red Fn LED	Yes; red Fn LED
• for module diagnostics	Yes; green/red DIAG LED	Yes; green/red DIAG LED
Integrated Functions		
Measuring functions		
• Measuring procedure for voltage measurement	TRMS	TRMS
• Measuring procedure for current measurement	TRMS	TRMS
• Type of measured value acquisition	seamless	seamless
• Curve shape of voltage	Sinusoidal or distorted	Sinusoidal or distorted
• Buffering of measured variables	No	Yes
• Parameter length	38 byte	74 byte
• Bandwidth of measured value acquisition	2 kHz; Harmonics: 39 / 50 Hz, 32 / 60 Hz	2 kHz; Harmonics: 39 / 50 Hz, 32 / 60 Hz
Operating mode for measured value acquisition		
- automatic detection of line frequency	No; Parameterizable	No; Parameterizable
Measuring range		
- Frequency measurement, min.	45 Hz	45 Hz
- Frequency measurement, max.	65 Hz	65 Hz
Measuring inputs for voltage		
- Measurable line voltage between phase and neutral conductor	230 V	277 V
- Measurable line voltage between the line conductors	400 V	480 V
- Measurable line voltage between phase and neutral conductor, min.	90 V	90 V
- Measurable line voltage between phase and neutral conductor, max.	264 V	293 V
- Measurable line voltage between the line conductors, min.	155 V	155 V
- Measurable line voltage between the line conductors, max.	460 V	508 V
- Measurement category for voltage measurement in accordance with IEC 61010-2-030	CAT II; CAT III in case of guaranteed protection level of 1.5 kV	CAT II; CAT III in case of guaranteed protection level of 1.5 kV
- Internal resistance line conductor and neutral conductor	3.4 MΩ	3.4 MΩ

I/O systems

SIMATIC ET 200 systems for the control cabinet

SIMATIC ET 200SP

I/O modules > Analog input modules**Technical specifications (continued)**

Article number	6ES7134-6PA01-0BD0 ET 200SP AI ENERGY METER 400VAC ST	6ES7134-6PA20-0BD0 ET 200SP AI ENERGY METER 480VAC ST
Measuring inputs for voltage (continued)		
- Power consumption per phase	20 mW	20 mW
- Impulse voltage resistance 1,2/50µs	1 kV	1 kV
Measuring inputs for current		
- measurable relative current (AC), min.	5 %; Relative to the secondary rated current; 1 A, 5 A	1 %; Relative to the secondary rated current 5 A
- measurable relative current (AC), max.	100 %; Relative to the secondary rated current; 1 A, 5 A	100 %; Relative to the secondary rated current 5 A
- Continuous current with AC, maximum permissible	5 A	5 A
- Apparent power consumption per phase for measuring range 5 A	0.6 V·A	0.6 V·A
- Rated value short-time withstand current restricted to 1 s	100 A	100 A
- Input resistance measuring range 0 to 5 A	25 mΩ; At the terminal	25 mΩ; At the terminal
- Zero point suppression	Parameterizable: 20 - 250 mA, default 50 mA	Parameterizable: 2 - 250 mA, default 50 mA
- Surge strength	10 A; for 1 minute	10 A; for 1 minute
Accuracy class according to IEC 61557-12		
- Measured variable voltage	0.5	0.2
- Measured variable current	0.5	0.2
- Measured variable apparent power	1	0.5
- Measured variable active power	1	0.5
- Measured variable reactive power	1	1
- Measured variable power factor	0.5	0.5
- Measured variable active energy	1	0.5
- Measured variable reactive energy	2	1
- Measured variable neutral current		0.5; calculated
- Measured variable phase angle	±1 °; not covered by IEC 61557-12	±1 °; not covered by IEC 61557-12
- Measured variable frequency	0.05	0.05
Potential separation		
Potential separation channels		
• between the channels and backplane bus	Yes; 3 700V AC (type test) CAT III	Yes; 3 700V AC (type test) CAT III
Isolation		
Isolation tested with	2 300V AC for 1 min. (type test)	2 300V AC for 1 min. (type test)
Ambient conditions		
Ambient temperature during operation		
• horizontal installation, min.	0 °C	0 °C
• horizontal installation, max.	60 °C	60 °C
• vertical installation, min.	0 °C	0 °C
• vertical installation, max.	50 °C	50 °C
Dimensions		
Width	20 mm	20 mm
Height	73 mm	73 mm
Depth	58 mm	58 mm
Weights		
Weight (without packaging)	45 g	45 g
Data for selecting a current transformer		
• Burden power current transformer x/1A, min.	As a function of cable length and cross section, see device manual	As a function of cable length and cross section, see device manual
• Burden power current transformer x/5A, min.	As a function of cable length and cross section, see device manual	As a function of cable length and cross section, see device manual

Ordering data	Article No.	Article No.
<p>Analog input modules</p> <p>Delivery options: Apart from the standard delivery form in an individual package, selected I/O modules and BaseUnits are also available in a pack of 10 units. The pack of 10 units enables the amount of waste to be reduced considerably, as well as saving the time of unpacking individual modules.</p> <p>The number of modules required is the number of modules ordered. The type of packaging is chosen by selecting the article number. Packs of 10 can therefore only be ordered in integer multiples of 10.</p> <p>Analog input module AI 8xI 2/4-wire BA, BU type A0 or A1, color code CC01</p> <p>Analog input module AI 2xU ST, BU type A0 or A1, color code CC00</p> <p>Analog input module AI 8xU BA, BU type A0 or A1, color code CC02</p> <p>Analog input module AI 4xU/I 2-wire Standard, BU type A0 or A1, color code CC03, 16-bit, $\pm 0.3\%$</p> <ul style="list-style-type: none"> • 1 unit • 10 units <p>Analog input module AI 2xI 2/4-wire Standard, BU type A0 or A1, color code CC05, 16-bit</p> <p>Analog input module AI 4xI 2/4-wire Standard, BU type A0 or A1, color code CC03, 16-bit, $\pm 0.3\%$</p> <p>Analog input module AI 4xI 2-wire 4...20 mA HART, BU type A0 or A1, color code CC03</p> <p>Analog input module AI 2xU/I 2/4-wire High Feature, BU type A0 or A1, color code CC05, 16-bit, $\pm 0.1\%$, independent channel isolation, isochronous mode above 1 ms</p> <p>Analog input module AI 2xU/I 2/4-wire High Speed, BU type A0 or A1, color code CC00, 16-bit, $\pm 0.3\%$, isochronous mode above 250 μs, oversampling above 50 μs</p> <p>Analog input module AI 8xRTD/TC 2-wire High Feature, BU type A0 or A1, color code CC00, 16-bit, $\pm 0.1\%$, scalable measuring range</p> <ul style="list-style-type: none"> • 1 unit • 10 units 	<p>6ES7 134-6GF00-0AA1</p> <p>6ES7134-6FB00-0BA1</p> <p>6ES7 134-6FF00-0AA1</p> <p>6ES7134-6HD00-0BA1 6ES7134-6HD00-2BA1</p> <p>6ES7134-6GB00-0BA1</p> <p>6ES7134-6GD00-0BA1</p> <p>6ES7134-6TD00-0CA1</p> <p>6ES7134-6HB00-0CA1</p> <p>6ES7134-6HB00-0DA1</p> <p>6ES7134-6JF00-0CA1 6ES7134-6JF00-2CA1</p>	<p>Analog input modules (continued)</p> <p>Analog input module AI 4xRTD/TC 2, 3, 4-wire High Feature, BU type A0 or A1, color code CC00, 16-bit, $\pm 0.1\%$, scalable measuring range</p> <ul style="list-style-type: none"> • 1 unit • 10 units <p>Analog input module AI Energy Meter Standard, 400 V AC, BU type D0</p> <p>6ES7134-6JD00-0CA1 6ES7134-6JD00-2CA1</p> <p>6ES7134-6PA01-0BD0</p> <p>Analog input module AI Energy Meter Standard, 480 V AC, BU type D0</p> <p>6ES7134-6PA20-0BD0</p> <p>Usable type A0 BaseUnits</p> <p>BU15-P16+A10+2D</p> <p>BU type A0; BaseUnit (light) with 16 process terminals (1...16) to the module and an additional 10 internally jumpered AUX terminals (1 A to 10 A); for starting a new load group (max. 10 A)</p> <ul style="list-style-type: none"> • 1 unit • 10 units <p>6ES7193-6BP20-0DA0 6ES7193-6BP20-2DA0</p> <p>BU15-P16+A0+2D</p> <p>BU type A0; BaseUnit (light) with 16 process terminals to the module; for starting a new load group (max. 10 A)</p> <ul style="list-style-type: none"> • 1 unit • 10 units <p>6ES7193-6BP00-0DA0 6ES7193-6BP00-2DA0</p> <p>BU15-P16+A10+2B</p> <p>BU type A0; BaseUnit (dark) with 16 process terminals (1...16) to the module and an additional 10 internally jumpered AUX terminals (1 A to 10 A); for continuing the load group</p> <ul style="list-style-type: none"> • 1 unit • 10 units <p>6ES7193-6BP20-0BA0 6ES7193-6BP20-2BA0</p> <p>BU15-P16+A0+2B</p> <p>BU type A0; BaseUnit (dark) with 16 process terminals to the module; for continuing the load group</p> <ul style="list-style-type: none"> • 1 unit • 10 units <p>6ES7193-6BP00-0BA0 6ES7193-6BP00-2BA0</p>

I/O systemsSIMATIC ET 200 systems for the control cabinet
SIMATIC ET 200SP**I/O modules > Analog input modules**

Ordering data	Article No.	Ordering data	Article No.
Usable type A1 BaseUnits (temperature detection)		Shield connection	6ES7193-6SC00-1AM0
BU15-P16+A0+12D/T	6ES7193-6BP40-0DA1	5 shield supports and 5 shield terminals	
BU type A1; BaseUnit (light) with 16 process terminals (1...16) to the module and an additional 2x5 internally jumpered additional terminals (1 B to 5 B and 1 C to 5 C); for starting a new load group (max. 10 A)		Color-coded labels	6ES7193-6CP00-2MA0
BU15-P16+A0+2D/T	6ES7193-6BP00-0DA1	Color code CC00, for 16 process terminals, for BU type A0, A1, gray (terminals 1 to 8), red (terminals 9 to 16); 10 units	
BU type A1; BaseUnit (light) with 16 process terminals to the module; for starting a new load group (max. 10 A)		Color code CC01, for 16 process terminals, for BU type A0, A1, gray (terminals 1 to 8), red (terminals 9 to 16); 10 units	6ES7193-6CP01-2MA0
BU15-P16+A0+12B/T	6ES7193-6BP40-0BA1	Color code CC02, for 16 process terminals, for BU type A0, A1, gray (terminals 1 to 8), blue (terminals 9 to 16); 10 units	6ES7193-6CP02-2MA0
BU type A1; BaseUnit (dark) with 16 process terminals (1...16) to the module and an additional 2x5 internally jumpered additional terminals (1 B to 5 B and 1 C to 5 C); for continuing the load group		Color code CC03, for 16 push-in terminals, for BU type A0, A1 gray (terminals 1 to 8), red (terminals 9 to 12), gray (terminals 13 to 16); 10 units	6ES7193-6CP03-2MA0
BU15-P16+A0+2B/T	6ES7193-6BP00-0BA1	Color code CC05, for 16 push-in terminals, for BU type A0, A1, gray (terminals 1 to 12), red (terminals 13 to 14), blue (terminals 15 to 16); 10 units	6ES7193-6CP05-2MA0
BU type A1; BaseUnit (dark) with 16 process terminals to the module; for continuing the load group		Color code CC71, for 10 AUX terminals, BU type A0, yellow/green (terminals 1 A to 10 A); 10 units	6ES7193-6CP71-2AA0
Usable type D0 BaseUnits		Color code CC72, for 10 AUX terminals, BU type A0, red (terminals 1 A to 10 A); 10 units	6ES7193-6CP72-2AA0
BU20-P12+A0+0B	6ES7193-6BP00-0BD0	Color code CC73, for 10 AUX terminals, BU type A0, blue (terminals 1 A to 10 A); 10 units	6ES7193-6CP73-2AA0
BU type D0; BaseUnit with 12 push-in terminals, without AUX terminals, bridged to the left		Color code CC74, for 2x5 additional terminals, BU type A1, red (terminals 1B to 5B), blue (terminals 1C to 5C); 10 units	6ES7193-6CP74-2AA0
Accessories			
Equipment labeling plate	6ES7193-6LF30-0AW0		
10 sheets of 16 labels, for printing with thermal transfer card printer or plotter			
Labeling strips			
500 labeling strips on roll, light gray, for inscription with thermal transfer roll printer	6ES7193-6LR10-0AA0		
500 labeling strips on roll, yellow, for inscription with thermal transfer roll printer	6ES7193-6LR10-0AG0		
1000 labeling strips DIN A4, light gray, card, perforated, for inscription with laser printer	6ES7193-6LA10-0AA0		
1000 labeling strips DIN A4, yellow, card, perforated, for inscription with laser printer	6ES7193-6LA10-0AG0		
BU cover			
for covering empty slots (gaps); 5 units			
• 15 mm wide	6ES7133-6CV15-1AM0		
• 20 mm wide	6ES7133-6CV20-1AM0		

Overview



- 2 and 4-channel analog output (AQ) modules
- Apart from the standard delivery form in an individual package, selected I/O modules and BaseUnits are also available in a pack of 10 units. The pack of 10 units enables the amount of waste to be reduced considerably, as well as saving the time of unpacking individual modules.

For different requirements, the digital output modules offer:

- Function classes Standard, High Feature and High-Speed
- BaseUnits for single or multiple-conductor connection with automatic slot coding
- Individual system-integrated load group formation with self-assembling voltage distribution bars (a separate power module is no longer required for ET 200SP)
- Option for connecting current and voltage actuators

Overview of analog output modules

Analog output	PU	Article No.	CC code	BU type
AQ 2 x U ST	1	6ES7135-6FB00-0BA1	CC00	A0, A1
AQ 2 x I ST	1	6ES7135-6GB00-0BA1	CC00	A0, A1
AQ 4 x U/I ST	1	6ES7135-6HD00-0BA1	CC00	A0, A1
AQ 2 x U/I HF	1	6ES7135-6HB00-0CA1	CC00	A0, A1
AQ 2 x U/I HS	1	6ES7135-6HB00-0DA1	CC00	A0, A1

With two operating modes:

- High-speed isochronous AQ
- Oversampling

- Clear labeling on front of module
- LEDs for diagnostics, status, power supply and faults
- Electronically readable and non-volatile writable rating plate (I&M data 0 to 3)
- Extended functions and additional operating modes in some cases
 - Oversampling (n-fold equidistant output of an analog value within one PN cycle and thus the precisely timed output of an analog value or a sequence of analog values)
 - Isochronous mode (simultaneous equidistant output of analog values)
 - Output of substitute value in the event of interruptions to communication (shutdown, output adjustable substitute value, or keep last value)
 - Calibration during runtime
 - Re-parameterization during operation
 - Firmware update
 - Diagnosis of wire break, short circuit, overflow, underflow
 - Value status (optional binary validity information of the analog signal in the process image)
 - Supports the PROFlenergy profile
- Optional accessories
 - Labeling strips (film or card)
 - Equipment labeling plate
 - Color-coded label with module-specific CC code
 - Shielding terminal

A quick and clear comparison of the functions of the AQ modules is offered by the TIA Selection Tool.

I/O systems

SIMATIC ET 200 systems for the control cabinet
SIMATIC ET 200SP

I/O modules > Analog output modules**Overview** (continued)

Overview of BaseUnits

BaseUnit	PU	Article No.	CC codes for process terminals	CC codes for AUX terminals
BU type A0 • New load group (light) • 16 process terminals • With 10 AUX terminals	1	6ES7193-6BP20-0DA0	CC01 to CC05	CC71 to CC73
BU type A0 • New load group (light) • 16 process terminals • With 10 AUX terminals	10	6ES7193-6BP20-2DA0	CC01 to CC05	CC71 to CC73
BU type A0 • New load group (light) • 16 process terminals • Without AUX terminals	1	6ES7193-6BP00-0DA0	CC01 to CC05	--
BU type A0 • New load group (light) • 16 process terminals • Without AUX terminals	10	6ES7193-6BP00-2DA0	CC01 to CC05	--
BU type A0 • Forwarding of load group (dark) • 16 process terminals • With 10 AUX terminals	1	6ES7193-6BP20-0BA0	CC01 to CC05	CC71 to CC73
BU type A0 • Forwarding of load group (dark) • 16 process terminals • With 10 AUX terminals	10	6ES7193-6BP20-2BA0	CC01 to CC05	CC71 to CC73
BU type A0 • Forwarding of load group (dark) • 16 process terminals • Without AUX terminals	1	6ES7193-6BP00-0BA0	CC01 to CC05	--
BU type A0 • Forwarding of load group (dark) • 16 process terminals • Without AUX terminals	10	6ES7193-6BP00-2BA0	CC01 to CC05	--
BU type A1 • New load group (light) • With temperature sensor • 16 process terminals • With 2x5 additional terminals	1	6ES7193-6BP40-0DA1	CC01 to CC05	CC74
BU type A1 • New load group (light) • With temperature sensor • 16 process terminals • Without 2x5 additional terminals	1	6ES7193-6BP00-0DA1	CC01 to CC05	--
BU type A1 • Forwarding of load group (dark) • With temperature sensor • 16 process terminals • With 2x5 additional terminals	1	6ES7193-6BP40-0BA1	CC01 to CC05	CC74
BU type A1 • Forwarding of load group (dark) • With temperature sensor • 16 process terminals • Without 2x5 additional terminals	1	6ES7193-6BP00-0BA1	CC01 to CC05	--

Technical specifications

Article number	6ES7135-6FB00-0BA1 ET 200SP, AQ 2xU STANDARD, PU 1	6ES7135-6GB00-0BA1 ET 200SP, AQ 2xI STANDARD, PU 1	6ES7135-6HD00-0BA1 ET 200SP, AQ 4xU/I ST	6ES7135-6HB00-0DA1 ET 200SP, AQ 2 X U/I HIGH SPEED	6ES7135-6HB00-0CA1 ET 200SP, AQ 2 X U/I HIGH FEATURE
General information					
Product type designation	ET 200SP, AQ 2xU Standard	ET 200SP, AQ 2xI Standard	ET 200SP, AQ 4xU/I Standard	ET 200SP, AQ 2xU/I High Speed	AQ 2xU/I HF
Product function					
• I&M data	Yes; I&M0 to I&M3	Yes; I&M0 to I&M3	Yes; I&M0 to I&M3	Yes; I&M0 to I&M3	Yes; I&M0 to I&M3
• Output range scalable	No	No	No		
Engineering with					
• STEP 7 TIA Portal configurable/ integrated as of version	V13 SP1 / -	V13 SP1 / -	V11 SP2 / V13	V13 SP1	V13 / V13
• STEP 7 configurable/integrated as of version	V5.5 SP3 / -	V5.5 SP3 / -	V5.5 SP3 / -	V5.5 SP3 / -	V5.5 SP3 / -
• PCS 7 configurable/integrated as of version			V8.1 SP1		V8.1 SP1
• PROFIBUS as of GSD version/ GSD revision	GSD Revision 5	GSD Revision 5	GSD Revision 5	GSD Revision 5	GSD Revision 5
• PROFINET as of GSD version/ GSD revision	GSDML V2.3	GSDML V2.3	GSDML V2.3	GSDML V2.3	GSDML V2.3
Operating mode					
• Oversampling	No	No	No	Yes; 2 channels per module	No
• MSO	No	No	No	No	No
CiR – Configuration in RUN					
Reparameterization possible in RUN	Yes	Yes	Yes	Yes	Yes
Calibration possible in RUN	No	No	No	Yes	Yes
Supply voltage					
Type of supply voltage	DC	DC	DC	DC	DC
Rated value (DC)	24 V	24 V	24 V	24 V	24 V
Reverse polarity protection	Yes	Yes	Yes	Yes	Yes
Analog outputs					
Number of analog outputs	2	2	4	2	2
Cycle time (all channels), min.	1 ms	1 ms	5 ms	125 µs	750 µs
Analog output with oversampling	No	No	No	Yes	
• Values per cycle, max.				16	
• Resolution, min.				45 µs; (2 channels), 35 µs (1 channel)	
Output ranges, voltage					
• 0 to 10 V	Yes; 15 bit		Yes; 15 bit	Yes; 15 bit	Yes; 15 bit
• 1 V to 5 V	Yes; 13 bit		Yes; 13 bit	Yes; 13 bit	Yes; 13 bit
• -5 V to +5 V	Yes; 15 bit incl. sign		Yes; 15 bit incl. sign	Yes; 15 bit incl. sign	Yes; 15 bit incl. sign
• -10 V to +10 V	Yes; 16 bit incl. sign		Yes; 16 bit incl. sign	Yes; 16 bit incl. sign	Yes; 16 bit incl. sign
Output ranges, current					
• 0 to 20 mA		Yes; 15 bit	Yes; 15 bit	Yes; 15 bit	Yes; 15 bit
• -20 mA to +20 mA		Yes; 16 bit incl. sign	Yes; 16 bit incl. sign	Yes; 16 bit incl. sign	Yes; 16 bit incl. sign
• 4 mA to 20 mA		Yes; 14 bit	Yes; 14 bit	Yes; 14 bit	Yes; 14 bit
Connection of actuators					
• for voltage output two-wire connection	Yes		Yes	Yes	Yes
• for voltage output four-wire connection	No		Yes	Yes	Yes
• for current output two-wire connection		Yes	Yes	Yes	Yes

I/O systems

SIMATIC ET 200 systems for the control cabinet
SIMATIC ET 200SP

I/O modules > Analog output modules

Technical specifications (continued)

Article number	6ES7135-6FB00-0BA1 ET 200SP, AQ 2XU STANDARD, PU 1	6ES7135-6GB00-0BA1 ET 200SP, AQ 2XI STANDARD, PU 1	6ES7135-6HD00-0BA1 ET 200SP, AQ 4XU/I ST	6ES7135-6HB00-0DA1 ET 200SP, AQ 2 X U/I HIGH SPEED	6ES7135-6HB00-0CA1 ET 200SP, AQ 2 X U/I HIGH FEATURE
Load impedance (in rated range of output)					
• with voltage outputs, min.	2 kΩ		2 kΩ	2 kΩ	2 kΩ
• with voltage outputs, capacitive load, max.	1 μF		1 μF	1 μF	1 μF
• with current outputs, max.		500 Ω	500 Ω	500 Ω	500 Ω
• with current outputs, inductive load, max.		1 mH	1 mH	1 mH	1 mH
Cable length					
• shielded, max.	200 m	1 000 m	1 000 m; 200 m for voltage output	1 000 m; 200 m for voltage output	1 000 m; 200 m for voltage output
Analog value generation for the outputs					
Integration and conversion time/resolution per channel					
• Resolution with overrange (bit including sign), max.	16 bit	16 bit	16 bit	16 bit	16 bit
Settling time					
• for resistive load	0.1 ms	0.1 ms; Typical value	0.1 ms	0.05 ms	0.05 ms
• for capacitive load	1 ms		1 ms	0.05 ms; Max. 47 nF and 20 m cable length	0.05 ms; Max. 47 nF and 20 m cable length
• for inductive load		0.5 ms	0.5 ms	0.05 ms	0.05 ms
Errors/accuracies					
Basic error limit (operational limit at 25 °C)					
• Voltage, relative to output range, (+/-)	0.3 %	0.3 %	0.3 %	0.1 %	0.1 %
• Current, relative to output range, (+/-)	0.3 %	0.3 %	0.3 %	0.1 %	0.1 %
Isochronous mode					
Isochronous operation (application synchronized up to terminal)	No	No	No	Yes	Yes
Execution and activation time (TCO), min.				70 μs	500 μs
Bus cycle time (TDP), min.				125 μs	750 μs
Interrupts/diagnostics/status information					
Diagnostics function	Yes	Yes	Yes	Yes	Yes
Substitute values connectable	Yes	Yes	Yes	Yes	Yes
Alarms					
• Diagnostic alarm	Yes	Yes	Yes	Yes	Yes
Diagnostic messages					
• Monitoring the supply voltage	Yes	Yes	Yes	Yes	Yes
• Wire-break		Yes	Yes	Yes; channel-by-channel, only for output type "current"	Yes; channel-by-channel, only for output type "current"
• Short-circuit	Yes		Yes	Yes; channel-by-channel, only for output type "voltage"	Yes; channel-by-channel, only for output type "voltage"
• Group error	Yes	Yes	Yes	Yes	Yes
• Overflow/underflow	Yes	Yes	Yes	Yes	Yes
Diagnostics indication LED					
• Monitoring of the supply voltage (PWR-LED)	Yes; green PWR LED	Yes; green PWR LED	Yes; green PWR LED	Yes; green PWR LED	Yes; green PWR LED
• Channel status display	Yes; Green LED	Yes; Green LED	Yes; Green LED	Yes; Green LED	Yes; Green LED
• for channel diagnostics	No	No	No	Yes; Red LED	Yes; Red LED
• for module diagnostics	Yes; green/red DIAG LED	Yes; green/red DIAG LED	Yes; green/red DIAG LED	Yes; green/red DIAG LED	Yes; green/red DIAG LED
Potential separation					
Potential separation channels					
• between the channels and backplane bus	Yes	Yes	Yes	Yes	Yes
Isolation					
Isolation tested with	707 V DC (type test)	707 V DC (type test)	707 V DC (type test)	707 V DC (type test)	707 V DC (type test)

Technical specifications (continued)

Article number	6ES7135-6FB00-0BA1 ET 200SP, AQ 2XU STANDARD, PU 1	6ES7135-6GB00-0BA1 ET 200SP, AQ 2XI STANDARD, PU 1	6ES7135-6HD00-0BA1 ET 200SP, AQ 4XU/I ST	6ES7135-6HB00-0DA1 ET 200SP, AQ 2 X U/I HIGH SPEED	6ES7135-6HB00-0CA1 ET 200SP, AQ 2 X U/I HIGH FEATURE
Ambient conditions					
Ambient temperature during operation					
• horizontal installation, min.	0 °C	0 °C	0 °C	0 °C	0 °C
• horizontal installation, max.	60 °C	60 °C	60 °C; Observe derating	60 °C	60 °C
• vertical installation, min.	0 °C	0 °C	0 °C	0 °C	0 °C
• vertical installation, max.	50 °C	50 °C	50 °C; Observe derating	50 °C	50 °C
Dimensions					
Width	15 mm	15 mm	15 mm	15 mm	15 mm
Height	73 mm	73 mm	73 mm	73 mm	73 mm
Depth	58 mm	58 mm	58 mm	58 mm	58 mm
Weights					
Weight, approx.	31 g	31 g	31 g	31 g	31 g

Ordering data

	Article No.	Article No.
Analog output modules		Usable type A0 BaseUnits
Analog output module AQ 2xU Standard, BU type A0 or A1, color code CC00, 16-bit	6ES7135-6FB00-0BA1	Delivery options: Apart from the standard delivery form in an individual package, selected BaseUnits are also available in a pack of 10 units. The pack of 10 units enables the amount of waste to be reduced considerably, as well as saving the time of unpacking individual modules.
Analog output module AQ 2xi Standard, BU type A0 or A1, color code CC00, 16-bit	6ES7135-6GB00-0BA1	The number of modules required is the number of modules ordered. The type of packaging is chosen by selecting the article number. Packs of 10 can therefore only be ordered in integer multiples of 10.
Analog output module AQ 4xU/I Standard, BU type A0 or A1, color code CC00, 16-bit, ± 0.3%	6ES7135-6HD00-0BA1	BU15-P16+A10+2D
Analog output module AQ 2xU/I High Feature, BU type A0 or A1, color code CC00, 16-bit, ± 0.1%	6ES7135-6HB00-0CA1	BU type A0; BaseUnit (light) with 16 process terminals (1...16) to the module and an additional 10 internally jumpered AUX terminals (1 A to 10 A); for starting a new load group (max. 10 A)
Analog output module AQ 2xU/I High Speed, BU type A0 or A1, color code CC00, 16-bit, ± 0.3%	6ES7135-6HB00-0DA1	<ul style="list-style-type: none"> • 1 unit • 10 units 6ES7193-6BP20-0DA0 6ES7193-6BP20-2DA0
		BU15-P16+A0+2D
		BU type A0; BaseUnit (light) with 16 process terminals to the module; for starting a new load group (max. 10 A)
		<ul style="list-style-type: none"> • 1 unit • 10 units 6ES7193-6BP00-0DA0 6ES7193-6BP00-2DA0
		BU15-P16+A10+2B
		BU type A0; BaseUnit (dark) with 16 process terminals (1...16) to the module and an additional 10 internally jumpered AUX terminals (1 A to 10 A); for continuing the load group
		<ul style="list-style-type: none"> • 1 unit • 10 units 6ES7193-6BP20-0BA0 6ES7193-6BP20-2BA0
		BU15-P16+A0+2B
		BU type A0; BaseUnit (dark) with 16 process terminals to the module; for continuing the load group
		<ul style="list-style-type: none"> • 1 unit • 10 units 6ES7193-6BP00-0BA0 6ES7193-6BP00-2BA0

I/O systems

SIMATIC ET 200 systems for the control cabinet
SIMATIC ET 200SP

I/O modules > Analog output modules

Ordering data	Article No.	Accessories	Article No.
Usable type A1 BaseUnits (temperature detection)		Equipment labeling plate	6ES7193-6LF30-0AW0
BU15-P16+A0+12D/T BU type A1; BaseUnit (light) with 16 process terminals (1...16) to the module and an additional 2x5 internally jumpered additional terminals (1 B to 5 B and 1 C to 5 C); for starting a new load group (max. 10 A)	6ES7193-6BP40-0DA1	10 sheets of 16 labels, for printing with thermal transfer card printer or plotter	
BU15-P16+A0+2D/T BU type A1; BaseUnit (light) with 16 process terminals to the module; for starting a new load group (max. 10 A)	6ES7193-6BP00-0DA1	Labeling strips	
BU15-P16+A0+12B/T BU type A1; BaseUnit (dark) with 16 process terminals (1...16) to the module and an additional 2x5 internally jumpered additional terminals (1 B to 5 B and 1 C to 5 C); for continuing the load group	6ES7193-6BP40-0BA1	500 labeling strips on roll, light gray, for inscription with thermal transfer roll printer	6ES7193-6LR10-0AA0
BU15-P16+A0+2B/T BU type A1; BaseUnit (dark) with 16 process terminals to the module; for continuing the load group	6ES7193-6BP00-0BA1	500 labeling strips on roll, yellow, for inscription with thermal transfer roll printer	6ES7193-6LR10-0AG0
		1000 labeling strips DIN A4, light gray, card, perforated, for inscription with laser printer	6ES7193-6LA10-0AA0
		1000 labeling strips DIN A4, yellow, card, perforated, for inscription with laser printer	6ES7193-6LA10-0AG0
		BU cover	
		for covering empty slots (gaps); 5 units	
		• 15 mm	6ES7133-6CV15-1AM0
		• 20 mm	6ES7133-6CV20-1AM0
		Shield connection	6ES7193-6SC00-1AM0
		5 shield supports and 5 shield terminals	
		Color-coded labels	
		Color code CC00, for 16 process terminals, for BU type A0, A1, gray (terminals 1 to 8), red (terminals 9 to 16); 10 units	6ES7193-6CP00-2MA0
		Color code CC71, for 10 AUX terminals, BU type A0, yellow/green (terminals 1 A to 10 A); 10 units	6ES7193-6CP71-2AA0
		Color code CC72, for 10 AUX terminals, BU type A0, red (terminals 1 A to 10 A); 10 units	6ES7193-6CP72-2AA0
		Color code CC73, for 10 AUX terminals, BU type A0, blue (terminals 1 A to 10 A); 10 units	6ES7193-6CP73-2AA0
		Color code CC74, for 2x5 additional terminals, BU type A1, red (terminals 1B to 5B), blue (terminals 1C to 5C); 10 units	6ES7193-6CP74-2AA0

Overview



- 8 and 16-channel digital input modules for the ET 200SP
- Can be plugged onto Type A0 BaseUnits (BU) with automatic coding
- LED display for error, operation, supply voltage and status
- Clear labeling on front of module
 - Plain text identification of the module type and function class
 - 2D matrix code (order and serial number)
 - Connection diagram
 - Color coding of the DI module type: white
 - Hardware and firmware version
 - Color code (CC) for module-specific color coding of the potentials at the terminals of the BU
 - Complete Article No.
- Optional labeling accessories
 - Labeling strips
 - Reference identification label
- Optional module-specific color identification of the terminals according to the color code (CC)
- Optional system-integrated shield connection

Note:

SIPLUS extreme products are based on SIMATIC standard products. The contents listed here were taken from the respective standard products. SIPLUS extreme-specific information was added.

Technical specifications

Article number	6AG1131-6BF00-7BA0	6AG1131-6BH00-7BA0
Based on	6ES7131-6BF00-0BA0 SIPLUS ET 200SP DI 8x24VDC ST	6ES7131-6BH00-0BA0 SIPLUS ET 200SP DI 16x24VDC ST
Ambient conditions		
Ambient temperature during operation		
• horizontal installation, min.	-40 °C; = Tmin; Startup @ -25 °C	-40 °C; = Tmin; Startup @ -25 °C
• horizontal installation, max.	70 °C; = Tmax; > +60 °C number of simultaneously controllable inputs max. 6	70 °C; = Tmax; > +60 °C number of simultaneously controllable inputs max. 4
• vertical installation, min.	-40 °C; = Tmin; Startup @ -25 °C	-40 °C; = Tmin; Startup @ -25 °C
• vertical installation, max.	50 °C; = Tmax	50 °C; = Tmax
Extended ambient conditions		
• relative to ambient temperature-atmospheric pressure-installation altitude	Tmin ... Tmax at 1080 hPa ... 795 hPa (-1000 m ... +2000 m) // Tmin ... (Tmax - 10K) at 795 hPa ... 658 hPa (+2000 m ... +3500 m) // Tmin ... (Tmax - 20K) at 658 hPa ... 540 hPa (+3500 m ... +5000 m)	Tmin ... Tmax at 1080 hPa ... 795 hPa (-1000 m ... +2000 m) // Tmin ... (Tmax - 10K) at 795 hPa ... 658 hPa (+2000 m ... +3500 m) // Tmin ... (Tmax - 20K) at 658 hPa ... 540 hPa (+3500 m ... +5000 m)
Relative humidity		
- With condensation, tested in accordance with IEC 60068-2-38, max.	100 %; RH incl. condensation/frost (no commissioning under condensation conditions)	100 %; RH incl. condensation/frost (no commissioning under condensation conditions)
Resistance		
- against biologically active substances / conformity with EN 60721-3-3	Yes; Class 3B2 mold, fungus and dry rot spores (with the exception of fauna). The supplied connector covers must remain on the unused interfaces during operation!	Yes; Class 3B2 mold, fungus and dry rot spores (with the exception of fauna). The supplied connector covers must remain on the unused interfaces during operation!
- against chemically active substances / conformity with EN 60721-3-3	Yes; Class 3C4 (RH < 75%) incl. salt spray according to EN 60068-2-52 (degree of severity 3). The supplied connector covers must remain on the unused interfaces during operation!	Yes; Class 3C4 (RH < 75%) incl. salt spray according to EN 60068-2-52 (degree of severity 3). The supplied connector covers must remain on the unused interfaces during operation!
- against mechanically active substances / conformity with EN 60721-3-3	Yes; Class 3S4 incl. sand, dust. The supplied connector covers must remain on the unused interfaces during operation!	Yes; Class 3S4 incl. sand, dust. The supplied connector covers must remain on the unused interfaces during operation!

I/O systems

SIMATIC ET 200 systems for the control cabinet
SIMATIC ET 200SP

I/O modules > SIPLUS digital inputs

Ordering data	Article No.	Ordering data	Article No.
SIPLUS digital input modules (Extended temperature range and exposure to media) DI 8x24 V DC Standard, BU type A0, color code CC01 DI 16x24 V DC Standard, BU type A0, color code CC00	6AG1131-6BF00-7BA0 6AG1131-6BH00-7BA0	BU15-P16+A10+2D (Extended temperature range and exposure to media) BU type A0; BaseUnit (light) with 16 process terminals (1...16) to the module and an additional 10 internally jumpered AUX terminals (1 A to 10 A); for starting a new load group (max. 10 A)	6AG1193-6BP20-7DA0
Usable SIPLUS BaseUnits		BU15-P16+A10+2B (Extended temperature range and exposure to media) BU type A0; BaseUnit (dark) with 16 process terminals (1...16) to the module and an additional 10 internally jumpered AUX terminals (1 A to 10 A); for continuing the load group	6AG1193-6BP20-7BA0
BU15-P16+A0+2D (Extended temperature range and exposure to media) BU type A0; BaseUnit (light) with 16 process terminals to the module; for starting a new load group (max. 10 A)	6AG1193-6BP00-7DA0	Accessories	See SIMATIC ET 200SP, digital input modules, page 9/23
BU15-P16+A0+2B (Extended temperature range and exposure to media) BU type A0; BaseUnit (dark) with 16 process terminals to the module; for continuing the load group	6AG1193-6BP00-7BA0		

Overview



- 4, 8 and 16-channel DQ modules
- 4-channel RQ modules
- BaseUnits for single conductor or multiple-conductor connection
- Function classes Basic, Standard, High Feature and High-Speed as well as fail-safe DQ and RQ
- Clear labeling on front of module
- LEDs for diagnostics, status and errors
- Individual system-integrated load group formation with self-assembling potential multi-terminal busbars (power module not required for ET 200SP)
- Electronically readable rating plate (I&M data)
- Additional operating modes in some cases
- Optional accessories:
 - Labeling strips
 - Equipment marking label
 - Color-coded label with module-specific CC code
 - Shielding terminal

Overview of digital output modules

Digital output	Article No.	CC code	BU type	VPE
DQ 16 x 24 V DC/0.5 A ST	6AG1132-6BH00-7BA0	CC00	A0	1
DQ 8 x 24 V DC/0.5 A ST	6AG1132-6BF00-7BA0	CC02	A0	1
DQ 8 x 24 V DC/0.5 A HF	6AG1132-6BF00-7CA0	CC02	A0	1
DQ 4 x 24 V DC/2 A ST	6AG1132-6BD20-7BA0	CC02	A0	1
RQ 4 x 24 V UC/2 A CO ST	6AG1132-6GD50-2BA0	CC00	A0	1
RQ 4 x 120 V DC-230 V AC/5 A NO ST	6AG1132-6HD00-7BB0	CC00	B0	1

Note:

SIPLUS extreme products are based on SIMATIC standard products. The contents listed here were taken from the respective standard products. SIPLUS extreme-specific information was added.

I/O systems

SIMATIC ET 200 systems for the control cabinet
SIMATIC ET 200SP

I/O modules > SIPLUS digital outputs

Technical specifications

Article number	6AG1132-6BD20-7BA0	6AG1132-6BF00-7BA0	6AG1132-6BH00-7BA0
Based on	6ES7132-6BD20-0BA0	6ES7132-6BF00-0BA0	6ES7132-6BH00-0BA0
	SIPLUS ET 200SP DQ 4x24VDC/2A ST	SIPLUS ET 200SP DQ 8x24VDC/0,5A ST	SIPLUS ET 200SP DQ 16x24VDC/0,5A ST
Ambient conditions			
Ambient temperature during operation			
• horizontal installation, min.	-40 °C; = Tmin; Startup @ -25 °C	-40 °C; = Tmin; Startup @ -25 °C	-40 °C; = Tmin; Startup @ -25 °C
• horizontal installation, max.	70 °C; = Tmax ; > +60 °C number of simultaneously controllable outputs max. 2 x 0.25 A or max. 4 x 0.125 A, max. total current 0.5 A	70 °C; = Tmax; > +60 °C max. total current 1.0 A	70 °C; = Tmax; > +60 °C max. total current 1.0 A
• vertical installation, min.	-40 °C; = Tmin; Startup @ -25 °C	-40 °C; = Tmin; Startup @ -25 °C	-40 °C; = Tmin; Startup @ -25 °C
• vertical installation, max.	50 °C; = Tmax	50 °C; = Tmax	50 °C; = Tmax
Extended ambient conditions			
• relative to ambient temperature-atmospheric pressure-installation altitude	Tmin ... Tmax at 1080 hPa ... 795 hPa (-1000 m ... +2000 m) // Tmin ... (Tmax - 10K) at 795 hPa ... 658 hPa (+2000 m ... +3500 m) // Tmin ... (Tmax - 20K) at 658 hPa ... 540 hPa (+3500 m ... +5000 m)	Tmin ... Tmax at 1080 hPa ... 795 hPa (-1000 m ... +2000 m) // Tmin ... (Tmax - 10K) at 795 hPa ... 658 hPa (+2000 m ... +3500 m) // Tmin ... (Tmax - 20K) at 658 hPa ... 540 hPa (+3500 m ... +5000 m)	Tmin ... Tmax at 1080 hPa ... 795 hPa (-1000 m ... +2000 m) // Tmin ... (Tmax - 10K) at 795 hPa ... 658 hPa (+2000 m ... +3500 m) // Tmin ... (Tmax - 20K) at 658 hPa ... 540 hPa (+3500 m ... +5000 m)
Relative humidity			
- With condensation, tested in accordance with IEC 60068-2-38, max.	100 %; RH incl. condensation/frost (no commissioning under condensation conditions)	100 %; RH incl. condensation/frost (no commissioning under condensation conditions)	100 %; RH incl. condensation/frost (no commissioning under condensation conditions)
Resistance			
- against biologically active substances / conformity with EN 60721-3-3	Yes; Class 3B2 mold, fungus and dry rot spores (with the exception of fauna). The supplied connector covers must remain on the unused interfaces during operation!	Yes; Class 3B2 mold, fungus and dry rot spores (with the exception of fauna). The supplied connector covers must remain on the unused interfaces during operation!	Yes; Class 3B2 mold, fungus and dry rot spores (with the exception of fauna). The supplied connector covers must remain on the unused interfaces during operation!
- against chemically active substances / conformity with EN 60721-3-3	Yes; Class 3C4 (RH < 75%) incl. salt spray according to EN 60068-2-52 (degree of severity 3). The supplied connector covers must remain on the unused interfaces during operation!	Yes; Class 3C4 (RH < 75%) incl. salt spray according to EN 60068-2-52 (degree of severity 3). The supplied connector covers must remain on the unused interfaces during operation!	Yes; Class 3C4 (RH < 75%) incl. salt spray according to EN 60068-2-52 (degree of severity 3). The supplied connector covers must remain on the unused interfaces during operation!
- against mechanically active substances / conformity with EN 60721-3-3	Yes; Class 3S4 incl. sand, dust. The supplied connector covers must remain on the unused interfaces during operation!	Yes; Class 3S4 incl. sand, dust. The supplied connector covers must remain on the unused interfaces during operation!	Yes; Class 3S4 incl. sand, dust. The supplied connector covers must remain on the unused interfaces during operation!

Technical specifications (continued)

Article number	6AG1132-6BF00-7CA0 6ES7132-6BF00-0CA0 SIPLUS ET 200SP DQ 8X24VDC/0,5A HF	6AG1132-6GD50-2BA0 6ES7132-6GD50-0BA0 SIPLUS ET 200SP RQ 4X24VDC/2A CO ST	6AG1132-6HD00-7BB1 6ES7132-6HD00-0BB0 SIPLUS ET 200SP RQ 4x120VDC/230VAC/5A
Ambient conditions			
Ambient temperature during operation			
<ul style="list-style-type: none"> • horizontal installation, min. • horizontal installation, max. 	-40 °C; = Tmin; Startup @ -25 °C 70 °C; = Tmax; > +60 °C max. total current 1.0 A	-40 °C; = Tmin; Startup @ -25 °C 60 °C; = Tmax	-40 °C; = Tmin 70 °C; = Tmax; see Derating BasedOn (e.g. manual), additionally Tmax > 60 °C max. continuous current of 3 A per relay
Extended ambient conditions			
<ul style="list-style-type: none"> • relative to ambient temperature-atmospheric pressure-installation altitude 	Tmin ... Tmax at 1080 hPa ... 795 hPa (-1000 m ... +2000 m) // Tmin ... (Tmax - 10K) at 795 hPa ... 658 hPa (+2000 m ... +3500 m) // Tmin ... (Tmax - 20K) at 658 hPa ... 540 hPa (+3500 m ... +5000 m)	Tmin ... Tmax at 1080 hPa ... 795 hPa (-1000 m ... +2000 m)	3 000 m with: Tmin ... Tmax at 1 080 hPa ... 795 hPa (-1 000 m ... +2 000 m) // Tmin ... (Tmax - 10 K) at 795 hPa ... 658 hPa (+2 000 m ... +3 500 m)
Relative humidity			
<ul style="list-style-type: none"> - With condensation, tested in accordance with IEC 60068-2-38, max. 	100 %; RH incl. condensation / frost (no commissioning in bedewed state), horizontal installation	100 %; RH incl. condensation / frost (no commissioning in bedewed state), horizontal installation	100 %; RH incl. condensation / frost (no commissioning in bedewed state), horizontal installation
Resistance			
<ul style="list-style-type: none"> - against biologically active substances / conformity with EN 60721-3-3 - against chemically active substances / conformity with EN 60721-3-3 - against mechanically active substances / conformity with EN 60721-3-3 	Yes; Class 3B2 mold, fungus and dry rot spores (with the exception of fauna); Class 3B3 on request Yes; Class 3C4 (RH < 75%) incl. salt spray according to EN 60068-2-52 (degree of severity 3). The supplied connector covers must remain on the unused interfaces during operation! Yes; Class 3S4 incl. sand, dust. The supplied connector covers must remain on the unused interfaces during operation!	Yes; Class 3B2 mold, fungus and dry rot spores (with the exception of fauna); Class 3B3 on request Yes; Class 3C4 (RH < 75%) incl. salt spray according to EN 60068-2-52 (degree of severity 3). The supplied connector covers must remain on the unused interfaces during operation! Yes; Class 3S4 incl. sand, dust. The supplied connector covers must remain on the unused interfaces during operation!	Yes; Class 3B2 mold, fungus and dry rot spores (with the exception of fauna); Class 3B3 on request Yes; Class 3C4 (RH < 75%) incl. salt spray according to EN 60068-2-52 (degree of severity 3). The supplied connector covers must remain on the unused interfaces during operation! Yes; Class 3S4 incl. sand, dust. The supplied connector covers must remain on the unused interfaces during operation!

I/O systemsSIMATIC ET 200 systems for the control cabinet
SIMATIC ET 200SP**I/O modules > SIPLUS digital outputs**

Ordering data	Article No.	Article No.
SIPLUS digital output modules		
(Extended temperature range and exposure to media)		
Digital output module DQ 4x24 V DC/2 A Standard, BU type A0, color code CC02	6AG1132-6BD20-7BA0	6AG1193-6BP20-7DA0
Digital output module DQ 8x24 V DC/0.5 A Standard, BU type A0, color code CC02	6AG1132-6BF00-7BA0	
Digital output module DQ 8x24 V DC/0.5 A High Feature, BU type A0, color code CC02	6AG1132-6BF00-7CA0	
Digital output module DQ 16x24 V DC/0.5 A Standard, BU type A0, color code CC00	6AG1132-6BH00-7BA0	
Signal relay module RQ CO 4x24 V UC/2 A Standard, changeover contact, BU type A0, color code CC00	6AG1132-6GD50-2BA0	
Relay module RQ NO 4x120 V DC - 230 V AC/5 A Standard, normally open, BU type B0, color code CC00	6AG1132-6HD00-7BB1	
Usable SIPLUS BaseUnits		
BU15-P16+A0+2D	6AG1193-6BP00-7DA0	
(Extended temperature range and exposure to media)		
BU type A0; BaseUnit (light) with 16 process terminals to the module, for starting a new load group (max. 10 A)		
BU15-P16+A0+2B	6AG1193-6BP00-7BA0	
(Extended temperature range and exposure to media)		
BU type A0; BaseUnit (dark) with 16 process terminals to the module; for continuing the load group		
BU15-P16+A10+2D		
(Extended temperature range and exposure to media)		
BU type A0; BaseUnit (light) with 16 process terminals (1...16) to the module and an additional 10 internally jumpered AUX terminals (1 A to 10 A); for starting a new load group (max. 10 A)		
BU15-P16+A10+2B		
(Extended temperature range and exposure to media)		
BU type A0; BaseUnit (dark) with 16 process terminals (1...16) to the module and an additional 10 internally jumpered AUX terminals (1 A to 10 A); for continuing the load group		
BU20-P12+A4+0B		
(Extended temperature range and exposure to media)		
BU type B0; BaseUnit (dark) with 12 process terminals (1...12) to the module and an additional 4 internally jumpered AUX terminals (1 A to 4 A); for continuing the load group; 1 unit		
Accessories		
		See SIMATIC ET 200SP, digital output modules, page 9/35

Overview



- 2, 4 and 8-channel AI modules
- Measuring ranges for current, voltage, thermocouples, resistance thermometer, resistor and PTC
- BaseUnits for 2, 3 and 4-conductor connection
- Function classes Basic, Standard, High Feature and High Speed
- Clear labeling on front of module
- LEDs for diagnostics, status and errors
- Individual system-integrated load group formation with self-assembling potential multi-terminal busbars (power module not required for ET 200SP)
- Electronically readable rating plate (I&M data)
- Additional operating modes in some cases
- Optional accessories:
 - Labeling strips
 - Equipment marking label
 - Color-coded label with module-specific CC code
 - Shielding terminal

Overview of SIPLUS analog input modules

Analog input	Article No.	CC code	BU type	PU
AI 4 x U/I 2-wire ST	6AG1134-6HD00-7BA1	CC03	A0, A1	1
AI 4 x I 2/4-wire ST	6AG1134-6GD00-7BA1	CC03	A0, A1	1
AI 4 x I 2-wire 4...20 mA HART	6AG1134-6TD00-2CA1	CC03	A0, A1	1
AI 2 x U/I 2/4-wire HF	6AG1134-6HB00-2CA1	CC05	A0, A1	1
AI 2xU/I 2/4-wire HS	6AG1134-6HB00-2DA1	CC00	A0, A1	1
With two operating modes: • High-speed isochronous AI • Oversampling				
AI 8 x RTD/TC 2-wire HF	6AG1134-6JF00-2CA1	CC00	A0, A1	1
AI 4 x RTD/TC 2/3/4-wire HF	6AG1134-6JD00-2CA1	CC00	A0, A1	1
AI Energy Meter 400 V AC ST	6AG1134-6PA00-7BD0	--	D0	1

Note:

SIPLUS extreme products are based on SIMATIC standard products. The contents listed here were taken from the respective standard products. SIPLUS extreme-specific information was added.

I/O systems

SIMATIC ET 200 systems for the control cabinet
SIMATIC ET 200SP

I/O modules > SIPLUS analog inputs

Technical specifications

Article number	6AG1134-6HD00-7BA1	6AG1134-6GD00-7BA1	6AG1134-6TD00-2CA1
Based on	6ES7134-6HD00-0BA1 SIPLUS ET 200SP AI 4xU/I 2-wire ST	6ES7134-6GD00-0BA1 SIPLUS ET 200SP AI 4xI 2/4-wire ST	6ES7134-6TD00-0CA1 SIPLUS ET 200SP AI 4XI 2-WIRE 4...20MA H
Ambient conditions			
Ambient temperature during operation			
• horizontal installation, min.	-40 °C; = Tmin; Startup @ -25 °C	-40 °C; = Tmin; Startup @ -25 °C	-40 °C; = Tmin; Startup @ -25 °C
• horizontal installation, max.	70 °C; = Tmax; > 60 °C max. 1x +/- 20 mA or 4x +/- 10 V permissible	70 °C; = Tmax; > 60 °C max. 1x +/- 20 mA permissible	60 °C
• vertical installation, min.	-40 °C; = Tmin; Startup @ -25 °C	-40 °C; = Tmin; Startup @ -25 °C	-40 °C; = Tmin; Startup @ -25 °C
• vertical installation, max.	50 °C; = Tmax	50 °C; = Tmax	50 °C
Extended ambient conditions			
• relative to ambient temperature-atmospheric pressure-installation altitude			Tmin ... Tmax at 1080 hPa ... 795 hPa (-1000 m ... +2000 m) // Tmin ... (Tmax - 10K) at 795 hPa ... 658 hPa (+2000 m ... +3500 m) // Tmin ... (Tmax - 20K) at 658 hPa ... 540 hPa (+3500 m ... +5000 m)
Relative humidity			
- With condensation, tested in accordance with IEC 60068-2-38, max.	100 %; RH incl. condensation/frost (no commissioning under condensation conditions)	100 %; RH incl. condensation/frost (no commissioning under condensation conditions)	100 %; RH incl. condensation/frost (no commissioning under condensation conditions)
Resistance			
- against biologically active substances / conformity with EN 60721-3-3	Yes; Class 3B2 mold, fungus and dry rot spores (with the exception of fauna). The supplied connector covers must remain on the unused interfaces during operation!	Yes; Class 3B2 mold, fungus and dry rot spores (with the exception of fauna). The supplied connector covers must remain on the unused interfaces during operation!	Yes; Class 3B2 mold, fungus and dry rot spores (with the exception of fauna). The supplied connector covers must remain on the unused interfaces during operation!
- against chemically active substances / conformity with EN 60721-3-3	Yes; Class 3C4 (RH < 75%) incl. salt spray according to EN 60068-2-52 (degree of severity 3). The supplied connector covers must remain on the unused interfaces during operation!	Yes; Class 3C4 (RH < 75%) incl. salt spray according to EN 60068-2-52 (degree of severity 3). The supplied connector covers must remain on the unused interfaces during operation!	Yes; Class 3C4 (RH < 75%) incl. salt spray according to EN 60068-2-52 (degree of severity 3). The supplied connector covers must remain on the unused interfaces during operation!
- against mechanically active substances / conformity with EN 60721-3-3	Yes; Class 3S4 incl. sand, dust. The supplied connector covers must remain on the unused interfaces during operation!	Yes; Class 3S4 incl. sand, dust. The supplied connector covers must remain on the unused interfaces during operation!	Yes; Class 3S4 incl. sand, dust. The supplied connector covers must remain on the unused interfaces during operation!

Article number	6AG1134-6HB00-2CA1	6AG1134-6HB00-2DA1	6AG1134-6JF00-2CA1	6AG1134-6JD00-2CA1
Based on	6ES7134-6HB00-0CA1 SIPLUS ET 200SP AI 2 X U/I 2, 4-WIRE HF	6ES7134-6HB00-0DA1 SIPLUS ET 200SP AI 2 X U/I 2, 4-WIRE HS	6ES7134-6JF00-0CA1 SIPLUS ET 200SP AI 8XRTD/TC 2-WIRE HF	6ES7134-6JD00-0CA1 SIPLUS ET 200SP AI 4XRTD/TC HF
Ambient conditions				
Ambient temperature during operation				
• horizontal installation, min.	-40 °C; = Tmin; Startup @ -25 °C	-40 °C; = Tmin; Startup @ -25 °C	-40 °C; = Tmin; Startup @ -25 °C	-40 °C; = Tmin; Startup @ -25 °C
• horizontal installation, max.	60 °C; = Tmax	60 °C; = Tmax	60 °C	60 °C; = Tmax
• vertical installation, min.			-40 °C; = Tmin; Startup @ -25 °C	-40 °C; = Tmin; Startup @ -25 °C
• vertical installation, max.			50 °C	50 °C; = Tmax
Extended ambient conditions				
• relative to ambient temperature-atmospheric pressure-installation altitude	Tmin ... Tmax at 1080 hPa ... 795 hPa (-1000 m ... +2000 m) // Tmin ... (Tmax - 10K) at 795 hPa ... 658 hPa (+2000 m ... +3500 m) // Tmin ... (Tmax - 20K) at 658 hPa ... 540 hPa (+3500 m ... +5000 m)	Tmin ... Tmax at 1080 hPa ... 795 hPa (-1000 m ... +2000 m) // Tmin ... (Tmax - 10K) at 795 hPa ... 658 hPa (+2000 m ... +3500 m) // Tmin ... (Tmax - 20K) at 658 hPa ... 540 hPa (+3500 m ... +5000 m)	Tmin ... Tmax at 1080 hPa ... 795 hPa (-1000 m ... +2000 m) // Tmin ... (Tmax - 10K) at 795 hPa ... 658 hPa (+2000 m ... +3500 m) // Tmin ... (Tmax - 20K) at 658 hPa ... 540 hPa (+3500 m ... +5000 m)	

Technical specifications (continued)

Article number	6AG1134-6HB00-2CA1	6AG1134-6HB00-2DA1	6AG1134-6JF00-2CA1	6AG1134-6JD00-2CA1
Based on	6ES7134-6HB00-0CA1 SIPLUS ET 200SP AI 2 X U/I 2, 4-WIRE HF	6ES7134-6HB00-0DA1 SIPLUS ET 200SP AI 2 X U/I 2, 4-WIRE HS	6ES7134-6JF00-0CA1 SIPLUS ET 200SP AI 8XRTD/TC 2-WIRE HF	6ES7134-6JD00-0CA1 SIPLUS ET 200SP AI 4xRTD/TC HF
Relative humidity				
- With condensation, tested in accordance with IEC 60068-2-38, max.	100 %; RH incl. condensation / frost (no commissioning in bedewed state), horizontal installation	100 %; RH incl. condensation / frost (no commissioning in bedewed state), horizontal installation	100 %; RH incl. condensation/frost (no commissioning under condensation conditions)	100 %; RH incl. condensation/frost (no commissioning under condensation conditions)
Resistance				
- against biologically active substances / conformity with EN 60721-3-3	Yes; Class 3B2 mold, fungus and dry rot spores (with the exception of fauna). The supplied connector covers must remain on the unused interfaces during operation!	Yes; Class 3B2 mold, fungus and dry rot spores (with the exception of fauna). The supplied connector covers must remain on the unused interfaces during operation!	Yes; Class 3B2 mold, fungus and dry rot spores (with the exception of fauna). The supplied connector covers must remain on the unused interfaces during operation!	Yes; Class 3B2 mold, fungus and dry rot spores (with the exception of fauna). The supplied connector covers must remain on the unused interfaces during operation!
- against chemically active substances / conformity with EN 60721-3-3	Yes; Class 3C4 (RH < 75%) incl. salt spray according to EN 60068-2-52 (degree of severity 3). The supplied connector covers must remain on the unused interfaces during operation!	Yes; Class 3C4 (RH < 75%) incl. salt spray according to EN 60068-2-52 (degree of severity 3). The supplied connector covers must remain on the unused interfaces during operation!	Yes; Class 3C4 (RH < 75%) incl. salt spray according to EN 60068-2-52 (degree of severity 3). The supplied connector covers must remain on the unused interfaces during operation!	Yes; Class 3C4 (RH < 75%) incl. salt spray according to EN 60068-2-52 (degree of severity 3). The supplied connector covers must remain on the unused interfaces during operation!
- against mechanically active substances / conformity with EN 60721-3-3	Yes; Class 3S4 incl. sand, dust. The supplied connector covers must remain on the unused interfaces during operation!	Yes; Class 3S4 incl. sand, dust. The supplied connector covers must remain on the unused interfaces during operation!	Yes; Class 3S4 incl. sand, dust. The supplied connector covers must remain on the unused interfaces during operation!	Yes; Class 3S4 incl. sand, dust. The supplied connector covers must remain on the unused interfaces during operation!

Article number	6AG1134-6PA00-7BD0
Based on	6ES7134-6PA00-0BD0 SIPLUS ET 200SP AI Energy Meter
Ambient conditions	
Ambient temperature during operation	
• horizontal installation, min.	-40 °C; = Tmin; Startup @ -25 °C
• horizontal installation, max.	70 °C; = Tmax; > +60 °C max. permissible current 1 A per phase
• vertical installation, min.	-40 °C; = Tmin; Startup @ -25 °C
• vertical installation, max.	50 °C; = Tmax
Extended ambient conditions	
• relative to ambient temperature-atmospheric pressure-installation altitude	Tmin ... Tmax at 1080 hPa ... 795 hPa (-1000 m ... +2000 m)
Relative humidity	
- With condensation, tested in accordance with IEC 60068-2-38, max.	100 %; RH incl. condensation/frost (no commissioning under condensation conditions)

Article number	6AG1134-6PA00-7BD0
Based on	6ES7134-6PA00-0BD0 SIPLUS ET 200SP AI Energy Meter
Resistance	
- against biologically active substances / conformity with EN 60721-3-3	Yes; Class 3B2 mold, fungus and dry rot spores (with the exception of fauna). The supplied connector covers must remain on the unused interfaces during operation!
- against chemically active substances / conformity with EN 60721-3-3	Yes; Class 3C4 (RH < 75%) incl. salt spray according to EN 60068-2-52 (degree of severity 3). The supplied connector covers must remain on the unused interfaces during operation!
- against mechanically active substances / conformity with EN 60721-3-3	Yes; Class 3S4 incl. sand, dust. The supplied connector covers must remain on the unused interfaces during operation!

I/O systemsSIMATIC ET 200 systems for the control cabinet
SIMATIC ET 200SP**I/O modules > SIPLUS analog inputs****Ordering data****Article No.****Article No.****SIPLUS analog input modules**

(Extended temperature range and exposure to media)

Analog input module
AI 4xU/I 2-wire Standard,
BU type A0 or A1,
color code CC03, 16-bit, ± 0.3%**6AG1134-6HD00-7BA1**Analog input module
AI 4xI 2/4-wire Standard,
BU type A0 or A1,
color code CC03, 16-bit, ± 0.3%**6AG1134-6GD00-7BA1**Analog input module
AI 4xRTD/TC 2, 3, 4-wire
High Feature, BU type A0 or A1,
color code CC00, 16-bit, ± 0.1%,
scalable measuring range**6AG1134-6JD00-2CA1**Analog input module
AI 4xI 2-wire 4...20 mA HART,
BU type A0 or A1, color code CC03**6AG1134-6TD00-2CA1**Analog input module
AI 2xU/I 2/4-wire High Feature,
BU type A0 or A1, color code
CC05, 16-bit, ± 0.1%, independent
channel isolation, isochronous
mode above 1 ms**6AG1134-6HB00-2CA1**Analog input module
AI 2xU/I 2/4-wire High Speed,
BU type A0 or A1,
color code CC00, 16-bit, ± 0.3%,
isochronous mode above 250 µs,
oversampling above 50 µs**6AG1134-6HB00-2DA1**Analog input module
AI 8xRTD/TC 2-wire High Feature,
BU type A0 or A1,
color code CC00, 16-bit, ± 0.1%,
scalable measuring range**6AG1134-6JF00-2CA1**Analog input module
AI Energy Meter Standard,
BU type D0**6AG1134-6PA00-7BD0****Usable SIPLUS BaseUnits
type A0****BU15-P16+A0+2D**

(Extended temperature range and exposure to media)

BU type A0; BaseUnit (light) with
16 process terminals to the module,
for starting a new load group
(max. 10 A)**6AG1193-6BP00-7DA0****BU15-P16+A0+2B**

(Extended temperature range and exposure to media)

BU type A0; BaseUnit (dark) with
16 process terminals to the module,
for continuing the load group**6AG1193-6BP00-7BA0****BU15-P16+A10+2D**

(Extended temperature range and exposure to media)

BU type A0; BaseUnit (light) with
16 process terminals (1...16) to the
module and an additional 10 inter-
nally jumpered AUX terminals (1 A
to 10 A); for starting a new load
group (max. 10 A)**6AG1193-6BP20-7DA0****BU15-P16+A10+2B**

(Extended temperature range and exposure to media)

BU type A0; BaseUnit (dark) with
16 process terminals (1...16) to the
module and an additional 10 inter-
nally jumpered AUX terminals (1 A
to 10 A); for continuing the load
group**6AG1193-6BP20-7BA0****Usable SIPLUS BaseUnits type
A1 (temperature detection)****BU15-P16+A0+2D/T**

(Extended temperature range and exposure to media)

BU type A1; BaseUnit (light) with
16 process terminals to the module,
for starting a new load group
(max. 10 A)**6AG1193-6BP00-7DA1****BU15-P16+A0+2B/T**

(Extended temperature range and exposure to media)

BU type A1; BaseUnit (dark) with
16 process terminals to the module;
for continuing the load group**6AG1193-6BP00-7BA1****BU15-P16+A0+12D/T**

(Extended temperature range and exposure to media)

BU type A1; BaseUnit (light) with
16 process terminals (1...16) to the
module and an additional 2x5 inter-
nally jumpered AUX terminals (1 B
to 5 B and 1 C to 5 C); for starting a
new load group (max. 10 A)**6AG1193-6BP40-7DA1****BU15-P16+A0+12B/T**

(Extended temperature range and exposure to media)

BU type A1; BaseUnit (dark) with
16 process terminals (1...16) to the
module and an additional 2x5 inter-
nally jumpered AUX terminals (1 B
to 5 B and 1 C to 5 C);
for continuing the load group**6AG1193-6BP40-7BA1****Usable SIPLUS BaseUnits
type D0****BU20-P12+A0+0B**

(Extended temperature range and exposure to media)

BU type D0; BaseUnit
with 12 push-in terminals, without
AUX terminals, bridged to the left**6AG1193-6BP00-7BD0****Accessories**See SIMATIC ET 200SP,
analog input modules,
page 9/50

Overview



- 2 and 4-channel AQ modules
- Output ranges for current, voltage
- BaseUnits for 2, 3 and 4-conductor connection
- Function classes Standard, High Feature and High Speed
- Clear labeling on front of module
- LEDs for diagnostics, status and errors
- Individual system-integrated load group formation with self-assembling potential multi-terminal busbars (power module not required for ET 200SP)
- Electronically readable rating plate (I&M data)
- Additional operating modes in some cases
- Optional accessories
 - Labeling strips
 - Reference identification label
 - Color-coded label with module-specific CC code
 - Shielding terminal

Overview of analog output modules

Analog output	Article No.	CC code	BU type	PU
AQ 4 x U/I ST	6AG1135-6HD00-7BA1	CC00	A0, A1	1
AQ 2xU/I HS	6AG1135-6HB00-2DA1	CC00	A0, A1	1

With two operating modes:

- High-speed isochronous AQ
- Oversampling

Note:

SIPLUS extreme products are based on SIMATIC standard products. The contents listed here were taken from the respective standard products. SIPLUS extreme-specific information was added.

Technical specifications

Article number	6AG1135-6HD00-7BA1	6AG1135-6HB00-2DA1
Based on	6ES7135-6HD00-0BA1 SIPLUS ET 200SP AQ 4xU/I ST	6ES7135-6HB00-0DA1 SIPLUS ET 200SP AQ 2 X U/I HIGH SPEED
Ambient conditions		
Ambient temperature during operation		
• horizontal installation, min.	-40 °C; = Tmin; Startup @ -25 °C	-40 °C; = Tmin; Startup @ -25 °C
• horizontal installation, max.	70 °C; = Tmax; > +60 °C max. 2x +/- 10 V permissible	60 °C; = Tmax
• vertical installation, min.	-40 °C; = Tmin; Startup @ -25 °C	
• vertical installation, max.	50 °C; = Tmax	
Extended ambient conditions		
• relative to ambient temperature-atmospheric pressure-installation altitude	Tmin ... Tmax at 1080 hPa ... 795 hPa (-1000 m ... +2000 m) // Tmin ... (Tmax - 10K) at 795 hPa ... 658 hPa (+2000 m ... +3500 m) // Tmin ... (Tmax - 20K) at 658 hPa ... 540 hPa (+3500 m ... +5000 m)	Tmin ... Tmax at 1080 hPa ... 795 hPa (-1000 m ... +2000 m) // Tmin ... (Tmax - 10K) at 795 hPa ... 658 hPa (+2000 m ... +3500 m) // Tmin ... (Tmax - 20K) at 658 hPa ... 540 hPa (+3500 m ... +5000 m)
Relative humidity		
- With condensation, tested in accordance with IEC 60068-2-38, max.	100 %; RH incl. condensation/frost (no commissioning under condensation conditions)	100 %; RH incl. condensation / frost (no commissioning in bedewed state), horizontal installation
Resistance		
- against biologically active substances / conformity with EN 60721-3-3	Yes; Class 3B2 mold, fungus and dry rot spores (with the exception of fauna). The supplied connector covers must remain on the unused interfaces during operation!	Yes; Class 3B2 mold, fungus and dry rot spores (with the exception of fauna). The supplied connector covers must remain on the unused interfaces during operation!
- against chemically active substances / conformity with EN 60721-3-3	Yes; Class 3C4 (RH < 75%) incl. salt spray according to EN 60068-2-52 (degree of severity 3). The supplied connector covers must remain on the unused interfaces during operation!	Yes; Class 3C4 incl. salt spray according to EN 60068-2-52 (degree of severity 3). The supplied connector covers must remain on the unused interfaces during operation!
- against mechanically active substances / conformity with EN 60721-3-3	Yes; Class 3S4 incl. sand, dust. The supplied connector covers must remain on the unused interfaces during operation!	Yes; Class 3S4 incl. sand, dust. The supplied connector covers must remain on the unused interfaces during operation!

I/O systemsSIMATIC ET 200 systems for the control cabinet
SIMATIC ET 200SP**I/O modules > SIPLUS analog outputs**

Ordering data	Article No.	Article No.
SIPLUS analog output modules (Extended temperature range and exposure to media) AQ 4XU/I Standard, BU type A0 or A1, color code CC03 Analog output module AQ 2xU/I High Speed, BU type A0 or A1, color code CC00, 16-bit, ± 0.3%	6AG1135-6HD00-7BA1 6AG1135-6HB00-2DA1	Usable SIPLUS BaseUnits type A1 (temperature detection) BU15-P16+A0+2D/T (Extended temperature range and exposure to media) BU type A1; BaseUnit (light) with 16 process terminals to the module, for starting a new load group (max. 10 A)
Usable SIPLUS BaseUnits type A0 BU15-P16+A0+2D (Extended temperature range and exposure to media) BU type A0; BaseUnit (light) with 16 process terminals to the module, for starting a new load group (max. 10 A)	6AG1193-6BP00-7DA0	BU15-P16+A0+2B/T (Extended temperature range and exposure to media) BU type A1; BaseUnit (dark) with 16 process terminals to the module; for continuing the load group
BU15-P16+A0+2B (Extended temperature range and exposure to media) BU type A0; BaseUnit (dark) with 16 process terminals to the module; for continuing the load group	6AG1193-6BP00-7BA0	BU15-P16+A0+12D/T (Extended temperature range and exposure to media) BU type A1; BaseUnit (light) with 16 process terminals (1...16) to the module and an additional 2x5 internally jumpered AUX terminals (1 B to 5 B and 1 C to 5 C); for starting a new load group (max. 10 A)
BU15-P16+A10+2D (Extended temperature range and exposure to media) BU type A0; BaseUnit (light) with 16 process terminals (1...16) to the module and an additional 10 internally jumpered AUX terminals (1 A to 10 A); for starting a new load group (max. 10 A)	6AG1193-6BP20-7DA0	BU15-P16+A0+12B/T (Extended temperature range and exposure to media) BU type A1; BaseUnit (dark) with 16 process terminals (1...16) to the module and an additional 2x5 internally jumpered AUX terminals (1 B to 5 B and 1 C to 5 C); for continuing the load group
BU15-P16+A10+2B (Extended temperature range and exposure to media) BU type A0; BaseUnit (dark) with 16 process terminals (1...16) to the module and an additional 10 internally jumpered AUX terminals (1 A to 10 A); for continuing the load group	6AG1193-6BP20-7BA0	Accessories See SIMATIC ET 200SP, analog output modules, page 9/56

Overview



Technical properties

- Counter module for ET 200SP
- Interfaces:
 - 24 V encoder signals A, B and N from P, M or push-pull-switching encoders and sensors
 - 24 V encoder supply output, short-circuit proof
 - 3 digital inputs for controlling the count operation, for saving or for setting the count value
 - 2 digital outputs for fast reactions regardless of the counter status or measured value

- Counting frequency 200 kHz (800 kHz with quadruple evaluation)
- Counting range: +/- 31-bits
- Measurement function
- Parameterizable hardware interrupts
- Parameterizable input filters for suppressing interferences at sensor and digital inputs

Supported types of encoders/signals

- 24 V incremental encoder with and without signal N
- 24 V pulse encoder with direction signal
- 24 V pulse encoder without direction signal
- 24 V pulse encoder for pulse up and down respectively

Supported system functions

- Isochronous mode
- Firmware update
- Identification data I&M

Technical specifications

Article number	6ES7138-6AA00-0BA0 ET 200SP, TM COUNT 1X24V
General information	
Product type designation	TM Count 1x24V
Product function	
• I&M data	Yes; I&M0 to I&M3
Engineering with	
• STEP 7 TIA Portal configurable/integrated as of version	V13 / -
• STEP 7 configurable/integrated as of version	V5.5 SP3 / -
• PROFIBUS as of GSD version/GSD revision	GSD Revision 5
• PROFINET as of GSD version/GSD revision	GSDML V2.3
Installation type/mounting	
Rack mounting	Yes
Rail mounting	Yes
Supply voltage	
Load voltage L+	
• Rated value (DC)	24 V
• Reverse polarity protection	Yes
Input current	
Current consumption, max.	60 mA; without load
Encoder supply	
Number of outputs	1
24 V encoder supply	
• 24 V	Yes; L+ (-0.8 V)
• Short-circuit protection	Yes; electronic/thermal
• Output current, max.	300 mA
Power loss	
Power loss, typ.	1 W

Article number	6ES7138-6AA00-0BA0 ET 200SP, TM COUNT 1X24V
Digital inputs	
Number of digital inputs	3
Digital inputs, parameterizable	Yes
Input characteristic curve in accordance with IEC 61131, type 3	Yes
Digital input functions, parameterizable	
• Gate start/stop	Yes
• Capture	Yes
• Synchronization	Yes
• Freely usable digital input	Yes
Input voltage	
• Rated value (DC)	24 V
• for signal "0"	-30 to +5V
• for signal "1"	+11 to +30V
• permissible voltage at input, min.	-30 V
• permissible voltage at input, max.	30 V
Input current	
• for signal "1", typ.	2.5 mA
Input delay (for rated value of input voltage) for standard inputs	
- parameterizable	Yes; none / 0.05 / 0.1 / 0.4 / 0.8 / 1.6 / 3.2 / 12.8 / 20 ms
- at "0" to "1", min.	6 µs; for parameterization "none"
- at "1" to "0", min.	6 µs; for parameterization "none"
for counter/technological functions	
- parameterizable	Yes
Cable length	
• shielded, max.	1 000 m
• unshielded, max.	600 m

I/O systems

SIMATIC ET 200 systems for the control cabinet
SIMATIC ET 200SP

I/O modules > Technology modules > TM Count 1x24V counter module

Technical specifications (continued)

Article number	6ES7138-6AA00-0BA0 ET 200SP, TM COUNT 1X24V
Digital outputs	
Type of digital output	Transistor
Number of digital outputs	2
Digital outputs, parameterizable	Yes
Short-circuit protection	Yes; electronic/thermal
Limitation of inductive shutdown voltage to	L+ (-33 V)
Controlling a digital input	Yes
Digital output functions, parameterizable	
• Switching tripped by comparison values	Yes
• Freely usable digital output	Yes
Switching capacity of the outputs	
• with resistive load, max.	0.5 A; Per digital output
• on lamp load, max.	5 W
Load resistance range	
• lower limit	48 Ω
• upper limit	12 kΩ
Output voltage	
• for signal "1", min.	23.2 V; L+ (-0.8 V)
Output current	
• for signal "1" rated value	0.5 A; Per digital output
• for signal "0" residual current, max.	0.5 mA
Output delay with resistive load	
• "0" to "1", max.	50 μs
• "1" to "0", max.	50 μs
Switching frequency	
• with resistive load, max.	10 kHz
• with inductive load, max.	0.5 Hz; Acc. to IEC 60947-5-1, DC-13; observe derating curve
• on lamp load, max.	10 Hz
Total current of the outputs	
• Current per module, max.	1 A
Cable length	
• shielded, max.	1 000 m
• unshielded, max.	600 m
Encoder	
Connectable encoders	
• 2-wire sensor	Yes
- permissible quiescent current (2-wire sensor), max.	1.5 mA
Encoder signals, incremental encoder (asymmetrical)	
• Input voltage	24 V
• Input frequency, max.	200 kHz
• Counting frequency, max.	800 kHz; with quadruple evaluation
• Cable length, shielded, max.	600 m; depending on input frequency, encoder and cable quality; max. 50 m at 200 kHz
• Signal filter, parameterizable	Yes
• Incremental encoder with A/B tracks, 90° phase offset	Yes
• Incremental encoder with A/B tracks, 90° phase offset and zero track	Yes
• Pulse encoder	Yes
• Pulse encoder with direction	Yes
• Pulse encoder with one impulse signal per count direction	Yes

Article number	6ES7138-6AA00-0BA0 ET 200SP, TM COUNT 1X24V
Encoder signal 24 V	
- permissible voltage at input, min.	-30 V
- permissible voltage at input, max.	30 V
Interface types	
• Input characteristic curve in accordance with IEC 61131, type 3	Yes
• Source/sink input	Yes
Isochronous mode	
Isochronous operation (application synchronized up to terminal)	Yes
Interrupts/diagnostics/status information	
Substitute values connectable	Yes; Parameterizable
Alarms	
• Diagnostic alarm	Yes
• Hardware interrupt	Yes
Diagnostic messages	
• Monitoring the supply voltage	Yes
• Wire-break	Yes
• Short-circuit	Yes
• A/B transition error at incremental encoder	Yes
• Group error	Yes
Diagnostics indication LED	
• Monitoring of the supply voltage (PWR-LED)	Yes; green PWR LED
• for module diagnostics	Yes; green/red DIAG LED
• Status indicator backward counting (green)	Yes
• Status indicator forward counting (green)	Yes
Integrated Functions	
Number of counters	1
Counting frequency (counter) max.	800 kHz; with quadruple evaluation
Counting functions	
• Can be used with TO High_Speed_Counter	Yes
• Continuous counting	Yes
• Counter response parameterizable	Yes
• Hardware gate via digital input	Yes
• Software gate	Yes
• Event-controlled stop	Yes
• Synchronization via digital input	Yes
• Counting range, parameterizable	Yes
Comparator	
- Number of comparators	2
- Direction dependency	Yes
- Can be changed from user program	Yes
Position detection	
• Incremental acquisition	Yes
• Suitable for S7-1500 Motion Control	Yes
Measuring functions	
• Measuring time, parameterizable	Yes
• Dynamic measurement period adjustment	Yes
• Number of thresholds, parameterizable	2

Technical specifications (continued)

Article number	6ES7138-6AA00-0BA0 ET 200SP, TM COUNT 1X24V
Measuring range	
- Frequency measurement, min.	0.04 Hz
- Frequency measurement, max.	800 kHz
- Cycle duration measurement, min.	1.25 µs
- Cycle duration measurement, max.	25 s
Accuracy	
- Frequency measurement	100 ppm; depending on measuring interval and signal evaluation
- Cycle duration measurement	100 ppm; depending on measuring interval and signal evaluation
- Velocity measurement	100 ppm; depending on measuring interval and signal evaluation

Article number	6ES7138-6AA00-0BA0 ET 200SP, TM COUNT 1X24V
Potential separation	
Potential separation channels	
• between the channels and backplane bus	Yes
Isolation	
Isolation tested with	707 V DC (type test)
Dimensions	
Width	15 mm
Height	73 mm
Depth	58 mm
Weights	
Weight, approx.	45 g

Ordering data**Article No.****Article No.**

TM Count 1x24V counter module	
With one channel, max. 200 kHz; for 24 V encoder	6ES7138-6AA00-0BA0
Usable BaseUnits	
BU15-P16+A0+2D	
BU type A0; BaseUnit (light) with 16 process terminals to the module; for starting a new load group (max. 10 A)	
• 1 unit	6ES7193-6BP00-0DA0
• 10 units	6ES7193-6BP00-2DA0
BU15-P16+A0+2B	
BU type A0; BaseUnit (dark) with 16 process terminals to the module; for continuing the load group	
• 1 unit	6ES7193-6BP00-0BA0
• 10 units	6ES7193-6BP00-2BA0
BU15-P16+A10+2D	
BU type A0; BaseUnit (light) with 16 process terminals (1...16) to the module and an additional 10 internally jumpered AUX terminals (1 A to 10 A); for starting a new load group (max. 10 A)	
• 1 unit	6ES7193-6BP20-0DA0
• 10 units	6ES7193-6BP20-2DA0
BU15-P16+A10+2B	
BU type A0; BaseUnit (dark) with 16 process terminals (1...16) to the module and an additional 10 internally jumpered AUX terminals (1 A to 10 A); for continuing the load group	
• 1 unit	6ES7193-6BP20-0BA0
• 10 units	6ES7193-6BP20-2BA0

Accessories	
Reference identification label	6ES7193-6LF30-0AW0
10 sheets of 16 labels	
Labeling strips	
500 labeling strips on roll, light gray, for inscription with thermal transfer roll printer	6ES7193-6LR10-0AA0
500 labeling strips on roll, yellow, for inscription with thermal transfer roll printer	6ES7193-6LR10-0AG0
1000 labeling strips DIN A4, light gray, card, for inscription with laser printer	6ES7193-6LA10-0AA0
1000 labeling strips DIN A4, yellow, card, for inscription with laser printer	6ES7193-6LA10-0AG0
BU cover	
for covering empty slots (gaps); 5 units	
• 15 mm wide	6ES7133-6CV15-1AM0
• 20 mm wide	6ES7133-6CV20-1AM0
Shield connection	6ES7193-6SC00-1AM0
5 shield supports and 5 shield terminals	
Color-coded labels	
• Color code CC71, for 10 AUX terminals 1 A to 10 A, for BU type A0, yellow/green, with push-in terminals; 10 units	6ES7193-6CP71-2AA0
• Color code CC72, for 10 AUX terminals 1 A to 10 A, for BU type A0, red, with push-in terminals; 10 units	6ES7193-6CP72-2AA0
• Color code CC73, for 10 AUX terminals 1 A to 10 A, for BU type A0, blue, with push-in terminals; 10 units	6ES7193-6CP73-2AA0

I/O systems

SIMATIC ET 200 systems for the control cabinet
SIMATIC ET 200SP

I/O modules > Technology modules > TM PosInput 1 counting and position detection module

Overview



Technical properties

- Counting and position detection module for ET 200SP
- Interfaces:
 - Encoder signals A, B and N for 5 V TTL or RS 422 differential signals
 - SSI interface with clock and data for RS 422 differential signals
 - 24 V encoder supply output, short-circuit proof
 - 2 digital inputs for controlling the counting process, for saving or setting the counter or position value
 - 2 digital outputs for fast reactions depending on the counter reading, position value or measured value

- Counter frequency 1 MHz (4 MHz with four-fold evaluation)
- Counting range: +/- 31 bits
- Measurement function
- Parameterizable hardware interrupts
- Parameterizable input filters for suppressing interferences at sensor and digital inputs

Supported types of encoders/signals

- Incremental encoders with or without N signal
- Pulse encoders with directional signal
- Pulse encoders without directional signal
- Pulse encoders for forward or reverse pulses
- SSI encoders with a frame length of 10 to 40 bits, of which up to 31 bits position value

Supported system functions

- Isochronous mode
- Firmware update
- Identification data (I&M)

Technical specifications

Article number	6ES7138-6BA00-0BA0 ET 200SP, TM POSINPUT 1
General information	
Product type designation	TM PosInput 1
Product function	
• I&M data	Yes; I&M0 to I&M3
Engineering with	
• STEP 7 TIA Portal configurable/integrated as of version	V13 / V13
• STEP 7 configurable/integrated as of version	V5.5 SP3 / V5.5 SP4
• PROFIBUS as of GSD version/GSD revision	GSD Revision 5
• PROFINET as of GSD version/GSD revision	GSDML V2.3
Installation type/mounting	
Rack mounting	Yes
Rail mounting	Yes
Supply voltage	
Load voltage L+	
• Rated value (DC)	24 V
• Reverse polarity protection	Yes
Input current	
Current consumption, max.	75 mA; without load

Article number	6ES7138-6BA00-0BA0 ET 200SP, TM POSINPUT 1
Encoder supply	
Number of outputs	1
24 V encoder supply	
• 24 V	Yes; L+ (-0.8 V)
• Short-circuit protection	Yes
• Output current, max.	300 mA
Power loss	
Power loss, typ.	1.9 W
Digital inputs	
Number of digital inputs	2
Digital inputs, parameterizable	Yes
Input characteristic curve in accordance with IEC 61131, type 3	Yes
Digital input functions, parameterizable	
• Gate start/stop	Yes; only for pulse and incremental encoders
• Capture	Yes
• Synchronization	Yes; only for pulse and incremental encoders
• Freely usable digital input	Yes
Input voltage	
• Rated value (DC)	24 V
• for signal "0"	-30 to +5V
• for signal "1"	+11 to +30V
• permissible voltage at input, min.	-30 V
• permissible voltage at input, max.	30 V

Technical specifications (continued)

Article number	6ES7138-6BA00-0BA0 ET 200SP, TM POSINPUT 1
Input current • for signal "1", typ.	2.5 mA
Input delay (for rated value of input voltage) for standard inputs - parameterizable - at "0" to "1", min. - at "1" to "0", min.	Yes; none / 0.05 / 0.1 / 0.4 / 0.8 / 1.6 / 3.2 / 12.8 / 20 ms 6 µs; for parameterization "none" 6 µs; for parameterization "none"
for counter/technological functions - parameterizable	Yes
Cable length • shielded, max. • unshielded, max.	1 000 m 600 m
Digital outputs Type of digital output Number of digital outputs Digital outputs, parameterizable Short-circuit protection Limitation of inductive shutdown voltage to Controlling a digital input	Transistor 2 Yes Yes; electronic/thermal L+ (-33 V) Yes
Digital output functions, parameterizable • Switching tripped by comparison values • Freely usable digital output	Yes Yes
Switching capacity of the outputs • with resistive load, max. • on lamp load, max.	0.5 A; Per digital output 5 W
Load resistance range • lower limit • upper limit	48 Ω 12 kΩ
Output voltage • for signal "1", min.	23.2 V; L+ (-0.8 V)
Output current • for signal "1" rated value • for signal "0" residual current, max.	0.5 A; Per digital output 0.5 mA
Output delay with resistive load • "0" to "1", max. • "1" to "0", max.	50 µs 50 µs
Switching frequency • with resistive load, max. • with inductive load, max. • on lamp load, max.	10 kHz 0.5 Hz; Acc. to IEC 60947-5-1, DC-13; observe derating curve 10 Hz
Total current of the outputs • Current per module, max.	1 A
Cable length • shielded, max. • unshielded, max.	1 000 m 600 m

Article number	6ES7138-6BA00-0BA0 ET 200SP, TM POSINPUT 1
Encoder signals, incremental encoder (symmetrical) • Input voltage • Input frequency, max. • Counting frequency, max. • Cable length, shielded, max. • Signal filter, parameterizable • Incremental encoder with A/B tracks, 90° phase offset • Incremental encoder with A/B tracks, 90° phase offset and zero track • Pulse encoder • Pulse encoder with direction • Pulse encoder with one impulse signal per count direction	RS 422 1 MHz 4 MHz; with quadruple evaluation 32 m; at 1 MHz Yes Yes Yes Yes Yes Yes Yes Yes
Encoder signals, incremental encoder (asymmetrical) • Input voltage • Input frequency, max. • Counting frequency, max. • Signal filter, parameterizable • Incremental encoder with A/B tracks, 90° phase offset • Incremental encoder with A/B tracks, 90° phase offset and zero track • Pulse encoder • Pulse encoder with direction • Pulse encoder with one impulse signal per count direction	5 V TTL (push-pull encoders only) 1 MHz 4 MHz; with quadruple evaluation Yes Yes Yes Yes Yes Yes Yes
Encoder signals, absolute encoder (SSI) • Input signal • Telegram length, parameterizable • Clock frequency, max. • Binary code • Gray code • Cable length, shielded, max. • Parity bit, parameterizable • Monoflop time • Multiturn • Singleturn	to RS-422 10 ... 40 bit 2 MHz; 125 kHz, 250 kHz, 500 kHz, 1 MHz, 1.5 MHz or 2 MHz Yes Yes 320 m; Cable length, RS-422 SSI absolute encoders, Siemens type 6FX2001-5, 24 V supply: 125 kHz, 320 meters shielded, max.; 250 kHz, 160 meters shielded, max.; 500 kHz, 60 meters shielded, max.; 1 MHz, 20 meters shielded, max.; 1.5 MHz, 10 meters shielded, max.; 2 MHz, 8 meters shielded, max. Yes 16, 32, 48, 64 µs & automatic Yes Yes
Interface types • RS 422 • TTL 5 V	Yes Yes; push-pull encoders only

I/O systemsSIMATIC ET 200 systems for the control cabinet
SIMATIC ET 200SP

I/O modules > Technology modules > TM PosInput 1 counting and position detection module

Technical specifications (continued)

Article number	6ES7138-6BA00-0BA0 ET 200SP, TM POSINPUT 1
Isochronous mode	
Isochronous operation (application synchronized up to terminal)	Yes
Interrupts/diagnostics/status information	
Substitute values connectable	Yes; Parameterizable
Alarms	
• Diagnostic alarm	Yes
• Hardware interrupt	Yes
Diagnostic messages	
• Monitoring the supply voltage	Yes
• Wire-break	Yes
• Short-circuit	Yes
• A/B transition error at incremental encoder	Yes
• Telegram error at SSI encoder	Yes
• Group error	Yes
Diagnostics indication LED	
• Monitoring of the supply voltage (PWR-LED)	Yes; green PWR LED
• for module diagnostics	Yes; green/red DIAG LED
• Status indicator backward counting (green)	Yes
• Status indicator forward counting (green)	Yes
Integrated Functions	
Number of counters	1
Counting frequency (counter) max.	4 MHz; with quadruple evaluation
Counting functions	
• Can be used with TO High_Speed_Counter	Yes; only for pulse and incremental encoders
• Continuous counting	Yes
• Counter response parameterizable	Yes
• Hardware gate via digital input	Yes
• Software gate	Yes
• Event-controlled stop	Yes
• Synchronization via digital input	Yes
• Counting range, parameterizable	Yes
Comparator	
- Number of comparators	2
- Direction dependency	Yes
- Can be changed from user program	Yes
Position detection	
• Incremental acquisition	Yes
• Absolute acquisition	Yes
• Suitable for S7-1500 Motion Control	Yes
Measuring functions	
• Measuring time, parameterizable	Yes
• Dynamic measurement period adjustment	Yes
• Number of thresholds, parameterizable	2

Article number	6ES7138-6BA00-0BA0 ET 200SP, TM POSINPUT 1
Measuring range	
- Frequency measurement, min.	0.04 Hz
- Frequency measurement, max.	4 MHz
- Cycle duration measurement, min.	0.25 µs
- Cycle duration measurement, max.	25 s
Accuracy	
- Frequency measurement	100 ppm; depending on measuring interval and signal evaluation
- Cycle duration measurement	100 ppm; depending on measuring interval and signal evaluation
- Velocity measurement	100 ppm; depending on measuring interval and signal evaluation
Potential separation	
Potential separation channels	
• between the channels and backplane bus	Yes
Isolation	
Isolation tested with	707 V DC (type test)
Ambient conditions	
Ambient temperature during operation	
• horizontal installation, min.	0 °C
• horizontal installation, max.	60 °C; Observe derating
• vertical installation, min.	0 °C
• vertical installation, max.	50 °C; Observe derating
Dimensions	
Width	15 mm
Height	73 mm
Depth	58 mm
Weights	
Weight, approx.	45 g

Ordering data	Article No.	Accessories	Article No.
TM PosInput 1 counting and position detection module With one channel, max. 1 MHz for 5 V TTL or RS 422 differential signals or SSI absolute encoder	6ES7138-6BA00-0BA0	Reference identification label 10 sheets of 16 labels	6ES7193-6LF30-0AW0
Usable BaseUnits BU15-P16+A0+2D BU type A0; BaseUnit (light) with 16 process terminals to the module; for starting a new load group (max. 10 A) <ul style="list-style-type: none"> • 1 unit • 10 units 	6ES7193-6BP00-0DA0 6ES7193-6BP00-2DA0	Labeling strips 500 labeling strips on roll, light gray, for inscription with thermal transfer roll printer	6ES7193-6LR10-0AA0
BU15-P16+A0+2B BU type A0; BaseUnit (dark) with 16 process terminals to the module; for continuing the load group <ul style="list-style-type: none"> • 1 unit • 10 units 	6ES7193-6BP00-0BA0 6ES7193-6BP00-2BA0	500 labeling strips on roll, yellow, for inscription with thermal transfer roll printer	6ES7193-6LR10-0AG0
BU15-P16+A10+2D BU type A0; BaseUnit (light) with 16 process terminals (1...16) to the module and an additional 10 internally jumpered AUX terminals (1 A to 10 A); for starting a new load group (max. 10 A) <ul style="list-style-type: none"> • 1 unit • 10 units 	6ES7193-6BP20-0DA0 6ES7193-6BP20-2DA0	1000 labeling strips DIN A4, light gray, card, for inscription with laser printer	6ES7193-6LA10-0AA0
BU15-P16+A10+2B BU type A0; BaseUnit (dark) with 16 process terminals (1...16) to the module and an additional 10 internally jumpered AUX terminals (1 A to 10 A); for continuing the load group <ul style="list-style-type: none"> • 1 unit • 10 units 	6ES7193-6BP20-0BA0 6ES7193-6BP20-2BA0	1000 labeling strips DIN A4, yellow, card, for inscription with laser printer	6ES7193-6LA10-0AG0
		BU cover for covering empty slots (gaps); 5 units <ul style="list-style-type: none"> • 15 mm wide • 20 mm wide 	6ES7133-6CV15-1AM0 6ES7133-6CV20-1AM0
		Shield connection 5 shield supports and 5 shield terminals	6ES7193-6SC00-1AM0
		Color-coded labels <ul style="list-style-type: none"> • Color code CC71, for 10 AUX terminals 1 A to 10 A, for BU type A0, yellow/green, with push-in terminals; 10 units • Color code CC72, for 10 AUX terminals 1 A to 10 A, for BU type A0, red, with push-in terminals; 10 units • Color code CC73, for 10 AUX terminals 1 A to 10 A, for BU type A0, blue, with push-in terminals; 10 units 	6ES7193-6CP71-2AA0 6ES7193-6CP72-2AA0 6ES7193-6CP73-2AA0

I/O systems

SIMATIC ET 200 systems for the control cabinet
SIMATIC ET 200SP

I/O modules > Technology modules > TM Timer DIDQ 10x24V time-based I/O module

Overview

- 4 digital inputs, 6 digital outputs
- Inputs for detecting the input edges with μs accuracy
- Outputs for outputting the switching signals with μs accuracy
- 32x oversampling
- PWM output
- Counter function
- Outputs can be switched between 0.5 A standard and especially fast 0.1 A high-speed mode

Technical specifications

Article number	6ES7138-6CG00-0BA0 ET 200SP, TM TIMER DIDQ 10X24V
General information	
Product type designation	TM Timer DIDQ 10x24V
Product function	
• I&M data	Yes; I&M 0
Engineering with	
• STEP 7 TIA Portal configurable/integrated as of version	V13 Update 3
• STEP 7 configurable/integrated as of version	V5.5 SP3 / -
Supply voltage	
Load voltage L+	
• Rated value (DC)	24 V
• Reverse polarity protection	Yes; against destruction
Input current	
Current consumption, max.	50 mA; without load
Encoder supply	
Number of outputs	1
24 V encoder supply	
• 24 V	Yes; L+ (-0.8 V)
• Short-circuit protection	Yes
• Output current, max.	500 mA; Observe derating
Power loss	
Power loss, typ.	1.5 W
Digital inputs	
Number of digital inputs	4
Digital inputs, parameterizable	Yes
Input characteristic curve in accordance with IEC 61131, type 3	Yes

Article number	6ES7138-6CG00-0BA0 ET 200SP, TM TIMER DIDQ 10X24V
Digital input functions, parameterizable	
• Digital input with time stamp	Yes
- Number, max.	4
• Counter	Yes
- Number, max.	3
• Counter for incremental encoder	Yes
- Number, max.	1
• Digital input with oversampling	Yes
- Number, max.	4
• HW enable for digital input	Yes
- Number, max.	1
• HW enable for digital output	Yes
- Number, max.	3
Input voltage	
• Type of input voltage	DC
• Rated value (DC)	24 V
• for signal "0"	-30 to +5V
• for signal "1"	+11 to +30V
• permissible voltage at input, min.	-30 V
• permissible voltage at input, max.	30 V
Input current	
• for signal "1", typ.	2.5 mA
Input delay (for rated value of input voltage)	
• Minimum pulse width for program reactions	3 μs for parameterization "none"
for standard inputs	
- parameterizable	Yes; none / 0.05 / 0.1 / 0.4 / 0.8 ms
- at "0" to "1", min.	4 μs
- at "1" to "0", min.	4 μs
Cable length	
• shielded, max.	1 000 m; Depending on sensor, cable quality and rate of change
• unshielded, max.	600 m; Depending on sensor, cable quality and rate of change

Technical specifications (continued)

Article number	6ES7138-6CG00-0BA0 ET 200SP, TM TIMER DIDQ 10X24V
Digital outputs	
Type of digital output	Transistor
Number of digital outputs	6
Current-sinking	Yes; With High Speed output
Current-sourcing	Yes
Digital outputs, parameterizable	Yes
Short-circuit protection	Yes; electronic/thermal
Limitation of inductive shutdown voltage to	-0.8 V
Digital output functions, parameterizable	
• Digital output with time stamp	Yes
- Number, max.	6
• PWM output	Yes
- Number, max.	6
• Digital output with oversampling	Yes
- Number, max.	6
Switching capacity of the outputs	
• with resistive load, max.	0.5 A; 0.1 A with High Speed output
• on lamp load, max.	5 W; 1 W with High Speed output
Load resistance range	
• lower limit	48 Ω; 240 ohm with High Speed output
• upper limit	12 kΩ
Output voltage	
• Type of output voltage	DC
• for signal "0", max.	1 V; With High Speed output
• for signal "1", min.	23.2 V; L+ (-0.8 V)
Output current	
• for signal "1" rated value	0.5 A; 0.1 A with High Speed output, observe derating
• for signal "0" residual current, max.	0.5 mA
Output delay with resistive load	
• "0" to "1", max.	1 μs; With High Speed output, 5 μs with Standard output
• "1" to "0", max.	1 μs; With High Speed output, 6 μs with Standard output
Switching frequency	
• with resistive load, max.	10 kHz
• on lamp load, max.	10 Hz
Total current of the outputs	
• Current per module, max.	3.5 A; Observe derating
Cable length	
• shielded, max.	1 000 m; Depending on load and cable quality
• unshielded, max.	600 m; Depending on load and cable quality
Encoder	
Connectable encoders	
• Incremental encoder (asymmetrical)	Yes
• 24 V initiator	Yes
• 2-wire sensor	Yes
- permissible quiescent current (2-wire sensor), max.	1.5 mA

Article number	6ES7138-6CG00-0BA0 ET 200SP, TM TIMER DIDQ 10X24V
Encoder signals, incremental encoder (asymmetrical)	
• Input voltage	24 V
• Input frequency, max.	50 kHz
• Counting frequency, max.	200 kHz; with quadruple evaluation
• Cable length, shielded, max.	600 m; Depending on input frequency, encoder and cable quality; max. 200 m at 50 kHz
• Incremental encoder with A/B tracks, 90° phase offset	Yes
• Pulse encoder	Yes
Encoder signal 24 V	
- permissible voltage at input, min.	-30 V
- permissible voltage at input, max.	30 V
Interface types	
• Input characteristic curve in accordance with IEC 61131, type 3	Yes
Isochronous mode	
Isochronous operation (application synchronized up to terminal)	Yes
Bus cycle time (TDP), min.	375 μs
Interrupts/diagnostics/status information	
Diagnostics function	Yes
Substitute values connectable	Yes
Alarms	
• Diagnostic alarm	Yes
Diagnostic messages	
• Monitoring the supply voltage	Yes
• Short-circuit	Yes
Diagnostics indication LED	
• Monitoring of the supply voltage (PWR-LED)	Yes; green PWR LED
• Channel status display	Yes
• for module diagnostics	Yes; green/red DIAG LED
Integrated Functions	
Number of counters	3
Counting frequency (counter) max.	200 kHz; with quadruple evaluation
Counting functions	
• Continuous counting	Yes
Potential separation	
Potential separation channels	
• between the channels and backplane bus	Yes
Isolation	
Isolation tested with	707 V DC (type test)
Ambient conditions	
Ambient temperature during operation	
• horizontal installation, min.	0 °C
• horizontal installation, max.	60 °C; Observe derating
• vertical installation, min.	0 °C
• vertical installation, max.	50 °C; Observe derating
Decentralized operation	
to SIMATIC S7-1500	Yes
Dimensions	
Width	15 mm
Height	73 mm
Depth	58 mm
Weights	
Weight, approx.	45 g

I/O systems

SIMATIC ET 200 systems for the control cabinet
SIMATIC ET 200SP

I/O modules > Technology modules > TM Timer DIDQ 10x24V time-based I/O module

Ordering data	Article No.	Accessories	Article No.
TM Timer DIDQ 10x24V time-based I/O module 4 time-controlled inputs, 6 time-controlled outputs	6ES7138-6CG00-0BA0	Reference identification label 10 sheets of 16 labels	6ES7193-6LF30-0AW0
Usable BaseUnits		Labeling strips	
BU15-P16+A0+2D BU type A0; BaseUnit (light) with 16 process terminals to the module; for starting a new load group (max. 10 A) • 1 unit • 10 units	6ES7193-6BP00-0DA0 6ES7193-6BP00-2DA0	500 labeling strips on roll, light gray, for inscription with thermal transfer roll printer	6ES7193-6LR10-0AA0
BU15-P16+A0+2B BU type A0; BaseUnit (dark) with 16 process terminals to the module; for continuing the load group • 1 unit • 10 units	6ES7193-6BP00-0BA0 6ES7193-6BP00-2BA0	500 labeling strips on roll, yellow, for inscription with thermal transfer roll printer	6ES7193-6LR10-0AG0
BU15-P16+A10+2D BU type A0; BaseUnit (light) with 16 process terminals (1...16) to the module and an additional 10 inter- nally jumpered AUX terminals (1 A to 10 A); for starting a new load group (max. 10 A) • 1 unit • 10 units	6ES7193-6BP20-0DA0 6ES7193-6BP20-2DA0	1000 labeling strips DIN A4, light gray, card, for inscription with laser printer	6ES7193-6LA10-0AA0
BU15-P16+A10+2B BU type A0; BaseUnit (dark) with 16 process terminals (1...16) to the module and an additional 10 inter- nally jumpered AUX terminals (1 A to 10 A); for continuing the load group • 1 unit • 10 units	6ES7193-6BP20-0BA0 6ES7193-6BP20-2BA0	1000 labeling strips DIN A4, yellow, card, for inscription with laser printer	6ES7193-6LA10-0AG0
		BU cover for covering empty slots (gaps); 5 units • 15 mm wide • 20 mm wide	6ES7133-6CV15-1AM0 6ES7133-6CV20-1AM0
		Shield connection 5 shield supports and 5 shield terminals	6ES7193-6SC00-1AM0
		Color-coded labels • Color code CC71, for 10 AUX terminals 1 A to 10 A, for BU type A0, yellow/green, with push-in terminals; 10 units • Color code CC72, for 10 AUX terminals 1 A to 10 A, for BU type A0, red, with push-in terminals; 10 units • Color code CC73, for 10 AUX terminals 1 A to 10 A, for BU type A0, blue, with push-in terminals; 10 units	6ES7193-6CP71-2AA0 6ES7193-6CP72-2AA0 6ES7193-6CP73-2AA0

Overview



2-channel pulse output module for ET 200SP

- Operating modes:
 - Single pulse with defined length
 - Pulse chain with defined number of pulses
 - Pulse width modulation (with flexible ON period, optional current control and dither function)
 - PWM signal for controlling a DC motor
 - ON and OFF delay; rising and falling edge can be delayed separately to the microsecond
 - Frequency output with defined output frequency
- Hardware:
 - 2 channels 24 V, 2 A output current
 - Parallel switching for enhanced performance on 4 A output current
 - Switching frequencies to 10 kHz; at reduced output current to 0.1 A up to 100 kHz
 - Push-pull output driver for especially steep edges at the outputs
 - Polarity change in DC motor operation for direction reversal
 - 1 high-speed 24 V digital input per channel with parameterizable input delay from 4 μ s
- Channel functions:
 - HW enable; start of signal output with the onboard digital input
 - Parameterizable ON delay; for precise deceleration between the HW enable and the start of output
 - Current measurement in the operating modes pulse-width modulation and pulse chain; enables control of the output current mean value over a period. Temperature influences can thus be balanced to the resistance of the actuator
 - Cyclic control of the respective main setpoint from the PLC in every operating mode; other values can be modified flexibly from the user program
- Supported system functions:
 - Isochronous mode; enables precision-timed connection of the setpoint output to a higher-level controller
 - Firmware update
 - Identification data I&M

Technical specifications

Article number	6ES7138-6DB00-0BB1 ET 200SP, TM PULSE 2X24V
General information	
Product type designation	TM Pulse 2x24 V
Product function	
• I&M data	Yes; I&M 0
• Isochronous mode	Yes
Engineering with	
• STEP 7 TIA Portal configurable/integrated as of version	V13 SP1 + HSP
• STEP 7 configurable/integrated as of version	V5.5 SP4 and higher
• PROFIBUS as of GSD version/GSD revision	GSD Revision 5
• PROFINET as of GSD version/GSD revision	GSDML V2.31
Supply voltage	
Load voltage L+	
• Rated value (DC)	24 V
• Short-circuit protection	Yes
• Reverse polarity protection	Yes; against destruction

Article number	6ES7138-6DB00-0BB1 ET 200SP, TM PULSE 2X24V
Input current	
Current consumption, max.	70 mA; without load
Encoder supply	
Number of outputs	2; A common 24V encoder supply for both channels
24 V encoder supply	
• 24 V	Yes; L+ (-0.8 V)
• Short-circuit protection	Yes; per module, electronic
• Output current, max.	300 mA
Power loss	
Power loss, typ.	1.7 W
Digital inputs	
Number of digital inputs	2; 1 per channel
Digital inputs, parameterizable	Yes
Input characteristic curve in accordance with IEC 61131, type 3	Yes
Digital input functions, parameterizable	
• Freely usable digital input	Yes
• HW enable for digital output	Yes

I/O systems

SIMATIC ET 200 systems for the control cabinet
SIMATIC ET 200SP

I/O modules > Technology modules > TM Pulse 2x24V pulse output module

Technical specifications (continued)

Article number	6ES7138-6DB00-0BB1 ET 200SP, TM PULSE 2X24V
Input voltage	
• Type of input voltage	DC
• Rated value (DC)	24 V
• for signal "0"	-30 to +5V
• for signal "1"	+11 to +30V
• permissible voltage at input, min.	-30 V
• permissible voltage at input, max.	30 V
Input current	
• for signal "1", typ.	2.5 mA
Input delay (for rated value of input voltage) for standard inputs	
- parameterizable	Yes; none / 0.05 / 0.1 / 0.4 / 0.8 / 1.6 / 3.2 / 12.8 / 20 ms
- at "0" to "1", min.	4 µs; for parameterization "none"
- at "1" to "0", min.	4 µs; for parameterization "none"
Digital outputs	
Type of digital output	P- and M-switching
Number of digital outputs	2; 1 per channel
Current-sinking	Yes
Current-sourcing	Yes
Digital outputs, parameterizable	Yes
Short-circuit protection	Yes; electronic/thermal
Limitation of inductive shutdown voltage to	-0.8 V
Controlling a digital input	Yes
Digital output functions, parameterizable	
• Freely usable digital output	Yes
• PWM output	Yes
- Number, max.	2; 1 per channel
• Connection of a proportional valve	Yes
• Dithering	Yes
• Current measurement	Yes
• Current control	Yes
• Connection of a DC motor	Yes
• ON-delay	Yes
• OFF-delay	Yes
• Frequency output	Yes
• Pulse train	Yes
• Pulse output	Yes
Switching capacity of the outputs	
• with resistive load, max.	2 A
• on lamp load, max.	10 W; 1 W with High Speed output

Article number	6ES7138-6DB00-0BB1 ET 200SP, TM PULSE 2X24V
Load resistance range	
• lower limit	12 Ω; 240 ohm with High Speed output
• upper limit	12 kΩ
Output voltage	
• Type of output voltage	DC
• for signal "0", max.	1 V
• for signal "1", min.	23.2 V; L+ (-0.8 V)
Output current	
• for signal "1" rated value	2 A; 0.1 A with High Speed output, observe derating
Output delay with resistive load	
• "0" to "1", typ.	0 µs; With High Speed output, 4.5 µs with Standard output
• "0" to "1", max.	0.8 µs; With High Speed output, 9 µs with Standard output
• "1" to "0", typ.	0 µs; With High Speed output, 4.5 µs with Standard output
• "1" to "0", max.	0.8 µs; With High Speed output, 9 µs with Standard output
Parallel switching of two outputs	
• for uprating	Yes
Switching frequency	
• with resistive load, max.	100 kHz; With High Speed output, 10 kHz with standard output
• with inductive load, max.	100 kHz; With High Speed output, 10 kHz with standard output
• on lamp load, max.	10 Hz
Total current of the outputs	
• Current per channel, max.	2 A
• Current per group, max.	4 A
• Current per module, max.	4 A
Isochronous mode	
Isochronous operation (application synchronized up to terminal)	Yes
Bus cycle time (TDP), min.	250 µs; with 1 channel configuration, 375 µs with 2 channel configuration
Interrupts/diagnostics/status information	
Diagnostics function	Yes
Substitute values connectable	Yes; Parameterizable
Alarms	
• Diagnostic alarm	Yes
Diagnostic messages	
• Monitoring the supply voltage	Yes
• Short-circuit	Yes
Diagnostics indication LED	
• Monitoring of the supply voltage (PWR-LED)	Yes; green PWR LED
• Channel status display	Yes
• for module diagnostics	Yes; green/red DIAG LED

Technical specifications (continued)

Article number	6ES7138-6DB00-0BB1 ET 200SP, TM PULSE 2X24V
Potential separation	
Potential separation channels	
• between the channels	No
• between the channels and backplane bus	Yes
Isolation	
Isolation tested with	707 V DC (type test)
Ambient conditions	
Ambient temperature during operation	
• horizontal installation, max.	60 °C; Observe derating
• vertical installation, max.	50 °C; Observe derating

Article number	6ES7138-6DB00-0BB1 ET 200SP, TM PULSE 2X24V
Decentralized operation	
to SIMATIC S7-300	Yes
to SIMATIC S7-400	Yes
to SIMATIC S7-1200	Yes
to SIMATIC S7-1500	Yes
to standard PROFIBUS master	Yes
to standard PROFINET controller	Yes
Dimensions	
Width	20 mm
Height	73 mm
Depth	58 mm
Weights	
Weight, approx.	50 g

Ordering data
TM Pulse 2x24V pulse output module

PWM and pulse output, 2 channels of 2 A for proportional valves and DC motors

6ES7138-6DB00-0BB1
Usable BaseUnits
BU20-P12+A0+4B

BU type B1; BaseUnit (dark); without AUX terminals; for continuing the load group

6ES7193-6BP20-0BB1
Article No.
Accessories
Reference identification label

10 sheets of 16 labels

6ES7193-6LF30-0AW0
Labeling strips

500 labeling strips on roll, light gray, for inscription with thermal transfer roll printer

6ES7193-6LR10-0AA0

500 labeling strips on roll, yellow, for inscription with thermal transfer roll printer

6ES7193-6LR10-0AG0

1000 labeling strips DIN A4, light gray, card, for inscription with laser printer

6ES7193-6LA10-0AA0

1000 labeling strips DIN A4, yellow, card, for inscription with laser printer

6ES7193-6LA10-0AG0
BU cover

for covering empty slots (gaps); 5 units

- 15 mm wide
- 20 mm wide

6ES7133-6CV15-1AM0
6ES7133-6CV20-1AM0

I/O systems

SIMATIC ET 200 systems for the control cabinet
SIMATIC ET 200SP

I/O modules > Technology modules > SIWAREX WP321

Overview



SIWAREX WP321 is a versatile and flexible weighing module for the seamless integration of a static scale into the SIMATIC automation environment.

The electronic weighing system is integrated in the SIMATIC ET 200SP series and uses all the features of a modern automation system, such as integrated communication, operator control and monitoring, diagnostic system and configuration tools in the TIA Portal, SIMATIC STEP 7, WinCC flexible and PCS 7.

Technical specifications

SIWAREX WP321	
Integration in automation systems	
SIMATIC S7-300, S7-400, S7-1200 and S7-1500	Via SIMATIC ET 200SP interface module (PROFIBUS or PROFINET)
Other manufacturers (with restrictions)	Via SIMATIC ET 200SP interface module (PROFIBUS or PROFINET)
Communication interfaces	<ul style="list-style-type: none"> • SIMATIC ET 200SP backplane bus • RS 485 (SIWATOOL, Siebert remote display)
Commissioning options	<ul style="list-style-type: none"> • Using SIWATOOL V7 • Using function block in SIMATIC CPU / Touch Panel
Measuring accuracy	
according to DIN 1319-1 of full-scale value at 20 °C ± 10 K (68 °F ± 10 K)	0.05%
Internal resolution	± 2 million parts
Measuring frequency	100 / 120 Hz
Digital filter	Variable adjustable low-pass and average filter
Typical applications	<ul style="list-style-type: none"> • Non-automatic weighing instruments • Force measurements • Fill-level monitoring • Belt tension monitors
Weighing functions	
Weight values	<ul style="list-style-type: none"> • Gross • Net • Tare
Limit values	<ul style="list-style-type: none"> • 2 × min/max • Empty
Zeroing	Via command by controller or HMI
Tare	Via command by controller or HMI
External tare specification	Via command by controller or HMI
Calibration commands	Via command by controller or HMI
Load cells	Full-bridge strain gauges in 4-wire or 6-wire system
Load cell powering	
Supply voltage (value applies at sensor, cable-related voltage drops of up to 5 V are controlled)	4.85 V DC ±2%

SIWAREX WP321	
Permissible load resistance	
• R _{Lmin}	> 40 Ω
• R _{Lmax}	< 4100 Ω
With SIWAREX IS Ex interface	
• R _{Lmin}	> 50 Ω
• R _{Lmax}	< 4100 Ω
Load cell characteristic	1 ... 4 mV/V
Permissible range of measuring signal (at greatest set characteristic value)	-21.3 ... +21.3 mV
Max. distance of load cells	1000 m (459.32 ft)
Connection to load cells in Ex zone 1	Optionally via SIWAREX IS Ex interface (compatibility of the load cells must be checked)
Approvals/certificates	<ul style="list-style-type: none"> • ATEX Zone 2 • UL • FM • EAC • KCC • IECEx • RCM
Auxiliary power supply	
Rated voltage	24 V DC
Max. power consumption	typ. 0.1 A @ 24 V DC (0.2 A max.)
Max. power consumption SIMATIC Bus	30 mA
IP degree of protection according to DIN EN 60529; IEC 60529	IP20
Climatic requirements T_{min} (IND) ... T_{max} (IND) (operating temperature)	
• Vertical installation in SIMATIC S7 ¹⁾	-25 ... +50 °C (-13 ... 122 °F)
• Horizontal installation in SIMATIC S7 ¹⁾	-25 ... +60 °C (-13 ... 140 °F)
EMC requirements	according to IEC 61000-6-2, IEC 61000-6-4, OIML-R76-1
Dimensions (width)	15 mm (0.6 in)

¹⁾ The S7 standard modules may not be operated at temperatures below 0 °C (32 °F). For operating conditions below 0 °C (32 °F), SIMATIC modules from the SIPLUS series must be used.

Ordering data	Article No.	Article No.
TM SIWAREX WP321 weighing module Single-channel, for platform or hopper scales with analog load cells / full-bridge strain gauges (1 - 4 mV/V), 1 x LC, 1 x RS 485	7MH4138-6AA00-0BA0	
SIWAREX WP321 manual Available in a range of languages Free download from the Internet at: http://www.siemens.com/weighing-technology		Ex interface SIWAREX IS For intrinsically safe connection of load cells. With ATEX approval (not UL/FM). Suitable for SIWAREX electronic weighing system. Compatibility of load cells must be checked Approved for use in the EU • Short-circuit current < 199 mA DC • Short-circuit current < 137 mA DC Cable (optional) Cable Li2Y 1 x 2 x 0.75 ST + 2 x (2 x 0.34 ST) – CY For connecting SIWAREX electronic weighing systems to junction box (JB), extension box (EB) and Ex interface or between two JB's. For permanent installation. Occasional bending is possible External diameter: approx. 10.8 mm (0.43 in) Permissible ambient temperature -40 ... +80 °C (-40 ... +176 °F). Sold by the meter. • Sheath color: orange • For potentially explosive atmospheres. Sheath color: blue
SIWAREX WP321 "Ready for Use" TIA Portal and SIMATIC Manager sample configuration Free download from the Internet at: http://www.siemens.com/weighing-technology		7MH4710-5BA 7MH4710-5CA
SIWAREX WP321 configuration package for TIA Portal • "Ready for use" software for operating a scale with SIWAREX WP321 and a touch panel (in many different languages) • SIWATOOL V7.0 • Device manuals (PDF files in a variety of languages)	7MH4138-1AK01	
SIWAREX WP321 configuration package for PCS 7 V8.1 • APL function block and faceplate • SIWATOOL V7.0 • Device manuals (PDF files in a variety of languages)	7MH4138-1AK61	
Accessories (mandatory requirement) BaseUnit (Type A0 – one BaseUnit required for each WP321) • For opening a new potential group - BU15P-16+A0+2D or - BU15P-16+A10+2D • For continuing the potential group - BU15P-16+A0+2B - BU15P-16+A10+2B	6ES7193-6BP00-0DA0 6ES7193-6BP20-0DA0 6ES7193-6BP00-0BA0 6ES7193-6BP20-0BA0	
Shielded connection for BaseUnit (5 units / for 5 scales) For laying the load cell cable	6ES7193-6SC00-1AM0	
Accessories (optional)		
SIWAREX JB junction box, aluminum housing For connecting up to 4 load cells in parallel, and for connecting several junction boxes	7MH4710-1BA	
SIWAREX JB junction box, stainless steel housing For connecting up to 4 load cells in parallel	7MH4710-1EA	
SIWAREX JB junction box, stainless steel housing (ATEX) For parallel connection of up to 4 load cells (for zone allocation, see manual or type examination certificate)	7MH4710-1EA01	
		RS 485/USB interface converter Commercially available interface converter with FTDI chip, e.g. USB-Nano from CTI https://www.cti-shop.com/epages/15488632.sf/en_GB/?ViewObject-Path=%2FShops%2F15488632%2FProducts%2F95031010
		Remote display The Siebert S102 and S302 remote digital displays can be directly connected to the SIWAREX FTA via an RS 485 interface Siebert Industrieelektronik GmbH Postfach 1180D-65565 Eppelborn, Germany Tel.: +49 6806/980-9 Fax: +49 6806/980-999 Internet: http://www.siebert.de Detailed information is available from the manufacturer

I/O systems

SIMATIC ET 200 systems for the control cabinet
SIMATIC ET 200SP

I/O modules > Communication > CM PtP serial interface

Overview



- CM PtP communication module; module for serial communication connections with RS 232 and RS 422 interfaces. RS 485 for the Freeport, 3964(R), Modbus RTU and USS protocols, max. 115.2 Kbps, 2 KB frame length, 4 KB receive buffer
- Protocols supported
 - Freeport: User-parameterizable frame format for universal communication
 - 3964(R) for improved transmission reliability
 - Modbus RTU master (requires instructions in SIMATIC S7)
 - Modbus RTU slave (requires instructions in SIMATIC S7)
 - USS, implemented through instructions
- Interface properties
 - RS 232 with auxiliary signals
 - RS 422 for full-duplex connections
 - RS 485 for half-duplex and multi-point connections
 - Transmission rates from 300 to 115200 bit/s
- Can be plugged onto Type A0 BaseUnits (BU) with automatic coding
- LED display for errors, operation and supply voltage
- Communication display for sending and receiving
- Clear labeling on front of module
 - Plain text identification of the module type and function class
 - 2D matrix code (order and serial number)
 - Connection diagram
 - Color coding of the CM module type: silver
 - Hardware and firmware version
 - Complete Article No.
- Optional labeling accessories
 - Labeling strips
 - Reference identification label
- Optional system-integrated shield connection

9

Technical specifications

Article number	6ES7137-6AA00-0BA0 ET 200SP, CM PTP
General information	
Product type designation	ET 200SP CM PtP
Product function	
• I&M data	Yes; I&M0 to I&M3
Engineering with	
• STEP 7 TIA Portal configurable/ integrated as of version	V12 / V12
• STEP 7 configurable/integrated as of version	V5.5 SP2 with GSD file
• PROFIBUS as of GSD version/ GSD revision	GSD as of Revision 5
• PROFINET as of GSD version/ GSD revision	GSDML V2.3
Installation type/mounting	
Rack mounting	Yes
Rail mounting	Yes
Supply voltage	
Type of supply voltage	24 V DC
Rated value (DC)	24 V
Reverse polarity protection	Yes

Article number	6ES7137-6AA00-0BA0 ET 200SP, CM PTP
Input current	
Current consumption (rated value)	29 mA
Power loss	
Power loss, typ.	0.7 W
1. Interface	
Interface types	
• RS 485	Yes
• RS 422	Yes
• RS 232	Yes
RS 232	
• Transmission rate, max.	115.2 kbit/s
• Cable length, max.	15 m
• RS 232 auxiliary signals	RTS, CTS, DTR, DSR, RI, DCD
RS 485	
• Transmission rate, max.	115.2 kbit/s
• Cable length, max.	1 200 m
RS 422	
• Transmission rate, max.	115.2 kbit/s
• Cable length, max.	1 200 m
• 4-wire full duplex connection	Yes
• 4-wire multipoint connection	Yes

Technical specifications (continued)

Article number	6ES7137-6AA00-0BA0 ET 200SP, CM PTP
Integrated protocols	
Freeport	
- Telegram length, max.	2 kbyte
- Bits per character	7 or 8
- Number of stop bits	1 or 2 bit
- Parity	None, even, odd, always 1, always 0, any
3964 (R)	
- Telegram length, max.	2 kbyte
- Bits per character	7 or 8
- Number of stop bits	1 or 2 bit
- Parity	None, even, odd, always 1, always 0, any
Modbus RTU master	
- Address area	1 to 247, extended 1 to 65535
- Number of slaves, max.	32
MODBUS RTU slave	
- Address area	1 to 247, extended 1 to 65535
Telegram buffer	
• Buffer memory for telegrams	4 kbyte
• Number of telegrams which can be buffered	255
Interrupts/diagnostics/status information	
Diagnostics function	Yes
Alarms	
• Diagnostic alarm	Yes
• Hardware interrupt	No
Diagnostic messages	
• Wire-break	Yes

Article number	6ES7137-6AA00-0BA0 ET 200SP, CM PTP
Diagnostics indication LED	
• Monitoring of the supply voltage (PWR-LED)	Yes; green PWR LED
• for module diagnostics	Yes; green/red DIAG LED
• Receive RxD	Yes; Green LED
• Transmit TxD	Yes; Green LED
Potential separation	
between backplane bus and interface	Yes
Isolation	
Isolation tested with	707 V DC (type test)
Decentralized operation	
to SIMATIC S7-300	Yes
to SIMATIC S7-400	Yes
to SIMATIC S7-1200	Yes
to SIMATIC S7-1500	Yes
to standard PROFINET controller	Yes
Dimensions	
Width	15 mm
Height	73 mm
Depth	58 mm
Weights	
Weight, approx.	30 g

Ordering data

Article No.	Article No.
CM PtP communication module	6ES7137-6AA00-0BA0
For serial communication connections with RS 232, RS 422, RS 485 interfaces, BU type A0, color code CC00	
Accessories	
BU15-P16+A0+2D	6ES7193-6BP00-0DA0
BU type A0; BaseUnit (light) with 16 process terminals to the module; for starting a new load group (max. 10 A)	
BU15-P16+A0+2B	6ES7193-6BP00-0BA0
BU type A0; BaseUnit (dark) with 16 process terminals to the module; for continuing the load group	
BU15-P16+A10+2D	6ES7193-6BP20-0DA0
BU type A0; BaseUnit (light) with 16 process terminals (1...16) to the module and an additional 10 internally jumpered AUX terminals (1 A to 10 A); for starting a new load group (max. 10 A)	
BU15-P16+A10+2B	6ES7193-6BP20-0BA0
BU type A0; BaseUnit (dark) with 16 process terminals (1...16) to the module and an additional 10 internally jumpered AUX terminals (1 A to 10 A); for continuing the load group	

Article No.	Article No.
Reference identification label	6ES7193-6LF30-0AW0
10 sheets of 16 labels	
Labeling strips	6ES7193-6LR10-0AA0
500 labeling strips on roll, light gray, for inscription with thermal transfer roll printer	
Shield connection	6ES7193-6SC00-1AM0
5 shield supports and 5 shield terminals, for direct connection	

I/O systems

SIMATIC ET 200 systems for the control cabinet
SIMATIC ET 200SP

I/O modules > Communication > CM 4x IO-Link

Overview



- CM 4x IO-Link communication module
Serial communication module for connecting up to 4 IO-Link devices in accordance with IO-Link specification V1.0 and V1.1. The IO-Link parameters are configured using the Port Configuration Tool (PCT), version V3.0 and higher
- Time-based IO
Time-based IO ensures that signals are output with a precisely defined response time. By combining inputs and outputs, for example, passing products can be accurately measured or fluids dosed in precise quantities
- Supported data transfer rates
 - COM1 (4.8 Kbps)
 - COM2 (38.4 Kbps)
 - COM3 (230.4 Kbps)

- Expansion limits
 - Length of cable: Max. 20 m
 - Max. 32 bytes of input and output data per port
 - Max. 144 bytes of input data and 128 bytes of output data per module
- Supported ET 200SP system functions
 - Replacement without PG with automatic backup without the engineering tool of the IO-Link device parameter (V1.1 devices only) and the IO-Link master parameters by means of redundant saving of parameters on the e-coding element
 - Re-parameterization during operation
 - Identification data I&M
 - Firmware update
 - PROFlenergy
- Can be plugged onto Type A0 BaseUnits (BU) with automatic e-coding
- LEDs
 - DIAG: Operating state indicator (green/red) of the module
 - C1..C4: Port status indicator (green) for Port 1, 2, 3 and 4
 - Q1..Q4: Channel status indicator (green) for Port 1, 2, 3 and 4
 - F1..F4: Port fault indicator (red) for Port 1, 2, 3 and 4
 - PWR: Supply voltage indicator (green)
- Clear labeling on front of module
 - Plain text identification of the module type and function class
 - 2D matrix code (order and serial number)
 - Connection diagram
 - Color-coding of the CM module class: silver
 - Hardware and firmware version
 - Complete Article No.
- Optional accessories
 - Labeling strips
 - Equipment labeling plate
 - Color-coding plate with color code CC04
- Optional system-integrated shield connection

Overview of CM 4 x IO-Link

Communication module	Article No.	CC Code	BU type	PU
CM 4 x IO-Link	6ES7137-6BD00-0BA0	CC04	A0	1

Overview of BaseUnits

BaseUnit	Article No.	CC Codes for process terminals	CC Codes for AUX terminals	PU
BU type A0 • New load group (light) • 16 process terminals • With 10 AUX terminals	6ES7193-6BP20-0DA0	CC01 to CC05	CC71 to CC73	1
BU type A0 • New load group (light) • 16 process terminals • With 10 AUX terminals	6ES7193-6BP20-2DA0	CC01 to CC05	CC71 to CC73	10
BU type A0 • New load group (light) • 16 process terminals • Without AUX terminals	6ES7193-6BP00-0DA0	CC01 to CC05	--	1
BU type A0 • New load group (light) • 16 process terminals • Without AUX terminals	6ES7193-6BP00-2DA0	CC01 to CC05	--	10
BU type A0 • Forwarding of load group (dark) • 16 process terminals • With 10 AUX terminals	6ES7193-6BP20-0BA0	CC01 to CC05	CC71 to CC73	1

Overview (continued)

BaseUnit	Article No.	CC Codes for process terminals	CC Codes for AUX terminals	PU
BU type A0 <ul style="list-style-type: none"> • Forwarding of load group (dark) • 16 process terminals • With 10 AUX terminals 	6ES7193-6BP20-2BA0	CC01 to CC05	CC71 to CC73	10
BU type A0 <ul style="list-style-type: none"> • Forwarding of load group (dark) • 16 process terminals • Without AUX terminals 	6ES7193-6BP00-0BA0	CC01 to CC05	--	1
BU type A0 <ul style="list-style-type: none"> • Forwarding of load group (dark) • 16 process terminals • Without AUX terminals 	6ES7193-6BP00-2BA0	CC01 to CC05	--	10

Technical specifications

Article number	6ES7137-6BD00-0BA0 ET 200SP, CM 4 X IO-LINK ST
General information	
Product type designation	ET 200SP, CM 4xIO-Link
Product function	
• I&M data	Yes
Engineering with	
• STEP 7 TIA Portal configurable/integrated as of version	V13 / V13
• STEP 7 configurable/integrated as of version	V5.5 / -
• PROFIBUS as of GSD version/GSD revision	GSD Revision 5
• PROFINET as of GSD version/GSD revision	V2.3 / -
Supply voltage	
Rated value (DC)	24 V
Reverse polarity protection	Yes
Input current	
Current consumption, max.	45 mA; without load
Encoder supply	
Number of outputs	4
Output current	
• Rated value	200 mA
Power loss	
Power loss, typ.	1 W
Isochronous mode	
Equidistance	Yes

Article number	6ES7137-6BD00-0BA0 ET 200SP, CM 4 X IO-LINK ST
Interrupts/diagnostics/status information	
Diagnostics function	Yes
Alarms	
• Diagnostic alarm	Yes; The port diagnosis is available in the IO-Link mode only.
Diagnostic messages	
• Monitoring the supply voltage	Yes
Diagnostics indication LED	
• Monitoring of the supply voltage (PWR-LED)	Yes; green PWR LED
• Channel status display	Yes; one green LED for channel status Qn (SIO mode) and port status Cn (IO-Link mode) per channel
• for channel diagnostics	Yes; red Fn LED
• for module diagnostics	Yes; green/red DIAG LED
Potential separation	
Potential separation channels	
• between the channels	No
• between the channels and backplane bus	Yes
Isolation	
Isolation tested with	707 V DC (type test)
Dimensions	
Width	15 mm
Weights	
Weight, approx.	30 g

I/O systems

SIMATIC ET 200 systems for the control cabinet
SIMATIC ET 200SP

I/O modules > Communication > CM 4x IO-Link

Ordering data	Article No.	Ordering data	Article No.
CM 4x IO-Link master V1.1 Standard communication module Serial communication module for connecting up to 4 IO-Link devices, time-based IO, BU type A0, color code CC04	6ES7137-6BD00-0BA0	Labeling strips 500 labeling strips on roll, light gray, for inscription with thermal transfer roll printer	6ES7193-6LR10-0AA0
Accessories		500 labeling strips on roll, yellow, for inscription with thermal transfer roll printer	6ES7193-6LR10-0AG0
Usable type A0 BaseUnits		1000 labeling strips DIN A4, light gray, card, perforated, for inscription with laser printer	6ES7193-6LA10-0AA0
BU15-P16+A10+2D BU type A0; BaseUnit (light) with 16 process terminals (1...16) to the module and an additional 10 internally jumpered AUX terminals (1 A to 10 A); for starting a new load group (max. 10 A)	6ES7193-6BP20-0DA0 6ES7193-6BP20-2DA0	1000 labeling strips DIN A4, yellow, card, perforated, for inscription with laser printer	6ES7193-6LA10-0AG0
<ul style="list-style-type: none"> • 1 unit • 10 units 		Color-coding plates Color code CC04, for 16 push-in terminals, BU type A0, A1, gray (terminals 1 to 8), red (terminals 9 to 12), blue (terminals 13 to 16); 10 units	6ES7193-6CP04-2MA0
BU15-P16+A0+2D BU type A0; BaseUnit (light) with 16 process terminals to the module; for starting a new load group (max. 10 A)	6ES7193-6BP00-0DA0 6ES7193-6BP00-2DA0	Color code CC71, for 10 AUX terminals, BU type A0, yellow/green (terminals 1 A to 10 A); 10 units	6ES7193-6CP71-2AA0
<ul style="list-style-type: none"> • 1 unit • 10 units 		Color code CC72, for 10 AUX terminals, BU type A0, red (terminals 1 A to 10 A); 10 units	6ES7193-6CP72-2AA0
BU15-P16+A10+2B BU type A0; BaseUnit (dark) with 16 process terminals (1...16) to the module and an additional 10 internally jumpered AUX terminals (1 A to 10 A); for continuing the load group	6ES7193-6BP20-0BA0 6ES7193-6BP20-2BA0	Color code CC73, for 10 AUX terminals, BU type A0, blue (terminals 1 A to 10 A); 10 units	6ES7193-6CP73-2AA0
<ul style="list-style-type: none"> • 1 unit • 10 units 		Spare parts	
BU15-P16+A0+2B BU type A0; BaseUnit (dark) with 16 process terminals to the module; for continuing the load group	6ES7193-6BP00-0BA0 6ES7193-6BP00-2BA0	Electronic coding element type H Pack of 5 units; included in scope of supply of CM 4x IO-Link module	6ES7193-6EH00-1AA0
<ul style="list-style-type: none"> • 1 unit • 10 units 			
Equipment labeling plate 10 sheets of 16 labels, for printing with thermal transfer card printer or plotter	6ES7193-6LF30-0AW0		

Overview

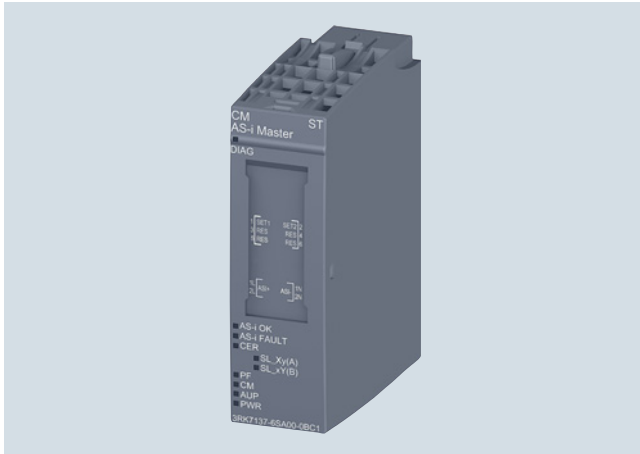

CM AS-i Master ST for SIMATIC ET 200SP

The CM AS-i Master ST communication module is designed for use in the SIMATIC ET 200SP distributed I/O system and has the following features:

- As many as 62 AS-Interface slaves can be connected
- Supports all AS-Interface master functions according to the AS-Interface Specification V3.0
- User-friendly configuration with graphic display of the AS-i line in TIA Portal V12 and higher, or via GSD in other systems
- Supply via AS-Interface cable
- Suitable for AS-i Power24V and for AS-Interface with 30 V voltage
- Integrated ground-fault monitoring for the AS-Interface cable
- Through connection to AS-Interface, the number of digital inputs and outputs available for the control system is greatly increased (max. 496 DI/496 DO on the AS-Interface per CM AS-i Master ST)
- Integrated analog value processing

ET 200SP Distributed I/O System

SIMATIC ET 200SP is a scalable and highly flexible distributed I/O system for connecting the process signals to a central control system via PROFIBUS or PROFINET.

Up to eight CM AS-i Master STs can be plugged onto a SIMATIC ET 200SP with the IM 155-6 PN standard interface module.

For more information, see "SIMATIC ET 200SP Distributed I/O system" System Manual, <https://support.industry.siemens.com/cs/ww/en/view/58649293>.

Design

The CM AS-i Master ST module has an ET 200SP module enclosure with a width of 20 mm. A C0 type BaseUnit (BU) is required for use in the ET 200SP.

The communication module has LED indicators for diagnostics, operation, AS-i voltage and AS-i slave status and offers informative front-side module inscription for:

- Plain-text marking of the module type and function class
- 2D matrix code (Article No. and serial number)
- Connection diagram
- Color coding of the CM module type: light gray
- Hardware and firmware version
- Complete Article No.

Function

The CM AS-i Master ST supports all specified functions of the AS-Interface Specification V3.0.

The input/output values of the digital AS-i slaves can be activated via the cyclic process image. The values of the analog AS-i slaves can be attained via the cyclic process image (firmware V1.1 or higher) or via data record transfer.

If required, master calls can be performed with the command interface, e.g. read/write parameters, read/write configuration.

Changeover of the operating mode, automatic application of the slave configuration and the re-addressing of a connected AS-i slave can be implemented via the control panel of the CM AS-i Master ST in STEP 7.

Expansions from firmware version V1.1

In order to implement modular machine concepts, the AS-i slaves can be activated or deactivated via the PLC program (option handling). The configuration of AS-i slaves can be modified while being executed, thus enabling variable machine setups and tool changing with integrated input/output modules during ongoing operation. Without deactivating the controller, AS-i input/output modules can be added in the system.

An existing AS-i installation can be read into the STEP 7 hardware configuration and then adapted and documented in the project. Analog values are transmitted via the cyclic process image, the length of which is adjustable and extendable up to 288 bytes (depending on the interface module (IM) used).

Diagnostic information is accessed via automatic alarm indications, via the process image or data record reading in the user program or in the STEP 7 engineering system in a graphical overview matrix. The AS-i network's transmission quality can also be read out. To avoid configuration errors, duplicate addresses in the AS-i network can be detected.

The new functions are available with TIA Portal STEP 7 V13 SP1 or with STEP 7 V5.5 with HSP 2092 V3.0¹⁾. Configuration is possible with SIMATIC CPUs S7-300 up to S7-1500 and with a SINUMERIK 840D sl or other controller.

In the network view, the AS-i slaves' online diagnostics status can be displayed directly on the slaves (in the case of S7-1500 CPUs with updated TIA Portal STEP 7 V14 firmware or higher).

¹⁾ HSP 2092, see <https://support.industry.siemens.com/cs/ww/en/view/23183356>.

I/O systems

SIMATIC ET 200 systems for the control cabinet
SIMATIC ET 200SP

I/O modules > Communication > CM AS-i Master ST for SIMATIC ET 200SP

Overview (continued)

Notes on safety

In order to protect plants, systems, machines and networks against cyber threats, it is necessary to implement – and continuously maintain – a holistic, state-of-the-art industrial security concept. Siemens products and solutions only represent one component of such a concept.

For more information on the topic of Industrial Security, see <http://www.siemens.com/industrialsecurity>.

Configuration

The following software is required for configuration of the CM AS-i Master ST module:

- STEP 7 (classic) V5.5 SP3 HF4 or higher with HSP 2092 or HSP 2092 V3.0 (for firmware V1.1) or
- STEP 7 (TIA Portal) V12 or higher or V13 SP1 or higher (for firmware V1.1) or
- the GSD file of the ET 200SP with STEP 7 or another engineering tool

STEP 7 enables user-friendly configuration and diagnostics of the AS-i master and any connected slaves.

Alternatively, you can also apply the AS-Interface ACTUAL configuration as the DESIRED configuration at the "touch of a button" via the control panel integrated in the TIA Portal or an optional expansion button. Configuration with the GSD file is possible only with the button.

The CM AS-i Master ST module occupies up to 288 input bytes and up to 288 output bytes in the I/O data of the ET 200SP station. The I/O assignment depends on the configuration in STEP 7.

Together with an ET 200SP CPU 1510SP/1512SP (firmware V1.8 or higher) or 1515SP PC, preprocessing of safe AS-i signals directly in the ET 200SP station and setting up of an independent AS-i station without a higher-level CPU are possible (TIA Portal V13 SP1 Update 4 and higher).

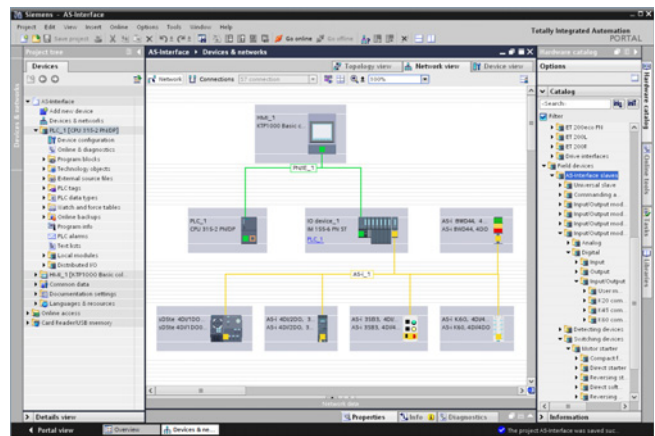

Configuration of an AS-Interface network with CM AS-i Master ST via TIA Portal

Ordering data	Article No.	Article No.
CM AS-i Master ST communication module <ul style="list-style-type: none"> AS-Interface Master for SIMATIC ET 200SP Can be plugged onto BaseUnit type C0 Corresponds to AS-Interface Specification V3.0 Dimensions (W x H x D / mm): 90 x 132 x 88.5 	3RK7137-6SA00-0BC1	BusAdapters for PROFINET For connection of the Ethernet cable to the PROFINET IM 155-6 PN interface module <ul style="list-style-type: none"> 2 x RJ45 connection (supplied without RJ45 connector) 2 x FC connection (FastConnect) For more BusAdapters with fiber-optic cable connection, see Catalog IK PI "Industrial Communication" or the Industry Mall .
Accessories		
BaseUnit BU20-P6+A2+4D <ul style="list-style-type: none"> BaseUnit (light), BU type C0 Suitable for the CM AS-i Master ST module For connection of AS-Interface cable to the CM AS-i Master ST Beginning of an AS-i network, disconnection of AS-i voltage to the left-hand module 	6ES7193-6BP20-0DC0	6ES7193-6AR00-0AA0 6ES7193-6AF00-0AA0
PROFINET IM 155-6 PN Basic interface module Max. 12 I/O modules, max. 32 bytes I/O data per station <ul style="list-style-type: none"> Including server module and BusAdapter 2 x RJ45 ports (supplied without RJ45 plug) 	6ES7155-6AR00-0AN0	AS-Interface addressing unit V3.0 3RK1904-2AB02 <ul style="list-style-type: none"> For AS-Interface modules and sensors and actuators with integrated AS-Interface according to AS-i Specification V3.0 For setting the AS-i address of standard slaves, and slaves with extended addressing mode (A/B slaves) With input/output test function and many other commissioning functions Battery operation with four type AA batteries (IEC LR6, NEDA 15) Degree of protection IP40 Dimensions (W x H x D / mm): 84 x 195 x 35 Scope of supply: <ul style="list-style-type: none"> Addressing unit with 4 batteries Addressing cable, with M12 plug to addressing plug (hollow plug), length 1.5 m More information For the Manual "CM AS-i Master ST for SIMATIC ET 200SP", see https://support.industry.siemens.com/cs/ww/en/view/71756485 .
PROFINET IM 155-6 PN Standard interface module Max. 32 I/O modules, max. 256 bytes I/O data per station <ul style="list-style-type: none"> Including server module and BusAdapter 2 x RJ45 (supplied without RJ45 plug) Including server module (BusAdapter must be ordered separately, see right) 	6ES7155-6AA00-0BN0 6ES7155-6AU00-0BN0	
PROFINET IM 155-6 DP Standard High Feature interface module Max. 64 I/O modules, max. 1 440 bytes I/O data per station <ul style="list-style-type: none"> Including server module BusAdapter must be ordered separately, see right) Including server module and PROFIBUS connector 	6ES7155-6AU00-0CN0 6ES7155-6BA00-0CN0	

I/O systems

SIMATIC ET 200 systems for the control cabinet
SIMATIC ET 200SP

I/O modules > Communication > CM DP for ET 200SP CPU

Overview

- PROFIBUS DP master/slave with electrical interface for connecting the ET 200SP CPUs to PROFIBUS at up to 12 Mbps
- Expands the ET 200SP CPUs 1510SP-1 PN / 1512SP-1 PN by one PROFIBUS connection
- For communication with lower-level PROFIBUS devices at bandwidths of 9.6 Kbps to 12 Mbps
- Communication services:
 - PROFIBUS DP
 - PG/OP communication
 - S7 communication:
 - This makes it possible to establish communication between the ET 200SP CPU and other devices, for example those from the SIMATIC S7-300/400/1500 range.
- Time synchronization
- Simple programming and configuration over PROFIBUS
- Cross-network PG communication using S7 routing
- Data set routing

Technical specifications

Article number	6ES7545-5DA00-0AB0 ET 200SP, CM DP FOR ET 200SP CPU
General information	
Product type designation	ET 200SP, CM DP
Engineering with	
• STEP 7 TIA Portal configurable/ integrated as of version	V13 Update 3
Installation type/mounting	
Rack mounting	No
Rail mounting	Yes; Standard - DIN rail
Supply voltage	
Type of supply voltage	24 V DC
Rated value (DC)	24 V
Reverse polarity protection	Yes
1. Interface	
Interface types	
• RS 485	Yes
Functionality	
• PROFIBUS DP master	Yes
• PROFIBUS DP slave	Yes
• SIMATIC communication	Yes
RS 485	
• Transmission rate, max.	12 Mbit/s
• Cable length, max.	100 m
Protocols	
PROFIBUS DP master	
Services	
- PG/OP communication	Yes
- S7 routing	Yes
- Data record routing	Yes
- Isochronous mode	No
- Equidistance	No
- Number of DP slaves	125
- Activation/deactivation of DP slaves	Yes

Article number	6ES7545-5DA00-0AB0 ET 200SP, CM DP FOR ET 200SP CPU
PROFIBUS DP slave	
• Transmission rate, max.	12 Mbit/s
• automatic baud rate search	Yes
• Address area, max.	120
• User data per address area, max.	128 byte
Services	
- PG/OP communication	Yes; Only with active interface
- Routing	Yes; Only with active interface
- S7 communication	Yes; Only with active interface
- Direct data exchange (slave-to-slave communication)	Yes; No subscriber possible - only passive publisher
- DPV1	Yes
Transfer memory	
- Inputs	244 byte
- Outputs	244 byte
Interrupts/diagnostics/ status information	
Diagnostics function	Yes
Diagnostics indication LED	
• for module diagnostics	Yes; green/red DIAG LED
Potential separation	
between backplane bus and interface	Yes
Ambient conditions	
Ambient temperature during operation	
• horizontal installation, min.	0 °C
• horizontal installation, max.	60 °C
• vertical installation, min.	0 °C
• vertical installation, max.	50 °C
Dimensions	
Width	35 mm
Height	117 mm
Depth	75 mm
Weights	
Weight, approx.	80 g

Ordering data	Article No.		Article No.
CM DP for ET 200SP CPU PROFIBUS DP master/slave with electrical interface for connecting the ET 200SP CPUs to PROFIBUS at up to 12 Mbps	6ES7545-5DA00-0AB0	PROFIBUS DP bus connector RS 485 with 90° cable outlet, max. transfer rate 12 Mbps • without PG interface • with PG interface	6ES7972-0BA12-0XA0 6ES7972-0BB12-0XA0
Accessories			
Reference identification label 10 sheets of 16 labels	6ES7193-6LF30-0AW0	with 90° cable outlet for FastConnect connection system, max. transfer rate 12 Mbps • without PG interface, 1 unit • without PG interface, 100 units • with PG interface, 1 unit • with PG interface, 100 units	6ES7972-0BA52-0XA0 6ES7972-0BA52-0XB0 6ES7972-0BB52-0XA0 6ES7972-0BB52-0XB0
Labeling strips 500 labeling strips on roll, light gray, for inscription with thermal transfer roll printer	6ES7193-6LR10-0AA0	FastConnect bus cable Standard type with special design for quick mounting, 2-core, shielded, sold by the meter; max. delivery unit 1000 m, minimum order quantity 20 m	6XV1830-0EH10
500 labeling strips on roll, yellow, for inscription with thermal transfer roll printer	6ES7193-6LR10-0AG0		
1000 labeling strips DIN A4, light gray, card, for inscription with laser printer	6ES7193-6LA10-0AA0		
1000 labeling strips DIN A4, yellow, card, for inscription with laser printer	6ES7193-6LA10-0AG0		

I/O systems

SIMATIC ET 200 systems for the control cabinet
SIMATIC ET 200SP

I/O modules > Communication > CP 1542SP-1

Overview



The CP 1542SP-1 communications processor connects the ET 200SP Distributed Controller with Industrial Ethernet networks.

The module can also be used for integrating the ET 200SP Distributed Controller into an IPv6-based network. All functions are configured using STEP 7 Professional V14 (TIA Portal) or higher.

The CP 1542SP-1 supports the following communication services:

- PG/OP communication
- S7 communication
- Open communication (Open User Communication)
- IT communication
 - Sending emails via SMTP for authentication on an email server (also with IPv6)
 - SNMPv1 for transfer of network analysis information
- Integration of the ET 200SP Distributed Controller into IPv6-based networks

ISO	TCP/UDP	PN	MRP	IT	IP-R	PG/OP	S7
	●			●		●	●

G...JK10...XX...50730

Technical specifications

Article number	6GK7542-6UX00-0XE0
Product type designation	CP 1542SP-1
Transmission rate	
Transfer rate	
• at the 1st interface	10 ... 100 Mbit/s
Interfaces	
Number of interfaces acc. to Industrial Ethernet	1
Number of electrical connections	
• at the 1st interface acc. to Industrial Ethernet	2
Type of electrical connection	
• at the 1st interface acc. to Industrial Ethernet	via ET200SP bus adaptor (RJ45, FC, LC, SCRJ), switch integrated
Supply voltage, current consumption, power loss	
Type of voltage of the supply voltage	DC
Supply voltage	24 V
Supply voltage	19.2 ... 28.8 V
Power loss [W]	2.64 W
Permitted ambient conditions	
Ambient temperature	
• for vertical installation during operation	0 ... 50 °C
• for horizontally arranged busbars during operation	0 ... 60 °C
• during storage	-40 ... +70 °C
• during transport	-40 ... +70 °C
Relative humidity at 25 °C without condensation during operation maximum	95 %
Protection class IP	IP20

Article number	6GK7542-6UX00-0XE0
Product type designation	CP 1542SP-1
Design, dimensions and weight	
Width	60 mm
Height	117 mm
Depth	74 mm
Net weight	0.18 kg
Mounting type	
• 35 mm DIN rail mounting	Yes
Product properties, functions, components general	
Number of units	
• per CPU maximum	2
• Note	2 CPs can be plugged in per CPU, simultaneous operation with BA Send and CM DP is possible
Performance data open communication	
Number of possible connections for open communication	
• by means of T blocks maximum	32
Amount of data	
• as user data per ISO on TCP connection for open communication by means of T blocks maximum	65 536 byte
Performance data S7 communication	
Number of possible connections for S7 communication	
• maximum	16
• with OP connections maximum	16

Technical specifications (continued)

Article number	6GK7542-6UX00-0XE0
Product type designation	CP 1542SP-1
Performance data multi-protocol mode	
Number of active connections with multi-protocol mode	32
Product function MIB support	Yes
Protocol is supported	
• SNMP v1	Yes
• SNMP v3	No
• DCP	Yes
• LLDP	Yes
Configuration software	
• required	STEP 7 Professional V14 (TIA Portal) or higher
Identification & maintenance function	
• I&MO - device-specific information	Yes
• I&M1 – higher-level designation/location designation	Yes
Product functions Diagnosis	
Product function Web-based diagnostics	Yes; yes, via ET 200SP CPU

Article number	6GK7542-6UX00-0XE0
Product type designation	CP 1542SP-1
Product functions Security	
Product function	
• Blocking of communication via physical ports	Yes
Product functions Time	
Product function SICLOCK support	Yes
Product function pass on time synchronization	No
Protocol is supported	
• NTP	Yes
• NTP (secure)	No
time synchronization	
• from NTP-server	Yes

Ordering data

Ordering data	Article No.	Ordering data	Article No.
CP 1542SP-1 communications processor For connection of SIMATIC S7 ET 200SP to Industrial Ethernet, open IE communication (TCP/IP, ISO-ON-TCP, UDP), PG/OP, S7 routing, IP broadcast/multicast, SNMPv1, DHCP, email, IPv4/IPv6, time synchronization via NTP, access to web server of CPU, BusAdapter required	6GK7542-6UX00-0XE0	SIMATIC BA SCRJ/RJ45 BusAdapter For PROFINET interface modules, High Feature function class or above; fiber-optic cable connection for POF or PCF; for increased vibration and EMC load capacity; max. cable length 50 m (POF) or 100 m (PCF)	6ES7193-6AP20-0AA0
Accessories		SIMATIC BA SCRJ/FC BusAdapter For PROFINET interface modules, High Feature function class or above; with media converter FOC-Cu; for increased vibration and EMC loads; max. cable length 50 m (POF, copper) or 100 m (PCF)	6ES7193-6AP40-0AA0
SIMATIC BA 2xRJ45 BusAdapter For PROFINET interface modules, Standard function class or above; max. cable length 50 m	6ES7193-6AR00-0AA0	SIMATIC BA 2XLC BusAdapter For PROFINET interface modules, High Feature function class or above; with LC fiber-optic connection; for increased vibration and EMC load capacity; max. cable length 2 km	6ES7193-6AG00-0AA0
SIMATIC BA 2xFC BusAdapter For PROFINET interface modules, Standard function class or above; for increased vibration and EMC loads; max. cable length 50 m	6ES7193-6AF00-0AA0	SIMATIC BA LC/RJ45 BusAdapter For PROFINET interface modules, High Feature function class or above; with media converter FOC-Cu; for increased vibration and EMC loads; max. cable length 2 km (fiber-optic) or 50 m (copper)	6ES7193-6AG20-0AA0
SIMATIC BA 2xSCRJ BusAdapter For PROFINET interface modules, High Feature function class or above; fiber-optic cable connection for POF or PCF; for increased vibration and EMC load capacity; max. cable length 50 m (POF) or 100 m (PCF)	6ES7193-6AP00-0AA0	SIMATIC BA LC/FC BusAdapter For PROFINET interface modules, High Feature function class or above; with media converter FOC-Cu; for increased vibration and EMC loads; max. cable length 2 km (fiber-optic) or 50 m (copper)	6ES7193-6AG40-0AA0

I/O systems

SIMATIC ET 200 systems for the control cabinet
SIMATIC ET 200SP

I/O modules > Communication > CP 1542SP-1

Ordering data	Article No.	Article No.
IE FC RJ45 Plug 180 2 x 2 RJ45 plug connector for Industrial Ethernet with a rugged metal enclosure and integrated insulation displacement contacts for connecting Industrial Ethernet FC installation cables; with 180° cable outlet; for network components and CPs/CPUs with Industrial Ethernet interface <ul style="list-style-type: none"> • 1 pack = 1 unit • 1 pack = 10 units • 1 pack = 50 units 	6GK1901-1BB10-2AA0 6GK1901-1BB10-2AB0 6GK1901-1BB10-2AE0	IE FC Stripping Tool Preadjusted stripping tool for fast stripping of the Industrial Ethernet FC cables 6GK1901-1GA00
IE FC RJ45 Plug 4 x 2 RJ45 plug connector for Industrial Ethernet (10/100/1000 Mbps) with a rugged metal enclosure and integrated insulation displacement contacts for connecting Industrial Ethernet FC installation cables; 180° cable outlet; for network components and CPs/CPUs with Industrial Ethernet interface <ul style="list-style-type: none"> • 1 pack = 1 unit • 1 pack = 10 units • 1 pack = 50 units 	6GK1901-1BB11-2AA0 6GK1901-1BB11-2AB0 6GK1901-1BB11-2AE0	Labeling strips 500 labeling strips on roll, light gray, for labeling with thermal transfer roll printer 6ES7193-6LR10-0AA0 500 labeling strips on roll, yellow, for labeling with thermal transfer roll printer 6ES7193-6LR10-0AG0 1000 labeling strips DIN A4, light gray, card, perforated, for labeling with laser printer 6ES7193-6LA10-0AA0 1000 labeling strips DIN A4, yellow, card, perforated, for labeling with laser printer 6ES7193-6LA10-0AG0
IE FC TP Standard Cable GP 2 x 2 (Type A) 4-core, shielded TP installation cable for connection to IE FC outlet RJ45/IE FC RJ45 plug; PROFINET-compatible; with UL approval; sold by the meter; max. length 1000 m, minimum order quantity 20 m	6XV1840-2AH10	Equipment labeling plate 10 sheets of 16 labels, for printing with thermal transfer card printer or plotter 6ES7193-6LF30-0AW0
IE FC TP Standard Cable GP 4 x 2 8-core, shielded TP installation cable for connection to IE FC RJ45 Modular Outlet for universal applications; with UL approval; sold by the meter; max. quantity 1000 m, minimum order 20 m <ul style="list-style-type: none"> • AWG22, for connection to IE FC RJ45 Modular Outlet • AWG24, for connection to IE FC RJ45 Plug 4 x 2 	6XV1870-2E 6XV1878-2A	Spare parts Server module Terminates an ET 200SP station; included in the scope of delivery of the interface modules 6ES7193-6PA00-0AA0
		PE connection element for DIN rail 2000 mm 20 units 6ES7590-5AA00-0AA0
		Power supply connector Spare part; for connecting the 24 V DC supply voltage; with push-in terminals 6ES7193-4JB00-0AA0

Note:

You can find order information for software for communication with PC systems in Catalog IK PI or in the Industry Mall.

Overview



ISO	TCP/UDP	PN	MRP	IT	IP-R	PG/OP	S7
	●			●		●	●

G_1K10_XX_50730

The CP 1543SP-1 communications processor connects the ET 200SP Distributed Controller with Industrial Ethernet networks. By combining a variety of security features such as an SPI (Stateful Packet Inspection) firewall, VPN and data

encryption protocols (e.g. SNMPv3), the communications processor protects individual ET 200SP Distributed Controllers or even entire automation cells against unauthorized access.

The module can also be used for integrating the ET 200SP Distributed Controller into an IPv6-based network. All functions can be configured with STEP 7 Professional V14 (TIA Portal) and higher.

The CP 1543SP-1 supports the following communication services:

- PG/OP communication
- S7 communication
- Open communication (Open User Communication)
- IT communication
 - Sending emails via SMTP or ESMTP with "SMTP-Auth" for authentication on an email server (also with IPv6)
- Security functions
 - Stateful Packet Inspection (layer 3 and 4 firewall)
 - Secure communication via VPN (IPsec)
 - Secure access to the web server of the CPU via the HTTPS protocol
 - Secure transfer of the time of day (NTP)
 - SNMPv3 for tap-proof transfer of network analysis information
- Integration of the ET 200SP Distributed Controller into IPv6-based networks

Technical specifications

Article number	6GK7543-6WX00-0XE0
Product type designation	CP 1543SP-1
Transmission rate	
Transfer rate	
• at the 1st interface	10 ... 100 Mbit/s
Interfaces	
Number of interfaces acc. to Industrial Ethernet	1
Number of electrical connections	
• at the 1st interface acc. to Industrial Ethernet	2
Type of electrical connection	
• at the 1st interface acc. to Industrial Ethernet	via ET200SP bus adaptor (RJ45, FC, LC, SCRJ), switch integrated
Supply voltage, current consumption, power loss	
Type of voltage of the supply voltage	DC
Supply voltage	24 V
Supply voltage	19.2 ... 28.8 V
Power loss [W]	2.64 W
Permitted ambient conditions	
Ambient temperature	
• for vertical installation during operation	0 ... 50 °C
• for horizontally arranged busbars during operation	0 ... 60 °C
• during storage	-40 ... +70 °C
• during transport	-40 ... +70 °C
Relative humidity at 25 °C without condensation during operation maximum	95 %
Protection class IP	IP20

Article number	6GK7543-6WX00-0XE0
Product type designation	CP 1543SP-1
Design, dimensions and weight	
Width	60 mm
Height	117 mm
Depth	74 mm
Net weight	0.18 kg
Mounting type	
• 35 mm DIN rail mounting	Yes
Product properties, functions, components general	
Number of units	
• per CPU maximum	2
• Note	2 CPs can be plugged in per CPU, simultaneous operation with BA Send and CM DP is possible
Performance data open communication	
Number of possible connections for open communication	
• by means of T blocks maximum	32
Amount of data	
• as user data per ISO on TCP connection for open communication by means of T blocks maximum	65 536 byte
Performance data S7 communication	
Number of possible connections for S7 communication	
• maximum	16
• with OP connections maximum	16

I/O systemsSIMATIC ET 200 systems for the control cabinet
SIMATIC ET 200SP**I/O modules > Communication > CP 1543SP-1****Technical specifications** (continued)

Article number	6GK7543-6WX00-0XE0
Product type designation	CP 1543SP-1
Performance data multi-protocol mode	
Number of active connections with multi-protocol mode	32
Product function MIB support	Yes
Protocol is supported	
• SNMP v1	Yes
• SNMP v3	Yes
• DCP	Yes
• LLDP	Yes
Configuration software	
• required	STEP 7 Professional V14 (TIA Portal) or higher
Identification & maintenance function	
• I&M0 - device-specific information	Yes
• I&M1 – higher-level designation/location designation	Yes
Product functions Diagnosis	
Product function Web-based diagnostics	Yes; yes, via ET 200SP CPU

Article number	6GK7543-6WX00-0XE0
Product type designation	CP 1543SP-1
Product functions Security	
Firewall version	stateful inspection
Product function with VPN connection	IPSec
Type of encryption algorithms with VPN connection	AES-256, AES-192, AES-128, 3DES-168, DES-56
Type of authentication procedure with VPN connection	Preshared key (PSK), X.509v3 certificates
Type of hashing algorithms with VPN connection	MD5, SHA-1
Number of possible connections with VPN connection	4
Product function	
• switch-off of non-required services	Yes
• Blocking of communication via physical ports	Yes
• log file for unauthorized access	Yes
Product functions Time	
Product function SICLOCK support	Yes
Product function pass on time synchronization	No
Protocol is supported	
• NTP	Yes
• NTP (secure)	Yes
time synchronization	
• from NTP-server	Yes

Ordering data**Article No.****CP 1543SP-1 communications processor****6GK7543-6WX00-0XE0**

CP 1543SP-1 communications processor for connecting SIMATIC S7-ET 200SP to Industrial Ethernet, Security (firewall and VPN), open IE communication (TCP/IP, ISO-on-TCP, UDP) PG/OP, S7 routing, IP broadcast/multicast, SNMPv1/V3, DHCP, secure email, IPv4/IPv6, time synchronization via NTP, access to web server of CPU, BusAdapter required

Accessories**SIMATIC BA 2xRJ45 BusAdapter****6ES7193-6AR00-0AA0**

For PROFINET interface modules, Standard function class or above; max. cable length 50 m

SIMATIC BA 2xFC BusAdapter**6ES7193-6AF00-0AA0**

For PROFINET interface modules, Standard function class or above; for increased vibration and EMC loads; max. cable length 50 m

SIMATIC BA 2xSCRJ BusAdapter**6ES7193-6AP00-0AA0**

For PROFINET interface modules, High Feature function class or above; fiber-optic cable connection for POF or PCF; for increased vibration and EMC load capacity; max. cable length 50 m (POF) or 100 m (PCF)

Article No.**SIMATIC BA SCRJ/RJ45 BusAdapter****6ES7193-6AP20-0AA0**

For PROFINET interface modules, High Feature function class or above; fiber-optic cable connection for POF or PCF; for increased vibration and EMC load capacity; max. cable length 50 m (POF) or 100 m (PCF)

SIMATIC BA SCRJ/FC BusAdapter**6ES7193-6AP40-0AA0**

for PROFINET interface modules, High Feature function class or above; with media converter FOC-Cu; for increased vibration and EMC loads; max. cable length 50 m (POF, copper) or 100 m (PCF)

SIMATIC BA 2XLC BusAdapter**6ES7193-6AG00-0AA0**

For PROFINET interface modules, High Feature function class or above; with LC fiber-optic connection; for increased vibration and EMC load capacity; max. cable length 2 km

SIMATIC BA LC/RJ45 BusAdapter**6ES7193-6AG20-0AA0**

For PROFINET interface modules, High Feature function class or above; with media converter FOC-Cu; for increased vibration and EMC loads; max. cable length 2 km (fiber-optic) or 50 m (copper)

Ordering data	Article No.	Article No.
SIMATIC BA LC/FC BusAdapter For PROFINET interface modules, High Feature function class or above; with media converter FOC-Cu; for increased vibration and EMC loads; max. cable length 2 km (fiber-optic) or 50 m (copper)	6ES7193-6AG40-0AA0	
IE FC RJ45 Plug 180 2 x 2 RJ45 plug connector for Industrial Ethernet with a rugged metal enclosure and integrated insulation displacement contacts for connecting Industrial Ethernet FC installation cables; with 180° cable outlet; for network components and CPs/CPUs with Industrial Ethernet interface <ul style="list-style-type: none"> • 1 pack = 1 unit • 1 pack = 10 units • 1 pack = 50 units 	6GK1901-1BB10-2AA0 6GK1901-1BB10-2AB0 6GK1901-1BB10-2AE0	IE FC TP Standard Cable GP 4 x 2 8-core, shielded TP installation cable for connection to IE FC RJ45 Modular outlet for universal applications; with UL approval; sold by the meter; max. quantity 1000 m, minimum order quantity 20 m <ul style="list-style-type: none"> • AWG22, for connection to IE FC RJ45 Modular Outlet • AWG24, for connection to IE FC RJ45 Plug 4 x 2
IE FC RJ45 Plug 4 x 2 RJ45 plug connector for Industrial Ethernet (10/100/1000 Mbps) with a rugged metal enclosure and integrated insulation displacement contacts for connecting Industrial Ethernet FC installation cables; 180° cable outlet; for network components and CPs/CPUs with Industrial Ethernet interface <ul style="list-style-type: none"> • 1 pack = 1 unit • 1 pack = 10 units • 1 pack = 50 units 	6GK1901-1BB11-2AA0 6GK1901-1BB11-2AB0 6GK1901-1BB11-2AE0	IE FC Stripping Tool Preadjusted stripping tool for fast stripping of the Industrial Ethernet FC cables
IE FC TP Standard Cable GP 2 x 2 (Type A) 4-core, shielded TP installation cable for connection to IE FC outlet RJ45/IE FC RJ45 plug; PROFINET-compatible; with UL approval; sold by the meter; max. length 1000 m, minimum order quantity 20 m	6XV1840-2AH10	Labeling strips 500 labeling strips on roll, light gray, for labeling with thermal transfer roll printer 500 labeling strips on roll, yellow, for labeling with thermal transfer roll printer 1000 labeling strips DIN A4, light gray, card, perforated, for labeling with laser printer 1000 labeling strips DIN A4, yellow, card, perforated, for labeling with laser printer
		Equipment labeling plate 10 sheets of 16 labels, for printing with thermal transfer card printer or plotter
		Spare parts Server module Terminates an ET 200SP station; included in the scope of delivery of the interface modules
		PE connection element for DIN rail 2000 mm 20 units
		Power supply connector Spare part; for connecting the 24 V DC supply voltage; with push-in terminals
		6XV1870-2E 6XV1878-2A 6GK1901-1GA00 6ES7193-6LR10-0AA0 6ES7193-6LR10-0AG0 6ES7193-6LA10-0AA0 6ES7193-6LA10-0AG0 6ES7193-6LF30-0AW0 6ES7193-6PA00-0AA0 6ES7590-5AA00-0AA0 6ES7193-4JB00-0AA0

Note:

You can find order information for software for communication with PC systems in Catalog IK PI or in the Industry Mall.

I/O systems

SIMATIC ET 200 systems for the control cabinet
SIMATIC ET 200SP

I/O modules > Communication > CP 1542SP-1 IRC

Overview



ISO	TCP/UDP	PN	MRP	IT	IP-R	PG/OP	S7
	●			●		●	●

G...JK10...XX...50730

The CP 1542SP-1 IRC communications processor connects the ET 200SP Distributed Controller with Industrial Ethernet networks. In addition, control centers can be connected using various telecontrol protocols.

The CP is characterized by the following:

- Ethernet-based connection to TeleControl Server Basic, e.g. via Internet
- Ethernet-based connection to the control center via IEC 60870-5-104 or DNP3 protocol
- Data transfer of measured values, control variable values or alarms optimized for telecontrol systems
- Automatic sending of alert emails
- Data buffering of up to 100,000 values ensures a secure database, even with temporary connection failures
- Clearly laid out LED signaling for fast and easy diagnostics
- Fast commissioning thanks to easy configuration using STEP 7

The module can also be used for integrating the ET 200SP Distributed Controller into an IPv6-based network. All functions are configured using STEP 7 Professional V14 (TIA Portal) or higher.

The CP 1542SP-1 IRC supports the following communication services:

- Supports multiple telecontrol protocols such as DNP3, IEC 60870-5-104 and TeleControl Basic
- PG/OP communication
- S7 communication
- Open communication (Open User Communication)
- IT communication
 - Sending emails via SMTP or SMTPS with "SMTP-Auth" for authentication on an email server (also with IPv6)
 - Email transfer with addressing by program block
 - Email transfer via "Notifications" (alerts)

Technical specifications

Article number	6GK7542-6VX00-0XE0
Product type designation	CP 1542SP-1 IRC
Transmission rate	
Transfer rate	
• at the 1st interface	10 ... 100 Mbit/s
Interfaces	
Number of interfaces acc. to Industrial Ethernet	1
Number of electrical connections	
• at the 1st interface acc. to Industrial Ethernet	2
Type of electrical connection	
• at the 1st interface acc. to Industrial Ethernet	via ET200SP bus adaptor (RJ45, FC, LC, SCRJ), switch integrated
Supply voltage, current consumption, power loss	
Type of voltage of the supply voltage	DC
Supply voltage	24 V
Supply voltage	19.2 ... 28.8 V
Power loss [W]	2.64 W
Permitted ambient conditions	
Ambient temperature	
• for vertical installation during operation	0 ... 50 °C
• for horizontally arranged busbars during operation	0 ... 60 °C
• during storage	-40 ... +70 °C
• during transport	-40 ... +70 °C
Relative humidity at 25 °C without condensation during operation maximum	95 %
Protection class IP	IP20
Design, dimensions and weight	
Width	60 mm
Height	117 mm
Depth	74 mm
Net weight	0.18 kg
Mounting type	
• 35 mm DIN rail mounting	Yes
Product properties, functions, components general	
Number of units	
• per CPU maximum	2
• Note	2 CPUs can be plugged in per CPU, simultaneous operation with BA Send and CM DP is possible
Performance data open communication	
Number of possible connections for open communication	
• by means of T blocks maximum	32
Amount of data	
• as user data per ISO on TCP connection for open communication by means of T blocks maximum	65 536 byte
Performance data S7 communication	
Number of possible connections for S7 communication	
• maximum	16
• with OP connections maximum	16

Article number	6GK7542-6VX00-0XE0
Product type designation	CP 1542SP-1 IRC
Performance data multi-protocol mode	
Number of active connections with multi-protocol mode	32
Performance data telecontrol	
Suitability for use	
• Node station	No
• substation	Yes
• TIM control center	No
Control center connection	IEC 60870-5, DNP3, (Modbus TCP using software components of the CPU) capable control stations and connection to Telecontrol Server Basic
• by means of a permanent connection	supported
• by means of demand-oriented connection	supported
• Note	Connection to SCADA system using IEC 60870-5 104, DNP3 and Telecontrol Server Basic
Protocol is supported	
• TCP/IP	Yes
• DNP3	Yes
• IEC 60870-5	Yes
Product function data buffering if connection is aborted	Yes
Number of data points per station maximum	500
Product function MIB support	Yes
Protocol is supported	
• SNMP v1	Yes
• SNMP v3	No
• DCP	Yes
• LLDP	Yes
Configuration software	
• required	STEP 7 Professional V14 (TIA Portal) or higher
Identification & maintenance function	
• I&MO - device-specific information	Yes
• I&M1 – higher-level designation/ location designation	Yes
Product functions Diagnosis	
Product function Web-based diagnostics	Yes; yes, via ET 200SP CPU
Product functions Security	
Product function	
• Blocking of communication via physical ports	Yes
Product functions Time	
Product function SICLOCK support	Yes
Product function pass on time synchronization	Yes
Protocol is supported	
• NTP	Yes
• NTP (secure)	No
time synchronization	
• from NTP-server	Yes
• from control center	Yes

I/O systemsSIMATIC ET 200 systems for the control cabinet
SIMATIC ET 200SP**I/O modules > Communication > CP 1542SP-1 IRC**

Ordering data	Article No.	Article No.
CP 1542SP-1 IRC communications processor CP 1542SP-1 IRC communications processor for connection of SIMATIC S7 ET 200SP to Industrial Ethernet, TeleControl Server Basic, IEC 60870-5-104 or DNP3 protocol to a control center; open IE communication (TCP/IP, ISO-on-TCP, UDP), IP broadcast/multicast, SNMPv1, DHCP, secure email, IPv4/IPv6, time synchronization via NTP, access to web server of CPU, BusAdapter required	6GK7542-6VX00-0XE0	
Accessories SIMATIC BA 2xRJ45 BusAdapter For PROFINET interface modules, Standard function class or above; max. cable length 50 m	6ES7193-6AR00-0AA0	
SIMATIC BA 2xFC BusAdapter For PROFINET interface modules, Standard function class or above; for increased vibration and EMC loads; max. cable length 50 m	6ES7193-6AF00-0AA0	
SIMATIC BA 2xSCRJ BusAdapter For PROFINET interface modules, High Feature function class or above; fiber-optic cable connection for POF or PCF; for increased vibration and EMC load capacity; max. cable length 50 m (POF) or 100 m (PCF)	6ES7193-6AP00-0AA0	
SIMATIC BA SCRJ/RJ45 BusAdapter For PROFINET interface modules, High Feature function class or above; fiber-optic cable connection for POF or PCF; for increased vibration and EMC load capacity; max. cable length 50 m (POF) or 100 m (PCF)	6ES7193-6AP20-0AA0	
SIMATIC BA SCRJ/FC BusAdapter for PROFINET interface modules, High Feature function class or above; with media converter FOC-Cu; for increased vibration and EMC loads; max. cable length 50 m (POF, copper) or 100 m (PCF)	6ES7193-6AP40-0AA0	
SIMATIC BA 2XLC BusAdapter For PROFINET interface modules, High Feature function class or above; with LC fiber-optic connection; for increased vibration and EMC load capacity; max. cable length 2 km	6ES7193-6AG00-0AA0	
SIMATIC BA LC/RJ45 BusAdapter For PROFINET interface modules, High Feature function class or above; with media converter FOC-Cu; for increased vibration and EMC loads; max. cable length 2 km (fiber-optic) or 50 m (copper)	6ES7193-6AG20-0AA0	
SIMATIC BA LC/FC BusAdapter For PROFINET interface modules, High Feature function class or above; with media converter FOC-Cu; for increased vibration and EMC loads; max. cable length 2 km (fiber-optic) or 50 m (copper)	6ES7193-6AG40-0AA0	
IE FC RJ45 Plug 180 2 x 2 RJ45 plug connector for Industrial Ethernet with a rugged metal enclosure and integrated insulation displacement contacts for connecting Industrial Ethernet FC installation cables; with 180° cable outlet; for network components and CPs/CPUs with Industrial Ethernet interface <ul style="list-style-type: none"> • 1 pack = 1 unit • 1 pack = 10 units • 1 pack = 50 units 		6GK1901-1BB10-2AA0 6GK1901-1BB10-2AB0 6GK1901-1BB10-2AE0
IE FC RJ45 Plug 4 x 2 RJ45 plug connector for Industrial Ethernet (10/100/1000 Mbps) with a rugged metal enclosure and integrated insulation displacement contacts for connecting Industrial Ethernet FC installation cables; 180° cable outlet; for network components and CPs/CPUs with Industrial Ethernet interface <ul style="list-style-type: none"> • 1 pack = 1 unit • 1 pack = 10 units • 1 pack = 50 units 		6GK1901-1BB11-2AA0 6GK1901-1BB11-2AB0 6GK1901-1BB11-2AE0
IE FC TP Standard Cable GP 2 x 2 (Type A) 4-core, shielded TP installation cable for connection to IE FC outlet RJ45/IE FC RJ45 plug; PROFINET-compatible; with UL approval; sold by the meter; max. length 1000 m, minimum order quantity 20 m		6XV1840-2AH10
IE FC TP Standard Cable GP 4 x 2 8-core, shielded TP installation cable for connection to IE FC RJ45 Modular Outlet for universal applications; with UL approval; sold by the meter; max. quantity 1000 m, minimum order quantity 20 m <ul style="list-style-type: none"> • AWG22, for connection to IE FC RJ45 Modular Outlet • AWG24, for connection to IE FC RJ45 Plug 4 x 2 		6XV1870-2E 6XV1878-2A

Ordering data	Article No.	Article No.
IE FC Stripping Tool Preadjusted stripping tool for fast stripping of the Industrial Ethernet FC cables	6GK1901-1GA00	
Labeling strips 500 labeling strips on roll, light gray, for labeling with thermal transfer roll printer	6ES7193-6LR10-0AA0	
500 labeling strips on roll, yellow, for labeling with thermal transfer roll printer	6ES7193-6LR10-0AG0	
1000 labeling strips DIN A4, light gray, card, perforated, for labeling with laser printer	6ES7193-6LA10-0AA0	
1000 labeling strips DIN A4, yellow, card, perforated, for labeling with laser printer	6ES7193-6LA10-0AG0	
Equipment labeling plate 10 sheets of 16 labels, for printing with thermal transfer card printer or plotter	6ES7193-6LF30-0AW0	
Spare parts		
Server module Terminates an ET 200SP station; included in the scope of delivery of the interface modules	6ES7193-6PA00-0AA0	
PE connection element for DIN rail 2000 mm 20 units	6ES7590-5AA00-0AA0	
Power supply connector Spare part; for connecting the 24 V DC supply voltage; with push-in terminals	6ES7193-4JB00-0AA0	
		TeleControl Server Basic V3.0 Software for 8 to 5000 stations; single license for one installation; OPC (UA) server for GPRS and Ethernet/Internet communication with SIMATIC S7-1200 and SIMATIC S7-200 (GPRS only); connection management to remote stations; routing for connections between S7 stations; German and English operator interface; for Windows 7 Professional 32/64-bit + Service Pack 1 Windows 7 Enterprise 32/64-bit + Service Pack 1 Windows 7 Ultimate 32/64-bit + Service Pack 1 Windows Server 2008 32-bit + Service Pack 2 MS Windows Server 2008 R2 Standard 64-bit + Service Pack 1
		<ul style="list-style-type: none"> • TeleControl Server Basic 8 V3 Connection management for 8 SIMATIC S7-1200 or S7-200 stations 6NH9910-0AA21-0AA0 • TeleControl Server Basic 32 V3 Connection management for 32 SIMATIC S7-1200 or S7-200 stations 6NH9910-0AA21-0AF0 • TeleControl Server Basic 64 V3 Connection management for 64 SIMATIC S7-1200 or S7-200 stations 6NH9910-0AA21-0AB0 • TeleControl Server Basic 256 V3 Connection management for 256 SIMATIC S7-1200 or S7-200 stations 6NH9910-0AA21-0AC0 • TeleControl Server Basic 1000 V3 Connection management for 1000 SIMATIC S7-1200 or S7-200 stations 6NH9910-0AA21-0AD0 • TeleControl Server Basic 5000 V3 Connection management for 5000 SIMATIC S7-1200 or S7-200 stations 6NH9910-0AA21-0AE0 • TeleControl Server Basic UPGR V3 Upgrade package from Version V2.x to V3 for all license sizes 6NH9910-0AA21-0GA0

Note:

You can find order information for software for communication with PC systems in Catalog IK PI or in the Industry Mall.

I/O systems

SIMATIC ET 200 systems for the control cabinet
SIMATIC ET 200SP

I/O modules > Communication > SCALANCE W761 RJ45 for the control cabinet**Overview**

- Low-cost Access Point, suitable for applications where the device is to be mounted in the control cabinet

Technical specifications

Article number	6GK5761-1FC00-0AA0 6GK5761-1FC00-0AB0 ¹⁾
Product type designation	SCALANCE W761-1 RJ45
Transmission rate	
• Transfer rate with WLAN maximum	150 Mbit/s
• Transfer rate for Industrial Ethernet	10 Mbit/s, 100 Mbit/s, 10 Mbit/s, 100 Mbit/s
Interfaces	
Number of electrical connections	
• for network components or terminal equipment	1
• for power supply	1
• for redundant voltage supply	0
Type of electrical connection	
• for network components or terminal equipment	RJ45 socket
• for power supply	3-pole screw terminal
design of the removable storage	
• C-PLUG	No
• KEY-PLUG	No
Interfaces wireless	
Number of radio cards permanently installed	1
Number of electrical connections for external antenna(s)	1
Type of electrical connection for external antenna(s)	R-SMA (socket)
Product feature external antenna can be mounted directly on device	Yes
Supply voltage, current consumption, power loss	
Type of voltage of the supply voltage	DC
Supply voltage 1	
• from terminal block	19.2 V
Supply voltage 2	
• from terminal block	28.8 V
Consumed current	
• at DC at 24 V typical	0.15 A
Power loss [W]	
• at DC at 24 V typical	3.6 W

Article number	6GK5761-1FC00-0AA0 6GK5761-1FC00-0AB0 ¹⁾
Product type designation	SCALANCE W761-1 RJ45
Permitted ambient conditions	
Ambient temperature	
• during operation	0 ... 55 °C
• during storage	-40 ... +85 °C
• during transport	-40 ... +85 °C
Relative humidity at 25 °C without condensation during operation maximum	95 %
Ambient condition for operation	When used under hazardous conditions (Zone 2), the SCALANCE W761-1 RJ45 or W72x-1 RJ45 product must be installed in an enclosure. To comply with EN 50021, this enclosure must meet the requirements of at least IP 54 in compliance with EN 60529.
Protection class IP	IP20
Design, dimensions and weight	
Width	50 mm
Height	114 mm
Depth	74 mm
Width of the enclosure without antenna	50 mm
Height of the enclosure without antenna	114 mm
Depth of the enclosure without antenna	74 mm
Net weight	0.13 kg
Mounting type	
• S7-300 rail mounting	No
• S7-1500 rail mounting	No
• 35 mm DIN rail mounting	Yes
• wall mounting	No

¹⁾ Wireless approval in the USA

Technical specifications (continued)

Article number	6GK5761-1FC00-0AA0 6GK5761-1FC00-0AB0 ¹⁾
Product type designation	SCALANCE W761-1 RJ45
Wireless frequencies	
Operating frequency	
• for WLAN in 2.4 GHz frequency band	2.41 ... 2.48 GHz
• for WLAN in 5 GHz frequency band	4.9 ... 5.8 GHz
Product properties, functions, components general	
Product function Access Point Mode	Yes
Product function Client Mode	Yes
Number of SSIDs	1
Product function	
• iPCF Access Point	No
• iPCF client	No
• iPCF-MC Access Point	No
• iPCF-MC client	No
Product functions management, configuration	
Number of manageable IP addresses in client	4
Product function	
• CLI	Yes
• web-based management	Yes
• MIB support	Yes
• TRAPs via email	Yes
• Configuration with STEP 7	Yes
• configuration with STEP 7 in the TIA Portal	Yes
• operation with IWLAN controller	No
• operation with Enterasys WLAN controller	No
• forced roaming on IP down with IWLAN	Yes
• forced roaming on link down with IWLAN	Yes
• WDS	Yes
Protocol is supported	
• Address Resolution Protocol (ARP)	Yes
• ICMP	Yes
• Telnet	Yes
• HTTP	Yes
• HTTPS	Yes
• TFTP	Yes
• DCP	Yes
• LLDP	Yes
Identification & maintenance function	
• I&MO - device-specific information	Yes
• I&M1 – higher-level designation/location designation	Yes

Article number	6GK5761-1FC00-0AA0 6GK5761-1FC00-0AB0 ¹⁾
Product type designation	SCALANCE W761-1 RJ45
Product functions Diagnosis	
Product function	
• PROFINET IO diagnosis	No
• Link Check	No
• connection monitoring IP-Alive	No
• localization via Aeroscout	No
• SysLog	Yes
Protocol is supported	
• SNMP v1	Yes
• SNMP v2	Yes
• SNMP v3	Yes
Product functions VLAN	
Product function	
• function VLAN with IWLAN	Yes
Product functions DHCP	
Product function	
• DHCP client	Yes
• in Client Mode DHCP server via LAN	Yes
• DHCP Option 82	Yes
Product functions Redundancy	
Protocol is supported	
• STP/RSTP	Yes
• MSTP	Yes
• RSTP	Yes
Product functions Security	
Product function	
• ACL - MAC-based	Yes
• Management security, ACL-IP based	Yes
• IEEE 802.1x (radius)	Yes
• NAT/NAPT	No
• access protection according to IEEE802.11i	Yes
• WPA/WPA2	Yes
• TKIP/AES	Yes
Protocol is supported	
• SSH	Yes
• RADIUS	Yes
Product functions Time	
Protocol is supported	
• NTP	Yes
• SNTP	Yes
• SIMATIC Time	Yes

¹⁾ Wireless approval in the USA

I/O systemsSIMATIC ET 200 systems for the control cabinet
SIMATIC ET 200SP**I/O modules > Communication > SCALANCE W761 RJ45 for the control cabinet****Technical specifications** (continued)

Article number	6GK5761-1FC00-0AA0 6GK5761-1FC00-0AB0 ¹⁾
Product type designation	SCALANCE W761-1 RJ45
Standards, specifications, approvals	
Standard	
• for FM	FM 3611: Class I, Division 2, Groups A,B,C,D, T4 / Class 1, Zone 2, Group IIC, T4
• for hazardous zone	EN 60079-15:2005, EN 60079-0:2006, II 3 G Ex nA II T4 KEMA 07 ATEX 0145X
• for safety from CSA and UL Certificate of suitability	UL 60950-1 CSA C22.2 No. 60950-1
• EC declaration of conformity	Yes
• CE marking	Yes
• C-Tick	Yes
• CCC	No
• E1 approval	No
• Railway application in accordance with EN 50155	No
• NEMA TS2	No
• IEC 61375	No
• IEC 61850-3	No
• NEMA4X	No
• Power-over-Ethernet according IEEE802.3at for type 1 and IEEE802.3af	No
• Power-over-Ethernet according to IEEE802.3at for type 2	No

Article number	6GK5761-1FC00-0AA0 6GK5761-1FC00-0AB0 ¹⁾
Product type designation	SCALANCE W761-1 RJ45
Standard for wireless communication	
• IEEE 802.11a	Yes
• IEEE 802.11b	Yes
• IEEE 802.11e	Yes
• IEEE 802.11g	Yes
• IEEE 802.11h	Yes
• IEEE 802.11i	Yes
• IEEE 802.11n	Yes
Wireless approval	You will find the current list of countries at: www.siemens.com/wireless-approvals
Marine classification association	
• American Bureau of Shipping Europe Ltd. (ABS)	No
• Bureau Veritas (BV)	No
• DNV GL	No
• Lloyds Register of Shipping (LRS)	No
• Nippon Kaiji Kyokai (NK)	No
• Polski Rejestr Statkow (PRS)	No
• Royal Institution of Naval Architects (RINA)	No
Accessories	
accessories	24 V DC screw terminal included in scope of delivery

¹⁾ Wireless approval in the USA

9

Ordering data**Article No.****SCALANCE W761 Access Points**

IWLAN Access Point with built-in wireless interface; wireless networks IEEE 802.11a/b/g/h/n at 2.4/5 GHz up to 150 Mbps; WPA2/AES; IP20 degree of protection (0 °C to +55 °C); scope of delivery: Mounting hardware, 3-pin screw terminal for 24 V DC; manual on CD-ROM; German/English

SCALANCE W761-1 RJ45

IWLAN Access Point with one built-in wireless interface

- National approvals for operation outside the USA
- National approvals for operation within the USA ²⁾

6GK5761-1FC00-0AA0**6GK5761-1FC00-0AB0****Article No.****Accessories****IE FC RJ45 Plug 180 2 x 2**

RJ45 plug connector for Industrial Ethernet with a rugged metal enclosure and integrated insulation displacement contacts for connecting Industrial Ethernet FC installation cables; with a 180° cable outlet; for network components and CPs/CPUs with Industrial Ethernet interface

- 1 pack = 1 unit
- 1 pack = 10 units
- 1 pack = 50 units

6GK1901-1BB10-2AA0**6GK1901-1BB10-2AB0****6GK1901-1BB10-2AE0****IE FC Standard Cable GP 2 x 2**

4-core, shielded TP installation cable for connection to IE FC outlet RJ45 plug / IE FC RJ45 plug; PROFINET-compliant; with UL approval; sold by the meter; max. quantity 1000 m, minimum order quantity 20 m

6XV1840-2AH10**IE FC Stripping Tool**

Preadjusted stripping tool for fast stripping of the Industrial Ethernet FC cables

6GK1901-1GA00**Antennas and miscellaneous IWLAN accessories**

See Catalog IK PI or Industry Mall

²⁾ Please note national approvals under <http://www.siemens.com/wireless-approvals>

Overview



- Low-cost Client Module, suitable for applications where the device is to be mounted in the control cabinet
- Equipped with iFeatures

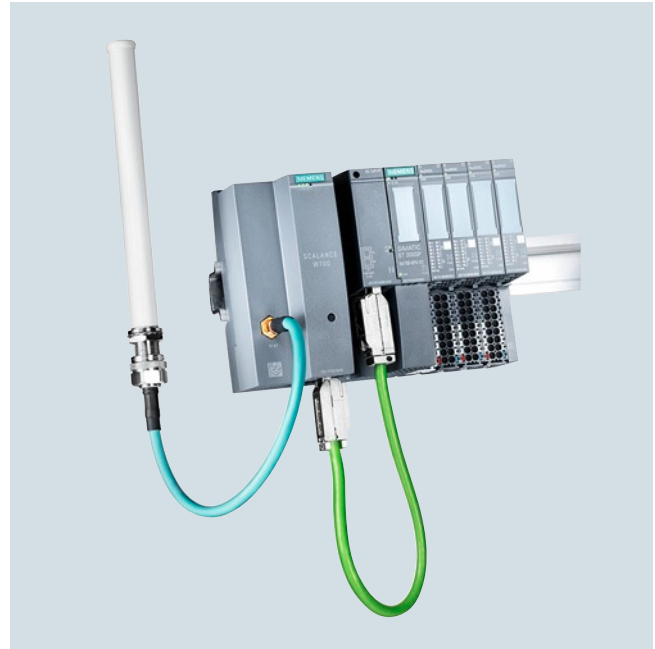

ET 200SP station with SCALANCE W722 RJ45

Technical specifications

Article number	6GK5722-1FC00-0AA0 6GK5722-1FC00-0AB0 ¹⁾
Product type designation	SCALANCE W722-1 RJ45
Transmission rate	
• Transfer rate with WLAN maximum	150 Mbit/s
• Transfer rate for Industrial Ethernet	10 Mbit/s, 100 Mbit/s, 10 Mbit/s, 100 Mbit/s
Interfaces	
Number of electrical connections	
• for network components or terminal equipment	1
• for power supply	1
• for redundant voltage supply	0
Type of electrical connection	
• for network components or terminal equipment	RJ45 socket
• for power supply	3-pole screw terminal
design of the removable storage	
• C-PLUG	No
• KEY-PLUG	No
Interfaces wireless	
Number of radio cards permanently installed	1
Number of electrical connections for external antenna(s)	1
Type of electrical connection for external antenna(s)	R-SMA (socket)
Product feature external antenna can be mounted directly on device	Yes

Article number	6GK5722-1FC00-0AA0 6GK5722-1FC00-0AB0 ¹⁾
Product type designation	SCALANCE W722-1 RJ45
Supply voltage, current consumption, power loss	
Type of voltage of the supply voltage	DC
Supply voltage 1	
• from terminal block	19.2 V
Supply voltage 2	
• from terminal block	28.8 V
Consumed current	
• at DC at 24 V typical	0.15 A
Power loss [W]	
• at DC at 24 V typical	3.6 W
Permitted ambient conditions	
Ambient temperature	
• during operation	0 ... 55 °C
• during storage	-40 ... +85 °C
• during transport	-40 ... +85 °C
Relative humidity at 25 °C without condensation during operation maximum	95 %
Ambient condition for operation	When used under hazardous conditions (Zone 2), the SCALANCE W761-1 RJ45 or W72x-1 RJ45 product must be installed in an enclosure. To comply with EN 50021, this enclosure must meet the requirements of at least IP 54 in compliance with EN 60529.
Protection class IP	IP20

¹⁾ Wireless approval in the USA

I/O systemsSIMATIC ET 200 systems for the control cabinet
SIMATIC ET 200SP**I/O modules > Communication > SCALANCE W722 RJ45 for the control cabinet****Technical specifications (continued)**

Article number	6GK5722-1FC00-0AA0 6GK5722-1FC00-0AB0 ¹⁾
Product type designation	SCALANCE W722-1 RJ45
Design, dimensions and weight	
Width	50 mm
Height	114 mm
Depth	74 mm
Width of the enclosure without antenna	50 mm
Height of the enclosure without antenna	114 mm
Depth of the enclosure without antenna	74 mm
Net weight	0.13 kg
Mounting type	
• S7-300 rail mounting	No
• S7-1500 rail mounting	No
• 35 mm DIN rail mounting	Yes
• wall mounting	No
Wireless frequencies	
Operating frequency	
• for WLAN in 2.4 GHz frequency band	2.41 ... 2.48 GHz
• for WLAN in 5 GHz frequency band	4.9 ... 5.8 GHz
Product properties, functions, components general	
Product function Access Point Mode	No
Product function Client Mode	Yes
Product function	
• iPCF client	Yes
• iPCF-MC Access Point	No
• iPCF-MC client	Yes
Number of iPCF-capable radio modules	1
Product functions management, configuration	
Number of manageable IP addresses in client	4
Product function	
• CLI	Yes
• web-based management	Yes
• MIB support	Yes
• TRAPs via email	Yes
• Configuration with STEP 7	Yes
• configuration with STEP 7 in the TIA Portal	Yes
• WDS	No
Protocol is supported	
• Address Resolution Protocol (ARP)	Yes
• ICMP	Yes
• Telnet	Yes
• HTTP	Yes
• HTTPS	Yes
• TFTP	Yes
• DCP	Yes
• LLDP	No
Identification & maintenance function	
• I&M0 - device-specific information	Yes
• I&M1 – higher-level designation/location designation	Yes

Article number	6GK5722-1FC00-0AA0 6GK5722-1FC00-0AB0 ¹⁾
Product type designation	SCALANCE W722-1 RJ45
Product functions Diagnosis	
Product function	
• PROFINET IO diagnosis	Yes
• Link Check	No
• connection monitoring IP-Alive	No
• SysLog	Yes
Protocol is supported	
• SNMP v1	Yes
• SNMP v2	Yes
• SNMP v3	Yes
Product functions VLAN	
Product function	
• function VLAN with IWLAN	No
Product functions DHCP	
Product function	
• DHCP client	Yes
• in Client Mode DHCP server via LAN	Yes
• DHCP Option 82	Yes
Product functions Redundancy	
Protocol is supported	
• STP/RSTP	Yes
• MSTP	Yes
• RSTP	Yes
Product functions Security	
Product function	
• ACL - MAC-based	Yes
• Management security, ACL-IP based	Yes
• IEEE 802.1x (radius)	Yes
• NAT/NAPT	Yes
• access protection according to IEEE802.11i	Yes
• WPA/WPA2	Yes
• TKIP/AES	Yes
Protocol is supported	
• SSH	Yes
• RADIUS	Yes
Product functions Time	
Protocol is supported	
• NTP	Yes
• SNTP	Yes
• SIMATIC Time	Yes

1) Wireless approval in the USA

Technical specifications (continued)

Article number	6GK5722-1FC00-0AA0 6GK5722-1FC00-0AB0 ¹⁾
Product type designation	SCALANCE W722-1 RJ45
Standards, specifications, approvals	
Standard	
• for FM	FM 3611: Class I, Division 2, Groups A,B,C,D, T4 / Class 1, Zone 2, Group IIC, T4
• for hazardous zone	EN 60079-15:2005, EN 60079-0:2006, II 3 G Ex nA II T4 KEMA 07 ATEX 0145X
• for safety from CSA and UL Certificate of suitability	UL 60950-1 CSA C22.2 No. 60950-1
• EC declaration of conformity	Yes
• CE marking	Yes
• C-Tick	Yes
• CCC	No
• E1 approval	No
• Railway application in accordance with EN 50155	No
• NEMA TS2	No
• IEC 61375	No
• IEC 61850-3	No
• NEMA4X	No
• Power-over-Ethernet according IEEE802.3at for type 1 and IEEE802.3af	No
• Power-over-Ethernet according to IEEE802.3at for type 2	No

Article number	6GK5722-1FC00-0AA0 6GK5722-1FC00-0AB0 ¹⁾
Product type designation	SCALANCE W722-1 RJ45
Standard for wireless communication	
• IEEE 802.11a	Yes
• IEEE 802.11b	Yes
• IEEE 802.11e	Yes
• IEEE 802.11g	Yes
• IEEE 802.11h	Yes
• IEEE 802.11i	Yes
• IEEE 802.11n	Yes
Wireless approval	You will find the current list of countries at: www.siemens.com/wireless-approvals
Marine classification association	
• American Bureau of Shipping Europe Ltd. (ABS)	No
• Bureau Veritas (BV)	No
• DNV GL	No
• Lloyds Register of Shipping (LRS)	No
• Nippon Kaiji Kyokai (NK)	No
• Polski Rejestr Statkow (PRS)	No
• Royal Institution of Naval Architects (RINA)	No
Accessories	
accessories	24 V DC screw terminal included in scope of delivery

¹⁾ Wireless approval in the USA

Ordering data

Article No.

Article No.

SCALANCE W722 Client Modules

IWLAN Ethernet Client Modules with iFeatures support and built-in wireless interface; wireless networks IEEE 802.11a/b/g/h/n at 2.4/5 GHz up to 150 Mbps; WPA2/AES; IP20 degree of protection (0 °C to +55 °C); scope of delivery: Mounting hardware, 3-pin screw terminal for 24 V DC; manual on CD-ROM; German/English

SCALANCE W722-1 RJ45

For administration of the wireless connection with iFeatures from a connected device with Industrial Ethernet connection

- National approvals for operation outside the USA
- National approvals for operation within the USA ²⁾

6GK5722-1FC00-0AA0

6GK5722-1FC00-0AB0

Accessories**IE FC RJ45 Plug 180 2 x 2**

RJ45 plug connector for Industrial Ethernet with a rugged metal enclosure and integrated insulation displacement contacts for connecting Industrial Ethernet FC installation cables; with a 180° cable outlet; for network components and CPs/CPUs with Industrial Ethernet interface

- 1 pack = 1 unit
- 1 pack = 10 units
- 1 pack = 50 units

6GK1901-1BB10-2AA0

6GK1901-1BB10-2AB0

6GK1901-1BB10-2AE0

IE FC Standard Cable GP 2 x 2

6XV1840-2AH10

4-core, shielded TP installation cable for connection to IE FC outlet RJ45 plug / IE FC RJ45 plug; PROFINET-compliant; with UL approval; Sold by the meter max. quantity 1000 m minimum order quantity 20 m

IE FC Stripping Tool

6GK1901-1GA00

Preadjusted stripping tool for fast stripping of the Industrial Ethernet FC cables

Antennas and miscellaneous IWLAN accessories

See Catalog IK PI or Industry Mall

²⁾ Please note national approvals under <http://www.siemens.com/wireless-approvals>

I/O systems

SIMATIC ET 200 systems for the control cabinet
SIMATIC ET 200SP

I/O modules > Communication > SCALANCE W721 RJ45 for the control cabinet

Overview

- Low-cost Client Module, suitable for applications where the device is to be mounted in the control cabinet

Technical specifications

Article number	6GK5721-1FC00-0AA0 6GK5721-1FC00-0AB0 ¹⁾
Product type designation	SCALANCE W721-1 RJ45
Transmission rate	
• Transfer rate with WLAN maximum	150 Mbit/s
• Transfer rate for Industrial Ethernet	10 Mbit/s, 100 Mbit/s, 10 Mbit/s, 100 Mbit/s
Interfaces	
Number of electrical connections	
• for network components or terminal equipment	1
• for power supply	1
• for redundant voltage supply	0
Type of electrical connection	
• for network components or terminal equipment	RJ45 socket
• for power supply	3-pole screw terminal
design of the removable storage	
• C-PLUG	No
• KEY-PLUG	No
Interfaces wireless	
Number of radio cards permanently installed	1
Number of electrical connections for external antenna(s)	1
Type of electrical connection for external antenna(s)	R-SMA (socket)
Product feature external antenna can be mounted directly on device	Yes
Supply voltage, current consumption, power loss	
Type of voltage of the supply voltage	DC
Supply voltage 1	
• from terminal block	19.2 V
Supply voltage 2	
• from terminal block	28.8 V
Consumed current	
• at DC at 24 V typical	0.15 A
Power loss [W]	
• at DC at 24 V typical	3.6 W

Article number	6GK5721-1FC00-0AA0 6GK5721-1FC00-0AB0 ¹⁾
Product type designation	SCALANCE W721-1 RJ45
Permitted ambient conditions	
Ambient temperature	
• during operation	0 ... 55 °C
• during storage	-40 ... +85 °C
• during transport	-40 ... +85 °C
Relative humidity at 25 °C without condensation during operation maximum	95 %
Ambient condition for operation	When used under hazardous conditions (Zone 2), the SCALANCE W761-1 RJ45 or W72x-1 RJ45 product must be installed in an enclosure. To comply with EN 50021, this enclosure must meet the requirements of at least IP 54 in compliance with EN 60529.
Protection class IP	IP20
Design, dimensions and weight	
Width	50 mm
Height	114 mm
Depth	74 mm
Width of the enclosure without antenna	50 mm
Height of the enclosure without antenna	114 mm
Depth of the enclosure without antenna	74 mm
Net weight	0.13 kg
Mounting type	
• S7-300 rail mounting	No
• S7-1500 rail mounting	No
• 35 mm DIN rail mounting	Yes
• wall mounting	No

¹⁾ Wireless approval in the USA

Technical specifications (continued)

Article number	6GK5721-1FC00-0AA0 6GK5721-1FC00-0AB0 ¹⁾
Product type designation	SCALANCE W721-1 RJ45
Wireless frequencies	
Operating frequency	
• for WLAN in 2.4 GHz frequency band	2.41 ... 2.48 GHz
• for WLAN in 5 GHz frequency band	4.9 ... 5.8 GHz
Product properties, functions, components general	
Product function Access Point Mode	No
Product function Client Mode	Yes
Product function	
• iPCF client	No
• iPCF-MC client	No
Product functions management, configuration	
Number of manageable IP addresses in client	4
Product function	
• CLI	Yes
• web-based management	Yes
• MIB support	Yes
• TRAPs via email	Yes
• Configuration with STEP 7	Yes
• configuration with STEP 7 in the TIA Portal	Yes
• WDS	No
Protocol is supported	
• Address Resolution Protocol (ARP)	Yes
• ICMP	Yes
• Telnet	Yes
• HTTP	Yes
• HTTPS	Yes
• TFTP	Yes
• DCP	Yes
• LLDP	No
Identification & maintenance function	
• I&MO - device-specific information	Yes
• I&M1 – higher-level designation/ location designation	Yes
Product functions Diagnosis	
Product function	
• PROFINET IO diagnosis	No
• Link Check	No
• connection monitoring IP-Alive	No
• SysLog	Yes
Protocol is supported	
• SNMP v1	Yes
• SNMP v2	Yes
• SNMP v3	Yes
Product functions VLAN	
Product function	
• function VLAN with IWLAN	No

Article number	6GK5721-1FC00-0AA0 6GK5721-1FC00-0AB0 ¹⁾
Product type designation	SCALANCE W721-1 RJ45
Product functions DHCP	
Product function	
• DHCP client	Yes
• in Client Mode DHCP server via LAN	Yes
• DHCP Option 82	Yes
Product functions Redundancy	
Protocol is supported	
• STP/RSTP	Yes
• MSTP	Yes
• RSTP	Yes
Product functions Security	
Product function	
• ACL - MAC-based	Yes
• Management security, ACL-IP based	Yes
• IEEE 802.1x (radius)	Yes
• NAT/NAPT	No
• access protection according to IEEE802.11i	Yes
• WPA/WPA2	Yes
• TKIP/AES	Yes
Protocol is supported	
• SSH	Yes
• RADIUS	Yes
Product functions Time	
Protocol is supported	
• NTP	Yes
• SNTP	Yes
• SIMATIC Time	Yes
Standards, specifications, approvals	
Standard	
• for FM	FM 3611: Class I, Division 2, Groups A,B,C,D, T4 / Class 1, Zone 2, Group IIC, T4
• for hazardous zone	EN 60079-15:2005, EN 60079-0:2006, II 3 G Ex nA II T4 KEMA 07 ATEX 0145X
• for safety from CSA and UL	UL 60950-1 CSA C22.2 No. 60950-1
Certificate of suitability	
• EC declaration of conformity	Yes
• CE marking	Yes
• C-Tick	Yes
• CCC	No
• E1 approval	No
• Railway application in accordance with EN 50155	No
• NEMA TS2	No
• IEC 61375	No
• IEC 61850-3	No
• NEMA4X	No
• Power-over-Ethernet according IEEE802.3at for type 1 and IEEE802.3af	No
• Power-over-Ethernet according to IEEE802.3at for type 2	No

1) Wireless approval in the USA

I/O systemsSIMATIC ET 200 systems for the control cabinet
SIMATIC ET 200SP**I/O modules > Communication > SCALANCE W721 RJ45 for the control cabinet****Technical specifications** (continued)

Article number	6GK5721-1FC00-0AA0 6GK5721-1FC00-0AB0 ¹⁾
Product type designation	SCALANCE W721-1 RJ45
Standard for wireless communication	
• IEEE 802.11a	Yes
• IEEE 802.11b	Yes
• IEEE 802.11e	Yes
• IEEE 802.11g	Yes
• IEEE 802.11h	Yes
• IEEE 802.11i	Yes
• IEEE 802.11n	Yes
Wireless approval	You will find the current list of countries at: www.siemens.com/wireless-approvals

Article number	6GK5721-1FC00-0AA0 6GK5721-1FC00-0AB0 ¹⁾
Product type designation	SCALANCE W721-1 RJ45
Marine classification association	
• American Bureau of Shipping Europe Ltd. (ABS)	No
• Bureau Veritas (BV)	No
• DNV GL	No
• Lloyds Register of Shipping (LRS)	No
• Nippon Kaiji Kyokai (NK)	No
• Polski Rejestr Statkow (PRS)	No
• Royal Institution of Naval Architects (RINA)	No
Accessories	
accessories	24 V DC screw terminal included in scope of delivery

¹⁾ Wireless approval in the USA

Ordering data**Article No.****SCALANCE W721 Client Modules**

IWLAN Ethernet Client Modules with built-in wireless interface; wireless networks
IEEE 802.11a/b/g/h/n at 2.4/5 GHz up to 150 Mbps; WPA2/AES;
IP20 degree of protection (0 °C to +55 °C);
scope of delivery:
Mounting hardware,
3-pin screw terminal for 24 V DC;
manual on CD-ROM;
German/English

SCALANCE W721-1 RJ45

For administration of the wireless connection from a connected device with Industrial Ethernet connection

- National approvals for operation outside the USA
- National approvals for operation within the USA ²⁾

6GK5721-1FC00-0AA0**6GK5721-1FC00-0AB0****Article No.****Accessories****IE FC RJ45 Plug 180 2 x 2**

RJ45 plug connector for Industrial Ethernet with a rugged metal enclosure and integrated insulation displacement contacts for connecting Industrial Ethernet FC installation cables; with a 180° cable outlet; for network components and CPs/CPUs with Industrial Ethernet interface

- 1 pack = 1 unit
- 1 pack = 10 units
- 1 pack = 50 units

6GK1901-1BB10-2AA0**6GK1901-1BB10-2AB0****6GK1901-1BB10-2AE0****IE FC Standard Cable GP 2 x 2****6XV1840-2AH10**

4-core, shielded TP installation cable for connection to IE FC outlet RJ45 plug / IE FC RJ45 plug;
PROFINET-compliant;
with UL approval;
sold by the meter;
max. quantity 1000 m,
minimum order quantity 20 m

IE FC Stripping Tool**6GK1901-1GA00**

Preadjusted stripping tool for fast stripping of the Industrial Ethernet FC cables

Antennas and miscellaneous IWLAN accessories

See Catalog IK PI or Industry Mall

²⁾ Please note national approvals under <http://www.siemens.com/wireless-approvals>

Overview



- PROFIBUS DP master/slave with electrical interface for connecting the ET 200SP CPUs to PROFIBUS at up to 12 Mbps
- Expands the ET 200SP CPUs 1510SP-1 PN / 1512SP-1 PN by one PROFIBUS connection
- For communication with lower-level PROFIBUS devices at bandwidths of 9.6 Kbps to 12 Mbps
- Communication services:
 - PROFIBUS DP
 - PG/OP communication
 - S7 communication:
This makes it possible to establish communication between the ET 200SP CPU and other devices, for example those from the SIMATIC S7-300/400/1500 range.
- Time synchronization
- Simple programming and configuration over PROFIBUS
- Cross-network PG communication using S7 routing
- Data set routing

Note

SIPLUS extreme products are based on SIMATIC standard products. The contents listed here were taken from the respective standard products. SIPLUS extreme-specific information was added.

Technical specifications

Article number	6AG1545-5DA00-2AB0
Based on	6ES7545-5DA00-0AB0 SIPLUS ET 200SP CM DP
Ambient conditions	
Ambient temperature during operation	
• horizontal installation, min.	-40 °C; = Tmin; Startup @ -25 °C
• horizontal installation, max.	60 °C; = Tmax
• vertical installation, min.	-40 °C; = Tmin; Startup @ -25 °C
• vertical installation, max.	50 °C; = Tmax
Extended ambient conditions	
• relative to ambient temperature-atmospheric pressure-installation altitude	Tmin ... Tmax at 1080 hPa ... 795 hPa (-1000 m ... +2000 m) // Tmin ... (Tmax - 10K) at 795 hPa ... 658 hPa (+2000 m ... +3500 m) // Tmin ... (Tmax - 20K) at 658 hPa ... 540 hPa (+3500 m ... +5000 m)
Relative humidity	
- With condensation, tested in accordance with IEC 60068-2-38, max.	100 %; RH incl. condensation/frost (no commissioning under condensation conditions)
Resistance	
- against biologically active substances / conformity with EN 60721-3-3	Yes; Class 3B2 mold, fungus and dry rot spores (with the exception of fauna). The supplied connector covers must remain on the unused interfaces during operation!
- against chemically active substances / conformity with EN 60721-3-3	Yes; Class 3C4 (RH < 75%) incl. salt spray according to EN 60068-2-52 (degree of severity 3). The supplied connector covers must remain on the unused interfaces during operation!
- against mechanically active substances / conformity with EN 60721-3-3	Yes; Class 3S4 incl. sand, dust. The supplied connector covers must remain on the unused interfaces during operation!

Ordering data

Article No.

SIPLUS CM DP for ET 200SP CPU (Extended temperature range and exposure to media) PROFIBUS DP master/slave with electrical interface for connecting the ET 200SP CPUs to PROFIBUS at up to 12 Mbps	6AG1545-5DA00-2AB0
Accessories	see SIMATIC CM DP, page 9/93

I/O systems

SIMATIC ET 200 systems for the control cabinet
SIMATIC ET 200SP

Fail-safe I/O modules > Digital F input modules**Overview**

Digital fail-safe input module:
F-DI 8x24 V DC High Feature for BU type A0, color code CC01

Other properties:

- 8-channel digital fail-safe input module for the ET 200SP
- For fail-safe reading of sensor information (1 or 2 channels)
- Provides integral discrepancy evaluation for 2-out-of-2 signals
- 8 internal sensor supplies (incl. test function) onboard
- Certified up to SIL 3 (IEC 61508), PL e (ISO 13849)
- Can be plugged onto type A0 BaseUnits (BU) with automatic coding
- LED display for error, operation, supply voltage and status
- Clear labeling on front of module
 - Plain text identification of the module type and function class
 - 2D matrix code (order and serial number)
 - Connection diagram
 - Color coding of the DI module type: white
 - Hardware and firmware version
 - Color code (CC) for module-specific color coding of the potentials at the terminals of the BU
 - Complete Article No.
- Optional labeling accessories
 - Labeling strips
 - Reference identification label
- Optional module-specific color identification of the terminals according to the color code (CC)
- Optional system-integrated shield connection
- The modules support PROFIsafe in both PROFIBUS and PROFINET configurations. They can be used with all fail-safe SIMATIC S7 CPUs

Technical specifications

Article number	6ES7136-6BA00-0CA0 ET 200SP, EL-MOD., F-DI 8X24VDC HF
General information	
Product type designation	F-DI 8x24VDC HF
Product function	
• I&M data	Yes; I&M0 to I&M3
Engineering with	
• STEP 7 TIA Portal configurable/ integrated as of version	V12
• STEP 7 configurable/integrated as of version	V5.5 SP3 / -
Supply voltage	
Type of supply voltage	24 V DC
Rated value (DC)	24 V
Reverse polarity protection	Yes
Encoder supply	
Number of outputs	8
Short-circuit protection	Yes; Electronic (response threshold 0.7 A to 1.8 A)
Output current	
• up to 60 °C, max.	0.3 A
24 V encoder supply	
• 24 V	Yes; min. L+ (-1.5 V)
• Short-circuit protection	Yes
• Output current, max.	800 mA; Total current of all encoders

Article number	6ES7136-6BA00-0CA0 ET 200SP, EL-MOD., F-DI 8X24VDC HF
Digital inputs	
Number of digital inputs	8
Source/sink input	Yes; P-reading
Input characteristic curve in accordance with IEC 61131, type 1	Yes
Input voltage	
• Type of input voltage	DC
• Rated value (DC)	24 V
• for signal "0"	-30 to +5V
• for signal "1"	+15 to +30V
Input current	
• for signal "1", typ.	3.7 mA
Input delay (for rated value of input voltage) for standard inputs	
- parameterizable	Yes
for counter/technological functions	
- parameterizable	No
Cable length	
• shielded, max.	1 000 m
• unshielded, max.	500 m

Technical specifications (continued)

Article number	6ES7136-6BA00-0CA0 ET 200SP, EL-MOD., F-DI 8X24VDC HF
Interrupts/diagnostics/ status information	
Diagnostics function	Yes, "Alarms/diagnostic messages" section in the manual
Alarms	
• Diagnostic alarm	Yes
• Hardware interrupt	No
Diagnostics indication LED	
• RUN LED	Yes; Green LED
• ERROR LED	Yes; Red LED
• Monitoring of the supply voltage (PWR-LED)	Yes; green PWR LED
• Channel status display	Yes; Green LED
• for channel diagnostics	Yes; Red LED
• for module diagnostics	Yes; green/red DIAG LED
Potential separation	
Potential separation channels	
• between the channels and backplane bus	Yes
Isolation	
Isolation tested with	707 V DC (type test)

Article number	6ES7136-6BA00-0CA0 ET 200SP, EL-MOD., F-DI 8X24VDC HF
Standards, approvals, certificates	
Suitable for safety functions	Yes
Highest safety class achievable in safety mode	
• Performance level according to ISO 13849-1	PLe
• SIL acc. to IEC 61508	SIL 3
Probability of failure (for service life of 20 years and repair time of 100 hours)	
- Low demand mode: PFDavg in accordance with SIL3	< 2.00E-05 1/h
- High demand/continuous mode: PFH in accordance with SIL3	< 1.00E-09 1/h
Ambient conditions	
Ambient temperature during operation	
• horizontal installation, min.	0 °C
• horizontal installation, max.	60 °C
• vertical installation, min.	0 °C
• vertical installation, max.	50 °C
Dimensions	
Width	15 mm
Weights	
Weight, approx.	49 g

Ordering data**Digital F input modules**F-DI 8x24 V DC High Feature,
BU type A0, color code CC01**Article No.****6ES7136-6BA00-0CA0****Usable BaseUnits****BU15-P16+A0+2D**BU type A0; BaseUnit (light) with
16 process terminals to the module;
for starting a new load group
(max. 10 A)

- 1 unit
- 10 units

6ES7193-6BP00-0DA0
6ES7193-6BP00-2DA0**BU15-P16+A0+2B**BU type A0; BaseUnit (dark) with
16 process terminals to the module;
for continuing the load group

- 1 unit
- 10 units

6ES7193-6BP00-0BA0
6ES7193-6BP00-2BA0**BU15-P16+A10+2D**BU type A0; BaseUnit (light) with
16 process terminals (1...16) to the
module and an additional 10 inter-
nally jumpered AUX terminals
(1 A to 10 A); for starting a new
load group (max. 10 A)

- 1 unit
- 10 units

6ES7193-6BP20-0DA0
6ES7193-6BP20-2DA0**Article No.****BU15-P16+A10+2B**BU type A0; BaseUnit (dark) with
16 process terminals (1...16) to the
module and an additional 10 inter-
nally jumpered AUX terminals
(1 A to 10 A); for continuing the
load group

- 1 unit
- 10 units

6ES7193-6BP20-0BA0
6ES7193-6BP20-2BA0**Accessories****S7 Distributed Safety
programming tool V5.4**

Task:
Engineering tool for configuring
fail-safe user programs for
SIMATIC S7-300F, S7-400F,
WinAC RTX F, ET 200S, ET 200M,
ET 200iSP, ET 200pro, ET 200eco

Requirement:
STEP 7 V5.3 SP3 and higher

Floating license for 1 user

6ES7833-1FC02-0YA5Floating license for 1 user,
license key download without
software or documentation¹⁾;
email address required for delivery**6ES7833-1FC02-0YH5**

I/O systemsSIMATIC ET 200 systems for the control cabinet
SIMATIC ET 200SP**Fail-safe I/O modules > Digital F input modules****Ordering data****Article No.****STEP 7 Safety Advanced V14 SP1****Task:**

Engineering tool for configuring and programming fail-safe user programs for SIMATIC S7-1200 FC, S7-1500F, S7-1500F Software Controller, S7-300F, S7-400F, WinAC RTX F, ET 200SP F Controller and the fail-safe ET 200SP, ET 200S, ET 200M, ET 200iSP, ET 200pro and ET 200eco I/O

Requirement:

STEP 7 Professional V14 SP1

Floating license for 1 user, software and documentation on DVD; license key on USB flash drive

Floating license for 1 user, software, documentation and license key for download¹⁾; email address required for delivery

6ES7833-1FA14-0YA5**6ES7833-1FA14-0YH5****Reference identification label****6ES7193-6LF30-0AW0**

10 sheets of 16 labels

Labeling strips

500 labeling strips on roll, light gray, for inscription with thermal transfer roll printer

6ES7193-6LR10-0AA0

500 labeling strips on roll, yellow, for inscription with thermal transfer roll printer

6ES7193-6LR10-0AG0

1000 labeling strips DIN A4, light gray, card, for inscription with laser printer

6ES7193-6LA10-0AA0

1000 labeling strips DIN A4, yellow, card, for inscription with laser printer

6ES7193-6LA10-0AG0**Article No.****BU cover**

for covering empty slots (gaps); 5 units

- 15 mm wide
- 20 mm wide

6ES7133-6CV15-1AM0**6ES7133-6CV20-1AM0****Shield connection****6ES7193-6SC00-1AM0**

5 shield supports and 5 shield terminals

Color-coding plates

- Color code CC01, module-specific, for 16 push-in terminals; for BaseUnit type A0, A1; 10 units
- Color code CC71, for 10 AUX terminals 1 A to 10 A, for BU type A0, yellow/green, with push-in terminals; 10 units
- Color code CC72, for 10 AUX terminals 1 A to 10 A, for BU type A0, red, with push-in terminals; 10 units
- Color code CC73, for 10 AUX terminals 1 A to 10 A, for BU type A0, blue, with push-in terminals; 10 units

6ES7193-6CP01-2MA0**6ES7193-6CP71-2AA0****6ES7193-6CP72-2AA0****6ES7193-6CP73-2AA0****E-coding element type F****6ES7193-6EF00-1AA0**

5 units, spare part

¹⁾ For up-to-date information and download availability, see: <http://www.siemens.com/tia-online-software-delivery>

Overview



Digital fail-safe output module:
F-DQ 4x24 V DC High Feature, BU type A0, color code CC01

Other properties:

- 4-channel digital fail-safe output module for the ET 200SP
- Fail-safe 2-channel activation (sink/source output) by actuators
- Actuators can be controlled up to 2 A
- Certified up to SIL 3 (IEC 61508), PL e (ISO 13849)

- Can be plugged onto type A0 BaseUnits (BU) with automatic coding
- LED display for error, operation, supply voltage and status
- Clear labeling on front of module
 - Plain text identification of the module type and function class
 - 2D matrix code (order and serial number)
 - Connection diagram
 - Color coding of the DI module type: white
 - Hardware and firmware version
 - Color code (CC) for module-specific color coding of the potentials at the terminals of the BU
 - Complete Article No.
- Optional labeling accessories
 - Labeling strips
 - Reference identification label
- Optional module-specific color identification of the terminals according to the color code (CC)
- Optional system-integrated shield connection
- The modules support PROFIsafe, both in PROFIBUS, and in PROFINET configurations
- They can be used with all fail-safe SIMATIC S7 CPUs

Technical specifications

Article number	6ES7136-6DB00-0CA0 ET 200SP, EL-MOD., F-DQ 4XDC 24V/2A
General information	
Product type designation	F-DQ 4x 24 V DC/2 A PM HF
Product function	
• I&M data	Yes; I&M0 to I&M3
Engineering with	
• STEP 7 TIA Portal configurable/ integrated as of version	V12
• STEP 7 configurable/integrated as of version	V5.5 SP3 / -
• PROFINET as of GSD version/ GSD revision	V2.31
Supply voltage	
Type of supply voltage	24 V DC
Rated value (DC)	24 V
Reverse polarity protection	Yes
Digital outputs	
Number of digital outputs	4
Digital outputs, parameterizable	Yes
Short-circuit protection	Yes
Open-circuit detection	Yes
Overload protection	Yes
Limitation of inductive shutdown voltage to	typ. 2*47V

Article number	6ES7136-6DB00-0CA0 ET 200SP, EL-MOD., F-DQ 4XDC 24V/2A
Switching capacity of the outputs	
• with resistive load, max.	2 A
• on lamp load, max.	10 W
Load resistance range	
• lower limit	12 Ω
• upper limit	2 000 Ω
Output voltage	
• Type of output voltage	DC
• for signal "1", min.	24 V; L+ (-0.5 V)
Output current	
• for signal "1" rated value	2 A
• for signal "0" residual current, max.	0.5 mA
Switching frequency	
• with resistive load, max.	30 Hz; Symmetrical
• with inductive load, max.	0.1 Hz; according to IEC 60947-5-1, DC-13, symmetrical
• on lamp load, max.	10 Hz; Symmetrical
Total current of the outputs	
• Current per channel, max.	2 A; Note derating data in the manual
• Current per module, max.	6 A; Note derating data in the manual
Cable length	
• shielded, max.	1 000 m
• unshielded, max.	500 m

I/O systemsSIMATIC ET 200 systems for the control cabinet
SIMATIC ET 200SP**Fail-safe I/O modules > Digital F output modules****Technical specifications** (continued)

Article number	6ES7136-6DB00-0CA0 ET 200SP, EL-MOD., F-DQ 4XDC 24V/2A
Interrupts/diagnostics/ status information	
Diagnostics function	Yes; "Alarms/diagnostic messages" section in the manual
Substitute values connectable	No
Alarms	
• Diagnostic alarm	Yes
Diagnostics indication LED	
• RUN LED	Yes; Green LED
• ERROR LED	Yes; Red LED
• Monitoring of the supply voltage (PWR-LED)	Yes; green PWR LED
• Channel status display	Yes; Green LED
• for channel diagnostics	Yes; Red LED
• for module diagnostics	Yes; green/red DIAG LED
Potential separation	
Potential separation channels	
• between the channels and backplane bus	Yes
Isolation	
Isolation tested with	707 V DC (type test)

Article number	6ES7136-6DB00-0CA0 ET 200SP, EL-MOD., F-DQ 4XDC 24V/2A
Standards, approvals, certificates	
Suitable for safety functions	Yes
Highest safety class achievable in safety mode	
• Performance level according to ISO 13849-1	PLe
• SIL acc. to IEC 61508	SIL 3
Probability of failure (for service life of 20 years and repair time of 100 hours)	
- Low demand mode: PFDavg in accordance with SIL3	< 2.00E-05 1/h
- High demand/continuous mode: PFH in accordance with SIL3	< 1.00E-09 1/h
Ambient conditions	
Ambient temperature during operation	
• horizontal installation, min.	0 °C
• horizontal installation, max.	60 °C
• vertical installation, min.	0 °C
• vertical installation, max.	50 °C
Dimensions	
Width	15 mm
Weights	
Weight, approx.	57 g

Ordering data**Article No.**

Digital F output modules	
F-DQ 4x24 V DC High Feature, BU type A0, color code CC01	6ES7136-6DB00-0CA0
Usable BaseUnits	
BU15-P16+A0+2D	
BU type A0; BaseUnit (light) with 16 process terminals to the module; for starting a new load group (max. 10 A)	
• 1 unit	6ES7193-6BP00-0DA0
• 10 units	6ES7193-6BP00-2DA0
BU15-P16+A0+2B	
BU type A0; BaseUnit (dark) with 16 process terminals to the module; for continuing the load group	
• 1 unit	6ES7193-6BP00-0BA0
• 10 units	6ES7193-6BP00-2BA0
BU15-P16+A10+2D	
BU type A0; BaseUnit (light) with 16 process terminals (1...16) to the module and an additional 10 inter- nally jumpered AUX terminals (1 A to 10 A); for starting a new load group (max. 10 A)	
• 1 unit	6ES7193-6BP20-0DA0
• 10 units	6ES7193-6BP20-2DA0
BU15-P16+A10+2B	
BU type A0; BaseUnit (dark) with 16 process terminals (1...16) to the module and an additional 10 inter- nally jumpered AUX terminals (1 A to 10 A); for continuing the load group	
• 1 unit	6ES7193-6BP20-0BA0
• 10 units	6ES7193-6BP20-2BA0

Article No.

BU20-P12+A4+0B	6ES7193-6BP20-0BB0
BU type B0; BaseUnit (dark) with 12 process terminals (1...12) to the module and an additional 4 inter- nally jumpered AUX terminals (1 A to 4 A); for continuing the load group	
Accessories	
S7 Distributed Safety programming tool V5.4	
Task: Engineering tool for configuring fail-safe user programs for SIMATIC S7-300F, S7-400F, WinAC RTX F, ET 200S, ET 200M, ET 200iSP, ET 200pro, ET 200eco	
Requirement: STEP 7 V5.3 SP3 and higher	
Floating license for 1 user	6ES7833-1FC02-0YA5
Floating license for 1 user, license key download without software or documentation ¹⁾ ; email address required for delivery	6ES7833-1FC02-0YH5

Ordering data	Article No.	Article No.
STEP 7 Safety Advanced V14 SP1 Task: Engineering tool for configuring and programming fail-safe user programs for SIMATIC S7-1200 FC, S7-1500F, S7-1500F Software Controller, S7-300F, S7-400F, WinAC RTX F, ET 200SP F Controller and the fail-safe ET 200SP, ET 200S, ET 200M, ET 200iSP, ET 200pro and ET 200eco I/O Requirement: STEP 7 Professional V14 SP1 Floating license for 1 user, software and documentation on DVD; license key on USB flash drive Floating license for 1 user, software, documentation and license key for download ¹⁾ ; email address required for delivery	6ES7833-1FA14-0YA5 6ES7833-1FA14-0YH5	BU cover for covering empty slots (gaps); 5 units <ul style="list-style-type: none"> • 15 mm wide 6ES7133-6CV15-1AM0 • 20 mm wide 6ES7133-6CV20-1AM0 Shield connection 6ES7193-6SC00-1AM0 5 shield supports and 5 shield terminals
Reference identification label 10 sheets of 16 labels	6ES7193-6LF30-0AW0	Color-coding plates <ul style="list-style-type: none"> • Color code CC02, module-specific, for 16 push-in terminals; for BaseUnit type A0, A1; 10 units 6ES7193-6CP02-2MA0 • Color code CC71, for 10 AUX terminals 1 A to 10 A, for BU type A0, yellow/green, with push-in terminals; 10 units 6ES7193-6CP71-2AA0 • Color code CC72, for 10 AUX terminals 1 A to 10 A, for BU type A0, red, with push-in terminals; 10 units 6ES7193-6CP72-2AA0 • Color code CC73, for 10 AUX terminals 1 A to 10 A, for BU type A0, blue, with push-in terminals; 10 units 6ES7193-6CP73-2AA0
Labeling strips 500 labeling strips on roll, light gray, for inscription with thermal transfer roll printer 6ES7193-6LR10-0AA0 500 labeling strips on roll, yellow, for inscription with thermal transfer roll printer 6ES7193-6LR10-0AG0 1000 labeling strips DIN A4, light gray, card, for inscription with laser printer 6ES7193-6LA10-0AA0 1000 labeling strips DIN A4, yellow, card, for inscription with laser printer 6ES7193-6LA10-0AG0		E-coding element type F 6ES7193-6EF00-1AA0 5 units, spare part

¹⁾ For up-to-date information and download availability, see: <http://www.siemens.com/tia-online-software-delivery>

I/O systems

SIMATIC ET 200 systems for the control cabinet
SIMATIC ET 200SP

Fail-safe I/O modules > Digital F output module relay

Overview

The digital F electronic module relay 1 F-RQ 24 V DC/24...230 V AC/5 A has the following characteristics:

- 1 relay output (2 NO contacts)
- Total output current 5 A
- Rated load voltage 24 V DC and 24...230 V AC
- The control circuit of the two safety relays must be routed from the outside to the respective terminals

The attainable safety integrity level is SIL 3 (IEC 61508) when the control of the F-RQ module is implemented via a fail-safe output (e.g. ET 200SP 4F-DQ 24 V DC/2 A PROFIsafe).

Technical specifications

Article number	6ES7136-6RA00-0BF0 ET 200SP, F-RQ 1X24VDC/ 24...230VAC/5A ST
General information	
Product type designation	F-RQ 1x24VDC/24 ... 230VAC/5A
Product function	
• I&M data	Yes; I&M0 to I&M3
Engineering with	
• STEP 7 TIA Portal configurable/ integrated as of version	V13
• STEP 7 configurable/integrated as of version	V5.5 SP4 and higher
Supply voltage	
Type of supply voltage	24 V DC
Rated value (DC)	24 V; Coil voltage
Digital outputs	
Number of digital outputs	1
Limitation of inductive shutdown voltage to	No
Controlling a digital input	Yes
Switching capacity of the outputs	
• with resistive load, max.	5 A
• on lamp load, max.	25 W
Switching frequency	
• with resistive load, max.	2 Hz
• with inductive load, max.	0.1 Hz; See data in manual
• with inductive load (acc. to IEC 60947-5-1, DC13), max.	0.1 Hz
• with inductive load (acc. to IEC 60947-5-1, AC15), max.	2 Hz
Total current of the outputs (per module)	
horizontal installation	
- up to 40 °C, max.	5 A; Note derating data in the manual
- up to 50 °C, max.	4 A; Note derating data in the manual
- up to 60 °C, max.	3 A; Note derating data in the manual
vertical installation	
- up to 50 °C, max.	3 A; Note derating data in the manual
Relay outputs	
• Number of relay outputs	1; 2 NO contacts
• Rated supply voltage of relay coil L+ (DC)	24 V
• Current consumption of relays (coil current of all relays), max.	70 mA
• external protection for relay outputs	yes; 6 A, see data in manual
• Relay approved acc. to UL 508	Yes; Pilot Duty B300, R300

Article number	6ES7136-6RA00-0BF0 ET 200SP, F-RQ 1X24VDC/ 24...230VAC/5A ST
Switching capacity of contacts	
- with inductive load, max.	see additional description in the manual
- with resistive load, max.	see additional description in the manual
- Thermal continuous current, max.	5 A
- Switching current, min.	1 mA
- Switching current after exceeding 300 mA, min.	10 mA
- Switching current after exceeding 300 mA, max.	5 A
- Rated switching voltage (DC)	24 V
- Rated switching voltage (AC)	230 V
Cable length	
• shielded, max.	500 m; for load contacts
• unshielded, max.	300 m; for load contacts
• Control cable (input), max.	10 m
Interrupts/diagnostics/ status information	
Diagnostics function	yes, firmware update
Diagnostics indication LED	
• RUN LED	Yes; green/red DIAG LED
• Channel status display	Yes; Green LED
Potential separation	
Potential separation channels	
• between the channels and backplane bus	Yes
Isolation	
Isolation tested with	2 545 V DC/2 s (routine test)
Overvoltage category	III
tested with	
• between channels and backplane bus/supply voltage	DC 2545 V 2 s (routine test), impulse voltage test DC 7200 V / 5 positive and 5 negative pulses (type test)
• between backplane bus and supply voltage	707 V DC (type test)
Standards, approvals, certificates	
Suitable for safety functions	Yes
Highest safety class achievable in safety mode	
• Performance level according to ISO 13849-1	PLe
• Category according to ISO 13849-1	4
• SIL acc. to IEC 61508	SIL 3

Technical specifications (continued)

Article number	6ES7136-6RA00-0BF0 ET 200SP, F-RQ 1X24VDC/ 24..230VAC/5A ST
Probability of failure (for service life of 20 years and repair time of 100 hours)	
- Low demand mode: PFDavg in accordance with SIL2	< 1.00E-04, function test 1x per year
- Low demand mode: PFDavg in accordance with SIL3	< 1.00E-05, function test 1x per month
- High demand/continuous mode: PFH in accordance with SIL2	< 1.00E-08 1/h, function test 1x per year
- High demand/continuous mode: PFH in accordance with SIL3	< 6.00E-09 1/h, function test 1x per month

Article number	6ES7136-6RA00-0BF0 ET 200SP, F-RQ 1X24VDC/ 24..230VAC/5A ST
Dimensions	
Width	20 mm
Weights	
Weight, approx.	56 g

Ordering data**Digital F output module
relay 1 F-RQ**

BU type F0, relay output
(2 NO contacts), total output current
5 A, load voltages 24 V DC and
24..230 V AC; can be used
up to SIL3/Cat.4/PLe if controlled
via F-DQ

6ES7136-6RA00-0BF0**Usable BaseUnits****BU20-P8+A4+0B**

BU type F0; BaseUnit (dark) with
8 process terminals to the module
and an additional 4 internally jum-
pered AUX terminals (1 A to 4 A);
for continuing the load group

6ES7193-6BP20-0BF0**Accessories****S7 Distributed Safety
programming tool V5.4**

Task:
Engineering tool for configuring
fail-safe user programs for
SIMATIC S7-300F, S7-400F,
WinAC RTX F, ET 200S, ET 200M,
ET 200iSP, ET 200pro, ET 200eco
Requirement:
STEP 7 V5.3 SP3 and higher

Floating license for 1 user

6ES7833-1FC02-0YA5

Floating license for 1 user,
license key download without
software or documentation¹⁾;
email address required for delivery

6ES7833-1FC02-0YH5**STEP 7 Safety Advanced V14 SP1**

Task:

Engineering tool for configuring
and programming fail-safe user
programs for SIMATIC S7-1200 FC,
S7-1500F, S7-1500F Software
Controller, S7-300F, S7-400F,
WinAC RTX F, ET 200SP F Controller
and the fail-safe ET 200SP,
ET 200S, ET 200M, ET 200iSP,
ET 200pro and ET 200eco I/O

Requirement:

STEP 7 Professional V14 SP1

Floating license for 1 user,
software and documentation on
DVD; license key on USB flash drive

6ES7833-1FA14-0YA5

Floating license for 1 user,
software, documentation and
license key for download¹⁾;
email address required for delivery

6ES7833-1FA14-0YH5**Reference identification label****6ES7193-6LF30-0AW0**

10 sheets of 16 labels

Labeling strips

500 labeling strips on roll, light gray

6ES7193-6LR10-0AA0

500 labeling strips on roll, yellow

6ES7193-6LR10-0AG0

1000 labeling strips DIN A4,
light gray

6ES7193-6LA10-0AA0

1000 labeling strips DIN A4, yellow

6ES7193-6LA10-0AG0**BU cover****6ES7133-6CV15-1AM0**

for covering empty slots (gaps);
5 units

- 20 mm wide

Shield connection**6ES7193-6SC00-1AM0**

5 shield supports and
5 shield terminals

Color-coded labels

- Color code CC42,
module-specific;
for BaseUnit type F0; 10 units

6ES7193-6CP42-2MB0

¹⁾ For up-to-date information and download availability see:
<http://www.siemens.com/tia-online-software-delivery>

I/O systems

SIMATIC ET 200 systems for the control cabinet
SIMATIC ET 200SP

Fail-safe I/O modules > Fail-safe special modules

Overview



Digital fail-safe power module:
F-PM-E PPM 24 V DC/8 A for BU type C0, color code
CC52

Other properties:

- Certified up to SIL 3 (IEC 61508), PL e (ISO 13849)
- Safety-related shutdown of output modules within the potential group of the F-PM-E
- Two fail-safe digital inputs, for reading of sensor information (1 or 2 channels)
- One fail-safe digital output onboard (ppm switching, up to 2 A, up to SIL 3/PL e)

- Fail-safe digital output and potential supply pp or pm switching can be parameterized
- Parameterizable onboard evaluation of the fail-safe inputs for control of the fail-safe digital outputs and of the potential group
- Digital standard output modules can be shut down up to PL d (ISO 13849) and SIL 2 (IEC 61508) (up to 8 A)
- Can be plugged onto type C0 BaseUnits (BU) with automatic coding
- LED display for error, operation, supply voltage and status
- Clear labeling on front of module
 - Plain text identification of the module type and function class
 - 2D matrix code (order and serial number)
 - Connection diagram
 - Color coding of the DI module type: white
 - Hardware and firmware version
 - Color code (CC) for module-specific color coding of the potentials at the terminals of the BU
 - Complete Article No.
- Optional labeling accessories
 - Labeling strips
 - Reference identification label
- Optional module-specific color identification of the terminals according to the color code (CC)
- Optional system-integrated shield connection
- The modules support PROFIsafe in both PROFIBUS and PROFINET configurations. They can be used with all fail-safe SIMATIC S7 CPUs

Technical specifications

Article number	6ES7136-6PA00-0BC0 ET 200SP, POWERMOD. F-PM-E PPM, DC24V
General information	
Product type designation	F-PM-E PPM 24VDC
Product function	
• I&M data	Yes; I&M0 to I&M3
Engineering with	
• STEP 7 TIA Portal configurable/integrated as of version	V12
• STEP 7 configurable/integrated as of version	V5.5 SP3 / -
• PROFIBUS as of GSD version/GSD revision	V2.3
• PROFINET as of GSD version/GSD revision	V2.31
Supply voltage	
Type of supply voltage	24 V DC
Rated value (DC)	24 V
Reverse polarity protection	Yes
Output voltage	
Type of output voltage	DC
Encoder supply	
Number of outputs	2
Short-circuit protection	Yes; Electronic (response threshold 0.7 A to 2.1 A)
Output current	
• up to 60 °C, max.	0.3 A
24 V encoder supply	
• 24 V	Yes; min. L+ (-1.5 V)
• Short-circuit protection	Yes
• Output current, max.	600 mA; Total current of all encoders

Article number	6ES7136-6PA00-0BC0 ET 200SP, POWERMOD. F-PM-E PPM, DC24V
Digital inputs	
Number of digital inputs	2
Source/sink input	Yes; P-reading
Input characteristic curve in accordance with IEC 61131, type 1	Yes
Input voltage	
• Type of input voltage	DC
• Rated value (DC)	24 V
• for signal "0"	-30 to +5V
• for signal "1"	+15 to +30V
Input current	
• for signal "1", typ.	3.7 mA
Input delay (for rated value of input voltage) for standard inputs	
- parameterizable	Yes
for counter/technological functions	
- parameterizable	No
Cable length	
• shielded, max.	1 000 m
• unshielded, max.	500 m
Digital outputs	
Number of digital outputs	1
Digital outputs, parameterizable	Yes
Short-circuit protection	Yes
Open-circuit detection	Yes
Overload protection	Yes
Limitation of inductive shutdown voltage to	max. 1.5 V

Technical specifications (continued)

Article number	6ES7136-6PA00-0BC0 ET 200SP, POWERMOD. F-PM-E PPM, DC24V
Switching capacity of the outputs	
• with resistive load, max.	8 A
• on lamp load, max.	100 W
Load resistance range	
• lower limit	3 Ω
• upper limit	2 000 Ω
Output voltage	
• for signal "1", min.	24 V; L+ (-0.5 V)
Output current	
• for signal "1" rated value	8 A
• for signal "0" residual current, max.	1.5 mA; PP-switching: max. 1.5 mA; PM-switching: max. 1 mA
Switching frequency	
• with resistive load, max.	10 Hz; Symmetrical
• with inductive load, max.	0.1 Hz; according to IEC 60947-5-1, DC-13, symmetrical
• on lamp load, max.	4 Hz; Symmetrical
Total current of the outputs	
• Current per channel, max.	8 A; Note derating data in the manual
• Current per module, max.	8 A; Note derating data in the manual
Cable length	
• shielded, max.	1 000 m
• unshielded, max.	500 m
Interrupts/diagnostics/ status information	
Diagnostics function	Yes, "Alarms/diagnostic messages" section in the manual
Substitute values connectable	No
Alarms	
• Diagnostic alarm	Yes
• Hardware interrupt	No

Article number	6ES7136-6PA00-0BC0 ET 200SP, POWERMOD. F-PM-E PPM, DC24V
Diagnostics indication LED	
• RUN LED	Yes; Green LED
• ERROR LED	Yes; Red LED
• Monitoring of the supply voltage (PWR-LED)	Yes; green PWR LED
• Channel status display	Yes; Green LED
• for channel diagnostics	Yes; Red LED
• for module diagnostics	Yes; green/red DIAG LED
Potential separation	
Potential separation channels	
• between the channels and backplane bus	Yes
Isolation	
Isolation tested with	707 V DC (type test)
Standards, approvals, certificates	
Suitable for safety functions	Yes
Highest safety class achievable in safety mode	
• Performance level according to ISO 13849-1	PLe
• SIL acc. to IEC 61508	SIL 3
Probability of failure (for service life of 20 years and repair time of 100 hours)	
- Low demand mode: PFDavg in accordance with SIL3	< 2.00E-05 1/h
- High demand/continuous mode: PFH in accordance with SIL3	< 1.00E-09 1/h
Ambient conditions	
Ambient temperature during operation	
• horizontal installation, min.	0 °C
• horizontal installation, max.	60 °C
• vertical installation, min.	0 °C
• vertical installation, max.	50 °C
Dimensions	
Width	20 mm
Height	72 mm
Depth	55 mm
Weights	
Weight, approx.	70 g

Ordering data

Ordering data	Article No.
Digital F power module F-PM-E 24 V DC/8 A PPM Standard	6ES7136-6PA00-0BC0
BU type C0, color code CC52. 2 inputs, 1 output, SIL3/Cat.4/PLe	
Type C0 BaseUnits	
BU20-P6+A2+4D	6ES7193-6BP20-0DC0
BU type C0; BaseUnit (light) with 6 push-in terminals (1...6) to the module and an additional 2 AUX terminals; new load group	
Accessories	
Reference identification label	6ES7193-6LF30-0AW0
10 sheets of 16 labels	
Labeling strips	6ES7193-6LA10-0AG0
1000 labeling strips DIN A4, yellow, card, for inscription with laser printer	

Ordering data	Article No.
BU cover	
for covering empty slots (gaps); 5 units	
• 20 mm wide	6ES7133-6CV20-1AM0
Shield connection	6ES7193-6SC00-1AM0
5 shield supports and 5 shield terminals	
Color-coding plates	6ES7193-6CP52-2MC0
• Color code CC52, module-specific, for 8 push-in terminals; 10 units	
E-coding element type F	6ES7193-6EF00-1AA0
5 units, spare part	

I/O systems

SIMATIC ET 200 systems for the control cabinet
SIMATIC ET 200SP

Fail-safe I/O modules > SIPLUS digital F input modules

Overview



Digital fail-safe input module:
F-DI 8x24 V DC High Feature for BU type A0, color code CC01

Other properties:

- 8-channel digital fail-safe input module for the ET 200SP
- For fail-safe reading of sensor information (1 or 2 channels)
- Provides integral discrepancy evaluation for 2-out-of-2 signals
- 8 internal sensor supplies (incl. test function) onboard
- Certified up to SIL 3 (IEC 61508), PL e (ISO 13849)

- Can be plugged onto type A0 BaseUnits (BU) with automatic coding
- LED display for error, operation, supply voltage and status
- Clear labeling on front of module
 - Plain text identification of the module type and function class
 - 2D matrix code (order and serial number)
 - Connection diagram
 - Color coding of the DI module type: white
 - Hardware and firmware version
 - Color code (CC) for module-specific color coding of the potentials at the terminals of the BU
 - Complete Article No.
- Optional labeling accessories
 - Labeling strips
 - Reference identification label
- Optional module-specific color identification of the terminals according to the color code (CC)
- Optional system-integrated shield connection
- The modules support PROFIsafe in both PROFIBUS and PROFINET configurations. They can be used with all fail-safe SIMATIC S7 CPUs

Note:

SIPLUS extreme products are based on SIMATIC standard products. The contents listed here were taken from the respective standard products. SIPLUS extreme-specific information was added.

Technical specifications

Article number	6AG1136-6BA00-2CA0
Based on	6ES7136-6BA00-0CA0 SIPLUS ET 200SP F-DI 4/8x24VDC HF
Ambient conditions	
Ambient temperature during operation	
• horizontal installation, min.	-25 °C
• horizontal installation, max.	60 °C
• vertical installation, min.	-25 °C
• vertical installation, max.	50 °C
Extended ambient conditions	
• relative to ambient temperature-atmospheric pressure-installation altitude	Tmin ... Tmax at 1080 hPa ... 795 hPa (-1000 m ... +2000 m)
Relative humidity	
- With condensation, tested in accordance with IEC 60068-2-38, max.	100 %; RH incl. condensation/frost (no commissioning under condensation conditions)

Article number	6AG1136-6BA00-2CA0
Based on	6ES7136-6BA00-0CA0 SIPLUS ET 200SP F-DI 4/8x24VDC HF
Resistance	
- against biologically active substances / conformity with EN 60721-3-3	Yes; Class 3B2 mold, fungus and dry rot spores (with the exception of fauna). The supplied connector covers must remain on the unused interfaces during operation!
- against chemically active substances / conformity with EN 60721-3-3	Yes; Class 3C4 (RH < 75%) incl. salt spray according to EN 60068-2-52 (degree of severity 3). The supplied connector covers must remain on the unused interfaces during operation!
- against mechanically active substances / conformity with EN 60721-3-3	Yes; Class 3S4 incl. sand, dust. The supplied connector covers must remain on the unused interfaces during operation!

Ordering data	Article No.	Ordering data	Article No.
SIPLUS digital fail-safe input modules (Extended temperature range and exposure to media) F-DI 8x24 V DC High Feature, BU type A0, color code CC01	6AG1136-6BA00-2CA0	BU15-P16+A10+2D (Extended temperature range and exposure to media) BU type A0; BaseUnit (light) with 16 process terminals (1...16) to the module and an additional 10 internally jumpered AUX terminals (1 A to 10 A); for starting a new load group (max. 10 A)	6AG1193-6BP20-7DA0
Usable BaseUnits BU15-P16+A0+2D (Extended temperature range and exposure to media) BU type A0; BaseUnit (light) with 16 process terminals to the module; for starting a new load group (max. 10 A)	6AG1193-6BP00-7DA0	BU15-P16+A10+2B (Extended temperature range and exposure to media) BU type A0; BaseUnit (dark) with 16 process terminals (1...16) to the module and an additional 10 internally jumpered AUX terminals (1 A to 10 A); for continuing the load group	6AG1193-6BP20-7BA0
BU15-P16+A0+2B (Extended temperature range and exposure to media) BU type A0; BaseUnit (dark) with 16 process terminals to the module; for continuing the load group	6AG1193-6BP00-7BA0	Accessories See SIMATIC ET 200SP, digital fail-safe input modules, page 9/115	

I/O systems

SIMATIC ET 200 systems for the control cabinet
SIMATIC ET 200SP

Fail-safe I/O modules > SIPLUS digital F output modules

Overview



Digital fail-safe output module:
F-DQ 4x24VDC High Feature, BU type A0, color code CC01

Other properties:

- 4-channel digital fail-safe output module for the ET 200SP
- Fail-safe 2-channel activation (sink/source output) by actuators
- Actuators can be controlled up to 2 A
- Certified up to SIL 3 (IEC 61508), PL e (ISO 13849)

- Can be plugged onto type A0 BaseUnits (BU) with automatic coding
- LED display for error, operation, supply voltage and status
- Clear labeling on front of module
 - Plain text identification of the module type and function class
 - 2D matrix code (order and serial number)
 - Connection diagram
 - Color coding of the DI module type: white
 - Hardware and firmware version
 - Color code (CC) for module-specific color coding of the potentials at the terminals of the BU
 - Complete Article No.
- Optional labeling accessories
 - Labeling strips
 - Reference identification label
- Optional module-specific color identification of the terminals according to the color code (CC)
- Optional system-integrated shield connection
- The modules support PROFIsafe in both PROFIBUS and PROFINET configurations
- They can be used with all fail-safe SIMATIC S7 CPUs

Note:

SIPLUS extreme products are based on SIMATIC standard products. The contents listed here were taken from the respective standard products. SIPLUS extreme-specific information was added.

Technical specifications

Article number	6AG1136-6DB00-2CA0
Based on	6ES7136-6DB00-0CA0 SIPLUS ET 200SP F-DQ 4x24VDC/2A PM HF
Ambient conditions	
Ambient temperature during operation	
• horizontal installation, min.	-25 °C
• horizontal installation, max.	60 °C
• vertical installation, min.	-25 °C
• vertical installation, max.	50 °C
Extended ambient conditions	
• relative to ambient temperature-atmospheric pressure-installation altitude	Tmin ... Tmax at 1080 hPa ... 795 hPa (-1000 m ... +2000 m)
Relative humidity	
- With condensation, tested in accordance with IEC 60068-2-38, max.	100 %; RH incl. condensation/frost (no commissioning under condensation conditions)

Article number	6AG1136-6DB00-2CA0
Based on	6ES7136-6DB00-0CA0 SIPLUS ET 200SP F-DQ 4x24VDC/2A PM HF
Resistance	
- against biologically active substances / conformity with EN 60721-3-3	Yes; Class 3B2 mold, fungus and dry rot spores (with the exception of fauna). The supplied connector covers must remain on the unused interfaces during operation!
- against chemically active substances / conformity with EN 60721-3-3	Yes; Class 3C4 (RH < 75%) incl. salt spray according to EN 60068-2-52 (degree of severity 3). The supplied connector covers must remain on the unused interfaces during operation!
- against mechanically active substances / conformity with EN 60721-3-3	Yes; Class 3S4 incl. sand, dust. The supplied connector covers must remain on the unused interfaces during operation!

Ordering data	Article No.	Ordering data	Article No.
SIPLUS digital fail-safe output modules (Extended temperature range and exposure to media) F-DQ 4x24VDC High Feature, BU type A0, color code CC01	6AG1136-6DB00-2CA0	BU15-P16+A10+2B (Extended temperature range and exposure to media) BU type A0; BaseUnit (dark) with 16 process terminals (1...16) to the module and an additional 10 internally jumpered AUX terminals (1 A to 10 A); for continuing the load group	6AG1193-6BP20-7BA0
Usable BaseUnits BU15-P16+A0+2D (Extended temperature range and exposure to media) BU type A0; BaseUnit (light) with 16 process terminals to the module; for starting a new load group (max. 10 A)	6AG1193-6BP00-7DA0	BU20-P12+A4+0B (Extended temperature range and exposure to media) BU type B0; BaseUnit (dark) with 12 process terminals (1...12) to the module and an additional 4 internally jumpered AUX terminals (1 A to 4 A); for continuing the load group; 1 unit	6AG1193-6BP20-7BB0
BU15-P16+A0+2B (Extended temperature range and exposure to media) BU type A0; BaseUnit (dark) with 16 process terminals to the module; for continuing the load group	6AG1193-6BP00-7BA0	Accessories See SIMATIC ET 200SP, digital F output modules, page 9/118	
BU15-P16+A10+2D (Extended temperature range and exposure to media) BU type A0; BaseUnit (light) with 16 process terminals (1...16) to the module and an additional 10 internally jumpered AUX terminals (1 A to 10 A); for starting a new load group (max. 10 A)	6AG1193-6BP20-7DA0		

IO systems

SIMATIC ET 200 systems for the control cabinet
SIMATIC ET 200SP

Fail-safe I/O modules > SIPLUS fail-safe special modules

Overview

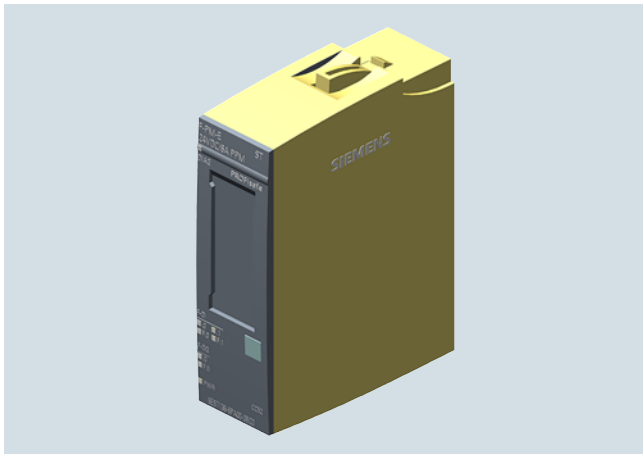

Digital fail-safe power module:
F-PM-E PPM 24VDC/8A for BU type C0,
color code CC52

Other properties:

- Certified up to SIL 3 (IEC 61508), PL e (ISO 13849)
- Safety-related shutdown of output modules within the potential group of the F-PM-E
- Two fail-safe digital inputs, for reading of sensor information (1 or 2 channels)
- One fail-safe digital output onboard (ppm switching, up to 2 A, up to SIL 3/PL e)
- Fail-safe digital output and potential supply pp or pm switching can be configured
- Configurable onboard evaluation of the fail-safe inputs for control of the fail-safe digital outputs and of the potential group
- Digital standard output modules can be shut down up to PL d (ISO 13849) and SIL 2 (IEC 61508) (up to 8 A)
- Can be plugged onto type C0 BaseUnits (BU) with automatic coding
- LED display for error, operation, supply voltage and status
- Clear labeling on front of module
 - Plain text identification of the module type and function class
 - 2D matrix code (order and serial number)
 - Connection diagram
 - Color coding of the DI module type: white
 - Hardware and firmware version
 - Color code (CC) for module-specific color coding of the potentials at the terminals of the BU
 - Complete Article No.
- Optional labeling accessories
 - Labeling strips
 - Reference identification label
- Optional module-specific color identification of the terminals according to the color code (CC)
- Optional system-integrated shield connection
- The modules support PROFIsafe in both PROFIBUS and PROFINET configurations
- They can be used with all fail-safe SIMATIC S7 CPUs

Note:

SIPLUS extreme products are based on SIMATIC standard products. The contents listed here were taken from the respective standard products. SIPLUS extreme-specific information was added.

Technische Daten		Ordering data	Article No.
Article number	6AG1136-6PA00-2BC0	SIPLUS digital F power module F-PM-E 24 V DC/8 A PPM Standard (Extended temperature range and exposure to media) BU type C0, color code CC52. 2 inputs, 1 output, SIL3/Cat.4/PLe	6AG1136-6PA00-2BC0
Based on	6ES7136-6PA00-0BC0 SIPLUS ET 200SP F-PM-E 24VDC/8A PPM		
Ambient conditions		Type C0 BaseUnits	
Ambient temperature during operation		BU20-P6+A2+4D	6AG1193-6BP20-7DC0
• horizontal installation, min.	-25 °C	(Extended temperature range and exposure to media)	
• horizontal installation, max.	60 °C	BU type C0; BaseUnit (light) with 6 push-in terminals (1...6) to the module and an additional 2 AUX terminals; new load group	
• vertical installation, min.	-25 °C		
• vertical installation, max.	50 °C		
Extended ambient conditions		Accessories	See SIMATIC ET 200SP, fail-safe special modules, page 9/123
• relative to ambient temperature- atmospheric pressure-installation altitude	Tmin ... Tmax at 1080 hPa ... 795 hPa (-1000 m ... +2000 m)		
Relative humidity			
- With condensation, tested in accordance with IEC 60068-2-38, max.	100 %; RH incl. condensation/frost (no commissioning under conden- sation conditions)		
Resistance			
- against biologically active substances / conformity with EN 60721-3-3	Yes; Class 3B2 mold, fungus and dry rot spores (with the exception of fauna). The supplied connector covers must remain on the unused interfaces during operation!		
- against chemically active substances / conformity with EN 60721-3-3	Yes; Class 3C4 (RH < 75%) incl. salt spray according to EN 60068-2-52 (degree of severity 3). The supplied connector covers must remain on the unused interfaces during operation!		
- against mechanically active substances / conformity with EN 60721-3-3	Yes; Class 3S4 incl. sand, dust. The supplied connector covers must remain on the unused interfaces during operation!		

I/O systems

SIMATIC ET 200 systems for the control cabinet
SIMATIC ET 200SP

Fail-safe I/O modules > F-CM AS-i Safety ST for SIMATIC ET 200SP

Overview



The F-CM AS-i Safety ST fail-safe communication module supplements an AS-Interface network without additional wiring to produce a safety-related AS-i network.

Important features:

- Fail-safe communication module for the ET 200SP
 - 31 fail-safe input channels in the process image
 - 16 fail-safe output channels in the process image
 - Certified up to SIL 3 (IEC 61508/EN 62061), PL e (EN ISO 13849-1)
 - Parameterization conforms with other fail-safe I/O modules of the ET 200SP
- The communication module supports PROFIsafe in PROFINET and PROFIBUS configurations. It can be used with fail-safe SIMATIC S7-300F/S7-416F CPUs and S7-1500F CPUs and also the fail-safe versions of the ET 200SP station with ET 200SP F-CPU 1510SP F / 1512SP F (firmware V1.8 or higher) or 1515SP PC F
- For reading up to 31 fail-safe AS-i input slaves
 - Two sensor inputs/signals for each fail-safe AS-i input slave
 - Adjustable evaluation of sensor signals: 2-channel or 2 x 1-channel
 - Integrated discrepancy evaluation in the case of 2-channel signals
 - Integrated AND operation in the case of 2 x 1-channel signals
 - Input delay can be parameterized
 - Start-up test can be set
 - Sequence monitoring can be activated
- For control of up to 16 fail-safe AS-i output circuit groups
 - The output circuit groups are controlled independently of one another
 - One output circuit group can act on one or more actuators (e.g. to switch drives simultaneously)
 - An actuator (e.g. a contactor) is interfaced via an AS-i safety output module (e.g. SlimLine S45F safety module, Article No. 3RK1405-1SE15-0AA2; see [Catalog IC 10, Chapter 2 "Industrial Communication" → "ASIsafe" → "Fail-safe AS-Interface modules"](#)).
 - Simple fault acknowledgment via the process image
- Simple module replacement thanks to automatic importing of the safety parameters from the coding element
- Comprehensive diagnostic options
- Can be plugged onto type C1 or type C0 BaseUnits (BU)
- Informative automatic alarm indications (firmware V1.0.1 or higher)

- Supply via AS-Interface voltage
- Eight LED indicators for diagnostics, operating state, fault indication and supply voltage
- Informative front-side module inscription
 - Plain text marking of the module type and function class
 - 2D matrix code (Article No. and serial number)
 - Connection diagram
 - Color coding of the CM module type: light gray
 - Hardware and firmware version
 - Complete Article No.
- Optional labeling accessories
 - Labeling strips
 - Reference identification label

Design

The fail-safe F-CM AS-i Safety ST module has an ET 200SP module enclosure with a width of 20 mm.

One AS-i master according to the AS-i Specification V3.0, as well as fail-safe AS-i input slaves and/or AS-i safety output modules are needed for operation. The CM AS-i Master ST communication module (Article no. 3RK7137-6SA00-0BC1) is recommended as the AS-i master for the ET 200SP, see beginning from page 9/89.

Simple combination of the CM AS-i Master ST and F-CM AS-i Safety ST modules in one ET 200SP station results in a powerful, safety-oriented router between PROFINET (or PROFIBUS) and AS-Interface, which can be expanded further in a modular fashion.

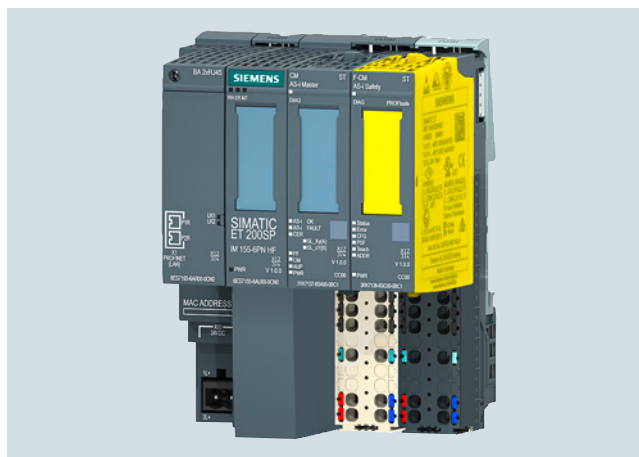

Combination of an ET 200SP interface module, CM AS-i Master ST and F-CM AS-i Safety ST

With the digital and analog I/O modules of the ET 200SP, additional local inputs and outputs can be realized so as to ensure that the modular AS-i router complies precisely with customer requirements. Expansion variants for almost every application are possible thanks to the selection of standard and fail-safe I/O modules.

Besides the single AS-i master, double, triple or generally multiple masters can be realized with or without fail-safe functionality.

Overview (continued)Supported BaseUnits

With the combination of the CM AS-i Master ST and F-CM AS-i Safety ST modules, the CM module is plugged onto a light type C0 BaseUnit and, directly to the right of it, the F-CM module is plugged onto a dark type C1 BaseUnit. The AS-i cable is connected only on the light BaseUnit of the CM module.

Notes on safety

In order to protect plants, systems, machines and networks against cyber threats, it is necessary to implement – and continuously maintain – a holistic, state-of-the-art industrial security concept. Siemens products and solutions only represent one component of such a concept.

For more information on the topic of Industrial Security, see <http://www.siemens.com/industrialsecurity>.

Configuration

The following software is required for configuration of the F-CM AS-i Safety ST module:

- STEP 7 (classic), V5.5 SP3 HF4 or higher with HSP 2093¹⁾ and Distributed Safety V5.4 SP5 or F-Configuration Pack SP11

or

- STEP 7 (TIA Portal) V13 and higher with HSP 0070²⁾ and Safety Advanced V13.
For connection to S7-1500F you require STEP 7 V13 SP1. When configuring with STEP 7 V13 SP1, the latest version of HSP 0070 V2.0 (or higher) is an essential prerequisite. STEP 7 Safety V13 SP1 Update 4 and the new version of HSP 0070 V3.0 (or higher) is needed for configuration of the F-CM AS-i Safety ST module in an ET 200SP station with ET 200SP F-CPU 1510SP F/1512SP F (firmware V1.8 or higher) or 1515SP PC F.

Configuration and programming are done entirely in the STEP 7 user interface. No additional configuration software is needed for commissioning.

Data management – together with all other configuration data of the SIMATIC – is realized completely in the S7 project.

The input and output channels are assigned to the process image automatically and manual linking via configuration function blocks is not necessary.

If the F-CM AS-i Safety ST module is replaced, all necessary settings are automatically imported into the new module.

The F-CM AS-i Safety ST module occupies 16 input bytes and 8 output bytes in the I/O data of the ET 200SP station.

For diagnostics during ongoing operation, diagnostics blocks with clearly arranged visualization on the SIMATIC HMI panel are available or can be downloaded free of charge via a web browser, see <https://support.industry.siemens.com/cs/ww/en/view/109479103>.

¹⁾ HSP 2093; see <https://support.industry.siemens.com/cs/ww/en/view/23183356>.

²⁾ HSP 0070; see <https://support.industry.siemens.com/cs/ww/en/view/72341852>.

Ordering data**Article No.****F-CM AS-i Safety ST communication module****3RK7136-6SC00-0BC1**

- Fail-safe module for SIMATIC ET 200SP, can be plugged onto BaseUnit type C1 (alternatively type C0)
- Operation requires an AS-i master, e.g. CM AS-i Master ST
- Can be used up to SIL 3 (IEC 62061/IEC 61508), PL e (EN ISO 13849-1)
- Coding element type H (included in scope of supply)
- Dimensions (W x H x D / mm): 20 x 73 x 58

Accessories**BaseUnit BU20-P6+A2+4B****6ES7193-6BP20-0BC1**

- BaseUnit (dark), BU type C1
- Suitable for the F-CM AS-i Safety ST fail-safe module
- Continuation of an AS-i network, connection with the AS-i voltage of the left-hand module

Coding element type H (spare part)**6ES7193-6EH00-1AA0**

- For the ET 200SP modules F-CM AS-i Safety ST, CM 4xIO-Link
- Packing unit 5 items

More accessories

See CM AS-i Master ST communication modules

More information

For the Manual "F-CM AS-i Safety ST for SIMATIC ET 200SP", see <https://support.industry.siemens.com/cs/ww/en/view/90265988>.

Released combinations of the AS-i modules for ET 200SP, see <https://support.industry.siemens.com/cs/ww/en/view/103624653>.

I/O systems

SIMATIC ET 200 systems for the control cabinet
SIMATIC ET 200SP

I/O modules > ET 200SP motor starters

Overview

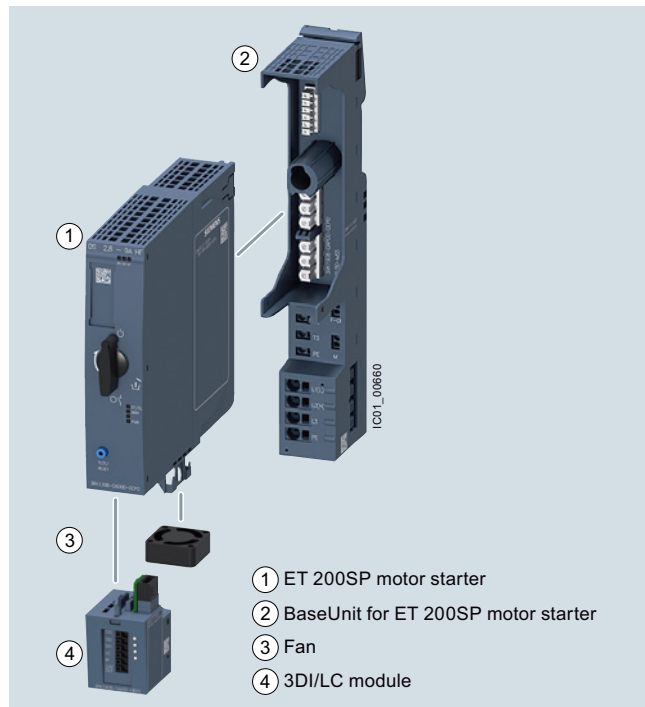

Motor starter, BaseUnit and 3DI/LC control module

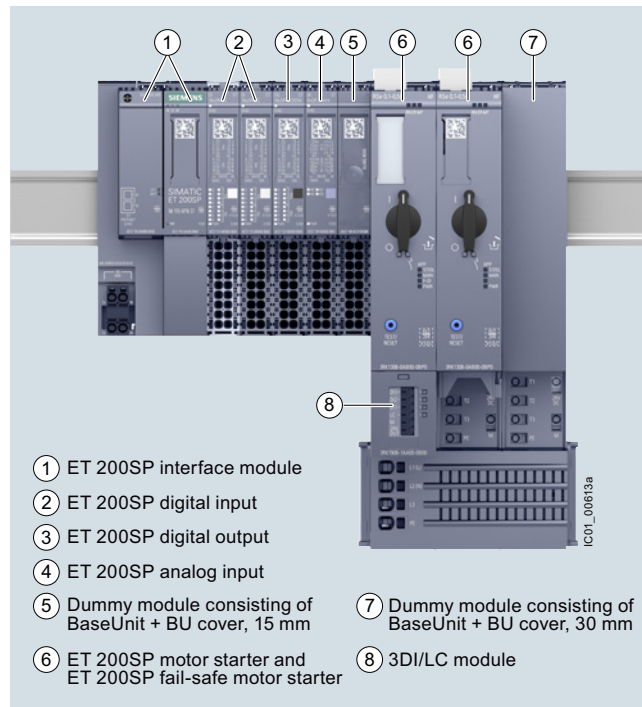

3RK1308 motor starter in the ET 200SP I/O system

More information

Home page see <http://www.siemens.com/ET200SP-motorstarter>

Further components in the ET 200SP distributed I/O system see [Industry Mall, https://mall.industry.siemens.com/mall/en/de/Catalog/Products/10144488?tree=CatalogTree](https://mall.industry.siemens.com/mall/en/de/Catalog/Products/10144488?tree=CatalogTree)

ET 200SP motor starters

ET 200SP is a scalable, highly flexible and modular I/O system with IP20 degree of protection.

As I/O modules, the ET 200SP motor starters are an integral part of this I/O system. They are switching and protection devices for single and three-phase loads and are available as direct-on-line or reversing starters.

Basic functionality

All versions of the ET 200SP motor starters have the following functionality:

- Fully pre-wired motor starters for switching and protecting any AC loads up to 5.5 kW from 48 V AC to 500 V AC
- Disconnection possible via fail-safe motor starters up to SIL 3 and PL e Cat. 4
- With self-assembling 32 A power bus, i.e. the load voltage is only fed in once for a group of motor starters
- All control supply voltages connected only once, i.e. when modules are added they are automatically connected to the next module
- Hot swapping is permissible
- Digital inputs can be used optionally via a 3DI/LC module
- Control of the motor starter from the control system and extensive diagnostics status via the cyclic process image
- Diagnostics capability for active monitoring of the switching and protection functions
- The signal states in the process image of the motor starter provide information about protective devices (short circuit or overload), the switching states of the motor starter, and system faults.

Designing interference-free motor starters

For interference-free operation of the ET 200SP station in accordance with the IEC 60947-4-2 standard, use a dummy module before the first motor starter. The dummy module consists of the 6ES7193-6BP00-0BA0 or 6ES7193-6BP00-0DA0 BaseUnit and the 6ES7133-6CV15-1AM0 BU cover 15 mm.

The 15 mm BU cover protects the plug contacts of the BaseUnit against dirt.

Both can be ordered as accessories, see also page 9/141.

Overview (continued)

Article No. scheme

Product versions		Article number	
Motor starters		3RK1308 - 0 <input type="checkbox"/> <input type="checkbox"/> <input type="checkbox"/> <input type="checkbox"/> 0 0 - 0 C P 0	
Product function	Direct-on-line starters	A	for motor standard output 0.12 ... 5.5 kW ¹⁾
	Reversing starters	B	for motor standard output 0.12 ... 5.5 kW ¹⁾
	Fail-safe direct-on-line starters	C	for motor standard output 0.12 ... 5.5 kW ¹⁾
	Fail-safe reversing starters	D	for motor standard output 0.12 ... 5.5 kW ¹⁾
Current range	0.3 ... 1 A	B	
	0.9 ... 3 A	C	
	2.8 ... 9 A	D	
	4 ... 12 A	E	
		A	
Example		3RK1308 - 0 A D 0 0 - 0 C P 0	

¹⁾ For standard motors: Single- or three-phase asynchronous motors, single-phase AC motors, single-phase asynchronous motors, at 400 V AC and 500 V AC; the actual startup characteristics of the motor as well as its rated data are important factors here.

Note:

The Article No. scheme shows an overview of product versions for better understanding of the logic behind the article numbers.

For your orders, please use the article numbers quoted in the selection and ordering data.

BaseUnits for motor starters

BaseUnits are components for accommodating the ET 200SP I/O modules. The self-assembling voltage buses integrated into the BaseUnits reduce wiring outlay to the single infeed (both of auxiliary and load voltage).

All modules following on the right are automatically supplied upon plugging the BaseUnits together, if BaseUnits are inserted

Article No. scheme

Product versions		Article number	
BaseUnit		3RK1908 - 0 A P 0 0 - 0 <input type="checkbox"/> P 0	
BaseUnit infeed	24 V and 500 V DC	A	
	24 V DC	B	
	500 V AC	C	
	without infeed	D	
	500 V AC	E	with F-DI for fail-safe motor starters
	without infeed	F	with F-DI for fail-safe motor starters
Example		3RK1908 - 0 A P 0 0 - 0 A P 0	

Note:

The Article No. scheme shows an overview of product versions for better understanding of the logic behind the article numbers.

For your orders, please use the article numbers quoted in the selection and ordering data.

3DI/LC control module

This is a digital input module with three inputs for local motor starter functions such as "manual local control", "implementation of fast inputs" or "end position disconnection".

For a list of all the functions permitted by the 3DI/LC module, see Manual "ET 200SP motor starters", "Function overview" section
<https://support.industry.siemens.com/cs/ww/en/view/109479973>

The module is plugged onto the front of the motor starter from which it is supplied with a 24 V DC operating voltage.

I/O systems

SIMATIC ET 200 systems for the control cabinet
SIMATIC ET 200SP

I/O modules > ET 200SP motor starters

Benefits

Product advantages

The ET 200SP motor starters offer a number of benefits:

- Fully integrated into the ET 200SP I/O system (including TIA Selection Tool and TIA Portal)
- High degree of flexibility when it comes to safety applications via SIMATIC F-CPU or SIRIUS 3SK safety relays up to SIL 3 and PL e Cat. 4.
- Simple, integrated current value transmission
- Extensive parameterization by means of TIA Portal
- Increase of plant availability through fast replacement of units (easy mounting and plug-in technology)
- Longer service life and reduced heat losses thanks to hybrid technology
- Less space required in the control cabinet (20 to 80%) as a result of greater functional density (direct-on-line and reversing starters in same width)
- Extensive diagnostics and information for preventive maintenance
- Parameterizable inputs via 3DI/LC control module
- Less wiring and testing required as a result of integrating several functions into a single device
- Lower overheads for stock keeping and configuration as a result of the wide setting range of the electronic overload release (up to 1:3)
- Lower technology-reduced inherent power loss as speed-controlled drive systems, also enabling lower cooling requirements (and enabling a more compact design)

The ET 200SP motor starters can be used with highly energy-efficient IE3/IE4 motors.

For more information on IE3/IE4 ready see [Catalog IC 10, Preface](#) or <https://www.siemens.com/ie3ready>

Standards and approvals

- IEC/EN 60947-4-2
- UL 60947-4-2
- CSA
- ATEX
- IEC 61508-1: SIL 3
- ISO 13849: PL e
- CCC approval for China

Application

The ET 200SP motor starters are suitable for the following applications:

- Switching and monitoring of
 - 3-phase motors with overload and short-circuit protection (e.g. 400 V asynchronous motors for secondary drives in conveyor systems)
 - 1-phase motors with overload and short-circuit protection (e.g. 250 V motors for pump applications)
 - Resistive loads by means of current value and diagnosis via the maintenance function (e.g. for heaters)
- Plant monitoring and energy management in conveyor systems:

By means of phase asymmetry and zero current detection, for example, it is possible to monitor drive belts and blocking
- Track switching and lifting table control in conveyor systems

Track switches can be implemented by means of the quick stop function and lifting table controls by means of the "immediate end position disconnection" function without any laborious programming
- Safe isolation of drive from main power supply:

The isolating functions in accordance with IEC 60947-1 offer protection against inadvertent activation during plant maintenance

Technical specifications

More information

Industry Mall, see www.siemens.com/product?3RK1308

Manual, see

<https://support.industry.siemens.com/cs/ww/en/view/109479973>

FAQs, see <https://support.industry.siemens.com/cs/de/en/ps/21800/faq>

ET 200SP motor starters

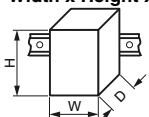
Article number	3RK1308-0AB00-0CP0	3RK1308-0AC00-0CP0	3RK1308-0AD00-0CP0	3RK1308-0AE00-0CP0
	3RK1308-0BB00-0CP0	3RK1308-0BC00-0CP0	3RK1308-0BD00-0CP0	3RK1308-0BE00-0CP0
Product designation	Motor starters			
General technical data				
Width x Height x Depth	mm	30 × 142 × 150		
				
Design of the switching contact	Hybrid			
Type of the motor protection	solid-state			
Installation altitude at height above sea level maximum	m	4 000		
Mounting position	Vertical, horizontal, flat (observe derating)			
Mounting type	pluggable in BaseUnit			
Ambient temperature				
• during operation	°C	-25 ... +60		
• during transport	°C	-40 ... +70		
• during storage	°C	-40 ... +70		

Article number		3RK1308-0AB00-0CP0	3RK1308-0AC00-0CP0	3RK1308-0AD00-0CP0	3RK1308-0AE00-0CP0
		3RK1308-0BB00-0CP0	3RK1308-0BC00-0CP0	3RK1308-0BD00-0CP0	3RK1308-0BE00-0CP0
Relative humidity during operation	%	10 ... 95			
Vibration resistance		15 mm to 6 Hz; 2g to 500 Hz			
Shock resistance		6 g / 11 ms			
Protection class IP		IP20			
Type of assignment		1			
Electrical data					
Supply voltage at DC rated value	V	24			
Operating power at AC-53a at 400 V rated value	kW	0.25	1.1	4	5.5
Operating frequency rated value	Hz	50 ... 60			
Maximum short-circuit current breaking capacity (I_{cu})					
• at 400 V rated value	kA	55			
• at 500 V rated value	kA	55			
Adjustable pick-up value current of the current-dependent overload release	A	0.3 ... 1	0.9 ... 3	2.8 ... 9	4 ... 12
Current-carrying capacity at startup maximum	A	10	30	90	100
maximum permissible voltage for safe isolation between main and auxiliary circuit	V	500			
Insulation voltage rated value	V	500			
Trip class		CLASS 5 and 10 adjustable			

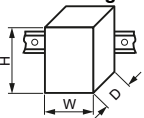
Article number		3RK1308-0CB00-0CP0	3RK1308-0CC00-0CP0	3RK1308-0CD00-0CP0	3RK1308-0CE00-0CP0
		3RK1308-0DB00-0CP0	3RK1308-0DC00-0CP0	3RK1308-0DD00-0CP0	3RK1308-0DE00-0CP0
Product designation		Fail-safe motor starter			
General technical data					
Width x Height x Depth	mm	30 x 142 x 150			
					
Design of the switching contact		Hybrid			
Type of the motor protection		Solid-state			
Installation altitude at height above sea level maximum	m	2 000			
Mounting position		Vertical, horizontal, flat (observe derating)			
Mounting type		Pluggable in BaseUnit			
Ambient temperature					
• during operation	°C	-25 ... +60			
• during transport	°C	-40 ... +70			
• during storage	°C	-40 ... +70			
Relative humidity during operation	%	10 ... 95			
Vibration resistance		15 mm bis 6 Hz; 2 g bis 500 Hz			
Shock resistance		6 g / 11 ms			
Protection class IP		IP20			
Type of assignment		1			
Electrical data					
Supply voltage at DC rated value	V	24			
Operating power at AC-53a at 400 V rated value	kW	0.25	1.1	4	5.5
Operating frequency rated value	Hz	50 ... 60			
Maximum short-circuit current breaking capacity (I_{cu})					
• at 400 V rated value	kA	55			
• at 500 V rated value	kA	55			
Adjustable pick-up value current of the current-dependent overload release	A	0.3 ... 1	0.9 ... 3	2.8 ... 9	4 ... 12
Current-carrying capacity at startup maximum	A	10	30	90	100
maximum permissible voltage for safe isolation between main and auxiliary circuit	V	500			
Insulation voltage rated value	V	500			
Trip class		CLASS 5 and 10 adjustable			

I/O systems

SIMATIC ET 200 systems for the control cabinet

SIMATIC ET 200SP

I/O modules > ET 200SP motor starters**BaseUnits for motor starters**

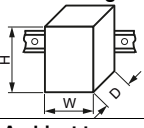
Article number	3RK1908-0AP00-0AP0	3RK1908-0AP00-0BP0	3RK1908-0AP00-0CP0	3RK1908-0AP00-0DP0	3RK1908-0AP00-0EP0	3RK1908-0AP00-0FP0
Product designation	BaseUnit					
General technical data						
Width x Height x Depth	mm	30 × 215 × 75				
						
Ambient temperature		IP20				
• during operation	°C	-25 ... +60				
• during transport	°C	-40 ... +70				
• during storage	°C	-40 ... +70				
Protection class IP		finger-safe				
Protection against electrical shock		finger-safe				
Connections/Terminals						
Type of connectable conductor cross-sections						
• at the inputs for supply voltage		<ul style="list-style-type: none"> - solid - finely stranded with core end processing - finely stranded without core end processing - at AWG conductors solid 				
		1x0.5 ... 2.5 mm ²	--	--	--	--
		1x0.5 ... 2.5 mm ²	--	--	--	--
		1x0.5 ... 2.5 mm ²	--	--	--	--
		1x20 ... 12	--	--	--	--
• for supply		<ul style="list-style-type: none"> - solid - finely stranded with core end processing - finely stranded without core end processing - at AWG conductors solid 				
		1x1 ... 6 mm ²	--	1x1 ... 6 mm ²	--	1x1 ... 6 mm ² --
		1x1 ... 6 mm ²	--	1x1 ... 6 mm ²	--	1x1 ... 6 mm ² --
		1x1 ... 6 mm ²	--	1x1 ... 6 mm ²	--	1x1 ... 6 mm ² --
		1x18 ... 10	--	1x18 ... 10	--	1x18 ... 10 --
• for load-side outgoing feeder		<ul style="list-style-type: none"> - solid - finely stranded with core end processing - finely stranded without core end processing - at AWG conductors solid 				
		1x0.5 ... 2.5 mm ²	--	--	--	--
		1x0.5 ... 2.5 mm ²	--	--	--	--
		1x0.5 ... 2.5 mm ²	--	--	--	--
		1x20 ... 12	--	--	--	--
Type of electrical connection for auxiliary and control current circuit		PUSH-IN connection (spring-loaded connection)				
Miscellaneous						
Shape of the screwdriver tip		Slot				
Size of the screwdriver tip		Standard screwdriver 0.6 mm x 3.5 mm				

3DI/LC control module





Article number	3RK1908-1AA00-0BP0	
Product designation	3DI/LC control module	
General technical data		
Width x Height x Depth	mm	30 × 54.5 × 42.3
Design of the product	Accessories	
Number of digital inputs	4	
Installation altitude at height above sea level maximum	m	2 000
Mounting position	vertical, horizontal, flat	
Mounting type	Can be plugged onto motor starters	
Ambient temperature		
• during operation	°C	-25 ... +60
• during transport	°C	-40 ... +70
• during storage	°C	-40 ... +70
Connections/Terminals		
Connectable conductor cross-section for auxiliary contacts		
• single or multi-stranded	mm ²	0.2 ... 1.5
• finely stranded with core end processing	mm ²	0.25 ... 1.5
• finely stranded without core end processing	mm ²	0.2 ... 1.5
AWG number as coded connectable conductor cross section for auxiliary contacts	24 ... 16	
Type of electrical connection for auxiliary and control current circuit	PUSH-IN connection (spring-loaded connection)	
Electrical data		
Type of voltage of the control supply voltage	DC	
Control supply voltage at DC rated value	V	20.4 ... 28.8
Miscellaneous		
Shape of the screwdriver tip	Slot	
Size of the screwdriver tip	Standard screwdriver 0.6 mm x 3.5 mm	

I/O systems

SIMATIC ET 200 systems for the control cabinet
SIMATIC ET 200SP

I/O modules > ET 200SP motor starters **IE3/IE4 ready**

Selection and ordering data

	Adjustable current response value of the inverse-time delayed overload release	Current-carrying capacity at startup maximum		Article No.
	A	A		
Motor starters				
Direct-online starter				
	0.3 ... 1	10		3RK1308-0AB00-0CP0 3RK1308-0AC00-0CP0 3RK1308-0AD00-0CP0 3RK1308-0AE00-0CP0
	0.9 ... 3	30		
	2.8 ... 9	90		
	4 ... 12	100	NEW	
3RK1308-0AB00-0CP0				
Reversing starter				
	0.3 ... 1	10		3RK1308-0BB00-0CP0 3RK1308-0BC00-0CP0 3RK1308-0BD00-0CP0 3RK1308-0BE00-0CP0
	0.9 ... 3	30		
	2.8 ... 9	90		
	4 ... 12	100	NEW	
3RK1308-0BB00-0CP0				
Fail-safe direct-online starter				
	0.3 ... 1	10	NEW	3RK1308-0CB00-0CP0 3RK1308-0CC00-0CP0 3RK1308-0CD00-0CP0 3RK1308-0CE00-0CP0
	0.9 ... 3	30	NEW	
	2.8 ... 9	90	NEW	
	4 ... 12	100	NEW	
3RK1308-0CE00-0CP0				
Fail-safe reversing starter				
	0.3 ... 1	10	NEW	3RK1308-0DB00-0CP0 3RK1308-0DC00-0CP0 3RK1308-0DD00-0CP0 3RK1308-0DE00-0CP0
	0.9 ... 3	30	NEW	
	2.8 ... 9	90	NEW	
	4 ... 12	100	NEW	
3RK1308-0DE00-0CP0				

Design of the product	Operating voltage of AC supply	Supply voltage of DC supply	Spring-loaded connection (push-in)
			Article No.
	V	V	

BaseUnit¹⁾

3RK1908-0AP00-0AP0

For AC/DC feed in	500	24	3RK1908-0AP00-0AP0
For AC feed in	--	24	3RK1908-0AP00-0BP0
For DC feed in	500	--	3RK1908-0AP00-0CP0
Without feed in	--	--	3RK1908-0AP00-0DP0
For AC infeed, F-DI	500	--	3RK1908-0AP00-0EP0
Without infeed, F-DI	--	--	3RK1908-0AP00-0FP0

NEW

NEW

¹⁾ The voltage is looped-through from BaseUnits with infeed to subsequent BaseUnits.

Control supply voltage at DC rated value	Product function		Spring-loaded connection (push-in)
	on-site operation	digital inputs parameterizable	Article No.
V			

3DI/LC control module

3RK1908-1AA00-0BP0

20.4 ... 28.8	Yes	Yes	3RK1908-1AA00-0BP0
---------------	-----	-----	---------------------------

Product designation	Article No.

Accessories



3RK1908-1CA00-0BP0

BaseUnit cover	3RK1908-1CA00-0BP0
-----------------------	---------------------------

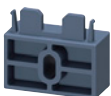

3RK1908-1DA00-2BP0

Infeed bus cover	3RK1908-1DA00-2BP0
-------------------------	---------------------------



3RK1908-1EA00-1BP0

Mechanical bracket	3RK1908-1EA00-1BP0
---------------------------	---------------------------



3RW4928-8VB00

Fan	3RW4928-8VB00
------------	----------------------

I/O systems

SIMATIC ET 200 systems for the control cabinet
SIMATIC ET 200SP

BaseUnits

Overview



With the BaseUnits, the ET 200SP offers a rugged and service-friendly design with permanent wiring:

- No tools needed for one-handed wiring using push-in terminals
- Actuation of the spring NC contacts with a standard screwdriver, with a blade width up to 3.5 mm
- Outstanding access due to arrangement of measuring tap, spring NC contacts and cable entry in columns, while at the same time reducing the space required by 64%
- Fault-proof color coding of the spring NC contacts for better orientation in the terminal panel

- Replacement of I/O modules during operation without affecting the wiring
- Operation with module gaps (gaps without I/O module)
- Automatic coding of the I/O modules prevents destruction of the electronics if a module is accidentally inserted in the wrong slot during replacement
- High EMC interference immunity:
 - self-assembling shielded backplane bus
 - multi-layer conductor plate with shield levels for interference-free signal transmission from the terminal to the I/O module
 - system-integrated, space-saving shield connection for quick installation
- Self-assembling potential groups without external wiring or jumpers
- Replaceable terminal box
- Side-by-side latching of the BUs for high mechanical and EMC loads
- Optional module-specific color identification of the terminals according to the color code (CC)
- Optional equipment marking using slide-in equipment labeling plates

An ET 200SP station can be expanded via one BU-Send BaseUnit with a BA-Send BusAdapter plugged onto it with up to 16 modules from the ET 200AL series of I/O devices with IP67 protection.

Technical specifications

Article number	6ES7193-6BP20-0DA0	6ES7193-6BP00-0DA0	6ES7193-6BP20-0BA0	6ES7193-6BP00-0BA0
	BASEUNIT TYPE A0, BU15-P16+A10+2D	BASEUNIT TYPE A0, BU15-P16+A0+2D	BASEUNIT TYPE A0, BU15-P16+A10+2B	BASEUNIT TYPE A0, BU15-P16+A0+2B
General information				
Product type designation	ET 200SP, BaseUnit BU type A0, BU15-P16+A10+2D, PU 1	BU Type A0, BU15-P16+A0+2D, PU 1	ET 200SP, BaseUnit BU type A0, BU15-P16+A10+2B, PU 1	BU Type A0, BU15-P16+A0+2B, PU 1
Dimensions				
Width	15 mm	15 mm	15 mm	15 mm
Height	141 mm	117 mm	141 mm	117 mm
Depth	35 mm	35 mm	35 mm	35 mm
Weights				
Weight, approx.	50 g	40 g	50 g	40 g

Article number	6ES7193-6BP20-0BB0	6ES7193-6BP20-0BB1	6ES7193-6BP20-0DC0	6ES7193-6BP00-0BD0	6ES7193-6BP20-0BF0
	BASEUNIT TYP B0, BU20-P12+A4+0B	BASEUNIT TYPE B1, BU20-P12+A0+4B	BASEUNIT TYP C0, BU20-P6+A2+4D	BASEUNIT TYPE D0, BU20-P12+A0+0B	BASEUNIT TYPE F0, BU20-P8+A4+0B
General information					
Product type designation	ET 200SP, BaseUnit BU-Typ B0, PU 1	ET 200SP, BaseUnit BU type B1, BU20-P12+A0+4B, PU 1	ET 200SP, BaseUnit type C0, BU20-P6+A2+4D, PU 1	ET 200SP, BaseUnit BU type D0, PU 1	ET 200SP, BaseUnit BU type F0, BU20-P8+A4+0B, PU 1
Dimensions					
Width	20 mm	20 mm	20 mm	20 mm	20 mm
Height	117 mm	117 mm	117 mm	117 mm	117 mm
Depth	35 mm	35 mm	35 mm	35 mm	35 mm
Weights					
Weight, approx.	48 g	48 g	47 g	47 g	48 g

Technical specifications (continued)

Article number	6ES7193-6BP40-0DA1 BASEUNIT TYPE A1, BU15-P16+A0+12D/T	6ES7193-6BP00-0DA1 BASEUNIT TYPE A1, BU15-P16+A0+2D/T	6ES7193-6BP40-0BA1 BASEUNIT TYPE A1, BU15-P16+A0+12B/T	6ES7193-6BP00-0BA1 BASEUNIT TYPE A1, BU15-P16+A0+2B/T
General information				
Product type designation	ET 200SP, BaseUnit BU type A1, BU15-P16+A0+12D/T, PU 1	ET 200SP, BaseUnit BU type A1, BU15-P16+A0+2D/T, PU 1	ET 200SP, BaseUnit BU type A1, BU15-P16+A0+12B/T, PU 1	BU type A1, BU15-P16+A0+2B/T, PU 1
Dimensions				
Width	15 mm	15 mm	15 mm	15 mm
Height	141 mm	117 mm	141 mm	117 mm
Depth	35 mm	35 mm	35 mm	35 mm
Weights				
Weight, approx.	50 g	40 g	50 g	40 g

Article number	6ES7193-6BN00-0NE0 ET 200SP, BASEUNIT BU-SEND
General information	
Product type designation	BaseUnit BU-Send
Dimensions	
Width	20 mm
Height	117 mm
Depth	35 mm
Weights	
Weight, approx.	30 g

Ordering data

Article No.	Article No.
Type A0 BaseUnits BU15-P16+A10+2D BU type A0; BaseUnit (light) with 16 process terminals (1...16) to the module and an additional 10 internally jumpered AUX terminals (1 A to 10 A); for starting a new load group (max. 10 A) • 1 unit • 10 units 6ES7193-6BP20-0DA0 6ES7193-6BP20-2DA0	Type B0 BaseUnits BU20-P12+A4+0B BU type B0; BaseUnit (dark) with 12 process terminals (1...12) to the module and an additional 4 internally jumpered AUX terminals (1 A to 4 A); for continuing the load group; 1 unit • 1 unit • 10 units 6ES7193-6BP20-0BB0 6ES7193-6BP20-2BB0
BU15-P16+A0+2D BU type A0; BaseUnit (light) with 16 process terminals to the module; for starting a new load group (max. 10 A) • 1 unit • 10 units 6ES7193-6BP00-0DA0 6ES7193-6BP00-2DA0	Type B1 BaseUnits BU20-P12+A0+4B BU type B1; BaseUnit (dark) with 12 process terminals to the module; for continuing the load group; 1 unit 6ES7193-6BP20-0BB1
BU15-P16+A10+2B BU type A0; BaseUnit (dark) with 16 process terminals (1...16) to the module and an additional 10 internally jumpered AUX terminals (1 A to 10 A); for continuing the load group • 1 unit • 10 units 6ES7193-6BP20-0BA0 6ES7193-6BP20-2BA0	Type C0 BaseUnits BU20-P6+A2+4D BU type C0; BaseUnit (light) with 6 push-in terminals (1...6) to the module and an additional 2 AUX terminals; new load group 6ES7193-6BP20-0DC0
BU15-P16+A0+2B BU type A0; BaseUnit (dark) with 16 process terminals to the module; for continuing the load group • 1 unit • 10 units 6ES7193-6BP00-0BA0 6ES7193-6BP00-2BA0	Type D0 BaseUnits BU20-P12+A0+0B BU type D0; BaseUnit (dark) with 12 push-in terminals, without AUX terminals, bridged to the left 6ES7193-6BP00-0BD0

I/O systemsSIMATIC ET 200 systems for the control cabinet
SIMATIC ET 200SP**BaseUnits**

Ordering data	Article No.	Accessories	Article No.
Type A1 BaseUnits (with temperature detection)		Equipment labeling plate	6ES7193-6LF30-0AW0
BU15-P16+A0+12D/T	6ES7193-6BP40-0DA1	10 sheets of 16 labels	
BU type A1; BaseUnit (light) with 16 process terminals (1...16) to the module and an additional 2x5 internally jumpered additional terminals (1 B to 5 B and 1 C to 5 C); for starting a new load group (max. 10 A)		BU cover	
		for covering empty slots (gaps); 5 units	
		• 15 mm wide	6ES7133-6CV15-1AM0
		• 20 mm wide	6ES7133-6CV20-1AM0
BU15-P16+A0+2D/T	6ES7193-6BP00-0DA1	Shield connection	6ES7193-6SC00-1AM0
BU type A1; BaseUnit (light) with 16 process terminals to the module; for starting a new load group (max. 10 A)		5 shield supports and 5 shield terminals	
BU15-P16+A0+12B/T	6ES7193-6BP40-0BA1	Color-coded labels	
BU type A1; BaseUnit (dark) with 16 process terminals (1...16) to the module and an additional 2x5 internally jumpered additional terminals (1 B to 5 B and 1 C to 5 C); for continuing the load group		• Color code CC01, module-specific, for 16 push-in terminals; for BaseUnit type A0, A1; 10 units	6ES7193-6CP01-2MA0
		• Color code CC02, module-specific, for 16 push-in terminals; for BaseUnit type A0, A1; 10 units	6ES7193-6CP02-2MA0
		• Color code CC03, module-specific, for 16 push-in terminals; for BaseUnit type A0, A1; 10 units	6ES7193-6CP03-2MA0
		• Color code CC04, module-specific, for 16 push-in terminals; for BaseUnit type A0, A1; 10 units	6ES7193-6CP04-2MA0
BU15-P16+A0+2B/T	6ES7193-6BP00-0BA1	• Color code CC71, for 10 AUX terminals 1 A to 10 A, for BU type A0, yellow/green, with push-in terminals; 10 units	6ES7193-6CP71-2AA0
BU type A1; BaseUnit (dark) with 16 process terminals to the module; for continuing the load group		• Color code CC72, for 10 AUX terminals 1 A to 10 A, for BU type A0, red, with push-in terminals; 10 units	6ES7193-6CP72-2AA0
Type F0 BaseUnits		• Color code CC73, for 10 AUX terminals 1 A to 10 A, for BU type A0, blue, with push-in terminals; 10 units	6ES7193-6CP73-2AA0
BU20-P8+A4+0B	6ES7193-6BP20-0BF0	• Color code CC74, for 2x5 additional terminals, 5 x red, 5 x blue, for BU type A1, with push-in terminals; 10 units	6ES7193-6CP74-2AA0
BU type F0; BaseUnit (dark) with 8 process terminals to the module and an additional 4 internally jumpered AUX terminals (1 A to 4 A); for continuing the load group		• Color code CC81, for 4 AUX terminals 1 A to 4 A, yellow/green, for BaseUnit type B0; 10 units	6ES7193-6CP81-2AB0
Station expansion with IP67 I/O system ET 200AL		• Color code CC82, for 4 AUX terminals 1 A to 4 A, red, for BaseUnit type B0; 10 units	6ES7193-6CP82-2AB0
BaseUnit BU-Send	6ES7193-6BN00-0NE0	• Color code CC83, for 4 AUX terminals 1 A to 4 A, blue, for BaseUnit type B0; 10 units	6ES7193-6CP83-2AB0
ET 200SP	6ES7193-6AS00-0AA0	• Color code CC41, module-specific, for 12 push-in terminals; for BaseUnit type B1; 10 units	6ES7193-6CP41-2MB0
BA-Send 1 x FC BusAdapter		• Color code CC84, for 2 AUX terminals 1 A to 2 A, yellow/green, for BaseUnit type C0; 10 units	6ES7193-6CP84-2AC0
		• Color code CC85, for 2 AUX terminals 1 A to 2 A, red, for BaseUnit type C0; 10 units	6ES7193-6CP85-2AC0
		• Color code CC86, for 2 AUX terminals 1 A to 2 A, blue, for BaseUnit type C0; 10 units	6ES7193-6CP86-2AC0

Overview



With the BaseUnits, the ET 200SP offers a rugged and service-friendly design with permanent wiring:

- No tools needed for one-handed wiring using push-in terminals
- Outstanding access due to arrangement of measuring tap, spring NC contacts and cable entry in columns, while at the same time reducing the space required by 64%
- Fault-proof color coding of the spring NC contacts for better orientation in the terminal panel
- Replacement of I/O modules during operation without affecting the wiring

- Operation with module gaps (missing I/O module)
- Automatic coding of the I/O modules prevents destruction of the electronics if a module is accidentally inserted in the wrong slot during replacement
- High immunity to electromagnetic interference due to
 - self-assembling shielded backplane bus
 - multi-layer conductor plate with shield levels for interference-free signal transmission from the terminal to the I/O module
 - system-integrated, space-saving shield connection for quick installation
- Self-assembling potential groups without external wiring or jumpers
- Replaceable terminal box
- Side-by-side latching of the BUs for high mechanical load capacity
- Optional module-specific color identification of the terminals according to the color code (CC)
- Actuation of the spring NC contacts with a standard screwdriver, with a blade width up to 3.5 mm

Note:

SIPLUS extreme products are based on SIMATIC standard products. The contents listed here were taken from the respective standard products. SIPLUS extreme-specific information was added.

Technical specifications

Article number	6AG1193-6BP00-7BA0	6AG1193-6BP00-7DA0	6AG1193-6BP20-7BA0	6AG1193-6BP20-7DA0
Based on	6ES7193-6BP00-0BA0	6ES7193-6BP00-0DA0	6ES7193-6BP20-0BA0	6ES7193-6BP20-0DA0
	SIPLUS ET 200SP BU15-P16+A0+2B	SIPLUS ET 200SP BU15-P16+A0+2D	SIPLUS ET 200SP BU15-P16+A10+2B	SIPLUS ET 200SP BU15-P16+A10+2D
Extended ambient conditions				
<ul style="list-style-type: none"> • relative to ambient temperature-atmospheric pressure-installation altitude 	Tmin ... Tmax at 1080 hPa ... 795 hPa (-1000 m ... +2000 m) // Tmin ... (Tmax - 10K) at 795 hPa ... 658 hPa (+2000 m ... +3500 m) // Tmin ... (Tmax - 20K) at 658 hPa ... 540 hPa (+3500 m ... +5000 m)	Tmin ... Tmax at 1080 hPa ... 795 hPa (-1000 m ... +2000 m) // Tmin ... (Tmax - 10K) at 795 hPa ... 658 hPa (+2000 m ... +3500 m) // Tmin ... (Tmax - 20K) at 658 hPa ... 540 hPa (+3500 m ... +5000 m)	Tmin ... Tmax at 1080 hPa ... 795 hPa (-1000 m ... +2000 m) // Tmin ... (Tmax - 10K) at 795 hPa ... 658 hPa (+2000 m ... +3500 m) // Tmin ... (Tmax - 20K) at 658 hPa ... 540 hPa (+3500 m ... +5000 m)	Tmin ... Tmax at 1080 hPa ... 795 hPa (-1000 m ... +2000 m) // Tmin ... (Tmax - 10K) at 795 hPa ... 658 hPa (+2000 m ... +3500 m) // Tmin ... (Tmax - 20K) at 658 hPa ... 540 hPa (+3500 m ... +5000 m)
Relative humidity				
<ul style="list-style-type: none"> - With condensation, tested in accordance with IEC 60068-2-38, max. 	100 %; RH incl. condensation/frost (no commissioning under condensation conditions)	100 %; RH incl. condensation/frost (no commissioning under condensation conditions)	100 %; RH incl. condensation/frost (no commissioning under condensation conditions)	100 %; RH incl. condensation/frost (no commissioning under condensation conditions)

I/O systems

SIMATIC ET 200 systems for the control cabinet SIMATIC ET 200SP

SIPLUS BaseUnits

Technical specifications (continued)

Article number	6AG1193-6BP00-7BA0	6AG1193-6BP00-7DA0	6AG1193-6BP20-7BA0	6AG1193-6BP20-7DA0
Based on	6ES7193-6BP00-0BA0 SIPLUS ET 200SP BU15-P16+A0+2B	6ES7193-6BP00-0DA0 SIPLUS ET 200SP BU15-P16+A0+2D	6ES7193-6BP20-0BA0 SIPLUS ET 200SP BU15-P16+A10+2B	6ES7193-6BP20-0DA0 SIPLUS ET 200SP BU15-P16+A10+2D
Resistance				
- against biologically active substances / conformity with EN 60721-3-3	Yes; Class 3B2 mold, fungus and dry rot spores (with the exception of fauna). The supplied connector covers must remain on the unused interfaces during operation!	Yes; Class 3B2 mold, fungus and dry rot spores (with the exception of fauna). The supplied connector covers must remain on the unused interfaces during operation!	Yes; Class 3B2 mold, fungus and dry rot spores (with the exception of fauna). The supplied connector covers must remain on the unused interfaces during operation!	Yes; Class 3B2 mold, fungus and dry rot spores (with the exception of fauna). The supplied connector covers must remain on the unused interfaces during operation!
- against chemically active substances / conformity with EN 60721-3-3	Yes; Class 3C4 (RH < 75%) incl. salt spray according to EN 60068-2-52 (degree of severity 3). The supplied connector covers must remain on the unused interfaces during operation!	Yes; Class 3C4 (RH < 75%) incl. salt spray according to EN 60068-2-52 (degree of severity 3). The supplied connector covers must remain on the unused interfaces during operation!	Yes; Class 3C4 (RH < 75%) incl. salt spray according to EN 60068-2-52 (degree of severity 3). The supplied connector covers must remain on the unused interfaces during operation!	Yes; Class 3C4 (RH < 75%) incl. salt spray according to EN 60068-2-52 (degree of severity 3). The supplied connector covers must remain on the unused interfaces during operation!
- against mechanically active substances / conformity with EN 60721-3-3	Yes; Class 3S4 incl. sand, dust. The supplied connector covers must remain on the unused interfaces during operation!	Yes; Class 3S4 incl. sand, dust. The supplied connector covers must remain on the unused interfaces during operation!	Yes; Class 3S4 incl. sand, dust. The supplied connector covers must remain on the unused interfaces during operation!	Yes; Class 3S4 incl. sand, dust. The supplied connector covers must remain on the unused interfaces during operation!
Article number	6AG1193-6BP00-7BA1	6AG1193-6BP00-7DA1	6AG1193-6BP40-7BA1	6AG1193-6BP40-7DA1
Based on	6ES7193-6BP00-0BA1 SIPLUS ET 200SP BU15-P16+A0+2B/T	6ES7193-6BP00-0DA1 SIPLUS ET 200SP BU15-P16+A0+2D/T	6ES7193-6BP40-0BA1 SIPLUS ET 200SP BU15-P16+A0+12B/T	6ES7193-6BP40-0DA1 SIPLUS ET 200SP BU15-P16+A0+12D/T
Extended ambient conditions				
• relative to ambient temperature-atmospheric pressure-installation altitude	Tmin ... Tmax at 1080 hPa ... 795 hPa (-1000 m ... +2000 m) // Tmin ... (Tmax - 10K) at 795 hPa ... 658 hPa (+2000 m ... +3500 m) // Tmin ... (Tmax - 20K) at 658 hPa ... 540 hPa (+3500 m ... +5000 m)	Tmin ... Tmax at 1080 hPa ... 795 hPa (-1000 m ... +2000 m) // Tmin ... (Tmax - 10K) at 795 hPa ... 658 hPa (+2000 m ... +3500 m) // Tmin ... (Tmax - 20K) at 658 hPa ... 540 hPa (+3500 m ... +5000 m)	Tmin ... Tmax at 1080 hPa ... 795 hPa (-1000 m ... +2000 m) // Tmin ... (Tmax - 10K) at 795 hPa ... 658 hPa (+2000 m ... +3500 m) // Tmin ... (Tmax - 20K) at 658 hPa ... 540 hPa (+3500 m ... +5000 m)	Tmin ... Tmax at 1080 hPa ... 795 hPa (-1000 m ... +2000 m) // Tmin ... (Tmax - 10K) at 795 hPa ... 658 hPa (+2000 m ... +3500 m) // Tmin ... (Tmax - 20K) at 658 hPa ... 540 hPa (+3500 m ... +5000 m)
Relative humidity				
- With condensation, tested in accordance with IEC 60068-2-38, max.	100 %; RH incl. condensation/frost (no commissioning under condensation conditions)	100 %; RH incl. condensation/frost (no commissioning under condensation conditions)	100 %; RH incl. condensation/frost (no commissioning under condensation conditions)	100 %; RH incl. condensation/frost (no commissioning under condensation conditions)
Resistance				
- against biologically active substances / conformity with EN 60721-3-3	Yes; Class 3B2 mold, fungus and dry rot spores (with the exception of fauna). The supplied connector covers must remain on the unused interfaces during operation!	Yes; Class 3B2 mold, fungus and dry rot spores (with the exception of fauna). The supplied connector covers must remain on the unused interfaces during operation!	Yes; Class 3B2 mold, fungus and dry rot spores (with the exception of fauna). The supplied connector covers must remain on the unused interfaces during operation!	Yes; Class 3B2 mold, fungus and dry rot spores (with the exception of fauna). The supplied connector covers must remain on the unused interfaces during operation!
- against chemically active substances / conformity with EN 60721-3-3	Yes; Class 3C4 (RH < 75%) incl. salt spray according to EN 60068-2-52 (degree of severity 3). The supplied connector covers must remain on the unused interfaces during operation!	Yes; Class 3C4 (RH < 75%) incl. salt spray according to EN 60068-2-52 (degree of severity 3). The supplied connector covers must remain on the unused interfaces during operation!	Yes; Class 3C4 (RH < 75%) incl. salt spray according to EN 60068-2-52 (degree of severity 3). The supplied connector covers must remain on the unused interfaces during operation!	Yes; Class 3C4 (RH < 75%) incl. salt spray according to EN 60068-2-52 (degree of severity 3). The supplied connector covers must remain on the unused interfaces during operation!
- against mechanically active substances / conformity with EN 60721-3-3	Yes; Class 3S4 incl. sand, dust. The supplied connector covers must remain on the unused interfaces during operation!	Yes; Class 3S4 incl. sand, dust. The supplied connector covers must remain on the unused interfaces during operation!	Yes; Class 3S4 incl. sand, dust. The supplied connector covers must remain on the unused interfaces during operation!	Yes; Class 3S4 incl. sand, dust. The supplied connector covers must remain on the unused interfaces during operation!

Technical specifications (continued)

Article number	6AG1193-6BP20-7BB0	6AG1193-6BP20-7BB1	6AG1193-6BP20-7DC0	6AG1193-6BP00-7BD0
Based on	6ES7193-6BP20-0BB0 SIPLUS ET 200SP BU20-P12+A4+0B	6ES7193-6BP20-0BB1 SIPLUS ET 200SP BU20-P12+A0+4B TYP B1	6ES7193-6BP20-0DC0 SIPLUS ET 200SP BU20-P6+A2+4D	6ES7193-6BP00-0BD0 SIPLUS ET 200SP BU20-P12+A0+0B
Ambient conditions				
Ambient temperature during operation				
• horizontal installation, min.	-40 °C; = Tmin	-40 °C; = Tmin; Startup @ -25 °C	-25 °C; = Tmin	-40 °C; = Tmin
• horizontal installation, max.	70 °C; = Tmax	70 °C; = Tmax	60 °C; = Tmax	70 °C; = Tmax
• vertical installation, min.	-40 °C		-25 °C	-40 °C
• vertical installation, max.	50 °C		50 °C	50 °C
Extended ambient conditions				
• relative to ambient temperature-atmospheric pressure-installation altitude	Tmin ... Tmax at 1080 hPa ... 795 hPa (-1000 m ... +2000 m) // Tmin ... (Tmax - 10K) at 795 hPa ... 658 hPa (+2000 m ... +3500 m) // Tmin ... (Tmax - 20K) at 658 hPa ... 540 hPa (+3500 m ... +5000 m)	Tmin ... Tmax at 1080 hPa ... 795 hPa (-1000 m ... +2000 m) // Tmin ... (Tmax - 10K) at 795 hPa ... 658 hPa (+2000 m ... +3500 m) // Tmin ... (Tmax - 20K) at 658 hPa ... 540 hPa (+3500 m ... +5000 m)	Tmin ... Tmax at 1080 hPa ... 795 hPa (-1000 m ... +2000 m)	Tmin ... Tmax at 1080 hPa ... 795 hPa (-1000 m ... +2000 m) // Tmin ... (Tmax - 10K) at 795 hPa ... 658 hPa (+2000 m ... +3500 m) // Tmin ... (Tmax - 20K) at 658 hPa ... 540 hPa (+3500 m ... +5000 m)
Relative humidity				
- With condensation, tested in accordance with IEC 60068-2-38, max.	100 %; RH incl. condensation/frost (no commissioning under condensation conditions)	100 %; RH incl. condensation / frost (no commissioning in bedewed state), horizontal installation	100 %; RH incl. condensation/frost (no commissioning under condensation conditions)	100 %; RH incl. condensation/frost (no commissioning under condensation conditions)
Resistance				
- against biologically active substances / conformity with EN 60721-3-3	Yes; Class 3B2 mold, fungus and dry rot spores (with the exception of fauna). The supplied connector covers must remain on the unused interfaces during operation!	Yes; Class 3B2 mold, fungus and dry rot spores (with the exception of fauna). The supplied connector covers must remain on the unused interfaces during operation!	Yes; Class 3B2 mold, fungus and dry rot spores (with the exception of fauna). The supplied connector covers must remain on the unused interfaces during operation!	Yes; Class 3B2 mold, fungus and dry rot spores (with the exception of fauna). The supplied connector covers must remain on the unused interfaces during operation!
- against chemically active substances / conformity with EN 60721-3-3	Yes; Class 3C4 (RH < 75%) incl. salt spray according to EN 60068-2-52 (degree of severity 3). The supplied connector covers must remain on the unused interfaces during operation!	Yes; Class 3C4 (RH < 75%) incl. salt spray according to EN 60068-2-52 (degree of severity 3). The supplied connector covers must remain on the unused interfaces during operation!	Yes; Class 3C4 (RH < 75%) incl. salt spray according to EN 60068-2-52 (degree of severity 3). The supplied connector covers must remain on the unused interfaces during operation!	Yes; Class 3C4 (RH < 75%) incl. salt spray according to EN 60068-2-52 (degree of severity 3). The supplied connector covers must remain on the unused interfaces during operation!
- against mechanically active substances / conformity with EN 60721-3-3	Yes; Class 3S4 incl. sand, dust. The supplied connector covers must remain on the unused interfaces during operation!	Yes; Class 3S4 incl. sand, dust. The supplied connector covers must remain on the unused interfaces during operation!	Yes; Class 3S4 incl. sand, dust. The supplied connector covers must remain on the unused interfaces during operation!	Yes; Class 3S4 incl. sand, dust. The supplied connector covers must remain on the unused interfaces during operation!

I/O systemsSIMATIC ET 200 systems for the control cabinet
SIMATIC ET 200SP**SIPLUS BaseUnits**

Ordering data	Article No.	Article No.	
SIPLUS BaseUnits type A0 BU15-P16+A0+2D (Extended temperature range and exposure to media) BU type A0; BaseUnit (light) with 16 process terminals to the module; for starting a new load group (max. 10 A)	6AG1193-6BP00-7DA0	BU15-P16+A0+12D/T (Extended temperature range and exposure to media) BU type A1; BaseUnit (light) with 16 process terminals (1...16) to the module and an additional 2x5 internally jumpered AUX terminals (1 B to 5 B and 1 C to 5 C); for starting a new load group (max. 10 A)	6AG1193-6BP40-7DA1
BU15-P16+A0+2B (Extended temperature range and exposure to media) BU type A0; BaseUnit (dark) with 16 process terminals to the module; for continuing the load group	6AG1193-6BP00-7BA0	BU15-P16+A0+12B/T (Extended temperature range and exposure to media) BU type A1; BaseUnit (dark) with 16 process terminals (1...16) to the module and an additional 2x5 internally jumpered AUX terminals (1 B to 5 B and 1 C to 5 C); for continuing the load group	6AG1193-6BP40-7BA1
BU15-P16+A10+2D (Extended temperature range and exposure to media) BU type A0; BaseUnit (light) with 16 process terminals (1...16) to the module and an additional 10 internally jumpered AUX terminals (1A to 10A); for starting a new load group (max. 10 A)	6AG1193-6BP20-7DA0	SIPLUS BaseUnits type B0 BU20-P12+A4+0B (Extended temperature range and exposure to media) BU type B0; BaseUnit (dark) with 12 process terminals (1...12) to the module and an additional 4 internally jumpered AUX terminals (1 A to 4 A); for continuing the load group; 1 unit	6AG1193-6BP20-7BB0
BU15-P16+A10+2B (Extended temperature range and exposure to media) BU type A0; BaseUnit (dark) with 16 process terminals (1...16) to the module and an additional 10 internally jumpered AUX terminals (1A to 10A); for continuing the load group	6AG1193-6BP20-7BA0	SIPLUS BaseUnits type B1 BU20-P12+A0+4B (Extended temperature range and exposure to media) BU type B1; BaseUnit (dark) with 12 process terminals to the module; for continuing the load group; 1 unit	6AG1193-6BP20-7BB1
SIPLUS BaseUnits type A1 (with temperature detection) BU15-P16+A0+2D/T (Extended temperature range and exposure to media) BU type A1; BaseUnit (light) with 16 process terminals to the module; for starting a new load group (max. 10 A)	6AG1193-6BP00-7DA1	SIPLUS BaseUnits type C0 BU20-P6+A2+4D (Extended temperature range and exposure to media) BU type C0; BaseUnit (light) with 6 push-in terminals (1...6) to the module and an additional 2 AUX terminals; new load group	6AG1193-6BP20-7DC0
BU15-P16+A0+2B/T (Extended temperature range and exposure to media) BU type A1; BaseUnit (dark) with 16 process terminals to the module; for continuing the load group	6AG1193-6BP00-7BA1	SIPLUS BaseUnits type D0 BU20-P12+A0+0B (Extended temperature range and exposure to media) BU type D0; BaseUnit (dark) with 12 push-in terminals, without AUX terminals, bridged to the left	6AG1193-6BP00-7BD0
		Accessories	See SIMATIC ET 200SP BaseUnits, page 9/142

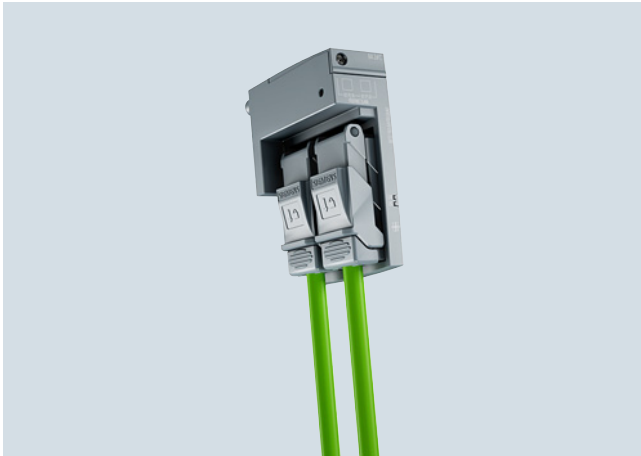
Overview

SIMATIC BA 2xFC BusAdapter for direct laying of the PROFINET cable via FastConnect connection



ET 200SP BA-Send BusAdapter for expansion of an ET 200SP station with ET 200AL modules



SIMATIC BA LC/RJ45 BusAdapter for use as a system-integrated media converter from copper (RJ45) to glass fiber (LC)

For the SIMATIC ET 200SP, two types of BusAdapter (BA) are available for selection:

- ET 200SP BA-Send BusAdapter for expansion of an ET 200SP station with up to 16 modules from the ET 200AL I/O series with IP67 protection via an ET connection
- SIMATIC BusAdapter for the free selection of the connection system (pluggable or direct connection) and physical PROFINET connection (copper, POF, HCS or glass fiber) to devices with a SIMATIC BusAdapter interface. One further advantage of the SIMATIC BusAdapter: only the adapter needs to be replaced for subsequent conversion to the rugged FastConnect technology or a fiber-optic connection, or to repair defective RJ45 sockets

I/O systems

SIMATIC ET 200 systems for the control cabinet

SIMATIC ET 200SP

BusAdapters**Technical specifications**

Article number	6ES7193-6AR00-0AA0 ET 200SP, BA 2XRJ45 BUSADAPTER	6ES7193-6AF00-0AA0 ET 200SP, BA 2XFC BUSADAPTER	6ES7193-6AP00-0AA0 ET 200SP, BA 2XSCRJ BUSADAPTER	6ES7193-6AP20-0AA0 ET 200SP, BA SCRJ/RJ45 BUSADAPTER
General information				
Product type designation	SIMATIC BusAdapter BA 2x RJ45	SIMATIC BusAdapter BA 2x FC	SIMATIC BusAdapter BA 2x SCRJ	SIMATIC BusAdapter BA SCRJ / RJ45
Interfaces				
Number of PROFINET interfaces	1	1	1; 2 ports (switch) SCRJ FO	1; 2 ports (SCRJ + RJ45)
PROFINET IO				
• RJ 45	Yes; 2 x		No	Yes; 1x
• FC (FastConnect)	No	Yes; 2 x	No	No
• Number of SCRJ ports	0		2	1
• Number of LC ports	0		0	0
Cable length				
- PCF			100 m	100 m
- Plastic FOC (POF)			50 m	50 m
- PCF-GI			250 m	250 m
- Cu conductors	100 m	100 m		100 m
Dimensions				
Width	20 mm	20 mm	20 mm	20 mm
Height	69.5 mm	69.5 mm	69.5 mm	
Depth	59 mm	59 mm	59 mm	
Weights				
Weight, approx.	46 g	53 g	50 g	50 g

Article number	6ES7193-6AP40-0AA0 ET 200SP, BA 2XSCRJ/FC BUSADAPTER	6ES7193-6AG00-0AA0 SIMATIC BA 2XLC BUSADAPTER	6ES7193-6AG20-0AA0 SIMATIC BA LC/RJ45 BUSADAPTER	6ES7193-6AG40-0AA0 SIMATIC BA 2XLC/FC BUSADAPTER
General information				
Product type designation	SIMATIC BusAdapter BA SCRJ / FC	SIMATIC BusAdapter BA 2x LC	SIMATIC BusAdapter BA LC / RJ45	SIMATIC BusAdapter BA LC / FC
Interfaces				
Number of PROFINET interfaces	1; 2 ports (SCRJ + FC)	1; 2 ports (switch) LC Multimode Glass Fibre	1; 2 ports (switch) LC / RJ45	1
PROFINET IO				
• RJ 45	No	No	Yes; 1x	No
• FC (FastConnect)	Yes; 1x	No	No	Yes; 1x
• Number of SCRJ ports	1	0	0	0
• Number of LC ports	0	2	1	1
Cable length				
- PCF	100 m			
- Plastic FOC (POF)	50 m			
- PCF-GI	250 m			
- Cu conductors	100 m		100 m	100 m
- Multimode graded-index fiber 50/125 µm		3 km	3 km	3 km
- Multimode graded-index fiber 62.5/125 µm		3 km	3 km	3 km
Ambient conditions				
Ambient temperature during operation				
• min.		0 °C	0 °C	0 °C
• max.		60 °C	60 °C	60 °C
Dimensions				
Width	20 mm	20 mm	20 mm	20 mm
Height	69.5 mm	69.5 mm	69.5 mm	69.5 mm
Depth	59 mm	59 mm	59 mm	59 mm
Weights				
Weight, approx.	50 g	40 g	32 g	50 g

Technical specifications (continued)		Ordering data	Article No.
Article number	6ES7193-6AS00-0AA0 ET 200SP, BA-SEND BA1XFC BUSADAPTER	BA 2xRJ45 BusAdapter For IM 155-6PN ST, HF	6ES7193-6AR00-0AA0
General information		BA 2xFC BusAdapter For IM 155-6PN ST, HF; for increased resistance to vibration and EMC loads	6ES7193-6AF00-0AA0
Product type designation	BusAdapter BA-Send 1x FC	BA 2xSCRJ BusAdapter For IM 155-6PN HF; fiber-optic connection for POF or PCF cables up to 250 m, with monitoring of damping	6ES7193-6AP00-0AA0
Interfaces		BA SCRJ/RJ45 BusAdapter For IM 155-6PN HF; with media converter FOC-Cu; 1 x SCRJ FO connection, 1 x RJ45 connection	6ES7193-6AP20-0AA0
PROFINET IO		BA SCRJ/FC BusAdapter For IM 155-6PN HF; with media converter FOC-Cu; 1 x SCRJ FO connection, 1 x FastConnect connection	6ES7193-6AP40-0AA0
Cable length		BA 2XLC BusAdapter For IM 155-6PN HF; 2 glass FO connections	6ES7193-6AG00-0AA0
- Cu conductors	15 m; from IM firmware V3.3: between BA-send and the first ET-CONNECTION bus node and between all other bus nodes	BA LC/RJ45 BusAdapter For IM 155-6PN HF; with media converter glass FO - copper; 1 x LC connection, 1 x RJ45 connection	6ES7193-6AG20-0AA0
ET-Connection		BA LC/FC BusAdapter For IM 155-6PN HF; with media converter glass FO - copper; 1 x LC connection, 1 x FastConnect connection	6ES7193-6AG40-0AA0
• Number of interfaces ET connection	1	Station expansion with IP67 I/O system ET 200AL	
• FC (FastConnect)	Yes	ET 200SP BA-Send 1 x FC BusAdapter	6ES7193-6AS00-0AA0
Ambient conditions		BaseUnit BU-Send	6ES7193-6BN00-0NE0
Ambient temperature during operation		Accessories	
• min.	0 °C	Equipment labeling plate	6ES7193-6LF30-0AW0
• max.	60 °C	10 sheets of 16 labels, for printing with thermal transfer card printer or plotter	
Dimensions			
Width	20 mm		
Weights			
Weight, approx.	44 g		

I/O systems

SIMATIC ET 200 systems for the control cabinet
SIMATIC ET 200SP

SIPLUS BusAdapters

Overview



ET 200SP BusAdapter (RJ45)



BA 2xFC BusAdapter

Some interface modules of the SIPLUS ET 200SP have a universal PROFINET interface for BusAdapters. With the appropriate BusAdapter, the type of connection can be adapted to the requirements of the respective application:

- For standard applications with a moderate mechanical and EMC load, the BA 2xRJ45 BusAdapter is used. It offers two sockets for standard RJ45 plugs.
- For machines and systems in which higher mechanical and/or EMC loads act on the devices, the BA 2xFC BusAdapter is recommended. In this case, the bus cables are connected directly by means of FastConnect terminals – similar to the PROFIBUS connector, proven in millions of applications. The technology is extremely quick to assemble and achieves 5 times better vibration resistance and also 5 times greater resistance to electromagnetic interference, when compared to RJ45 plug connectors.
- BusAdapters with connections for fiber-optic cables can be used to cover high potential differences between two stations and/or high EMC loads.

Another advantage of the BusAdapters: In order to repair defective RJ45 sockets or for subsequent conversion to the rugged FastConnect technology or a fiber-optic connection, only the adapter needs to be replaced.

The following interface modules offer a PROFINET connection via BusAdapter:

- SIPLUS IM 155-6PN Standard
- SIPLUS IM 155-6PN High Feature

Note

SIPLUS extreme products are based on SIMATIC standard products. The contents listed here were taken from the respective standard products. SIPLUS extreme-specific information was added.

Technical specifications

Article number	6AG1193-6AR00-7AA0	6AG1193-6AF00-7AA0	6AG1193-6AP00-2AA0
Based on	6ES7193-6AR00-0AA0 SIPLUS ET 200SP BA 2xRJ45	6ES7193-6AF00-0AA0 SIPLUS ET 200SP BA 2XFC PN	6ES7193-6AP00-0AA0 SIPLUS ET 200SP BA 2XSCRJ PN
Ambient conditions			
Ambient temperature during operation			
• min.	-40 °C; = Tmin; Startup @ -25 °C	-40 °C; = Tmin; Startup @ -25 °C	-40 °C; = Tmin; Startup @ -25 °C
• max.	70 °C; = Tmax	70 °C; = Tmax	60 °C; = Tmax
Extended ambient conditions			
• relative to ambient temperature-atmospheric pressure-installation altitude	Tmin ... Tmax at 1080 hPa ... 795 hPa (-1000 m ... +2000 m) // Tmin ... (Tmax - 10K) at 795 hPa ... 658 hPa (+2000 m ... +3500 m) // Tmin ... (Tmax - 20K) at 658 hPa ... 540 hPa (+3500 m ... +5000 m)	Tmin ... Tmax at 1080 hPa ... 795 hPa (-1000 m ... +2000 m) // Tmin ... (Tmax - 10K) at 795 hPa ... 658 hPa (+2000 m ... +3500 m) // Tmin ... (Tmax - 20K) at 658 hPa ... 540 hPa (+3500 m ... +5000 m)	Tmin ... Tmax at 1080 hPa ... 795 hPa (-1000 m ... +2000 m) // Tmin ... (Tmax - 10K) at 795 hPa ... 658 hPa (+2000 m ... +3500 m) // Tmin ... (Tmax - 20K) at 658 hPa ... 540 hPa (+3500 m ... +5000 m)
Relative humidity			
- With condensation, tested in accordance with IEC 60068-2-38, max.	100 %; RH incl. condensation/frost (no commissioning under condensation conditions)	100 %; RH incl. condensation/frost (no commissioning under condensation conditions)	100 %; RH incl. condensation/frost (no commissioning under condensation conditions)
Resistance			
- against biologically active substances / conformity with EN 60721-3-3	Yes; Class 3B2 mold, fungus and dry rot spores (with the exception of fauna). The supplied connector covers must remain on the unused interfaces during operation!	Yes; Class 3B2 mold, fungus and dry rot spores (with the exception of fauna). The supplied connector covers must remain on the unused interfaces during operation!	Yes; Class 3B2 mold, fungus and dry rot spores (with the exception of fauna). The supplied connector covers must remain on the unused interfaces during operation!
- against chemically active substances / conformity with EN 60721-3-3	Yes; Class 3C4 (RH < 75%) incl. salt spray according to EN 60068-2-52 (degree of severity 3). The supplied connector covers must remain on the unused interfaces during operation!	Yes; Class 3C4 (RH < 75%) incl. salt spray according to EN 60068-2-52 (degree of severity 3). The supplied connector covers must remain on the unused interfaces during operation!	Yes; Class 3C4 (RH < 75%) incl. salt spray according to EN 60068-2-52 (degree of severity 3). The supplied connector covers must remain on the unused interfaces during operation!
- against mechanically active substances / conformity with EN 60721-3-3	Yes; Class 3S4 incl. sand, dust. The supplied connector covers must remain on the unused interfaces during operation!	Yes; Class 3S4 incl. sand, dust. The supplied connector covers must remain on the unused interfaces during operation!	Yes; Class 3S4 incl. sand, dust. The supplied connector covers must remain on the unused interfaces during operation!

Ordering data

Ordering data	Article No.	Ordering data	Article No.
SIPLUS BA 2xRJ45 BusAdapter (Extended temperature range and exposure to media) for IM 155-6PN ST, HF	6AG1193-6AR00-7AA0	SIPLUS BA 2xSCRJ BusAdapter (Extended temperature range and exposure to media) for IM 155-6PN HF; fiber-optic connection for POF or PCF cables up to 250 m, with monitoring of damping	6AG1193-6AP00-2AA0
SIPLUS BA 2xFC BusAdapter (Extended temperature range and exposure to media) for IM 155-6PN ST, HF; for increased resistance to vibration and EMC loads	6AG1193-6AF00-7AA0	Reference identification label 10 sheets of 16 labels, for printing with thermal transfer card printer or plotter	6ES7193-6LF30-0AW0

I/O systems

SIMATIC ET 200 systems for the control cabinet
SIMATIC ET 200SP

Accessories

Overview Labeling strips

The head-end stations and I/O modules can optionally be equipped with labeling strips (13 x 31 mm) for system-specific marking. The labeling strips can be inscribed mechanically. Labeling strips are available in two versions in the colors light gray and yellow:

- 500 strips on the roll, for printing on thermal transfer printers. Core diameter 40 mm, external diameter 70 mm, width 62 mm
- 10 DIN A4 sheets with 100 strips each, 180 g/sm card, perforated, for printing using a laser printer direct from TIA Portal or via print templates

Overview Reference identification labels



Optionally, one equipment labeling plate each can be plugged onto head-end stations, BusAdapters, BaseUnits, and I/O modules. Equipment labeling plates are supplied in packs of 10 sheets with 16 labels each. The labels can be printed with thermal transfer card printers or plotters, or stickers can be attached to them. Advantages compared to labels that are attached directly:

- The inscription on the front is not covered
- Simple label replacement when replacing a module
- No parallax errors when marking the BaseUnits on the mounting plate

The size of the labels is 14.8 x 10.5 mm (W x H)

Overview BU cover

The ET 200SP system can be operated with any number of slot gaps (BU slot without inserted I/O module). Applications for this include:

- Partial commissioning
- Prewired but unequipped options

To protect against damage, such slot gaps must be covered by a BU cover.

Within the BU cover, an equipment labeling plate for identification of the I/O module planned for this slot can be stored.

Versions:

- For BaseUnits with a width of 15 mm (pack containing 5 BU covers)
- For BaseUnits with a width of 20 mm (pack containing 5 BU covers)

Overview Shield connection

The shield connection permits the low-cost connection of cable shields. Compared to external shield supports, the system offers the following advantages:

- Quick installation without tools by plugging the shield connection element onto the BaseUnit
- Automatic low-impedance connection to the functional ground (DIN rail)
- Optimized EMC properties by separating the signal lines from the voltage supply lines
- Short unshielded cable lengths
- Requires little space

Overview Color-coded labels

The I/O modules that are plugged onto the BaseUnits determine the potentials connected at the process terminals. The +/- potentials can optionally be identified using module-specific color-coded labels. The potentials of the AUX and add-on terminals can also be marked using color-coded labels. Advantages of the color-coded labels:

- Quick installation (one label for marking 16 terminals)
- Printed terminal numbers
- Avoidance of wiring errors
- Simple detection of potentials during servicing

Overview Server module

The server module is included in the scope of delivery of all head-end stations (interface module, CPU, Open Controller). It concludes the setup of an ET 200SP station.

Overview e-coding elements

The operation of selected modules requires an electronic coding element that is always included in the scope of delivery of the I/O module. Apart from the mechanical coding function, this contains a re-writable memory for the redundant storage of module-specific configuration data (e.g. F target address for fail-safe modules or parameter data in the case of the IO-Link master). In this way, this data is automatically backed up during a module replacement. This saves the user from having to set addresses manually or back up data when replacing modules.

At present, there are two types of electronic coding element:

- e-coding element (Type H), which can be used in the I/O modules:
 - CM IO-Link master
 - F-CM AS-i Safety
- e-coding element (Type F), which can be used in the I/O modules:
 - F-DI 8x24VDC HF
 - F-DQ 4x24VDC/2A PM HF
 - F-PM-E 24VDC/8A PPM ST

Ordering data	Article No.	Article No.
Labeling strips 500 labeling strips on roll, light gray, for inscription with thermal transfer roll printer 500 labeling strips on roll, yellow, for inscription with thermal transfer roll printer 1000 labeling strips DIN A4, light gray, card, for inscription with laser printer 1000 labeling strips DIN A4, yellow, card, for inscription with laser printer	6ES7193-6LR10-0AA0 6ES7193-6LR10-0AG0 6ES7193-6LA10-0AA0 6ES7193-6LA10-0AG0	Color code CC42, for 12 process terminals, BU type F0, gray (terminals 1 to 8), red (terminals 9 to 10), blue (terminals 11 to 12) Color code CC51, for 6 process terminals, for BU type C0, C1, gray (terminals 1 to 4), red (terminal 5), blue (terminal 6) Color code CC51, for 6 process terminals, for BU type C0, gray (terminals 1, 2 and 5), red (terminals 3 and 4), blue (terminal 6)
Equipment labeling plate 10 sheets of 16 labels	6ES7193-6LF30-0AW0	6ES7193-6CP42-2MB0
BU cover For covering empty slots (gaps); 5 units <ul style="list-style-type: none"> • 15 mm wide • 20 mm wide 	6ES7133-6CV15-1AM0 6ES7133-6CV20-1AM0	6ES7193-6CP51-2MC0
Shield connection 5 shield supports and 5 shield terminals each for plugging onto BaseUnits with automatic low-impedance connection to functional ground	6ES7193-6SC00-1AM0	6ES7193-6CP52-2MC0
Module-specific color-coded labels (pack containing 10 labels) Color code CC00, for 16 process terminals, for BU type A0, A1, gray (terminals 1 to 8), red (terminals 9 to 16) Color code CC01, for 16 process terminals, for BU type A0, A1, gray (terminals 1 to 8), red (terminals 9 to 16) Color code CC02, for 16 process terminals, for BU type A0, A1, gray (terminals 1 to 8), blue (terminals 9 to 16) Color code CC03, for 16 process terminals, for BU type A0, A1, gray (terminals 1 to 8), red (terminals 9 to 12), gray (terminals 13 to 16) Color code CC04, for 16 process terminals, BU type A0, A1, gray (terminals 1 to 8), red (terminals 9 to 12), blue (terminals 13 to 16) Color code CC05, for 16 process terminals, for BU type A0, A1, gray (terminals 1 to 12), red (terminals 13 to 14), blue (terminals 15 to 16) Color code CC41, for 16 process terminals; for BU type B1, gray (terminals 1 to 4), red (terminals 5 to 8), blue (terminals 9 to 12)	6ES7193-6CP00-2MA0 6ES7193-6CP01-2MA0 6ES7193-6CP02-2MA0 6ES7193-6CP03-2MA0 6ES7193-6CP04-2MA0 6ES7193-6CP05-2MA0 6ES7193-6CP41-2MB0	Color-coded labels for additional terminals (pack containing 10 labels) Color code CC71, for 10 AUX terminals, BU type A0, yellow/green (terminals 1 A to 10 A) Color code CC72, for 10 AUX terminals, BU type A0, red (terminals 1 A to 10 A) Color code CC73, for 10 AUX terminals, BU type A0, blue (terminals 1 A to 10 A) Color code CC74, for 2x5 additional terminals, BU type A1, red (terminals 1B to 5B), blue (terminals 1C to 5C) Color code CC81, for 4 AUX terminals, BU type B0, yellow/green (terminals 1 A to 4 A) Color code CC82, for 4 AUX terminals, BU type B0, red (terminals 1 A to 4 A) Color code CC83, for 4 AUX terminals, BU type B0, blue (terminals 1 A to 4 A) Color code CC84, for 2 AUX terminals, BU type C0, C1, yellow/green (1 A to 2 A) Color code CC85, for 2 AUX terminals, BU type C0, C1, red (1 A to 2 A) Color code CC86, for 2 AUX terminals, BU type C0, C1, blue (1 A to 2 A)
		6ES7193-6CP71-2AA0
		6ES7193-6CP72-2AA0
		6ES7193-6CP73-2AA0
		6ES7193-6CP74-2AA0
		6ES7193-6CP81-2AB0
		6ES7193-6CP82-2AB0
		6ES7193-6CP83-2AB0
		6ES7193-6CP84-2AC0
		6ES7193-6CP85-2AC0
		6ES7193-6CP86-2AC0
		6ES7193-6PA00-0AA0
		Spare parts
		e-coding element
		Type H; pack containing 5 e-coding elements
		Type F; pack containing 5 e-coding elements

I/O systems

SIMATIC ET 200 systems for the control cabinet

SIMATIC ET 200MP

Overview

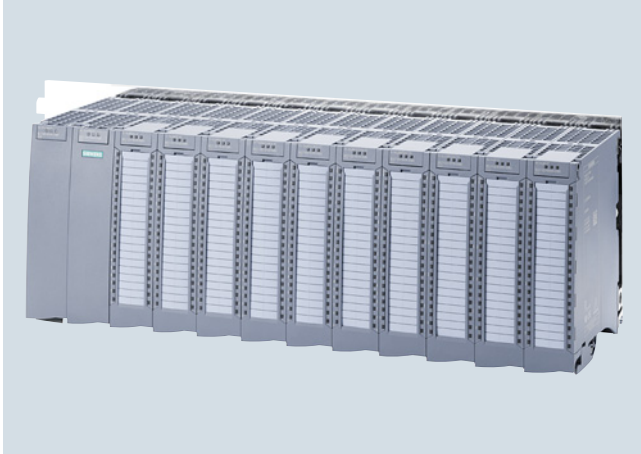

The SIMATIC ET 200MP is a modular and scalable I/O system with IP20 degree of protection for universal use, and offers the same system advantages as the S7-1500. The SIMATIC ET 200MP permits extremely short bus cycles and very fast response times, even with large quantity structures.

SIMATIC ET 200MP consists of the following components:

- Interface module for connecting S7-1500 I/O modules to PROFINET; up to 30 modules can be connected to one interface module
- Interface module for connecting S7-1500 I/O modules to PROFIBUS; up to 12 modules can be connected to one interface module

The SIMATIC ET 200MP distributed I/O system is particularly easy to install, wire, and commission.

Highlights:

- Modular I/O system with IP20 protection for PROFINET or alternatively for PROFIBUS
- Compact dimensions
- High degree of user-friendliness due to the following design features:
 - Uniform 40-pin front connector simplifies ordering, logistics, and warehousing
 - Uniform pin assignment per module type simplifies wiring and helps avoid errors
 - Integrated potential bridges simplify wiring and allow flexible subsequent modification
 - The cable storage space grows along with the requirements and allows a uniform appearance even with insulated conductors with a large cross-section and/or thick insulation
 - The pre-wiring position for the front connector allows convenient wiring both when commissioning and making changes during operation

- The top hat rail integrated in the S7-1500 DIN rail allows snapping-on of many standard components such as additional terminals, miniature circuit breakers or small relays
- The 1:1 allocation of channel status and diagnostics LED, terminal and inscription allows fast location and elimination of errors. Assistance is provided by the wiring diagram printed on the inside of the front panels
- The integrated shielding concept for analog and technology modules allows reliable and rugged operation, in particular with high-speed applications. Installation does not require any tools
- Particularly space-saving and simple design with slim 25 mm modules; the maximum possible station configuration with power supply (PS), interface module (IM) and 30 I/O modules can be accommodated on a 830-mm-wide S7-1500 DIN rail
- Comprehensive product portfolio comprising digital and analog input or output modules, technology modules, and communication modules for point-to-point communication; further modules, e.g. F modules, will be available soon
- Extensive system functions
 - Integrated system diagnostics when operated with an S7-1500 and the TIA portal
 - Increased communication availability by using Media Redundancy Protocol (MRP) on the PROFINET; in addition, the IM 155-5 PN HF High Feature interface module can be operated on an S7-400H. Configuration is carried out with STEP 7 V5.5 SP3 and a GSDML file. The IM 155-5 PN HF also supports operation on an S7-400H CPU (system redundancy)
 - Consistent use of identification and maintenance data IM0 to IM3 for fast electronic and unambiguous identification of individual modules (Article No., serial number, etc.)
 - Uniform firmware update for the interface module and all I/O modules for subsequent expansion of functions (investment security)
 - Bus cycle time $\geq 250 \mu\text{s}$ and coupling to the isochronous task permit implementation of applications with high performance requirements with PROFINET
 - Up to 30 I/O modules (PROFINET) or 12 I/O modules (PROFIBUS) within a station save on interface modules and installation time
 - MMC not required with PROFINET; automatic address assignment via LLDP or manually via TIA portal or PST tool
 - Shared device on up to two (IM 155-5 PN BA and IM 155-5 PN ST) or four (IM 155-5 PN HF) IO controllers
 - Module shared input / module shared output as system function for all S7-1500 I/O modules

Overview

- Interface modules for linking the ET 200MP to PROFINET
- These handle data exchange with the PROFINET IO controller in the PLC
- Integrated 2-port switch for line topology

IM 155-5 PN BA

- Max. 30 I/O modules
- Shortest bus cycle time 1 ms
- Media redundancy (MRP)
- Shared device on up to 2 IO controllers
- Omission of SIMATIC Memory Card (SMC); IM replacement without PG using LLDP

IM 155-5 PN ST, IM 155-5 PN HF

- Interface modules for linking the ET 200MP to PROFINET
- These handle data exchange with the PROFINET IO controller in the PLC
- Integrated 2-port switch for line topology
- Max. 30 I/O modules
- Shortest bus cycle 250 μ s
- Linking to the isochronous task of the CPU
- Prioritized fast startup (FSU) with max. 12 I/O modules
- Media Redundancy Protocol (MRP)
- Shared device on up to two I/O controllers (when configuring using GSD file; depends on the respective configuration tool)
- Omission of SIMATIC Memory Card (SMC); IM replacement without PG using LLDP
- Operation of F modules and PROFIsafe

Starting from FW version V2.0.0, the IM155-5 PN ST interface module supports the following new functions:

- Submodule-granular shared device with up to two I/O controllers
- Configuration control (option handling)
- Module shared input and module shared output (MSI/MSO), i.e. the inputs or outputs of a module can be made available simultaneously to up to two I/O controllers

The IM155-5 PN HF interface module has the following additional functions:

- Shared device on up to 4 IO controllers
- Module-internal shared input and output (MSI/MSO) on up to four IO controllers
- Operation on a highly available SIMATIC S7-400H
- Support for the MRPD function (media redundancy with planned duplication)

I/O systems

SIMATIC ET 200 systems for the control cabinet
SIMATIC ET 200MP

Interface modules > IM 155-5 PN**Overview** (continued)

	IM 155-5 PN BA	IM 155-5 PN ST	IM 155-5 PN HF
Article No.	6ES7155-5AA00-0AA0	6ES7155-5AA00-0AB0	6ES7155-5AA00-0AC0
Specifications			
I/O modules	All except PROFIsafe	All	All
Max. number I/O modules / IM	12	30	30
Max. number of bytes / slot	64 inputs 64 outputs	256 inputs 256 outputs	256 inputs 256 outputs
Max. number bytes / station	64 inputs 64 outputs	512 inputs 512 outputs	512 inputs 512 outputs
Update time	1 ms	250 µs	250 µs
Configuration			
GSDML	Yes	Yes	Yes
STEP 7	GSDML	GSDML	GSDML
TIA Portal	Yes	Yes	Yes
PCS 7	No	No	No
General functions			
Reset to factory settings	TIA Portal	TIA Portal	TIA Portal
Device replacement: without PG	LLDP	LLDP	LLDP
Configuration management (option handling)	No	Yes	Yes
I&M data	IM 0 ... 3	IM 0 ... 3	IM 0 ... 3
Isochronous mode	No	Yes	Yes
PROFIsafe	No	Yes	Yes
PROFINET functions			
RT	Yes	Yes	Yes
IRT	No	Yes	Yes
MRP	Yes	Yes	Yes
MRPD	No	No	No
S2 redundancy	No	No	Yes
Fast Startup	No	Yes	Yes
Shared device	Yes; up to 2 ctrl.	Yes; up to 2 ctrl.	Yes; up to 4 ctrl.
MSI / MSO	Yes	Yes	Yes
Submodules	Yes	Yes	Yes

Technical specifications

Article number	6ES7155-5AA00-0AA0 ET 200MP, IM 155-5 PN BA	6ES7155-5AA00-0AB0 ET 200MP, IM 155-5 PN ST	6ES7155-5AA00-0AC0 ET 200MP, IM 155-5 PN HF
General information			
Product type designation	IM 155-5 PN BA	IM 155-5 PN ST	IM 155-5 PN HF
Product function			
• I&M data	Yes; I&M0 to I&M3	Yes; I&M0 to I&M3	Yes; I&M0 to I&M3
Engineering with			
• STEP 7 TIA Portal configurable/ integrated as of version	V14 with HSP 0187	V13 / V13	V13 / V13
• STEP 7 configurable/integrated as of version	V5.5 SP3 / -	V5.5 SP3 / -	V5.5 SP3 / -
• PROFINET as of GSD version/ GSD revision	V2.3 / -	V2.3 / -	V2.3 / -
Supply voltage			
Type of supply voltage	DC	DC	DC
Rated value (DC)	24 V	24 V	24 V
Reverse polarity protection	Yes	Yes	Yes
Short-circuit protection	Yes	Yes	Yes
Mains buffering			
• Mains/voltage failure stored energy time	5 ms	5 ms	5 ms
Hardware configuration			
Integrated power supply	Yes	Yes	Yes
Rack			
• Modules per rack, max.	12; I/O modules	30; I/O modules	30; I/O modules
Submodules			
• Number of submodules per station, max.	108; 9 submodules / I/O modules		
Interfaces			
Number of PROFINET interfaces	1; 2 ports (switch) RJ45	1	1
1. Interface			
Interface types			
• Number of ports	2	2	2
• integrated switch	Yes	Yes	Yes
• RJ 45 (Ethernet)	Yes	Yes	Yes
• BusAdapter (PROFINET)	No		
Functionality			
• PROFINET IO Device	Yes	Yes	Yes
• Media redundancy	Yes	Yes; PROFINET MRP	Yes; PROFINET MRP
Interface types			
RJ 45 (Ethernet)			
• Transmission procedure	PROFINET with 100 Mbit/s full duplex (100BASE-TX)	PROFINET with 100 Mbit/s full duplex (100BASE-TX)	PROFINET with 100 Mbit/s full duplex (100BASE-TX)
• 100 Mbps	Yes	Yes	Yes
• Autonegotiation	Yes	Yes	Yes
• Autocrossing	Yes	Yes	Yes
PROFINET IO Device			
Services			
- Isochronous mode	No	Yes	Yes
- Open IE communication	Yes		
- IRT	No	Yes	Yes
- MRP	Yes	Yes	Yes
- MRPD	No	No	No
- PROFINET system redundancy	No	No	Yes
- PROFIenergy	No	No	No
- Prioritized startup	No	Yes	Yes
- Shared device	Yes	Yes	Yes
- Number of IO Controllers with shared device, max.	2	2	4

I/O systemsSIMATIC ET 200 systems for the control cabinet
SIMATIC ET 200MP**Interface modules > IM 155-5 PN****Technical specifications** (continued)

Article number	6ES7155-5AA00-0AA0 ET 200MP, IM 155-5 PN BA	6ES7155-5AA00-0AB0 ET 200MP, IM 155-5 PN ST	6ES7155-5AA00-0AC0 ET 200MP, IM 155-5 PN HF
Open IE communication			
• TCP/IP	Yes	Yes	Yes
• SNMP	Yes	Yes	Yes
• LLDP	Yes	Yes	Yes
Isochronous mode			
Isochronous operation (application synchronized up to terminal)	No	Yes	Yes
Equidistance	No	Yes	Yes
shortest clock pulse		250 µs	250 µs
max. cycle		4 ms	4 ms
Interrupts/diagnostics/ status information			
Status indicator	Yes	Yes	Yes
Alarms	Yes	Yes	Yes
Diagnostic functions	Yes	Yes	Yes
Diagnostics indication LED			
• RUN LED	Yes; Green LED	Yes; Green LED	Yes; Green LED
• ERROR LED	Yes; Red LED	Yes; Red LED	Yes; Red LED
• MAINT LED	Yes; yellow LED	Yes; yellow LED	Yes; yellow LED
• Connection display LINK TX/RX	Yes; 2x green-yellow LEDs	Yes; yellow LED	Yes; yellow LED
Isolation			
Isolation tested with	707 V DC (type test)	707 V DC (type test)	707 V DC (type test)
Standards, approvals, certificates			
Network loading class	2		
Ambient conditions			
Ambient temperature during operation			
• horizontal installation, min.	0 °C	0 °C	0 °C
• horizontal installation, max.	60 °C	60 °C	60 °C
• vertical installation, min.	0 °C	0 °C	0 °C
• vertical installation, max.	40 °C	40 °C	40 °C
Dimensions			
Width	35 mm	35 mm	35 mm
Height	147 mm	147 mm	147 mm
Depth	129 mm	129 mm	129 mm
Weights			
Weight, approx.	236 g	310 g	350 g

Ordering data	Article No.	Article No.
IM 155-5 PN interface module IP 20 degree of protection, module width 35 mm, installation on S7-1500 DIN rail IM 155-5 PN BA, Basic version IM 155-5 PN ST, Standard version IM 155-5 PN HF, High Feature version with additional functions	6ES7155-5AA00-0AA0 6ES7155-5AA00-0AB0 6ES7155-5AA00-0AC0	
Accessories		
Front flap for IM 155-5 PN (spare part), 5 units	6ES7528-0AA70-7AA0	
SIMATIC S7-1500 DIN rail Fixed lengths, with grounding elements <ul style="list-style-type: none"> • 160 mm • 245 mm • 482 mm • 530 mm • 830 mm For cutting to length by customer, without drill holes; grounding elements must be ordered separately <ul style="list-style-type: none"> • 2000 mm 	6ES7590-1AB60-0AA0 6ES7590-1AC40-0AA0 6ES7590-1AE80-0AA0 6ES7590-1AF30-0AA0 6ES7590-1AJ30-0AA0	
PE connection element for DIN rail 2000 mm	6ES7590-5AA00-0AA0	
20 units		
Power supply		
For supplying the backplane bus of the S7-1500		
24 V DC input voltage, power 25 W	6ES7505-0KA00-0AB0	
24/48/60 V DC input voltage, power 60 W	6ES7505-0RA00-0AB0	
24/48/60 V DC input voltage, power 60 W, buffering functionality	6ES7505-0RB00-0AB0	
120/230 V AC input voltage, power 60 W	6ES7507-0RA00-0AB0	
Power connector	6ES7590-8AA00-0AA0	
With coding element for power supply module; spare part, 10 units		
Load power supply		
24 V DC/3 A	6EP1332-4BA00	
24 V DC/8 A	6EP1333-4BA00	
Power supply connector		
Spare part; for connecting the 24 V DC supply voltage <ul style="list-style-type: none"> • with push-in terminals 	6ES7193-4JB00-0AA0	
		IE FC RJ45 plugs RJ45 plug connector for Industrial Ethernet with a rugged metal enclosure and integrated insulation displacement contacts for connecting Industrial Ethernet FC installation cables
		IE FC RJ45 Plug 180 180° cable outlet 1 unit 10 units 50 units
		6GK1901-1BB10-2AA0 6GK1901-1BB10-2AB0 6GK1901-1BB10-2AE0
		IE FC TP Standard Cable GP 2x2 4-core, shielded TP installation cable for connection to IE FC outlet RJ45/ IE FC RJ45 plug; PROFINET-compatible; with UL approval; Sold by the meter, max. length 1000 m; minimum order quantity 20 m
		6XV1840-2AH10
		IE FC TP Trailing Cable 2 x 2 (Type C) 4-core, shielded TP installation cable for connection to IE FC outlet RJ45/ IE FC RJ45 plug 180/90 for trailing cable use; PROFINET-compatible; with UL approval; Sold by the meter, max. length 1000 m; minimum order quantity 20 m
		6XV1840-3AH10
		IE FC TP Marine Cable 2 x 2 (Type B) 4-core, shielded TP installation cable for connection to IE FC outlet RJ45/ IE FC RJ45 Plug 180/90 marine certified; Sold by the meter, max. length 1000 m; minimum order quantity 20 m
		6XV1840-4AH10
		IE FC Stripping Tool Preadjusted stripping tool for fast stripping of Industrial Ethernet FC cables
		6GK1901-1GA00

I/O systems

SIMATIC ET 200 systems for the control cabinet
SIMATIC ET 200MP

Interface modules > IM 155-5 DP**Overview**

- Interface module for linking the ET 200MP to PROFIBUS
- Handles data exchange with the PROFIBUS master in the PLC
- Max. 12 I/O modules
- Automatic detection of baud rate 9.6 kBd ... 12 MBd
- PROFIBUS addresses 1 ... 125; adjustable using DIP switches
- Identification and maintenance data IM0 ... IM3

Technical specifications

Article number	6ES7155-5BA00-0AB0 ET 200MP, IM155-5 DP ST
General information	
Product type designation	IM 155-5 DP ST
Product function	
• I&M data	Yes; I&M0 to I&M3
Engineering with	
• STEP 7 TIA Portal configurable/ integrated as of version	V13 / V13
• STEP 7 configurable/integrated as of version	V5.5 SP3 / -
• PROFIBUS as of GSD version/ GSD revision	V1.0 / V5.1
Supply voltage	
Type of supply voltage	DC
Rated value (DC)	24 V
Reverse polarity protection	Yes
Short-circuit protection	Yes
Mains buffering	
• Mains/voltage failure stored energy time	5 ms
Hardware configuration	
Integrated power supply	Yes
Rack	
• Modules per rack, max.	12; I/O modules
Interfaces	
Number of PROFIBUS interfaces	1
1. Interface	
Interface types	
• RS 485	Yes
Functionality	
• PROFIBUS DP slave	Yes
RS 485	
• Transmission rate, max.	12 Mbit/s

Article number	6ES7155-5BA00-0AB0 ET 200MP, IM155-5 DP ST
PROFIBUS	
Services	
- SYNC capability	Yes
- FREEZE capability	Yes
- DPV1	Yes
Isochronous mode	
Isochronous operation (application synchronized up to terminal)	No
Interrupts/diagnostics/ status information	
Status indicator	Yes
Alarms	Yes
Diagnostic functions	Yes
Diagnostics indication LED	
• RUN LED	Yes; Green LED
• ERROR LED	Yes; Red LED
• MAINT LED	Yes; yellow LED
• Connection display DP	Yes; Green LED
Isolation	
Isolation tested with	707 V DC (type test)
Ambient conditions	
Ambient temperature during operation	
• horizontal installation, min.	0 °C
• horizontal installation, max.	60 °C
• vertical installation, min.	0 °C
• vertical installation, max.	40 °C
Dimensions	
Width	35 mm
Height	147 mm
Depth	129 mm
Weights	
Weight, approx.	360 g

Ordering data	Article No.	Article No.
IM 155-5 DP ST interface module IP 20 degree of protection, module width 35 mm, installation on S7-1500 DIN rail	6ES7155-5BA00-0AB0	
Accessories		
Front flap for IM 155-5 PN (spare part), 5 units	6ES7528-0AA70-7AA0	
SIMATIC S7-1500 DIN rail Fixed lengths, with grounding elements <ul style="list-style-type: none"> • 160 mm • 245 mm • 482 mm • 530 mm • 830 mm For cutting to length by customer, without drill holes; grounding elements must be ordered separately <ul style="list-style-type: none"> • 2000 mm 	6ES7590-1AB60-0AA0 6ES7590-1AC40-0AA0 6ES7590-1AE80-0AA0 6ES7590-1AF30-0AA0 6ES7590-1AJ30-0AA0	
PE connection element for DIN rail 2000 mm 20 units	6ES7590-5AA00-0AA0	
Load power supply 24 V DC/3 A 24 V DC/8 A	6EP1332-4BA00 6EP1333-4BA00	
Power supply connector Spare part; for connecting the 24 V DC supply voltage <ul style="list-style-type: none"> • with push-in terminals 	6ES7193-4JB00-0AA0	
PROFIBUS connector <ul style="list-style-type: none"> • Connector for PROFIBUS, up to 12 Mbps, 90° cable outlet, insulation displacement system, without PG socket • Connector for PROFIBUS, up to 12 Mbps, 90° cable outlet, insulation displacement system, with PG socket 	6ES7972-0BA70-0XA0 6ES7972-0BB70-0XA0	
PROFIBUS Stripping Tool Stripping tool for fast stripping of the PROFIBUS	6GK1905-6AA00	
PROFIBUS FastConnect bus cable <ul style="list-style-type: none"> • Standard type with special design for quick mounting, 2-core, shielded, sold by the meter, max. delivery unit 1000 m, minimum order quantity 20 m • 20 m • 50 m • 100 m • 200 m • 500 m • 1000 m 	6XV1830-0EH10 6XV1830-0EN20 6XV1830-0EN50 6XV1830-0ET10 6XV1830-0ET20 6XV1830-0ET50 6XV1830-0EU10	
		FC robust cable Bus cable with PUR sheath for use under conditions of extreme mechanical stress or aggressive chemicals, 2-core, shielded, sold by the meter, max. delivery unit 1,000 m, minimum order quantity 20 m
		6XV1830-0JH10
		FC flexible cable PROFIBUS bus cable, flexible, with special design for quick mounting, 2-core, shielded, sold by the meter, max. delivery unit 1000 m, minimum order quantity 20 m
		6XV1831-2K
		FC trailing cable PROFIBUS trailing cable, at least 3 million bending cycles, min. bending radius approx. 120 mm, 2-core, shielded, sold by the meter, max. delivery unit 1000 m, minimum order quantity 20 m
		6XV1830-3EH10
		FC bus cable PROFIBUS Food bus cable with PE sheath for use in the food and beverages industry, 2-core, shielded, sold by the meter, max. delivery unit 1,000 m, minimum order quantity 20 m
		6XV1830-0GH10
		FC underground cable PROFIBUS underground cable, 2-core, shielded, sold by the meter, max. delivery unit 1,000 m, minimum order quantity 20 m
		6XV1830-3FH10
		FC FRNC cable PROFIBUS bus cable, flame-retardant and halogen-free, with copolymer sheath FRNC, sold by the meter, max. delivery unit 1000 m, minimum order quantity 20 m
		6XV1830-0LH10
		FC trailing cable PROFIBUS trailing cable, at least 3 million bending cycles, min. bending radius approx. 120 mm, 2-core, shielded, sold by the meter, max. delivery unit 1000 m, minimum order quantity 20 m
		6XV1831-2L
		IE FC Stripping Tool Preadjusted stripping tool for fast stripping of Industrial Ethernet FC cables
		6GK1901-1GA00

I/O systems

SIMATIC ET 200 systems for the control cabinet
SIMATIC ET 200MP

Interface modules > SIPLUS IM 155-5 PN

Overview

- Interface module for linking the ET 200MP to PROFINET
- Handles data exchange with the PROFINET IO controller in the PLC
- Integrated 2-port switch for line topology
- Max. 30 I/O modules
- Shortest bus cycle 250 µs
- Linking to the isochronous task of the CPU
- Prioritized fast startup (FSU) with 500 ms (max. 12 I/O modules)
- Media Redundancy Protocol (MRP)
- Shared device on up to two I/O controllers (when configuring using GSD file; depends on the respective configuration tool)
- Omission of SIMATIC Memory Card (SMC); IM replacement without PG using LLDP

Note:

SIPLUS extreme products are based on SIMATIC standard products. The contents listed here were taken from the respective standard products. SIPLUS extreme-specific information was added.

Technical specifications

Article number	6AG1155-5AA00-7AB0
Based on	6ES7155-5AA00-0AB0 SIPLUS ET 200MP IM 155-5 PN ST
Extended ambient conditions	
<ul style="list-style-type: none"> • relative to ambient temperature-atmospheric pressure-installation altitude 	Tmin ... Tmax at 1080 hPa ... 795 hPa (-1000 m ... +2000 m) // Tmin ... (Tmax - 10K) at 795 hPa ... 658 hPa (+2000 m ... +3500 m) // Tmin ... (Tmax - 20K) at 658 hPa ... 540 hPa (+3500 m ... +5000 m)
Relative humidity	
<ul style="list-style-type: none"> - With condensation, tested in accordance with IEC 60068-2-38, max. 	100 %; RH incl. condensation/frost (no commissioning under condensation conditions)
Resistance	
<ul style="list-style-type: none"> - against biologically active substances / conformity with EN 60721-3-3 - against chemically active substances / conformity with EN 60721-3-3 - against mechanically active substances / conformity with EN 60721-3-3 	Yes; Class 3B2 mold, fungus and dry rot spores (with the exception of fauna). The supplied connector covers must remain on the unused interfaces during operation! Yes; Class 3C4 (RH < 75%) incl. salt spray according to EN 60068-2-52 (degree of severity 3). The supplied connector covers must remain on the unused interfaces during operation! Yes; Class 3S4 incl. sand, dust. The supplied connector covers must remain on the unused interfaces during operation!

Ordering data**SIPLUS IM 155-5 PN interface module**

(Extended temperature range and exposure to media)

IP 20 degree of protection, module width 35 mm, installation on S7-1500 rail

Accessories**Article No.**

6AG1155-5AA00-7AB0

See SIMATIC ET 200MP, IM 155-5 PN interface module, page 9/159

Overview

I/O modules constitute the interface of the SIMATIC ET 200MP to the process:

- Digital and analog modules provide exactly the inputs/outputs required for each task
- Technology modules for SIMATIC S7-1500 and ET 200MP
 - With integrated functions for high-speed counting and position detection
 - With integrated inputs and outputs for tasks at the process level and short response times
- Communication modules for SIMATIC S7-1500 and ET 200MP
 - For data exchange using point-to-point coupling
 - For connecting to PROFIBUS
 - For connecting to Industrial Ethernet
- Connection system for user-friendly, low-overhead wiring of the S7-1500 and ET 200MP modules

For further information, see SIMATIC S7-1500, chapter 4.

I/O systems

SIMATIC ET 200 systems for the control cabinet

SIMATIC ET 200M

Overview

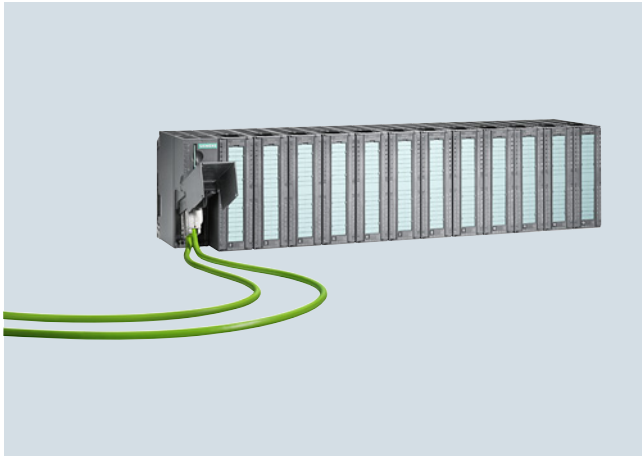

- Modular I/O system with IP20 degree of protection, particularly suitable for user-specific and complex automation tasks
- Consists of a PROFIBUS DP or PROFINET interface module IM 153, up to 8 or 12 I/O modules of the S7-300 automation system (structure with bus connection or with active bus modules), and a power supply if applicable
- Can be expanded with S7-300 automation system signal, communication and function modules
- Applicable Ex analog input or output modules with HART optimize the ET 200M for use in process engineering
- Can be used in redundant systems (S7-400H, S7-400F/FH)
- Modules can be replaced during operation (hot swapping) with the bus modules active
- Transmission rates up to 12 Mbps
- Ex approval to Cat. 3 for Zone 2 acc. to ATEX100a
- Fail-safe digital inputs/outputs as well as analog inputs for safety-oriented signal processing in accordance with PROFIsafe
- Supports modules with expanded user data, e.g. HART modules with HART minor variables

Technical specifications

General technical data ET 200M	
Cables and connections	Screw and spring-loaded connections in permanent wiring
Degree of protection	IP20
Ambient temperature on vertical wall (preferred mounting position)	<ul style="list-style-type: none"> • with horizontal assembly 0 to +60 °C • with other assembly 0 to +40 °C
Relative humidity	5 to 95% (RH stress level 2 according to IEC 1131-2)
Atmospheric pressure	795 to 1080 hPa
Mechanical stress	
• Vibrations	IEC 68, parts 2 – 6: 10 - 57 Hz (const. amplitude 0.075 mm) 57 - 150 Hz (constant acceleration 1 g)
• Shock	IEC 68, parts 2 – 27 half-sine, 15 g, 11 ms

Overview



The ET 200M system with various interface modules is available for the distributed use of S7-300 I/O modules. Depending on the application purpose, the best suited IM in terms of costs and functions can be selected:

IM153-1 Standard

The IM153-1 is one reasonably priced variant that is excellently suited for most applications in the manufacturing environment. It permits the use of up to 8 S7-300 I/O modules.

IM153-2 High Feature

For higher requirements in manufacturing technology, such as the use of F technology or the highest performance in conjunction with clock synchronization, the IM153-2 High Feature is available. This IM is also designed for use with the PCS 7 in the field of process-oriented applications. This IM can be redundantly used and supports typical functions as they are required in the control field. These include, for example, clock synchronization or time stamping with an accuracy of up to 1 ms.

Technical specifications

Article number	6ES7153-1AA03-0XB0 ET 200M, INTERFACE MODULE IM153-1	6ES7153-2BA10-0XB0 ET 200M, INTERFACE IM153-2 HF	6ES7153-2BA70-0XB0 ET 200M, INTERFACE IM153-2 HF OUTDOOR
General information			
Product type designation	IM 153-1 DP ST	IM 153-2 DP HF	
Supply voltage			
Rated value (DC)	24 V	24 V	
• 24 V DC	Yes	Yes	Yes
permissible range (ripple included), lower limit (DC)	20.4 V	20.4 V	20.4 V
permissible range (ripple included), upper limit (DC)	28.8 V	28.8 V	28.8 V
external protection for power supply lines (recommendation)	not necessary	2,5 A	2,5 A
Mains buffering			
• Mains/voltage failure stored energy time	5 ms	5 ms	5 ms
Input current			
Current consumption, max.	350 mA; at 24 V DC	650 mA; with 24 V DC supply	650 mA
Inrush current, typ.	2.5 A	3 A	3 A
I^2t	0.1 A ² ·s	0.1 A ² ·s	0.1 A ² ·s
Output voltage			
Rated value (DC)	5 V		
Output current			
for backplane bus (5 V DC), max.	1 A	1.5 A	1.5 A
Power loss			
Power loss, typ.	3 W	5.5 W	5.5 W
Address area			
Addressing volume			
• Inputs	128 byte	244 byte	244 byte
• Outputs	128 byte	244 byte	244 byte
Hardware configuration			
Number of modules per DP slave interface, max.	8	12	12

I/O systemsSIMATIC ET 200 systems for the control cabinet
SIMATIC ET 200M

Interface modules > IM 153-1/153-2

Technical specifications (continued)

Article number	6ES7153-1AA03-0XB0 ET 200M, INTERFACE MODULE IM153-1	6ES7153-2BA10-0XB0 ET 200M, INTERFACE IM153-2 HF	6ES7153-2BA70-0XB0 ET 200M, INTERFACE IM153-2 HF OUTDOOR
Time stamping			
Accuracy		1 ms; 1ms at up to 8 modules; 10ms at up to 12 modules	1 ms; 1ms at up to 8 modules; 10ms at up to 12 modules
Number of message buffers		15	15
Messages per message buffer		20	20
Number of stampable digital inputs, max.		128; Max. 128 signals/station; max. 32 signals/slot	128; Max. 128 signals/station; max. 32 signals/slot
Time format		RFC 1119	RFC 1119
Time resolution		0.466 ns	0.466 ns
Time interval for transmitting the message buffer if a message is present		1 000 ms	1 000 ms
Time stamp on signal change		rising / falling edge as signal entering or exiting	rising / falling edge as signal entering or exiting
Interfaces			
Interface physics, RS 485	Yes	Yes	Yes
Interface physics, FOC	No	No	No
PROFIBUS DP			
• Node addresses	1 to 125 permitted	1 to 125 permitted	1 to 125 permitted
• automatic detection of transmission rate	Yes	Yes	Yes
• Output current, max.	90 mA	70 mA	70 mA
• Transmission rate, max.	12 Mbit/s	12 Mbit/s	12 Mbit/s
• Transmission procedure	RS 485	RS 485	RS 485
• SYNC capability	Yes	Yes	Yes
• FREEZE capability	Yes	Yes	Yes
• Direct data exchange (slave-to-slave communication)	Yes; Sender	Yes; as publisher with all IO, as subscriber with F-IO only	Yes; as publisher with all IO, as subscriber with F-IO only
• Connector type	9-pin sub D socket	9-pin sub D	9-pin sub D
1. Interface			
DP slave			
• GSD file	(for DPV1) SIEM801D.GSD; SI01801D.GSG	SI05801E.GSG	SI05801E.GSG
• automatic baud rate search	Yes	Yes	Yes
Protocols			
Bus protocol/transmission protocol	PROFIBUS DP to EN 50170	PROFIBUS DP to EN 50170	PROFIBUS DP to EN 50170
Isolation			
Isolation tested with	Isolation voltage 500 V	Isolation voltage 500 V	Isolation voltage 500 V
Degree and class of protection			
Degree of protection acc. to EN 60529			
• IP20	Yes	Yes	Yes
Ambient conditions			
Ambient temperature during operation			
• min.	0 °C	0 °C	
• max.	60 °C	60 °C	
Air pressure acc. to IEC 60068-2-13			
• Installation altitude above sea level, max.	3 000 m	3 000 m	3 000 m
Configuration			
Configuration software			
• STEP 7	STEP 7 / COM PROFIBUS / non-Siemens tools via GSD file	Yes; STEP 7 / COM PROFIBUS / non-Siemens tools via GSD file	Yes; STEP 7 / COM PROFIBUS / non-Siemens tools via GSD file
Dimensions			
Width	40 mm	40 mm	40 mm
Height	125 mm	125 mm	125 mm
Depth	117 mm	117 mm	117 mm
Weights			
Weight, approx.	360 g	360 g	360 g

Technical specifications (continued)

Article number	6ES7195-7HD10-0XA0 ET 200M, BUS UNIT F. 2 IM 153-2 RED.		
Accessories			
belongs to product	ET 200M		
Dimensions			
Width	97 mm		
Height	92 mm		
Depth	30 mm		
Weights			
Weight, approx.	133 g		
Article number	6ES7195-7HA00-0XA0 ET 200M, BUS UNIT F. PS AND IM 153	6ES7195-7HB00-0XA0 ET 200M, BUS UNIT F. 2 40MM I/O MODULES	6ES7195-7HC00-0XA0 ET 200M, BUS UNIT F. 1 80MM I/O MODULE
Accessories			
belongs to product	ET 200M	ET 200M	ET 200M
Dimensions			
Width	97 mm	97 mm; 80 mm when installed	97 mm; 80 mm when installed
Height	92 mm	92 mm	92 mm
Depth	30 mm	30 mm	30 mm
Weights			
Weight, approx.	111 g	140 g	127 g

Ordering data

Ordering data	Article No.	Ordering data	Article No.
IM 153-1 interface module Slave interface for connecting an ET 200M to PROFIBUS DP • Standard temperature range	6ES7153-1AA03-0XB0	SIMATIC S7-300 DIN rail • Length: 160 mm • Length: 480 mm (19") • Length: 530 mm • Length: 830 mm • Length: 2000 mm	6ES7390-1AB60-0AA0 6ES7390-1AE80-0AA0 6ES7390-1AF30-0AA0 6ES7390-1AJ30-0AA0 6ES7390-1BC00-0AA0
IM 153-2 interface module Slave interface for connecting an ET 200M to PROFIBUS DP; also for use in redundant systems • High Feature • High Feature with extended temperature range	6ES7153-2BA10-0XB0 6ES7153-2BA70-0XB0	PROFIBUS bus connector 90° outgoing cable, terminating resistor with disconnecting function, up to 12 Mbps, FastConnect Without PG interface • 1 unit • 100 units With PG interface • 1 unit • 100 units	6ES7972-0BA52-0XA0 6ES7972-0BA52-0XB0 6ES7972-0BB52-0XA0 6ES7972-0BB52-0XB0
Active IM 153/IM 153 bus module For two IM 153-2 High Feature modules for designing redundant systems	6ES7195-7HD10-0XA0	S7 Manual Collection Electronic manuals on DVD, multi-language: S7-200, TD 200, S7-300, M7-300, C7, S7-400, M7-400, STEP 7, Engineering Tools, Runtime Software, SIMATIC DP (Distributed I/O), SIMATIC HMI (Human Machine Interface), SIMATIC NET (Industrial Communication)	6ES7998-8XC01-8YE0
Bus module for ET 200M • For accommodating a power supply and an IM 153 module for the hot-swapping function during RUN, incl. bus module cover • For accommodating two 40-mm-wide I/O modules for the hot-swapping function • For accommodating one 80-mm-wide I/O module for the hot-swapping function	6ES7195-7HA00-0XA0 6ES7195-7HB00-0XA0 6ES7195-7HC00-0XA0	S7 Manual Collection update service for 1 year Scope of delivery: Current DVD "S7 Manual Collection" and the three subsequent updates	6ES7998-8XC01-8YE2
ET 200M redundancy bundle Comprising two IM 153-2 High Feature modules and one IM 153/IM 153 bus module	6ES7153-2AR04-0XA0		
Accessories			
SIMATIC DP DIN rail for ET 200M Accommodates up to 5 bus modules; for hot-swapping function • Length: 483 mm (19") • Length: 530 mm • Length: 620 mm • Length: 2000 mm	6ES7195-1GA00-0XA0 6ES7195-1GF30-0XA0 6ES7195-1GG30-0XA0 6ES7195-1GC00-0XA0		

I/O systems

SIMATIC ET 200 systems for the control cabinet
SIMATIC ET 200M

Interface modules > IM 153-4 PN

Overview



- For connecting ET 200M to PROFINET IO (via copper line, RJ45) as an IO device
- 2 versions:
 - IM 153-4 PN Standard
 - IM 153-4 PN High Feature: supports, in contrast to the STANDARD version, the operation of PROFI-safe F and HART modules. The operation of an S7-400H (system redundancy) is likewise possible
- Integrated 2-port switch
- 12 modules per station
- Usable I/O capacity: 192 bytes each
- Active bus backplane to hot-swap modules available as an option
- Baud rate 10 Mbps / 100 Mbps (autonegotiation / full duplex)
- I&M functions according to PNO Guideline Order No. 3.502, Version V1.1

Note:

Micro Memory Card with at least 64 KB required if not all the stations in the network support LLDP (Link Layer Discovery Protocol; proximity detection).

Technical specifications

Article number	6ES7153-4AA01-0XB0 IM153-4 PN IO FOR 12 MODULES S7-300	6ES7153-4BA00-0XB0 IM153-4 PN IO HF FOR 12 MODULES S7-300
General information		
Product type designation	IM 153-4 PN ST	IM 153-4 PN HF
Supply voltage		
Rated value (DC)	24 V	24 V
• 24 V DC	Yes	Yes
permissible range (ripple included), lower limit (DC)	20.4 V	18.5 V
permissible range (ripple included), upper limit (DC)	28.8 V	30.2 V
external protection for power supply lines (recommendation)	In a construction with grounded reference potential, a fuse is necessary for redundant interface modules (Recommendation: 2.5 A)	In a construction with grounded reference potential, a fuse is necessary for redundant interface modules (Recommendation: 2.5 A)
Mains buffering		
• Mains/voltage failure stored energy time	5 ms	5 ms
Input current		
Current consumption, max.	600 mA; with 24 V DC supply	600 mA; with 24 V DC supply
Inrush current, typ.	4 A	4 A
I ² t	0.09 A ² ·s	0.09 A ² ·s
Output voltage		
Rated value (DC)	5 V	5 V
Output current		
for backplane bus (5 V DC), max.	1.5 A	1.5 A
Power loss		
Power loss, typ.	6 W	6 W
Address area		
Addressing volume		
• Inputs	192 byte	672 byte; Extended HART user data
• Outputs	192 byte	192 byte
Hardware configuration		
Number of modules per DP slave interface, max.	12	12

Technical specifications (continued)

Article number	6ES7153-4AA01-0XB0 IM153-4 PN IO FOR 12 MODULES S7-300	6ES7153-4BA00-0XB0 IM153-4 PN IO HF FOR 12 MODULES S7-300
Protocols		
Bus protocol/transmission protocol	PROFINET IO	PROFINET IO
Interrupts/diagnostics/ status information		
Diagnostics indication LED		
• Connection to network LINK (green)	Yes	Yes
• Transmit/receive RX/TX (yellow)	Yes	Yes
Isolation		
Isolation tested with	500 V DC	Between PROFINET and 24 V supply: 1 500 V AC, between functional grounding and 24 V supply: 500 V DC
Degree and class of protection		
Degree of protection acc. to EN 60529		
• IP20	Yes	Yes
Ambient conditions		
Ambient temperature during operation		
• min.	0 °C	0 °C
• max.	60 °C	60 °C
Air pressure acc. to IEC 60068-2-13		
• Installation altitude above sea level, max.	2 000 m	2 000 m
Dimensions		
Width	40 mm	40 mm
Height	125 mm	125 mm
Depth	118 mm	118 mm
Weights		
Weight, approx.	215 g	215 g

I/O systemsSIMATIC ET 200 systems for the control cabinet
SIMATIC ET 200M**Interface modules > IM 153-4 PN**

Ordering data	Article No.	Article No.
IM 153-4 PN interface module I/O device to connect an ET 200M to PROFINET		
Standard	6ES7153-4AA01-0XB0	
High Feature	6ES7153-4BA00-0XB0	
Accessories		
Bus modules for ET 200M		
• For accommodating a power supply and an IM 153 module for the hot-swapping function during RUN, incl. bus module cover	6ES7195-7HA00-0XA0	
• For accommodating two 40-mm-wide I/O modules for the hot-swapping function	6ES7195-7HB00-0XA0	
• For accommodating one 80-mm-wide I/O module for the hot-swapping function	6ES7195-7HC00-0XA0	
SIMATIC Micro Memory Card 64 KB ¹⁾	6ES7953-8LF31-0AA0	
SIMATIC DP DIN rail for ET 200M Accommodates bus modules; for hot-swapping function		
• Length: 483 mm (19")	6ES7195-1GA00-0XA0	
• Length: 530 mm	6ES7195-1GF30-0XA0	
• Length: 620 mm	6ES7195-1GG30-0XA0	
• Length: 2000 mm	6ES7195-1GC00-0XA0	
SIMATIC S7-300 DIN rail		
Length: 160 mm	6ES7390-1AB60-0AA0	
Length: 480 mm (19")	6ES7390-1AE80-0AA0	
Length: 530 mm	6ES7390-1AF30-0AA0	
Length: 830 mm	6ES7390-1AJ30-0AA0	
Length: 2000 mm	6ES7390-1BC00-0AA0	
Power supply connector For connection of the 24 V DC power supply; spare part, 1 pack containing 10 units		
Spring-loaded connections	6ES7193-4JB00-0AA0	
Screw terminal connections	6ES7193-4JB50-0AA0	
		S7 Manual Collection Electronic manuals on DVD, multi-language: S7-200, TD 200, S7-300, M7-300, C7, S7-400, M7-400, STEP 7, Engineering Tools, Runtime Software, SIMATIC DP (Distributed I/O), SIMATIC HMI (Human Machine Interface), SIMATIC NET (Industrial Communication)
		6ES7998-8XC01-8YE0
		S7 Manual Collection update service for 1 year Scope of delivery: Current DVD "S7 Manual Collection" and the three subsequent updates
		6ES7998-8XC01-8YE2
		Industrial Ethernet FC RJ45 Plug 180 RJ45 plug connector for Industrial Ethernet with a rugged metal housing and integrated insulation displacement contacts for connecting Industrial Ethernet FC installation cables; with 180° cable outlet
		1 unit
		6GK1901-1BB10-2AA0
		10 units
		6GK1901-1BB10-2AB0
		50 units
		6GK1901-1BB10-2AE0
		Industrial Ethernet FastConnect installation cables
		• FastConnect standard cable
		6XV1840-2AH10
		• FastConnect trailing cable
		6XV1840-3AH10
		• FastConnect marine cable
		6XV1840-4AH10
		Industrial Ethernet FastConnect
		Stripping tool
		6GK1901-1GA00

¹⁾ To operate the IM153-4, an MMC is required with at least 64 KB memory. Cards with higher memory capacity may also be used.

Overview



Note:

SIPLUS extreme products are based on SIMATIC standard products. The contents listed here were taken from the respective standard products. SIPLUS extreme-specific information was added.

For technical documentation on SIPLUS, see:

<http://www.siemens.com/siplus-extreme>

Technical specifications

Article number	6AG1153-1AA03-2XB0	6AG1153-2BA10-2XY0	6AG1153-2BA10-7XB0
Based on	6ES7153-1AA03-0XB0 SIPLUS IM153-1	6ES7153-2BA10-0XB0 SIPLUS ET 200M IM153-2 EN50155	6ES7153-2BA10-0XB0 SIPLUS ET 200M IM153-2 HF
Ambient conditions			
Ambient temperature during operation			
• min.	-40 °C; = Tmin	-25 °C; = Tmin	-40 °C; = Tmin; Startup @ -25 °C
• max.	70 °C; = Tmax; 60 °C @ UL/cUL, ATEX and FM use	60 °C; = Tmax; the rated temperature range of -25 ... +55 °C (T1) applies for the use on railway vehicles according to EN50155	70 °C; = Tmax
Ambient temperature during storage/transportation			
• min.	-40 °C	-40 °C	-40 °C
• max.	70 °C	70 °C	70 °C
Extended ambient conditions			
• relative to ambient temperature-atmospheric pressure-installation altitude	Tmin ... Tmax at 1080 hPa ... 795 hPa (-1000 m ... +2000 m) // Tmin ... (Tmax - 10K) at 795 hPa ... 658 hPa (+2000 m ... +3500 m) // Tmin ... (Tmax - 20K) at 658 hPa ... 540 hPa (+3500 m ... +5000 m)	Tmin ... Tmax at 1080 hPa ... 795 hPa (-1000 m ... +2000 m) // Tmin ... (Tmax - 10K) at 795 hPa ... 658 hPa (+2000 m ... +3500 m) // Tmin ... (Tmax - 20K) at 658 hPa ... 540 hPa (+3500 m ... +5000 m)	Tmin ... Tmax at 1080 hPa ... 795 hPa (-1000 m ... +2000 m) // Tmin ... (Tmax - 10K) at 795 hPa ... 658 hPa (+2000 m ... +3500 m) // Tmin ... (Tmax - 20K) at 658 hPa ... 540 hPa (+3500 m ... +5000 m)
• At cold restart, min.	-25 °C	-25 °C	-25 °C
Relative humidity			
- With condensation, tested in accordance with IEC 60068-2-38, max.	100 %; RH incl. condensation/frost (no commissioning under condensation conditions)	100 %; RH incl. condensation/frost (no commissioning under condensation conditions)	100 %; RH incl. condensation/frost (no commissioning under condensation conditions)
Resistance			
- against biologically active substances / conformity with EN 60721-3-3	Yes; Class 3B2 mold, fungus and dry rot spores (with the exception of fauna). The supplied connector covers must remain on the unused interfaces during operation!	Yes; Class 3B2 mold, fungus and dry rot spores (with the exception of fauna). The supplied connector covers must remain on the unused interfaces during operation!	Yes; Class 3B2 mold, fungus and dry rot spores (with the exception of fauna). The supplied connector covers must remain on the unused interfaces during operation!
- against chemically active substances / conformity with EN 60721-3-3	Yes; Class 3C4 incl. salt spray according to EN 60068-2-52 (degree of severity 3). The supplied connector covers must remain on the unused interfaces during operation!	Yes; Class 3C4 (RH < 75%) incl. salt spray according to EN 60068-2-52 (degree of severity 3). The supplied connector covers must remain on the unused interfaces during operation!	Yes; Class 3C4 (RH < 75%) incl. salt spray according to EN 60068-2-52 (degree of severity 3). The supplied connector covers must remain on the unused interfaces during operation!
- against mechanically active substances / conformity with EN 60721-3-3	Yes; Class 3S4 incl. sand, dust. The supplied connector covers must remain on the unused interfaces during operation!	Yes; Class 3S4 incl. sand, dust. The supplied connector covers must remain on the unused interfaces during operation!	Yes; Class 3S4 incl. sand, dust. The supplied connector covers must remain on the unused interfaces during operation!

I/O systemsSIMATIC ET 200 systems for the control cabinet
SIMATIC ET 200M

Interface modules > SIPLUS ET 200M IM 153-1/153-2

Technical specifications (continued)

Article number	6AG1195-7HA00-2XA0	6AG1195-7HB00-7XA0	6AG1195-7HC00-2XA0	6AG1195-7HD10-2XA0
Based on	6ES7195-7HA00-0XA0 SIPLUS ET 200M DP Busmodul	6ES7195-7HB00-0XA0 SIPLUS DP Busmodul ET 200M 2X40	6ES7195-7HC00-0XA0 SIPLUS ET 200M Busmodul	6ES7195-7HD10-0XA0 SIPLUS ET 200M DP Busmodul
Ambient conditions				
Ambient temperature during operation				
• min.	-40 °C; = Tmin	-40 °C; = Tmin	-40 °C; = Tmin	-40 °C; = Tmin
• max.	70 °C; = Tmax; 60 °C @ UL/cUL, ATEX and FM use	70 °C; = Tmax; 60 °C @ UL/cUL, ATEX and FM use	70 °C; = Tmax; 60 °C @ UL/cUL, ATEX and FM use	70 °C; = Tmax; 60 °C @ UL/cUL, ATEX and FM use
Ambient temperature during storage/transportation				
• min.		-40 °C	-40 °C	-40 °C
• max.		70 °C	70 °C	70 °C
Extended ambient conditions				
• relative to ambient temperature-atmospheric pressure-installation altitude	Tmin ... Tmax at 1080 hPa ... 795 hPa (-1000 m ... +2000 m) // Tmin ... (Tmax - 10K) at 795 hPa ... 658 hPa (+2000 m ... +3500 m) // Tmin ... (Tmax - 20K) at 658 hPa ... 540 hPa (+3500 m ... +5000 m)	Tmin ... Tmax at 1080 hPa ... 795 hPa (-1000 m ... +2000 m) // Tmin ... (Tmax - 10K) at 795 hPa ... 658 hPa (+2000 m ... +3500 m) // Tmin ... (Tmax - 20K) at 658 hPa ... 540 hPa (+3500 m ... +5000 m)	Tmin ... Tmax at 1080 hPa ... 795 hPa (-1000 m ... +2000 m) // Tmin ... (Tmax - 10K) at 795 hPa ... 658 hPa (+2000 m ... +3500 m) // Tmin ... (Tmax - 20K) at 658 hPa ... 540 hPa (+3500 m ... +5000 m)	Tmin ... Tmax at 1080 hPa ... 795 hPa (-1000 m ... +2000 m) // Tmin ... (Tmax - 10K) at 795 hPa ... 658 hPa (+2000 m ... +3500 m) // Tmin ... (Tmax - 20K) at 658 hPa ... 540 hPa (+3500 m ... +5000 m)
Relative humidity				
- With condensation, tested in accordance with IEC 60068-2-38, max.	100 %; RH incl. condensation/frost (no commissioning under condensation conditions)	100 %; RH incl. condensation/frost (no commissioning under condensation conditions)	100 %; RH incl. condensation/frost (no commissioning under condensation conditions)	100 %; RH incl. condensation/frost (no commissioning under condensation conditions)
Resistance				
- against biologically active substances / conformity with EN 60721-3-3	Yes; Class 3B2 mold, fungus and dry rot spores (with the exception of fauna). The supplied connector covers must remain on the unused interfaces during operation!	Yes; Class 3B2 mold, fungus and dry rot spores (with the exception of fauna). The supplied connector covers must remain on the unused interfaces during operation!	Yes; Class 3B2 mold, fungus and dry rot spores (with the exception of fauna). The supplied connector covers must remain on the unused interfaces during operation!	Yes; Class 3B2 mold, fungus and dry rot spores (with the exception of fauna). The supplied connector covers must remain on the unused interfaces during operation!
- against chemically active substances / conformity with EN 60721-3-3	Yes; Class 3C4 (RH < 75%) incl. salt spray according to EN 60068-2-52 (degree of severity 3). The supplied connector covers must remain on the unused interfaces during operation!	Yes; Class 3C4 (RH < 75%) incl. salt spray according to EN 60068-2-52 (degree of severity 3). The supplied connector covers must remain on the unused interfaces during operation!	Yes; Class 3C4 (RH < 75%) incl. salt spray according to EN 60068-2-52 (degree of severity 3). The supplied connector covers must remain on the unused interfaces during operation!	Yes; Class 3C4 (RH < 75%) incl. salt spray according to EN 60068-2-52 (degree of severity 3). The supplied connector covers must remain on the unused interfaces during operation!
- against mechanically active substances / conformity with EN 60721-3-3	Yes; Class 3S4 incl. sand, dust. The supplied connector covers must remain on the unused interfaces during operation!	Yes; Class 3S4 incl. sand, dust. The supplied connector covers must remain on the unused interfaces during operation!	Yes; Class 3S4 incl. sand, dust. The supplied connector covers must remain on the unused interfaces during operation!	Yes; Class 3S4 incl. sand, dust. The supplied connector covers must remain on the unused interfaces during operation!

Ordering data	Article No.		Article No.
SIPLUS ET 200M IM 153-1 Slave interface for connecting an ET 200M to PROFIBUS DP for a maximum of 8 S7-300 modules <ul style="list-style-type: none"> Extended temperature range and exposure to media 	6AG1153-1AA03-2XB0	Bus module for SIPLUS ET 200M Bus module for accommodating a power supply and an IM 153 module for the hot-swapping function during RUN, incl. bus module cover <ul style="list-style-type: none"> Extended temperature range and exposure to media 	6AG1195-7HA00-2XA0
SIPLUS ET 200M IM 153-2 High Feature Slave interface for connecting an ET 200M to PROFIBUS DP for a maximum of 12 S7-300 modules; also for use in redundant systems <ul style="list-style-type: none"> Extended temperature range and exposure to media Conforms to EN 50155 	6AG1153-2BA10-7XB0 6AG1153-2BA10-2XY0	Bus module for accommodating two 40-mm-wide I/O modules for the hot-swapping function <ul style="list-style-type: none"> Extended temperature range and exposure to media 	6AG1195-7HB00-7XA0
		Bus module for accommodating one 80-mm-wide I/O module for the hot-swapping function <ul style="list-style-type: none"> Extended temperature range and exposure to media 	6AG1195-7HC00-2XA0
		Bus module for accommodating two IM 153 modules for the hot-swapping function; for setting up redundant systems <ul style="list-style-type: none"> Extended temperature range and exposure to media 	6AG1195-7HD10-2XA0
		RS 485 bus connector with 90° cable outlet Max. transfer rate 12 Mbps Extended temperature range and exposure to media <ul style="list-style-type: none"> without PG interface with PG interface 	6AG1972-0BA12-2XA0 6AG1972-0BB12-2XA0
		Additional accessories	see SIMATIC ET 200M IM 153-1/153-2, page 9/167

I/O systems

SIMATIC ET 200 systems for the control cabinet
SIMATIC ET 200M

Interface modules > SIPLUS ET 200M IM 153-4 PN IO

Overview

- For connection of ET 200M as an IO device to PROFINET IO (copper, RJ45)
- 2 versions:
 - IM 153-4 PN STANDARD
 - IM 153-4 PN HIGH FEATURE: compared to the STANDARD version, also allows operation of PROFIsafe F and HART modules
- Integrated 2-port switch
- 12 modules per station
- Usable I/O quantity structure: 192 bytes each
- Active backplane bus for hot swapping of modules optionally available
- Baud rate 10 Mbps / 100 Mbps (Autonegotiation/Full Duplex)
- I&M functions according to PNO-Guideline Order-No. 3.502, Version V1.1

Notes:

Micro Memory Card with min. 64 KB required if not all participants in the network support LLDP (Link Layer Discovery Protocol; proximity detection).

SIPLUS extreme products are based on SIMATIC standard products. The contents listed here were taken from the respective standard products. SIPLUS extreme-specific information was added.

Technical documentation on SIPLUS can be found here:
<http://www.siemens.com/siplus-extreme>

Technical specifications

Article number	6AG1153-4AA01-7XB0
Based on	6ES7153-4AA01-0XB0 SIPLUS ET 200M IM 153-4 PN IO
Ambient conditions	
Ambient temperature during operation	
• min.	-25 °C; = Tmin
• max.	70 °C; = Tmax; 60 °C @ UL/cUL, ATEX and FM use
Ambient temperature during storage/transportation	
• min.	-40 °C
• max.	70 °C
Extended ambient conditions	
• relative to ambient temperature-atmospheric pressure-installation altitude	Tmin ... Tmax at 1080 hPa ... 795 hPa (-1000 m ... +2000 m) // Tmin ... (Tmax - 10K) at 795 hPa ... 658 hPa (+2000 m ... +3500 m) // Tmin ... (Tmax - 20K) at 658 hPa ... 540 hPa (+3500 m ... +5000 m)
Relative humidity	
- With condensation, tested in accordance with IEC 60068-2-38, max.	100 %; RH incl. condensation/frost (no commissioning under condensation conditions)
Resistance	
- against biologically active substances / conformity with EN 60721-3-3	Yes; Class 3B2 mold, fungus and dry rot spores (with the exception of fauna). The supplied connector covers must remain on the unused interfaces during operation!
- against chemically active substances / conformity with EN 60721-3-3	Yes; Class 3C4 (RH < 75%) incl. salt spray according to EN 60068-2-52 (degree of severity 3). The supplied connector covers must remain on the unused interfaces during operation!
- against mechanically active substances / conformity with EN 60721-3-3	Yes; Class 3S4 incl. sand, dust. The supplied connector covers must remain on the unused interfaces during operation!

Ordering data**Article No.**

SIPLUS ET 200M IM 153-4 PN	6AG1153-4AA01-7XB0
Slave interface for connecting an ET 200M to PROFINET for a maximum of 12 S7-300 modules • Extended temperature range and exposure to media	
Accessories	
IE FC RJ45 Plug 180	6AG1901-1BB10-7AA0
180° cable outlet; 1 unit	
Additional accessories	See SIMATIC ET 200M IM 153-4 PN interface module, page 9/170

Overview Digital modules



- Digital inputs and outputs
- For flexible adaptation of the controller to the respective task
- For connecting digital sensors and actuators

For further information, see SIMATIC S7-300, chapter 5.

Overview Analog modules



- Analog inputs and outputs
- For solving even complex tasks with analog process signals
- For connecting analog actuators and sensors without additional measuring amplifiers

For further information, see SIMATIC S7-300, chapter 5.

I/O systems

SIMATIC ET 200 systems for the control cabinet
SIMATIC ET 200M

I/O modules > Analog modules with HART > Analog input module with HART

Overview



- Can only be plugged onto ET 200M with IM 153-2 and IM 153-2 FO
- 8 AI HART
- Redundancy switching
- Firmware update
- HART minor variables

Technical specifications

Article number	6ES7331-7TF01-0AB0 SM331, 8AI, 0/4-20MA HART
Supply voltage	
Load voltage L+	
• Rated value (DC)	24 V
• Reverse polarity protection	Yes
Input current	
from load voltage L+ (without load), max.	20 mA
from backplane bus 5 V DC, max.	120 mA
Output voltage	
Power supply to the transmitters	
• present	Yes
• Rated value (DC)	24 V
• short-circuit proof	Yes
Power loss	
Power loss, typ.	1.5 W
Analog inputs	
Number of analog inputs	8
permissible input current for current input (destruction limit), max.	40 mA
Input ranges	
• Current	Yes
Input ranges (rated values), currents	
• 0 to 20 mA	Yes
• Input resistance (0 to 20 mA)	140 Ω
• Input resistance (-20 mA to +20 mA)	140 Ω
• Input resistance (4 mA to 20 mA)	140 Ω
Cable length	
• shielded, max.	800 m

Article number	6ES7331-7TF01-0AB0 SM331, 8AI, 0/4-20MA HART
Analog value generation for the inputs	
Measurement principle	Sigma Delta
Integration and conversion time/resolution per channel	
• Resolution with overrange (bit including sign), max.	16 bit
• Integration time, parameterizable	Yes
• Integration time (ms)	20 ms at 50 Hz; 16.6 ms at 60 Hz; 100 ms at 100 Hz
• Basic conversion time, including integration time (ms)	55 ms @ 60 Hz, 65 ms @ 50 Hz, 305 ms @ 100 Hz
• Interference voltage suppression for interference frequency f1 in Hz	10 / 50 / 60 Hz
Encoder	
Connection of signal encoders	
• for current measurement as 2-wire transducer	Yes
• for current measurement as 4-wire transducer	Yes
Errors/accuracies	
Linearity error (relative to input range), (+/-)	0.01 %
Temperature error (relative to input range), (+/-)	0.001 %/K
Crosstalk between the inputs, min.	70 dB
Repeat accuracy in steady state at 25 °C (relative to input range), (+/-)	0.1 %
Operational error limit in overall temperature range	
• Current, relative to input range, (+/-)	0.15 %
Basic error limit (operational limit at 25 °C)	
• Current, relative to input range, (+/-)	0.1 %
Interference voltage suppression for $f = n \times (f1 \pm 1 \%)$, $f1 =$ interference frequency	
• Series mode interference (peak value of interference < rated value of input range), min.	40 dB
• Common mode interference, min.	100 dB

Technical specifications (continued)

Article number	6ES7331-7TF01-0AB0 SM331, 8AI, 0/4-20MA HART
Isochronous mode	
Isochronous operation (application synchronized up to terminal)	No
Interrupts/diagnostics/status information	
Diagnostic functions	Yes
Alarms	
• Diagnostic alarm	Yes
• Limit value alarm	Yes
Diagnostic messages	
• Diagnostic information readable	Yes
Diagnostics indication LED	
• Group error SF (red)	Yes
• Channel fault indicator F (red)	Yes

Article number	6ES7331-7TF01-0AB0 SM331, 8AI, 0/4-20MA HART
Potential separation	
Potential separation analog inputs	
• between the channels	No
• between the channels and backplane bus	Yes
Isolation	
Isolation tested with	500 V DC
Connection method	
required front connector	20-pin
Dimensions	
Width	40 mm
Height	125 mm
Depth	117 mm
Weights	
Weight, approx.	205 g

Ordering data

Ordering data	Article No.
SM 331 HART analog input module 8 inputs, 0/4 – 20 mA, HART for ET 200M with IM 153-2 interface module	6ES7331-7TF01-0AB0
Accessories	
Front connectors	
• 20-pin, with screw terminals	
- 1 unit	6ES7392-1AJ00-0AA0
- 100 units	6ES7392-1AJ00-1AB0
• 20-pin, with spring-loaded terminals	
- 1 unit	6ES7392-1BJ00-0AA0
- 100 units	6ES7392-1BJ00-1AB0
LK 393 cable guide	6ES7393-4AA00-0AA0
Mandatory for operation in hazardous areas	
SIMATIC DP DIN rail for ET 200M	
For mounting of up to 5 bus modules for	
• Length: 483 mm (19")	6ES7195-1GA00-0XA0
• Length: 530 mm	6ES7195-1GF30-0XA0
SIMATIC S7-300 DIN rail	
• Length: 160 mm	6ES7390-1AB60-0AA0
• Length: 480 mm (19")	6ES7390-1AE80-0AA0
• Length: 530 mm	6ES7390-1AF30-0AA0
• Length: 830 mm	6ES7390-1AJ30-0AA0
• Length: 2000 mm	6ES7390-1BC00-0AA0

Ordering data	Article No.
Label cover (10 units, spare part) for signal modules (not 32-channel modules), function modules and CPU 312 IFM	6ES7392-2XY00-0AA0
Labeling strips (10 units, spare part) for signal modules (not 32-channel modules), function modules and CPU 312 IFM	6ES7392-2XX00-0AA0
Labeling sheets for machine printing For modules with 20-pin front connector, DIN A4, for printing with laser printer; 10 units	
petrol	6ES7392-2AX00-0AA0
light beige	6ES7392-2BX00-0AA0
yellow	6ES7392-2CX00-0AA0
red	6ES7392-2DX00-0AA0

I/O systems

SIMATIC ET 200 systems for the control cabinet
SIMATIC ET 200M

I/O modules > Analog modules with HART > Analog output module with HART

Overview



- For plugging into ET 200M exclusively with IM 153-2 and IM 153-2 FO
- 8 AO HART
- Redundancy switching
- Firmware update
- HART minor variables

Technical specifications

Article number	6ES7332-8TF01-0AB0 SM332, 8AO, 0/4 - 20MA HART
Supply voltage	
Load voltage L+	
• Rated value (DC)	24 V
• Reverse polarity protection	Yes
Input current	
from load voltage L+ (without load), max.	350 mA
from backplane bus 5 V DC, max.	110 mA
Power loss	
Power loss, typ.	6 W
Analog outputs	
Number of analog outputs	8
Current output, no-load voltage, max.	24 V
Output ranges, current	
• 0 to 20 mA	Yes
• -20 mA to +20 mA	No
• 4 mA to 20 mA	Yes
Connection of actuators	
• for current output two-wire connection	Yes
Load impedance (in rated range of output)	
• with current outputs, max.	750 Ω
• with current outputs, inductive load, max.	10 mH
Destruction limits against externally applied voltages and currents	
• Voltages at the outputs towards MANA	+60/-0.5 V
Cable length	
• shielded, max.	800 m

Article number	6ES7332-8TF01-0AB0 SM332, 8AO, 0/4 - 20MA HART
Analog value generation for the outputs	
Integration and conversion time/resolution per channel	
• Resolution with overrange (bit including sign), max.	16 bit
Settling time	
• for resistive load	0.1 ms
• for inductive load	0.5 ms
Errors/accuracies	
Output ripple (relative to output range, bandwidth 0 to 50 kHz), (+/-)	0.02 %
Linearity error (relative to output range), (+/-)	0.01 %
Temperature error (relative to output range), (+/-)	0.002 %/K
Crosstalk between the outputs, min.	70 dB
Repeat accuracy in steady state at 25 °C (relative to output range), (+/-)	0.05 %
Operational error limit in overall temperature range	
• Current, relative to output range, (+/-)	0.2 %
Basic error limit (operational limit at 25 °C)	
• Current, relative to output range, (+/-)	0.1 %
Isochronous mode	
Isochronous operation (application synchronized up to terminal)	No

Technical specifications (continued)

Article number	6ES7332-8TF01-0AB0 SM332, 8AO, 0/4 - 20MA HART
Interrupts/diagnostics/ status information	
Diagnostic functions	Yes
Substitute values connectable	Yes
Alarms	
• Diagnostic alarm	Yes
Diagnostic messages	
• Diagnostic information readable	Yes
Diagnostics indication LED	
• Group error SF (red)	Yes
Potential separation	
Potential separation analog outputs	
• between the channels	No
• between the channels and backplane bus	Yes
• Between the channels and load voltage L+	Yes

Article number	6ES7332-8TF01-0AB0 SM332, 8AO, 0/4 - 20MA HART
Isolation	
Isolation tested with	500 V DC
Connection method	
required front connector	20-pin
Dimensions	
Width	40 mm
Height	125 mm
Depth	117 mm
Weights	
Weight, approx.	220 g

Ordering data

Article No.	Article No.
SM 332 HART analog output module HART analog output, 8 outputs, 0/4 – 20 mA, HART for ET 200M with IM 153-2	6ES7332-8TF01-0AB0
Accessories	
Front connector (1 unit) 20-pin, with screw contacts	6ES7392-1AJ00-0AA0
LK 393 cable guide Mandatory for operation in hazardous areas	6ES7393-4AA00-0AA0
SIMATIC DP DIN rail for ET 200M For mounting of up to 5 bus modules for • Length: 483 mm • Length: 530 mm	6ES7195-1GA00-0XA0 6ES7195-1GF30-0XA0
SIMATIC S7-300 DIN rail • Length: 160 mm • Length: 480 mm (19") • Length: 530 mm • Length: 830 mm • Length: 2000 mm	6ES7390-1AB60-0AA0 6ES7390-1AE80-0AA0 6ES7390-1AF30-0AA0 6ES7390-1AJ30-0AA0 6ES7390-1BC00-0AA0
Label cover (10 units, spare part) for signal modules (not 32-channel modules), function modules and CPU 312 IFM	6ES7392-2XY00-0AA0

Labeling strips (10 units, spare part) for signal modules (not 32-channel modules), function modules and CPU 312 IFM	6ES7392-2XX00-0AA0
S7 Manual Collection Electronic manuals on DVD, multi-language: S7-200, TD 200, S7-300, M7-300, C7, S7-400, M7-400, STEP 7, Engineering Tools, Runtime Software, SIMATIC DP (Distributed I/O), SIMATIC HMI (Human Machine Interface), SIMATIC NET (Industrial Communication)	6ES7998-8XC01-8YE0
S7 Manual Collection update service for 1 year Scope of delivery: Current DVD "S7 Manual Collection" and the three subsequent updates	6ES7998-8XC01-8YE2
Labeling sheets for machine printing for modules with 20-pin front connector, DIN A4, for printing with laser printer; 10 units petrol light beige yellow red	6ES7392-2AX00-0AA0 6ES7392-2BX00-0AA0 6ES7392-2CX00-0AA0 6ES7392-2DX00-0AA0

I/O systems

SIMATIC ET 200 systems for the control cabinet
SIMATIC ET 200M

I/O modules > Analog modules with HART > Ex analog input module with HART

Overview



- For connecting HART devices in hazardous areas
- Can only be plugged onto ET 200M
- 2 AI HART, Ex
- 2 inputs in 2 channel groups (single-channel isolation)
- Measurement type and range can be selected for each channel
- Diagnostics and diagnostic alarm parameterizable

Technical specifications

Article number	6ES7331-7TB10-0AB0 SIMATIC DP, HART ANALOG INPUT M
Supply voltage	
Load voltage L+	
• Rated value (DC)	24 V
• Reverse polarity protection	Yes
Input current	
from load voltage L+ (without load), max.	180 mA
from backplane bus 5 V DC, max.	100 mA
Output voltage	
Power supply to the transmitters	
• present	Yes
• Rated value (DC)	15 V; at 22 mA
• short-circuit proof	Yes; approx. 30 mA
• No-load voltage (DC)	29.6 V
Power loss	
Power loss, typ.	4.5 W
Analog inputs	
Number of analog inputs	2
permissible input current for current input (destruction limit), max.	40 mA
Input ranges	
• Current	Yes
Input ranges (rated values), currents	
• 0 to 20 mA	Yes
• Input resistance (0 to 20 mA)	50 Ω
• 4 mA to 20 mA	Yes
• Input resistance (4 mA to 20 mA)	50 Ω
Cable length	
• shielded, max.	400 m
Analog value generation for the inputs	
Measurement principle	Sigma Delta
Integration and conversion time/resolution per channel	
• Resolution with overrange (bit including sign), max.	16 bit; 10 bit to 15 bit + sign
• Integration time, parameterizable	Yes
• Integration time (ms)	2.5 / 16.67 / 20 / 100 ms
• Basic conversion time, including integration time (ms)	2.5 / 16.67 / 20 / 100 (1 channel enabled); 7.5 / 50 / 60 / 300 (2 channels enabled)
• Interference voltage suppression for interference frequency f1 in Hz	10 / 50 / 60 / 400 Hz

Article number	6ES7331-7TB10-0AB0 SIMATIC DP, HART ANALOG INPUT M
Encoder	
Connection of signal encoders	
• for current measurement as 2-wire transducer	Yes
• for current measurement as 4-wire transducer	Yes
Errors/accuracies	
Linearity error (relative to input range), (+/-)	0.01 %
Temperature error (relative to input range), (+/-)	0.01 %/K
Crosstalk between the inputs, min.	130 dB
Repeat accuracy in steady state at 25 °C (relative to input range), (+/-)	0.05 %
Operational error limit in overall temperature range	
• Current, relative to input range, (+/-)	0.45 %; From 0/4 to 20 mA
Basic error limit (operational limit at 25 °C)	
• Current, relative to input range, (+/-)	0.1 %; From 0/4 to 20 mA
Interference voltage suppression for $f = n \times (f1 \pm 1 \%)$, f1 = interference frequency	
• Series mode interference (peak value of interference < rated value of input range), min.	60 dB
• Common mode interference, min.	130 dB
Interrupts/diagnostics/status information	
Diagnostic functions	Yes; Parameterizable
Alarms	
• Diagnostic alarm	Yes; Parameterizable
• Limit value alarm	Yes; Parameterizable, channels 0 and 1
Diagnostic messages	
• Diagnostic information readable	Yes; possible
• Overrange	Yes; Red LED, signal
• Wire-break in signal transmitter cable	Yes; Red LED, signal cable
• Short-circuit of the signal encoder cable	Yes; Red LED, signal cable
• HART communication active	Yes; green LED (H)
Diagnostics indication LED	
• Group error SF (red)	Yes
• Channel fault indicator F (red)	Yes

Technical specifications (continued)

Article number	6ES7331-7TB10-0AB0 SIMATIC DP, HART ANALOG INPUT M
Ex(i) characteristics	
Module for Ex(i) protection	Yes
Maximum values of input circuits (per channel)	
• Co (permissible external capacity), max.	62 nF
• Io (short-circuit current), max.	96.1 mA
• Lo (permissible external inductivity), max.	3 mH
• Po (power of load), max.	511 mW
• Uo (output no-load voltage), max.	26 V
• Um (fault voltage), max.	250 V; DC
• Ta (permissible ambient temperature), max.	60 °C
Potential separation	
Potential separation analog inputs	
• between the channels	Yes
• between the channels and backplane bus	Yes
Permissible potential difference	
between the inputs (UCM)	60 V DC/30 V AC permitted potential difference (Viso) of signals from hazardous areas
Isolation tested with	
• Channels against backplane bus and load voltage L+	2500 V DC
• Channels among one another	2500 V DC
• Load voltage L+ against backplane bus	500 V DC

Article number	6ES7331-7TB10-0AB0 SIMATIC DP, HART ANALOG INPUT M
Standards, approvals, certificates	
CE mark	Yes
UL approval	Yes
FM approval	Yes
RCM (formerly C-TICK)	Yes
KC approval	Yes
EAC (formerly Gost-R)	Yes
Use in hazardous areas	
• Type of protection acc. to FM	Class I, Division 2, Group A, B, C, D T4; Class I, Zone 2, Group IIC T4
• Type of protection acc. to KEMA	II 3 G (2) GD Ex nA [ib Gb] [ib IIIC Db] IIC T4 Gc
• Test number KEMA	DEKRA 14 ATEX 0052X
Ambient conditions	
Ambient temperature during operation	
• min.	0 °C
• max.	60 °C
Connection method	
required front connector	1x 20-pin
Dimensions	
Width	40 mm
Height	125 mm
Depth	120 mm
Weights	
Weight, approx.	260 g

Ordering data

Ordering data	Article No.
SM 331 HART analog input module 2 inputs, 0/4 – 20 mA, HART for ET 200M with IM 153-2 interface module For HART protocol V5.0 and higher	6ES7331-7TB10-0AB0
Accessories	
Front connector¹⁾ 20-pin, with screw contacts • 1 unit • 100 units	6ES7392-1AJ00-0AA0 6ES7392-1AJ00-1AB0
LK 393 cable guide Mandatory for operation in hazardous areas	6ES7393-4AA00-0AA0
SIMATIC DP DIN rail for ET 200M For mounting of up to 5 bus modules for • Length: 483 mm • Length: 530 mm	6ES7195-1GA00-0XA0 6ES7195-1GF30-0XA0
SIMATIC S7-300 DIN rail • Length: 160 mm • Length: 480 mm (19") • Length: 530 mm • Length: 830 mm • Length: 2000 mm	6ES7390-1AB60-0AA0 6ES7390-1AE80-0AA0 6ES7390-1AF30-0AA0 6ES7390-1AJ30-0AA0 6ES7390-1BC00-0AA0

Ordering data

Ordering data	Article No.
Label cover (10 units, spare part) for signal modules (not 32-channel modules), function modules and CPU 312 IFM	6ES7392-2XY00-0AA0
Labeling strips (10 units, spare part) for signal modules (not 32-channel modules), function modules and CPU 312 IFM	6ES7392-2XX00-0AA0
Labeling sheets for machine printing for modules with 20-pin front connector, DIN A4, for printing with laser printer; 10 units	
petrol	6ES7392-2AX00-0AA0
light beige	6ES7392-2BX00-0AA0
yellow	6ES7392-2CX00-0AA0
red	6ES7392-2DX00-0AA0

¹⁾ A connector with spring-loaded terminals cannot be used if the cable guide is used.

I/O systems

SIMATIC ET 200 systems for the control cabinet
SIMATIC ET 200M

I/O modules > Analog modules with HART > Ex analog output module with HART

Overview



- For using HART devices in hazardous areas
- Can only be plugged onto ET 200M
- 2 AO HART, Ex
- 2 current outputs in 2 channel groups (single-channel isolation)
- Output type and range can be selected for each channel
- Diagnostics and diagnostic alarm parameterizable
- Read-back capability of the analog outputs

Technical specifications

Article number	6ES7332-5TB10-0AB0 SIMATIC DP, HART ANALOG OUTPUT
Supply voltage	
Load voltage L+	
• Rated value (DC)	24 V
• Reverse polarity protection	Yes
Input current	
from load voltage L+ (without load), max.	150 mA
from backplane bus 5 V DC, max.	100 mA
Power loss	
Power loss, typ.	3.5 W
Analog outputs	
Number of analog outputs	2
Current output, no-load voltage, max.	19 V
Cycle time (all channels) max.	5 ms
Output ranges, current	
• 0 to 20 mA	Yes
• -20 mA to +20 mA	No
• 4 mA to 20 mA	Yes
Connection of actuators	
• for current output two-wire connection	Yes
Load impedance (in rated range of output)	
• with current outputs, max.	650 Ω
• with current outputs, inductive load, max.	7.5 mH
Destruction limits against externally applied voltages and currents	
• Voltages at the outputs towards MANA	max. 17 V / -0.5 V
• Current, max.	60 mA / -1 A
Cable length	
• shielded, max.	400 m
Analog value generation for the outputs	
Integration and conversion time/resolution per channel	
• Resolution with overrange (bit including sign), max.	12 bit; + sign
• Conversion time (per channel)	40 ms

Article number	6ES7332-5TB10-0AB0 SIMATIC DP, HART ANALOG OUTPUT
Settling time	
• for resistive load	2.5 ms
• for capacitive load	4 ms
• for inductive load	2.5 ms
Errors/accuracies	
Output ripple (relative to output range, bandwidth 0 to 50 kHz), (+/-)	0.02 %
Linearity error (relative to output range), (+/-)	0.03 %
Temperature error (relative to output range), (+/-)	0.01 %/K
Crosstalk between the outputs, min.	130 dB
Repeat accuracy in steady state at 25 °C (relative to output range), (+/-)	0.005 %
Operational error limit in overall temperature range	
• Current, relative to output range, (+/-)	0.55 %
Basic error limit (operational limit at 25 °C)	
• Current, relative to output range, (+/-)	0.15 %
Interrupts/diagnostics/status information	
Diagnostic functions	Yes; Parameterizable
Substitute values connectable	Yes; Parameterizable
Alarms	
• Diagnostic alarm	Yes; Parameterizable
Diagnostic messages	
• Diagnostic information readable	Yes; possible
• Overrange	Yes
• Wire-break	Yes; as of output value > 0.5 mA
• HART communication active	Yes; green LED (H)
Diagnostics indication LED	
• Group error SF (red)	Yes; Red LED
• Channel fault indicator F (red)	Yes; per channel
Ex(i) characteristics	
Module for Ex(i) protection	Yes

Technical specifications (continued)

Article number	6ES7332-5TB10-0AB0 SIMATIC DP, HART ANALOG OUTPUT
Maximum values of output circuits (per channel)	
• Co (permissible external capacity), max.	230 nF
• Io (short-circuit current), max.	66 mA
• Lo (permissible external inductivity), max.	7.5 mH
• Po (power of load), max.	506 mW
• Uo (output no-load voltage), max.	19 V
• Um (fault voltage), max.	60 V; DC
• Ta (permissible ambient temperature), max.	60 °C
Potential separation	
Potential separation analog outputs	
• between the channels	Yes
• between the channels and backplane bus	Yes
• Between the channels and load voltage L+	Yes
Permissible potential difference	
between the outputs (UCM)	60 V DC/30 V AC permitted potential difference (Viso) of signals from hazardous areas

Article number	6ES7332-5TB10-0AB0 SIMATIC DP, HART ANALOG OUTPUT
Isolation tested with	
• Channels against backplane bus and load voltage L+	2500 V DC
• Channels among one another	2500 V DC
• Load voltage L+ against backplane bus	500 V DC
Standards, approvals, certificates	
FM approval	Yes
Use in hazardous areas	
• Type of protection acc. to FM	Class I, Division 2, Group A, B, C, D T4; Class I, Zone 2, Group IIC T4
• Type of protection acc. to KEMA	II 3 G (2) GD Ex nA [ib Gb] [ib IIC Db] IIC T4 Gc
• Test number KEMA	DEKRA 14 ATEX 0053X
Connection method	
required front connector	20-pin
Dimensions	
Width	40 mm
Height	125 mm
Depth	120 mm
Weights	
Weight, approx.	290 g

Ordering data**Article No.****Article No.**

SM 332 HART analog output module	
HART analog output, 8 outputs, 0/4 – 20 mA, HART for ET 200M with IM 153-2	
For HART protocol V5.0 and higher	6ES7332-5TB10-0AB0
Accessories	
Front connectors	
20-pin, with screw contacts	
• 1 unit	6ES7392-1AJ00-0AA0
• 100 units	6ES7392-1AJ00-1AB0
LK 393 cable guide	6ES7393-4AA00-0AA0
Mandatory for operation in hazardous areas	
SIMATIC DP DIN rail for ET 200M	
For mounting of up to 5 bus modules for	
• Length: 483 mm (19")	6ES7195-1GA00-0XA0
• Length: 530 mm	6ES7195-1GF30-0XA0
SIMATIC S7-300 DIN rail	
• Length: 160 mm	6ES7390-1AB60-0AA0
• Length: 480 mm (19")	6ES7390-1AE80-0AA0
• Length: 530 mm	6ES7390-1AF30-0AA0
• Length: 830 mm	6ES7390-1AJ30-0AA0
• Length: 2000 mm	6ES7390-1BC00-0AA0
Label cover	6ES7392-2XY00-0AA0
(10 units, spare part) for signal modules (not 32-channel modules), function modules and CPU 312 IFM	

Labeling strips	6ES7392-2XX00-0AA0
(10 units, spare part) for signal modules (not 32-channel modules), function modules and CPU 312 IFM	
Software for machine labeling of modules directly from the STEP 7 project	
Labeling sheets for machine printing	
for modules with 20-pin front connector, DIN A4, for printing with laser printer; 10 units	
petrol	6ES7392-2AX00-0AA0
light beige	6ES7392-2BX00-0AA0
yellow	6ES7392-2CX00-0AA0
red	6ES7392-2DX00-0AA0
S7 Manual Collection	6ES7998-8XC01-8YE0
Electronic manuals on DVD, multi-language: S7-200, TD 200, S7-300, M7-300, C7, S7-400, M7-400, STEP 7, Engineering Tools, Runtime Software, SIMATIC DP (Distributed I/O), SIMATIC HMI (Human Machine Interface), SIMATIC NET (Industrial Communication)	
S7 Manual Collection update service for 1 year	6ES7998-8XC01-8YE2
Scope of delivery: Current DVD "S7 Manual Collection" and the three subsequent updates	

I/O systems

SIMATIC ET 200 systems for the control cabinet
SIMATIC ET 200M

I/O modules > Analog modules with HART > SIPLUS S7-300 analog input module with HART**Overview**

- Can only be plugged onto ET 200M with IM 153-2 and IM 153-2 FO
- 8 AI HART
- Redundant connection
- Firmware update
- HART secondary variables

Note:

SIPLUS extreme products are based on SIMATIC standard products. The contents listed here were taken from the respective standard products. SIPLUS extreme-specific information was added.

For technical documentation on SIPLUS, see:

<http://www.siemens.com/siplus-extreme>

Technical specifications

Article number	6AG1331-7TF01-7AB0
Based on	6ES7331-7TF01-0AB0 SIPLUS SM331 AI 8 x 0/4...20mA HART
Ambient conditions	
Ambient temperature during operation	
• min.	-25 °C; = Tmin
• max.	70 °C; = Tmax; 60 °C @ UL/cUL use
Ambient temperature during storage/transportation	
• min.	-40 °C
• max.	70 °C
Extended ambient conditions	
• relative to ambient temperature-atmospheric pressure-installation altitude	Tmin ... Tmax at 1080 hPa ... 795 hPa (-1000 m ... +2000 m) // Tmin ... (Tmax - 10K) at 795 hPa ... 658 hPa (+2000 m ... +3500 m) // Tmin ... (Tmax - 20K) at 658 hPa ... 540 hPa (+3500 m ... +5000 m)
Relative humidity	
- With condensation, tested in accordance with IEC 60068-2-38, max.	100 %; RH incl. condensation/frost (no commissioning under condensation conditions)
Resistance	
- against biologically active substances / conformity with EN 60721-3-3	Yes; Class 3B2 mold, fungus and dry rot spores (with the exception of fauna). The supplied connector covers must remain on the unused interfaces during operation!
- against chemically active substances / conformity with EN 60721-3-3	Yes; Class 3C4 (RH < 75%) incl. salt spray according to EN 60068-2-52 (degree of severity 3). The supplied connector covers must remain on the unused interfaces during operation!
- against mechanically active substances / conformity with EN 60721-3-3	Yes; Class 3S4 incl. sand, dust. The supplied connector covers must remain on the unused interfaces during operation!

Ordering data**Article No.****SIPLUS SM 331 analog input module with HART**

8 inputs, 0/4 – 20 mA,
HART for ET 200M with
IM 153-2 interface module

Extended temperature range and exposure to media

6AG1331-7TF01-7AB0

Accessories

See SIMATIC ET 200M analog input module with HART, page 9/177

Overview



- Can only be plugged onto ET 200M with IM 153-2 and IM 153-2 FO
- 8 AO HART
- Redundant connection
- Firmware update
- HART secondary variables

Note:

SIPLUS extreme products are based on SIMATIC standard products. The contents listed here were taken from the respective standard products. SIPLUS extreme-specific information was added.

For technical documentation on SIPLUS, see:

<http://www.siemens.com/siplus-extreme>

Technical specifications

Article number	6AG1332-8TF01-2AB0
Based on	6ES7332-8TF01-0AB0 SIPLUS SM332 8AO HART
Ambient conditions	
Ambient temperature during operation	
• min.	-25 °C; = Tmin
• max.	60 °C; = Tmax
Ambient temperature during storage/transportation	
• min.	-40 °C
• max.	70 °C
Extended ambient conditions	
• relative to ambient temperature-atmospheric pressure-installation altitude	Tmin ... Tmax at 1080 hPa ... 795 hPa (-1000 m ... +2000 m) // Tmin ... (Tmax - 10K) at 795 hPa ... 658 hPa (+2000 m ... +3500 m) // Tmin ... (Tmax - 20K) at 658 hPa ... 540 hPa (+3500 m ... +5000 m)
Relative humidity	
- With condensation, tested in accordance with IEC 60068-2-38, max.	100 %; RH incl. condensation/frost (no commissioning under condensation conditions)
Resistance	
- against biologically active substances / conformity with EN 60721-3-3	Yes; Class 3B2 mold, fungus and dry rot spores (with the exception of fauna). The supplied connector covers must remain on the unused interfaces during operation!
- against chemically active substances / conformity with EN 60721-3-3	Yes; Class 3C4 (RH < 75%) incl. salt spray according to EN 60068-2-52 (degree of severity 3). The supplied connector covers must remain on the unused interfaces during operation!
- against mechanically active substances / conformity with EN 60721-3-3	Yes; Class 3S4 incl. sand, dust. The supplied connector covers must remain on the unused interfaces during operation!

Ordering data

Article No.

SIPLUS SM 332 analog output module with HART	
8 outputs, 0/4...20 mA HART, for ET 200M with IM 153-2 interface module	
Extended temperature range and exposure to media	6AG1332-8TF01-2AB0
Accessories	See SIMATIC SM 332 analog output modules with HART, page 9/179

I/O systems

SIMATIC ET 200 systems for the control cabinet
SIMATIC ET 200M

I/O modules > Analog modules with HART > SIPLUS S7-300 Ex analog input module with HART

Overview

- For connecting HART devices in hazardous areas
- Can only be plugged onto ET 200M
- 2 AI HART, Ex
- 2 inputs in 2 channel groups (single-channel isolation)
- Measurement type and range can be selected for each channel
- Programmable diagnostics and diagnostic interrupt

Note:

SIPLUS extreme products are based on SIMATIC standard products. The contents listed here were taken from the respective standard products. SIPLUS extreme-specific information was added.

For technical documentation on SIPLUS, see:

<http://www.siemens.com/siplus-extreme>

Technical specifications

Article number	6AG1331-7TB00-7AB0
Based on	6ES7331-7TB00-0AB0 SIPLUS S7-300 SM331 2AE HART
Ambient conditions	
Ambient temperature during operation	
• min.	-25 °C; = Tmin
• max.	70 °C; = Tmax; 60 °C @ UL/cUL, ATEX and FM use
Ambient temperature during storage/transportation	
• min.	-40 °C
• max.	70 °C
Extended ambient conditions	
• relative to ambient temperature-atmospheric pressure-installation altitude	Tmin ... Tmax at 1080 hPa ... 795 hPa (-1000 m ... +2000 m) // Tmin ... (Tmax - 10K) at 795 hPa ... 658 hPa (+2000 m ... +3500 m) // Tmin ... (Tmax - 20K) at 658 hPa ... 540 hPa (+3500 m ... +5000 m)
Relative humidity	
- With condensation, tested in accordance with IEC 60068-2-38, max.	100 %; RH incl. condensation/frost (no commissioning under condensation conditions)
Resistance	
- against biologically active substances / conformity with EN 60721-3-3	Yes; Class 3B2 mold, fungus and dry rot spores (with the exception of fauna). The supplied connector covers must remain on the unused interfaces during operation!
- against chemically active substances / conformity with EN 60721-3-3	Yes; Class 3C4 (RH < 75%) incl. salt spray according to EN 60068-2-52 (degree of severity 3). The supplied connector covers must remain on the unused interfaces during operation!
- against mechanically active substances / conformity with EN 60721-3-3	Yes; Class 3S4 incl. sand, dust. The supplied connector covers must remain on the unused interfaces during operation!

Ordering data**Article No.**

SIPLUS SM 331 Ex analog input module with HART	
2 inputs, 0/4 ... 20 mA, HART for ET 200M with IM 153-2 interface module	
Extended temperature range and exposure to media	6AG1331-7TB00-7AB0
Accessories	See SIMATIC ET 200M Ex analog input module with HART, page 9/181

Overview

The fail-safe CPUs of SIMATIC S7 and the fail-safe signal modules of SIMATIC ET 200S, ET 200pro, ET 200eco and ET 200M have been specially developed for distributed safety-related applications in production engineering. Thanks to the discreetly modular structure of the fail-safe I/Os, safety technology is only applied where actually required. The new system replaces conventional electromechanical components, such as:

- Freely programmable, safe linking of sensors to actuators
- Selective safe shutdown of actuators
- Mixed configuration of fail-safe modules and standard modules in a station
- Single-bus concept; fail-safe signals and standard signals are transferred over a single bus medium (PROFIBUS DP, PROFINET)

Totally Integrated Automation (TIA)

Safety technology (Safety Integrated) is a component of Totally Integrated Automation which provides total integration of safety automation and standard automation (SIMATIC S7).

Where standard automation (classical PLC) and safety automation (electromechanics) are still separate today, these two worlds are growing together into a uniform, integrated overall system.

Siemens can therefore present itself as a complete supplier for automation technology in which safety engineering is part of standard automation and system-wide integration exists.

For further information, see SIMATIC S7-300, chapter 5.

I/O systems

SIMATIC ET 200 systems for the control cabinet
SIMATIC ET 200M

I/O modules > Function modules

Overview

Function modules unburden the CPU of work-intensive tasks such as counting, positioning and controlling

Module spectrum

- Counter modules
- Positioning modules for rapid traverse and creep speed drives
- Positioning modules for stepper motors
- Positioning and continuous path modules
- SSI position detection modules
- Electronic cam controllers
- High-speed Boolean processor
- Control modules

Function modules	
Counting	FM 350-1 counter module
	FM 350-2 counter module
Positioning	• of rapid traverse and creep speed drives
	• of stepper motors
Position and path control	FM 351 positioning module
	FM 353 positioning module
SSI position detection	FM 357-2 path and position control module ¹⁾
Electronic cam control	SM 338 POS input modules
High speed logic operation	FM 352 electronic cam controller
Controlling	FM 352-5 high-speed Boolean processor
	FM 355 controller module
Weighing and proportioning electronics	FM 355-2 temperature controller module
	SIWAREX

¹⁾ Not for ET 200M

Overview (continued)**Applicability with ET 200M distributed I/O device**

Almost all function modules can be used in the ET 200M distributed I/O device. In doing so, the following details must be observed:

Module	Article No.	For plugging in behind IM 153-1 (6ES7 153-1AA03-0XB0)		For plugging in behind IM 153-2 (6ES7 153-2BA02-0XB0)		For plugging in behind IM 153-2 FO (6ES7 153-2BB00-0XB0)		For plugging in behind IM 153-4 PN (6ES7 153-4AA00-0XB0)
		STEP 7 ¹⁾	GSD ²⁾	STEP 7 ¹⁾	GSD ²⁾	STEP 7 ¹⁾	GSD ²⁾	STEP 7 ¹⁾
		configurable with						
FM 350-1 counter module	6ES7 350-1AH03-0AE0	<input type="checkbox"/>	--	<input type="checkbox"/>	--	<input type="checkbox"/>	--	<input type="checkbox"/>
FM 350-2 counter module	6ES7 350-2AH01-0AE0	<input type="checkbox"/>	--	<input type="checkbox"/>	--	<input type="checkbox"/>	--	<input type="checkbox"/>
FM 351 positioning module	6ES7 351-1AH01-0AE0	<input type="checkbox"/>	--	<input type="checkbox"/>	--	<input type="checkbox"/>	--	<input type="checkbox"/>
FM 352 cam controller	6ES7 352-1AH02-0AE0	<input type="checkbox"/>	--	<input type="checkbox"/>	--	<input type="checkbox"/>	--	<input type="checkbox"/>
FM 352-5 high-speed Boolean processor	6ES7 352-5AH00-0AE0	<input style="font-size: small; vertical-align: middle;" type="checkbox"/> ³⁾	<input type="checkbox"/>	<input style="font-size: small; vertical-align: middle;" type="checkbox"/> ³⁾	<input type="checkbox"/>	<input style="font-size: small; vertical-align: middle;" type="checkbox"/> ³⁾	<input type="checkbox"/>	<input type="checkbox"/>
FM 352-5 high-speed Boolean processor	6ES7 352-5AH10-0AE0	<input style="font-size: small; vertical-align: middle;" type="checkbox"/> ³⁾	<input type="checkbox"/>	<input style="font-size: small; vertical-align: middle;" type="checkbox"/> ³⁾	<input type="checkbox"/>	<input style="font-size: small; vertical-align: middle;" type="checkbox"/> ³⁾	<input type="checkbox"/>	<input type="checkbox"/>
FM 353 positioning module	6ES7 353-1AH01-0AE0	--	--	<input type="checkbox"/>	--	<input type="checkbox"/>	--	--
FM 355 C controller module	6ES7 355-0VH10-0AE0	--	--	<input type="checkbox"/>	--	<input type="checkbox"/>	--	<input type="checkbox"/>
FM 355 S controller module	6ES7 355-1VH10-0AE0	--	--	<input type="checkbox"/>	--	<input type="checkbox"/>	--	<input type="checkbox"/>
FM 355-2 C temperature controller module	6ES7 355-2CH00-0AE0	<input type="checkbox"/>	--	<input type="checkbox"/>	--	<input type="checkbox"/>	--	<input type="checkbox"/>
FM 355-2 S temperature controller module	6ES7 355-2SH00-0AE0	<input type="checkbox"/>	--	<input type="checkbox"/>	--	<input type="checkbox"/>	--	<input type="checkbox"/>
SM 338 POS input module	6ES7 338-4BC01-0AB0	<input type="checkbox"/>	<input type="checkbox"/>	<input type="checkbox"/>	<input type="checkbox"/>	<input type="checkbox"/>	<input type="checkbox"/>	<input type="checkbox"/>

: configurable

--: not configurable

¹⁾ Configuration using the meta-knowledge integrated into STEP 7 (in Hardware Catalog under PROFIBUS DP > ET 200M > IM 153-1 / IM 153-2 or PROFINET IO > I/O > ET 200M > IM153-4 PN).

²⁾ Configuration using GSD file (after installation of the GSD file configurable from the Hardware Catalog under PROFIBUS DP > Additional field devices > I/O > ET 200M). During configuration on the CP 342-5 as DP master, S5 (IM 308C) as DP master or external masters, the GSD file must be configured.

³⁾ Visible and configurable only with the corresponding configuration package in STEP 7.

Note:

Position measurement systems and prefabricated connecting cables for counter and positioning function are offered under SIMODRIVE Sensor and Motion Connect 500.

<http://www.siemens.com/simatic-technology>

For further information, see SIMATIC S7-300, chapter 5.

I/O systems

SIMATIC ET 200 systems for the control cabinet
SIMATIC ET 200M

I/O modules > Communication**Overview Special modules**

Special modules provide the user with diagnostic and commissioning functions.

For further information, see SIMATIC S7-300, chapter 5.

Overview Communication

- Communication boards for data exchange using point-to-point coupling
- Communication board for the connection of identification systems

For further information, see SIMATIC S7-300, chapter 5.

Overview

- Load current supplies for S7-300/ET 200M
- For converting the line voltage to the required operating voltage (24 V DC)
- Output current 2 A, 5 A or 10 A

For further information, see SIMATIC S7-300, chapter 5.

I/O systems

SIMATIC ET 200 systems for the control cabinet

SIMATIC ET 200iSP

Overview



The ET 200iSP is a modular, intrinsically safe I/O system with IP30 degree of protection which can be operated in gas and dust atmospheres at ambient temperatures from -20 to +70 °C. It is optimized for use with SIMATIC PCS 7 and SIMATIC S7, but can also be integrated in other systems such as SIMATIC S5 per GSD file.

In accordance with ATEX directive 94/9/EC, the ET 200iSP remote I/O stations can be installed directly in the Ex zones 1, 2, 21 or 22 as well as in non-hazardous areas. The intrinsically safe sensors, actuators and HART field devices can also be located in zone 0 or 20 if necessary.

The modular design of the ET 200iSP makes it possible to optimally adapt the remote I/O stations to the respective automation task through individual configuration and flexible expansion. To increase plant availability, the pressure-encapsulated power supply and the intrinsically safe PROFIBUS DP connection (RS 485-IS) of the stations can also be of redundant design.

The modern architecture with hardwiring and automatic slot coding supports pre-wiring without the electronics modules, simple and reliable hot swapping of individual modules without a fire certificate as well as configuration in run (CiR).

In addition to analog and digital I/O modules for the automation of the technological functions of the process (Basic Process Control), the range of electronics modules also includes safety-related F-I/O modules for implementing safety applications. The various types of electronics module can be arranged mixed within a station. Comprehensive diagnostic options facilitate commissioning and troubleshooting.

Technical specifications

ET 200iSP – general		
Degree of protection	IP30	
Ambient temperature	-20 ... +70 °C	
• Horizontal mounting position	-20 ... +70 °C	
• Other mounting positions	-20 ... +50 °C	
Loading of media	According to ISA-S71.04 severity level G1; G2; G3 (except for NH3, only level G2 in this case)	
EMC	Electromagnetic compatibility according to NE21	
Vibration resistance	0.5 g continuously, 1 g periodically	
Approvals, standards		
• ATEX	II 2 G (1) GD I M2	Ex de [ia/ib] IIC T4 Ex de [ia/ib] I
• IECEX	Zone 1	Ex de [ia/ib] IIC T4
• INMETRO	Zone 1	BR-Ex de [ia/ib] IIC T4
• cFMus	Class I, II, III	NI Division 2, Groups A, B, C, D, E, F, G T4 AIS Division 1, Groups A, B, C, D, E, F, G
• cULus	Class I Class I, II, III	Zone 1, AEx de [ia/ib] IIC T4 Division 2, Groups A, B, C, D, E, F, G T4 providing int. safe circuits for Division 1, Groups A, B, C, D, E, F, G
• NEPSI	Class I Ex de [ib] [ia] IIC T4 Ex de [ia/ib] IIC T4	Zone 1, AEx de [ia/ib] IIC T4
• PROFIBUS	EN 50170, Volume 2	
• IEC	IEC 61131, Part 2	
• CE	According to 94/9/EC (previously ATEX 100a), 2004/108/EC and 2006/95/EC	
• KCC	Korea Certification	
• Marine approval	Classification companies	
	• ABS (American Bureau of Shipping)	
	• BV (Bureau Veritas)	
	• DNV (Det Norske Veritas)	
	• GL (Germanischer Lloyd)	
	• LRS (Lloyds Register of Shipping)	
	• Class NK (Nippon Kaiji Kyokai)	

Overview



An ET 200iSP power supply unit consists of a TM-PS terminal module (A or B) and a PS power supply module which is plugged onto this. Terminal modules and power supply modules can be ordered separately.

The power supply modules are suitable for both individual operation (standard) and redundant operation. Depending on the operating mode, they must be combined with the terminal modules as follows:

- Standard: 1 x PS on TM-PS-A
- Redundancy: 1 x PS on TM-PS-A (left) plus 1 x PS on TM-PS-B (right)

Power supply modules are available for supplies of 24 V DC and 120/230 V AC.

The operating state of the power supply modules is indicated by two LEDs on the IM 152 interface module (one for each module).

Technical specifications

Article number	6ES7138-7EA01-0AA0	6ES7138-7EC00-0AA0
	ET 200iSP, POWER SUPPLY MODULE	ET 200iSP, POWER SUPPLY MOD. 120/230 V AC
Supply voltage		
Rated value (DC)	24 V	
Rated value (AC)		230 V; 120/230V AC
Reverse polarity protection	Yes	
Line frequency		
• permissible range, lower limit		47 Hz
• permissible range, upper limit		63 Hz
Input current		
from supply voltage L+, max. from supply voltage L1, max.	4 A	1.04 A; at rated voltage 230 V AC:0.45A at rated voltage 120 V AC:0.75A
Power loss		
Power loss, typ.	20 W	5 W; 5 W + 1.2 x total power loss of the electronics modules
Power loss, max.		21.3 W
Interrupts/diagnostics/ status information		
Status indicator	Yes	Yes
Alarms	No	No
Diagnostic messages		
• Diagnostic information readable	Yes; via IM 152	Yes; via IM 152
Diagnostics indication LED		
• Group error SF (red)	No	No
Ex(i) characteristics		
Maximum values of input circuits (per channel)		
• Um (fault voltage), max.	250 V; DC	264 V; AC/DC
Potential separation		
primary/secondary	Yes	Yes
between supply voltage and electronics	Yes	No

I/O systems

SIMATIC ET 200 systems for the control cabinet
SIMATIC ET 200iSP

Power supply unit**Technical specifications** (continued)

Article number	6ES7138-7EA01-0AA0 ET 200iSP, POWER SUPPLY MODULE	6ES7138-7EC00-0AA0 ET 200iSP, POWER SUPPLY MOD. 120/230 V AC
Standards, approvals, certificates		
CE mark	Yes	Yes
Use in hazardous areas		
• Type of protection acc. to EN 50020 (CENELEC)	Ex de [ib]IIC T4	Ex de [ib]IIC T4
• Type of protection acc. to KEMA	04 ATEX 2263	09 ATEX 0156
Dimensions		
Width	60 mm	60 mm
Height	190 mm	190 mm
Depth	136.5 mm	136.5 mm
Weights		
Weight, approx.	2 700 g	2 700 g
Article number	6ES7193-7DA20-0AA0 ET 200iSP, TERM.-MOD. TM-PS-A UC	6ES7193-7DB20-0AA0 ET 200iSP, TERM.-MOD. TM-PS-B UC
Standards, approvals, certificates		
CE mark	Yes	Yes
Use in hazardous areas		
• Type of protection acc. to EN 50020 (CENELEC)	see ET200iSP system	see ET200iSP system
• Test number KEMA	04 ATEX 2242	04 ATEX 2242
Dimensions		
Width	60 mm	60 mm
Height	190 mm	190 mm
Depth	52 mm	52 mm
Weights		
Weight, approx.	230 g	230 g

9

Ordering data	Article No.	Article No.
PS 24 V DC power supply module for ET 200iSP	6ES7138-7EA01-0AA0	TM-PS-A UC terminal module For standard operation
PS 120/230 V AC power supply module for ET 200iSP	6ES7138-7EC00-0AA0	TM-PS-B UC terminal module Additional terminal module for redundant operation
		6ES7193-7DA20-0AA0
		6ES7193-7DB20-0AA0

Overview



The IM 152 interface module connects the ET 200iSP to the PROFIBUS DP with intrinsically safe RS 485-iS transmission technology with transmission rates up to 1.5 Mbps. A redundant connection is also possible. In this case the ET 200iSP is connected via two interface modules to two redundant PROFIBUS DP segments of a fault-tolerant automation system.

The IM 152 is plugged onto a special terminal module (to be ordered separately). The following terminal modules are available:

- TM-IM/IM terminal module for two interface modules (for redundant PROFIBUS DP connection)
- TM-IM/EM60 terminal module for one interface module and one watchdog, reserve or electronics module (except 2 DO relay)
 - with blue screw-type or spring-loaded terminals for hazardous environments
 - with black screw-type terminals for non-hazardous environments

Tasks of the IM 152 interface module

- Connection of ET 200iSP to the intrinsically safe PROFIBUS DP
- Autonomous communication with the host automation system
- Preparation of data for the fitted electronics modules
- Saving of parameters of the electronics modules
- Time stamping of digital process signals with an accuracy of 20 ms

The maximum address space of the interface module is 244 bytes for inputs and 244 bytes for outputs.

Technical specifications

Article number	6ES7152-1AA00-0AB0 ET 200iSP, IM152-1 INTERFACE MODULE
Input current	
from supply voltage L+, max.	30 mA
Power loss	
Power loss, typ.	0.5 W
Time stamping	
Description	for each digital input, digital input module, total ET 200iS
Accuracy	20 ms
Number of stampable digital inputs, max.	64; for accuracy class 20 ms
Time format	RFC 1119 Internet (ISP)
Time resolution	1 ms
Time interval for transmitting the message buffer if a message is present	1 000 ms
Time stamp on signal change	rising / falling edge as signal entering or exiting
Interfaces	
Interface physics, RS 485	Yes; intrinsically safe
PROFIBUS DP	
• Transmission rate, max.	1.5 Mbit/s; 9,6 / 19,2 / 45,45 / 93,75 / 187,5 / 500 kbit/s
• SYNC capability	Yes
• FREEZE capability	Yes
• Direct data exchange (slave-to-slave communication)	Yes; Slave to slave as publisher
Protocols	
PROFIBUS DP	Yes
Protocols (Ethernet)	
• TCP/IP	No

Article number	6ES7152-1AA00-0AB0 ET 200iSP, IM152-1 INTERFACE MODULE
Isochronous mode	
Isochronous operation (application synchronized up to terminal)	No
Interrupts/diagnostics/status information	
Alarms	Yes
Diagnostic functions	Yes
Alarms	
• acyclic function, interrupts	Yes
• acyclic function, parameters	Yes
Diagnostics indication LED	
• Bus fault BF (red)	Yes
• Group error SF (red)	Yes
• Monitoring 24 V voltage supply ON (green)	Yes
Potential separation	
between supply voltage and electronics	Yes
Standards, approvals, certificates	
CE mark	Yes
Use in hazardous areas	
• Type of protection acc. to EN 50020 (CENELEC)	II2 G Ex ib IIC T4 and I M2 Ex ib I
• Type of protection acc. to KEMA	04 ATEX 1243
Dimensions	
Width	30 mm
Height	129 mm
Depth	136.5 mm
Weights	
Weight, approx.	245 g

I/O systems

SIMATIC ET 200 systems for the control cabinet
SIMATIC ET 200iSP

Interface module

Technical specifications (continued)

Article number	6ES7193-7AA00-0AA0 ET 200iSP, TERM.-MOD. TM-IM/EM60S, SCREW	6ES7193-7AA10-0AA0 ET 200iSP, TERM.-MOD. TM-IM/EM60C, SPRING	6ES7193-7AA20-0AA0 ET 200iSP, TERM.-MOD. TM-IM/EM60S	6ES7193-7AB00-0AA0 ET 200iSP, TERM.-MOD. TM-IM/IM F. TWO IM
Standards, approvals, certificates				
CE mark	Yes	Yes	Yes	Yes
Use in hazardous areas				
• Type of protection acc. to EN 50020 (CENELEC)	see ET200iSP system	see ET200iSP system	No	see ET200iSP system
• Test number KEMA	04 ATEX 2242	04 ATEX 2242		04 ATEX 2242
Dimensions				
Width	60 mm	60 mm	60 mm	60 mm
Height	190 mm	190 mm	190 mm	190 mm
Depth	52 mm	52 mm	52 mm	52 mm
Weights				
Weight, approx.	235 g	235 g	235 g	195 g

Ordering data

Ordering data	Article No.	Ordering data	Article No.
ET 200iSP interface module IM 152-1	6ES7152-1AA00-0AB0	Labeling sheet DIN A4, perforated, each consisting of 10 sheets of 30 strips each for electronics modules and 20 strips each for IM 152	
ET 200iSP terminal module TM-IM/EM60 For an IM 152 and a watchdog, reserve or electronics module (except 2 DO relay), including terminating module		• petrol • yellow	6ES7193-7BH00-0AA0 6ES7193-7BB00-0AA0
• For hazardous environments		Labels, inscribed For slot numbering, label size H x W (in mm): 5 x 7	
- TM-IM/EM60S (blue screw-type terminals)	6ES7193-7AA00-0AA0	• 204 labels, for slots 1 to 20	8WA8361-0AB
- TM-IM/EM60C (blue spring-loaded terminals)	6ES7193-7AA10-0AA0	• 204 labels, for slots 1 to 40	8WA8361-0AC
• For non-hazardous environments		• 136 labels, inscription in plain text	8WA8348-0XA
- TM-IM/EM60S (black screw-type terminals)	6ES7193-7AA20-0AA0	Labels, blank 136 labels for slot numbering, label size H x W (in mm): 5 x 7	8WA8348-2AY
ET 200iSP terminal module TM-IM/IM For two IM 152 modules (redundant operation), including terminating module	6ES7193-7AB00-0AA0	S7-300 DIN rails	
Accessories		• 585 mm long, suitable for assembly of ET 200iSP in a 650 mm-wide wall box	6ES7390-1AF85-0AA0
PROFIBUS connector with selectable terminating resistor For connection of IM 152 to PROFIBUS DP with RS 485-iS transmission technology	6ES7972-0DA60-0XA0	• 885 mm long, suitable for assembly of ET 200iSP in a 950 mm-wide wall box	6ES7390-1AJ85-0AA0
RS 485-iS coupler Isolating transformer for connection of PROFIBUS DP segments with RS 485 and RS 485-iS transmission technologies	6ES7972-0AC80-0XA0		

Overview

**Digital input modules**

- 8-channel digital input module DI NAMUR EEx i, for evaluation of NAMUR sensors, connected and non-connected contacts, as well as for use as counter or frequency meter
Parameterizable connections:
 - NAMUR sensor on/off
 - NAMUR changeover contact
 - Single contact connected (mechanical NO contact)
 - Changeover contact connected (mechanical changeover contact)
 - Single contact non-connected (mechanical NO contact with single contact)
 - Changeover contact non-connected (mechanical changeover contact)
 - Counting function: optional use of 2 channels for recording counter pulses or for frequency measurement
 - Short-circuit and wire break monitoring

Digital output modules

- 4-channel digital output modules DO EEx i, 23.1 V DC/20 mA, 17.4 V DC/27 mA, 17.4 V DC/40 mA or 25.5 V DC/22 mA, with external actuator switch-off via High or Low signal (H/L switch-off)
 - Load-free switching of outputs via external intrinsically safe signal
 - Power boosting through parallel connection of two outputs for one actuator with 4 DO 17.4 V DC/27 mA or 4 DO 17.4 V DC/40 mA
 - Short-circuit and wire break monitoring
- 2-channel digital output module DO Relay EEx e, e.g. for switching solenoid valves, DC contactors or signaling lamps
 - Can be plugged onto TM-RM/RM terminal module
 - Output current up to 2 A with 60 V UC for each of the two relay outputs
 - Installation up to Ex zone 1
 - Intrinsically-safe and non-intrinsically safe signals can be mixed in a station

Extra functionsActuator shutdown function of the 4 DO EEx i modules

The 4 DO EEx i modules are equipped with a shutdown function. This permits implementation of an external switch-off independent of the automation system (controller).

As soon as the intrinsically safe switch-off signal (High or Low) is present at the actuator switch-off input of the electronics module, its outputs are deactivated.

You can also combine several DO modules into a switch-off group. The intrinsically safe power supply for the switch-off device is either via the watchdog module or a separate intrinsically safe source.

Technical specifications

Article number	6ES7131-7RF00-0AB0 ET 200iSP, EL-MOD., 8DI, NAMUR
Digital inputs	
Number of digital inputs	8
Number of NAMUR inputs	8
Input voltage	
• Type of input voltage	DC
Input delay (for rated value of input voltage)	
for standard inputs	
- at "0" to "1", min.	2.8 ms
- at "0" to "1", max.	3.5 ms
- at "1" to "0", min.	2.8 ms
- at "1" to "0", max.	3.5 ms
Cable length	
• shielded, max.	500 m
Encoder	
Number of connectable encoders, max.	8
Connectable encoders	
• NAMUR encoder	Yes
NAMUR encoder	
• Input current for signal "0", max.	1.2 mA
• Input current for signal "1", min.	2.1 mA

Article number	6ES7131-7RF00-0AB0 ET 200iSP, EL-MOD., 8DI, NAMUR
Interrupts/diagnostics/status information	
Diagnostic functions	Yes
Alarms	
• Diagnostic alarm	Yes; Parameterizable
• Hardware interrupt	No
Diagnostic messages	
• Diagnostic information readable	Yes
• Short-circuit	Yes; R load < 150 ohms with NAMUR sensor/sensor and NAMUR changeover contact/sensor to DIN 19234
Diagnostics indication LED	
• Group error SF (red)	Yes
• Status indicator digital input (green)	Yes
Integrated Functions	
Frequency measurement	Yes; (Gate time) 50 ms; 200 ms; 1 s
Number of frequency meters	2
Counter	
Number of counter inputs	2; normal and periodic count function
Input frequency, max.	5 kHz; with a cable length of 20 m: 5 kHz; with a cable length of 100 m: 1 kHz; with a cable length of 200 m: 500 Hz

I/O systems

SIMATIC ET 200 systems for the control cabinet
SIMATIC ET 200iSP

Digital electronics modules

Technical specifications (continued)

Article number	6ES7131-7RF00-0AB0		Article number	6ES7131-7RF00-0AB0	
	ET 200iSP, EL-MOD., 8DI, NAMUR			ET 200iSP, EL-MOD., 8DI, NAMUR	
Potential separation			Dimensions		
Potential separation digital inputs			Width	30 mm	
• between the channels	No		Height	129 mm	
• between the channels and backplane bus	Yes		Depth	136.5 mm	
Permissible potential difference			Weights		
between different circuits	60 V DC/30 V AC		Weight, approx.	255 g	
Standards, approvals, certificates					
CE mark	Yes				
Use in hazardous areas					
• Type of protection acc. to EN 50020 (CENELEC)	II2 G (1) GD Ex ib[ia] IIC T4 and I M2 Ex ib[ia] I				
• Type of protection acc. to KEMA	04 ATEX 1248				
Article number	6ES7132-7RD01-0AB0	6ES7132-7RD11-0AB0	6ES7132-7RD22-0AB0		
	ET 200iSP, EL-MOD., 4DO, DC 23,1V, 20MA	ET 200iSP, EL-MOD., 4DO, DC 17,4V, 27MA	ET 200iSP, EL-MOD., 4DO, DC 17.4V, 40MA		
Input current					
from load voltage L+ (without load), max.	340 mA; with actuator supply	300 mA	400 mA		
from backplane bus 3.3 V DC, max.	10 mA	10 mA			
Power loss					
Power loss, typ.	2.5 W	2.1 W	2.8 W		
Address area					
Address space per module					
• without packing	2 byte	2 byte	2 byte		
Digital outputs					
Number of digital outputs	4; additionally 1 intrinsically-safe input for H shutdown	4; additionally 1 intrinsically-safe input for H shutdown	4; additionally 1 intrinsically-safe input for H shutdown		
Short-circuit protection	Yes	Yes	Yes		
No-load voltage U _{ao} (DC)	23.1 V	17.4 V	17.4 V		
Internal resistor R _i	275 Ω	150 Ω	167 Ω		
Trend key points E					
• Voltage U _e (DC)	17.6 V	13.3 V	10.7 V		
• Current I _e	20 mA	27 mA	40 mA; 80 mA when outputs connected in parallel		
Output current					
• for signal "1" rated value	0.02 A	0.027 A	0.04 A		
Output delay with resistive load					
• "0" to "1", max.	2 ms	2 ms	2 ms		
• "1" to "0", max.	1.5 ms	1.5 ms	1.5 ms		
Parallel switching of two outputs					
• for uprating	No; for Ex reasons not possible; nor for predecessor	Yes	Yes		
Switching frequency					
• with resistive load, max.	100 Hz	100 Hz	100 Hz		
• with inductive load, max.	2 Hz	2 Hz	2 Hz		
Cable length					
• shielded, max.	500 m	500 m	500 m		
• unshielded, max.	500 m	500 m	500 m		

Technical specifications (continued)

Article number	6ES7132-7RD01-0AB0 ET 200iSP, EL-MOD., 4DO, DC 23,1V, 20MA	6ES7132-7RD11-0AB0 ET 200iSP, EL-MOD., 4DO, DC 17,4V, 27MA	6ES7132-7RD22-0AB0 ET 200iSP, EL-MOD., 4DO, DC 17.4V, 40MA
Interrupts/diagnostics/status information			
Status indicator	Yes	Yes	Yes
Alarms		No	
Diagnostic functions	Yes	Yes	
Alarms			
• Diagnostic alarm	Yes; Parameterizable	Yes; Parameterizable	Yes; Parameterizable
Diagnostic messages			
• Diagnostic information readable	Yes	Yes	Yes
• Wire-break	Yes; R > 10 kohms, I < 100 µA	Yes	Yes; R > 10 kohms, I < 100 µA
• Short-circuit	Yes; R < 800 ohms (one output), R < 40 ohms (outputs connected in parallel)	Yes	Yes; R < 80 Ohm (one output), R < 40 Ohm (outputs connected in parallel)
Diagnostics indication LED			
• Group error SF (red)	Yes	Yes	Yes
• Status indicator digital output (green)	Yes	Yes	Yes; Per channel
Parameter			
Remark		14 byte	
Diagnostics wire break	Yes	Yes	Yes
Diagnostics short-circuit	Yes	Yes	Yes
Response to CPU/master STOP	Substitute a value/keep last value	Substitute a value/keep last value	Substitute a value/keep last value
Ex(i) characteristics			
Maximum values of output circuits (per channel)			
• Co (permissible external capacity), max.			241 nF; For IIC, 1507 nF for IIB
• Io (short-circuit current), max.			118 mA
• Lo (permissible external inductivity), max.			1.7 mH; For IIC, 10.4 mH for IIB
• Po (power of load), max.			572 mW
• Uo (output no-load voltage), max.			19.4 V
• Ta (permissible ambient temperature), max.	70 °C	70 °C	
Potential separation			
Potential separation digital outputs			
• between the channels	No	No	No
• between the channels and backplane bus	Yes	Yes	Yes
• Between the channels and load voltage L+	Yes	Yes	Yes
Permissible potential difference			
between different circuits			60 V DC/30 V AC
Standards, approvals, certificates			
CE mark			Yes
Highest safety class achievable in safety mode			
• SIL acc. to IEC 61508	No		No
Use in hazardous areas			
• Type of protection acc. to EN 50020 (CENELEC)	II2 G (1) GD Ex ib[ia] IIC T4 and I M2 Ex ib[ia] I	II2 G (1) GD Ex ib[ia] IIC T4 and I M2 Ex ib[ia] I	II2 G (1) GD Ex ib[ia] IIC T4 and I M2 Ex ib[ia] I
• Type of protection acc. to KEMA	04 ATEX 1249	04 ATEX 1249	04 ATEX 1249
Dimensions			
Width	30 mm	30 mm	30 mm
Height	129 mm	129 mm	129 mm
Depth	136.5 mm	136.5 mm	136.5 mm
Weights			
Weight, approx.	255 g	255 g	255 g

I/O systems

SIMATIC ET 200 systems for the control cabinet

SIMATIC ET 200iSP

Digital electronics modules**Technical specifications (continued)**

Article number	6ES7132-7GD00-0AB0 ET 200iSP, EL-MOD., 4DO, DC 23,1V, 20MA	6ES7132-7GD10-0AB0 ET 200iSP, EL-MOD., 4DO, DC 17,4V, 27MA	6ES7132-7GD21-0AB0 ET 200iSP, EL-MOD., 4DO, DC 17,4V, 40MA	6ES7132-7GD30-0AB0 ET 200iSP, EL-MOD., 4DO, DC 25.5V, 22MA
Input current				
from load voltage L+ (without load), max.	340 mA; with actuator supply	300 mA; with actuator supply	400 mA	400 mA
from backplane bus 3.3 V DC, max.	10 mA	10 mA		
Power loss				
Power loss, typ.	2.5 W	2.1 W	2.8 W	2.8 W
Address area				
Address space per module				
• without packing	2 byte	2 byte	2 byte	2 byte
Digital outputs				
Number of digital outputs	4; additionally 1 intrinsically-safe input for L shutdown	4; additionally 1 intrinsically-safe input for L shutdown	4; additionally 1 intrinsically-safe input for L shutdown	4; additionally 1 intrinsically-safe input for L shutdown
Short-circuit protection	Yes	Yes	Yes	Yes
No-load voltage U _{ao} (DC)	23.1 V	17.4 V	17.4 V	25.5 V
Internal resistor R _i	275 Ω	150 Ω	167 Ω	260 Ω
Trend key points E				
• Voltage U _e (DC)	17.6 V	13.3 V	10.7 V	19.8 V
• Current I _e	20 mA	27 mA; 54 mA when outputs connected in parallel	40 mA	22 mA
Output current				
• for signal "1" rated value	0.02 A	0.027 A	0.04 A	0.022 A
Output delay with resistive load				
• "0" to "1", max.	2 ms	2 ms	2 ms	2 ms
• "1" to "0", max.	1.5 ms	1.5 ms	1.5 ms	1.5 ms
Parallel switching of two outputs				
• for uprating	No; for Ex reasons not possible; nor for predecessor	Yes	Yes	No
Switching frequency				
• with resistive load, max.	100 Hz	100 Hz	100 Hz	100 Hz
• with inductive load, max.	2 Hz	2 Hz	2 Hz	2 Hz
Cable length				
• shielded, max.	500 m	500 m	500 m	500 m
• unshielded, max.	500 m	500 m	500 m	500 m
Interrupts/diagnostics/status information				
Status indicator	Yes	Yes	Yes	Yes
Diagnostic functions	Yes	Yes	Yes	Yes
Alarms				
• Diagnostic alarm	Yes; Parameterizable	Yes; Parameterizable	Yes; Parameterizable	Yes; Parameterizable
Diagnostic messages				
• Diagnostic information readable	Yes	Yes	Yes	Yes
• Wire-break	Yes; R > 10 kohms, I < 100 μA	Yes; R > 10 kohms, I < 100 μA	Yes; R > 10 kohms, I < 100 μA	Yes; R > 10 kohms, I < 100 μA
• Short-circuit	Yes; R < 80 Ohm (one output), R < 40 Ohm (outputs connected in parallel)	Yes; R < 800 ohms (one output), R < 40 ohms (outputs connected in parallel)	Yes; R < 80 Ohm (one output), R < 40 Ohm (outputs connected in parallel)	Yes; R < 80 ohms
Diagnostics indication LED				
• Group error SF (red)	Yes	Yes	Yes	Yes
• Status indicator digital output (green)	Yes	Yes	Yes; Per channel	Yes; Per channel

Technical specifications (continued)

Article number	6ES7132-7GD00-0AB0 ET 200iSP, EL-MOD., 4DO, DC 23,1V, 20MA	6ES7132-7GD10-0AB0 ET 200iSP, EL-MOD., 4DO, DC 17,4V, 27MA	6ES7132-7GD21-0AB0 ET 200iSP, EL-MOD., 4DO, DC 17,4V, 40MA	6ES7132-7GD30-0AB0 ET 200iSP, EL-MOD., 4DO, DC 25.5V, 22MA
Parameter				
Remark	14 byte	14 byte		
Diagnostics wire break	Yes	Yes	Yes	Yes
Diagnostics short-circuit	Yes	Yes	Yes	Yes
Response to CPU/master STOP	Substitute a value/keep last value	Substitute a value/keep last value	Substitute a value/keep last value	Substitute a value/keep last value
Ex(i) characteristics				
Maximum values of output circuits (per channel)				
• Co (permissible external capacity), max.			241 nF; For IIC, 1507 nF for IIB	81 nF; For IIC, 651 nF for IIB
• Io (short-circuit current), max.			118 mA	110 mA
• Lo (permissible external inductivity), max.			1.7 mH; For IIC, 10.4 mH for IIB	1.7 mH; For IIC, 11.5 mH for IIB
• Po (power of load), max.			572 mW	764 mW
• Uo (output no-load voltage), max.			19.4 V	27.9 V
• Ta (permissible ambient temperature), max.	70 °C	70 °C		
Potential separation				
Potential separation digital outputs				
• between the channels	No	No	No	No
• between the channels and backplane bus	Yes	Yes	Yes	Yes
• Between the channels and load voltage L+	Yes	Yes	Yes	Yes
Permissible potential difference				
between different circuits			60 V DC/30 V AC	60 V DC/30 V AC
Standards, approvals, certificates				
CE mark	Yes	Yes	Yes	Yes
Highest safety class achievable in safety mode				
• SIL acc. to IEC 61508	No	No	No	No
Use in hazardous areas				
• Type of protection acc. to EN 50020 (CENELEC)	II 2 G (1) GD Ex ib[ia] IIC T4 and I M2 Ex ib[ia] I	II 2 G (1) GD Ex ib[ia] IIC T4 and I M2 Ex ib[ia] I	II 2 G (1) GD and I M2 Ex ib[ia][iaD] IIC T4; Ex ib [ia] I	II 2 G (1) GD and I M2 Ex ib[ia][iaD] IIC T4; Ex ib [ia] I
• Type of protection acc. to KEMA	04 ATEX 1249	04 ATEX 1249	04 ATEX 1249	04 ATEX 1249
Dimensions				
Width	30 mm	30 mm	30 mm	30 mm
Height	129 mm	129 mm	129 mm	129 mm
Depth	136.5 mm	136.5 mm	136.5 mm	136.5 mm
Weights				
Weight, approx.	255 g	255 g	255 g	255 g

I/O systemsSIMATIC ET 200 systems for the control cabinet
SIMATIC ET 200iSP**Digital electronics modules****Technical specifications (continued)**

Article number	6ES7132-7HB00-0AB0 ET 200iSP, RELAY-MOD., 2DO, UC60V, 2A
Input current	
from load voltage L+ (without load), max.	120 mA
Power loss	
Power loss, typ.	1.1 W
Digital outputs	
Number of digital outputs	2
Short-circuit protection	No
Output current	
• for signal "1" rated value	2 A
Output delay with resistive load	
• "0" to "1", max.	8 ms
• "1" to "0", max.	3 ms
Parallel switching of two outputs	
• for uprating	No
• for redundant control of a load	No
Switching frequency	
• with resistive load, max.	0.5 Hz; See data in manual
• with inductive load, max.	0.2 Hz; See data in manual
Relay outputs	
Switching capacity of contacts	
- with resistive load, up to 60 °C, max.	2 A; See data in manual
- Thermal continuous current, max.	2 A; See data in manual
Cable length	
• shielded, max.	500 m
• unshielded, max.	500 m
Interrupts/diagnostics /status information	
Status indicator	Yes
Alarms	No
Substitute values connectable	Yes
Alarms	
• Diagnostic alarm	Yes
• Hardware interrupt	No

Article number	6ES7132-7HB00-0AB0 ET 200iSP, RELAY-MOD., 2DO, UC60V, 2A
Diagnostic messages	
• Diagnostic information readable	Yes
• Wire-break	No; Cannot be determined in contact power circuit
• Short-circuit	No; Cannot be determined in contact power circuit
Diagnostics indication LED	
• Group error SF (red)	Yes
• Status indicator digital output (green)	Yes; Per channel
Ex(i) characteristics	
Maximum values of output circuits (per channel)	
• U _o (output no-load voltage), max.	60 V
• U _m (fault voltage), max.	250 V
• T _a (permissible ambient temperature), max.	70 °C
Potential separation	
Potential separation digital outputs	
• between the channels	Yes
• between the channels and backplane bus	Yes
• Between the channels and load voltage L+	Yes; Channels and power bus
Standards, approvals, certificates	
CE mark	Yes
Highest safety class achievable in safety mode	
• SIL acc. to IEC 61508	No
Use in hazardous areas	
• Type of protection acc. to EN 50020 (CENELEC)	II 2 G and I M2 Ex eibmb IIC T4; Ex eibmb I
• Type of protection acc. to KEMA	07 ATEX 0180
Dimensions	
Width	30 mm
Height	129 mm
Depth	136.5 mm
Weights	
Weight, approx.	255 g

Article number	6ES7193-7CA00-0AA0 ET 200iSP, TERM.-MOD. TM-EM/EM60S F. EM	6ES7193-7CA10-0AA0 ET 200iSP, TERM.-MOD. TM-EM/EM60C F. EM	6ES7193-7CA20-0AA0 ET 200iSP, TERM.-MOD. TM-EM/EM60S F. EM	6ES7193-7CB00-0AA0 ET 200iSP, TERM.-MOD. TM-RM/RM
Standards, approvals, certificates				
CE mark	Yes	Yes	Yes	Yes
Use in hazardous areas				
• Type of protection acc. to EN 50020 (CENELEC)	see ET200iSP system	see ET200iSP system	No	see ET200iSP system
• Test number KEMA	04 ATEX 2242	04 ATEX 2242		07 ATEX 0205
Dimensions				
Width	60 mm	60 mm	60 mm	60 mm
Height	190 mm	190 mm	190 mm	190 mm
Depth	52 mm	52 mm	52 mm	52 mm
Weights				
Weight, approx.	275 g	275 g	235 g	340 g

Technical specifications (continued)

Article number	6ES7138-7AA00-0AA0 ET 200iSP, RESERVE MODULE
Digital inputs	
Number of digital inputs	0
Standards, approvals, certificates	
CE mark	Yes
Use in hazardous areas	
• Type of protection acc. to EN 50020 (CENELEC)	II2 G EEx ib IIC T4
• Test number KEMA	04 ATEX 1251

Article number	6ES7138-7AA00-0AA0 ET 200iSP, RESERVE MODULE
Dimensions	
Width	30 mm
Height	129 mm
Depth	136.5 mm
Weights	
Weight, approx.	180 g

Ordering data**Digital input modules**

Digital input modules EEx i

8 DI NAMUR

For evaluation of NAMUR sensors, connected/non-connected contacts, as well as for recording counter pulses or measuring frequencies

- 8 × NAMUR (NAMUR sensor on/off, NAMUR changeover contact) or connected/non-connected inputs (single/changeover contact)
- 2 channels optionally usable as counters (max. 5 kHz) or frequency meters (1 Hz ... 5 kHz)
- Time tagging 20 ms, rising or falling edge
- Wire break monitoring
- Short-circuit monitoring
- Sensor power supply monitoring
- Flutter monitoring

Article No.**6ES7131-7RF00-0AB0****Digital output modules**

Digital output modules EEx i with H-switch-off

(external actuator switch-off via H-signal); for switching of solenoid valves, DC relays, signal lamps, actuators

4 DO DC 23.1 V/20 mA

- 4 channels with 20 mA each
- Short-circuit monitoring
- Wire break monitoring
- Configurable connection of substitute value in the event of CPU failure
- Load-free switching of outputs via external intrinsically safe signal

6ES7132-7RD01-0AB0**4 DO DC 17.4 V/27 mA**

- 4 channels with 27 mA each or 2 outputs connected in parallel with 54 mA each
- Short-circuit monitoring
- Wire break monitoring
- Configurable connection of substitute value in the event of CPU failure
- Load-free switching of outputs via external intrinsically safe signal

6ES7132-7RD11-0AB0**Article No.****4 DO DC 17.4 V/40 mA**

- 4 channels with 40 mA each or 2 outputs connected in parallel with 80 mA each
- Short-circuit monitoring
- Wire break monitoring
- Configurable connection of substitute value in the event of CPU failure
- Load-free switching of outputs via external intrinsically safe signal

6ES7132-7RD22-0AB0

Digital output modules EEx i with L-switch-off

(external actuator switch-off via L-signal); for switching of solenoid valves, DC relays, signal lamps, actuators

4 DO DC 23.1 V/20 mA

- 4 channels with 20 mA each
- Short-circuit monitoring
- Wire break monitoring
- Configurable connection of substitute value in the event of CPU failure
- Load-free switching of outputs via external intrinsically safe signal

6ES7132-7GD00-0AB0**4 DO DC 17.4 V/27 mA**

- 4 channels with 27 mA each or 2 outputs connected in parallel with 54 mA each
- Short-circuit monitoring
- Wire break monitoring
- Configurable connection of substitute value in the event of CPU failure
- Load-free switching of outputs via external intrinsically safe signal

6ES7132-7GD10-0AB0**4 DO DC 17.4 V/40 mA**

- 4 channels with 40 mA each or 2 outputs connected in parallel with 80 mA each
- Short-circuit monitoring
- Wire break monitoring
- Configurable connection of substitute value in the event of CPU failure
- Load-free switching of outputs via external intrinsically safe signal

6ES7132-7GD21-0AB0

I/O systems

SIMATIC ET 200 systems for the control cabinet
SIMATIC ET 200iSP

Digital electronics modules

Ordering data	Article No.	Accessories	Article No.
Digital input modules (continued)		Reserve module For any electronics module	6ES7138-7AA00-0AA0
4 DO DC 25.5 V/22 mA¹⁾ <ul style="list-style-type: none"> 4 channels with 22 mA each Short-circuit monitoring Wire break monitoring Configurable connection of substitute value in the event of CPU failure Load-free switching of outputs via external intrinsically safe signal 	6ES7132-7GD30-0AB0	Labeling sheet DIN A4, perforated, each consisting of 10 sheets of 30 strips each for electronics modules and 20 strips each for IM 151 <ul style="list-style-type: none"> petrol yellow 	6ES7193-7BH00-0AA0 6ES7193-7BB00-0AA0
Digital output modules EEx e For switching of solenoid valves, DC contactors or indicator lights		Labels, inscribed for slot numbering, label size H × W (in mm): 5 × 7 <ul style="list-style-type: none"> 204 labels, for slots 1 to 20 204 labels, for slots 1 to 40 	8WA8361-0AB 8WA8361-0AC
2 DO Relay, 60 V UC, 2 A <ul style="list-style-type: none"> Can be plugged onto TM-RM/RM terminal module Output current up to 2 A with 60 V UC for each of the two relay outputs Installation up to Ex zone 1 Configurable connection of substitute value in the event of CPU failure 	6ES7132-7HB00-0AB0	Labels, blank 136 labels for slot numbering, label size H × W (in mm): 5 × 7	8WA8348-2AY
Terminal modules		S7-300 rails <ul style="list-style-type: none"> 585 mm long, suitable for assembly of ET 200iSP in a 650 mm-wide wall box 885 mm long, suitable for assembly of ET 200iSP in a 950 mm-wide wall box 	6ES7390-1AF85-0AA0 6ES7390-1AJ85-0AA0
ET 200iSP terminal module TM-EM/EM60 For two modules (reserve module, watchdog module and all electronics modules except 2 DO Relay can be plugged in) <ul style="list-style-type: none"> For hazardous environments <ul style="list-style-type: none"> TM-EM/EM60S (blue screw-type terminals) TM-EM/EM60C (blue spring-loaded terminals) For non-hazardous environments <ul style="list-style-type: none"> TM-EM/EM60S (black screw-type terminals) 	6ES7193-7CA00-0AA0 6ES7193-7CA10-0AA0 6ES7193-7CA20-0AA0		
ET 200iSP terminal module TM-RM/RM 60 For two modules (electronics module 2 DO Relay and reserve module can be plugged in) <ul style="list-style-type: none"> TM-RM/RM60S (screw-type terminals) 	6ES7193-7CB00-0AA0		

¹⁾ Can be used with SIMATIC PCS 7 V7.1+SP2 or higher

Overview**Analog input modules**

- 4-channel analog input module AI 2 WIRE HART EEx i for current measurement in the range 4 to 20 mA, suitable for connection of two-wire transmitters (with/without HART functionality)
 - Resolution 12 bit + sign
 - Max. load of transmitter 750 Ω
 - Short-circuit and wire break monitoring
- 4-channel analog input module AI 4 WIRE HART EEx i for current measurement in the range 0/4 to 20 mA, suitable for connection of 4-wire transmitters (with/without HART functionality)
 - Resolution 12 bit + sign
 - Max. load of transmitter 750 Ω
 - Wire break monitoring
- 4-channel analog input module AI RTD EEx i for resistance measurement and for temperature measurement per Pt100/Ni100 resistance thermometer
 - Resolution 15 bit + sign
 - 2, 3 or 4-wire connection possible
 - Resistance measurements 600 Ω absolute and 1 000 Ω absolute
 - Wire break monitoring
- 4-channel analog input module AI TC EEx i for thermoelectric EMF measurements and for temperature measurement per thermocouple, type B, E, N, J, K, L, S, R, T, U
 - Resolution 15 bit + sign
 - Internal temperature compensation possible using TC sensor module (included in scope of delivery of module)
 - External temperature compensation by means of a temperature value acquired at an analog module of the same ET 200iSP station
 - Wire break monitoring

Analog output modules

- 4-channel analog output module AO I HART EEx i for output of current signals in the range 0/4 to 20 mA to field devices (with/without HART functionality)
 - Resolution 14 bit
 - Parameterizable substitute value in case of CPU failure
 - Short-circuit and wire break monitoring

Extra functionsTemperature compensation

A TC sensor module for internal temperature compensation is provided with the 4 AI TC module, and is fitted on the corresponding terminals of the associated terminal module.

External temperature compensation is possible via a Pt100 on a 4 AI RTD module.

I/O systems

SIMATIC ET 200 systems for the control cabinet

SIMATIC ET 200iSP

Analog electronics modules**Technical specifications**

Article number	6ES7134-7SD00-0AB0 ET 200iSP, EL-MOD., 4 AI TC	6ES7134-7SD51-0AB0 ET 200iSP, EL-MOD., 4 AI RTD, PT100/NI100	6ES7134-7TD00-0AB0 ET 200iSP, EL-MOD., 4 AI, HART, 2-WIRE	6ES7134-7TD50-0AB0 ET 200iSP, EL-MOD., 4 AI, HART, 4-WIRE
Input current				
from supply voltage L+, max.	30 mA	22 mA	320 mA	30 mA
Output voltage				
Power supply to the transmitters				
<ul style="list-style-type: none"> • short-circuit proof • Supply current, max. 			Yes 23 mA; per channel	
Power loss				
Power loss, typ.	0.4 W	0.4 W	2.7 W	0.4 W
Analog inputs				
Number of analog inputs	4	4	4	4
permissible input current for current input (destruction limit), max.			90 mA	50 mA
Cycle time (all channels) max.	320 ms; 66 ms basic conversion time x 4 channels with interference frequency suppression 60 Hz, 80 ms basic conversion time x 4 channels with interference frequency suppression 50 Hz	320 ms; 66 ms basic conversion time x 4 channels with interference frequency suppression 60 Hz, 80 ms basic conversion time x 4 channels with interference frequency suppression 50 Hz	120 ms; 30 ms basic conversion time x 4 channels with 60 Hz, 50 Hz interference frequency suppression	120 ms; 30 ms basic conversion time x 4 channels with 60 Hz, 50 Hz interference frequency suppression
Technical unit for temperature measurement adjustable	Yes	Yes	Yes	Yes
Input ranges				
<ul style="list-style-type: none"> • Voltage • Current • Thermocouple • Resistance thermometer • Resistance 	Yes No Yes No No	No No No Yes Yes	No Yes No No No	No Yes No No No
Input ranges (rated values), voltages				
<ul style="list-style-type: none"> • -80 mV to +80 mV • Input resistance (-80 mV to +80 mV) 	Yes 1 000 kΩ			
Input ranges (rated values), currents				
<ul style="list-style-type: none"> • 4 mA to 20 mA • Input resistance (4 mA to 20 mA) 			Yes	Yes 295 Ω
Input ranges (rated values), thermocouples				
<ul style="list-style-type: none"> • Type B • Input resistance (Type B) • Type C • Input resistance (Type C) • Type E • Input resistance (Type E) • Type J • Input resistance (type J) • Type K • Input resistance (Type K) • Type L • Input resistance (Type L) • Type N • Input resistance (Type N) • Type R • Input resistance (Type R) • Type S • Input resistance (Type S) • Type T • Input resistance (Type T) • Type U • Input resistance (Type U) 	Yes 1 000 kΩ Yes 1 000 kΩ Yes 1 000 kΩ Yes 1 000 kΩ Yes 1 000 kΩ Yes 1 000 kΩ Yes 1 000 kΩ Yes 1 000 kΩ Yes 1 000 kΩ Yes 1 000 kΩ Yes 1 000 kΩ Yes 1 000 kΩ			

Technical specifications (continued)

Article number	6ES7134-7SD00-0AB0 ET 200iSP, EL-MOD., 4 AI TC	6ES7134-7SD51-0AB0 ET 200iSP, EL-MOD., 4 AI RTD, PT100/NI100	6ES7134-7TD00-0AB0 ET 200iSP, EL-MOD., 4 AI, HART, 2-WIRE	6ES7134-7TD50-0AB0 ET 200iSP, EL-MOD., 4 AI, HART, 4-WIRE
Input ranges (rated values), resistance thermometer				
<ul style="list-style-type: none"> Ni 100 Input resistance (Ni 100) Pt 100 Input resistance (Pt 100) 		Yes 2 000 kΩ Yes 2 000 kΩ		
Input ranges (rated values), resistors				
<ul style="list-style-type: none"> 0 to 600 ohms Input resistance (0 to 600 ohms) 		Yes; Also 1000 ohms 1 000 kΩ		
Thermocouple (TC)				
Temperature compensation				
<ul style="list-style-type: none"> internal temperature compensation external temperature compensation with compensations socket 	Yes; via supplied TC sensor module Yes; via temperature value, acquired by an analog module of the same ET 200iSP station			
Characteristic linearization				
<ul style="list-style-type: none"> parameterizable for thermocouples for resistance thermometer 	Yes Yes	Yes Yes		
Cable length				
<ul style="list-style-type: none"> shielded, max. 	50 m	500 m	500 m	500 m
Analog value generation for the inputs				
Measurement principle	integrating (Sigma-Delta)	integrating (Sigma-Delta)	integrating (Sigma-Delta)	integrating (Sigma-Delta)
Integration and conversion time/ resolution per channel				
<ul style="list-style-type: none"> Resolution with overrange (bit including sign), max. Integration time, parameterizable Basic conversion time, including integration time (ms) <ul style="list-style-type: none"> additional conversion time for wire-break monitoring Interference voltage suppression for interference frequency f1 in Hz 	16 bit Yes 80 ms at 50 Hz; 66 ms at 60 Hz 5 ms 50 / 60 Hz	16 bit Yes 80 ms at 50 Hz; 66 ms at 60 Hz 5 ms 50 / 60 Hz	13 bit No 50 / 60 Hz	12 bit; + sign Yes 30 ms 50 / 60 Hz
Smoothing of measured values				
<ul style="list-style-type: none"> parameterizable Step: None Step: low Step: Medium Step: High 	Yes; in 4 stages Yes; 1 x cycle time Yes; 4 x cycle time Yes; 32 x cycle time Yes; 64 x cycle time	Yes; in 4 stages Yes; 1 x cycle time Yes; 4 x cycle time Yes; 32 x cycle time Yes; 64 x cycle time	Yes; in 4 stages Yes; 1 x cycle time Yes; 4 x cycle time Yes; 32 x cycle time Yes; 64 x cycle time	Yes; in 4 stages Yes; 1 x cycle time Yes; 4 x cycle time Yes; 32 x cycle time Yes; 64 x cycle time
Encoder				
Connection of signal encoders				
<ul style="list-style-type: none"> for current measurement as 2-wire transducer <ul style="list-style-type: none"> Burden of 2-wire transmitter, max. for current measurement as 4-wire transducer for resistance measurement with two-wire connection for resistance measurement with three-wire connection for resistance measurement with four-wire connection 			Yes 750 Ω	Yes

I/O systems

SIMATIC ET 200 systems for the control cabinet

SIMATIC ET 200iSP

Analog electronics modules**Technical specifications** (continued)

Article number	6ES7134-7SD00-0AB0 ET 200iSP, EL-MOD., 4 AI TC	6ES7134-7SD51-0AB0 ET 200iSP, EL-MOD., 4 AI RTD, PT100/NI100	6ES7134-7TD00-0AB0 ET 200iSP, EL-MOD., 4 AI, HART, 2-WIRE	6ES7134-7TD50-0AB0 ET 200iSP, EL-MOD., 4 AI, HART, 4-WIRE
Errors/accuracies				
Linearity error (relative to input range), (+/-)	0.015 %	0.015 %	0.015 %	0.015 %
Temperature error (relative to input range), (+/-)	0.02 %/K	0.02 %/K	0.005 %/K	0.005 %/K
Crosstalk between the inputs, min.	-50 dB	-50 dB	-50 dB	-50 dB
Repeat accuracy in steady state at 25 °C (relative to input range), (+/-)	0.01 %	0.01 %	0.01 %	0.01 %
Operational error limit in overall temperature range				
• Voltage, relative to input range, (+/-)	0.15 %		0.15 %	0.15 %
• Current, relative to input range, (+/-)				
• Resistance thermometer, relative to input range, (+/-)		0.15 %; Applies to resistances standard ± 0.8 K, climatic ± 0.3 K		
Basic error limit (operational limit at 25 °C)				
• Voltage, relative to input range, (+/-)	0.1 %		0.1 %	0.1 %
• Current, relative to input range, (+/-)				
• Resistance thermometer, relative to input range, (+/-)		0.1 %; Applies to resistances standard ± 0.5 K, climatic ± 0.2 K		
Interference voltage suppression for $f = n \times (f_1 \pm 1 \%)$, $f_1 =$ interference frequency				
• Series mode interference (peak value of interference < rated value of input range), min.	70 dB	70 dB	70 dB	70 dB
• Common mode interference, min.	90 dB	90 dB		
Interrupts/diagnostics/status information				
Alarms				
• Diagnostic alarm	Yes; Parameterizable	Yes	Yes; Parameterizable	Yes; Parameterizable
• Limit value alarm	Yes; Parameterizable	Yes	Yes; Parameterizable	Yes; Parameterizable
Diagnostic messages				
• Diagnostic information readable	Yes	Yes	Yes	Yes
• Wire-break		Yes	Yes	Yes
• Short-circuit		Yes	Yes	
• Group error		Yes		
Diagnostics indication LED				
• Group error SF (red)	Yes	Yes	Yes	Yes
Potential separation				
Potential separation analog inputs				
• between the channels	Yes	No	No	No
• between the channels and backplane bus	Yes	Yes	Yes	Yes
• Between the channels and load voltage L+		Yes; Channels and power bus		

Technical specifications (continued)

Article number	6ES7134-7SD00-0AB0 ET 200iSP, EL-MOD., 4 AI TC	6ES7134-7SD51-0AB0 ET 200iSP, EL-MOD., 4 AI RTD, PT100/NI100	6ES7134-7TD00-0AB0 ET 200iSP, EL-MOD., 4 AI, HART, 2-WIRE	6ES7134-7TD50-0AB0 ET 200iSP, EL-MOD., 4 AI, HART, 4-WIRE
Standards, approvals, certificates				
CE mark	Yes	Yes	Yes	Yes
Highest safety class achievable in safety mode				
• Performance level according to ISO 13849-1	none	none	none	none
• SIL acc. to IEC 61508	No	No	No	No
Use in hazardous areas				
• Type of protection acc. to EN 50020 (CENELEC)	II2 G (1) GD Ex ib[ia] IIC T4 and I M2 Ex ib[ia] I	II2 G (1) GD Ex ib[ia] IIC T4 and I M2 Ex ib[ia] I	II2 G (1) GD Ex ib[ia] IIC T4 and I M2 Ex ib[ia] I	II2 G (1) GD Ex ib[ia] IIC T4 and I M2 Ex ib[ia] I
• Type of protection acc. to KEMA	04 ATEX 1246	04 ATEX 1247	04 ATEX 1244	04 ATEX 1245
Dimensions				
Width	30 mm	30 mm	30 mm	30 mm
Height	129 mm	129 mm	129 mm	129 mm
Depth	136.5 mm	136.5 mm	136.5 mm	136.5 mm
Weights				
Weight, approx.	230 g	230 g	230 g	230 g

Article number	6ES7135-7TD00-0AB0 ET 200iSP, EL-MOD., 4 AO, 4-20MA, HART
Input current	
from load voltage L+ (without load), max.	330 mA
Power loss	
Power loss, typ.	2.7 W
Analog outputs	
Number of analog outputs	4
Cycle time (all channels) max.	3.6 ms
Output ranges, current	
• 0 to 20 mA	Yes
• 4 mA to 20 mA	Yes
Connection of actuators	
• for current output two-wire connection	Yes
Load impedance (in rated range of output)	
• with current outputs, max.	750 Ω
Cable length	
• shielded, max.	500 m
Analog value generation for the outputs	
Integration and conversion time/resolution per channel	
• Resolution with overrange (bit including sign), max.	14 bit
Settling time	
• for resistive load	4 ms
• for capacitive load	40 ms
• for inductive load	40 ms
Errors/accuracies	
Linearity error (relative to output range), (+/-)	0.015 %
Temperature error (relative to output range), (+/-)	0.005 %/K
Crosstalk between the outputs, min.	-50 dB
Repeat accuracy in steady state at 25 °C (relative to output range), (+/-)	0.01 %
Operational error limit in overall temperature range	
• Current, relative to output range, (+/-)	0.15 %

Article number	6ES7135-7TD00-0AB0 ET 200iSP, EL-MOD., 4 AO, 4-20MA, HART
Basic error limit (operational limit at 25 °C)	
• Current, relative to output range, (+/-)	0.1 %
Interrupts/diagnostics/status information	
Substitute values connectable	Yes
Alarms	
• Diagnostic alarm	Yes
Diagnostic messages	
• Diagnostic information readable	Yes
• Wire-break	Yes
• Short-circuit	Yes
Diagnostics indication LED	
• Group error SF (red)	Yes
Potential separation	
• between the channels	No
• between the channels and backplane bus	Yes
Standards, approvals, certificates	
CE mark	Yes
Use in hazardous areas	
• Type of protection acc. to EN 50020 (CENELEC)	II2 G (1) GD Ex ib[ia] IIC T4 and I M2 Ex ib[ia] I
• Type of protection acc. to KEMA	04 ATEX 1250
Dimensions	
Width	30 mm
Height	129 mm
Depth	136.5 mm
Weights	
Weight, approx.	265 g

I/O systemsSIMATIC ET 200 systems for the control cabinet
SIMATIC ET 200iSP**Analog electronics modules****Technical specifications** (continued)

Article number	6ES7193-7CA00-0AA0 ET 200iSP, TERM.-MOD. TM-EM/EM60S F. EM	6ES7193-7CA10-0AA0 ET 200iSP, TERM.-MOD. TM-EM/EM60C F. EM	6ES7193-7CA20-0AA0 ET 200iSP, TERM.-MOD. TM-EM/EM60S F. EM	6ES7193-7CB00-0AA0 ET 200iSP, TERM.-MOD. TM-RM/RM
Standards, approvals, certificates				
CE mark	Yes	Yes	Yes	Yes
Use in hazardous areas				
• Type of protection acc. to EN 50020 (CENELEC)	see ET200iSP system	see ET200iSP system	No	see ET200iSP system
• Test number KEMA	04 ATEX 2242	04 ATEX 2242		07 ATEX 0205
Dimensions				
Width	60 mm	60 mm	60 mm	60 mm
Height	190 mm	190 mm	190 mm	190 mm
Depth	52 mm	52 mm	52 mm	52 mm
Weights				
Weight, approx.	275 g	275 g	235 g	340 g

Article number	6ES7138-7AA00-0AA0 ET 200iSP, RESERVE MODULE
Digital inputs	
Number of digital inputs	0
Standards, approvals, certificates	
CE mark	Yes
Use in hazardous areas	
• Type of protection acc. to EN 50020 (CENELEC)	II2 G EEx ib IIC T4
• Test number KEMA	04 ATEX 1251

Article number	6ES7138-7AA00-0AA0 ET 200iSP, RESERVE MODULE
Dimensions	
Width	30 mm
Height	129 mm
Depth	136.5 mm
Weights	
Weight, approx.	180 g

Ordering data**Article No.****Article No.****Analog input modules**

Analog input modules EEx i

4 AI | 2 WIRE HART

- For measuring currents with 2-wire transmitters with/without HART functionality
- 4 × 4 ... 20 mA, HART, 2-wire transmitter
 - Transmitter load: max. 750 Ω
 - Resolution 12 bit + sign
 - Short-circuit monitoring
 - Wire break monitoring

6ES7134-7TD00-0AB0**4 AI | 4 WIRE HART**

- For measuring currents with 4-wire transmitters with/without HART functionality
- 4 × 0/4 ... 20 mA, HART, 4-wire transmitter
 - Transmitter load: max. 750 Ω
 - Resolution 12 bit + sign
 - Wire break monitoring

6ES7134-7TD50-0AB0**4 AI RTD**

- For measuring resistances as well as for temperature measurements with resistance thermometers
- 4 × RTD, resistance thermometer Pt100/Ni100
 - 2, 3, 4-wire
 - Resolution 15 bit + sign
 - Short-circuit monitoring
 - Wire break monitoring

6ES7134-7SD51-0AB0**4 AI TC**

- For measuring thermal e.m.f. as well as for temperature measurements with thermocouples
- 4 × TC (thermocouples)
 - Type B [PtRh-PtRh]
 - Type N [NiCrSi-NiSi]
 - Type E [NiCr-CuNi]
 - Type R [PtRh-Pt]
 - Type S [PtPh-Pt]
 - Type J [Fe-CuNi]
 - Type L [Fe-CuNi]
 - Type T [Cu-CuNi]
 - Type K [NiCr-Ni]
 - Type U [Cu-CuNi]
 - Resolution 15 bit + sign
 - Internal compensation of cold junction temperature possible using TC sensor module (included in scope of delivery of module)
 - External temperature compensation via Pt100, connected to RTD module of same ET 200iSP station
 - Wire break monitoring

6ES7134-7SD00-0AB0

Ordering data	Article No.	Accessories	Article No.
Analog output modules		Reserve module	
Analog output modules EEx i		For any electronics module	
4 AO I HART		Labeling sheet	
For output of currents to field devices with/without HART functionality		DIN A4, perforated, each consisting of 10 sheets of 30 strips each for electronics modules and 20 strips each for IM 151	
<ul style="list-style-type: none"> • 4 × 0/4 ... 20 mA, HART (max. load 750 Ω) • Resolution 14-bit • Short-circuit monitoring • Wire break monitoring • Parameterizable substitute value in case of CPU failure 		<ul style="list-style-type: none"> • petrol • yellow 	
Terminal modules		Labels, inscribed	
ET 200iSP terminal module TM-EM/EM60		for slot numbering, label size H × W (in mm): 5 × 7	
For two modules (reserve module, watchdog module and all electronics modules except 2 DO Relay can be plugged in)		<ul style="list-style-type: none"> • 204 labels, for slots 1 to 20 • 204 labels, for slots 1 to 40 	
<ul style="list-style-type: none"> • For hazardous environments <ul style="list-style-type: none"> - TM-EM/EM60S (blue screw-type terminals) - TM-EM/EM60C (blue spring-loaded terminals) • For non-hazardous environments <ul style="list-style-type: none"> - TM-EM/EM60S (black screw-type terminals) 		Labels, blank	
<ul style="list-style-type: none"> 6ES7135-7TD00-0AB0 		136 labels for slot numbering, label size H × W (in mm): 5 × 7	
<ul style="list-style-type: none"> 6ES7193-7CA00-0AA0 6ES7193-7CA10-0AA0 6ES7193-7CA20-0AA0 		S7-300 DIN rails	
		<ul style="list-style-type: none"> • 585 mm long, suitable for assembly of ET 200iSP in a 650 mm-wide wall box • 885 mm long, suitable for assembly of ET 200iSP in a 950 mm-wide wall box 	
		<ul style="list-style-type: none"> 6ES7138-7AA00-0AA0 6ES7193-7BH00-0AA0 6ES7193-7BB00-0AA0 8WA8361-0AB 8WA8361-0AC 8WA8348-2AY 6ES7390-1AF85-0AA0 6ES7390-1AJ85-0AA0 	

I/O systems

SIMATIC ET 200 systems for the control cabinet
SIMATIC ET 200iSP

Safety-related electronics modules

Overview



The electronics modules of the SIMATIC ET 200iSP distributed I/O system equipped with safety functions can be used together with the safety-related automation systems (controllers) for the implementation of safety applications. The input modules record the process signals, evaluate them, and prepare them for additional processing by the automation system. The output modules convert the safety-related signals output by the automation systems so that they are suitable for controlling the connected actuators.

F digital input modules

- 8 F-DI Ex NAMUR
 - Safety-related digital input module for evaluating the signals from IEC 60947-5-6/NAMUR sensors and connected/non-connected mechanical contacts in hazardous and non-hazardous areas
 - SIL 3/Cat. 3/PL e with 8 inputs (1-channel/1oo1 evaluation) or 4 inputs (2-channel/1oo2 evaluation)
 - 8 short-circuit-proof sensor supplies (8 V DC) for 1 channel each
 - Inputs and sensor supplies electrically isolated from power bus and backplane bus
 - Diagnostics evaluation (deactivated for non-connected mechanical contacts)
 - Internal diagnostics buffer
 - Programmable diagnostics interrupt
 - Supports time stamping
 - Channel-selective passivation
 - Firmware update using HW Config possible
 - Exclusively for safety mode
 - LED displays for safety mode, group errors and channel status/fault

F digital output modules

- 4 F-DO Ex DC 17.4 V/40 mA
 - Safety-related digital output module for controlling actuators in hazardous and non-hazardous areas, e.g. solenoid valves, DC current relays or indicator lamps
 - SIL 3/Cat. 3/PL e with 4 outputs, P/P-switching
 - Electrical isolation from power bus and backplane bus
 - Rated load voltage 17.4 V DC
 - Max. output current 40 mA
 - Performance enhancement through parallel connection of two digital outputs for one actuator
 - Short-circuit, overload and wire-break monitoring
 - Configurable diagnostics
 - Internal diagnostics buffer
 - Programmable diagnostics interrupt
 - Channel-selective passivation
 - Firmware update using HW Config possible
 - Exclusively for safety mode
 - LED displays for safety mode, group errors and channel status/fault

F analog input modules

- 4 F-AI Ex HART (0 ... 20 mA or 4 ... 20 mA)
 - Safety-related digital input module for evaluating the signals from current sensors in hazardous and non-hazardous areas, e.g. 2-wire transmitters and HART field devices
 - SIL 3/Cat. 3/PL e with 4 inputs of one module (1-channel/1oo1 evaluation) or 4 inputs of two modules (2-channel/1oo2 evaluation)
 - Measuring ranges: 0 ... 20 mA or 4 ... 20 mA
 - Resolution 15 bit + sign
 - HART communication in measuring range 4 ... 20 mA
 - 4 short-circuit-proof sensor supplies (min. 12 V DC; max. 26 V DC) for 1 channel each
 - Inputs and sensor supplies electrically isolated from backplane bus
 - Configurable diagnostics
 - Programmable diagnostics interrupt
 - Internal diagnostics buffer
 - Firmware update using HW Config possible
 - Exclusively for safety mode
 - LED displays for safety mode, group errors, channel faults and HART status per channel

Technical specifications

Article number	6ES7138-7FN00-0AB0 ET 200iSP, 8F-DI NAMUR EX, FAIL-SAFE
Input current	
from supply voltage L+, max.	150 mA; int. Powerbus
Encoder supply	
Number of outputs	8
Type of output voltage	8 V DC
Power loss	
Power loss, typ.	1.4 W
Address area	
Occupied address area	
• Inputs	6 byte
• Outputs	4 byte
Digital inputs	
Number of digital inputs	8
Number of NAMUR inputs	8
Input voltage	
• Type of input voltage	DC
Input current	
• for signal *1*, typ.	9.5 mA
Input delay (for rated value of input voltage)	
for standard inputs	
- at *0* to *1*, min.	0.7 ms
- at *0* to *1*, max.	16 ms; Parameterizable
- at *1* to *0*, min.	0.7 ms
- at *1* to *0*, max.	16 ms; Parameterizable
Cable length	
• shielded, max.	500 m
• unshielded, max.	200 m
Encoder	
Number of connectable encoders, max.	8
Connectable encoders	
• NAMUR encoder	Yes
NAMUR encoder	
• Input current for signal *0*, max.	1.2 mA
• Input current for signal *1*, min.	2.1 mA
Interrupts/diagnostics/ status information	
Status indicator	Yes
Diagnostic functions	Yes
Alarms	
• Diagnostic alarm	Yes; Parameterizable
• Hardware interrupt	No
Diagnostic messages	
• Diagnostic information readable	Yes
• Wire-break	Yes; NAMUR encoders or single contact with 10 kOhm parallel resistor
• Short-circuit	Yes; R load < 150 ohms with NAMUR sensor/sensor and NAMUR changeover contact/sensor to DIN 19234
Diagnostics indication LED	
• Group error SF (red)	Yes

Article number	6ES7138-7FN00-0AB0 ET 200iSP, 8F-DI NAMUR EX, FAIL-SAFE
Parameter	
Diagnostics wire break	channel by channel
Diagnostics short-circuit	channel by channel
Potential separation	
Potential separation digital inputs	
• between the channels	No
• between the channels and backplane bus	Yes
Permissible potential difference	
between different circuits	60 V DC/30 V AC
Isolation	
Isolation tested with	350 V AC/1 min between the shield and backplane bus connection 350 V AC/1 min between the shield and I/O 2830 V AC/1 min between backplane bus connection and I/O
Standards, approvals, certificates	
CE mark	Yes
Highest safety class achievable in safety mode	
• Performance level according to ISO 13849-1	PLe
• SIL acc. to IEC 61508	SIL 3
Use in hazardous areas	
• Type of protection acc. to EN 50020 (CENELEC)	II 2 G (1) GD Ex ib[ia Ga][ia IIC Da] IIC T4 GB and I M2 Ex ib[ia Ma] I Mb
• Type of protection acc. to KEMA	10 ATEX 0056
Dimensions	
Width	30 mm
Height	129 mm
Depth	136.5 mm
Weights	
Weight, approx.	288 g

I/O systemsSIMATIC ET 200 systems for the control cabinet
SIMATIC ET 200iSP**Safety-related electronics modules****Technical specifications (continued)**

Article number	6ES7138-7FD00-0AB0 ET 200iSP, 4F-DO 40MA EX, FAIL-SAFE
Input current	
from load voltage L+ (without load), max.	510 mA; int. Powerbus
Power loss	
Power loss, typ.	5.3 W; max.
Digital outputs	
Number of digital outputs	4
Short-circuit protection	Yes
• Response threshold, typ.	Depending on the "short-circuit level" parameter
Controlling a digital input	No
No-load voltage U _{ao} (DC)	17.4 V
Internal resistor R _i	167 Ω
Load resistance range	
• lower limit	270 Ω
• upper limit	18 kΩ
Trend key points E	
• Voltage U _e (DC)	10.7 V
• Current I _e	40 mA
Output voltage	
• for signal "1", min.	max. 17.4 V
Output current	
• for signal "0" residual current, max.	10 μA
Parallel switching of two outputs	
• for uprating	Yes
• for redundant control of a load	No
Switching frequency	
• with resistive load, max.	30 Hz
• with inductive load, max.	2 Hz
Cable length	
• shielded, max.	500 m
• unshielded, max.	500 m
Interrupts/diagnostics/ status information	
Status indicator	Yes
Substitute values connectable	Yes
Alarms	
• Diagnostic alarm	Yes; Parameterizable
Diagnostic messages	
• Diagnostic information readable	Yes
• Wire-break	Yes
• Short-circuit	Yes
Diagnostics indication LED	
• Group error SF (red)	Yes
• Status indicator digital output (green)	Yes

Article number	6ES7138-7FD00-0AB0 ET 200iSP, 4F-DO 40MA EX, FAIL-SAFE
Parameter	
Diagnostics wire break	Yes
Diagnostics short-circuit	Yes
Potential separation	
Potential separation digital outputs	
• between the channels	No
• between the channels and backplane bus	Yes
• Between the channels and load voltage L+	Yes
Permissible potential difference	
between different circuits	60 V DC/30 V AC
Standards, approvals, certificates	
CE mark	Yes
Highest safety class achievable in safety mode	
• Performance level according to ISO 13849-1	PL _e
• SIL acc. to IEC 61508	SIL 3
Use in hazardous areas	
• Type of protection acc. to EN 50020 (CENELEC)	II 2 G (1) GD Ex ib[ia Ga][ia IIC Da] IIC T4 GB and I M2 Ex ib[ia Ma] I Mb
• Type of protection acc. to KEMA	10 ATEX 0057
Dimensions	
Width	30 mm
Height	129 mm
Depth	136.5 mm
Weights	
Weight, approx.	285 g

Technical specifications (continued)

Article number	6ES7138-7FA00-0AB0 ET 200iSP, 4F-AI HART EX, FAIL-SAFE
Input current	
from supply voltage L+, max.	490 mA; int. Powerbus
Output voltage	
Power supply to the transmitters	
• short-circuit proof	Yes
• Supply current, max.	25 mA; Plus 4 mA per channel
Power loss	
Power loss, max.	5.4 W
Address area	
Address space per module	
• Address space per module, max.	16 byte; 12 bytes in the I area / 4 bytes in the O area
Analog inputs	
Number of analog inputs	4
Cycle time (all channels) max.	See data in manual
Input ranges	
• Voltage	No
• Current	Yes
• Thermocouple	No
• Resistance thermometer	No
• Resistance	No
Input ranges (rated values), currents	
• 0 to 20 mA	Yes
• 4 mA to 20 mA	Yes
Cable length	
• shielded, max.	500 m
Analog value generation for the inputs	
Measurement principle	integrating (Sigma-Delta)
Integration and conversion time/resolution per channel	
• Resolution with overrange (bit including sign), max.	16 bit
• Integration time, parameterizable	Yes
• Interference voltage suppression for interference frequency f1 in Hz	50 / 60 Hz
Smoothing of measured values	
• parameterizable	Yes; in 4 stages
• Step: None	Yes; 1 x cycle time
• Step: low	Yes; 4 x cycle time
• Step: Medium	Yes; 16 x cycle time
• Step: High	Yes; 64 x cycle time
Encoder	
Connection of signal encoders	
• for current measurement as 2-wire transducer	Yes
- Burden of 2-wire transmitter, max.	750 Ω
Errors/accuracies	
Linearity error (relative to input range), (+/-)	0.015 %
Temperature error (relative to input range), (+/-)	0.005 %/K
Crosstalk between the inputs, min.	-50 dB
Repeat accuracy in steady state at 25 °C (relative to input range), (+/-)	0.015 %

Article number	6ES7138-7FA00-0AB0 ET 200iSP, 4F-AI HART EX, FAIL-SAFE
Operational error limit in overall temperature range	
• Current, relative to input range, (+/-)	0.35 %
Basic error limit (operational limit at 25 °C)	
• Current, relative to input range, (+/-)	0.1 %
Interference voltage suppression for f = n x (f1 +/- 1 %), f1 = interference frequency	
• Series mode interference (peak value of interference < rated value of input range), min.	40 dB
• Common mode interference, min.	50 dB
Interrupts/diagnostics/status information	
Alarms	
• Diagnostic alarm	Yes; Parameterizable
Diagnostic messages	
• Diagnostic information readable	Yes
• Wire-break	Yes
• Short-circuit	Yes
Diagnostics indication LED	
• Group error SF (red)	Yes
Potential separation	
Potential separation analog inputs	
• between the channels	No
• between the channels and backplane bus	Yes
• Between the channels and load voltage L+	Yes; Power bus
Permissible potential difference	
between different circuits	60 V DC/30 V AC
Standards, approvals, certificates	
CE mark	Yes
Highest safety class achievable in safety mode	
• Performance level according to ISO 13849-1	PLe
• SIL acc. to IEC 61508	SIL 3
Use in hazardous areas	
• Type of protection acc. to EN 50020 (CENELEC)	II 2 G (1) GD Ex ib[ia Ga][ia IIIC Da] IIC T4 GB and I M2 Ex ib[ia Ma] I Mb
• Type of protection acc. to KEMA	10 ATEX 0058
Dimensions	
Width	30 mm
Height	129 mm
Depth	136.5 mm
Weights	
Weight, approx.	299 g

I/O systemsSIMATIC ET 200 systems for the control cabinet
SIMATIC ET 200iSP**Safety-related electronics modules****Technical specifications** (continued)

Article number	6ES7138-7AA00-0AA0 ET 200iSP, RESERVE MODULE
Digital inputs	
Number of digital inputs	0
Standards, approvals, certificates	
CE mark	Yes
Use in hazardous areas	
• Type of protection acc. to EN 50020 (CENELEC)	II2 G EEx ib IIC T4
• Test number KEMA	04 ATEX 1251

Article number	6ES7138-7AA00-0AA0 ET 200iSP, RESERVE MODULE
Dimensions	
Width	30 mm
Height	129 mm
Depth	136.5 mm
Weights	
Weight, approx.	180 g

Ordering data**Article No.****Safety-related electronics modules**F digital input modules**8 F-DI Ex NAMUR**

For evaluating the signals from IEC 60947-5-6/NAMUR sensors and connected/non-connected mechanical contacts in hazardous and non-hazardous areas

- SIL3/Cat.3/PLe with 8 inputs (1-channel/1oo1 evaluation) or 4 inputs (2-channel/1oo2 evaluation)

6ES7138-7FN00-0AB0F digital output modules**4 F-DO Ex 17.4 V DC/40 mA**

For controlling actuators in hazardous and non-hazardous areas, e.g. solenoid valves, DC current relays or indicator lamps

- SIL 3/Cat. 3/PLe with 4 outputs, P/P-switching

6ES7138-7FD00-0AB0F analog input modules**4 F-AI Ex HART (0 ... 20 mA or 4 ... 20 mA)**

For evaluating the signals from current sensors in hazardous and non-hazardous areas, e.g. 2-wire transmitters and HART field devices

- SIL 3/Cat. 3/PLe with 4 inputs of one module (1-channel/1oo1 evaluation) or 4 inputs of two modules (2-channel/1oo2 evaluation)
- Resolution 15 bit + sign
- HART communication in measuring range 4 ... 20 mA

6ES7138-7FA00-0AB0**Article No.****Terminal modules****ET 200iSP terminal module TM-EM/EM60**

For two modules (reserve module, watchdog module and all electronics modules except 2 DO Relay can be plugged in)

- For hazardous environments
 - TM-EM/EM60S (blue screw-type terminals)
 - TM-EM/EM60C (blue spring-loaded terminals)
- For non-hazardous environments
 - TM-EM/EM60S (black screw-type terminals)

6ES7193-7CA00-0AA0**6ES7193-7CA10-0AA0****6ES7193-7CA20-0AA0****Accessories****Reserve module**

For any electronics module

6ES7138-7AA00-0AA0**Labeling sheet**

DIN A4, perforated, each consisting of 10 sheets of 30 strips each for electronics modules and 20 strips each for IM 151

- petrol
- yellow

6ES7193-7BH00-0AA0**6ES7193-7BB00-0AA0****Labels, inscribed**

for slot numbering, label size H x W (in mm): 5 x 7

- 204 labels, for slots 1 to 20
- 204 labels, for slots 1 to 40

8WA8361-0AB**8WA8361-0AC****Labels, blank**

136 labels for slot numbering, label size H x W (in mm): 5 x 7

8WA8348-2AY**S7-300 DIN rails**

- 585 mm long, suitable for assembly of ET 200iSP in a 650 mm-wide wall box
- 885 mm long, suitable for assembly of ET 200iSP in a 950 mm-wide wall box

6ES7390-1AF85-0AA0**6ES7390-1AJ85-0AA0**

Overview



The watchdog module has two fundamental functions:

- Monitoring of the ET 200iSP remote I/O station for hardware failures (hardware lifebeat); external, applicative failure monitoring is also possible via an I/O address area of the module
- Intrinsically-safe power supply for external actuator switch-off

The watchdog module must be plugged onto a terminal module (order separately). The following terminal modules are suitable for this:

- TM-IM/EM60 terminal modules for one interface module and one watchdog, reserve or electronics module (for versions, Interface module section)
- TM-EM/EM60 terminal modules with two slots for watchdog module, reserve module or electronics modules (except 2 DO relay):
 - with blue screw-type or spring-loaded terminals for hazardous environments
 - with black screw-type terminals for non-hazardous environments

The first slot directly next to the interface module is provided for the watchdog module.

Technical specifications

Article number	6ES7138-7BB00-0AB0 ET 200iSP, WATCHDOG MOD.
Digital inputs	
Number of digital inputs	0
Dimensions	
Width	30 mm
Height	129 mm
Depth	136.5 mm

Ordering data

Article No.

Watchdog module For failure monitoring and for the intrinsically safe power supply of an external actuator switch-off	6ES7138-7BB00-0AB0
Terminal modules	
ET 200iSP terminal module TM-EM/EM60 For two modules (reserve module, watchdog module and all electronics modules except 2 DO Relay can be plugged in)	
• For hazardous environments	
- TM-EM/EM60S (blue screw-type terminals)	6ES7193-7CA00-0AAA
- TM-EM/EM60C (blue spring-loaded terminals)	6ES7193-7CA10-0AAA
• For non-hazardous environments	
- TM-EM/EM60S (black screw-type terminals)	6ES7193-7CA20-0AAA
Accessories	
Labeling sheet DIN A4, perforated, each consisting of 10 sheets of 30 strips each for electronics modules and 20 strips each for IM 151	
• petrol	6ES7193-7BH00-0AAA
• yellow	6ES7193-7BB00-0AAA
Labels, inscribed for slot numbering, label size H × W (in mm): 5 × 7	
• 204 labels, for slots 1 to 20	8WA8361-0AB
• 204 labels, for slots 1 to 40	8WA8361-0AC
Labels, blank 136 labels for slot numbering, label size H × W (in mm): 5 × 7	8WA8348-2AY

I/O systems

SIMATIC ET 200 systems for the control cabinet
SIMATIC ET 200iSP

RS 485-iS coupler**Overview****Tasks of the RS 485-iS coupler**

- Conversion of the electrical PROFIBUS DP RS 485 transmission technology into the intrinsically safe RS 485-iS transmission technology with a transmission rate of 1.5 Mbps
- Required to connect intrinsically safe PROFIBUS DP stations, e.g. ET 200iSP or devices from other vendors with Ex i DP connection
- Acts as a safety barrier
- Additional use as a repeater in the hazardous area
- Passive bus station (no configuration necessary)
- Certified according to ATEX 100a

Technical specifications**Technical data RS 485-iS coupler****Dimensions and weight**

Dimensions W x H x D (mm)	80 x 125 x 130
Weight	Approx. 500 g

Technical data - General

Degree of protection	IP20
Ambient temperature	- 20 °C to + 60 °C

Standards and approvals

<ul style="list-style-type: none"> • PROFIBUS • EU directive • CENELEC • UL and CSA 	IEC 61784-1:2002 Ed1 CP 3/1 94/9/EG (ATEX 100a) II 3 (2) G EEx nA[ib] IIC T4 Class I, Division2, Group A, B, C, D T4 Class I Zone 2, Group IIC T4 AIS Class I, Division 1, Group A, B, C, D [Aexib] IIC, Class I, Zone1, 2, Group IIC
<ul style="list-style-type: none"> • FM 	Class I, Division2, Group A, B, C, D T4 Class I Zone 2, Group IIC T4 AIS Class I, Division 1, Group A, B, C, D [Aexib] IIC, Class I, Zone1, 2, Group IIC
<ul style="list-style-type: none"> • IEC • CE 	IEC61131-2, Part 2 Conforming with 89/336/EWG Conforming with 73/23/EWG
<ul style="list-style-type: none"> • Ship-building certification 	Classification companies <ul style="list-style-type: none"> • ABS (American Bureau of Shipping) • BV (Bureau Veritas) • DNV (Det Norske Veritas) • GL (Germanischer Lloyd) • LRD (Lloyds Register of Shipping) • Class NK (Nippon Kaiji Kyokai)

Module-Specific Specifications

Transfer rate on PROFIBUS DP, PROFIBUS RS 485-IS	9.6; 19.2; 45.45; 93.75; 187.5; 500 Kbps 1.5 Mbps
Bus-Protocol	PROFIBUS DP

Technical specifications (continued)

Technical data RS 485-iS coupler		
Voltages, Currents, Potentials		
Nominal supply voltage for RS 485-iS coupler	24 V DC (20.4 to 28.8 V)	
• Polarity reversal protection	Yes	
• Voltage drop bypass	Min. 5 ms	
Potential isolation for 24 V power supply		
• to PROFIBUS DP	Yes	
- tested with	500 V DC	
• to PROFIBUS RS 485-IS	Yes	
- tested with	AC 500 V	
Current consumption RS 485-iS coupler (24 V DC), max.	150 mA	
Power loss of the module, typically	3 Watts	
Status, alarms, diagnostics		
Status display	no	
Alarms	None	
Diagnostic functions	Yes	
• Bus monitoring PROFIBUS DP (primary)	Yellow LED "DP1"	
• Bus monitoring PROFIBUS RS 485-IS (secondary)	Yellow LED "DP2"	
• Monitoring 24 V power supply	Green LED "ON"	
Technical safety notice		
V_{DC}	± 4.2 V	
I_{SC}	± 93 mA	
P_0	0.1 Watts	
V_{max}	± 4.2 V	
L_i	0	
C_i	0	
U_m	AC 250 V	
T_a	-25 ... +60 °C	
RS 485-IS segment		
permitted cable length on a single line	RS 485-IS	DP Ex i
• 9.6 to 187.5 Kbps	1,000 m	200 m
• 500 Kbps	400 m	200 m
• 1.5 Mbps	200 m	200 m
Number of PROFIBUS DP nodes that can be connected, max.	31	16
PROFIBUS RS 485-IS bus termination switch	integrated, can be added	

Ordering data

RS 485-iS coupler
Isolating transformer for connection of PROFIBUS DP segments with RS 485 and RS 485-iS transmission technologies

6ES7972-0AC80-0XA0**Accessories**

PROFIBUS connector with selectable terminating resistor
For connection of IM 152 to PROFIBUS DP with RS 485-iS transmission technology

6ES7972-0DA60-0XA0**S7-300 rails**

Lengths:

- 160 mm
- 482 mm
- 530 mm
- 830 mm
- 2 000 mm

6ES7390-1AB60-0AA0
6ES7390-1AE80-0AA0
6ES7390-1AF30-0AA0
6ES7390-1AJ30-0AA0
6ES7390-1BC00-0AA0

PROFIBUS FastConnect bus cable

Standard type with special design for fast mounting, 2-core, shielded, cut-to-length; max. delivery unit 1 000 m, minimum order quantity 20 m

6XV1830-0EH10

I/O systems

SIMATIC ET 200 systems for the control cabinet
SIMATIC ET 200iSP

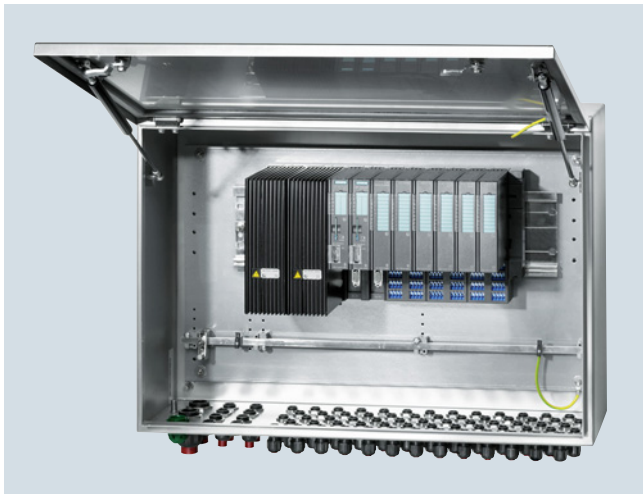
Stainless steel wall enclosure**Design**

ET 200iSP modules can also be installed in stainless steel wall enclosures designed to meet more exacting protection requirements. The enclosures are available in various sizes. They comply with IP65 degree of protection and can be used in Ex zones 1 and 21.

Delivery is possible as an empty enclosure (6DL2804-0....) or including components (6DL2804-1.... or 6DL2804-2....), depending on the order. Please send your requests to:

Siemens AG
PD PA AE SO
(please insert project name here)
Östl. Rheinbrückenstr. 50
76187 Karlsruhe, Germany

Email: cabinets.industry@siemens.com

Ordering data**Article No.**

Stainless steel enclosure IP65, protection class Ex e, suitable for Ex zones 1 and 21

Empty enclosure without installation of modules, for use in gas area (zones 1 and 2), IP65

Enclosure with hinged cover 650 x 450 x 230

For the installation of max. 15 ET 200iSP modules, for use in gas area, for temperature range -20 ... +70 °C, with equipotential bonding rail and cable inlets:

- 2 x M32 for infeed, 4 x M20 for bus cables, 39 x M16 (3 rows) for signal lines and 2 rows of blanking plugs, all cable inlets of black plastic **6DL2804-0AD30**
- 2 x M32 for infeed, 4 x M20 for bus cables, 39 x M16 (3 rows) for signal lines and 2 rows of blanking plugs, all cable inlets of metal, for extended temperature range -40 to +70 °C **6DL2804-0AD31**
- 2 x M32 for infeed, 4 x M20 for bus cables, 39 x M16 (3 rows) for signal lines and 2 rows of blanking plugs, cable inlets M20 and M16 of blue plastic, M32 of black plastic **6DL2804-0AD32**
- 2 x M32 for infeed, 4 x M20 for bus cables, 36 x M20 (3 rows) for signal lines and 2 rows of blanking plugs, cable inlets M20 of blue plastic, M32 of black plastic **6DL2804-0AD42**
- 2 x M32 for infeed, 4 x M20 for bus cables, 65 x M16 (5 rows) for signal lines, all cable inlets of black plastic **6DL2804-0AD50**
- 2 x M32 for infeed, 4 x M20 for bus cables, 65 x M16 (5 rows) for signal lines, all cable inlets of metal, for extended temperature range -40 ... +70 °C **6DL2804-0AD51**
- 2 x M32 for infeed, 4 x M20 for bus cables, 65 x M16 (5 rows) for signal lines, cable inlets M20 and M16 of blue plastic, M32 of black plastic **6DL2804-0AD52**
- 2 x M32 for infeed, 4 x M20 for bus cables, 60 x M20 (5 rows) for signal lines, cable inlets M20 of blue plastic, M32 of black plastic **6DL2804-0AD62**

Ordering data	Article No.	Article No.	
<p>Enclosure with hinged cover 950 x 450 x 230 For the installation of max. 25 ET 200iSP modules, for use in gas area, for temperature range -20 ... +70 °C, with equipotential bonding rail and cable inlets:</p> <ul style="list-style-type: none"> • 2 x M32 for infeed, 4 x M20 for bus cables, 66 x M16 (3 rows) for signal lines and 2 rows of blanking plugs, all cable inlets of black plastic • 2 x M32 for infeed, 4 x M20 for bus cables, 66 x M16 (3 rows) for signal lines and 2 rows of blanking plugs, all cable inlets of metal, for extended temperature range -40 to +70 °C • 2 x M32 for infeed, 4 x M20 for bus cables, 66 x M16 (3 rows) for signal lines and 2 rows of blanking plugs, cable inlets M20 and M16 of blue plastic, M32 of black plastic • 2 x M32 for infeed, 4 x M20 for bus cables, 57 x M20 (3 rows) for signal lines and 2 rows of blanking plugs, cable inlets M20 of blue plastic, M32 of black plastic • 2 x M32 for infeed, 4 x M20 for bus cables, 110 x M16 (5 rows) for signal lines, all cable inlets of black plastic • 2 x M32 for infeed, 4 x M20 for bus cables, 110 x M16 (5 rows) for signal lines, all cable inlets of black plastic • 2 x M32 for infeed, 4 x M20 for bus cables, 110 x M16 (5 rows) for signal lines, cable inlets M20 and M16 of blue plastic, M32 of black plastic • 2 x M32 for infeed, 4 x M20 for bus cables, 90 x M20 (5 rows) for signal lines, cable inlets M20 of blue plastic, M32 of black plastic 	<p>6DL2804-0AE30</p> <p>6DL2804-0AE31</p> <p>6DL2804-0AE32</p> <p>6DL2804-0AE42</p> <p>6DL2804-0AE50</p> <p>6DL2804-0AE51</p> <p>6DL2804-0AE52</p> <p>6DL2804-0AE62</p>	<p>Empty enclosure without installation of modules, for use in dust area (zones 21 and 22), IP65</p> <p>Enclosure with hinged cover 650 x 450 x 230 For the installation of max. 15 ET 200iSP modules, for use in dust area, for temperature range -20 ... +70 °C, with equipotential bonding rail and cable inlets:</p> <ul style="list-style-type: none"> • 2 x M32 for infeed, 4 x M20 for bus cables, 39 x M16 (3 rows) for signal lines and 2 rows of blanking plugs, all cable inlets of black plastic • 2 x M32 for infeed, 4 x M20 for bus cables, 39 x M16 (3 rows) for signal lines and 2 rows of blanking plugs, cable inlets M20 and M16 of blue plastic, M32 of black plastic • 2 x M32 for infeed, 4 x M20 for bus cables, 36 x M20 (3 rows) for signal lines and 2 rows of blanking plugs, cable inlets M20 of blue plastic, M32 of black plastic • 2 x M32 for infeed, 4 x M20 for bus cables, 65 x M16 (5 rows) for signal lines, all cable inlets of black plastic • 2 x M32 for infeed, 4 x M20 for bus cables, 65 x M16 (5 rows) for signal lines, cable inlets M20 and M16 of blue plastic, M32 of black plastic • 2 x M32 for infeed, 4 x M20 for bus cables, 60 x M20 (5 rows) for signal lines, cable inlets M20 of blue plastic, M32 of black plastic 	<p>6DL2804-0DD30</p> <p>6DL2804-0DD32</p> <p>6DL2804-0DD42</p> <p>6DL2804-0DD50</p> <p>6DL2804-0DD52</p> <p>6DL2804-0DD62</p>

I/O systemsSIMATIC ET 200 systems for the control cabinet
SIMATIC ET 200iSP**Stainless steel wall enclosure****Ordering data****Article No.****Article No.****Enclosure with hinged cover
950 x 450 x 230**

For the installation of max. 25 ET 200iSP modules, for use in dust area, for temperature range -20 ... +70 °C, with equipotential bonding rail and cable inlets:

- 2 x M32 for infeed, 4 x M20 for bus cables, 66 x M16 (3 rows) for signal lines and 2 rows of blanking plugs, all cable inlets of black plastic
- 2 x M32 for infeed, 4 x M20 for bus cables, 66 x M16 (3 rows) for signal lines and 2 rows of blanking plugs, cable inlets M20 and M16 of blue plastic, M32 of black plastic
- 2 x M32 for infeed, 4 x M20 for bus cables, 57 x M20 (3 rows) for signal lines and 2 rows of blanking plugs, cable inlets M20 of blue plastic, M32 of black plastic
- 2 x M32 for infeed, 4 x M20 for bus cables, 110 x M16 (5 rows) for signal lines, all cable inlets of black plastic
- 2 x M32 for infeed, 4 x M20 for bus cables, 110 x M16 (5 rows) for signal lines, cable inlets M20 and M16 of blue plastic, M32 of black plastic
- 2 x M32 for infeed, 4 x M20 for bus cables, 95 x M20 (5 rows) for signal lines, cable inlets M20 of blue plastic, M32 of black plastic

6DL2804-0DE30**6DL2804-0DE32****6DL2804-0DE42****6DL2804-0DE50****6DL2804-0DE52****6DL2804-0DE62****Empty enclosure without
installation of modules,
for use in mining (Cat. M2), IP65****Enclosure with hinged cover
650 x 450 x 230**

For the installation of max. 15 ET 200iSP modules, for use in mining (Cat. M2), for temperature range -20 to +70 °C, with equipotential bonding rail and cable inlets:

- 6 x M25 for infeed, 6 x M32 (1 row) for signal lines, all cable inlets of metal
- 6 x M25 for infeed, 12 x M32 (2 rows) for signal lines, all cable inlets of metal

6DL2804-0MD16**6DL2804-0MD26****Enclosure with hinged cover
950 x 450 x 230**

For the installation of max. 25 ET 200iSP modules, for use in mining (Cat. M2), for temperature range -20 to +70 °C, with equipotential bonding rail and cable inlets:

- 6 x M25 for infeed, 9 x M32 (1 row) for signal lines, all cable inlets of metal
- 6 x M25 for infeed, 18 x M32 (2 rows) for signal lines, all cable inlets of metal

6DL2804-0ME16**6DL2804-0ME26****Enclosure with installation of
ET 200iSP modules, for use in
gas area (zones 1 and 2), IP65****Enclosure with hinged cover
650 x 450 x 230**

For installation of max. 15 ET 200iSP modules, for use in gas area, for temperature range -20 ... +70 °C, with equipotential bonding rail and cable inlets:

- 2 x M32 for infeed, 4 x M20 for bus cables, 39 x M16 (3 rows) for signal lines and 2 rows of blanking plugs, all cable inlets of black plastic
- 2 x M32 for infeed, 4 x M20 for bus cables, 39 x M16 (3 rows) for signal lines and 2 rows of blanking plugs, all cable inlets of metal, minimum ambient operating temperature -30 °C (heater must be ordered separately)
- 2 x M32 for infeed, 4 x M20 for bus cables, 39 x M16 (3 rows) for signal lines and 2 rows of blanking plugs, cable inlets M20 and M16 of blue plastic, M32 of black plastic
- 2 x M32 for infeed, 4 x M20 for bus cables, 36 x M20 (3 rows) for signal lines and 2 rows of blanking plugs, cable inlets M20 of blue plastic, M32 of black plastic
- 2 x M32 for infeed, 4 x M20 for bus cables, 65 x M16 (5 rows) for signal lines, all cable inlets of black plastic
- 2 x M32 for infeed, 4 x M20 for bus cables, 65 x M16 (5 rows) for signal lines, all cable inlets of metal, minimum ambient operating temperature -30 °C (heater must be ordered separately)
- 2 x M32 for infeed, 4 x M20 for bus cables, 65 x M16 (5 rows) for signal lines, cable inlets M20 and M16 of blue plastic, M32 of black plastic
- 2 x M32 for infeed, 4 x M20 for bus cables, 60 x M20 (5 rows) for signal lines, cable inlets M20 of blue plastic, M32 of black plastic

6DL2804-1AD30**6DL2804-1AD31****6DL2804-1AD32****6DL2804-1AD42****6DL2804-1AD50****6DL2804-1AD51****6DL2804-1AD52****6DL2804-1AD62**

Ordering data	Article No.	Article No.	
<p>Enclosure with hinged cover 950 x 450 x 230 For the installation of max. 25 ET 200iSP modules, for use in gas area, for temperature range -20 ... +70 °C, with equipotential bonding rail and cable inlets:</p> <ul style="list-style-type: none"> • 2 x M32 for infeed, 4 x M20 for bus cables, 66 x M16 (3 rows) for signal lines and 2 rows of blanking plugs, all cable inlets of black plastic • 2 x M32 for infeed, 4 x M20 for bus cables, 66 x M16 (3 rows) for signal lines and 2 rows of blanking plugs, all cable inlets of metal, minimum ambient operating temperature -30 °C (heater must be ordered separately) • 2 x M32 for infeed, 4 x M20 for bus cables, 66 x M16 (3 rows) for signal lines and 2 rows of blanking plugs, cable inlets M20 and M16 of blue plastic, M32 of black plastic • 2 x M32 for infeed, 4 x M20 for bus cables, 57 x M20 (3 rows) for signal lines and 2 rows of blanking plugs, all cable inlets of metal, minimum ambient operating temperature -30 °C (heater must be ordered separately) • 2 x M32 for infeed, 4 x M20 for bus cables, 57 x M20 (3 rows) for signal lines and 2 rows of blanking plugs, cable inlets M20 of blue plastic, M32 of black plastic • 2 x M32 for infeed, 4 x M20 for bus cables, 110 x M16 (5 rows) for signal lines, all cable inlets of black plastic • 2 x M32 for infeed, 4 x M20 for bus cables, 110 x M16 (5 rows) for signal lines, all cable inlets of metal, minimum ambient operating temperature -30 °C (heater must be ordered separately) • 2 x M32 for infeed, 4 x M20 for bus cables, 110 x M16 (5 rows) for signal lines, cable inlets M20 and M16 of blue plastic, M32 of black plastic • 2 x M32 for infeed, 4 x M20 for bus cables, 95 x M20 (5 rows) for signal lines, all cable inlets of metal, minimum ambient operating temperature -30 °C (heater must be ordered separately) • 2 x M32 for infeed, 4 x M20 for bus cables, 90 x M20 (5 rows) for signal lines, cable inlets M20 of blue plastic, M32 of black plastic 	<p>6DL2804-1AE30</p> <p>6DL2804-1AE31</p> <p>6DL2804-1AE32</p> <p>6DL2804-1AE41</p> <p>6DL2804-1AE42</p> <p>6DL2804-1AE50</p> <p>6DL2804-1AE51</p> <p>6DL2804-1AE52</p> <p>6DL2804-1AE61</p> <p>6DL2804-1AE62</p>	<p>Enclosure with installation of ET 200iSP modules, for use in dust area (zones 21 and 22), IP65</p> <p>Enclosure with hinged cover 650 x 450 x 230 For the installation of max. 15 ET 200iSP modules, for use in dust area, for temperature range -20 ... +70 °C, with equipotential bonding rail and cable inlets:</p> <ul style="list-style-type: none"> • 2 x M32 for infeed, 4 x M20 for bus cables, 39 x M16 (3 rows) for signal lines and 2 rows of blanking plugs, all cable inlets of black plastic • 2 x M32 for infeed, 4 x M20 for bus cables, 39 x M16 (3 rows) for signal lines and 2 rows of blanking plugs, cable inlets M20 and M16 of blue plastic, M32 of black plastic • 2 x M32 for infeed, 4 x M20 for bus cables, 36 x M20 (3 rows) for signal lines and 2 rows of blanking plugs, cable inlets M20 of blue plastic, M32 of black plastic • 2 x M32 for infeed, 4 x M20 for bus cables, 65 x M16 (5 rows) for signal lines, all cable inlets of black plastic • 2 x M32 for infeed, 4 x M20 for bus cables, 65 x M16 (5 rows) for signal lines, all cable inlets of metal, minimum ambient operating temperature -30 °C (heater must be ordered separately) • 2 x M32 for infeed, 4 x M20 for bus cables, 65 x M16 (5 rows) for signal lines, cable inlets M20 and M16 of blue plastic, M32 of black plastic • 2 x M32 for infeed, 4 x M20 for bus cables, 60 x M20 (5 rows) for signal lines, cable inlets M20 of blue plastic, M32 of black plastic 	<p>6DL2804-1DD30</p> <p>6DL2804-1DD32</p> <p>6DL2804-1DD42</p> <p>6DL2804-1DD50</p> <p>6DL2804-1DD51</p> <p>6DL2804-1DD52</p> <p>6DL2804-1DD62</p>

I/O systems

SIMATIC ET 200 systems for the control cabinet
SIMATIC ET 200iSP

Stainless steel wall enclosure**Ordering data****Article No.****Article No.****Enclosure with hinged cover
950 x 450 x 230**

For the installation of max. 25 ET 200iSP modules, for use in dust area, for temperature range -20 ... +70 °C, with equipotential bonding rail and cable inlets:

- 2 x M32 for infeed, 4 x M20 for bus cables, 66 x M16 (3 rows) for signal lines and 2 rows of blanking plugs, all cable inlets of black plastic
- 2 x M32 for infeed, 4 x M20 for bus cables, 66 x M16 (3 rows) for signal lines and 2 rows of blanking plugs, cable inlets M20 and M16 of blue plastic, M32 of black plastic
- 2 x M32 for infeed, 4 x M20 for bus cables, 57 x M20 (3 rows) for signal lines and 2 rows of blanking plugs, cable inlets M20 of blue plastic, M32 of black plastic
- 2 x M32 for infeed, 4 x M20 for bus cables, 110 x M16 (5 rows) for signal lines, all cable inlets of black plastic
- 2 x M32 for infeed, 4 x M20 for bus cables, 110 x M16 (5 rows) for signal lines, cable inlets M20 and M16 of blue plastic, M32 of black plastic
- 2 x M32 for infeed, 4 x M20 for bus cables, 95 x M20 (5 rows) for signal lines, cable inlets M20 of blue plastic, M32 of black plastic

6DL2804-1DE30**6DL2804-1DE32****6DL2804-1DE42****6DL2804-1DE50****6DL2804-1DE52****6DL2804-1DE62****Enclosure with installation of
ET 200iSP modules, for use in
mining (Cat. M2), IP65****Enclosure with hinged cover
650 x 450 x 230**

For the installation of max. 15 ET 200iSP modules, for use in mining (Cat. M2), for temperature range -20 to +70 °C, with equipotential bonding rail and cable inlets:

- 6 x M25 for infeed, 6 x M32 (1 row) for signal lines, all cable inlets of metal
- 6 x M25 for infeed, 12 x M32 (2 rows) for signal lines, all cable inlets of metal

6DL2804-1MD16**6DL2804-1MD26****Enclosure with hinged cover
950 x 450 x 230**

For the installation of max. 25 ET 200iSP modules, for use in mining (Cat. M2), for temperature range -20 to +70 °C, with equipotential bonding rail and cable inlets:

- 6 x M25 for infeed, 9 x M32 (1 row) for signal lines, all cable inlets of metal
- 6 x M25 for infeed, 18 x M32 (2 rows) for signal lines, all cable inlets of metal

6DL2804-1ME16**6DL2804-1ME26****Enclosure with installation
of ET 200iSP and AirLINE
Ex modules, for use in gas area
(zones 1 and 2), IP65****Enclosure with hinged cover
650 x 450 x 230**

For the installation of max. 15 ET 200iSP modules, for use in gas area, for temperature range -20 ... +70 °C, with equipotential bonding rail and cable inlets:

- 2 x M32 for infeed, 4 x M20 for bus cables, 39 x M16 (3 rows) for signal lines and 2 rows of blanking plugs, all cable inlets of black plastic
- 2 x M32 for infeed, 4 x M20 for bus cables, 65 x M16 (5 rows) for signal lines, all cable inlets of black plastic
- 2 x M32 for infeed, 4 x M20 for bus cables, 60 x M20 (5 rows) for signal lines, cable inlets M20 of blue plastic, M32 of black plastic

6DL2804-2AD30**6DL2804-2AD50****6DL2804-2AD62****Enclosure with hinged cover
950 x 450 x 230**

For the installation of max. 25 ET 200iSP modules, for use in gas area, for temperature range -20 ... +70 °C, with equipotential bonding rail and cable inlets:

- 2 x M32 for infeed, 4 x M20 for bus cables, 66 x M16 (3 rows) for signal lines and 2 rows of blanking plugs, all cable inlets of black plastic
- 2 x M32 for infeed, 4 x M20 for bus cables, 110 x M16 (5 rows) for signal lines, all cable inlets of black plastic
- 2 x M32 for infeed, 4 x M20 for bus cables, 95 x M20 (5 rows) for signal lines, cable inlets M20 of blue plastic, M32 of black plastic

6DL2804-2AE30**6DL2804-2AE50****6DL2804-2AE62**

Ordering data	Article No.	Article No.	Article No.
Enclosure with installation of ET 200iSP and AirLINE Ex modules, for use in dust area (zones 21 and 22), IP65¹⁾		Enclosure with hinged cover 950 x 450 x 230 For installation of max. 25 ET 200iSP modules, for use in dust area, for temperature range -20 ... +70 °C, with equipotential bonding rail and cable inlets:	
Enclosure with hinged cover 650 x 450 x 230 For the installation of max. 15 ET 200iSP modules, for use in dust area, for temperature range -20 to +70 °C, with equipotential bonding rail and cable inlets: <ul style="list-style-type: none"> • 2 x M32 for infeed, 4 x M20 for bus cables, 36 x M20 (3 rows) for signal lines and 2 rows of blanking plugs, all cable inlets of black plastic 	6DL2804-2DD40	<ul style="list-style-type: none"> • 2 x M32 for infeed, 4 x M20 for bus cables, 57 x M20 (3 rows) for signal lines and 2 rows of blanking plugs, all cable inlets of black plastic • 2 x M32 for infeed, 4 x M20 for bus cables, 110 x M16 (5 rows) for signal lines, all cable inlets of black plastic 	6DL2804-2DE40 6DL2804-2DE50
		Special configurations	For individual configurations that deviate from the standard configurations, we would be happy to prepare an offer tailored to your needs. Please direct your request to cabinets.industry@siemens.com

¹⁾ The AirLINE Ex components (see catalog "Add-ons for SIMATIC PCS 7") must be ordered separately.

I/O systems

SIMATIC ET 200 systems without control cabinet

SIMATIC ET 200pro

Overview

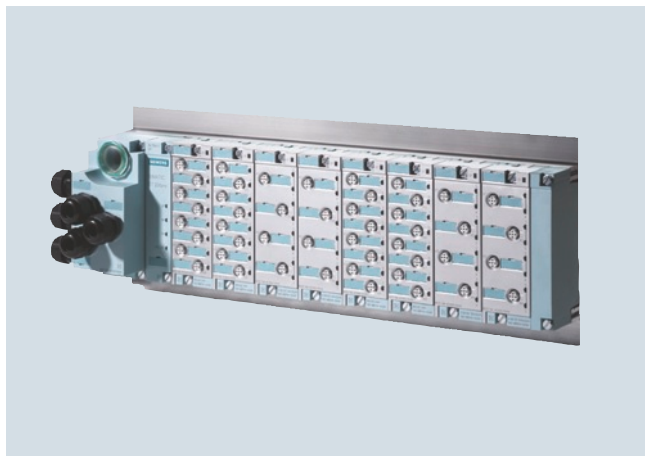

- SIMATIC ET 200pro distributed I/O system with IP65/67 degree of protection for cabinet-free use at the machine
- Small, multifunctional complete solution: Digital inputs/outputs, fail-safe modules, motor starters up to 5.5 kW, etc.
- Communication over PROFIBUS or PROFINET
- Mixed arrangement of fail-safe and standard modules in the same station
- Freely selectable connection technique: direct, ECOFAST or M12 7/8"
- Power module for easy implementation of load groups
- Module replacement during operation (hot swapping)
- Easy installation as well as permanent wiring
- Transmission rate for PROFIBUS DP up to 12 Mbps
- Extensive diagnostics: module-specific or channel-specific
- Intelligent motor starters for starting and protection of motors and loads up to 5.5 kW
 - Versions: direct and reversing starters - Standard and High Feature
- Fail-safe motor starters
- Fail-safe modules with safety-related signal processing according to PROFIsafe
- Frequency converters
- RFID communication modules
- Pneumatic interface modules

Technical specifications

General technical specifications

Electronic modules	<ul style="list-style-type: none"> • Digital inputs/outputs • Analog inputs • Analog outputs
Connections	M12 and M8 round connector with standard assignment for actuator/sensor
Transmission rate, max.	12 Mbit/s (PROFIBUS DP), 100 Mbit/s (PROFINET IO)
Supply voltage	24 V DC
Current consumption of one ET 200pro (internal and encoder supply, non-switched voltage), up to 55 °C, max.	≤ 5 A
Load current for ET 200pro per incoming supply (IM, PM, switched voltage), up to 55 °C, max.	10 A
For overall configuration with looping through (multiple ET 200pros), up to 55 °C, max.	16 A (with connecting module, directly)
Degree of protection	IP65/66/IP67 for interface, digital and analog modules
Material	Thermoplastic (reinforced with glass fiber)

Environmental conditions

Temperature	From -25 °C/0 °C to +55 °C
Relative humidity	From 5 to 100%
Air pressure	From 795 to 1080 hPa

Mechanical stress

- Vibration
 - Vibration test according to IEC 60068, Part 2-6 (sinusoidal)
 - Constant acceleration 5 g, occasionally 10 g for interface, digital and analog modules
 - 2 g motor starters
- Shock
 - Shock test according to IEC 680068 Part 2-27, half-sine, 30 g, 18 ms duration for interface, digital and analog modules
 - 15 g, 11 ms duration for motor starters

Approvals	UL, CSA or cULus
-----------	------------------

Overview



Interface modules for handling communication between the ET 200pro and the higher-level master over PROFIBUS DP.

Technical specifications

Article number	6ES7154-1AA01-0AB0 ET 200PRO, IM 154-1 DP	6ES7154-2AA01-0AB0 ET 200PRO, IM154-2 DP HF
Supply voltage		
Rated value (DC)	24 V	24 V
Reverse polarity protection	Yes; against destruction	Yes; against destruction
Short-circuit protection	Yes; over exchangeable fuses	Yes; over exchangeable fuses
Load voltage 2L+		
• Rated value (DC)	24 V	24 V
• Reverse polarity protection	Yes; against destruction	Yes; against destruction
Input current		
from supply voltage 1L+, max.	200 mA	200 mA
Power loss		
Power loss, typ.	5 W	5 W
Address area		
Addressing volume		
• Inputs	244 byte	244 byte
• Outputs	244 byte	244 byte
Interfaces		
Interfaces/bus type	PROFIBUS DP	PROFIBUS DP
Interface physics, RS 485	Yes	Yes
PROFIBUS DP		
• automatic detection of transmission rate	Yes	Yes
• Transmission rate, min.	9.6 kbit/s	9.6 kbit/s
• Transmission rate, max.	12 Mbit/s	12 Mbit/s
• SYNC capability	Yes	Yes
• FREEZE capability	Yes	Yes
• Direct data exchange (slave-to-slave communication)	Yes	Yes
Interrupts/diagnostics/status information		
Alarms		
• Diagnostic alarm	Yes; Parameterizable	Yes; Parameterizable
• Hardware interrupt	Yes; Parameterizable	Yes; Parameterizable
Diagnostics indication LED		
• Bus fault BF (red)	Yes	Yes
• Group error SF (red)	Yes	Yes
• Monitoring 24 V voltage supply ON (green)	Yes	Yes
• Load voltage monitoring 24 V DC (green)	Yes	Yes

I/O systems

SIMATIC ET 200 systems without control cabinet

SIMATIC ET 200pro

Interface modules > IM 154-1 and IM 154-2**Technical specifications** (continued)

Article number	6ES7154-1AA01-0AB0 ET 200PRO, IM 154-1 DP	6ES7154-2AA01-0AB0 ET 200PRO, IM154-2 DP HF
Parameter		
DPV1 operation	possible	possible
Swapping interrupt	Parameterizable	Parameterizable
Startup if setpoint not equal to actual configuration	Parameterizable	Parameterizable
Potential separation		
between supply voltage and electronics	Yes	Yes
Isolation		
Isolation tested with	707 V DC (type test)	707 V DC (type test)
Degree and class of protection		
Degree of protection acc. to EN 60529		
• IP67	Yes	Yes
Ambient conditions		
Ambient temperature during operation		
• min.	-25 °C	-25 °C
• max.	55 °C	55 °C
Ambient temperature during storage/transportation		
• min.	-40 °C	-40 °C
• max.	70 °C	70 °C
Dimensions		
Width	90 mm	90 mm
Height	130 mm	130 mm
Depth	59.3 mm	59.3 mm
Weights		
Weight, approx.	375 g	375 g

Ordering data	Article No.	Article No.
IM154-1 interface module For ET 200pro; for communication between ET 200pro and higher-level masters over PROFIBUS DP.	6ES7154-1AA01-0AB0	
IM154-2 DP High Feature interface module For ET 200pro; for communication between ET 200pro and higher-level masters over PROFIBUS DP; supports PROFI-safe.	6ES7154-2AA01-0AB0	
Accessories		
CM IM DP ECOFAST connection module For connecting PROFIBUS DP and the 24 V power supply to PROFIBUS interface modules, 2 ECOFAST Cu connections.	6ES7194-4AA00-0AA0	
CM IM DP direct connection module For connecting PROFIBUS DP and the 24 V power supply directly to PROFIBUS interface modules, up to six M20 cable glands.	6ES7194-4AC00-0AA0	
CM IM DP M12, 7/8" connection module For connecting PROFIBUS DP and the 24 V power supply to PROFIBUS interface modules, 2 x M12 and 2 x 7/8".	6ES7194-4AD00-0AA0	
Accessories for CM IM DP ECOFAST		
PROFIBUS ECOFAST hybrid cable, pre-assembled With 2 ECOFAST connectors, trailing-type cable with 2 x Cu 0.64 mm ² and 4 x Cu 1.5 mm ² , in various lengths:		
1.5 m	6XV1830-7BH15	
3.0 m	6XV1830-7BH30	
5.0 m	6XV1830-7BH50	
10 m	6XV1830-7BN10	
15 m	6XV1830-7BN15	
20 m	6XV1830-7BN20	
PROFIBUS ECOFAST hybrid cable GP, pre-assembled With 2 ECOFAST connectors, trailing-type cable with 2 x Cu 0.64 mm ² and 4 x Cu 1.5 mm ² , in various lengths:		
1.5 m	6XV1860-3PH15	
3.0 m	6XV1860-3PH30	
5.0 m	6XV1860-3PH50	
10 m	6XV1860-3PN10	
15 m	6XV1860-3PN15	
20 m	6XV1860-3PN20	
PROFIBUS ECOFAST hybrid cable, non-assembled Trailing-type cable with 2 x Cu 0.64 mm ² and 4 x Cu 1.5 mm ² , in various lengths:		
50 m	6XV1830-7AN50	
100 m	6XV1830-7AT10	
PROFIBUS ECOFAST hybrid connector 180 ECOFAST Cu, 2 x Cu, 4 x 1.5 mm ² , HANBRID connector		
• With male insert, 5-pack	6GK1905-0CA00	
• With female insert, 5-pack	6GK1905-0CB00	
PROFIBUS ECOFAST hybrid connector angular ECOFAST Cu, 2 x Cu, 4 x 1.5 mm ² , HANBRID connector		
• With male insert, 5-pack	6GK1905-0CC00	
• With female insert, 5-pack	6GK1905-0CD00	
Accessories for CM IM DP direct		
PROFIBUS trailing cable	6XV1830-3EH10	
Max. acceleration 4 m/s ² , at least 3 million bending cycles, bending radius at least 60 mm, 2-core shielded, sold by the meter, minimum order quantity 20 m, maximum order quantity 1 000 m.		
PROFIBUS FC Food bus cable	6XV1830-0GH10	
With PE sheath for use in the food and beverages industry, 2-core, shielded, sold by the meter, minimum order quantity 20 m, maximum order quantity 1 000 m.		
PROFIBUS FC Robust bus cable	6XV1830-0JH10	
With PUR sheath for use in environments subject to harsh chemicals and extreme mechanical stress, 2-core, shielded, sold by the meter, minimum order quantity 20 m, maximum order quantity 1 000 m.		
Power line	6XV1830-8AH10	
5-core, 5 x 1.5 mm ² , trailing type, sold by the meter, minimum order quantity 20 m, maximum order quantity 1 000 m.		

I/O systems

SIMATIC ET 200 systems without control cabinet
SIMATIC ET 200pro

Interface modules > IM 154-1 and IM 154-2

Ordering data	Article No.	Ordering data	Article No.
Accessories for CM IM DP M12, 7/8"		General accessories	
PROFIBUS M12 connecting cable		ET 200pro rack	
Pre-assembled with two M12 connectors, 5-pin, in various lengths:		<ul style="list-style-type: none"> Narrow, for interface, electronics and power modules <ul style="list-style-type: none"> - 500 mm - 1000 mm - 2000 mm, can be cut to length Compact, for interface, electronics and power modules <ul style="list-style-type: none"> - 500 mm - 1000 mm - 2000 mm, can be cut to length Wide, for interface, electronics, power modules and motor starters <ul style="list-style-type: none"> - 500 mm - 1000 mm - 2000 mm, can be cut to length Wide, for I/O modules and motor starters <ul style="list-style-type: none"> - 500 mm - 1000 mm - 2000 mm 	6ES7194-4GA00-0AA0 6ES7194-4GA60-0AA0 6ES7194-4GA20-0AA0 6ES7194-4GC70-0AA0 6ES7194-4GC60-0AA0 6ES7194-4GC20-0AA0 6ES7194-4GB00-0AA0 6ES7194-4GB60-0AA0 6ES7194-4GB20-0AA0 6ES7194-4GD00-0AA0 6ES7194-4GD10-0AA0 6ES7194-4GD20-0AA0
1.5 m	6XV1830-3DH15	Spare fuse	6ES7194-4HB00-0AA0
2.0 m	6XV1830-3DH20	12.5 A fast-blow, for interface and power modules, 10 units per pack.	
3.0 m	6XV1830-3DH30	PROFIBUS FastConnect bus cable	6XV1830-0EH10
5.0 m	6XV1830-3DH50	Standard type with special design for quick mounting, 2-core, shielded, sold by the meter, max. delivery unit 1 000 m, minimum order quantity 20 m.	
10 m	6XV1830-3DN10	PROFIBUS Hybrid Standard Cable GP	6XV1860-2R
15 m	6XV1830-3DN15	Standard PROFIBUS hybrid cable with 2 energy cables (1.5 mm ²) for supplying data and energy for ET 200pro.	
7/8" connecting cable to power supply		SIMATIC Manual Collection	6ES7998-8XC01-8YE0
5-core, 5 x 1.5 mm ² , trailing type, pre-assembled with two 7/8" connectors, 5-pin, in various lengths:		Electronic manuals on DVD, multi-language: S7-200, TD 200, S7-300, M7-300, C7, S7-400, M7-400, STEP 7, Engineering Tools, Runtime Software, SIMATIC DP (Distributed I/O), SIMATIC HMI (Human Machine Interface), SIMATIC NET (Industrial Communication).	
1.5 m	6XV1822-5BH15	SIMATIC Manual Collection update service for 1 year	6ES7998-8XC01-8YE2
2.0 m	6XV1822-5BH20	Scope of delivery: Current DVD "S7 Manual Collection" and the three subsequent updates.	
3.0 m	6XV1822-5BH30		
5.0 m	6XV1822-5BH50		
10 m	6XV1822-5BN10		
15 m	6XV1822-5BN15		
M12 cable connector			
For ET 200eco, with axial cable outlet.			
<ul style="list-style-type: none"> With male insert, 5-pack With female insert, 5-pack 	6GK1905-0EA00 6GK1905-0EB00		
PROFIBUS M12 bus termination connector	6GK1905-0EC00		
With male insert.			
7/8" cable connector			
For ET 200eco, with axial cable outlet.			
<ul style="list-style-type: none"> With male insert, 5-pack With female insert, 5-pack 	6GK1905-0FA00 6GK1905-0FB00		
M12 sealing cap	3RX9802-0AA00		
For protection of unused M12 connections with ET 200pro.			
Sealing cap 7/8"	6ES7194-3JA00-0AA0		
For protection of unused 7/8" connections with ET 200pro; 10 units per pack.			

Overview



Interface module for processing the communication between ET 200pro and a higher-level controller over PROFINET IO.

Technical specifications

Article number	6ES7154-4AB10-0AB0 ET 200PRO, IM 154-4 PN HF
Supply voltage	
Rated value (DC)	24 V
Reverse polarity protection	Yes; against destruction
Short-circuit protection	Yes; Fuse in lower part is exchangeable, the fuse on the IM-LP is not
Load voltage 2L+	
• Rated value (DC)	24 V
• Reverse polarity protection	Yes; against destruction
Input current	
from supply voltage 1L+, max.	400 mA; Dependent on terminal module, typ. maximum value for FO connection method, full load on RWB and 20.4 V input voltage
Power loss	
Power loss, typ.	6 W; Dependent on terminal module, typ. maximum value for CU connection method, full load on RWB, for FO the value is approx. 0.7 W higher
Memory	
Micro Memory Card	No; Internal memory medium
Address area	
Addressing volume	
• Inputs	256 byte
• Outputs	256 byte
Interfaces	
PROFINET IO	
• automatic detection of transmission rate	Yes
• Transmission rate, max.	100 Mbit/s
• Services	ARP, PING, SNMP
Interrupts/diagnostics/status information	
Alarms	
• Diagnostic alarm	Yes; Parameterizable
• Hardware interrupt	Yes; Parameterizable

Article number	6ES7154-4AB10-0AB0 ET 200PRO, IM 154-4 PN HF
Diagnostics indication LED	
• Bus fault BF (red)	Yes; Additional LEDs (MAINT, P1/2 LINK, P1/2 RX/TX) available
• Group error SF (red)	Yes
• Monitoring 24 V voltage supply ON (green)	Yes
• Load voltage monitoring 24 V DC (green)	Yes
Parameter	
Swapping interrupt	1
Startup if setpoint not equal to actual configuration	1
Hot swapping of modules	1
Potential separation	
between backplane bus and electronics	No
between supply voltage and electronics	Yes
Isolation	
Isolation tested with	707 V DC (type test)
Degree and class of protection	
Degree of protection acc. to EN 60529	
• IP65	Yes
• IP66	Yes
• IP67	Yes
Ambient conditions	
Ambient temperature during operation	
• min.	-25 °C
• max.	55 °C
Ambient temperature during storage/transportation	
• min.	-40 °C
• max.	70 °C
Dimensions	
Width	135 mm
Height	130 mm
Depth	59.3 mm
Weights	
Weight, approx.	490 g

I/O systemsSIMATIC ET 200 systems without control cabinet
SIMATIC ET 200pro**Interface modules > IM 154-4 PN**

Ordering data	Article No.	Article No.
IM 154-4 PN High Feature interface module For communication between ET 200pro and higher-level controllers over PROFINET IO; Supports PROFI-safe.	6ES7 154-4AB10-0AB0	
Accessories		
CM IM PN connection module M12, 7/8" For connecting PROFINET PN and 24 V power supply to PROFINET interface modules, 2 x M12 and 2 x 7/8".	6ES7 194-4AJ00-0AA0	
CM IM PN connection module 2xRJ45 For connecting PROFINET PN and 24 V power supply to PROFINET interface modules, 2 x RJ45 and 2 x push-pull power connector.	6ES7 194-4AF00-0AA0	
CM IM PN 2xSCRJ FO connection module For connecting PROFINET PN and 24 V power supply to PROFINET interface modules, 2 x SCRJ FO and 2 x push-pull power connector.	6ES7 194-4AG00-0AA0	
M12 sealing cap For protection of unused M12 connections with ET 200pro.	3RX9 802-0AA00	
IE M12 connecting cables Pre-assembled with two M12 connectors, up to 85 m, in various lengths: 0.3 m 0.5 m 1.0 m 1.5 m 2.0 m 3.0 m 5.0 m 10 m 15 m Other special lengths with 90° or 180° cable outlet.	6XV1 870-8AE30 6XV1 870-8AE50 6XV1 870-8AH10 6XV1 870-8AH15 6XV1 870-8AH20 6XV1 870-8AH30 6XV1 870-8AH50 6XV1 870-8AN10 6XV1 870-8AN15 See http://support.automation.siemens.com/WW/view/en/26999294	
7/8" sealing caps 1 pack = 10 units	6ES7 194-3JA00-0AA0	
		7/8" connecting cable to power supply 5-core, 5 x 1.5 mm ² , trailing type, pre-assembled with two 7/8" connectors, 5-pin, up to 50 m, in various lengths: 1.5 m 2.0 m 3.0 m 5.0 m 10 m 15 m Other special lengths with 90° or 180° cable outlet.
		Power line 5-core, 5 x 1.5 mm ² , trailing type, sold by the meter, minimum order quantity 20 m, maximum order quantity 1 000 m.
		7/8" cable connector For ET 200eco, with axial cable outlet. <ul style="list-style-type: none"> • With male insert, 5-pack • With female insert, 5-pack
		Industrial Ethernet FastConnect installation cables <ul style="list-style-type: none"> • IE FC TP Standard Cable GP 2 x 2; Sold by the meter, max. delivery unit 1 000 m; minimum order quantity 20 m. • IE FC TP Trailing Cable 2 x 2; Sold by the meter, max. order quantity 1000 m; minimum order quantity 20 m. • IE FC TP Trailing Cable GP 2 x 2; sold by the meter, max. delivery unit 1000 m; minimum order quantity 20 m. • IE TP Torsion Cable GP 2 x 2; sold by the meter, max. delivery unit 1000 m; minimum order quantity 20 m. • IE FC TP Marine Cable 2 x 2; Sold by the meter, max. order quantity 1000 m; minimum order quantity 20 m.
		6XV1 822-5BH15 6XV1 822-5BH20 6XV1 822-5BH30 6XV1 822-5BH50 6XV1 822-5BN10 6XV1 822-5BN15 See http://support.automation.siemens.com/WW/view/en/26999294
		6XV1 830-8AH10
		6GK1 905-0FA00 6GK1 905-0FB00
		6XV1 840-2AH10 6XV1 840-3AH10 6XV1 870-2D 6XV1 870-2F 6XV1 840-4AH10

Ordering data	Article No.	Article No.
IE RJ45 Plug PRO RJ45 plug in IP65/67-rated design for on-site assembly, plastic housing, insulation/displacement connection system, for SCALANCE X-200 IRT PRO and ET 200pro: 1 pack = 1 unit.	6GK1901-1BB10-6AA0	
IE SC RJ POF Plug PRO SC RJ plug for POF fibers in IP65/67-rated design for on-site assembly, plastic housing, for SCALANCE X-200IRT PRO and ET 200pro 1 pack = 1 unit	6GK1900-0MB00-6AA0	
IE SC RJ PCF Plug PRO SC RJ plug for PCF fibers in IP65/67-rated design for on-site assembly, plastic housing, for SCALANCE X-200IRT PRO 1 pack = 1 unit.	6GK1900-0NB00-6AA0	
Power Plug PRO 5-pole power plug for 2 x 24 V power supply in IP65/67-rated design, for on-site assembly, plastic housing, for SCALANCE X-200IRT and ET 200 pro 1 pack = 1 unit.	6GK1907-0AB10-6AA0	
IE panel feed-through Control cabinet feedthrough for converting M12 D-coded connection system (IP65) to RJ45 connection system (IP20) • 1 pack = 5 units	6GK1901-0DM20-2AA5	
Push-pull cable connector For 1L+/ 2L+, unassembled	6GK1907-0AB10-6AA0	
Cover caps for push-pull RJ45 female connectors 5 items per pack	6ES7194-4JD50-0AA0	
		General accessories ET 200pro rack <ul style="list-style-type: none"> Narrow, for interface, electronics and power modules <ul style="list-style-type: none"> - 500 mm - 1000 mm - 2000 mm, can be cut to length Compact, for interface, electronics and power modules <ul style="list-style-type: none"> - 500 mm - 1000 mm - 2000 mm, can be cut to length Wide, for interface, electronics, power modules and motor starters <ul style="list-style-type: none"> - 500 mm - 1000 mm - 2000 mm, can be cut to length Wide, for I/O modules and motor starters <ul style="list-style-type: none"> - 500 mm - 1000 mm - 2000 mm
		6ES7194-4GA00-0AA0 6ES7194-4GA60-0AA0 6ES7194-4GA20-0AA0 6ES7194-4GC70-0AA0 6ES7194-4GC60-0AA0 6ES7194-4GC20-0AA0 6ES7194-4GB00-0AA0 6ES7194-4GB60-0AA0 6ES7194-4GB20-0AA0 6ES7194-4GD00-0AA0 6ES7194-4GD10-0AA0 6ES7194-4GD20-0AA0 Spare fuse 12.5 A fast-blow, for interface and power modules, 10 units per pack 6ES7194-4HB00-0AA0
		SIMATIC Manual Collection Electronic manuals on DVD, multi-language: S7-200, TD 200, S7-300, M7-300, C7, S7-400, M7-400, STEP 7, Engineering Tools, Runtime Software, SIMATIC DP (Distributed I/O), SIMATIC HMI (Human Machine Interface), SIMATIC NET (Industrial Communication) 6ES7998-8XC01-8YE0
		SIMATIC Manual Collection update service for 1 year Scope of delivery: Current DVD "S7 Manual Collection" and the three subsequent updates 6ES7998-8XC01-8YE2

I/O systems

SIMATIC ET 200 systems without control cabinet
SIMATIC ET 200pro

I/O modules > Digital expansion modules**Overview**

- Expansion modules with digital inputs/outputs for connection of actuators/sensors
- With scalable diagnostics
 - Standard modules with module-specific diagnostics
 - High-feature module with channel-specific diagnostics and parameterizable input delay or hardware interrupts
- Double or single assignment can be implemented for each M12 in the case of the 8 DI and 8 DO module by selecting CM IO 4 x M12 or CM IO 8 x M12
- IO connection modules are available in metal and plastic versions

Technical specifications

Article number	6ES7141-4BF00-0AA0	6ES7141-4BF00-0AB0	6ES7141-4BH00-0AA0
	ET 200PRO, EM 8DI 24 V DC	ET 200PRO, EM 8DI 24 V DC HF	ET 200PRO, EM 16DI DC 24 V
Supply voltage			
Rated value (DC)	24 V	24 V	24 V
Reverse polarity protection	Yes; Against destruction; encoder power supply outputs applied with reversed polarity	Yes; against destruction; load increasing	Yes; Against destruction; encoder power supply outputs applied with reversed polarity
Input current			
from supply voltage 1L+, max.	20 mA	40 mA	30 mA
from backplane bus 3.3 V DC, max.	20 mA	20 mA	20 mA
Encoder supply			
Number of outputs	8	8	8
Short-circuit protection	Yes; per module, electronic	Yes; per channel, electronic	Yes; per module, electronic
Output current			
• up to 55 °C, max.	1 A	1 A	1 A
Power loss			
Power loss, typ.	2.5 W	2.5 W	3 W
Address area			
Occupied address area			
• Inputs	1 byte	1 byte	2 byte
Digital inputs			
Number of digital inputs	8	8	16
Input characteristic curve in accordance with IEC 61131, type 1	Yes	No	Yes
Input characteristic curve in accordance with IEC 61131, type 2	No	Yes	
Number of simultaneously controllable inputs			
all mounting positions			
- up to 55 °C, max.	8	8	16
Input voltage			
• Rated value (DC)	24 V	24 V	24 V
• for signal *0*	-3 to +5V	-3 to +5V	-3 to +5V
• for signal *1*	13 to 30V	+11 to +30V	+11 to +30V
Input current			
• for signal *1*, typ.	7 mA	7 mA	4 mA
Input delay (for rated value of input voltage) for standard inputs			
- parameterizable	No	Yes	No
- at *0* to *1*, min.	1.2 ms	0.5 ms; 0.5 ms/ 3ms/ 15 ms/ 20 ms	1.2 ms
- at *0* to *1*, max.	4.8 ms	20 ms	4.8 ms
- at *1* to *0*, min.	1.2 ms	0.5 ms; 0.5 ms/ 3ms/ 15 ms/ 20 ms	0.7 ms
- at *1* to *0*, max.	4.8 ms	20 ms	3 ms

Technical specifications (continued)

Article number	6ES7141-4BF00-0AA0 ET 200PRO, EM 8DI 24 V DC	6ES7141-4BF00-0AB0 ET 200PRO, EM 8DI 24 V DC HF	6ES7141-4BH00-0AA0 ET 200PRO, EM 16DI DC 24 V
Cable length			
• shielded, max.	30 m	30 m	30 m
• unshielded, max.	30 m	30 m	30 m
Encoder			
Connectable encoders			
• 2-wire sensor	Yes	Yes	Yes
- permissible quiescent current (2-wire sensor), max.	1.5 mA	1.5 mA	1.5 mA
Isochronous mode			
Isochronous operation (application synchronized up to terminal)	No	No	No
Interrupts/diagnostics/status information			
Diagnostic functions	Yes	Yes; channel by channel, parameterizable	Yes
Alarms			
• Diagnostic alarm	Yes	Yes	Yes
Diagnostic messages			
• Diagnostic information readable	Yes	Yes	Yes
• Wire-break		Yes; Monitoring, I < 0.3 mA	
• Short-circuit	Yes; Sensor supply to M; module by module	Yes	Yes; Sensor supply to M; module by module
Diagnostics indication LED			
• Group error SF (red)	Yes	Yes	Yes
• Status indicator digital input (green)	Yes; Per channel	Yes; Per channel	Yes; Per channel
Parameter			
Diagnostics wire break		channel by channel	
Diagnostics short-circuit	Sensor supply to M; module by module	channel by channel	
Potential separation			
between backplane bus and all other circuit components	Yes	Yes	Yes
Potential separation digital inputs			
• between the channels	No	No	No
• between the channels and backplane bus	Yes	Yes	Yes
Isolation			
Isolation tested with	707 V DC (type test)	707 V DC (type test)	707 V DC (type test)
Dimensions			
Width	45 mm	45 mm	45 mm
Height	130 mm	130 mm	130 mm
Depth	35 mm	35 mm; without terminal module	35 mm
Weights			
Weight, approx.	140 g	140 g	140 g

Article number	6ES7142-4BD00-0AA0 ET 200PRO, EM 4DO 24V DC/2.0A	6ES7142-4BD00-0AB0 ET 200PRO, EM 4DO 24VDC/2.0A HF	6ES7142-4BF00-0AA0 ET 200PRO, EM 8DO DC24V/0.5A
Supply voltage			
Load voltage 2L+			
• Rated value (DC)	24 V	24 V	24 V
• Short-circuit protection	Yes; per channel, electronic	Yes; per channel, electronic	Yes; per channel, electronic
• Reverse polarity protection	Yes; against destruction; load increasing	Yes; against destruction; load increasing	Yes; against destruction; load increasing
Input current			
from load voltage 2L+ (without load), max.	20 mA	40 mA	30 mA
from backplane bus 3.3 V DC, max.	20 mA	30 mA	30 mA
Power loss			
Power loss, typ.	2 W	2.5 W	2 W
Address area			
Address space per module			
• with packing	4 bit	4 bit	8 bit
• without packing	1 byte	1 byte	1 byte

I/O systems

SIMATIC ET 200 systems without control cabinet

SIMATIC ET 200pro

I/O modules > Digital expansion modules**Technical specifications (continued)**

Article number	6ES7142-4BD00-0AA0 ET 200PRO, EM 4DO 24V DC/2.0A	6ES7142-4BD00-0AB0 ET 200PRO, EM 4DO 24VDC/2.0A HF	6ES7142-4BF00-0AA0 ET 200PRO, EM 8DO DC24V/0.5A
Digital outputs			
Number of digital outputs	4	4	8
Short-circuit protection	Yes	Yes	Yes
• Response threshold, typ.	2.8 A	2.8 A	0.7 A
Limitation of inductive shutdown voltage to	2L+ (-47 V)	2L+ (-47 V)	2L+ (-47 V)
Controlling a digital input	Yes	Yes	Yes; Isolation between 1L+ and 2L+ is no longer provided, as 1M and 2M are jumpered
Switching capacity of the outputs			
• on lamp load, max.	10 W	10 W	5 W
Load resistance range			
• lower limit	12 Ω	12 Ω	48 Ω
• upper limit	4 kΩ	4 kΩ	4 kΩ
Output voltage			
• for signal "1", min.	2L+ (-0,8 V)	2L+ (-0,8 V)	2L+ (-0,8 V)
Output current			
• for signal "1" rated value	2 A	2 A	0.5 A
• for signal "0" residual current, max.	0.5 mA	0.5 mA	0.5 mA
Parallel switching of two outputs			
• for uprating	No	No	No
• for redundant control of a load	Yes	Yes	Yes
Switching frequency			
• with resistive load, max.	100 Hz	100 Hz	100 Hz
• with inductive load, max.	0.5 Hz	0.5 Hz	0.5 Hz
• on lamp load, max.	1 Hz	1 Hz	1 Hz
Total current of the outputs (per group)			
all mounting positions			
- up to 55 °C, max.	4 A	4 A	4 A
Cable length			
• shielded, max.	30 m	30 m	30 m
• unshielded, max.	30 m	30 m	30 m
Interrupts/diagnostics/status information			
Diagnostic functions	Yes	Yes	Yes
Substitute values connectable		Yes	
Alarms			
• Diagnostic alarm	Yes	Yes	Yes
Diagnostic messages			
• Diagnostic information readable	Yes	Yes	Yes
• Wire-break		Yes	
• Short-circuit	Yes; Short-circuit of outputs to ground; module by module	Yes	Yes; Short-circuit of outputs to ground; module by module
Diagnostics indication LED			
• Group error SF (red)	Yes	Yes	Yes
• Status indicator digital output (green)	Yes	Yes	Yes
• Channel fault indicator F (red)		Yes	

Technical specifications (continued)

Article number	6ES7142-4BD00-0AA0 ET 200PRO, EM 4DO 24V DC/2.0A	6ES7142-4BD00-0AB0 ET 200PRO, EM 4DO 24VDC/2.0A HF	6ES7142-4BF00-0AA0 ET 200PRO, EM 8DO DC24V/0.5A
Parameter			
Diagnostics wire break		channel by channel	
Diagnostics short-circuit		channel by channel	
Potential separation			
between backplane bus and all other circuit components	Yes	Yes	Yes
Potential separation digital outputs			
• between the channels	No	No	No
• between the channels and backplane bus	Yes	Yes	Yes
Isolation			
Isolation tested with	707 V DC (type test)	707 V DC (type test)	707 V DC (type test)
Dimensions			
Width	45 mm	45 mm	45 mm
Height	130 mm	130 mm	130 mm
Depth	35 mm	35 mm; without terminal module	35 mm
Weights			
Weight, approx.	140 g	140 g	140 g
Article number	6ES7143-4BF50-0AA0 ET 200PRO, EM 4DI / 4DO DC 24V, 0.5A	6ES7143-4BF00-0AA0 ET 200PRO, EM 4 DIO / 4 DO DC 24V, 0.5A	
Supply voltage			
Rated value (DC)		24 V	
Reverse polarity protection		Yes; Against destruction; encoder power supply outputs applied with reversed polarity	
Load voltage 2L+			
• Rated value (DC)	24 V	24 V	
• Short-circuit protection	Yes	Yes	
• Reverse polarity protection	Yes	Yes; against destruction; load increasing	
Input current			
from supply voltage 1L+, max.		20 mA	
from load voltage 2L+ (without load), max.	20 mA	20 mA	
from backplane bus 3.3 V DC, max.	20 mA	30 mA	
Encoder supply			
Number of outputs	4	4	
Short-circuit protection	Yes; per module, electronic	Yes; per module, electronic	
Output current			
• up to 55 °C, max.	1 A	1 A	
Power loss			
Power loss, typ.	2 W	3 W	
Digital inputs			
Number of digital inputs	4	4; 4 DIOs can be parameterized	
Input characteristic curve in accordance with IEC 61131, type 3	Yes	Yes	
Number of simultaneously controllable inputs			
all mounting positions - up to 55 °C, max.		4	
Input voltage			
• Rated value (DC)	24 V	24 V	
• for signal *0*	-3 to +5V	-3 to +5V	
• for signal *1*	+11 to +30V	+11 to +30V	
Input current			
• for signal *1*, typ.	7 mA	7 mA	

I/O systems

SIMATIC ET 200 systems without control cabinet
SIMATIC ET 200pro

I/O modules > Digital expansion modules**Technical specifications (continued)**

Article number	6ES7143-4BF50-0AA0 ET 200PRO, EM 4DI / 4DO DC 24V, 0.5A	6ES7143-4BF00-0AA0 ET 200PRO, EM 4 DIO / 4 DO DC 24V, 0.5A
Input delay (for rated value of input voltage) for standard inputs		
- at "0" to "1", min.		1.2 ms
- at "0" to "1", max.	3 ms	4.8 ms
- at "1" to "0", min.		1.2 ms
- at "1" to "0", max.	3 ms	4.8 ms
Cable length		
• shielded, max.	30 m	30 m
• unshielded, max.	30 m	30 m
Digital outputs		
Number of digital outputs	4	8; 4 DO fixed, 4 DIO parameterizable
• in groups of		4; 2 load groups for 4 outputs each
Short-circuit protection	Yes; per channel, electronic	Yes; per channel, electronic
• Response threshold, typ.	0.7 A	0.7 A
Limitation of inductive shutdown voltage to	Typ. (2L+) -47 V	Typ. (L1+, L2+) -47 V
Controlling a digital input	Yes	Yes
Switching capacity of the outputs		
• on lamp load, max.	5 W	5 W
Load resistance range		
• lower limit	48 Ω	48 Ω
• upper limit	4 kΩ	4 kΩ
Output voltage		
• for signal "1", min.		2L+ (-0.8 V)
Output current		
• for signal "1" rated value	0.5 A	0.5 A
• for signal "0" residual current, max.	0.5 mA	0.5 mA
Parallel switching of two outputs		
• for uprating	No	No
• for redundant control of a load	Yes	Yes
Switching frequency		
• with resistive load, max.	100 Hz	100 Hz
• with inductive load, max.	0.5 Hz	0.5 Hz
• on lamp load, max.	1 Hz	1 Hz
Total current of the outputs (per group)		
all mounting positions		
- up to 55 °C, max.	2 A	2 A
Cable length		
• shielded, max.	30 m	30 m
• unshielded, max.	30 m	30 m
Encoder		
Connectable encoders		
• 2-wire sensor	Yes	Yes
- permissible quiescent current (2-wire sensor), max.	1.5 mA	1.5 mA
Interrupts/diagnostics/ status information		
Diagnostic functions	Yes	Yes
Alarms		
• Diagnostic alarm	Yes	Yes

Technical specifications (continued)

Article number	6ES7143-4BF50-0AA0 ET 200PRO, EM 4DI / 4DO DC 24V, 0.5A	6ES7143-4BF00-0AA0 ET 200PRO, EM 4 DIO / 4 DO DC 24V, 0.5A
Diagnostic messages		
• Diagnostic information readable	Yes	Yes
• Short-circuit	Yes; Short-circuit of outputs to ground; module by module	Yes; Short-circuit of outputs to ground; module by module
Diagnostics indication LED		
• Group error SF (red)		Yes
• Status indicator digital input (green)	Yes	Yes
• Status indicator digital output (green)	Yes	Yes
Potential separation		
between backplane bus and all other circuit components	Yes	Yes
Potential separation digital inputs		
• between the channels	No	No
• between the channels and backplane bus	Yes	Yes
Potential separation digital outputs		
• between the channels	No	
• between the channels and backplane bus	Yes	Yes
Isolation		
Isolation tested with	707 V DC (type test)	707 V DC (type test)
Dimensions		
Width	45 mm	45 mm
Height	130 mm	130 mm
Depth	35 mm	35 mm
Weights		
Weight, approx.	140 g	140 g

I/O systemsSIMATIC ET 200 systems without control cabinet
SIMATIC ET 200pro**I/O modules > Digital expansion modules**

Ordering data	Article No.	Ordering data	Article No.
8 DI digital input module 24 V DC, with module-specific diagnostics, including bus module. Connection module must be ordered separately	6ES7141-4BF00-0AA0	CM IO 8 x M12 connection module 8 M12 sockets for connecting digital sensors or actuators to ET 200pro	6ES7194-4CB00-0AA0
8 DI High Feature digital input module 24 V DC, with channel-specific diagnostics, including bus module. Connection module must be ordered separately	6ES7141-4BF00-0AB0	CM IO 8 x M12 P connection module 8 M12 sockets for connecting digital sensors or actuators to ET 200pro; plastic version	6ES7194-4CB10-0AA0
16 DI digital input module 24 V DC, with module-specific diagnostics, including bus module. Connection module 6ES7194-4CB50-0AA0 must be ordered separately	6ES7141-4BH00-0AA0	CM IO 8 x M12D connection module 8 M12 sockets for connecting digital sensors or actuators to ET 200pro	6ES7194-4CB50-0AA0
4 DO digital output module 24 V DC, 2 A, with module-specific diagnostics, including bus module. Connection module must be ordered separately	6ES7142-4BD00-0AA0	CM IO 8 x M8 connection module 8 sockets M8 for connection of digital sensors or actuators to ET 200pro	6ES7194-4EB00-0AA0
4 DO High Feature digital output module 24 V DC, 2 A, with channel-specific diagnostics, including bus module. Connection module must be ordered separately	6ES7142-4BD00-0AB0	CM IO 2 x M12 connection module 2 M12 8-pin sockets; for use with: EM 8 DI, 24 V DC and 8 DO, 24 V DC/0.5 A	6ES7194-4FB00-0AA0
8 DO digital output module 24 V DC, 0.5 A, with module-specific diagnostics, including bus module. Connection module must be ordered separately	6ES7142-4BF00-0AA0	CM IO 1 x M23 connection module 1 M23 socket; for use with: EM 8 DI, 24 V DC and 8 DO, 24 V DC/0.5 A	6ES7194-4FA00-0AA0
4 DI/4 DO digital input and output module 24 V DC, 0.5 A, with module-specific diagnostics, including bus module. Connection module must be ordered separately	6ES7143-4BF50-0AA0	Module identification labels For color coding of the CM IOs in the colors of white, red, blue and green; pack with 100 units each	6ES7194-4HA00-0AA0
Digital input and output module 4 DIO / 4 DO 24 V DC, 0.5 A, with module-specific diagnostics, including bus module. Connection module must be ordered separately	6ES7143-4BF00-0AA0	M12 sealing cap For protection of unused M12 connections with ET 200pro	3RX9802-0AA00
Accessories		Labels 20 x 7, pale turquoise, 340 items per pack	3RT1900-1SB20
CM IO 4 x M12 connection module 4 M12 sockets for connecting digital or analog sensors or actuators to ET 200pro	6ES7194-4CA00-0AA0	M12 Y circular connector For double connection of sensors via a single cable, 5-pole; cannot be used for F DI 4/8	6ES7194-1KA01-0XA0
CM IO 4 x M12 inverse connection module 4 M12 sockets for connection of digital actuators to ET 200pro (4 DO and 4 DO HF); 2 x M12 single assignment, 2 x M12 double assignment	6ES7194-4CA50-0AA0	M12 Y cable For double connection of I/O by means of a single cable on ET 200, 5-pole	6ES7194-6KA00-0XA0
CM IO 4 x M12 P connection module 4 M12 sockets for connecting digital sensors or actuators to ET 200pro; plastic version	6ES7194-4CA10-0AA0	M8 sealing cap For IP67 modules	3RK1901-1PN00

Overview



- Expansion modules with analog inputs and outputs for connecting sensors or actuators
- With diagnostics functionality, limit values and substitute values

Technical specifications

Article number	6ES7144-4FF01-0AB0 ET 200PRO, EM 4AI-U HF	6ES7144-4GF01-0AB0 ET 200PRO, EM 4AI-I HF	6ES7144-4JF00-0AB0 ET 200PRO, EM 4 AI-RTD HF	6ES7144-4PF00-0AB0 ET 200PRO, EM 4 AI-TC HF
Supply voltage				
Rated value (DC)	24 V	24 V	24 V	24 V
Reverse polarity protection	Yes; against destruction	Yes; against destruction	Yes; against destruction	Yes; against destruction
Input current				
from supply voltage 1L+, max.	40 mA; Typical	40 mA; Typical	27 mA; Typical	34 mA; Typical
from backplane bus 3.3 V DC, max.	12 mA; Typical	12 mA; Typical	10 mA; Typical	20 mA; Typical
Encoder supply				
Number of outputs	4	4		
Short-circuit protection	Yes; per module, electronic to frame	Yes; per module, electronic to frame		
Output current				
• up to 55 °C, max.	1 A	1 A		
Power loss				
Power loss, typ.	1.1 W	1.1 W	0.7 W	0.7 W
Address area				
Address space per module				
• Address space per module, max.	8 byte	8 byte	8 byte	8 byte
Analog inputs				
Number of analog inputs	4	4	4	4
permissible input voltage for voltage input (destruction limit), max.	35 V			20 V
permissible input current for current input (destruction limit), max.		40 mA		
Constant measurement current for resistance-type transmitter, typ.			1.25 mA; 1.25 / 0.5 mA depending on measuring range	
Cycle time (all channels) max.	5 ms	10 ms	83 ms; 83 ms at 50 Hz; 69 ms at 60 Hz	Number of active channels per module x basic conversion time
Technical unit for temperature measurement adjustable			Yes; Degrees Celsius/degrees Fahrenheit	Yes; °C/°F/K
Input ranges				
• Voltage	Yes	No	No	Yes
• Current	No	Yes	No	No
• Thermocouple	No	No	No	Yes
• Resistance thermometer	No	No	Yes	No
• Resistance	No	No	Yes	No

I/O systems

SIMATIC ET 200 systems without control cabinet

SIMATIC ET 200pro

I/O modules > Analog expansion modules**Technical specifications** (continued)

Article number	6ES7144-4FF01-0AB0 ET 200PRO, EM 4AI-U HF	6ES7144-4GF01-0AB0 ET 200PRO, EM 4AI-I HF	6ES7144-4JF00-0AB0 ET 200PRO, EM 4 AI-RTD HF	6ES7144-4PF00-0AB0 ET 200PRO, EM 4 AI-TC HF
Input ranges (rated values), voltages				
• 0 to +10 V	Yes			
• 1 V to 5 V	Yes			
• -10 V to +10 V	Yes			
• -5 V to +5 V	Yes			
• -80 mV to +80 mV				Yes
• Input resistance (-80 mV to +80 mV)				10 M Ω
Input ranges (rated values), currents				
• 0 to 20 mA		Yes		
• Input resistance (0 to 20 mA)		50 Ω		
• -20 mA to +20 mA		Yes		
• Input resistance (-20 mA to +20 mA)		50 Ω		
• 4 mA to 20 mA		Yes		
• Input resistance (4 mA to 20 mA)		50 Ω		
Input ranges (rated values), thermocouples				
• Type B				Yes
• Input resistance (Type B)				10 M Ω
• Type E				Yes
• Input resistance (Type E)				10 M Ω
• Type J				Yes
• Input resistance (type J)				10 M Ω
• Type K				Yes
• Input resistance (Type K)				10 M Ω
• Type L				Yes
• Input resistance (Type L)				10 M Ω
• Type N				Yes
• Input resistance (Type N)				10 M Ω
• Type R				Yes
• Input resistance (Type R)				10 M Ω
• Type S				Yes
• Input resistance (Type S)				10 M Ω
• Type T				Yes
• Input resistance (Type T)				10 M Ω
Input ranges (rated values), resistance thermometer				
• Cu 10			No	
• Ni 100			Yes	
• Input resistance (Ni 100)			10 000 k Ω	
• Ni 1000			Yes	
• Input resistance (Ni 1000)			10 000 k Ω	
• Ni 120			Yes	
• Input resistance (Ni 120)			10 000 k Ω	
• Ni 200			Yes	
• Input resistance (Ni 200)			10 000 k Ω	
• Ni 500			Yes	
• Input resistance (Ni 500)			10 000 k Ω	
• Pt 100			Yes	
• Input resistance (Pt 100)			10 000 k Ω	
• Pt 1000			Yes	
• Input resistance (Pt 1000)			10 000 k Ω	
• Pt 200			Yes	
• Input resistance (Pt 200)			10 000 k Ω	
• Pt 500			Yes	
• Input resistance (Pt 500)			10 000 k Ω	

Technical specifications (continued)

Article number	6ES7144-4FF01-0AB0 ET 200PRO, EM 4AI-U HF	6ES7144-4GF01-0AB0 ET 200PRO, EM 4AI-I HF	6ES7144-4JF00-0AB0 ET 200PRO, EM 4 AI-RTD HF	6ES7144-4PF00-0AB0 ET 200PRO, EM 4 AI-TC HF
Input ranges (rated values), resistors				
• 0 to 150 ohms			Yes	
• Input resistance (0 to 150 ohms)			10 000 kΩ	
• 0 to 300 ohms			Yes	
• Input resistance (0 to 300 ohms)			10 000 kΩ	
• 0 to 600 ohms			Yes	
• Input resistance (0 to 600 ohms)			10 000 kΩ	
• 0 to 3000 ohms			Yes	
• Input resistance (0 to 3000 ohms)			10 000 kΩ	
Thermocouple (TC)				
Temperature compensation				
- internal temperature compensation				Yes
- external temperature compensation with compensations socket				Yes
Characteristic linearization				
• parameterizable			Yes	
- for resistance thermometer			Ptxxx, Nixxx	
Cable length				
• shielded, max.	30 m	30 m	30 m	30 m
Analog value generation for the inputs				
Measurement principle	integrating	integrating	integrating	integrating
Integration and conversion time/resolution per channel				
• Resolution with overrange (bit including sign), max.	15 bit; 15 bits + sign at ±10 V, at ±5 V; 15 bits at 0 V to 10 V, at 1 V to 5 V	15 bit; 15 bits + sign at ±10 V, at ±5 V; 15 bits at 0 V to 10 V, at 1 V to 5 V	15 bit; at 150, 300, 600 und 3000 ohms; otherwise 15 bits + sign	15 bit; + sign
• Integration time (ms)	0,3 / 16,7 / 20 / 60	0,3 / 16,7 / 20 / 60	20 / 16,667	2,5 / 16,67 / 20 / 100 ms
• Interference voltage suppression for interference frequency f1 in Hz	16,67 / 50 / 60 / 3 600	16,67 / 50 / 60 / 3 600	50 / 60 Hz	10 / 50 / 60 / 400 Hz
• Conversion time (per channel)	1.1 ms	1.1 ms	20.625 ms; 20.625 ms at 50 Hz; 17.25 ms at 60 Hz	4.7/19/22/102 ms
Smoothing of measured values				
• parameterizable	Yes	Yes	Yes	Yes
• Step: None	Yes; 1 x cycle time	Yes; 1 x cycle time	Yes; 1 x cycle time	Yes; 1 x cycle time
• Step: low	Yes; 4 x cycle time	Yes; 4 x cycle time	Yes; 4 x cycle time	Yes; 4 x cycle time
• Step: Medium	Yes; 16 x cycle time	Yes; 16 x cycle time	Yes; 16 x cycle time	Yes; 16 x cycle time
• Step: High	Yes; 64 x cycle time	Yes; 64 x cycle time	Yes; 64 x cycle time	Yes; 64 x cycle time
Encoder				
Connection of signal encoders				
• for voltage measurement	Yes			Yes
• for current measurement as 2-wire transducer		Yes		
• for current measurement as 4-wire transducer		Yes		
• for resistance measurement with two-wire connection			Yes; Line resistances are also measured	
• for resistance measurement with three-wire connection			Yes	
• for resistance measurement with four-wire connection			Yes	

I/O systems

SIMATIC ET 200 systems without control cabinet

SIMATIC ET 200pro

I/O modules > Analog expansion modules**Technical specifications (continued)**

Article number	6ES7144-4FF01-0AB0 ET 200PRO, EM 4AI-U HF	6ES7144-4GF01-0AB0 ET 200PRO, EM 4AI-I HF	6ES7144-4JF00-0AB0 ET 200PRO, EM 4 AI-RTD HF	6ES7144-4PF00-0AB0 ET 200PRO, EM 4 AI-TC HF
Errors/accuracies				
Linearity error (relative to input range), (+/-)	0.0075 %	0.0075 %	0.05 %	0.01 %
Temperature error (relative to input range), (+/-)	0.00075 %/K	0.00075 %/K	0.002 %/K	0.0004 %/K; Positive temperature
Crosstalk between the inputs, min.	-70 dB	-70 dB	-50 dB	-90 dB; max.
Repeat accuracy in steady state at 25 °C (relative to input range), (+/-)	0.004 %	0.004 %	0.015 %	0.01 %
Operational error limit in overall temperature range				
• Voltage, relative to input range, (+/-)	0.1 %			0.12 %; Positive temperature
• Current, relative to input range, (+/-)		0.1 %		
• Resistance thermometer, relative to input range, (+/-)			0.175 %	
Basic error limit (operational limit at 25 °C)				
• Voltage, relative to input range, (+/-)	0.075 %			0.1 %
• Current, relative to input range, (+/-)		0.075 %		
• Resistance thermometer, relative to input range, (+/-)			0.125 %	
Interference voltage suppression for $f = n \times (f_1 \pm 1 \%)$, $f_1 =$ interference frequency				
• Series mode interference (peak value of interference < rated value of input range), min.			50 dB	42 dB
• Common mode interference (USS < 2.5 V), min.			70 dB; Interference voltage < 5 V	85 dB; Interference voltage < 10 V
Interference voltage suppression for $f = n \times (f_1 \pm 0.5 \%)$, $f_1 =$ interference frequency				
• Series mode interference (peak value of interference < rated value of input range), min.	60 dB	60 dB		
• Common mode interference (USS < 2.5 V), min.	80 dB; Interference voltage < 10 V	80 dB; Interference voltage < 5 V		
Interrupts/diagnostics/status information				
Diagnostic functions	Yes	Yes	Yes	Yes
Alarms				
• Diagnostic alarm	Yes; Parameterizable	Yes; Parameterizable	Yes; Parameterizable	Yes; Parameterizable
• Hardware interrupt	Yes; (limit value alarm), can be parameterized for channel 0	Yes; (limit value alarm), can be parameterized for channel 0	No	No
Diagnostic messages				
• Diagnostic information readable	Yes	Yes	Yes	Yes
• Wire-break	Yes; at 1 to 5 V	Yes; at 4 to 20 mA	Yes	Yes
• Short-circuit	Yes; at 1 to 5 V	Yes; at 4 to 20 mA		
• Overflow/underflow			Yes	Yes
Diagnostics indication LED				
• Group error SF (red)	Yes	Yes	Yes	Yes

Technical specifications (continued)

Article number	6ES7144-4FF01-0AB0 ET 200PRO, EM 4AI-U HF	6ES7144-4GF01-0AB0 ET 200PRO, EM 4AI-I HF	6ES7144-4JF00-0AB0 ET 200PRO, EM 4 AI-RTD HF	6ES7144-4PF00-0AB0 ET 200PRO, EM 4 AI-TC HF
Parameter				
Diagnostics wire break			Yes	Yes
Measurement type/range			R4L / R3L / R2L / TR4L / TR3L / TR2L	Deactivated/ +/- 80 mV/ TC-EL Type T (Cu-CuNi)/ TC-EL Type K (NiCr-Ni)/ TC-EL Type B (PtRh-PtRh)/ TC-EL Type N (NiCrSi-NiSi)/ TC-EL Type E (NiCr-CuNi)/ TC-EL Type R (PtRh-Pt)/ TC-EL Type S (PtRh-Pt)/ TC-EL Type J (Fe-Cu-Ni)/ TC-EL Type L (Fe-CuNi)
Comparison point				None/internal/RTD(0)/dyn. ref. temp./fix. ref. temp.
Potential separation				
Potential separation analog inputs				
• between the channels	No	No	No	No
• between the channels and backplane bus	Yes	Yes	Yes	Yes
Isolation				
Isolation tested with	707 V DC (type test)	707 V DC (type test)	707 V DC (type test)	707 V DC (type test)
Dimensions				
Width	45 mm	45 mm	45 mm	45 mm
Height	130 mm	130 mm	130 mm	130 mm
Depth	35 mm	35 mm	35 mm	35 mm
Weights				
Weight, approx.	150 g	150 g	150 g	150 g

Article number	6ES7145-4FF00-0AB0 ET 200PRO, EM 4AO-U HF	6ES7145-4GF00-0AB0 ET 200PRO, EM 4 AO-I HF
Supply voltage		
Rated value (DC)	24 V	24 V
Reverse polarity protection	Yes; against destruction	Yes; against destruction
Input current		
from supply voltage 1L+, max.	65 mA	110 mA
from backplane bus 3.3 V DC, max.	10 mA	10 mA
Actuator supply		
Number of outputs	4	4
Short-circuit protection	Yes; per module	Yes; per module
Output current		
• up to 55 °C, max.	1 A	1 A
Power loss		
Power loss, typ.	1.7 W	2.3 W
Address area		
Address space per module		
• Address space per module, max.	8 byte	8 byte
Analog outputs		
Number of analog outputs	4	4
Voltage output, short-circuit protection	Yes; per channel, electronic to chassis	Yes; per module, electronic to frame
Voltage output, short-circuit current, max.	50 mA	
Current output, no-load voltage, max.		16 V
Cycle time (all channels) max.	3 ms	3 ms
Output ranges, voltage		
• 0 to 10 V	Yes	
• 1 V to 5 V	Yes	
• -10 V to +10 V	Yes	

I/O systems

SIMATIC ET 200 systems without control cabinet

SIMATIC ET 200pro

I/O modules > Analog expansion modules**Technical specifications** (continued)

Article number	6ES7145-4FF00-0AB0 ET 200PRO, EM 4AO-U HF	6ES7145-4GF00-0AB0 ET 200PRO, EM 4 AO-I HF
Output ranges, current		
• 0 to 20 mA		Yes
• -20 mA to +20 mA		Yes
• 4 mA to 20 mA		Yes
Connection of actuators		
• for voltage output two-wire connection	Yes	
• for voltage output four-wire connection	Yes	
• for current output two-wire connection		Yes
• for current output four-wire connection		Yes
Load impedance (in rated range of output)		
• with voltage outputs, min.	1 000 Ω	
• with voltage outputs, capacitive load, max.	1 μF	
• with current outputs, max.		600 Ω
• with current outputs, inductive load, max.		1 mH
Destruction limits against externally applied voltages and currents		
• Voltages at the outputs towards MANA	16 V; Permanent	
• Current, max.		100 mA
Cable length		
• shielded, max.	30 m	30 m
Analog value generation for the outputs		
Integration and conversion time/resolution per channel		
• Resolution with overrange (bit including sign), max.	15 bit; at -10 to +10 V; 14 bits at 1 to 5 V; 15 bits at 0 to 10 V	15 bit; at +/- 20 mA; 14 bits at 0 to 20 mA; 15 bits at 4 to 20 mA
• Conversion time (per channel)	0.7 ms	0.7 ms
Settling time		
• for resistive load	0.1 ms	0.1 ms
• for capacitive load	6 ms	
• for inductive load		1 ms
Errors/accuracies		
Output ripple (relative to output range, bandwidth 0 to 50 kHz), (+/-)	0.02 %	0.02 %
Linearity error (relative to output range), (+/-)	0.1 %	0.1 %
Temperature error (relative to output range), (+/-)	0.01 %/K	0.01 %/K
Repeat accuracy in steady state at 25 °C (relative to output range), (+/-)	0.05 %	0.05 %
Operational error limit in overall temperature range		
• Voltage, relative to output range, (+/-)	0.2 %	
• Current, relative to output range, (+/-)		0.2 %
Basic error limit (operational limit at 25 °C)		
• Voltage, relative to output range, (+/-)	0.15 %	
• Current, relative to output range, (+/-)		0.15 %

Technical specifications (continued)

Article number	6ES7145-4FF00-0AB0 ET 200PRO, EM 4AO-U HF	6ES7145-4GF00-0AB0 ET 200PRO, EM 4 AO-I HF
Interrupts/diagnostics/ status information		
Diagnostic functions		Yes
Substitute values connectable	Yes	Yes
Alarms		
• Diagnostic alarm	Yes; Parameterizable	Yes; Parameterizable
• Hardware interrupt	No	No
Diagnostic messages		
• Diagnostic information readable	Yes	Yes
• Wire-break	No	Yes; per channel, not in zero range
• Short-circuit	Yes; per channel, not in zero range	No
Diagnostics indication LED		
• Group error SF (red)	Yes	Yes
Parameter		
Diagnostics short-circuit	Outputs; sensor supply to M	Encoder supply to M
Potential separation		
Potential separation analog outputs		
• between the channels	No	No
• between the channels and backplane bus	Yes	Yes
Isolation		
Isolation tested with	707 V DC (type test)	707 V DC (type test)
Dimensions		
Width	45 mm	45 mm
Height	130 mm	130 mm
Depth	35 mm	35 mm
Weights		
Weight, approx.	150 g	150 g

Ordering data

Article No.	Article No.
4AI U analog input module High Feature, ±10 V; ±5 V; 0 to 10 V; 1 to 5 V, channel-specific diagnostics, including bus module. Connection module must be ordered separately	6ES7144-4FF01-0AB0
4AI I analog input module High Feature, ±20 mA; 0 to 20 mA; 4 to 20 mA, channel-specific diagnostics, including bus module. Connection module must be ordered separately	6ES7144-4GF01-0AB0
4AI RTD analog input module High Feature; resistances: 150, 300, 600 and 3000 Ohm; resistance thermometer: Pt100, 200, 500, 1000, Ni100, 120, 200, 500 and 1000; channel-discrete diagnostics, incl. bus module. Connection module must be ordered separately	6ES7144-4JF00-0AB0
Analog input module 4AI TC High Feature; thermocouples: Type B, E, J, K, L, N, R, S, T; voltage measurement: ±80 mV; channel diagnostics, including bus module. Connection module must be ordered separately	6ES7144-4PF00-0AB0
4AO U analog output module High Feature, ±10 V; 0 to 10 V; 1 to 5 V, channel-specific diagnostics, including bus module. Connection module must be ordered separately	6ES7145-4FF00-0AB0
4AO I analog output module High Feature, ±20 mA; 0 to 20 mA; 4 to 20 mA, channel-specific diagnostics, including bus module. Connection module must be ordered separately	6ES7145-4GF00-0AB0
Accessories	
CM IO 4 x M12 connection module 4 M12 sockets for connecting digital or analog sensors or actuators to ET 200pro	6ES7194-4CA00-0AA0
M12 compensation connectors With integral Pt100 for reference point compensation when connecting thermocouples	6ES7194-4AB00-0AA0
Module identification labels For color coding of the CM IOs in the colors of white, red, blue and green; pack with 100 units each	6ES7194-4HA00-0AA0
M12 sealing cap For protection of unused M12 connections with ET 200pro	3RX9802-0AA00

I/O systems

SIMATIC ET 200 systems without control cabinet
SIMATIC ET 200pro

I/O modules > Communication > IO-Link master modules

Overview

- 45 mm-wide 4 IO-LINK HF electronic module
- 4 IO-Link ports according to IO-Link specification V1.1
- Port Class B
- The IO-Link parameters are configured using the Port Configuration Tool (S7-PCT), version V3.4 and higher

Technical specifications

Article number	6ES7147-4JD00-0AB0 ET 200pro, EM 4 IO-Link HF
Supply voltage	
Rated value (DC)	24 V
Reverse polarity protection	Yes
Load voltage 2L+	
• Rated value (DC)	24 V
• Short-circuit protection	Yes
• Reverse polarity protection	Yes; against destruction; load increasing
Input current	
from supply voltage 1L+, max.	40 mA
from load voltage 2L+ (without load), max.	20 mA
from backplane bus 3.3 V DC, max.	20 mA
Encoder supply	
Number of outputs	4
Short-circuit protection	Yes; per module, electronic
Output current	
• up to 55 °C, max.	2 A
Power loss	
Power loss, typ.	2.6 W
IO-Link	
Number of ports	4
• of which simultaneously controllable	4
IO-Link protocol 1.0	Yes
IO-Link protocol 1.1	Yes
Transmission rate	4.8 kBaud (COM1); 38.4 kBaud (COM2), 230.4 kBaud (COM3)
Size of process data, input per port	32 byte
Size of process data, input per module	32 byte
Size of process data, output per port	32 byte
Size of process data, output per module	32 byte
Memory size for device parameter	2 kbyte; for each port
Master backup	Possible with function block IO_LINK_MASTER
Cable length unshielded, max.	20 m
Operating modes	
• IO-Link	Yes
• DI	Yes
• DQ	Yes; max. 100 mA
Connection of IO-Link devices	
• Port type A	Yes; via 3-core cable
• Port type B	Yes; Additional device supply; for X1 and X2 max. 2 A in total, for X3 and X4 max. 2 A in total

Article number	6ES7147-4JD00-0AB0 ET 200pro, EM 4 IO-Link HF
Interrupts/diagnostics/status information	
Diagnostic functions	Yes
Alarms	
• Diagnostic alarm	Yes
Diagnostic messages	
• Diagnostic information readable	Yes
• Wire-break	Yes
• Short-circuit	Yes
Diagnostics indication LED	
• Channel status display	Yes; One green LED for channel status Qn (SIO mode) and port status IO-Ln (IO-Link mode)
• Group error SF (red)	Yes
• Channel fault indicator F (red)	Yes; combined with the IO-Link port status
Parameter	
Diagnostics wire break	channel by channel
Diagnostics short-circuit	channel by channel
Potential separation	
between the load voltages	Yes
between backplane bus and all other circuit components	Yes
Potential separation channels	
• between the channels	No
Isolation	
Isolation tested with	707 V DC (type test)
Dimensions	
Width	45 mm
Height	130 mm
Depth	35 mm
Weights	
Weight, approx.	150 g

Ordering data

Article No.

4 IO-LINK HF electronic module	6ES7147-4JD00-0AB0
4 IO-Link ports according to IO-Link Specification V1.1, port Class B; High Feature, channel diagnostics, including bus module. Connection module must be ordered separately	
Accessories	
CM IO-Link 4 x M12 P connection module	6ES7194-4CA20-0AA0
4 M12 sockets for connecting IO-Link devices to ET 200pro electronic module 4 IO-LINK HF	
Module identification labels	6ES7194-4HA00-0AA0
For color coding of the CM IOs in the colors of white, red, blue and green; pack with 100 units each	
M12 sealing cap	3RX9802-0AA00
For protection of unused M12 connections with ET 200pro	

Overview

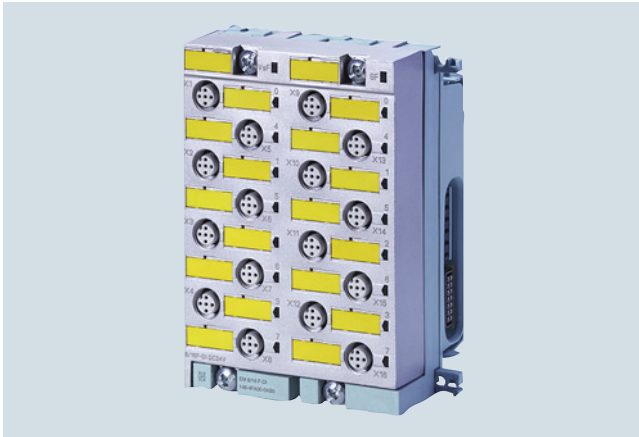

Fail-safe digital inputs/outputs with IP65/66/67 degree of protection for application on the machine level without control cabinet

Fail-safe digital inputs

- For fail-safe reading of sensor information (1 or 2 channels)
- Provide integral discrepancy evaluation for 2-out-of-2 signals
- Internal sensor supplies (incl. test function) available

Fail-safe digital outputs

- Fail-safe 2-channel activation (sink/source output) by actuators
- Actuators can be driven by up to 2 A

All modules are certified up to SIL 3 (IEC 61508) and feature detailed diagnostics.

The modules support PROFIsafe, both in PROFIBUS, and in PROFINET configurations. They can be used with IM151-7 F-CPU, CPU31xF-2 DP, CPU31xF-2 PN/DP and CPU416F-2.

Technical specifications

Article number	6ES7148-4FA00-0AB0 ET 200PRO, EL-MOD., 8/16 F-DI 24V DC
Supply voltage	
Rated value (DC)	24 V
Reverse polarity protection	Yes
Power loss	
Power loss, typ.	4.5 W
Digital inputs	
Number of digital inputs	16
Input current	
• for signal *1*, typ.	3.7 mA
Dimensions	
Width	90 mm
Height	130 mm
Depth	65 mm

Article number	6ES7148-4FC00-0AB0 ET 200PRO,EL-MOD,4/8 F-DI/4 F-DO 24VDC/2A	6ES7148-4FS00-0AB0 ET 200PRO,EL-MOD, F-SWITCH PROFISAFE
Supply voltage		
Rated value (DC)	24 V	24 V
Power loss		
Power loss, typ.	5.8 W	3 W
Digital inputs		
Number of digital inputs	8	2
Input current		
• for signal *1*, typ.	3.7 mA	3.5 mA
Digital outputs		
Number of digital outputs	4	3
Short-circuit protection	Yes	Yes
Output current		
• for signal *1* rated value	2 A	
Dimensions		
Width	90 mm	45 mm
Height	130 mm	130 mm
Depth	65 mm	65 mm

I/O systems

SIMATIC ET 200 systems without control cabinet

SIMATIC ET 200pro

I/O modules > Fail-safe expansion modules > Fail-safe digital expansion modules

Ordering data	Article No.	Accessories	Article No.
Fail-safe digital input module 8/16 F-DI PROFIsafe 24 V DC, including bus module. Connection module must be ordered separately	6ES7148-4FA00-0AB0	Connection module For the fail-safe electronic module F-Switch PROFIsafe	6ES7194-4DA00-0AA0
Fail-safe digital input/output module 4/8 F-DI, 4 F-DO 2 A 24 V DC, including bus module. Connection module must be ordered separately	6ES7148-4FC00-0AB0	Connection module For the fail-safe electronic module 4/8 F-DI/4 F-DO, 24 V DC/2 A	6ES7194-4DC00-0AA0
Fail-safe electronic module F-Switch PROFIsafe Three fail-safe PP-switching outputs for safe switching of the rear panel busbar (2L+, F0, F1); two fail-safe digital inputs, 45 mm; usable up to SIL3 (IEC 61508)	6ES7148-4FS00-0AB0	Connection module For the fail-safe electronic module 8/16 F-DI, 24 V DC	6ES7194-4DD00-0AA0
		PROFIBUS DP interface module IM154-2 Including termination module	6ES7154-2AA01-0AB0
		PROFINET interface module IM154-4 PN Including termination module	6ES7154-4AB10-0AB0
		M12 sealing cap For protection of unused M12 connections with ET 200pro	3RX9802-0AA00

Overview



- PM-E 24 V DC power module

Technical specifications

Article number	6ES7148-4CA00-0AA0 ET 200PRO, PM-E 24V DC
Supply voltage	
Load voltage 2L+	
• Rated value (DC)	24 V
• Short-circuit protection	Yes; via an exchangeable fuse in the power module
• Reverse polarity protection	Yes; against destruction
Input current	
from load voltage 2L+, max.	3 mA
Current carrying capacity	
max.	10 A; up to 55 °C (on the internal busbars of the ET 200pro)
Power loss	
Power loss, typ.	0.1 W
Interrupts/diagnostics/status information	
Diagnostic functions	Yes
Diagnostic messages	
• Diagnostic information readable	Yes
• missing load voltage	Yes
Diagnostics indication LED	
• Group error SF (red)	Yes
• Load voltage monitoring 24 V DC (green)	Yes

Article number	6ES7148-4CA00-0AA0 ET 200PRO, PM-E 24V DC
Parameter	
Missing load voltage	Potential group of the power module
Potential separation	
between load voltage and backplane bus	Yes
Isolation	
Isolation tested with	707 V DC (type test)
Degree and class of protection	
Degree of protection acc. to EN 60529	
• IP65	Yes
• IP66	Yes
• IP67	Yes
Dimensions	
Width	45 mm
Height	130 mm
Depth	35 mm
Weights	
Weight, approx.	140 g

I/O systems

SIMATIC ET 200 systems without control cabinet
SIMATIC ET 200pro

I/O modules > PM-E power module

Ordering data	Article No.	Article No.
PM-E 24 V DC power module For backfeed and group formation of the 24 V DC load supply for electronic modules within an ET 200pro station	6ES7148-4CA00-0AA0	
Accessories		
CM PM-E ECOFAST connecting module For supplying of 24 V load voltage, 1 ECOFAST Cu connection	6ES7194-4BA00-0AA0	
CM PM-E direct connecting module For backfeed of 24 V load voltage, up to 2 M20 screwed cable glands	6ES7194-4BC00-0AA0	
CM PM-E 7/8" connecting module For backfeed of 24 V load voltage, 1 x 7/8"	6ES7194-4BD00-0AA0	
CM PM-E PP connection module For supplying 24 V load voltage, 2 x push-pull, with spare fuse	6ES7194-4BE00-0AA0	
Spare fuse 12.5 A quick-response, for interface and power modules, 10 items per package unit	6ES7194-4HB00-0AA0	
PROFIBUS ECOFAST hybrid cable, copper Trailing-type cable (PUR casing) with two shielded copper cables for PROFIBUS DP and four copper cores of 1.5 mm ² in cross-section <u>Unassembled</u> • 50 m • 100 m <u>Pre-assembled</u> with ECOFAST male and female connector, fixed length • 1.5 m • 3 m • 5 m • 10 m • 15 m • 20 m	6XV1830-7AN50 6XV1830-7AT10 6XV1830-7BH15 6XV1830-7BH30 6XV1830-7BH50 6XV1830-7BN10 6XV1830-7BN15 6XV1830-7BN20	
		PROFIBUS ECOFAST hybrid cable, GP Trailing-type cable with 4 x copper cores and 2 x copper cores, shielded, with UL approval Pre-assembled with ECOFAST male and female connector • 1.5 m • 3 m • 5 m • 10 m • 15 m • 20 m
		ECOFAST cable connector, for user assembly Female connector; ordering unit 5 items
		PROFIBUS ECOFAST hybrid plug, angled With 2 x shielded copper cores and 4 x 1.5 mm ² copper cores; 5 items; with assembly instructions; female insert
		Push-pull cable connector For 1L+/ 2L+, unassembled
		Cover caps for push-pull female connectors 5 units
		Accessories for CM PM-E direct
		Power line 5-core, 5 x 1.5 mm ² , trailing type, sold by the meter, minimum order quantity 20 m, maximum order quantity 1,000 m
		Accessories for CM PM-E 7/8"
		7/8" connecting cable to power supply 5-core, 5 x 1.5 mm ² , trailing type, pre-assembled with two 7/8" connectors, 5-pin • 1.5 m long • 2.0 m long • 3.0 m long • 5.0 m long • 10 m long • 15 m long
		7/8" cable connector With axial cable outlet • with female insert, 5 per pack

Overview



PM-O 2 x 24 V DC power module with CM PM-O PP

- PM-O 2x 24 V DC power module

Technical specifications

Article number	6ES7148-4CA60-0AA0 ET 200PRO, PM-O DC 2X24V
Supply voltage	
Load voltage 2L+	
• Rated value (DC)	24 V
• Short-circuit protection	Yes
• Reverse polarity protection	Yes; against destruction
Input current	
from load voltage 2L+, max.	3 mA
Current carrying capacity	
max.	10 A; up to 55 °C (on the internal busbars of the ET 200pro)
Power loss	
Power loss, typ.	1.1 W
Interrupts/diagnostics/status information	
Diagnostic functions	Yes
Diagnostic messages	
• Diagnostic information readable	Yes
• missing load voltage	No
Diagnostics indication LED	
• Group error SF (red)	Yes
• Load voltage monitoring 24 V DC (green)	No; Signalled in IM or in PM

Article number	6ES7148-4CA60-0AA0 ET 200PRO, PM-O DC 2X24V
Parameter	
Diagnostics short-circuit	Diagnosis short circuit implemented after M for 1L+
Potential separation	
between load voltage and backplane bus	Yes
Isolation	
Isolation tested with	707 V DC (type test)
Degree and class of protection	
Degree of protection acc. to EN 60529	
• IP65	Yes
• IP66	Yes
• IP67	Yes
Dimensions	
Width	45 mm
Height	130 mm
Depth	35 mm
Weights	
Weight, approx.	150 g

Ordering data

	Article No.
PM-O 2 x 24 V DC power module	6ES7148-4CA60-0AA0
For drawing the 24 V load voltage 2L+ and electronic/encoder supply voltage 1L+ within an ET 200pro station	
Accessories	
CM PM-O PP connection module	6ES7194-4BH00-0AA0
For drawing the 24 V load voltage and electronic/encoder supply voltage, 2 x push-pull connector	

	Article No.
Push-pull cable connector	6GK1907-0AB10-6AA0
For 1L+/ 2L+, unassembled	
Cover caps for push-pull female connectors	6ES7194-4JA50-0AA0
5 units	

I/O systems

SIMATIC ET 200 systems without control cabinet

SIMATIC ET 200pro

I/O modules > ET 200pro pneumatic interface

Overview

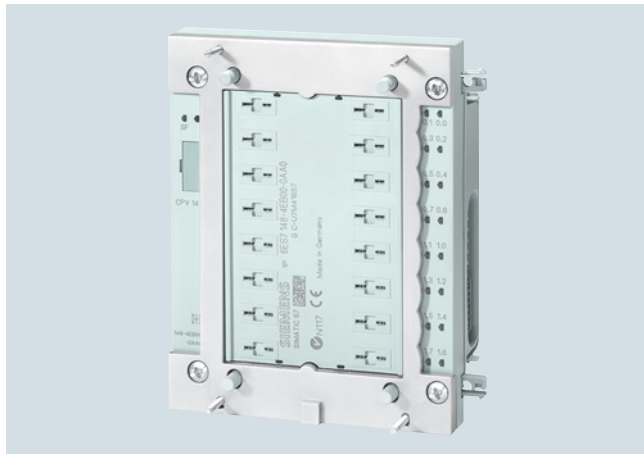

- Interface for holding an original FESTO CPV 10 or CPV 14 compact performance valve terminal
- For using the ET 200pro in applications with flexible pneumatics
- Highly flexible pneumatics due to a variety of valve functions and choice of flow rates

Technical specifications

Article number	6ES7148-4EA00-0AA0	6ES7148-4EB00-0AA0
	ET 200PRO, 16DO,PNEUMATIC INTERFACE CPV10	ET 200PRO, 16DO,PNEUMATIC INTERFACE CPV14
Supply voltage		
Load voltage 2L+		
• Rated value (DC)	24 V	24 V
• Short-circuit protection	Yes	Yes
• Reverse polarity protection	Yes	Yes
Input current		
from load voltage 2L+, max.	300 mA	370 mA
from backplane bus 3.3 V DC, max.	25 mA	25 mA
Power loss		
Power loss, typ.	2.6 W	3.7 W
Address area		
Address space per module		
• without packing	2 byte	2 byte
Digital outputs		
Number of digital outputs	16	16
Load resistance range		
• lower limit	500 Ω	500 Ω
• upper limit	2 500 Ω	2 500 Ω
Output current		
• for signal "1" rated value	12 mA	16 mA
Switching frequency		
• with inductive load, max.	25 Hz	20 Hz
Total current of the outputs (per group)		
all mounting positions		
- up to 55 °C, max.	250 mA; only up to 50 °C, limited by valves	330 mA; only up to 50 °C, limited by valves
Interrupts/diagnostics/status information		
Diagnostic functions	Yes	Yes
Alarms		
• Diagnostic alarm	Yes	Yes
Diagnostic messages		
• Diagnostic information readable	Yes	Yes
Diagnostics indication LED		
• Group error SF (red)	Yes	Yes
• Status indicator digital output (green)	Yes	Yes

Technical specifications (continued)

Article number	6ES7148-4EA00-0AA0 ET 200PRO, 16DO,PNEUMATIC INTERFACE CPV10	6ES7148-4EB00-0AA0 ET 200PRO, 16DO,PNEUMATIC INTERFACE CPV14
Pneumatics		
permissible working pressure, min.	3 bar	3 bar
permissible working pressure, max.	8 bar	8 bar
Rated flow rate	400 l/min	800 l/min
Number of connectable valves, max.	16	16
Parameter		
Remark	Diagnosis load voltage 2L+	Diagnosis load voltage 2L+
Response to CPU/master STOP	No	
Potential separation		
between backplane bus and all other circuit components	Yes	Yes
Potential separation digital outputs		
• between the channels and backplane bus	Yes	Yes
Isolation		
Isolation tested with	707 V DC (type test)	707 V DC (type test)
Dimensions		
Width	90 mm	120 mm
Height	130 mm	152 mm
Depth	47 mm	47 mm

Ordering data**EM 148-P pneumatic interface**

DO 16 x P/CPV 10 for direct accommodation of FESTO valve terminal CPV 10 16 DO x P

DO 16 x P/CPV 14 for direct accommodation of FESTO valve terminal CPV 14 16 DO x P

Article No.**6ES7148-4EA00-0AA0****6ES7148-4EB00-0AA0****Article No.**

FESTO CPV 10 valve terminal

FESTO CPV 14 valve terminal

available from FESTO

available from FESTO

FESTO AG & Co
Ruitersstr. 82
D-73732 Esslingen

More addresses
on the Internet at:
<http://www.festo.de>

I/O systems

SIMATIC ET 200 systems without control cabinet
SIMATIC ET 200pro

I/O modules > RF170C

Overview



The SIMATIC RF170C is a communication module for connecting the SIMATIC identification systems to the ET 200pro distributed I/O system. The readers (SLGs) of all RFID systems as well as the MV400 optical reader devices and MV300 optical handheld readers can be operated on the RF170C. In addition, the RF170C provides a universal RS 232/RS 422 interface for connecting devices using the Freeprotocol.

Thanks to the high degree of protection and ruggedness, ET 200pro is particularly suitable for machine-level use. The modular structure with PROFIBUS and PROFINET connection systems allows it to be used in all applications. The uniform plug-in connection system ensures rapid commissioning.

Technical specifications

Article number	6GT2002-0HD01
Product type designation	RF170C communication module
Suitability for operation	Dezentrale Peripherie ET 200pro together with RF200/300/600, MV300/400, MOBY D/E/I/U and RS232 devices
Transmission rate	
Transfer rate at the point-to-point connection serial maximum	115.2 kbit/s
Interfaces	
Design of the interface for point-to-point connection	RS422/RS232 via connection block
Number of readers connectable	2
Type of electrical connection	
• of the backplane bus	ET 200pro backplane bus
• of the PROFIBUS interface	(according to the head module)
• of Industrial Ethernet interface	(according to the head module)
• for supply voltage	ET 200pro backplane bus
Design of the interface to the reader for communication	Internal plug to the connection block
Mechanical data	
Material	Thermoplastic (Valox 467, fiberglass reinforced)
Color	IP Basic 714
Tightening torque of the screw for securing the equipment maximum	1.5 N·m
Supply voltage, current consumption, power loss	
Supply voltage	
• at DC Rated value	24 V
• at DC	20 ... 30 V
Consumed current at DC at 24 V	
• without connected devices typical	0.13 A
• with connected devices maximum	1 A

Article number	6GT2002-0HD01
Product type designation	RF170C communication module
Permitted ambient conditions	
Ambient temperature	
• during operation	-25 ... +55 °C
• during storage	-40 ... +70 °C
• during transport	-40 ... +70 °C
Protection class IP	IP67
Shock resistance	According to IEC 61131-2
Shock acceleration	300 m/s ²
Vibrational acceleration	100 m/s ²
Design, dimensions and weight	
Width	90 mm
Height	130 mm
Depth	35 mm
Net weight	0.27 kg
Mounting type	ET 200pro rack
Cable length for RS 422 interface maximum	1 000 m
Product properties, functions, components general	
Display version	(see connection block)
Product function transponder file handler can be addressed	No
Protocol is supported	
• S7 communication	Yes
Type of parameterization	HSP
Type of programming	FB 45, FB 55, ident profile, (FC 45/55 with limited functionality)
Type of computer-mediated communication	acyclic communication
Standards, specifications, approvals	
Certificate of suitability	CE, FCC, cULus
MTBF	77 y
Accessories	
accessories	Connection block for RF170C

Ordering data	Article No.		Article No.
SIMATIC RF170C communication module For connecting to the ET 200pro distributed I/O system	6GT2002-0HD01	MOBY D reader cable PUR material, CMG approval, suitable for cable carriers, 2 m	6GT2691-4FH20
Accessories		Reader cable for MV300 handheld readers Coiled cable with usable length of 1.6 m to 4 m for MV320, material: PUR	6GT2191-0BH50
Connection block for SIMATIC RF170C For connecting 2 readers or other RS 422/RS 432 devices via an M12 connector	6GT2002-1HD01	Coiled cable with usable length of 1.6 m to 4 m for MV340, material: PUR	6GT2191-0AH50
Reader cable for SIMATIC RF200 / RF300 / RF600 / MV440 Or MOBY D extension cable and SIMATIC RF200 / RF300 / RF600 / MV400, PUR material, CMG approval, suitable for cable carriers		Connector for connection of other RS 422/RS232 devices 8-pin M12 connector, male, screw contacts for wires up to 0.5 mm ² . Order quantity 1 pack with 5 units	6GT2090-0BE00
2 m, straight connector	6GT2891-4FH20	M12 sealing caps for unused reader connections Minimum order quantity 10 units, price per 100 units	3RX9802-0AA00
5 m, straight connector	6GT2891-4FH50	DVD "RFID Systems Software & Documentation"	6GT2080-2AA20
10 m, straight connector	6GT2891-4FN10		
20 m, straight connector	6GT2891-4FN20		
50 m, straight connector	6GT2891-4FN50		
2 m, plug angled at reader	6GT2891-4JH20		
5 m, plug angled at reader	6GT2891-4JH50		
10 m, plug angled at reader	6GT2891-4JN10		

I/O systems

SIMATIC ET 200 systems without control cabinet
SIMATIC ET 200pro

Power supplies > 3-phase, 24 V DC (ET 200pro PS, IP67)

Overview**Power supply for ET 200pro:**

- 3-phase, 24 V DC/8 A

The SIMATIC ET 200pro PS power supply unit with degree of protection IP67 is used as the electronics/encoder supply and load voltage supply of the new SIMATIC ET 200pro distributed I/O system for use close to the machine without a cabinet. With a signaling contact for "24 V OK" and "Overtemperature", as well as a second plug connector for input voltage loop-through.

Technical specifications

Article number	6ES7148-4PC00-0HA0
Product	SIMATIC ET 200pro PS
Power supply, type	24 V/8 A
Input	
Input	3-phase AC
Rated voltage value $V_{in \text{ rated}}$	400 ... 480 V
Voltage range AC	340 ... 550 V
• Note	320 ... 340 V for max. 1 min
Wide-range input	Yes
Overvoltage resistance	Implemented internally with varistors
Mains buffering at $I_{out \text{ rated}}$, min.	15 ms; at $V_{in} = 400 \text{ V}$
Rated line frequency 1	50 Hz
Rated line frequency 2	60 Hz
Rated line range	45 ... 66 Hz
Input current	
• at rated input voltage 400 V	0.5 A
Switch-on current limiting (+25 °C), max.	40 A
I^2t , max.	3.5 A ² ·s
Built-in incoming fuse	T 4 A
Protection in the mains power input (IEC 898)	Required: Circuit breaker 3RV2011-1DA10 or 3RV2711-1DD10 (UL 489)
Output	
Output	Controlled, isolated DC voltage
Rated voltage $V_{out \text{ DC}}$	24 V
Total tolerance, static ±	3 %
Static mains compensation, approx.	0.5 %
Static load balancing, approx.	0.5 %
Residual ripple peak-peak, max.	200 mV
Spikes peak-peak, max. (bandwidth: 20 MHz)	250 mV
Product function Output voltage adjustable	No
Output voltage setting	-
Status display	Green LED for 24 V OK
Signaling	max. 30 V, 10 mA; Power-Good (High-Pegel 1L+ for V_{out} in range 21.3 ... 29 V); Overtemperature warning at least 30 s before switch-off (high level 1L+ when the max. internal temperature is exceeded)

Article number	6ES7148-4PC00-0HA0
Product	SIMATIC ET 200pro PS
Power supply, type	24 V/8 A
On/off behavior	Overshoot of $V_{out} < 2 \%$
Startup delay, max.	1.5 s
Voltage rise, typ.	40 ms
Rated current value $I_{out \text{ rated}}$	8 A
Current range	0 ... 8 A
Supplied active power typical	192 W
Short-term overload current	
• on short-circuiting during the start-up typical	50 A
• at short-circuit during operation typical	50 A
Duration of overloading capability for excess current	
• on short-circuiting during the start-up	100 ms
• at short-circuit during operation	100 ms
Parallel switching for enhanced performance	No
Efficiency	
Efficiency at $V_{out \text{ rated}}$, $I_{out \text{ rated}}$, approx.	88 %
Power loss at $V_{out \text{ rated}}$, $I_{out \text{ rated}}$, approx.	25 W
Closed-loop control	
Dynamic mains compensation ($V_{in \text{ rated}} \pm 15 \%$), max.	0.5 %
Dynamic load smoothing (I_{out} : 50/100/50 %), $U_{out} \pm \text{typ.}$	1 %
Setting time maximum	2 ms
Protection and monitoring	
Output overvoltage protection	< 33 V
Current limitation, typ.	9.4 A
Property of the output	Yes
Short-circuit proof	
Short-circuit protection	Electronic shutdown, automatic restart
Enduring short circuit current RMS value	
• maximum	10 A
Overload/short-circuit indicator	-

Technical specifications (continued)

Article number	6ES7148-4PC00-0HA0
Product	SIMATIC ET 200pro PS
Power supply, type	24 V/8 A
Safety	
Primary/secondary isolation	Yes
Galvanic isolation	Protective extra low output voltage Vout according to EN 60950-1 and EN 50178
Protection class	Class I
Leakage current	
• maximum	3.5 mA
• typical	0.4 mA
CE mark	Yes
UL/cUL (CSA) approval	UL-Listed (UL 508) according to NFFPA compatibility (National Fire Protection Association), see operating instructions
Explosion protection	No
FM approval	-
CB approval	Yes
Marine approval	No
Degree of protection (EN 60529)	IP67, enclosure type 5 indoor
EMC	
Emitted interference	EN 55022 Class A
Supply harmonics limitation	-
Noise immunity	EN 61000-6-2
Operating data	
Ambient temperature	
• during operation	-25 ... +55 °C
- Note	with natural convection
• during transport	-40 ... +70 °C
• during storage	-40 ... +70 °C
Humidity class according to EN 60721	Climate class 3K3, no condensation

Article number	6ES7148-4PC00-0HA0
Product	SIMATIC ET 200pro PS
Power supply, type	24 V/8 A
Mechanics	
Connection technology	screw-type terminals
Connections	
• Supply input	L1, L2, L3, PE: Plug connector HAN Q4/2 (counterpart see "Electrical accessories")
• Output	L+, M: 2 x 1.5 mm ² each (4-pole cable for +/- with open, labeled ends, 4 x 1.5 mm ²)
• Auxiliary	Alarm signals: M12 plug-in connector 5-pin
Width of the enclosure	310 mm
Height of the enclosure	135 mm
Depth of the enclosure	90 mm
Weight, approx.	2.8 kg
Product feature of the enclosure housing for side-by-side mounting	No
Installation	Can be mounted onto ET200pro DIN rail
Electrical accessories	Power connector (Input: 3RK1911-2BE30 (6 mm ²)) (Output: 3RK1911-2BF10 (4 mm ²))
MTBF at 40 °C	196 354 h
Other information	Specifications at rated input voltage and ambient temperature +25 °C (unless otherwise specified)

Ordering data

Article No.	Article No.
SIMATIC ET 200pro PS Stabilized power supply in distributed I/O system design, permitting the loop-through of energy to further modules; with IP67 degree of protection; Input: 400-480 V 3 AC Output: 24 V DC/8 A	6ES7148-4PC00-0HA0
Accessories	
Power connector For connecting to the distributed I/O system	
• For X1 (6 mm ²) • For X2 (4 mm ²)	3RK1911-2BE30 3RK1911-2BF10

Article No.	Article No.
National Fire Protection Association compatible These devices are only approved for installation in industrial machinery according to the NFFPA79 Electrical Standard for Industrial Machinery.	
• for X1 SIMATIC ET 200pro PS 61 88 201 1003.xx (AWG10)* • for X1 SITOP PSU 300P 61 88 201 1000.xx / 61 88 201 1002.xx (AWG14)* • for X2 SIMATIC ET 200pro PS 61 88 202 1010.xx (AWG10)* supplied blanking cap for X2 • for X3 Phoenix Contact SAC-5P-M12-M12FS supplied blanking cap for X3	* http://www.harting.com/startseite
Sealing cap For 9-pole power sockets	
• X2 (1 unit) • X2 (10 units)	3RK1902-0CK00 3RK1902-0CJ00

I/O systems

SIMATIC ET 200 systems without control cabinet
SIMATIC ET 200pro

ET 200pro motor starters > General data

Overview

ET 200pro motor starters in the ET 200pro I/O system

SIMATIC ET 200pro is the modular I/O system with high IP65/66/67 degree of protection for local, cabinet-free use. The ET 200pro motor starters with the IP65 high degree of protection are an integral part of ET 200pro.



ET 200pro motor starter: Isolator module, Standard starter and High Feature starter mounted on a wide module rack

ET 200pro motor starters

- Only two variants up to 5.5 kW
- All settings can be parameterized by bus
- Comprehensive diagnostic signals
- Support for PROFlenergy
- Overload can be acknowledged by remote reset
- Current unbalance monitoring
- Stall protection
- EMERGENCY START function on overload
- Current value transmission by bus
- Current limit monitoring
- Fully supports of acyclic services
- Direct-on-line or reversing starters
- Power bus connection can be plugged in using Han Q4/2 plug connectors
- Motor feeder with Han Q8/0 connector
- Conductor cross-section up to 6 x 4 mm²
- 25 A per segment (power looped through using jumper plug)
- In Standard and High Feature versions (with 4 DI on board)
- Electromechanical switching and electronic switching
- Electronic starter for direct activation or with integrated soft starter function
- Supplied with 400 V AC brake contact as an option
- Temperature sensor can be connected (Thermoclick or PTC type A)
- Provision of the motor current in PROFlenergy format to higher-level systems, motor current shutdown in dead times using PROFlenergy

ET 200pro isolator modules (see page 9/267)

The isolator module with switch disconnecter function is used for safe disconnection of the 400 V operational voltage during repair work in the plant and provides an integrated group fusing function (i.e. additional group short-circuit protection for all subsequently supplied motor starters).

Depending on the power distribution concept, all stations can be equipped with an isolator module as an option.

More information

- Home page, see www.siemens.com/ET200pro
Industry Mall, see www.siemens.com/product?3RK1304
Further components in the ET 200pro distributed I/O system:
- Catalog ST 70, see www.siemens.com/industry/infocenter
 - Industry Mall, see www.siemens.com/product?ET200pro

Safety applications

Safety Solution local (see page 9/268)

With the Safety modules local

- Safety local isolator module and
- 400 V disconnecting module

and an appropriate connection, safety level PL e (according to ISO 13849-1) can be reached.

Safety Solution PROFIsafe (see page 9/271)

With the Safety modules PROFIsafe

- F-Switch and
 - 400 V disconnecting module
- and an appropriate connection, safety levels SIL 3 (according to IEC 62061) and PL e (according to ISO 13849-1) can also be reached.

Functionality

With the ET 200pro motor starters, any three-phase loads can be protected and switched.

The ET 200pro motor starters are available with mechanical and also electronic contacts.

The ET 200pro electromechanical starters are offered as direct-on-line starters (DSe) and reversing starters (RSe) as **Standard** and **High Feature** versions. There are device versions with or without control for externally fed brakes with 400 V AC.

Compared with the Standard motor starters, the **High Feature mechanical** motor starter also has:

- Four digital inputs
- Advanced parameterization options

The ET 200pro electronic starters are offered as direct-on-line starters (sDSSSte/sDSte) and reversing starters (sRSSSte/sRSte) in the High Feature version:

Compared with the High Feature mechanical motor starters, the **High Feature electronic** motor starter also has:

- Soft starting and smooth ramp-down function
- Deactivated soft start function as an electronic starter for applications with a high switching frequency
- Advanced parameterization options

As a result of the protection concept with solid-state overload evaluation and the use of SIRIUS switching devices, size S00, additional advantages are realized on the Standard and High Feature motor starters – advantages that soon make themselves positively felt particularly in manufacturing processes with high plant stoppage costs:

- Configuration is made easier by the fine modular structure with ET 200pro. When using ET 200pro motor starters, the parts list per load feeder is reduced to two main items: the bus module and the motor starter. This makes the ET 200pro ideal for modular machine concepts or solutions for conveying systems and machine-tool building.

- Expansions are easily possible through the subsequent adding of modules. The innovative plug-in technology also does away with the wiring needed up to now. Through the hot-swapping function (disconnection and connection during operation) a motor starter can be replaced within seconds if necessary, without having to shut down the ET 200pro station and with it the process in the plant. The motor starters are therefore recommendable in particular for applications with special demands on availability. Storage costs are also optimized by the low level of variance (two units up to 5.5 kW).

With four locally acting inputs available on the High Feature motor starter, it is possible to realize autonomous special functions that work independently of the bus and the higher-level control system, e.g. as a quick stop on gate valve controls or limit position disconnectors. In parallel with this, the states of these inputs are signaled to the control system.

Article No. scheme

Product versions		Article number											
Motor starters		3RK1304	-	5	<input type="checkbox"/> S	<input type="checkbox"/> 0	-	<input type="checkbox"/> A	<input type="checkbox"/> A	<input type="checkbox"/>			
Setting range	0.15 ... 2.0 A 1.5 ... 12 A	K											
		L											
Product function	Direct-on-line starters DSe			4		4				Standard			
	Reversing starters RSe			4		5				Standard			
	Direct-on-line starters DSe			4		2				High Feature			
	Reversing starters RSe			4		3				High Feature			
	Direct-on-line starters sDSSSte/sDSte			7		2				High Feature			
	Reversing starters sDSSSte/sDSte			7		3				High Feature			
Inputs/outputs	Without brake output									0			
	With brake output									3 400 V AC, with High Feature + 4 inputs			
Example		3RK1304	-	5	K	S	4	0	-	4	A	A	0

Product versions		Article number											
Modules		3RK1304	-	0	H	S	0	0	-	<input type="checkbox"/> A	<input type="checkbox"/> A	<input type="checkbox"/> 0	
Product function	Isolator modules									6			
	Isolator modules									7		Safety modules local	
	400 V disconnecting modules									8		Safety modules local/PROFIsafe	
Example		3RK1304	-	0	H	S	0	0	-	6	A	A	0

Note:

The Article No. scheme shows an overview of product versions for better understanding of the logic behind the article numbers.

For your orders please use the article numbers quoted in the selection and ordering data.

I/O systems

SIMATIC ET 200 systems without control cabinet
SIMATIC ET 200pro

ET 200pro motor starters > General data

Type Technology designation ¹⁾	Standard motor starters DSe, RSe		High Feature motor starters DSe, RSe	
			sDSSSte, sDSte, sRSSSte, sRSte	
Device functions (firmware features)				
Parameterizable rated operational current		✓		
Integrated short-circuit protection		✓		
Parameterizable current limit values		--	✓ 2 limit values	
Parameterizable response in case of current limit violation		--	✓	
Zero current monitoring		✓		
Parameterizable response in case of zero current violation		✓		
Parameterizable current unbalance limit	%	-- Fixed limit value (30 x I _e)	✓ 30 ... 60 x I _e	
Parameterizable response in case of unbalance limit violation		✓		
Motor blocking monitoring		--	✓	
Parameterizable blocking current limit	%	--	✓ 150 ... 1 000 x I _e	
Parameterizable blocking time limit	s	--	✓ 1 ... 5	
Current value transmission		✓		
Group warning diagnostics		--	✓ Parameterizable	
Group diagnostics		✓ Parameterizable		
EMERGENCY START				
Emergency start		✓		
Digital inputs				
• Parameterizable input signal		--	✓ 4 inputs	
• Parameterizable input level		--	✓ Latching/non-latching	
• Parameterizable input signal delay	ms	--	✓ NC/NO	
• Parameterizable input signal extension	ms	--	✓ 10 ... 80	
• Parameterizable input control actions		--	✓ 0 ... 200	
			✓ 12 different actions	
Brake output (400 V AC)				
Brake output		✓ Order option		
Parameterizable brake enabling delay	s	✓ -2.5 ... +2.5		
Parameterizable holding time of the brake during stopping	s	✓ 0 ... 25		
Parameterizable start-up type		--		✓
Parameterizable ramp-down time		--		✓
Parameterizable starting voltage		--		✓
Parameterizable stopping voltage		--		✓
Local device interface		✓		
Firmware update		✓ By specialists		
Thermal motor model		✓		
Parameterizable trip class		-- CLASS 10 fixed	✓ CLASS 5, 10, 15, 20	
Parameterizable response in case of overload of thermal motor model		--	✓ 3 possible states	
Advance warning limit for motor heating	%	--	✓ Parameterizable 0 ... 95	
Advance warning limit for time-related trip reserve	s	--	✓ Parameterizable 0 ... 500	
Parameterizable recovery time	min	--	✓ 1 ... 30	
Parameterizable protection against voltage failure		-- Permanently integrated	✓	
Reversing start function		✓ Order option		
Parameterizable interlock time for reversing starters		-- 150 ms fixed	✓ 0 ... 60 s	
Integrated logbook functions		✓ 3 device logbooks		
Integrated statistics data memory		✓		
Parameterizable response in case of CPU/master stop		✓		
PROFenergy profile support				
• Disconnection of the motor current during idle times		✓		
• Measured motor current values		✓		
Device indications				
• Group fault		SF LED (red)		
• Switching state		STATE LED (red, yellow, green)		
• Device status		DEVICE LED (red, yellow, green)		
• Digital inputs		--	IN 1 ... IN 4, LED	

✓ Function available

-- Function not available

- ¹⁾ DS Direct-on-line starters
RS Reversing starters
DSS .. Direct-on-line soft starters
RSS .. Reversing soft starters
e Electronic motor protection
te Full motor protection (thermal + electronic)
s Electronic switching with semiconductor.

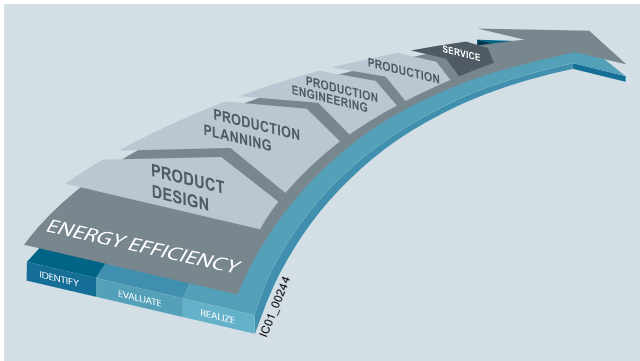
Benefits**Advantages through energy efficiency**

Overview of the energy management process

We offer you a unique portfolio for industrial energy management, using an energy management system that helps to optimally define your energy needs. We split up our industrial energy management into three phases – identify, evaluate, and realize – and we support you with the appropriate hardware and software solutions in every process phase.

The innovative products of the SIRIUS industrial controls portfolio can also make a substantial contribution to a plant's energy efficiency (see www.siemens.com/sirius/energysaving).

SIMATIC ET 200pro motor starters contribute to energy efficiency as follows:

- **Energy management:**
Provision of energy data (current) by bus to higher-level systems using PROFlenergy
- **Elimination of energy consumption in dead times** through disconnection using PROFlenergy
- **Current management:**
Avoidance of current peaks with the electronic soft starter, thus reducing the load on the grid and the mechanical system
- Depending on technology, lower intrinsic power loss than speed-controlled drive systems
- Solid-state modules equipped with soft start technology with bypass contactor, resulting in lower power losses than with conventional soft starters after start-up

Product advantages

ET 200pro motor starters provide the following advantages:

- High flexibility thanks to a modular and compact design
- Little variance among all motor starter versions (two units up to 5.5 kW)
- Extensive parameterization using STEP 7 HW Config
- Increase of plant availability through fast replacement of units (easy mounting and plug-in technology)
- Extensive diagnostics and information for preventive maintenance
- Parameterizable inputs for on-site control functions (High Feature)
- Cabinet-free design thanks to IP65 high degree of protection

Application

The SIMATIC ET 200pro motor starters are ideal for the use of several spatially concentrated distributed drive solutions in which several motors or digital or analog sensors and actuators are addressed from a distributed station. They are perfectly suited for protecting and switching any AC loads.

Use of ET 200pro motor starters in conjunction with IE3/IE4 motors

Note:

For the use of ET 200pro motor starters in conjunction with highly energy-efficient IE3/IE4 motors, please observe the information on dimensioning and configuring; see "Application manual - Controls with IE3/IE4 motors", <https://support.industry.siemens.com/cs/ww/en/view/94770820>.

For more information, see Catalog IC 10.

Application areas

The SIMATIC ET 200pro motor starters are suitable for numerous sectors of industry, e.g. machinery and plant engineering or conveying applications.

I/O systems

SIMATIC ET 200 systems without control cabinet
SIMATIC ET 200pro

ET 200pro motor starters > General data

Technical specifications

More information		Note on security:		
"AS-Interface Basic" manual, see https://support.industry.siemens.com/cs/ww/en/view/35016496		For plant networking, suitable protective measures (including IT security, e. g. network segmentation) must be taken to ensure safe operation of the plant. For more information about the subject of Industrial Security, see www.siemens.com/industrialsecurity .		
"AS-Interface Standard" manual, see https://support.industry.siemens.com/cs/ww/en/view/38722160				
Type		Standard motor starters Mechanically switching without inputs	High Feature motor starters Mechanically switching with inputs	Mechanically switching with inputs and soft starter function
Technology designation ¹⁾		DSe, RSe	DSe, RSe	sDSSte, sDSte, sRSSte, sRSte
Mechanics and environment				
Motor starters or modules that can be connected to ET 200pro with 110 mm width		max. 8		
Mounting dimensions (W x H x D)				
• Direct-on-line starters and reversing starters	mm	110 x 230 x 150		110 x 230 x 160
Permissible ambient temperature				
• During operation	°C	-25 ... +55, from +40 with derating		
• During storage	°C	-40 ... +70		
Permissible mounting position		Vertical, horizontal		
Vibration resistance acc. to IEC 60068, Part 2-6	g	2		
Shock resistance acc. to IEC 60068, Part 2-27	g/ms	Half-sine 15/11		
Degree of protection		IP65		
Pollution degree		3, IEC 60664 (IEC 61131)		
Electrical specifications				
Current consumption at 24 V DC				
• From auxiliary circuit L+/M (U1)	mA	Approx. 40		
• From auxiliary circuit A1/A2 (U2)	mA	Approx. 200		
Rated operational current I_e for power bus	A	25		
Rated operational voltage U_e	V AC	400 (50/60 Hz)		
• Approval according to EN 60947-1, Appendix N	V AC	Up to 400 (50/60 Hz)		
• Approval according to CSA and UL	V AC	Up to 600 (50/60 Hz)		
Approval				
• DIN VDE 0106, Part 101	V	Up to 400		
• CSA and UL approval	V	Up to 600		
Conductor cross-sections	mm ²	max. 6 x 4		
• Incoming power supply				
Touch protection		Finger-safe		
Rated impulse withstand voltage U_{imp}	kV	6		
Rated insulation voltage U_i	V	400		
Rated operational current for starters I_e				
• AC-1/2/3 at 40 °C				
- At 400 V	A	0.15 ... 2.0/1.5 ... 12.0		0.15 ... 2.0/1.5 ... 12.0 ²⁾
- At 500 V	A	0.15 ... 2.0/1.5 ... 9.0		
• AC-4 at 40 °C				
- At 400 V	A	0.15 ... 2.0/1.5 ... 4.0		
Rated short-circuit breaking capacity	kA	100 at 400 V		
Type of coordination acc. to IEC 60947-4-1		1		
Power of three-phase motors at 400 V	kW	Max. 5.5		Max. 5.5/4 ³⁾
Utilization categories		AC-1, AC-2, AC-3, AC-4		AC-53a ⁴⁾ (max. 9 A with deactivated soft start function up to CLASS 10)
Protective separation between main and auxiliary circuits	V	400, acc. to EN 60947-1, Appendix N		
Endurance of contactor				
• Mechanical	Operating cycles	30 million		
• Electrical	Operating cycles	Up to 10 million; depending on the current loading (see manual, https://support.industry.siemens.com/cs/ww/en/view/22332388)		
Permissible switching frequency		Depending on the current load, motor starting time, and relative ON period (see manual, https://support.industry.siemens.com/cs/ww/en/view/22332388)		
Switching times at 0.85 ... 1.1 x U_e				
• Closing delay	ms	11 ... 50		
• Opening delay	ms	5 ... 45		

¹⁾ DS ... Direct-on-line starters
RS ... Reversing starters
DSS .. Direct-on-line soft starters
RSS .. Reversing soft starters
e Electronic motor protection
te Full motor protection (thermal + electronic)

s Electronic switching with semiconductor.

²⁾ If the soft starter control function is deactivated, the permissible rated operational current is reduced to 9 A up to CLASS 10.

³⁾ With parameterization as electronic starter max. 4 kW.

⁴⁾ 8-hour operation.

Overview

The functionality, device functions, and technical specifications of the Standard motor starter are described in "ET 200pro motor starters, General Data" (see from page 9/260).

Selection and ordering data

Version	Article No.
---------	-------------

Standard motor starters, mechanical
Motor protection: thermal model

DSe Standard

Direct-on-line starters DSe¹⁾

- Without brake output
- With brake output 400 V AC

3RK1304-5□S40-4AA0
3RK1304-5□S40-4AA3
Reversing starters RSe¹⁾

- Without brake output
- With brake output 400 V AC

3RK1304-5□S40-5AA0
3RK1304-5□S40-5AA3

Setting range
Rated operational current

- 0.15 ... 2.0 A
- 1.5 ... 12.0 A

K
L

¹⁾ Only functions when used together with the backplane bus module and the wide module rack. The backplane bus module and the wide module rack must be ordered separately (see "Accessories for ET 200pro motor starters", page 9/276).

I/O systems

SIMATIC ET 200 systems without control cabinet
SIMATIC ET 200pro

ET 200pro motor starters > High Feature motor starters **IE3/IE4 ready**

Overview

The functionality, device functions, and technical specifications of the High Feature motor starter are described in "ET 200pro motor starters, General Data" (see from page 9/260).

The High Feature motor starter differs from the Standard motor starter in having more parameters and four integrated, freely-parameterizable digital inputs.

Selection and ordering data

Version	Article No.
---------	-------------

High Feature motor starters, mechanical Motor protection: thermal model



RSe High Feature

Direct-on-line starters DSe¹⁾

- Without brake output and with 4 inputs
- With brake output 400 V AC and 4 inputs

3RK1304-5□S40-2AA0
3RK1304-5□S40-2AA3

Reversing starters RSe¹⁾

- Without brake output and with 4 inputs
- With brake output 400 V AC and 4 inputs

3RK1304-5□S40-3AA0
3RK1304-5□S40-3AA3

Setting range
Rated operational current

- 0.15 ... 2.0 A
- 1.5 ... 12.0 A

K
L

High Feature motor starters²⁾, electronic Full motor protection, comprising thermal motor protection and thermistor motor protection



sRSSt High Feature

Direct-on-line starters sDSte/sDSte¹⁾²⁾

- Without brake output and with 4 inputs
- With brake output 400 V AC and 4 inputs

3RK1304-5□S70-2AA0
3RK1304-5□S70-2AA3

Reversing starters sRSSt/sRSSt¹⁾²⁾

- Without brake output and with 4 inputs
- With brake output 400 V AC and 4 inputs

3RK1304-5□S70-3AA0
3RK1304-5□S70-3AA3

Setting range
Rated operational current

- 0.15 ... 2.0 A
- 1.5 ... 12.0 A

K
L

¹⁾ Only functions when used together with the backplane bus module and the wide module rack. The backplane bus module and the wide module rack must be ordered separately (see "Accessories for ET 200pro motor starters" on page 9/276).

²⁾ The solid-state motor starters can be used not only as solid-state motor starters with a high level of switching frequency but also as fully fledged soft starters for soft starting and stopping. The changeover from motor starter to soft starter takes place through reparameterization in HW Config. Depending on the setting, this results in the following current ranges:

- Parameterization as solid-state motor starter: 0.15 to 2 A and 1.5 to 9 A (4 kW)
- Parameterization as soft starter: 0.15 to 2 A and 1.5 to 12 A (5.5 kW).

Overview

The isolator module with integrated group fusing function (i.e. additional group short-circuit protection for all subsequently supplied motor starters) and switch disconnecter function is used for safe disconnection of the 400 V operational voltage in the plant.

Depending on the power distribution concept, all stations can be equipped with an isolator module as an option.

The following properties apply to the isolator module:

- Increase of plant availability through fast replacement of units (easy mounting and plug-in technology)
- Cabinet-free design thanks to IP65 high degree of protection

The isolator module is also available in a safety version (see page 9/268, "Safety local isolator module").

Technical specifications

Type	Isolator modules	
General data		
Mounting dimensions (W x H x D)		
• Direct-on-line starters and reversing starters	mm	110 x 230 x 170
Permissible ambient temperature		
• During operation	°C	-25 ... +55
• During storage	°C	-40 ... +70
Permissible mounting position		
		Any
Vibration resistance acc. to IEC 60068 Part 2-6		
	g	2
Shock resistance acc. to IEC 60068 Part 2-27		
	g/ms	Half-sine 15/11
Power consumption		
• From auxiliary circuit L+/M (U1)	mA	Approx. 20
• From auxiliary circuit A1/A2 (U2)		--
Rated operational current I_e for power bus		
	A	25
Rated operational voltage U_e		
	V	400
Approvals according to		
• DIN VDE 0106, Part 101	V	Up to 500
• CSA and UL	V	Up to 600
Conductor cross-sections		
• Incoming power supply	mm ²	max. 6 x 4

Type	Isolator modules	
Degree of protection		
		IP65
Touch protection		
		Finger-safe
Pollution degree		
		3, IEC 60664 (IEC 61131)
Rated impulse withstand voltage U_{imp}		
	kV	6
Rated insulation voltage U_i		
	V	400
Rated operational current for starters I_e		
• AC-1/2/3 at 40 °C		
- At 400 V	A	25
- At 500 V	A	25
Rated short-circuit breaking capacity		
	kA	50 at 400 V
Type of coordination acc. to IEC 60947-4-1		
		2
Protective separation between main and auxiliary circuits		
	V	400, Acc. to DIN VDE 0106 Part 101
Device functions		
• Group diagnostics		Yes, parameterizable
Device indications		
• Group fault		SF LED (red)

Selection and ordering data

Version	Article No.
---------	-------------

ET 200pro isolator modules, mechanical

3RK1304-0HS00-6AA0

Isolator modules¹⁾
Rated operational current 25 A

3RK1304-0HS00-6AA0

¹⁾ Only functions when used together with the corresponding 110 mm backplane bus module and the wide module rack. The backplane bus module and the wide module rack must be ordered separately (see page 9/276, "Accessories for ET 200pro motor starters").

I/O systems

SIMATIC ET 200 systems without control cabinet
SIMATIC ET 200pro

ET 200pro Safety motor starters Solutions local/PROFIsafe > Safety modules local

Overview

Safety Solution local

With the Safety local modules

- Safety local isolator module and
 - 400 V disconnecting module
- and an appropriate connection, safety level PL e (according to ISO 13849-1) can be reached.



ET 200pro motor starter (Safety Solution local):
Safety local isolator module, disconnecting module, Standard starter
and High Feature starter mounted on a wide module rack

Safety local isolator module

The Safety local isolator module is a repair switch with integrated safety evaluation functions that can be parameterized using DIP switches.

It is used for

- Connection of a 1 or 2-channel EMERGENCY STOP circuit up to PL e (protective door or EMERGENCY STOP pushbuttons) and parameterizable start behavior
- For controlling the 400 V disconnecting module by means of a safety rail signal

400 V disconnecting module

The 400 V disconnecting module enables the safe disconnection of an operational voltage of 400 V up to PL e. For operation in a Safety Solution local application, it functions only in combination with the Safety local isolator module.

For operation in a Safety PROFIsafe application, it functions only in combination with the F-Switch.

Functionality

Safety local isolator module

The Safety local isolator module features the same functions as a standard isolator module with an additional local safety function.

The Safety local isolator module contains a 3TK2841 module and is equipped with M12 terminals for the connection of external safety components.

Terminals 1 and 2 can be used to connect either 1-channel or 2-channel EMERGENCY STOP circuits or protective door circuits (IN 1, IN 2).

For monitored starts, an external START switch can be connected to terminal 3.

The required safety functions can be set using two slide switches located under the left M12 opening.

In the event of an EMERGENCY STOP, the Safety local isolator module trips the downstream 400 V disconnecting module. This safely separates the 400 V circuit up to PL e.

In combination with the 400 V disconnecting module, the Safety local isolator module can be used for safety applications up to PL e.

400 V disconnecting module

The 400 V disconnecting module can be used together with the Safety local isolator module for local safety applications and together with the F-Switch for PROFIsafe safety applications.

It contains two contactors connected in series for safety-related disconnection of the main circuit.

The auxiliary circuit supply of the device is over a safety power rail in the backplane bus module.

The 400 V disconnecting module can be used in conjunction with the Safety local isolator module or with the F-Switch for safety applications up to PL e.

Technical specifications



Type		Safety local isolator module	400 V disconnecting module
General data			
Mounting dimensions (W x H x D) in mm			
• Direct-on-line starters and reversing starters	mm	110 x 230 x 170	110 x 230 x 150
Permissible ambient temperature			
• During operation	°C	-25 ... +55	
• During storage	°C	-40 ... +70	
Permissible mounting position		Any	
Vibration resistance acc. to IEC 60068, Part 2-6		2 g	
Shock resistance acc. to IEC 60068, Part 2-27		Half-sine 15 g/11 ms	
Power consumption			
• From auxiliary circuit L+/M (U1)	mA	Approx. 20	
• From auxiliary circuit A1/A2 (U2)		--	
Rated operational current I_e for power bus	A	25	
Rated operational voltage U_e	V	400 (50/60 Hz)	
Approval DIN VDE 0106, Part 101	V	Up to 500	
CSA and UL approval	V	Up to 600	
Conductor cross-sections			
Incoming power supply	mm ²	max. 6 x 4	
Degree of protection		IP65	
Touch protection		Finger-safe	
Pollution degree		3, IEC 60664 (IEC 61131)	
Rated impulse withstand voltage U_{imp}	kV	6	
Rated insulation voltage U_i	V	400	
Rated operational current I_e for starters			
• AC-1/2/3 at 40 °C			
- At 400 V	A	16	25
- At 500 V	A	16	25
Rated short-circuit breaking capacity	kA	50 at 400 V	
Type of coordination acc. to IEC 60947-4-1		2	
Protective separation between main and auxiliary circuits	V	400, Acc. to DIN VDE 0106 Part 101	
Switching times at 0.85 ... 1.1 x U_e			
• Closing delay	ms	--	25 ... 100
• Opening delay	ms	--	7 ... 10
Device functions			
• Group diagnostics		Yes, parameterizable	
Device indications			
• Group fault		SF LED (red)	

I/O systems

SIMATIC ET 200 systems without control cabinet

SIMATIC ET 200pro

ET 200pro Safety motor starters Solutions local/PROFIsafe > Safety modules local **IE3/IE4 ready****Selection and ordering data**

Version	Article No.
Safety modules local	
 <p>Safety local isolator module¹⁾²⁾ Rated operational current 16 A</p> <p>3RK1304-OHS00-7AA0</p>	3RK1304-OHS00-7AA0
 <p>400 V disconnecting module³⁾⁴⁾ Rated operational current 25 A</p> <p>3RK1304-OHS00-8AA0</p>	3RK1304-OHS00-8AA0

- 1) The Safety local isolator module only functions when used together with the 400 V disconnecting module.
- 2) Only in combination with the special backplane bus module for the Safety local isolator module (see page 9/276, "Accessories for ET 200pro motor starters").
- 3) The 400 V disconnecting module functions only when used together with the Safety local isolator module or with the F-Switch.
- 4) The 400 V disconnecting module functions only when used together with the backplane bus module and the wide module rack. The backplane bus module and the wide module rack must be ordered separately (see page 9/276, "Accessories for ET 200pro motor starters").

Overview**Safety Solution PROFIsafe**

With the Safety modules PROFIsafe

- F-Switch and
 - 400 V disconnecting module
- and an appropriate connection, safety levels SIL 3 (according to IEC 62061) and PL e (according to ISO 13849-1) can be reached.

F-Switch PROFIsafe

Fail-safe digital inputs/outputs in degrees of protection IP65 to IP67 for machine-level, cabinet-free use.

Fail-safe digital inputs

- For fail-safe reading in of sensor information (1/2-channel)
- Including integrated discrepancy evaluation for 2-out-of-2 signals
- Internal sensor supplies (incl. testing) available

Fail-safe digital outputs

- Three fail-safe PP-switching outputs for safe switching of the backplane busbars

The F-Switch is certified up to SIL 3/PL e and has detailed diagnostics.

It supports PROFIsafe in PROFIBUS configurations as well as in PROFINET configurations.

Note:

For safety characteristics, see [Catalog IC 10 2017 → Chapter 16 "Appendix" → "Standards and approvals" → "Overview"](#).



400 V disconnecting module

See ["Safety modules local", Overview, on page 9/268 and Technical specifications, page 9/269](#).

Functionality

The PROFIsafe F-Switch is a fail-safe electronic module for PROFIsafe safety applications. It has two fail-safe inputs and outputs for safe switching of the 24 V supply over backplane busbars. In combination with the 400 V disconnecting module, fail-safe disconnection of ET 200pro motor starters is possible in PROFIsafe applications up to SIL 3/PL e.

Selection and ordering data

Version	Article No.
ET 200pro safety modules	
 400 V disconnecting module¹⁾²⁾ Rated operational current 25 A 3RK1304-0HS00-8AA0	3RK1304-0HS00-8AA0
 F-Switch PROFIsafe 24 V DC, including bus module Connection module must be ordered separately 6ES7148-4FS00-0AB0	6ES7148-4FS00-0AB0
Connection modules for F-Switch 24 V DC 6ES7194-4DA00-0AA0	6ES7194-4DA00-0AA0

¹⁾ The 400 V disconnecting module functions only when used together with the Safety local isolator module or with the F-Switch.

²⁾ The 400 V disconnecting module functions only when used together with the backplane bus module and the wide module rack. The backplane bus module and the wide module rack must be ordered separately (see page 9/276, "Accessories for ET 200pro motor starters").

I/O systems

SIMATIC ET 200 systems without control cabinet
SIMATIC ET 200pro

ET 200pro Safety motor starters Solutions local/PROFIsafe > Accessories for ET 200pro motor starters

Overview

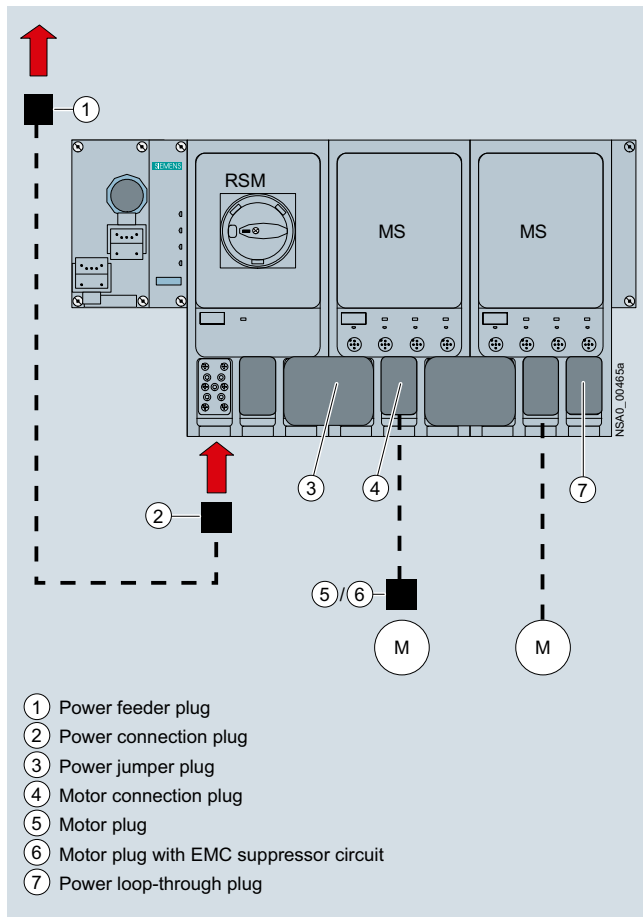

Basic design of an ET 200pro version with (from the left) connection module for IM, interface module for communication (IM), RSM isolator module, two ET 200pro motor starters (MS), and connections for power

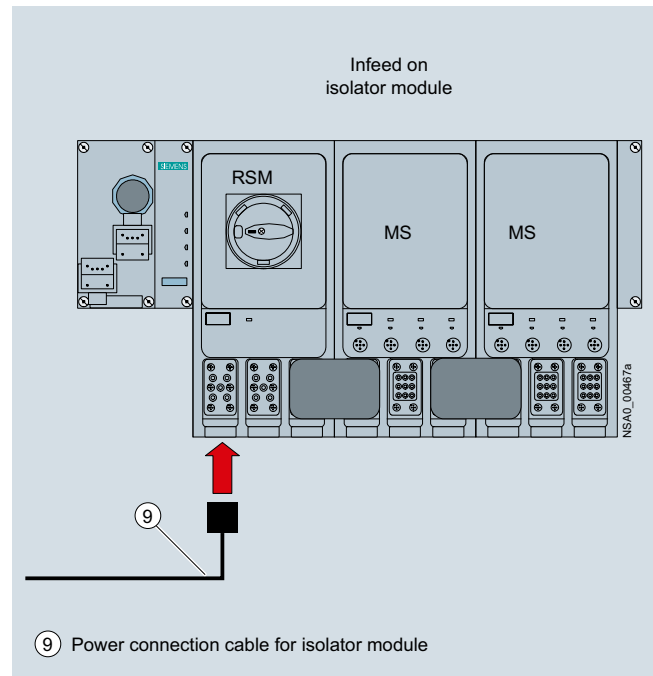

Infeed on the RSM isolator module

Legend:

- ① Power feeder plug (see page 9/274)
- ② Power connection plug (see page 9/274)
- ③ Power jumper plug (see page 9/274)
- ④ Motor connection plug (see page 9/274)
- ⑤ Motor plug (see page 9/274)
- ⑥ Motor plug with EMC suppressor circuit (see page 9/274)
- ⑦ Power loop-through plug (see page 9/274)
- ⑧ Power connection cable (see page 9/274)
- ⑨ Power connection cable for isolator modules (see page 9/274)
- ⑩ Motor cable (see page 9/275)

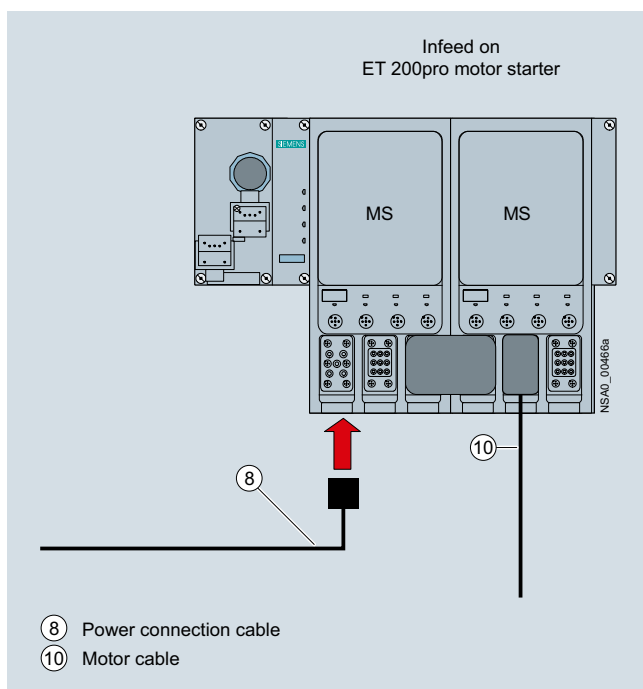

Infeed on the ET 200pro motor starter

Power bus

The power supply to the field devices (ET 200pro motor starters, M200D motor starters) is provided via the power bus, in which the power T terminal connectors or power double-T terminal connectors are connected by power bus cables.

Feeders

From the terminal connectors, spur lines with Han Q4/2 plugs lead to the field devices, from which the motors are supplied with power via motor connection cables.

Interruption-free thanks to power terminal connectors

In finger-safe connection technology the power T terminal connectors and power double-T terminal connectors connect the components of a feeder to the power bus. They ensure interruption-free operation, i.e. the power bus is not interrupted when the components are plugged in.

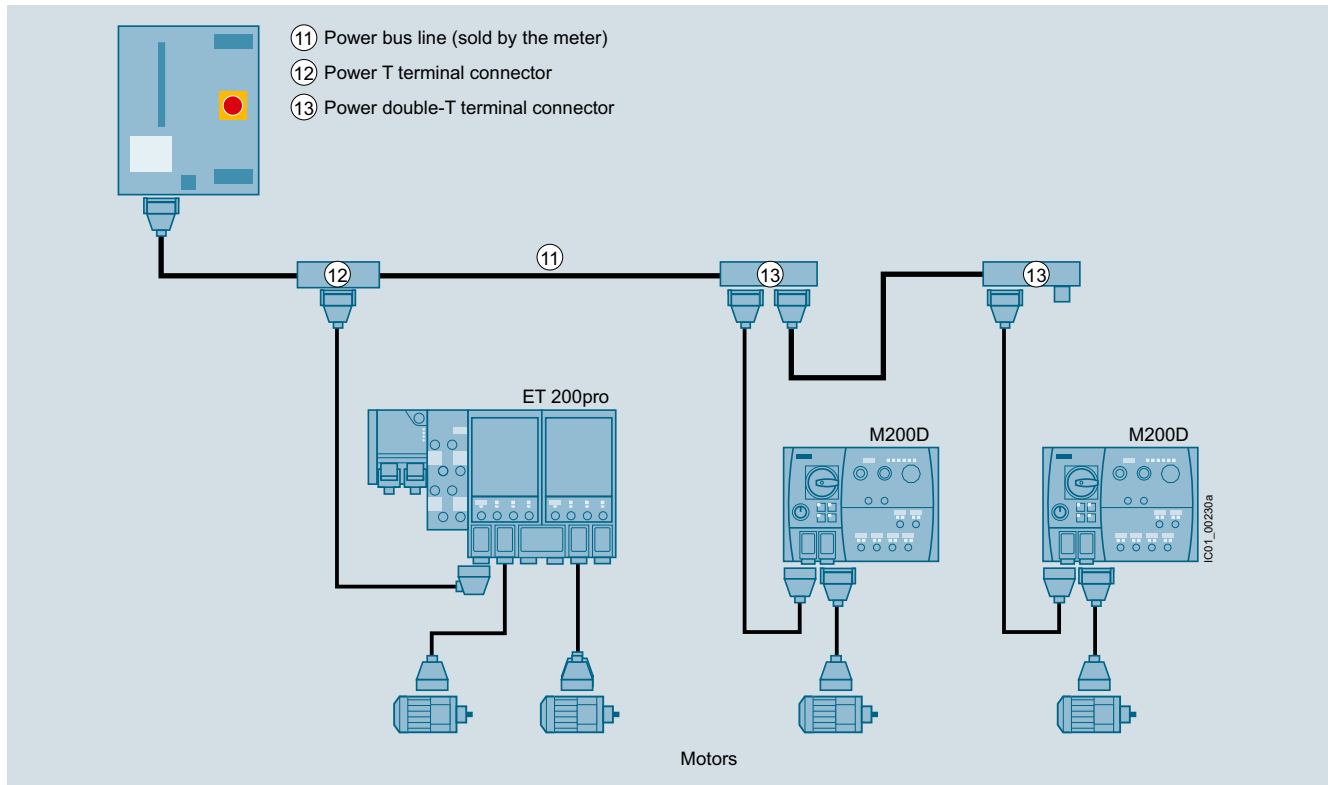

Power supply to the motors via the power bus with power T and double-T terminal connectors linked by power bus cables, spur lines to the field devices (motor starters), and power loop-through connections to the motors via motor connection cables

Motor control via PROFIBUS

The interface modules (IM) for PROFIBUS can be combined with three different connection modules for connecting PROFIBUS DP and the power supply:

- Direct connection with cable glands
- ECOFAST connection with hybrid fieldbus cables (with two copper cores for data transfer with PROFIBUS DP, and four copper cores for the power supply) and ECOFAST connectors (HanBrid)¹⁾
- M12, 7/8" connection
 - with M12 connecting cable and M12 plugs for data transmission with PROFIBUS DP
 - with 7/8" connecting cable and 7/8" plugs for the power supply²⁾

For the connection modules with the associated accessories, see [Accessories ET 200pro interface modules IM 154-1 and IM 154-2, page 9/230](#).

¹⁾ Hybrid fieldbus connections with HanBrid sockets designed as cabinet bushings transmit data and energy from the control cabinet (IP20) to the field (IP65). They are the interface for jointly routing PROFIBUS DP and the auxiliary voltages into the hybrid fieldbus cable.

²⁾ On the control cabinet bushings with two M12 sockets for the PROFIBUS M12 connecting cables, the 24 V supply of the motor starters is implemented via separate 7/8" connecting cables.

Motor control via PROFINET

For the connection modules with the associated accessories, see ["Accessories ET 200pro interface module IM 154-4, page 9/232"](#).

I/O systems

SIMATIC ET 200 systems without control cabinet



SIMATIC ET 200pro

ET 200pro Safety motor starters Solutions local/PROFIsafe > Accessories for ET 200pro motor starters

Selection and ordering data

Version	Article No.
Incoming power supply	
① Power feeder plugs Connector set for energy supply, e.g. for connecting to T terminal connectors, comprising a coupling enclosure, straight outgoing feeder (with bracket), pin insert for HAN Q4/2, incl. gland <ul style="list-style-type: none"> • 5 male contacts, 2.5 mm² • 5 male contacts, 4 mm² • 5 male contacts, 6 mm² 	3RK1911-2BS60 3RK1911-2BS20 3RK1911-2BS40
② Power connection plugs Connector set for energy supply for connection to ET 200pro motor starters/ET 200pro isolator modules, comprising a cable-end connector hood, angular outgoing feeder, female insert for HAN Q4/2, incl. gland <ul style="list-style-type: none"> • 5 female contacts, 2.5 mm² • 5 female contacts, 4 mm² • 5 female contacts, 6 mm² 	3RK1911-2BE50 3RK1911-2BE10 3RK1911-2BE30
⑧ Power connection cables, assembled at one end Power connection cable for ET 200pro motor starters, open at one end, for HAN Q4/2, angular, insert turned at isolator module end, 4 x 4 mm ² <ul style="list-style-type: none"> • Length 1.5 m • Length 5.0 m 	3RK1911-0DB13 3RK1911-0DB33
⑨ Power connection cables for isolator module, assembled at one end Power connection cable for ET 200pro isolator modules, open at one end, for HAN Q4/2, angular, insert turned at isolator module end, 4 x 4 mm ² <ul style="list-style-type: none"> • Length 1.5 m • Length 5.0 m 	3RK1911-0DF13 3RK1911-0DF33
Power loop-through on the field device	
③ Power jumper plugs	3RK1922-2BQ00
⑦ Power loop-through plugs Connector set for power loop-through for connection to ET 200pro motor starters/ET 200pro isolator modules, comprising a cable-end connector hood, angular outgoing feeder, male insert for HAN Q4/2, incl. gland <ul style="list-style-type: none"> • 4 male contacts, 2.5 mm² • 4 male contacts, 4 mm² 	3RK1911-2BF50 3RK1911-2BF10
Motor cables	
④ Motor connection plugs Connector set for motor cable for connection to ET 200pro motor starters, comprising a cable-end connector hood, angular outgoing feeder, pin insert for HAN Q8/0, incl. gland <ul style="list-style-type: none"> • 8 male contacts, 1.5 mm² • 6 male contacts, 2.5 mm² 	3RK1902-0CE00 3RK1902-0CC00
⑤ Motor plugs Connector set for motor cable for connection to motors, comprising a cable-end connector hood, straight outgoing feeder, female insert for HAN 10e, incl. star jumper, incl. gland <ul style="list-style-type: none"> • 7 female contacts, 1.5 mm² • 7 female contacts, 2.5 mm² 	3RK1911-2BM21 3RK1911-2BM22
⑥ Motor plugs with EMC suppressor circuit Connector set for motor cable for connection to motors, comprising a cable-end connector hood, straight outgoing feeder, female insert for HAN 10e with EMC suppressor circuit, incl. star jumper, incl. gland <ul style="list-style-type: none"> • 7 female contacts, 1.5 mm² • 7 female contacts, 2.5 mm² 	3RK1911-2BL21 3RK1911-2BL22

ET 200pro Safety motor starters Solutions local/PROFIsafe > Accessories for ET 200pro motor starters

Version	Article No.
Motor cables (continued)	
<p>⑩ Motor cables, assembled at one end Open at one end, HAN Q8, angular, length 5 m</p> <ul style="list-style-type: none"> • Motor cable for motor without brake for ET 200pro, 4 x 1.5 mm² • Motor cable for motor with brake for ET 200pro, 6 x 1.5 mm² • Motor cables for motor without brake with thermistor for ET 200pro, 6 x 1.5 mm² • Motor cables for motor with brake with thermistor for ET 200pro, 8 x 1.5 mm² 	<p>3RK1911-0EB31</p> <p>3RK1911-0ED31</p> <p>3RK1911-0EF31</p> <p>3RK1911-0EG31</p>
Power bus	
<p>⑫ Power T terminal connectors For 400 V AC, for connection of feeders (e.g. motor starters) by means of standard round cable at any point of the power bus, by insulation displacement connection, used with pre-assembled bus segments</p> <ul style="list-style-type: none"> • 2.5 mm² / 4 mm² • 4 mm² / 6 mm² 	<p>3RK1911-2BF01</p> <p>3RK1911-2BF02</p>
<p>⑬ Power double-T terminal connectors For 400 V AC, for connection of feeders (e.g. motor starters) by means of standard round cable at any point of the power bus, by insulation displacement connection, used with pre-assembled bus segments, connection of two motor starters possible</p> <ul style="list-style-type: none"> • 4 mm² / 6 mm² 	<p>3RK1911-2BG02</p>
<p>Sealing set (comprising 2 seals) For power T/power double-T terminal connectors</p> <ul style="list-style-type: none"> • For power cables with Ø 10 ... 13 mm • For power cables with Ø 13 ... 16 mm • For power cables with Ø 16 ... 19 mm • For power cables with Ø 19 ... 22 mm • Blanking plugs 	<p>3RK1911-5BA00</p> <p>3RK1911-5BA10</p> <p>3RK1911-5BA20</p> <p>3RK1911-5BA30</p> <p>3RK1911-5BA50</p>
Further accessories for power connections	
 <p>Crimping tool For pins/sockets, 4 mm² and 6 mm²</p> <p>3RK1902-0CW00</p>	<p>3RK1902-0CW00</p>
<p>Dismantling tools</p> <ul style="list-style-type: none"> • For male and female contacts for 9-pole HAN Q4/2 inserts • For male and female contacts for 9-pole HAN Q8 inserts 	<p>3RK1902-0AB00</p> <p>3RK1902-0AJ00</p>
 <p>Sealing caps For 9-pole power socket connectors</p> <ul style="list-style-type: none"> • 1 unit per pack • 10 units per pack <p>3RK1902-0CK00</p>	<p>3RK1902-0CK00</p> <p>3RK1902-0CJ00</p>

For more connection technology products, see "Siemens Solution Partners Automation" under the "Distributed Field Installation System" technology: www.siemens.com/partnerfinder.

I/O systems

SIMATIC ET 200 systems without control cabinet
SIMATIC ET 200pro

ET 200pro Safety motor starters Solutions local/PROFIsafe > Accessories for ET 200pro motor starters

Version	Article No.
Further accessories	
Module racks, wide¹⁾ <ul style="list-style-type: none"> Length 500 mm Length 1 000 mm Length 2 000 mm 	6ES7194-4GB00-0AA0 6ES7194-4GB60-0AA0 6ES7194-4GB20-0AA0
Module racks, wide, compact¹⁾ <ul style="list-style-type: none"> Length 500 mm Length 1 000 mm Length 2 000 mm 	6ES7194-4GD00-0AA0 6ES7194-4GD10-0AA0 6ES7194-4GD20-0AA0
Backplane bus modules 110 mm²⁾	3RK1922-2BA00
Backplane bus module for Safety local isolator modules	3RK1922-2BA01
Hand-held devices For ET 200pro motor starters (or for ET 200S High Feature and M200D motor starters) for local operation. The motor-starter-specific serial interface cables must be ordered separately. The RS 232 interface cable 3RK1922-2BP00 is used for the MS ET 200pro.	3RK1922-3BA00
RS 232 interface cable Serial data connection between ET 200pro (or M200D) motor starters and the RS 232 interface of a PC/PG/laptop (with the Motor Starter ES software) or the handheld device 3RK1922-3BA00.	3RK1922-2BP00
USB interface cables, 2.5 m Serial data connection between ET 200pro (or M200D) motor starters and the USB interface of a PC/PG/laptop (with the Motor Starter ES software).	6SL3555-0PA00-2AA0
M12 sealing caps For sealing unused M12 input or output sockets (one set contains ten sealing caps).	3RK1901-1KA00
Motor control with PROFIBUS	
	See page 9/227
Motor control with PROFINET	
	See page 9/231
SIMATIC ET 200pro motor starters manual	
	See https://support.industry.siemens.com/cs/ww/en/view/22332388



3RK1922-3BA00



3RK1901-1KA00

¹⁾ The wide module rack can accommodate all ET 200pro motor starters and any optional modules (isolator module, Safety local isolator module and 400 V disconnecting module).

²⁾ The backplane bus module is a prerequisite for operation of the ET 200pro motor starter and the optional module.

Overview



SIMATIC ET 200pro FC-2 frequency converter

The SIMATIC ET 200pro FC-2 frequency converter has the design of a SIMATIC ET 200pro module. It supplements the SIMATIC ET 200pro system range with distributed, speed-controlled drives. It is suitable for the open-loop and closed-loop control of induction motors in a wide range of industrial applications. It is predestined for conveyor technology applications using drives networked via PROFIBUS and PROFINET, in particular in distributed designs without control cabinet with high degree of protection (IP65), when combining several drives. The modular, service-friendly concept is ideally suited to manufacturing processes with high plant standstill costs.

Reasons for using distributed drive systems

- Modular drive solutions – therefore standardized mechatronic elements that can be individually tested
- A control cabinet is not required, resulting in a smaller space requirement and lower cooling requirements
- Long motor cables between converter and motor are not required
 - Less power losses
 - Reduced noise radiation
 - Reduced costs for shielded cables
 - No additional filters

- Distributed configurations offer considerable benefits for conveyor systems with their extensive coverage (e.g. in the automotive and logistics industries)

Siemens family of distributed drives

Siemens offers an innovative portfolio of frequency converters to optimally implement distributed drive solutions. The strengths of the individual members of the drive family permit simple adaptation to the widest range of application demands:

- Identical connection systems
- Standard commissioning and engineering tools for the family of distributed drives:
 - SINAMICS G110M frequency inverters
 - SINAMICS G110D frequency inverters
 - SINAMICS G120D frequency inverters
 - SIMATIC ET 200pro FC-2 frequency converters
 - SIRIUS M200D motor starters

Safety Integrated

The distributed SIMATIC ET 200pro FC-2 frequency converters are already equipped with the integrated STO (Safe Torque Off) safety function, certified in accordance with IEC 61508 SIL 2 as well as EN ISO 13849-1 PL d and Category 3. This can be activated by means of PROFIsafe.

STARTER commissioning tool

The STARTER commissioning tool (V4.4 and higher) plus the corresponding SINAMICS Support Package (SSP) supports the commissioning and maintenance of SIMATIC ET 200pro FC-2 frequency converters.

The operator guidance combined with comprehensive, user-friendly functions for the relevant drive solution allow you to commission the device quickly and easily.

STEP 7 classic engineering framework (V5.5 and higher)

Hardware Support Packages (HSP) are available for integrating SIMATIC ET 200pro FC-2 in STEP 7 classic.

TIA Portal engineering framework (V13 SP1 and higher)

TIA Portal is a powerful engineering framework providing full access to the whole digitized automation.

Hardware Support Packages (HSP) are available for integrating SIMATIC ET 200pro FC-2 in TIA Portal.

Technical specifications

Distributed frequency converter	SIMATIC ET 200pro FC-2
Selection features	
Integrated safety functions acc. to IEC 61508 SIL 2 and EN ISO 13849-1 PL d and Category 3	<ul style="list-style-type: none"> • Safe Torque Off (STO) • Control of the integrated safety function via the Safety Local isolator module F-RSM or via F-Switch PROFIsafe
Electrical data	
Line voltage	380 ... 480 V 3 AC ±10 %
Power	
• With an ambient temperature of 0 ... 55° C	1.1 kW
• With an ambient temperature of 0 ... 45° C	1.5 kW
Rated input current / output current	
• With an ambient temperature of 0 ... 55° C	2 A/3.5 A
• With an ambient temperature of 0 ... 45° C	2.5 A/3.9 A

I/O systems

SIMATIC ET 200 systems without control cabinet

SIMATIC ET 200pro

SIMATIC ET 200pro FC-2 frequency converter**Technical specifications** (continued)

Distributed frequency converter	SIMATIC ET 200pro FC-2															
Line frequency	47 ... 63 Hz															
Overload capability	<ul style="list-style-type: none"> • Overload current 1.5 x rated output current (i.e. 150 % overload) for 60 s, cycle time 300 s • Overload current 2 x rated output current (i.e. 200 % overload) for 3 s, cycle time 300 s 															
Output frequency	0 ... 550 Hz															
Pulse frequency	4 kHz (standard) 4 ... 16 kHz (in 2 kHz increments)															
Standard SCCR (Short Circuit Current Rating)	10 kA															
Skipped frequency range	1, programmable															
Converter efficiency	95 ... 97 %															
Interfaces	<ul style="list-style-type: none"> • Connection to PROFIBUS and PROFINET over the SIMATIC ET 200pro backplane bus • Mini USB interface for commissioning via PC (as from STARTER V4.4 plus SSP) • Optical interface for commissioning via the IOP Handheld • Slot for an optional memory card (SD) to upload or download parameter settings • PTC, bimetal, KTY84, Pt1000 interface for motor temperature monitoring 															
Functions																
Open-loop/closed-loop control techniques	<ul style="list-style-type: none"> • V/f control – linear ($M \sim n$) with/without flux current control (FCC), quadratic ($M \sim n^2$) or parameterizable • Vector control – sensorless • Closed-loop torque control 															
Operating functions	<ul style="list-style-type: none"> • Jogging • BICO technology • Automatic restart following interruptions in operation due to a power failure • Smooth connection of converter to rotating motor 															
Braking functions	<ul style="list-style-type: none"> • Integrated regenerative feedback functionality • Control of an electromagnetic holding brake <p>Integrated brake control supplies DC power supply to the brake</p> <table border="1"> <thead> <tr> <th>Line voltage</th> <th>380 V AC</th> <th>400 V AC</th> <th>440 V AC</th> <th>480 V AC</th> </tr> </thead> <tbody> <tr> <td>Rectified brake voltage</td> <td>171 V DC</td> <td>180 V DC</td> <td>198 V DC</td> <td>216 V DC</td> </tr> <tr> <td>Recommended brake coil voltage for Siemens motors</td> <td>170 ... 200 V DC</td> <td>170 ... 200 V DC 184 ... 218 V DC</td> <td>184 ... 218 V DC</td> <td>184 ... 218 V DC</td> </tr> </tbody> </table> <p>Disconnection on the DC side permits "fast" braking.</p>	Line voltage	380 V AC	400 V AC	440 V AC	480 V AC	Rectified brake voltage	171 V DC	180 V DC	198 V DC	216 V DC	Recommended brake coil voltage for Siemens motors	170 ... 200 V DC	170 ... 200 V DC 184 ... 218 V DC	184 ... 218 V DC	184 ... 218 V DC
Line voltage	380 V AC	400 V AC	440 V AC	480 V AC												
Rectified brake voltage	171 V DC	180 V DC	198 V DC	216 V DC												
Recommended brake coil voltage for Siemens motors	170 ... 200 V DC	170 ... 200 V DC 184 ... 218 V DC	184 ... 218 V DC	184 ... 218 V DC												
Protective functions	<ul style="list-style-type: none"> • Undervoltage • Overvoltage • Ground fault • Short-circuit • Stall protection • Thermal motor protection (I^2t or sensor) • Converter overtemperature • Motor blocking protection • Phase failure detection 															
Connectable motors	<ul style="list-style-type: none"> • Low-voltage induction motors • Motor cable lengths: max. 15 m (shielded) 															
Mechanical data																
Degree of protection	IP65															
Operating temperature	0 ... +55 °C (32 ... +131 °F)															
Mounting position	Vertical wall mounting (vertical alignment of the cooling fins)															
Dimensions (W x H x D)	155 mm x 246 mm x 248 mm															
Weight, approx.	4 kg															
Standards																
Certificates of suitability	UL508C, cUL, CE, Low Voltage Directive 2014/35/EU, EMC Directive 2014/30/EU															

Ordering data	Article No.		Article No.
SIMATIC ET 200pro FC-2 frequency converter With integrated safety function STO (Safe Torque Off)	6SL3514-1KE13-5AE0	PC inverter connection kit 2 Mini USB interface cable for communication with a PC, 3 m long	6SL3255-0AA00-2CA0
Backplane bus module For mounting the frequency converter (absolutely essential for operation of the converter)	6SL3260-2TA00-0AA0	Connecting cable pre-assembled at one end Power supply cable, open at one end, for HAN Q4/2, angled, 4 × 4 mm ² • Length 1.5 m • Length 5 m	3RK1911-0DB13 3RK1911-0DB33
Accessories		Connector set for the power supply HAN Q4/2 • 2.5 mm ² • 4 mm ² • 6 mm ²	3RK1911-2BE50 3RK1911-2BE10 3RK1911-2BE30
IOP Handheld For use with SINAMICS G120, SINAMICS G120C, SINAMICS G120P, SINAMICS G110D, SINAMICS G120D, SINAMICS G110M, SINAMICS S110 and SIMATIC ET 200pro FC-2 Included in the scope of delivery: • Intelligent Operator Panel IOP • Handheld housing • Rechargeable batteries (4 × AA) • Charging unit (international) • RS232 connecting cable (3 m long, for use with SINAMICS G120, SINAMICS G120C, SINAMICS G120P and SINAMICS S110) • USB cable (1 m long)	6SL3255-0AA00-4HA0	Motor cables pre-assembled at one end For motors with brake and temperature sensor with HAN Q8 connector, shielded Cross-section • Length 1.5 m • Length 3 m • Length 5 m • Length 10 m	(HTG: supplied by Harting) (ZKT: supplied by KnorrTec) 4 × 1.5 mm ² 2 × (2 × 0.75 mm ²) HTG: 61 88 201 0288 ZKT: 70020501000150 HTG: 61 88 201 0289 ZKT: 70020501000300 HTG: 61 88 201 0290 ZKT: 70020501000500 HTG: 61 88 201 0299 ZKT: 70020501001000
RS232 interface cable With optical interface to connect the SINAMICS G110D, SINAMICS G120D, SINAMICS G110M or SIMATIC ET 200pro FC-2 converters to the IOP Handheld (2.5 m long)	3RK1922-2BP00	Connector set for motor cable HAN Q8, shielded	HTG: 61 83 401 0131 ZKT: 10032001
SINAMICS Memory Card (SD card)	6SL3054-4AG00-2AA0	Power jumper connector	3RK1922-2BQ00
STARTER commissioning tool ¹⁾ on DVD-ROM	6SL3072-0AA00-0AG0		

¹⁾ The STARTER commissioning tool is also available on the Internet at www.siemens.com/starter

I/O systems

SIMATIC ET 200 systems without control cabinet
ET 200pro

ET 200pro software > Motor Starter ES

Overview

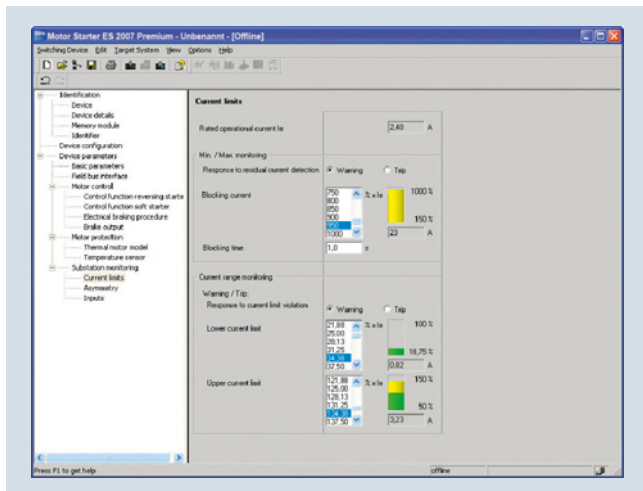

Motor Starter ES for parameterization, monitoring, diagnostics and testing of motor starters

More information

Home page see www.siemens.com/sirius

Industry Mall see <https://mall.industry.siemens.com/mall/en/de/Catalog/Products/10026777?tree=CatalogTree>

Technical specifications and system requirements, see <https://support.industry.siemens.com/cs/ww/en/ps/16713/td>

Motor Starter ES is used for the start-up, parameterization, diagnostics, documentation and preventive maintenance of SIMATIC ET 200S, ET 200pro, ECOFAST and M200D motor starters.

Interfacing is performed

- Through the local interface on the device
- With PROFIBUS DP-V1-capable motor starters from any point in PROFIBUS or in PROFINET (applies to ET 200S DP V1/ET 200pro/ECOFAST/M200D)
- With PROFINET-capable motor starters from any point in PROFINET or in PROFIBUS (applies to ET 200S DP V1/ ET 200pro/M200D)

Using Motor Starter ES, the communication-capable motor starters are easily parameterized during start-up, monitored during normal operation and successfully diagnosed for service purposes. Preventive maintenance is supported by a function for reading out diverse statistical data (e.g. operating hours, operating cycles, cut-off currents, etc.). The user is supported during these procedures with comprehensive Help functions and plain text displays.

Motor Starter ES can either be used as a stand-alone program or it can be integrated into STEP 7 via an Object Manager.

Efficient engineering with three program versions

The Motor Starter ES software program is available in three versions which differ in their user-friendliness, scope of functions and price.

Motor Starter ES	Basic	Standard	Premium
ET 200S High Feature PROFIBUS IM	✓	✓	✓
ET 200S High Feature PROFINET IM	✓	✓	✓
ECOFAST AS-Interface High Feature	✓	✓	--
ECOFAST PROFIBUS	✓	✓	✓
ET 200pro PROFIBUS IM	✓	✓	✓
ET 200pro PROFINET IM	✓	✓	✓
M200D AS-Interface Standard	✓	✓	(✓)
M200D PROFIBUS	✓	✓	✓
M200D PROFINET	✓	✓	✓

✓ Function available, (✓) Available with restricted functionality

-- Function not available

Motor Starter ES	Basic	Standard	Premium
Access through the local interface on the device	✓	✓	✓
Parameter assignment	✓	✓	✓
Operating	✓	✓	✓
Diagnostics	--	✓	✓
Creation of typicals	--	✓	✓
Comparison functions	--	✓	✓
Standard-compliant printout according to EN ISO 7200	--	✓	✓
Service data (maximum pointers, statistical data)	--	✓	✓
Access through PROFIBUS	--	--	✓
Access through PROFINET	--	--	✓
S7 routing	--	--	✓
Teleservice through MPI	--	--	✓
STEP 7 Object Manager	--	--	✓
Trace function	--	✓	✓

✓ Function available

-- Function not available

Additional functions

Standard-compliant printouts

The software tool greatly simplifies machine documentation. It enables parameterization printouts according to EN ISO 7200. The elements to be printed are easy to select and group as required.

Easy creation of typicals

Typicals can be created for devices and applications with only minimum differences in their parameters. These typicals contain all the parameters which are needed for parameterization. In addition it is possible to specify which of these parameters are fixed and which can be adapted, e.g. by the startup engineer.

Teleservice through MPI

The Motor Starter ES Premium version supports the use of MPI Teleservice (comprising the Teleservice software and various Teleservice adapters) for remote diagnostics of the devices. This facilitates diagnostics and maintenance, as well as shortening response times for service purposes.



Benefits

- Fast, error-free configuration and startup of motor starters even without extensive previous knowledge
- Transparent setting of the device functions and their parameters – online and offline
- Effective diagnostics functions on the soft starter and display of the most important measured values
- Trace function (oscilloscope function) for recording measured values and events (included in the Motor Starter ES Standard and Premium software version for M200D PROFIBUS and PROFINET).

Selection and ordering data**Parameterization, start-up and diagnostics software
Motor Starter ES 2007**

For ECOFAST Motor Starter, SIMATIC ET 200S High Feature Starter, SIMATIC ET 200pro Starter and M200D (AS-Interface Standard, PROFIBUS, PROFINET)

- Delivered without PC cable

Version	Article No.
Motor Starter ES 2007 Basic	
 <p>Floating license for one user Engineering software in limited-function version for diagnostics purposes, software and documentation on CD, 3 languages (English/German/French), communication via system interface</p> <ul style="list-style-type: none"> • License key on USB flash drive, Class A, including CD • License key download, Class A, without CD 	<p>3ZS1310-4CC10-0YA5 3ZS1310-4CE10-0YB5</p>
Motor Starter ES 2007 Standard	
 <p>Floating license for one user Engineering software, software and documentation on CD, 3 languages (English/German/French), communication via system interface</p> <ul style="list-style-type: none"> • License key on USB flash drive, Class A, including CD • License key download, Class A, without CD <p>Powerpack for Motor Starter ES 2007 Basic Floating license for one user, engineering software, license key on USB flash drive, Class A 3 languages (English/German/French), communication via system interface</p>	<p>3ZS1310-5CC10-0YA5 3ZS1310-5CE10-0YB5 3ZS1310-5CC10-0YD5</p>
<p>Software Update Service For 1 year with automatic extension, requires the current software version, engineering software, software and documentation on CD, communication via system interface</p>	<p>3ZS1310-5CC10-0YL5</p>

Notes:

Please order PC cable separately; [see page 9/282](#).

For a description of the software versions, [see page 9/280](#).

I/O systemsSIMATIC ET 200 systems without control cabinet
ET 200pro

ET 200pro software > Motor Starter ES

Version	Article No.
Motor Starter ES 2007 Premium	
 <p>Floating license for one user Engineering software, Software and documentation on CD, 3 languages (English/German/French), communication via system interface or PROFIBUS/PROFINET, STEP7 Object Manager</p> <ul style="list-style-type: none"> • License key on USB flash drive, Class A, including CD • License key download, Class A, without CD 	<p>3ZS1310-6CC10-0YA5 3ZS1310-6CE10-0YB5</p>
<p>Powerpack for Motor Starter ES 2007 Standard</p> <p>Floating license for one user, engineering software, license key on USB flash drive, Class A 3 languages (English/German/French), communication via system interface or PROFIBUS/PROFINET, STEP7 Object Manager</p>	<p>3ZS1310-6CC10-0YD5</p>
<p>Software Update Service</p> <p>For 1 year with automatic extension, requires the current software version, engineering software, Software and documentation on CD, communication via system interface or PROFIBUS/PROFINET, STEP7 Object Manager</p>	<p>3ZS1310-6CC10-0YL5</p>

3ZS1310-6CC10-0YA5

Notes:Please order PC cable separately; see [Accessories](#).For a description of the software versions, see [page 9/280](#).**Accessories**

Version	Article No.
Optional accessories	
<p>RS 232 interface cable</p> <p>Serial data connection between ET 200pro MS/FC, M200D and laptop/PC/PG or MS</p>	<p>3RK1922-2BP00</p>
<p>USB interface cable</p> <p>Serial data connection between ET 200pro MS/FC, M200D and laptop/PC/PG or MS</p>	<p>6SL3555-0PA00-2AA0</p>
<p>USB/serial adapter</p> <p>For connecting an RS 232 PC cable to the USB interface of a PC, recommended for use in conjunction with ET 200S/ECOFAS/ET 200pro motor starters</p>	<p>3UF7946-0AA00-0</p>

Overview

An interface module (EtherNet/IP adapter) is provided for operating the ET 200pro on EtherNet/IP. It can be used together with system and IO components of the ET 200pro distributed I/O system.

Technical specifications

Article number	ZNX:EIP200PRO ETHERNET/IP HEAD ASSEMBLY FOR ET 200PRO
Supply voltage	
Rated value (DC)	24 V
Input current	
from supply voltage 1L+, max.	400 mA
Power loss	
Power loss, typ.	6 W
Address area	
Addressing volume	
• Inputs	255 byte
• Outputs	255 byte
Interfaces	
PROFINET IO	
• automatic detection of transmission rate	Yes
• Transmission rate, max.	100 Mbit/s
• Services	See manual
Diagnostics indication LED	
• Bus fault BF (red)	Yes
• Group error SF (red)	Yes
• Monitoring 24 V voltage supply ON (green)	Yes
• Load voltage monitoring 24 V DC (green)	Yes
Potential separation	
between backplane bus and electronics	Yes
between supply voltage and electronics	Yes
Isolation	
Isolation tested with	707 V DC (type test)

Article number	ZNX:EIP200PRO ETHERNET/IP HEAD ASSEMBLY FOR ET 200PRO
Degree and class of protection	
Degree of protection acc. to EN 60529	
• IP65	Yes
• IP66	Yes
• IP67	Yes
Ambient conditions	
Ambient temperature during operation	
• min.	-25 °C
• max.	55 °C
Ambient temperature during storage/transportation	
• min.	-40 °C
• max.	70 °C
Dimensions	
Width	135 mm
Height	130 mm
Depth	59.3 mm
Weights	
Weight, approx.	490 g
Article number	ZNX:EIP200PROCM1 ET 200PRO, CM IM DP M12 / 7/8"
Input current	
from supply voltage 1L+, max.	No current input, only infeed current, max. 8 A
from load voltage 2L+ (without load), max.	No current input, only infeed current, max. 8 A
Weights	
Weight, approx.	540 g

Ordering data**Article No.**

SIMATIC ET 200pro interface module for EtherNet/IP	ZNX:EIP200PRO
Including: <ul style="list-style-type: none"> • Bus termination module for ET 200pro • Companion disk with the manuals and the configuration tool 	
Connecting module for EtherNet/IP	ZNX:EIP200PROCM1
For connecting the interface module to EtherNet/IP	

I/O systems

SIMATIC ET 200 systems without control cabinet

SIMATIC ET 200AL

Overview

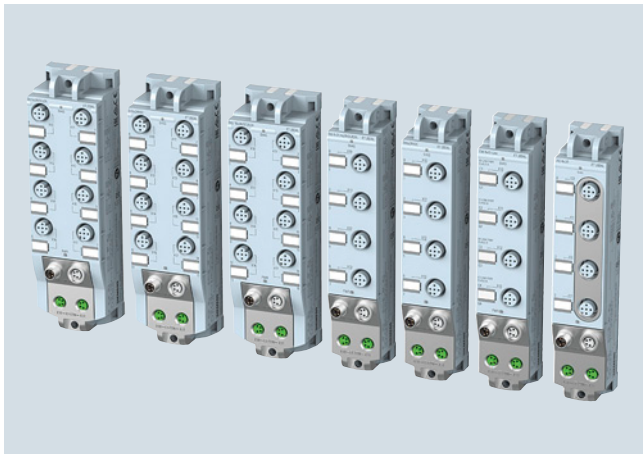

- Modular, distributed I/O system with compact I/O modules in IP65/67
- Especially easy and flexible installation, even in extremely confined spaces
- Easy wiring
- Easy commissioning
- SIMATIC ET 200AL consists of the following components:
 - Interface module for communication with IO controllers on PROFINET
 - Interface module for communication with all masters on the PROFIBUS
 - BusAdapters for connection to the ET 200SP I/O system
 - Various I/O modules, 30 mm and 45 mm-wide
- Maximum configuration of an ET 200AL station:
 - Up to 32 I/O modules with PROFINET or PROFIBUS in any combination
 - Up to 16 I/O modules at the ET 200SP in any combination
- Connection of the modules via an internal backplane bus established using bus cables (ET connection)

Highlights

- Compact dimensions
- Low weight
- Safety-oriented collective shutdown of the outputs (available soon)
- High degree of user-friendliness due to the following design features:
 - Flexible mounting in all positions possible due to screw fastening through the front or side
 - Direct installation on even surfaces or aluminum DIN rails
 - Labels for the identification of channels, modules and slots
 - Integrated cable tie opening
 - Clear and CAx-compliant interface designations
 - Uniform coloring of the system interfaces and system cables
 - 1:1 assignment of channel status LED, I/O socket and label
 - Pin assignment on the side
- I/O module portfolio comprising digital and analog modules as well as IO-Link communication module
- Ambient temperature range from -25 °C to +55 °C
- Extensive system functions
 - All interface and I/O modules support firmware update
 - Configuration control (option handling) via user software
 - System supports PROFIenergy for power saving purposes
 - Consistent use of identification and maintenance data IM0 to IM3/4 (electronic rating plate) for fast electronic and unambiguous identification of individual modules (Article No., serial number, etc.)

Overview



- Interface module for linking the ET 200AL to PROFIBUS
- As DP-V1 slave it handles the data exchange with the PROFIBUS master in the PLC
- Max. 32 I/O modules can be connected
- Max. data volume of 244 bytes, for input and output data respectively
- Automatic detection of baud rate 9.6 kBd ... 12 MBd
- PROFIBUS addresses 1 ... 99; can be set by means of rotary switch
- Identification and maintenance data IM0 ... IM3
- Firmware update
- Configuration management (option handling)

Technical specifications

Article number	6ES7157-1AA00-0AB0 ET 200AL, IM 157-1 DP
General information	
Product type designation	IM 157-1 DP
HW functional status	E01
Firmware version	V1.0.x
Vendor identification (VendorID)	81A9H
Product function	
• I&M data	Yes; I&M0 to I&M3
Engineering with	
• STEP 7 TIA Portal configurable/integrated as of version	STEP 7 V13 SP1 or higher
• STEP 7 configurable/integrated as of version	From V5.5 SP4 Hotfix 3
• PROFIBUS as of GSD version/GSD revision	GSD as of Revision 5
Supply voltage	
Load voltage 1L+	
• Rated value (DC)	24 V
• Reverse polarity protection	Yes; against destruction
Input current	
Current consumption (rated value)	50 mA
from load voltage 1L+ (unswitched voltage)	4 A; Maximum value
from load voltage 2L+, max.	4 A; Maximum value
Power loss	
Power loss, typ.	1.7 W
Address area	
Address space per station	
• Address space per station, max.	244 byte
Interfaces	
Number of PROFIBUS interfaces	1

Article number	6ES7157-1AA00-0AB0 ET 200AL, IM 157-1 DP
1. Interface	
Interface type	PROFIBUS DP
Interface types	
• RS 485	Yes
• M12 port	Yes; 2x M12 b-coded
Functionality	
• PROFIBUS DP slave	Yes
Interface types	
RS 485	
• Transmission rate, max.	12 Mbit/s
PROFIBUS	
Services	
- SYNC capability	Yes
- FREEZE capability	Yes
- Direct data exchange (slave-to-slave communication)	Yes
- DPV0	Yes
- DPV1	Yes
Interrupts/diagnostics/status information	
Alarms	Yes
Diagnostic functions	Yes
Diagnostics indication LED	
• RUN LED	Yes; Green LED
• ERROR LED	Yes; Red LED
• MAINT LED	Yes; yellow LED
• Connection display DP	Yes; Green LED
Potential separation	
between the load voltages	Yes
between PROFIBUS DP and all other circuit components	Yes
Isolation	
Isolation tested with	707 V DC (type test)

I/O systemsSIMATIC ET 200 systems without control cabinet
SIMATIC ET 200AL**Interface modules > IM 157-1 DP****Technical specifications** (continued)

Article number	6ES7157-1AA00-0AB0 ET 200AL, IM 157-1 DP
Degree and class of protection	
Degree of protection acc. to EN 60529	
• IP65	Yes
• IP67	Yes
Ambient conditions	
Ambient temperature during operation	
• min.	-25 °C
• max.	55 °C

Article number	6ES7157-1AA00-0AB0 ET 200AL, IM 157-1 DP
Connection method	
Power supply	M8, 4-pole
ET-Connection	
• ET-Connection	M8, 4-pin, shielded
Dimensions	
Width	45 mm
Height	159 mm
Depth	46 mm
Weights	
Weight, approx.	211 g

Ordering data

Ordering data	Article No.	Ordering data	Article No.
IM 157-1 DP interface module	6ES7157-1AA00-0AB0	M8 power cable	
For connecting ET 200AL to PROFIBUS		4-pin	
Accessories		Pre-assembled at both ends, M8 connector and M8 socket	
Bus cable for backplane bus (ET connection)		0.19 m	6ES7194-2LH02-1AA0
4-pin, shielded		0.3 m	6ES7194-2LH03-1AA0
Pre-assembled at both ends, 2 M8 connectors		1 m	6ES7194-2LH10-1AA0
0.19 m	6ES7194-2LH02-0AA0	2 m	6ES7194-2LH20-1AA0
0.3 m	6ES7194-2LH03-0AA0	5 m	6ES7194-2LH50-1AA0
1 m	6ES7194-2LH10-0AA0	10 m	6ES7194-2LN10-1AA0
2 m	6ES7194-2LH20-0AA0	15 m	6ES7194-2LN15-1AA0
5 m	6ES7194-2LH50-0AA0	Pre-assembled at both ends, angled M8 connector and angled M8 socket	
10 m	6ES7194-2LN10-0AA0	0.3 m	6ES7194-2LH03-1AB0
15 m	6ES7194-2LN15-0AA0	1 m	6ES7194-2LH10-1AB0
Pre-assembled at both ends, 2 M8 connectors, angled		2 m	6ES7194-2LH20-1AB0
0.3 m	6ES7194-2LH03-0AB0	5 m	6ES7194-2LH50-1AB0
1 m	6ES7194-2LH10-0AB0	10 m	6ES7194-2LN10-1AB0
2 m	6ES7194-2LH20-0AB0	15 m	6ES7194-2LN15-1AB0
5 m	6ES7194-2LH50-0AB0	Pre-assembled at one end, M8 socket	
10 m	6ES7194-2LN10-0AB0	2 m	6ES7194-2LH20-1AC0
15 m	6ES7194-2LN15-0AB0	5 m	6ES7194-2LH50-1AC0
Pre-assembled at one end, 1 M8 connector		10 m	6ES7194-2LN10-1AC0
2 m	6ES7194-2LH20-0AC0	15 m	6ES7194-2LN15-1AC0
5 m	6ES7194-2LH50-0AC0	M8 connector for ET connection	6ES7194-2AB00-0AA0
10 m	6ES7194-2LN10-0AC0	4-pin, shielded	
15 m	6ES7194-2LN15-0AC0	M8 power connector	
		Male contact insert, 4-pin	6ES7194-2AA00-0AA0
		Female contact insert, 4-pin	6ES7194-2AC00-0AA0
		ET connection FastConnect stripping tool	6ES7194-2KA00-0AA0
		Stripping tool for stripping the ET connection bus cable	
		Labels	6ES7194-2BA00-0AA0
		10 x 5 mm, RAL 9016; 5 frames with 40 labels each	

Overview



- Interface module for linking the ET 200AL to PROFINET
- Handles data exchange with the PROFINET IO controller in the PLC
- Max. 32 I/O modules can be connected
- Max. data volume of 1430 bytes, for input and output data respectively
- Shortest bus cycle 250 µs
- Automatic power-up by means of topology recognition
- Autocrossover
- Shared device on up to 4 IO controllers
- Support for the MRP (media redundancy protocol) and MRPD (media redundancy with planned duplication) functions
- Identification and maintenance data IM0 ... IM4
- Firmware update
- Configuration management (option handling)
- PROFIenergy

Technical specifications

Article number	6ES7157-1AB00-0AB0 ET 200AL, IM 157-1 PN
General information	
Product type designation	IM 157-1 PN
HW functional status	E01
Firmware version	V1.0.x
Vendor identification (VendorID)	002AH
Product function	
• I&M data	Yes; I&M0 to I&M4
Engineering with	
• STEP 7 TIA Portal configurable/integrated as of version	STEP 7 V13 SP1 or higher
• STEP 7 configurable/integrated as of version	From V5.5 SP4 Hotfix 3
• PROFINET as of GSD version/GSD revision	GSDML V2.3.1
Supply voltage	
Load voltage 1L+	
• Rated value (DC)	24 V
• Reverse polarity protection	Yes; against destruction
Input current	
Current consumption (rated value)	100 mA
from load voltage 1L+ (unswitched voltage)	4 A; Maximum value
from load voltage 2L+, max.	4 A; Maximum value
Power loss	
Power loss, typ.	2.9 W
Address area	
Address space per station	
• Address space per station, max.	1 430 byte
Interfaces	
Number of PROFINET interfaces	1

Article number	6ES7157-1AB00-0AB0 ET 200AL, IM 157-1 PN
1. Interface	
Interface type	PROFINET
Interface types	
• integrated switch	Yes
• M12 port	Yes; 2x M12 d-coded
Functionality	
• PROFINET IO Device	Yes
M12 port	
• Transmission procedure	PROFINET with 100 Mbit/s full duplex (100BASE-TX)
• 10 Mbps	Yes; for Ethernet services
• 100 Mbps	Yes; PROFINET with 100 Mbit/s full duplex (100BASE-TX)
• Autonegotiation	Yes
• Autocrossing	Yes
Protocols	
PROFINET IO Device	
Services	
- Open IE communication	Yes
- IRT	Yes; 250 µs, 500 µs, 1 ms, 2 ms, 4 ms, 8 ms, 16 ms, 32 ms, 64 ms, 128 ms
- MRP	Yes
- MRPD	No
- PROFIenergy	Yes
- Shared device	Yes
- Number of IO Controllers with shared device, max.	4
Open IE communication	
• TCP/IP	Yes
• SNMP	Yes
• LLDP	Yes
Interrupts/diagnostics/status information	
Alarms	Yes
Diagnostic functions	Yes

I/O systemsSIMATIC ET 200 systems without control cabinet
SIMATIC ET 200AL**Interface modules > IM 157-1 PN****Technical specifications** (continued)

Article number	6ES7157-1AB00-0AB0 ET 200AL, IM 157-1 PN
Diagnostics indication LED	
• RUN LED	Yes; Green LED
• ERROR LED	Yes; Red LED
• MAINT LED	Yes; yellow LED
• Connection display LINK TX/RX	Yes; 2x green LED
Potential separation	
between the load voltages	Yes
between PROFINET and all other circuits	Yes
Isolation	
Isolation tested with	707 V DC (type test)
Degree and class of protection	
Degree of protection acc. to EN 60529	
• IP65	Yes
• IP67	Yes

Article number	6ES7157-1AB00-0AB0 ET 200AL, IM 157-1 PN
Ambient conditions	
Ambient temperature during operation	
• min.	-25 °C
• max.	55 °C
Connection method	
Power supply	M8, 4-pole
ET-Connection	
• ET-Connection	M8, 4-pin, shielded
Dimensions	
Width	45 mm
Height	159 mm
Depth	40 mm
Weights	
Weight, approx.	263 g

Ordering data**Article No.**

IM 157-1 PN interface module	6ES7157-1AB00-0AB0
For connecting ET 200AL to PROFINET	
Accessories	
Bus cable for backplane bus (ET connection)	
4-pin, shielded	
Pre-assembled at both ends, 2 M8 connectors	
0.19 m	6ES7194-2LH02-0AA0
0.3 m	6ES7194-2LH03-0AA0
1 m	6ES7194-2LH10-0AA0
2 m	6ES7194-2LH20-0AA0
5 m	6ES7194-2LH50-0AA0
10 m	6ES7194-2LN10-0AA0
15 m	6ES7194-2LN15-0AA0
Pre-assembled at both ends, 2 M8 connectors, angled	
0.3 m	6ES7194-2LH03-0AB0
1 m	6ES7194-2LH10-0AB0
2 m	6ES7194-2LH20-0AB0
5 m	6ES7194-2LH50-0AB0
10 m	6ES7194-2LN10-0AB0
15 m	6ES7194-2LN15-0AB0
Pre-assembled at one end, 1 M8 connector	
2 m	6ES7194-2LH20-0AC0
5 m	6ES7194-2LH50-0AC0
10 m	6ES7194-2LN10-0AC0
15 m	6ES7194-2LN15-0AC0

Article No.

M8 power cable	
4-pin	
Pre-assembled at both ends, M8 connector and M8 socket	
0.19 m	6ES7194-2LH02-1AA0
0.3 m	6ES7194-2LH03-1AA0
1 m	6ES7194-2LH10-1AA0
2 m	6ES7194-2LH20-1AA0
5 m	6ES7194-2LH50-1AA0
10 m	6ES7194-2LN10-1AA0
15 m	6ES7194-2LN15-1AA0
Pre-assembled at both ends, angled M8 connector and angled M8 socket	
0.3 m	6ES7194-2LH03-1AB0
1 m	6ES7194-2LH10-1AB0
2 m	6ES7194-2LH20-1AB0
5 m	6ES7194-2LH50-1AB0
10 m	6ES7194-2LN10-1AB0
15 m	6ES7194-2LN15-1AB0
Pre-assembled at one end, M8 socket	
2 m	6ES7194-2LH20-1AC0
5 m	6ES7194-2LH50-1AC0
10 m	6ES7194-2LN10-1AC0
15 m	6ES7194-2LN15-1AC0
M8 connector for ET connection	6ES7194-2AB00-0AA0
4-pin, shielded	
M8 power connector	
Male contact insert, 4-pin	6ES7194-2AA00-0AA0
Female contact insert, 4-pin	6ES7194-2AC00-0AA0
ET connection FastConnect stripping tool	6ES7194-2KA00-0AA0
Stripping tool for stripping the ET connection bus cable	
Labels	6ES7194-2BA00-0AA0
10 x 5 mm, RAL 9016; 5 frames with 40 labels each	

Overview

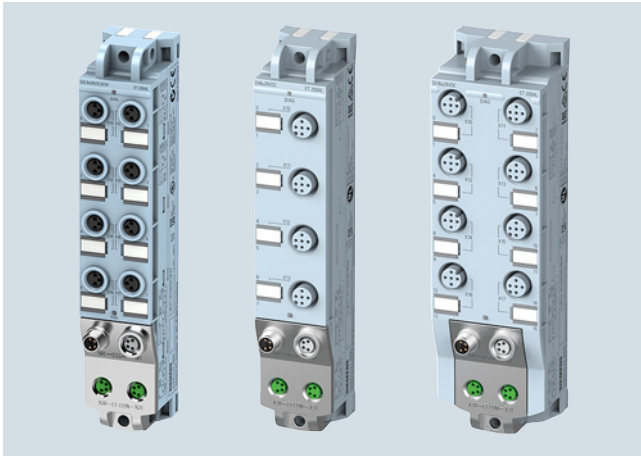

- 30 and 45 mm-wide modules with parameters and diagnostic functions
- 8-channel digital input module with M8 or M12 connection
- 16-channel digital input module with M12 connection
- 8-channel digital input/output module with M8 or M12 connection
- 16-channel digital input/output module with M12 connection
- 8-channel digital output module 2 A with M12 connection

Technical specifications

Article number	6ES7141-5BF00-0BA0 ET 200AL, DI 8X24VDC, 8XM8	6ES7141-5AF00-0BA0 ET 200AL, DI 8X24VDC, 4XM12	6ES7141-5AH00-0BA0 ET 200AL, DI 16X24VDC, 8XM12
General information			
Product type designation	DI 8x24VDC, 8xM8	DI 8x24VDC, 4XM12	DI 16x24VDC, 8XM12
HW functional status	E01	E01	E01
Firmware version	V1.0.x	V1.0.x	V1.0.x
Product function			
• I&M data	Yes; I&M0 to I&M3	Yes; I&M0 to I&M3	Yes; I&M0 to I&M3
Engineering with			
• STEP 7 TIA Portal configurable/ integrated as of version	STEP 7 V13 SP1 or higher	STEP 7 V13 SP1 or higher	STEP 7 V13 SP1 or higher
• STEP 7 configurable/integrated as of version	From V5.5 SP4 Hotfix 3	V5.5 SP4 Hotfix 7 or higher	V5.5 SP4 Hotfix 7 or higher
• PROFIBUS as of GSD version/ GSD revision	GSD as of Revision 5	GSD as of Revision 5	GSD as of Revision 5
• PROFINET as of GSD version/ GSD revision	GSDML V2.3.1	GSDML V2.3.1	GSDML V2.3.1
Supply voltage			
Load voltage 1L+			
• Rated value (DC)	24 V	24 V	24 V
• Reverse polarity protection	Yes; Against destruction; encoder power supply outputs applied with reversed polarity	Yes; Against destruction; encoder power supply outputs applied with reversed polarity	Yes; Against destruction; encoder power supply outputs applied with reversed polarity
Input current			
Current consumption (rated value) from load voltage 1L+ (unswitched voltage)	25 mA; without load 4 A; Maximum value	25 mA; without load 4 A; Maximum value	30 mA; without load 4 A; Maximum value
from load voltage 2L+, max.	4 A; Maximum value	4 A; Maximum value	4 A; Maximum value
Encoder supply			
Number of outputs	8	4	8
24 V encoder supply			
• Short-circuit protection	Yes; per module, electronic	Yes; per module, electronic	Yes; per module, electronic
• Output current, max.	0.7 A; Total current of all encoders	0.7 A; Total current of all encoders	1.4 A; Total current of all encoders
Power loss			
Power loss, typ.	1.9 W	1.9 W	2.7 W
Digital inputs			
Number of digital inputs	8	8	16
Input characteristic curve in accordance with IEC 61131, type 3	Yes	Yes	Yes

I/O systemsSIMATIC ET 200 systems without control cabinet
SIMATIC ET 200AL**I/O modules > Digital I/O modules****Technical specifications (continued)**

Article number	6ES7141-5BF00-0BA0 ET 200AL, DI 8X24VDC, 8XM8	6ES7141-5AF00-0BA0 ET 200AL, DI 8X24VDC, 4XM12	6ES7141-5AH00-0BA0 ET 200AL, DI 16X24VDC, 8XM12
Number of simultaneously controllable inputs			
all mounting positions			
- up to 55 °C, max.	8	8	16
Input voltage			
• Type of input voltage	DC	DC	DC
• Rated value (DC)	24 V	24 V	24 V
• for signal "0"	-30 to +5V	-30 to +5V	-30 to +5V
• for signal "1"	+11 to +30V	+11 to +30V	+11 to +30V
Input current			
• for signal "1", typ.	3.2 mA	3.2 mA	3.2 mA
Input delay (for rated value of input voltage) for standard inputs			
- at "0" to "1", min.	1.2 ms	1.2 ms	1.2 ms
- at "0" to "1", max.	4.8 ms	4.8 ms	4.8 ms
- at "1" to "0", min.	1.2 ms	1.2 ms	1.2 ms
- at "1" to "0", max.	4.8 ms	4.8 ms	4.8 ms
Cable length			
• unshielded, max.	30 m	30 m	30 m
Encoder			
Connectable encoders			
• 2-wire sensor	Yes	Yes	Yes
- permissible quiescent current (2-wire sensor), max.	1.5 mA	1.5 mA	1.5 mA
Interrupts/diagnostics/status information			
Alarms			
• Diagnostic alarm	Yes; Parameterizable	Yes; Parameterizable	Yes; Parameterizable
Diagnostic messages			
• Short-circuit	Yes; Sensor supply to M; module by module	Yes; Sensor supply to M; module by module	Yes; Sensor supply to M; module by module
Diagnostics indication LED			
• Channel status display	Yes; Green LED	Yes; Green LED	Yes; Green LED
• for module diagnostics	Yes; Green/red LED	Yes; Green/red LED	Yes; Green/red LED
Potential separation			
between the load voltages	Yes	Yes	Yes
Potential separation channels			
• between the channels	No	No	No
• between the channels and backplane bus	Yes	Yes	Yes
• between the channels and the power supply of the electronics	No	No	No
Isolation			
Isolation tested with	707 V DC (type test)	707 V DC (type test)	707 V DC (type test)
Degree and class of protection			
Degree of protection acc. to EN 60529			
• IP65	Yes	Yes	Yes
• IP67	Yes	Yes	Yes
Ambient conditions			
Ambient temperature during operation			
• min.	-25 °C	-25 °C	-25 °C
• max.	55 °C	55 °C	55 °C
Connection method			
Design of electrical connection for the inputs and outputs	M8, 3-pole	M12, 5-pole	M12, 5-pole
Power supply	M8, 4-pole	M8, 4-pole	M8, 4-pole
ET-Connection			
• ET-Connection	M8, 4-pin, shielded	M8, 4-pin, shielded	M8, 4-pin, shielded

Technical specifications (continued)

Article number	6ES7141-5BF00-0BA0 ET 200AL, DI 8X24VDC, 8XM8	6ES7141-5AF00-0BA0 ET 200AL, DI 8X24VDC, 4XM12	6ES7141-5AH00-0BA0 ET 200AL, DI 16X24VDC, 8XM12
Dimensions			
Width	30 mm	30 mm	45 mm
Height	159 mm	159 mm	159 mm
Depth	40 mm	40 mm	40 mm
Weights			
Weight, approx.	145 g	145 g	184 g

Article number	6ES7142-5AF00-0BA0 ET 200AL, DQ 8X24VDC/2A, 8XM12
General information	
Product type designation	DQ 8X24VDC/2A, 8XM12
HW functional status	E01
Firmware version	V1.0.x
Product function	
• I&M data	Yes; I&M0 to I&M3
Engineering with	
• STEP 7 TIA Portal configurable/integrated as of version	STEP 7 V13 SP1 or higher
• STEP 7 configurable/integrated as of version	V5.5 SP4 Hotfix 7 or higher
• PROFIBUS as of GSD version/GSD revision	GSD as of Revision 5
• PROFINET as of GSD version/GSD revision	GSDML V2.3.1
Supply voltage	
Load voltage 1L+	
• Rated value (DC)	24 V
• Reverse polarity protection	Yes; against destruction; load increasing
Load voltage 2L+	
• Rated value (DC)	24 V
• Reverse polarity protection	Yes; against destruction; load increasing
Input current	
Current consumption (rated value)	40 mA; without load
from load voltage 1L+ (unswitched voltage)	4 A; Maximum value
from load voltage 2L+, max.	4 A; Maximum value
Power loss	
Power loss, typ.	4 W
Digital outputs	
Number of digital outputs	8
• in groups of	4; 2 load groups for 4 outputs each
Short-circuit protection	Yes; per channel, electronic
• Response threshold, typ.	2.8 A
Limitation of inductive shutdown voltage to	2L+ (-47 V)
Switching capacity of the outputs	
• on lamp load, max.	10 W

Article number	6ES7142-5AF00-0BA0 ET 200AL, DQ 8X24VDC/2A, 8XM12
Load resistance range	
• lower limit	12 Ω
• upper limit	4 kΩ
Output voltage	
• for signal "1", min.	L+ (-0.8 V)
Output current	
• for signal "1" rated value	2 A
• for signal "1" permissible range, max.	2 A; with inductive load to IEC 60947-5-1, DC-13 / AC-15
• for signal "0" residual current, max.	0.5 mA
Switching frequency	
• with resistive load, max.	100 Hz
• with inductive load, max.	0.1 Hz; 0.25 Hz at 25 °C
• on lamp load, max.	1 Hz
Total current of the outputs	
• Current per group, max.	4 A; For inductive load max. 2 channels per group
Cable length	
• unshielded, max.	30 m
Interrupts/diagnostics/status information	
Substitute values connectable	Yes; channel by channel, parameterizable
Alarms	
• Diagnostic alarm	Yes; Parameterizable
Diagnostic messages	
• Short-circuit	Yes; Outputs to ground; module by module
Diagnostics indication LED	
• Channel status display	Yes; Green LED
• for module diagnostics	Yes; Green/red LED
• For load voltage monitoring	Yes; Green LED
Potential separation	
between the load voltages	Yes
Potential separation channels	
• between the channels, in groups of	4
• between the channels and backplane bus	Yes
• between the channels and the power supply of the electronics	No; 4 channels are non-isolated and 4 channels are isolated from supply voltage 1L+
Isolation	
Isolation tested with	707 V DC (type test)
Degree and class of protection	
Degree of protection acc. to EN 60529	
• IP65	Yes
• IP67	Yes

I/O systems

SIMATIC ET 200 systems without control cabinet
SIMATIC ET 200AL

I/O modules > Digital I/O modules**Technical specifications (continued)**

Article number	6ES7142-5AF00-0BA0		Article number	6ES7142-5AF00-0BA0	
	ET 200AL, DQ 8X24VDC/2A, 8XM12			ET 200AL, DQ 8X24VDC/2A, 8XM12	
Ambient conditions			Dimensions		
Ambient temperature during operation			Width	45 mm	
• min.	-25 °C		Height	159 mm	
• max.	55 °C		Depth	40 mm	
Connection method			Weights		
Design of electrical connection for the inputs and outputs	M12, 5-pole		Weight, approx.	192 g	
Power supply	M8, 4-pole				
ET-Connection					
• ET-Connection	M8, 4-pin, shielded				

Article number	6ES7143-5BF00-0BA0	6ES7143-5AF00-0BA0	6ES7143-5AH00-0BA0
	ET 200AL, DIQ 4+DQ 4X24VDC/0.5A, 8XM8	ET 200AL, DIQ 4+DQ 4X24VDC/0.5A, 4XM12	ET 200AL, DIQ 16x24VDC/0.5A, 8XM12
General information			
Product type designation	DIQ 4+DQ 4X24VDC/0.5A, 8xM8	DIQ 4+DQ 4X24VDC/0.5 A, 4XM12	DIQ 16X24VDC/0.5A, 8XM12
HW functional status	E01	E01	E01
Firmware version	V1.0.x	V1.0.x	V1.0.x
Product function			
• I&M data	Yes; I&M0 to I&M3	Yes; I&M0 to I&M3	Yes; I&M0 to I&M3
Engineering with			
• STEP 7 TIA Portal configurable/integrated as of version	STEP 7 V13 SP1 or higher	STEP 7 V13 SP1 or higher	STEP 7 V14 or higher
• STEP 7 configurable/integrated as of version	From V5.5 SP4 Hotfix 3	V5.5 SP4 Hotfix 7 or higher	V5.5 SP4 Hotfix 7 or higher
• PROFIBUS as of GSD version/GSD revision	GSD as of Revision 5	GSD as of Revision 5	GSD as of Revision 5
• PROFINET as of GSD version/GSD revision	GSDML V2.3.1	GSDML V2.3.1	GSDML V2.3.1
Operating mode			
• DI			Yes
• Counter			Yes
• DQ			Yes
Supply voltage			
Load voltage 1L+			
• Rated value (DC)	24 V	24 V	24 V
• Reverse polarity protection	Yes; Against destruction; encoder power supply outputs applied with reversed polarity, loads pick up	Yes; Against destruction; encoder power supply outputs applied with reversed polarity, loads pick up	Yes; Against destruction; encoder power supply outputs applied with reversed polarity, loads pick up
Load voltage 2L+			
• Rated value (DC)	24 V	24 V	24 V
• Reverse polarity protection	Yes; against destruction; load increasing	Yes; against destruction; load increasing	Yes; Against destruction; encoder power supply outputs applied with reversed polarity, loads pick up
Input current			
Current consumption (rated value) from load voltage 1L+ (unswitched voltage)	40 mA; without load 4 A; Maximum value	40 mA; without load 4 A; Maximum value	75 mA; without load 4 A; Maximum value
from load voltage 2L+, max.	4 A; Maximum value	4 A; Maximum value	4 A; Maximum value
Encoder supply			
Number of outputs	4	4	8
24 V encoder supply			
• Short-circuit protection	Yes; per module, electronic	Yes; per module, electronic	Yes; Per load voltage, electronic
• Output current, max.	0.7 A; Total current of all encoders	0.7 A; Total current of all encoders	1.4 A; Total current of all encoders, max. 0.7 A per load voltage

Technical specifications (continued)

Article number	6ES7143-5BF00-0BA0 ET 200AL, DIQ 4+DQ 4X24VDC/0.5A, 8XM8	6ES7143-5AF00-0BA0 ET 200AL, DIQ 4+DQ 4X24VDC/0.5A, 4XM12	6ES7143-5AH00-0BA0 ET 200AL, DIQ 16x24VDC/0.5A, 8xM12
Power loss			
Power loss, typ.	2.5 W	2.5 W	4 W
Digital inputs			
Number of digital inputs	4; Parameterizable as DIQ	4; Parameterizable as DIQ	16; Parameterizable as DIQ
Input characteristic curve in accordance with IEC 61131, type 3	Yes	Yes	Yes
Number of simultaneously controllable inputs			
all mounting positions			
- up to 55 °C, max.	4	4	16
Digital input functions, parameterizable			
• Freely usable digital input			Yes
• Counter			Yes
- Number, max.			4
- Counting frequency, max.			2 kHz
- Counting width			32 bit; Incl. sign
- Counting direction up/down			Yes
Input voltage			
• Type of input voltage	DC	DC	DC
• Rated value (DC)	24 V	24 V	24 V
• for signal "0"	-3 to +5V	-3 to +5V	-3 to +5V
• for signal "1"	+11 to +30V	+11 to +30V	+11 to +30V
Input current			
• for signal "1", typ.	3.2 mA	3.2 mA	3 mA
Input delay (for rated value of input voltage) for standard inputs			
- parameterizable			Yes
- at "0" to "1", min.	1.2 ms	1.2 ms	0.05 ms; 1.6 ms for channels 8 through 15
- at "0" to "1", max.	4.8 ms	4.8 ms	20 ms
- at "1" to "0", min.	1.2 ms	1.2 ms	0.05 ms; 1.6 ms for channels 8 through 15
- at "1" to "0", max.	4.8 ms	4.8 ms	20 ms
for counter/technological functions			
- parameterizable			Yes
Cable length			
• unshielded, max.	30 m	30 m	30 m
Digital outputs			
Number of digital outputs	8; 4 DQ fixed, 4 DIQ parameterizable	8; 4 DQ fixed, 4 DIQ parameterizable	16; Parameterizable as DIQ
• in groups of	4; 2 load groups for 4 outputs each	4; 2 load groups for 4 outputs each	8; 2 load groups for 8 outputs each
Short-circuit protection	Yes; per channel, electronic	Yes; per channel, electronic	Yes; per channel, electronic
• Response threshold, typ.	0.7 A	0.7 A	0.7 A
Limitation of inductive shutdown voltage to	2L+ (-47 V)	2L+ (-47 V)	L+ (-53 V)
Digital output functions, parameterizable			
• Switching tripped by comparison values			Yes
• Freely usable digital output			Yes
Switching capacity of the outputs			
• on lamp load, max.	5 W	5 W	5 W
Load resistance range			
• lower limit	48 Ω	48 Ω	48 Ω
• upper limit	4 kΩ	4 kΩ	4 kΩ

I/O systemsSIMATIC ET 200 systems without control cabinet
SIMATIC ET 200AL**I/O modules > Digital I/O modules****Technical specifications (continued)**

Article number	6ES7143-5BF00-0BA0 ET 200AL, DIQ 4+DQ 4X24VDC/0.5A, 8XM8	6ES7143-5AF00-0BA0 ET 200AL, DIQ 4+DQ 4X24VDC/0.5A, 4XM12	6ES7143-5AH00-0BA0 ET 200AL, DIQ 16x24VDC/0.5A, 8xM12
Output voltage			
• for signal "1", min.	L+ (-0.8 V)	L+ (-0.8 V)	L+ (-0.8 V)
Output current			
• for signal "1" rated value	0.5 A	0.5 A	0.5 A
• for signal "0" residual current, max.	0.5 mA	0.5 mA	0.5 mA
Switching frequency			
• with resistive load, max.	100 Hz	100 Hz	100 Hz
• with inductive load, max.	0.5 Hz	0.5 Hz	0.5 Hz
• on lamp load, max.	1 Hz	1 Hz	1 Hz
Total current of the outputs			
• Current per group, max.	2 A	2 A	4 A
Cable length			
• unshielded, max.	30 m	30 m	30 m
Encoder			
Connectable encoders			
• 2-wire sensor	Yes	Yes	Yes
- permissible quiescent current (2-wire sensor), max.	1.5 mA	1.5 mA	1.5 mA
Interrupts/diagnostics/ status information			
Substitute values connectable	Yes; channel by channel, parameterizable	Yes; channel by channel, parameterizable	Yes; channel by channel, parameterizable
Alarms			
• Diagnostic alarm	Yes; Parameterizable	Yes; Parameterizable	Yes; Parameterizable
Diagnostic messages			
• Short-circuit	Yes; Outputs to M; encoder supply to M; module by module	Yes; Outputs to M; encoder supply to M; module by module	Yes; Outputs to M; encoder supply to M; module by module
Diagnostics indication LED			
• Channel status display	Yes; Green LED	Yes; Green LED	Yes; Green LED
• for module diagnostics	Yes; Green/red LED	Yes; Green/red LED	Yes; Green/red LED
• For load voltage monitoring	Yes; Green LED	Yes; Green LED	Yes; Green LED
Potential separation			
between the load voltages	Yes	Yes	Yes
Potential separation channels			
• between the channels, in groups of	4; DIQ channels are isolated from DQ channels	4; DIQ channels are isolated from DQ channels	8
• between the channels and backplane bus	Yes	Yes	Yes
• between the channels and the power supply of the electronics	No; DIQ channels are non-isolated and DQ channels are isolated from supply voltage 1L+	No; DIQ channels are non-isolated and DQ channels are isolated from supply voltage 1L+	No; 8 channels are non-isolated and 8 channels are isolated from supply voltage 1L+
Isolation			
Isolation tested with	707 V DC (type test)	707 V DC (type test)	707 V DC (type test)
Degree and class of protection			
Degree of protection acc. to EN 60529			
• IP65	Yes	Yes	Yes
• IP67	Yes	Yes	Yes
Ambient conditions			
Ambient temperature during operation			
• min.	-25 °C	-25 °C	-25 °C
• max.	55 °C	55 °C	55 °C

Technical specifications (continued)

Article number	6ES7143-5BF00-0BA0 ET 200AL, DIQ 4+DQ 4X24VDC/0.5A, 8XM8	6ES7143-5AF00-0BA0 ET 200AL, DIQ 4+DQ 4X24VDC/0.5A, 4XM12	6ES7143-5AH00-0BA0 ET 200AL, DIQ 16x24VDC/0.5A, 8xM12
Connection method			
Design of electrical connection for the inputs and outputs	M8, 3-pole	M12, 5-pole	M12, 5-pole
Power supply	M8, 4-pole	M8, 4-pole	M8, 4-pole
ET-Connection			
• ET-Connection	M8, 4-pin, shielded	M8, 4-pin, shielded	M8, 4-pin, shielded
Dimensions			
Width	30 mm	30 mm	45 mm
Height	159 mm	159 mm	159 mm
Depth	40 mm	40 mm	40 mm
Weights			
Weight, approx.	145 g	145 g	195 g

Ordering data

Ordering data	Article No.	Ordering data	Article No.
Digital input modules		M8 power cable	
DI 8X24VDC, 8XM8	6ES7141-5BF00-0BA0	4-pin	
DI 8X24VDC, 4XM12	6ES7141-5AF00-0BA0	Pre-assembled at both ends, M8 connector and M8 socket	
DI 16X24VDC, 8XM12	6ES7141-5AH00-0BA0	0.19 m	6ES7194-2LH02-1AA0
Digital output modules		0.3 m	6ES7194-2LH03-1AA0
DQ 8X24VDC/2A, 8XM12	6ES7142-5AF00-0BA0	1 m	6ES7194-2LH10-1AA0
Digital input/output modules		2 m	6ES7194-2LH20-1AA0
4 DIO / 4 DO, 24 V DC, 0.5 A	6ES7143-5BF00-0BA0	5 m	6ES7194-2LH50-1AA0
DIQ 4+DQ 4X24VDC/0.5A, 4XM12	6ES7143-5AF00-0BA0	10 m	6ES7194-2LN10-1AA0
DIQ 16X24VDC/0.5A, 8XM12	6ES7143-5AH00-0BA0	15 m	6ES7194-2LN15-1AA0
Accessories		Pre-assembled at both ends, angled M8 connector and angled M8 socket	
Bus cable for backplane bus (ET connection)		0.3 m	6ES7194-2LH03-1AB0
4-pin, shielded		1 m	6ES7194-2LH10-1AB0
Pre-assembled at both ends, 2 M8 connectors		2 m	6ES7194-2LH20-1AB0
0.19 m	6ES7194-2LH02-0AA0	5 m	6ES7194-2LH50-1AB0
0.3 m	6ES7194-2LH03-0AA0	10 m	6ES7194-2LN10-1AB0
1 m	6ES7194-2LH10-0AA0	15 m	6ES7194-2LN15-1AB0
2 m	6ES7194-2LH20-0AA0	Pre-assembled at one end, M8 socket	
5 m	6ES7194-2LH50-0AA0	2 m	6ES7194-2LH20-1AC0
10 m	6ES7194-2LN10-0AA0	5 m	6ES7194-2LH50-1AC0
15 m	6ES7194-2LN15-0AA0	10 m	6ES7194-2LN10-1AC0
Pre-assembled at both ends, two M8 connectors, angled		15 m	6ES7194-2LN15-1AC0
0.3 m	6ES7194-2LH03-0AB0	M8 connector for ET connection	6ES7194-2AB00-0AA0
1 m	6ES7194-2LH10-0AB0	4-pin, shielded	
2 m	6ES7194-2LH20-0AB0	M8 power connector	
5 m	6ES7194-2LH50-0AB0	Male contact insert, 4-pin	6ES7194-2AA00-0AA0
10 m	6ES7194-2LN10-0AB0	Female contact insert, 4-pin	6ES7194-2AC00-0AA0
15 m	6ES7194-2LN15-0AB0	ET connection FastConnect stripping tool	6ES7194-2KA00-0AA0
Pre-assembled at one end, one M8 connector		Stripping tool for stripping the ET connection bus cable	
2 m	6ES7194-2LH20-0AC0	Labels	6ES7194-2BA00-0AA0
5 m	6ES7194-2LH50-0AC0	10 x 5 mm, RAL 9016;	
10 m	6ES7194-2LN10-0AC0	5 frames with 40 labels each	
15 m	6ES7194-2LN15-0AC0		

I/O systemsSIMATIC ET 200 systems without control cabinet
SIMATIC ET 200AL

I/O modules > Analog I/O modules

Overview

- 30-mm-wide module with parameters and diagnostic functions
- For connecting analog actuators and sensors without additional amplifiers
- 4-channel analog input module with M12 connection
- 4-channel analog output module with M12 connection

Technical specifications

Article number	6ES7144-5KD00-0BA0 ET 200AL, AI 4XU/I/RTD, 4XM12
General information	
Product type designation	AI 4xU/I/RTD, 4xM12
HW functional status	E02
Firmware version	V1.0.x
Product function	
• I&M data	Yes; I&M0 to I&M3
Engineering with	
• STEP 7 TIA Portal configurable/integrated as of version	STEP 7 V13 SP1 or higher
• STEP 7 configurable/integrated as of version	From V5.5 SP4 Hotfix 3
• PROFIBUS as of GSD version/GSD revision	GSD as of Revision 5
• PROFINET as of GSD version/GSD revision	GSDML V2.3.1
Supply voltage	
Load voltage 1L+	
• Rated value (DC)	24 V
• Reverse polarity protection	Yes; against destruction
Input current	
Current consumption (rated value)	35 mA; without load
from load voltage 1L+ (unswitched voltage)	4 A; Maximum value
from load voltage 2L+, max.	4 A; Maximum value
Encoder supply	
Number of outputs	4
24 V encoder supply	
• Short-circuit protection	Yes; per channel, electronic
• Output current, max.	0.5 A; per channel, total current of all channels max. 1 A
Power loss	
Power loss, typ.	1.5 W

Article number	6ES7144-5KD00-0BA0 ET 200AL, AI 4XU/I/RTD, 4XM12
Analog inputs	
Number of analog inputs	4
• For current measurement	4
• For voltage measurement	4
• For resistance/resistance thermometer measurement	4
permissible input voltage for voltage input (destruction limit), max.	30 V
permissible input current for current input (destruction limit), max.	50 mA
Cycle time (all channels), min.	8 ms
Technical unit for temperature measurement adjustable	Yes; Degrees Celsius / degrees Fahrenheit / Kelvin
Input ranges (rated values), voltages	
• 0 to +10 V	Yes
• Input resistance (0 to 10 V)	10 M Ω
• 1 V to 5 V	Yes
• Input resistance (1 V to 5 V)	10 M Ω
Input ranges (rated values), currents	
• 0 to 20 mA	Yes
• Input resistance (0 to 20 mA)	50 Ω
• 4 mA to 20 mA	Yes
• Input resistance (4 mA to 20 mA)	50 Ω
Input ranges (rated values), resistance thermometer	
• Ni 100	Yes; Standard/climate
• Input resistance (Ni 100)	10 M Ω
• Pt 100	Yes; Standard/climate
• Input resistance (Pt 100)	10 M Ω
Input ranges (rated values), resistors	
• 0 to 150 ohms	Yes
• Input resistance (0 to 150 ohms)	10 M Ω
• 0 to 300 ohms	Yes
• Input resistance (0 to 300 ohms)	10 M Ω

Technical specifications (continued)

Article number	6ES7144-5KD00-0BA0 ET 200AL, AI 4XU//RTD, 4XM12
Cable length	
• shielded, max.	30 m
Analog value generation for the inputs	
Measurement principle	integrating
Integration and conversion time/ resolution per channel	
• Resolution with overrange (bit including sign), max.	16 bit
• Integration time, parameterizable	Yes; channel by channel
• Integration time (ms)	0,3 / 16,7 / 20 / 60
• Interference voltage suppression for interference frequency f1 in Hz	16.7 / 50 / 60 / 3 600
• Conversion time (per channel)	2 / 18 / 21 / 61 ms
Smoothing of measured values	
• parameterizable	Yes
• Step: None	Yes; 1 x cycle time
• Step: low	Yes; 4 x cycle time
• Step: Medium	Yes; 16 x cycle time
• Step: High	Yes; 32 x cycle time
Encoder	
Connection of signal encoders	
• for voltage measurement	Yes
• for current measurement as 2-wire transducer	Yes
• for current measurement as 4-wire transducer	Yes
• for resistance measurement with two-wire connection	Yes
• for resistance measurement with three-wire connection	Yes
Errors/accuracies	
Linearity error (relative to input range), (+/-)	0.025 %
Temperature error (relative to input range), (+/-)	0.01 %/K
Crosstalk between the inputs, max.	-70 dB
Repeat accuracy in steady state at 25 °C (relative to input range), (+/-)	0.01 %
Operational error limit in overall temperature range	
• Voltage, relative to input range, (+/-)	0.35 %
• Current, relative to input range, (+/-)	0.45 %
• Resistance, relative to input range, (+/-)	0.25 %
• Resistance thermometer, relative to input range, (+/-)	0.25 %
Basic error limit (operational limit at 25 °C)	
• Voltage, relative to input range, (+/-)	0.25 %
• Current, relative to input range, (+/-)	0.25 %
• Resistance, relative to input range, (+/-)	0.15 %
• Resistance thermometer, relative to input range, (+/-)	0.15 %

Article number	6ES7144-5KD00-0BA0 ET 200AL, AI 4XU//RTD, 4XM12
Interference voltage suppression for f = n x (f1 +/- 0.5 %), f1 = interference frequency	
• Series mode interference (peak value of interference < rated value of input range), min.	40 dB
Interrupts/diagnostics/ status information	
Alarms	
• Diagnostic alarm	Yes; Parameterizable
• Limit value alarm	Yes; Parameterizable
Diagnostic messages	
• Wire-break	Yes; at 4 mA to 20 mA and 1 V to 5 V
• Short-circuit	Yes; Encoder supply to M, channel by channel
• Overflow/underflow	Yes
Diagnostics indication LED	
• Channel status display	Yes; Green LED
• for module diagnostics	Yes; Green/red LED
Potential separation	
between the load voltages	Yes
Potential separation channels	
• between the channels	No
• between the channels and backplane bus	Yes
• between the channels and the power supply of the electronics	No
Isolation	
Isolation tested with	707 V DC (type test)
Degree and class of protection	
Degree of protection acc. to EN 60529	
• IP65	Yes
• IP67	Yes
Ambient conditions	
Ambient temperature during operation	
• min.	-25 °C
• max.	55 °C
Connection method	
Design of electrical connection for the inputs and outputs	M12, 5-pole
Power supply	M8, 4-pole
ET-Connection	
• ET-Connection	M8, 4-pin, shielded
Dimensions	
Width	30 mm
Height	159 mm
Depth	40 mm
Weights	
Weight, approx.	168 g

I/O systemsSIMATIC ET 200 systems without control cabinet
SIMATIC ET 200AL**I/O modules > Analog I/O modules****Technical specifications (continued)**

Article number	6ES7145-5ND00-0BA0 ET 200AL, AQ 4xU/I, 4xM12
General information	
Product type designation	AQ 4XU/I, 4XM12
HW functional status	E01
Firmware version	V1.0.x
Product function	
• I&M data	Yes; I&M0 to I&M3
Engineering with	
• STEP 7 TIA Portal configurable/ integrated as of version	STEP 7 V14 or higher
• STEP 7 configurable/integrated as of version	V5.5 SP4 Hotfix 7 or higher
• PROFIBUS as of GSD version/ GSD revision	GSD as of Revision 5
• PROFINET as of GSD version/ GSD revision	GSDML V2.3.1
Supply voltage	
Load voltage 1L+	
• Rated value (DC)	24 V
• Reverse polarity protection	Yes; Against destruction; actuator power supply outputs applied with reversed polarity
Input current	
Current consumption (rated value)	110 mA; without load
from load voltage 1L+ (unswitched voltage)	4 A; Maximum value
from load voltage 2L+, max.	4 A; Maximum value
Actuator supply	
Number of outputs	4
Short-circuit protection	Yes; per module, electronic
Output current	
• Rated value	Total current 1 A up to 45 °C; 0.5 A up to 55 °C
Power loss	
Power loss, typ.	2.6 W
Analog outputs	
Number of analog outputs	4
Voltage output, short-circuit protection	Yes
Voltage output, short-circuit current, max.	24 mA
Current output, no-load voltage, max.	15 V
Cycle time (all channels) max.	1 ms
Output ranges, voltage	
• 0 to 10 V	Yes; 15 bit
• 1 V to 5 V	Yes; 14 bit
• -10 V to +10 V	Yes; 16 bit incl. sign
Output ranges, current	
• 0 to 20 mA	Yes; 15 bit
• -20 mA to +20 mA	Yes; 16 bit incl. sign
• 4 mA to 20 mA	Yes; 14 bit
Connection of actuators	
• for voltage output two-wire connection	Yes
• for voltage output four-wire connection	Yes
• for current output two-wire connection	Yes
• for current output four-wire connection	Yes

Article number	6ES7145-5ND00-0BA0 ET 200AL, AQ 4xU/I, 4xM12
Load impedance (in rated range of output)	
• with voltage outputs, min.	1 kΩ
• with voltage outputs, capacitive load, max.	1 μF
• with current outputs, max.	500 Ω
• with current outputs, inductive load, max.	1 mH
Destruction limits against exter- nally applied voltages and currents	
• Voltages at the outputs towards MANA	16 V
Cable length	
• shielded, max.	30 m
Settling time	
• for resistive load	1 ms
• for capacitive load	1 ms
• for inductive load	1 ms
Errors/accuracies	
Output ripple (relative to output range, bandwidth 0 to 50 kHz), (+/-)	0.02 %
Linearity error (relative to output range), (+/-)	0.1 %
Temperature error (relative to output range), (+/-)	0.005 %/K
Crosstalk between the outputs, max.	-70 dB
Repeat accuracy in steady state at 25 °C (relative to output range), (+/-)	0.03 %
Operational error limit in overall temperature range	
• Voltage, relative to output range, (+/-)	0.25 %
• Current, relative to output range, (+/-)	0.25 %
Basic error limit (operational limit at 25 °C)	
• Voltage, relative to output range, (+/-)	0.15 %
• Current, relative to output range, (+/-)	0.15 %
Interrupts/diagnostics/ status information	
Substitute values connectable	Yes; channel by channel, parameterizable
Alarms	
• Diagnostic alarm	Yes; Parameterizable
Diagnostic messages	
• Wire-break	Yes; channel-by-channel, only for output type "current"
• Short-circuit	Yes; Actuator supply module by module; channel by channel for output type "voltage"
Diagnostics indication LED	
• Channel status display	Yes; Green LED
• for module diagnostics	Yes; Green/red LED
Potential separation	
between the load voltages	Yes
Potential separation channels	
• between the channels	No
• between the channels and backplane bus	Yes
• between the channels and the power supply of the electronics	No

Technical specifications (continued)

Article number	6ES7145-5ND00-0BA0 ET 200AL, AQ 4xU/I, 4xM12
Isolation	
Isolation tested with	707 V DC (type test)
Degree and class of protection	
Degree of protection acc. to EN 60529	
• IP65	Yes
• IP67	Yes
Ambient conditions	
Ambient temperature during operation	
• min.	-25 °C
• max.	55 °C

Article number	6ES7145-5ND00-0BA0 ET 200AL, AQ 4xU/I, 4xM12
Connection method	
Design of electrical connection for the inputs and outputs	M12, 5-pole
Power supply	M8, 4-pole
ET-Connection	
• ET-Connection	M8, 4-pin, shielded
Dimensions	
Width	30 mm
Height	159 mm
Depth	40 mm
Weights	
Weight, approx.	175 g

Ordering data

Ordering data	Article No.
Analog input modules	
AI 4xU/I/RTD, 4xM12	6ES7144-5KD00-0BA0
AQ 4xU/I, 4xM12	6ES7145-5ND00-0BA0
Accessories	
Bus cable for backplane bus (ET connection)	
4-pin, shielded	
Pre-assembled at both ends, 2 M8 connectors	
0.19 m	6ES7194-2LH02-0AA0
0.3 m	6ES7194-2LH03-0AA0
1 m	6ES7194-2LH10-0AA0
2 m	6ES7194-2LH20-0AA0
5 m	6ES7194-2LH50-0AA0
10 m	6ES7194-2LN10-0AA0
15 m	6ES7194-2LN15-0AA0
Pre-assembled at both ends, 2 M8 connectors, angled	
0.3 m	6ES7194-2LH03-0AB0
1 m	6ES7194-2LH10-0AB0
2 m	6ES7194-2LH20-0AB0
5 m	6ES7194-2LH50-0AB0
10 m	6ES7194-2LN10-0AB0
15 m	6ES7194-2LN15-0AB0
Pre-assembled at one end, 1 M8 connector	
2 m	6ES7194-2LH20-0AC0
5 m	6ES7194-2LH50-0AC0
10 m	6ES7194-2LN10-0AC0
15 m	6ES7194-2LN15-0AC0

Ordering data	Article No.
M8 power cable	
4-pin	
Pre-assembled at both ends, M8 connector and M8 socket	
0.19 m	6ES7194-2LH02-1AA0
0.3 m	6ES7194-2LH03-1AA0
1 m	6ES7194-2LH10-1AA0
2 m	6ES7194-2LH20-1AA0
5 m	6ES7194-2LH50-1AA0
10 m	6ES7194-2LN10-1AA0
15 m	6ES7194-2LN15-1AA0
Pre-assembled at both ends, angled M8 connector and angled M8 socket	
0.3 m	6ES7194-2LH03-1AB0
1 m	6ES7194-2LH10-1AB0
2 m	6ES7194-2LH20-1AB0
5 m	6ES7194-2LH50-1AB0
10 m	6ES7194-2LN10-1AB0
15 m	6ES7194-2LN15-1AB0
Pre-assembled at one end, M8 socket	
2 m	6ES7194-2LH20-1AC0
5 m	6ES7194-2LH50-1AC0
10 m	6ES7194-2LN10-1AC0
15 m	6ES7194-2LN15-1AC0
M8 connector for ET connection	6ES7194-2AB00-0AA0
4-pin, shielded	
M8 power connector	
Male contact insert, 4-pin	6ES7194-2AA00-0AA0
Female contact insert, 4-pin	6ES7194-2AC00-0AA0
ET connection FastConnect stripping tool	6ES7194-2KA00-0AA0
Stripping tool for stripping the ET connection bus cable	
Labels	6ES7194-2BA00-0AA0
10 x 5 mm, RAL 9016; 5 frames with 40 labels each	

I/O systems

SIMATIC ET 200 systems without control cabinet
SIMATIC ET 200AL

I/O modules > Communication > CM IO-Link

Overview

- 30-mm-wide CM IO-Link communication module
- For the connection of up to 4 IO-Link devices according to IO-Link Specification V1.0 and V1.1 and port Class B
- The IO-Link parameters are configured using the Port Configuration Tool (PCT), version V3.2 and higher

Technical specifications

Article number	6ES7147-5JD00-0BA0 ET 200AL, CM 4X IO-LINK, 4XM12
General information	
Product type designation	CM 4x IO-LINK, 4xM12
HW functional status	E03
Firmware version	V1.0.x
Product function	
• I&M data	Yes; I&M0 to I&M3
Engineering with	
• STEP 7 TIA Portal configurable/integrated as of version	STEP 7 V13 SP1 or higher
• STEP 7 configurable/integrated as of version	From V5.5 SP4 Hotfix 3
• PROFIBUS as of GSD version/GSD revision	GSD as of Revision 5
• PROFINET as of GSD version/GSD revision	GSDML V2.3.1
Supply voltage	
Load voltage 1L+	
• Rated value (DC)	24 V
• Reverse polarity protection	Yes
Load voltage 2L+	
• Rated value (DC)	24 V
• Reverse polarity protection	Yes; against destruction; load increasing

Article number	6ES7147-5JD00-0BA0 ET 200AL, CM 4X IO-LINK, 4XM12
Input current	
Current consumption (rated value)	40 mA; without load
from load voltage 1L+ (unswitched voltage)	4 A; Maximum value
from load voltage 2L+, max.	4 A; Maximum value
Encoder supply	
Number of outputs	4
24 V encoder supply	
• Short-circuit protection	Yes; per module, electronic
• Output current, max.	1.4 A; Total current of all ports
Power loss	
Power loss, typ.	2.6 W
IO-Link	
Number of ports	4
• of which simultaneously controllable	4
IO-Link protocol 1.0	Yes
IO-Link protocol 1.1	Yes
Transmission rate	4.8 kBaud (COM1); 38.4 kBaud (COM2), 230 kBaud (COM3)
Size of process data, input per port	32 byte
Size of process data, input per module	32 byte
Size of process data, output per port	32 byte
Size of process data, output per module	32 byte
Memory size for device parameter	2 kbyte; for each port
Cable length unshielded, max.	20 m
Operating modes	
• IO-Link	Yes
• DI	Yes
• DQ	Yes; max. 100 mA
Connection of IO-Link devices	
• Port type A	Yes; via 3-core cable
• Port type B	Yes; Additional device supply: 1.6 A total current of all ports

Technical specifications (continued)

Article number	6ES7147-5JD00-0BA0 ET 200AL, CM 4X IO-LINK, 4XM12
Interrupts/diagnostics/ status information	
Alarms	
• Diagnostic alarm	Yes; Parameterizable
Diagnostic messages	
• Monitoring the supply voltage	Yes
• Wire-break	Yes
• Short-circuit	Yes
Diagnostics indication LED	
• Channel status display	Yes; Green LED
• for module diagnostics	Yes; Green/red LED
• For load voltage monitoring	Yes; Green LED
Potential separation	
between the load voltages	Yes
Potential separation channels	
• between the channels	No
• between the channels and backplane bus	Yes
• between the channels and the power supply of the electronics	No
Isolation	
Isolation tested with	707 V DC (type test)
Degree and class of protection	
Degree of protection acc. to EN 60529	
• IP65	Yes
• IP67	Yes
Standards, approvals, certificates	
Suitable for safety-oriented group deactivation	Yes
Highest safety class achievable in safety mode	
• Performance level according to ISO 13849-1	PL d
• SIL acc. to IEC 61508	SIL 2

Article number	6ES7147-5JD00-0BA0 ET 200AL, CM 4X IO-LINK, 4XM12
Ambient conditions	
Ambient temperature during operation	
• min.	-25 °C
• max.	55 °C
Connection method	
Design of electrical connection for the inputs and outputs	M12, 5-pole
Power supply	M8, 4-pole
ET-Connection	
• ET-Connection	M8, 4-pin, shielded
Dimensions	
Width	30 mm
Height	159 mm
Depth	40 mm
Weights	
Weight, approx.	145 g

I/O systemsSIMATIC ET 200 systems without control cabinet
SIMATIC ET 200AL

I/O modules > Communication > CM IO-Link

Ordering data	Article No.	Ordering data	Article No.
CM IO-Link		M8 power cable	
CM 4X IO-Link, 4XM12; for the connection of up to 4 IO-Link devices according to IO-Link Specification V1.0 and V1.1 and port Class B	6ES7147-5JD00-0BA0	4-pin	
Accessories		Pre-assembled at both ends, M8 connector and M8 socket	
Bus cable for backplane bus (ET connection)		0.19 m	6ES7194-2LH02-1AA0
4-pin, shielded		0.3 m	6ES7194-2LH03-1AA0
Pre-assembled at both ends, 2 M8 connectors		1 m	6ES7194-2LH10-1AA0
0.19 m	6ES7194-2LH02-0AA0	2 m	6ES7194-2LH20-1AA0
0.3 m	6ES7194-2LH03-0AA0	5 m	6ES7194-2LH50-1AA0
1 m	6ES7194-2LH10-0AA0	10 m	6ES7194-2LN10-1AA0
2 m	6ES7194-2LH20-0AA0	15 m	6ES7194-2LN15-1AA0
5 m	6ES7194-2LH50-0AA0	Pre-assembled at both ends, angled M8 connector and angled M8 socket	
10 m	6ES7194-2LN10-0AA0	0.3 m	6ES7194-2LH03-1AB0
15 m	6ES7194-2LN15-0AA0	1 m	6ES7194-2LH10-1AB0
Pre-assembled at both ends, 2 M8 connectors, angled		2 m	6ES7194-2LH20-1AB0
0.3 m	6ES7194-2LH03-0AB0	5 m	6ES7194-2LH50-1AB0
1 m	6ES7194-2LH10-0AB0	10 m	6ES7194-2LN10-1AB0
2 m	6ES7194-2LH20-0AB0	15 m	6ES7194-2LN15-1AB0
5 m	6ES7194-2LH50-0AB0	Pre-assembled at one end, M8 socket	
10 m	6ES7194-2LN10-0AB0	2 m	6ES7194-2LH20-1AC0
15 m	6ES7194-2LN15-0AB0	5 m	6ES7194-2LH50-1AC0
Pre-assembled at one end, 1 M8 connector		10 m	6ES7194-2LN10-1AC0
2 m	6ES7194-2LH20-0AC0	15 m	6ES7194-2LN15-1AC0
5 m	6ES7194-2LH50-0AC0	M8 connector for ET connection	6ES7194-2AB00-0AA0
10 m	6ES7194-2LN10-0AC0	4-pin, shielded	
15 m	6ES7194-2LN15-0AC0	M8 power connector	
		Male contact insert, 4-pin	6ES7194-2AA00-0AA0
		Female contact insert, 4-pin	6ES7194-2AC00-0AA0
		ET connection FastConnect stripping tool	6ES7194-2KA00-0AA0
		Stripping tool for stripping the ET connection bus cable	
		Labels	6ES7194-2BA00-0AA0
		10 x 5 mm, RAL 9016; 5 frames with 40 labels each	

Overview

- Pre-assembled cables in various designs and lengths:
 - For connecting the interface modules and I/O modules via the internal backplane bus (ET connection)
 - For power supply.

Technical specifications

Article number	6ES7194-2LH02-0AA0	6ES7194-2LH03-0AA0	6ES7194-2LH10-0AA0	6ES7194-2LH20-0AA0
	CONNECTING CABLE ET-CONNECTION, 0.19M	CONNECTING CABLE ET-CONNECTION, 0.3M	CONNECTING CABLE ET-CONNECTION, 1.0M	CONNECTING CABLE ET-CONNECTION, 2.0M
General information				
Product type designation	BUS CABLE ET CONNECTION, 0.19M	BUS CABLE ET-CONNECTION, 0.3M	BUS CABLE ET-CONNECTION, 1.0M	BUS CABLE ET-CONNECTION, 2.0M
Product description	Flexible cable (4-core), preassembled at both ends with 2x M8 plugs, 4-pin, shielded	Flexible cable (4-core), preassembled at both ends with 2x M8 plugs, 4-pin, shielded	Flexible cable (4-core), preassembled at both ends with 2x M8 plugs, 4-pin, shielded	Flexible cable (4-core), preassembled at both ends with 2x M8 plugs, 4-pin, shielded
Suitability for use	for connecting ET-CONNECTION node (e.g. SIMATIC ET 200AL) in degree of protection IP65 / 67	for connecting ET-CONNECTION nodes (e.g. SIMATIC ET 200AL) in degree of protection IP65 / 67	for connecting ET-CONNECTION nodes (e.g. SIMATIC ET 200AL) in degree of protection IP65 / 67	for connecting ET-CONNECTION nodes (e.g. SIMATIC ET 200AL) in degree of protection IP65 / 67
Degree and class of protection				
Degree of protection acc. to EN 60529				
• IP65	Yes	Yes	Yes	Yes
• IP67	Yes	Yes	Yes	Yes
Ambient conditions				
Ambient temperature during assembly, min.	-30 °C	-30 °C	-30 °C	-30 °C
Ambient temperature during assembly, max.	80 °C	80 °C	80 °C	80 °C
Ambient temperature during storage/transportation				
• min.	-40 °C	-40 °C	-40 °C	-40 °C
• max.	80 °C	80 °C	80 °C	80 °C
Cables				
Cable designation	2Y(ST)CY 1x4x0.5/1.0-100-GN	2Y(ST)CY 1x4x0.5/1.0-100-GN	2Y(ST)CY 1x4x0.5/1.0-100-GN	2Y(ST)CY 1x4x0.5/1.0-100-GN
Design of shield	Overlapped aluminum-clad foil, sheathed in a braid of tin-plated copper wires	Overlapped aluminum-clad foil, sheathed in a braid of tin-plated copper wires	Overlapped aluminum-clad foil, sheathed in a braid of tin-plated copper wires	Overlapped aluminum-clad foil, sheathed in a braid of tin-plated copper wires
Cable length	0.19 m	0.3 m	1 m	2 m
Number of electrical cores	4	4	4	4
Outer diameter of inner conductor	0.5 mm	0.5 mm	0.5 mm	0.5 mm
Outer diameter of core insulation	1 mm	1 mm	1 mm	1 mm
Outer diameter of cable sheath	5 mm	5 mm	5 mm	5 mm
Number of bending cycles	1 000 000; Cable carrier compliant for 1 million bending cycles with a bending radius of 100 mm, a speed of 4 m/s and an acceleration of 4 m/s ²	1 000 000; Cable carrier compliant for 1 million bending cycles with a bending radius of 100 mm, a speed of 4 m/s and an acceleration of 4 m/s ²	1 000 000; Cable carrier compliant for 1 million bending cycles with a bending radius of 100 mm, a speed of 4 m/s and an acceleration of 4 m/s ²	1 000 000; Cable carrier compliant for 1 million bending cycles with a bending radius of 100 mm, a speed of 4 m/s and an acceleration of 4 m/s ²
Permissible bending radius, single bend, min.	20 mm	20 mm	20 mm	20 mm
Permissible bending radius, multiple bends, min.	40 mm	40 mm	40 mm	40 mm
Bending radius for continuous bending	100 mm	100 mm	100 mm	100 mm
Color of cable sheath	Green	Green	Green	Green
Color of core insulation of data cores	white / yellow / blue / orange	white / yellow / blue / orange	white / yellow / blue / orange	white / yellow / blue / orange
Weight per length	34 kg/km	34 kg/km	34 kg/km	34 kg/km

I/O systemsSIMATIC ET 200 systems without control cabinet
SIMATIC ET 200AL**Accessories > Cables and connectors****Technical specifications (continued)**

Article number	6ES7194-2LH02-0AA0 CONNECTING CABLE ET-CONNECTION, 0.19M	6ES7194-2LH03-0AA0 CONNECTING CABLE ET-CONNECTION, 0.3M	6ES7194-2LH10-0AA0 CONNECTING CABLE ET-CONNECTION, 1.0M	6ES7194-2LH20-0AA0 CONNECTING CABLE ET-CONNECTION, 2.0M
Mechanics/material				
Type of cable outlet	180 degree cable outlet	180 degree cable outlet	180 degree cable outlet	180 degree cable outlet
Material of housing	metal	metal	metal	metal
Material of cable sheath	PVC	PVC	PVC	PVC
Material of core insulation	PE	PE	PE	PE
Article number	6ES7194-2LH50-0AA0 CONNECTING CABLE ET-CONNECTION, 5.0M	6ES7194-2LN10-0AA0 BUS CABLE ET-CONNECTION, 10M	6ES7194-2LN15-0AA0 BUS CABLE ET-CONNECTION, 15M	
General information				
Product type designation	BUS CABLE ET-CONNECTION, 5.0M	BUS CABLE ET-CONNECTION, 10M	BUS CABLE ET CONNECTION, 15M	
Product description	Flexible cable (4-core), preassembled at both ends with 2x M8 plugs, 4-pin, shielded	Flexible cable (4-core), preassembled at both ends with 2x M8 plugs, 4-pin, shielded	Flexible cable (4-core), preassembled at both ends with 2x M8 plugs, 4-pin, shielded	
Suitability for use	for connecting ET-CONNECTION nodes (e.g. SIMATIC ET 200AL) in degree of protection IP65 / 67	for connecting ET-CONNECTION nodes (e.g. SIMATIC ET 200AL) in degree of protection IP65 / 67	for connecting ET-CONNECTION nodes (e.g. SIMATIC ET 200AL) in degree of protection IP65 / 67	
Degree and class of protection				
Degree of protection acc. to EN 60529				
• IP65	Yes	Yes	Yes	
• IP67	Yes	Yes	Yes	
Ambient conditions				
Ambient temperature during assembly, min.	-30 °C	-30 °C	-30 °C	
Ambient temperature during assembly, max.	80 °C	80 °C	80 °C	
Ambient temperature during storage/transportation				
• min.	-40 °C	-40 °C	-40 °C	
• max.	80 °C	80 °C	80 °C	
Cables				
Cable designation	2Y(ST)CY 1x4x0.5/1.0-100-GN	2Y(ST)CY 1x4x0.5/1.0-100-GN	2Y(ST)CY 1x4x0.5/1.0-100-GN	
Design of shield	Overlapped aluminum-clad foil, sheathed in a braid of tin-plated copper wires	Overlapped aluminum-clad foil, sheathed in a braid of tin-plated copper wires	Overlapped aluminum-clad foil, sheathed in a braid of tin-plated copper wires	
Cable length	5 m	10 m	15 m	
Number of electrical cores	4	4	4	
Outer diameter of inner conductor	0.5 mm	0.5 mm	0.5 mm	
Outer diameter of core insulation	1 mm	1 mm	1 mm	
Outer diameter of cable sheath	5 mm	5 mm	5 mm	
Number of bending cycles	1 000 000; Cable carrier compliant for 1 million bending cycles with a bending radius of 100 mm, a speed of 4 m/s and an acceleration of 4 m/s ²	1 000 000; Cable carrier compliant for 1 million bending cycles with a bending radius of 100 mm, a speed of 4 m/s and an acceleration of 4 m/s ²		
Permissible bending radius, single bend, min.	20 mm	20 mm	20 mm	
Permissible bending radius, multiple bends, min.	40 mm	40 mm	40 mm	
Bending radius for continuous bending	100 mm	100 mm	100 mm	
Color of cable sheath	Green	Green	Green	
Color of core insulation of data cores	white / yellow / blue / orange	white / yellow / blue / orange	white / yellow / blue / orange	
Weight per length	34 kg/km	34 kg/km	34 kg/km	
Mechanics/material				
Type of cable outlet	180 degree cable outlet	180 degree cable outlet	180 degree cable outlet	
Material of housing	metal	metal	metal	
Material of cable sheath	PVC	PVC	PVC	
Material of core insulation	PE	PE	PE	

Technical specifications (continued)

Article number	6ES7194-2LH03-0AB0 CONNECTING CABLE ET-CON., ANGLED, 0.3M	6ES7194-2LH10-0AB0 CONNECTING CABLE ET-CON., ANGLED, 1.0M	6ES7194-2LH20-0AB0 CONNECTING CABLE ET-CON., ANGLED, 2.0M
General information			
Product type designation	BUS CABLE ET-CONNECTION, ANGLED, 0.3M	BUS CABLE ET-CONNECTION, ANGLED, 1.0M	BUS CABLE ET-CONNECTION, ANGLED, 2.0M
Product description	Flexible cable (4-core), preassembled at both ends with 2x M8 plugs, angled, 4-pin, shielded	Flexible cable (4-core), preassembled at both ends with 2x M8 plugs, angled, 4-pin, shielded	Flexible cable (4-core), preassembled at both ends with 2x M8 plugs, angled, 4-pin, shielded
Suitability for use	for connecting ET-CONNECTION nodes (e.g. SIMATIC ET 200AL) in degree of protection IP65 / 67	for connecting ET-CONNECTION nodes (e.g. SIMATIC ET 200AL) in degree of protection IP65 / 67	for connecting ET-CONNECTION nodes (e.g. SIMATIC ET 200AL) in degree of protection IP65 / 67
Degree and class of protection			
Degree of protection acc. to EN 60529			
• IP65	Yes	Yes	Yes
• IP67	Yes	Yes	Yes
Ambient conditions			
Ambient temperature during assembly, min.	-30 °C	-30 °C	-30 °C
Ambient temperature during assembly, max.	80 °C	80 °C	80 °C
Ambient temperature during storage/transportation			
• min.	-40 °C	-40 °C	-40 °C
• max.	80 °C	80 °C	80 °C
Cables			
Cable designation	2Y(ST)CY 1x4x0.5/1.0-100-GN	2Y(ST)CY 1x4x0.5/1.0-100-GN	2Y(ST)CY 1x4x0.5/1.0-100-GN
Design of shield	Overlapped aluminum-clad foil, sheathed in a braid of tin-plated copper wires	Overlapped aluminum-clad foil, sheathed in a braid of tin-plated copper wires	Overlapped aluminum-clad foil, sheathed in a braid of tin-plated copper wires
Cable length	0.3 m	1 m	2 m
Number of electrical cores	4	4	4
Outer diameter of inner conductor	0.5 mm	0.5 mm	0.5 mm
Outer diameter of core insulation	1 mm	1 mm	1 mm
Outer diameter of cable sheath	5 mm	5 mm	5 mm
Number of bending cycles	1 000 000; Cable carrier compliant for 1 million bending cycles with a bending radius of 100 mm, a speed of 4 m/s and an acceleration of 4 m/s ²	1 000 000; Cable carrier compliant for 1 million bending cycles with a bending radius of 100 mm, a speed of 4 m/s and an acceleration of 4 m/s ²	1 000 000; Cable carrier compliant for 1 million bending cycles with a bending radius of 100 mm, a speed of 4 m/s and an acceleration of 4 m/s ²
Permissible bending radius, single bend, min.	20 mm	20 mm	20 mm
Permissible bending radius, multiple bends, min.	40 mm	40 mm	40 mm
Bending radius for continuous bending	100 mm	100 mm	100 mm
Color of cable sheath	Green	Green	Green
Color of core insulation of data cores	white / yellow / blue / orange	white / yellow / blue / orange	white / yellow / blue / orange
Weight per length	34 kg/km	34 kg/km	34 kg/km
Mechanics/material			
Type of cable outlet	90 degree cable outlet	90 degree cable outlet	90 degree cable outlet
Material of housing	metal	metal	metal
Material of cable sheath	PVC	PVC	PVC
Material of core insulation	PE	PE	PE

I/O systemsSIMATIC ET 200 systems without control cabinet
SIMATIC ET 200AL**Accessories > Cables and connectors****Technical specifications (continued)**

Article number	6ES7194-2LH50-0AB0 CONNECTING CABLE ET-CON., ANGLED, 5.0M	6ES7194-2LN10-0AB0 BUS CABLE ET-CONNECTION, ANGLED, 10M	6ES7194-2LN15-0AB0 BUS CABLE ET-CONNECTION, ANGLED, 15M
General information			
Product type designation	BUS CABLE ET-CONNECTION, ANGLED, 5.0M	BUS CABLE ET-CONNECTION, ANGLED, 10M	BUS CABLE ET CONNECTION, ANGLED, 15M
Product description	Flexible cable (4-core), preassembled at both ends with 2x M8 plugs, angled, 4-pin, shielded	Flexible cable (4-core), preassembled at both ends with 2x M8 plugs, angled, 4-pin, shielded	Flexible cable (4-core), preassembled at both ends with 2x M8 plugs, angled, 4-pin, shielded
Suitability for use	for connecting ET-CONNECTION nodes (e.g. SIMATIC ET 200AL) in degree of protection IP65 / 67	for connecting ET-CONNECTION nodes (e.g. SIMATIC ET 200AL) in degree of protection IP65 / 67	for connecting ET-CONNECTION nodes (e.g. SIMATIC ET 200AL) in degree of protection IP65 / 67
Degree and class of protection			
Degree of protection acc. to EN 60529			
• IP65	Yes	Yes	Yes
• IP67	Yes	Yes	Yes
Ambient conditions			
Ambient temperature during assembly, min.	-30 °C	-30 °C	-30 °C
Ambient temperature during assembly, max.	80 °C	80 °C	80 °C
Ambient temperature during storage/transportation			
• min.	-40 °C	-40 °C	-40 °C
• max.	80 °C	80 °C	80 °C
Cables			
Cable designation	2Y(ST)CY 1x4x0.5/1.0-100-GN	2Y(ST)CY 1x4x0.5/1.0-100-GN	2Y(ST)CY 1x4x0.5/1.0-100-GN
Design of shield	Overlapped aluminum-clad foil, sheathed in a braid of tin-plated copper wires	Overlapped aluminum-clad foil, sheathed in a braid of tin-plated copper wires	Overlapped aluminum-clad foil, sheathed in a braid of tin-plated copper wires
Cable length	5 m	10 m	15 m
Number of electrical cores	4	4	4
Outer diameter of inner conductor	0.5 mm	0.5 mm	0.5 mm
Outer diameter of core insulation	1 mm	1 mm	1 mm
Outer diameter of cable sheath	5 mm	5 mm	5 mm
Number of bending cycles	1 000 000; Cable carrier compliant for 1 million bending cycles with a bending radius of 100 mm, a speed of 4 m/s and an acceleration of 4 m/s ²	1 000 000; Cable carrier compliant for 1 million bending cycles with a bending radius of 100 mm, a speed of 4 m/s and an acceleration of 4 m/s ²	
Permissible bending radius, single bend, min.	20 mm	20 mm	20 mm
Permissible bending radius, multiple bends, min.	40 mm	40 mm	40 mm
Bending radius for continuous bending	100 mm	100 mm	100 mm
Color of cable sheath	Green	Green	Green
Color of core insulation of data cores	white / yellow / blue / orange	white / yellow / blue / orange	white / yellow / blue / orange
Weight per length	34 kg/km	34 kg/km	34 kg/km
Mechanics/material			
Type of cable outlet	90 degree cable outlet	90 degree cable outlet	90 degree cable outlet
Material of housing	metal	metal	metal
Material of cable sheath	PVC	PVC	PVC
Material of core insulation	PE	PE	PE

Technical specifications (continued)

Article number	6ES7194-2LH20-0AC0 CONNECTING CABLE ET-CONNECTION, 2.0M	6ES7194-2LH50-0AC0 CONNECTING CABLE ET-CONNECTION, 5.0M	6ES7194-2LN10-0AC0 BUS CABLE ET-CONNECTION, 10M	6ES7194-2LN15-0AC0 BUS CABLE ET-CONNECTION, 15M
General information				
Product type designation	BUS CABLE ET-CONNECTION, 2.0M	BUS CABLE ET-CONNECTION, 5.0M	BUS CABLE ET-CONNECTION, 10M	BUS CABLE ET CONNECTION, 15M
Product description	Flexible cable (4-core), preassembled at one end with 1x M8 plug, 4-pin, shielded	Flexible cable (4-core), preassembled at one end with 1x M8 plug, 4-pin, shielded	Flexible cable (4-core), preassembled at one end with 1x M8 plug, 4-pin, shielded	Flexible cable (4-core), preassembled at one end with 1x M8 plug, 4-pin, shielded
Suitability for use	for connecting ET-CONNECTION nodes (e.g. SIMATIC ET 200AL) in degree of protection IP65 / 67	for connecting ET-CONNECTION nodes (e.g. SIMATIC ET 200AL) in degree of protection IP65 / 67	for connecting ET-CONNECTION nodes (e.g. SIMATIC ET 200AL) in degree of protection IP65 / 67	for connecting ET-CONNECTION nodes (e.g. SIMATIC ET 200AL) in degree of protection IP65 / 67
Degree and class of protection				
Degree of protection acc. to EN 60529				
• IP65	Yes	Yes	Yes	Yes
• IP67	Yes	Yes	Yes	Yes
Ambient conditions				
Ambient temperature during assembly, min.	-30 °C	-30 °C	-30 °C	-30 °C
Ambient temperature during assembly, max.	80 °C	80 °C	80 °C	80 °C
Ambient temperature during storage/transportation				
• min.	-40 °C	-40 °C	-40 °C	-40 °C
• max.	80 °C	80 °C	80 °C	80 °C
Cables				
Cable designation	2Y(ST)CY 1x4x0.5/1.0-100- GN	2Y(ST)CY 1x4x0.5/1.0-100- GN	2Y(ST)CY 1x4x0.5/1.0-100- GN	2Y(ST)CY 1x4x0.5/1.0-100- GN
Design of shield	Overlapped aluminum-clad foil, sheathed in a braid of tin-plated copper wires	Overlapped aluminum-clad foil, sheathed in a braid of tin-plated copper wires	Overlapped aluminum-clad foil, sheathed in a braid of tin-plated copper wires	Overlapped aluminum-clad foil, sheathed in a braid of tin-plated copper wires
Cable length	2 m	5 m	10 m	15 m
Number of electrical cores	4	4	4	4
Outer diameter of inner conductor	0.5 mm	0.5 mm	0.5 mm	0.5 mm
Outer diameter of core insulation	1 mm	1 mm	1 mm	1 mm
Outer diameter of cable sheath	5 mm	5 mm	5 mm	5 mm
Number of bending cycles	1 000 000; Cable carrier compliant for 1 million bending cycles with a bending radius of 100 mm, a speed of 4 m/s and an acceleration of 4 m/s ²	1 000 000; Cable carrier compliant for 1 million bending cycles with a bending radius of 100 mm, a speed of 4 m/s and an acceleration of 4 m/s ²	1 000 000; Cable carrier compliant for 1 million bending cycles with a bending radius of 100 mm, a speed of 4 m/s and an acceleration of 4 m/s ²	
Permissible bending radius, single bend, min.	20 mm	20 mm	20 mm	20 mm
Permissible bending radius, multiple bends, min.	40 mm	40 mm	40 mm	40 mm
Bending radius for continuous bending	100 mm	100 mm	100 mm	100 mm
Color of cable sheath	Green	Green	Green	Green
Color of core insulation of data cores	white / yellow / blue / orange	white / yellow / blue / orange	white / yellow / blue / orange	white / yellow / blue / orange
Weight per length	34 kg/km	34 kg/km	34 kg/km	34 kg/km
Mechanics/material				
Type of cable outlet	180 degree cable outlet	180 degree cable outlet	180 degree cable outlet	180 degree cable outlet
Material of housing	metal	metal	metal	metal
Material of cable sheath	PVC	PVC	PVC	PVC
Material of core insulation	PE	PE	PE	PE

I/O systemsSIMATIC ET 200 systems without control cabinet
SIMATIC ET 200AL**Accessories > Cables and connectors****Technical specifications (continued)**

Article number	6ES7194-2LH02-1AA0 POWER CABLE M8, 0.19M	6ES7194-2LH03-1AA0 POWER CABLE M8, 0.3M	6ES7194-2LH10-1AA0 POWER CABLE M8, 1.0M	6ES7194-2LH20-1AA0 POWER CABLE M8, 2.0M
General information				
Product type designation	Power cable M8, 0.19M	POWER CABLE M8, 0.3M	POWER CABLE M8, 1.0M	POWER CABLE M8, 2.0M
Product description	Flexible cable (4-core), preassembled at each end with a 4-pin M8 male / female connector	Flexible cable (4-core), preassembled at each end with a 4-pin M8 male / female connector	Flexible cable (4-core), preassembled at each end with a 4-pin M8 male / female connector	Flexible cable (4-core), preassembled at each end with a 4-pin M8 male / female connector
Suitability for use	For connection to ET 200AL for 24 V DC power supply	For connection to ET 200AL for 24 V DC power supply	For connection to ET 200AL for 24 V DC power supply	For connection to ET 200AL for 24 V DC power supply
Degree and class of protection				
Degree of protection acc. to EN 60529				
• IP65	Yes	Yes	Yes	Yes
• IP67	Yes	Yes	Yes	Yes
Ambient conditions				
Ambient temperature during assembly, min.	-30 °C	-30 °C	-30 °C	-30 °C
Ambient temperature during assembly, max.	80 °C	80 °C	80 °C	80 °C
Ambient temperature during storage/transportation				
• min.	-40 °C	-40 °C	-40 °C	-40 °C
• max.	80 °C	80 °C	80 °C	80 °C
Cables				
Cable designation	4 Li9Y 0.50 mm ² Y	4 Li9Y 0.50 mm ² Y	4 Li9Y 0.50 mm ² Y	4 Li9Y 0.50 mm ² Y
Cable length	0.19 m	0.3 m	1 m	2 m
Number of electrical cores	4	4	4	4
Outer diameter of inner conductor	0.8 mm	0.8 mm	0.8 mm	0.8 mm
Outer diameter of core insulation	1.46 mm	1.46 mm	1.46 mm	1.46 mm
Outer diameter of cable sheath	5.2 mm	5.2 mm	5.2 mm	5.2 mm
Number of bending cycles	2 500 000; Cable carrier compliant for 2.5 million bending cycles with a bending radius of 52 mm, a speed of 3 m/s and an acceleration of 10 m/s ²	2 500 000; Cable carrier compliant for 2.5 million bending cycles with a bending radius of 52 mm, a speed of 3 m/s and an acceleration of 10 m/s ²	2 500 000; Cable carrier compliant for 2.5 million bending cycles with a bending radius of 52 mm, a speed of 3 m/s and an acceleration of 10 m/s ²	2 500 000; Cable carrier compliant for 2.5 million bending cycles with a bending radius of 52 mm, a speed of 3 m/s and an acceleration of 10 m/s ²
Permissible bending radius, single bend, min.	26 mm	26 mm	26 mm	26 mm
Permissible bending radius, multiple bends, min.	52 mm	52 mm	52 mm	52 mm
Bending radius for continuous bending	52 mm	52 mm	52 mm	52 mm
Color of cable sheath	gray	gray	gray	gray
Color of core insulation of energy core	white / brown / blue / black	white / brown / blue / black	white / brown / blue / black	white / brown / blue / black
Weight per length	44 kg/km	44 kg/km	44 kg/km	44 kg/km
Mechanics/material				
Type of cable outlet	180 degree cable outlet	180 degree cable outlet	180 degree cable outlet	180 degree cable outlet
Material of housing	plastic	plastic	plastic	plastic
Material of cable sheath	PVC	PVC	PVC	PVC
Material of core insulation	PP	PP	PP	PP

Technical specifications (continued)

Article number	6ES7194-2LH50-1AA0 POWER CABLE M8, 5.0M	6ES7194-2LN10-1AA0 POWER CABLE M8, 10M	6ES7194-2LN15-1AA0 POWER CABLE M8, 15M
General information			
Product type designation	POWER CABLE M8, 5.0M	POWER CABLE M8, 10M	POWER CABLE M8, 15M
Product description	Flexible cable (4-core), preassembled at each end with a 4-pin M8 male / female connector	Flexible cable (4-core), preassembled at each end with a 4-pin M8 male / female connector	Flexible cable (4-core), preassembled at each end with a 4-pin M8 male / female connector
Suitability for use	For connection to ET 200AL for 24 V DC power supply	For connection to ET 200AL for 24 V DC power supply	For connection to ET 200AL for 24 V DC power supply
Degree and class of protection			
Degree of protection acc. to EN 60529			
• IP65	Yes	Yes	Yes
• IP67	Yes	Yes	Yes
Ambient conditions			
Ambient temperature during assembly, min.	-30 °C	-30 °C	-30 °C
Ambient temperature during assembly, max.	80 °C	80 °C	80 °C
Ambient temperature during storage/transportation			
• min.	-40 °C	-40 °C	-40 °C
• max.	80 °C	80 °C	80 °C
Cables			
Cable designation	4 Li9Y 0.50 mm ² Y	4 Li9Y 0.50 mm ² Y	4 Li9Y 0.50 mm ² Y
Cable length	5 m	10 m	15 m
Number of electrical cores	4	4	4
Outer diameter of inner conductor	0.8 mm	0.8 mm	0.8 mm
Outer diameter of core insulation	1.46 mm	1.46 mm	1.46 mm
Outer diameter of cable sheath	5.2 mm	5.2 mm	5.2 mm
Number of bending cycles	2 500 000; Cable carrier compliant for 2.5 million bending cycles with a bending radius of 52 mm, a speed of 3 m/s and an acceleration of 10 m/s ²	2 500 000; Cable carrier compliant for 2.5 million bending cycles with a bending radius of 52 mm, a speed of 3 m/s and an acceleration of 10 m/s ²	2 500 000; Cable carrier compliant for 2.5 million bending cycles with a bending radius of 52 mm, a speed of 3 m/s and an acceleration of 10 m/s ²
Permissible bending radius, single bend, min.	26 mm	26 mm	26 mm
Permissible bending radius, multiple bends, min.	52 mm	52 mm	52 mm
Bending radius for continuous bending	52 mm	52 mm	52 mm
Color of cable sheath	gray	gray	gray
Color of core insulation of energy core	white / brown / blue / black	white / brown / blue / black	white / brown / blue / black
Weight per length	44 kg/km	44 kg/km	44 kg/km
Mechanics/material			
Type of cable outlet	180 degree cable outlet	180 degree cable outlet	180 degree cable outlet
Material of housing	plastic	plastic	plastic
Material of cable sheath	PVC	PVC	PVC
Material of core insulation	PP	PP	PP

I/O systemsSIMATIC ET 200 systems without control cabinet
SIMATIC ET 200AL**Accessories > Cables and connectors****Technical specifications** (continued)

Article number	6ES7194-2LH03-1AB0	6ES7194-2LH10-1AB0	6ES7194-2LH20-1AB0
	POWER CABLE M8, ANGLED, 0.3M	POWER CABLE M8, ANGLED, 1.0M	POWER CABLE M8, ANGLED, 2.0M
General information			
Product type designation	POWER CABLE M8, ANGLED, 0.3M	POWER CABLE M8, ANGLED, 1.0M	POWER CABLE M8, ANGLED, 2.0M
Product description	Flexible cable (4-core), preassembled at each end with a 4-pin M8 male / female connector, angled	Flexible cable (4-core), preassembled at each end with a 4-pin M8 male / female connector, angled	Flexible cable (4-core), preassembled at each end with a 4-pin M8 male / female connector, angled
Suitability for use	For connection to ET 200AL for 24 V DC power supply	For connection to ET 200AL for 24 V DC power supply	For connection to ET 200AL for 24 V DC power supply
Degree and class of protection			
Degree of protection acc. to EN 60529			
• IP65	Yes	Yes	Yes
• IP67	Yes	Yes	Yes
Ambient conditions			
Ambient temperature during assembly, min.	-30 °C	-30 °C	-30 °C
Ambient temperature during assembly, max.	80 °C	80 °C	80 °C
Ambient temperature during storage/transportation			
• min.	-40 °C	-40 °C	-40 °C
• max.	80 °C	80 °C	80 °C
Cables			
Cable designation	4 Li9Y 0.50 mm ² Y	4 Li9Y 0.50 mm ² Y	4 Li9Y 0.50 mm ² Y
Cable length	0.3 m	1 m	2 m
Number of electrical cores	4	4	4
Outer diameter of inner conductor	0.8 mm	0.8 mm	0.8 mm
Outer diameter of core insulation	1.46 mm	1.46 mm	1.46 mm
Outer diameter of cable sheath	5.2 mm	5.2 mm	5.2 mm
Number of bending cycles	2 500 000; Cable carrier compliant for 2.5 million bending cycles with a bending radius of 52 mm, a speed of 3 m/s and an acceleration of 10 m/s ²	2 500 000; Cable carrier compliant for 2.5 million bending cycles with a bending radius of 52 mm, a speed of 3 m/s and an acceleration of 10 m/s ²	2 500 000; Cable carrier compliant for 2.5 million bending cycles with a bending radius of 52 mm, a speed of 3 m/s and an acceleration of 10 m/s ²
Permissible bending radius, single bend, min.	26 mm	26 mm	26 mm
Permissible bending radius, multiple bends, min.	52 mm	52 mm	52 mm
Bending radius for continuous bending	52 mm	52 mm	52 mm
Color of cable sheath	gray	gray	gray
Color of core insulation of energy core	white / brown / blue / black	white / brown / blue / black	white / brown / blue / black
Weight per length	44 kg/km	44 kg/km	44 kg/km
Mechanics/material			
Type of cable outlet	90 degree cable outlet	90 degree cable outlet	90 degree cable outlet
Material of housing	plastic	plastic	plastic
Material of cable sheath	PVC	PVC	PVC
Material of core insulation	PP	PP	PP

Technical specifications (continued)

Article number	6ES7194-2LH50-1AB0	6ES7194-2LN10-1AB0	6ES7194-2LN15-1AB0
	POWER CABLE M8, ANGLED, 5.0M	POWER CABLE M8, ANGLED, 10M	POWER CABLE M8, ANGLED, 15M
General information			
Product type designation	POWER CABLE M8, ANGLED, 5.0M	POWER CABLE M8, ANGLED 10M	POWER CABLE M8, ANGLED, 15M
Product description	Flexible cable (4-core), preassembled at each end with a 4-pin M8 male / female connector, angled	Flexible cable (4-core), preassembled at each end with a 4-pin M8 male / female connector, angled	Flexible cable (4-core), preassembled at each end with a 4-pin M8 male / female connector, angled
Suitability for use	For connection to ET 200AL for 24 V DC power supply	For connection to ET 200AL for 24 V DC power supply	For connection to ET 200AL for 24 V DC power supply
Degree and class of protection			
Degree of protection acc. to EN 60529			
• IP65	Yes	Yes	Yes
• IP67	Yes	Yes	Yes
Ambient conditions			
Ambient temperature during assembly, min.	-30 °C	-30 °C	-30 °C
Ambient temperature during assembly, max.	80 °C	80 °C	80 °C
Ambient temperature during storage/transportation			
• min.	-40 °C	-40 °C	-40 °C
• max.	80 °C	80 °C	80 °C
Cables			
Cable designation	4 Li9Y 0.50 mm ² Y	4 Li9Y 0.50 mm ² Y	4 Li9Y 0.50 mm ² Y
Cable length	5 m	10 m	15 m
Number of electrical cores	4	4	4
Outer diameter of inner conductor	0.8 mm	0.8 mm	0.8 mm
Outer diameter of core insulation	1.46 mm	1.46 mm	1.46 mm
Outer diameter of cable sheath	5.2 mm	5.2 mm	5.2 mm
Number of bending cycles	2 500 000; Cable carrier compliant for 2.5 million bending cycles with a bending radius of 52 mm, a speed of 3 m/s and an acceleration of 10 m/s ²	2 500 000; Cable carrier compliant for 2.5 million bending cycles with a bending radius of 52 mm, a speed of 3 m/s and an acceleration of 10 m/s ²	2 500 000; Cable carrier compliant for 2.5 million bending cycles with a bending radius of 52 mm, a speed of 3 m/s and an acceleration of 10 m/s ²
Permissible bending radius, single bend, min.	26 mm	26 mm	26 mm
Permissible bending radius, multiple bends, min.	52 mm	52 mm	52 mm
Bending radius for continuous bending	52 mm	52 mm	52 mm
Color of cable sheath	gray	gray	gray
Color of core insulation of energy core	white / brown / blue / black	white / brown / blue / black	white / brown / blue / black
Weight per length	44 kg/km	44 kg/km	44 kg/km
Mechanics/material			
Type of cable outlet	90 degree cable outlet	90 degree cable outlet	90 degree cable outlet
Material of housing	plastic	plastic	plastic
Material of cable sheath	PVC	PVC	PVC
Material of core insulation	PP	PP	PP

I/O systemsSIMATIC ET 200 systems without control cabinet
SIMATIC ET 200AL**Accessories > Cables and connectors****Technical specifications (continued)**

Article number	6ES7194-2LH20-1AC0 POWER CABLE M8, 2.0M	6ES7194-2LH50-1AC0 POWER CABLE M8, 5.0M	6ES7194-2LN10-1AC0 POWER CABLE M8, 10M	6ES7194-2LN15-1AC0 POWER CABLE M8, 15M
General information				
Product type designation	POWER CABLE M8, 2.0M	POWER CABLE M8, 5.0M	POWER CABLE M8, 10M	POWER CABLE M8, 15M
Product description	Flexible cable (4-core), preassembled at one end with 1x M8 female connector	Flexible cable (4-core), preassembled at one end with 1x M8 female connector	Flexible cable (4-core), preassembled at one end with 1x M8 plug, 4-pin, shielded	Flexible cable (4-core), preassembled at one end with 1x M8 plug, 4-pin, shielded
Suitability for use	For connection to ET 200AL for 24 V DC power supply	For connection to ET 200AL for 24 V DC power supply	For connection to ET 200AL for 24 V DC power supply	For connection to ET 200AL for 24 V DC power supply
Degree and class of protection				
Degree of protection acc. to EN 60529				
• IP65	Yes	Yes	Yes	Yes
• IP67	Yes	Yes	Yes	Yes
Ambient conditions				
Ambient temperature during assembly, min.	-30 °C	-30 °C	-30 °C	-30 °C
Ambient temperature during assembly, max.	80 °C	80 °C	80 °C	80 °C
Ambient temperature during storage/transportation				
• min.	-40 °C	-40 °C	-40 °C	-40 °C
• max.	80 °C	80 °C	80 °C	80 °C
Cables				
Cable designation	4 Li9Y 0.50 mm ² Y	4 Li9Y 0.50 mm ² Y	4 Li9Y 0.50 mm ² Y	4 Li9Y 0.50 mm ² Y
Cable length	2 m	5 m	10 m	15 m
Number of electrical cores	4	4	4	4
Outer diameter of inner conductor	0.8 mm	0.8 mm	0.8 mm	0.8 mm
Outer diameter of core insulation	1.46 mm	1.46 mm	1.46 mm	1.46 mm
Outer diameter of cable sheath	5.2 mm	5.2 mm	5.2 mm	5.2 mm
Number of bending cycles	2 500 000; Cable carrier compliant for 2.5 million bending cycles with a bending radius of 52 mm, a speed of 3 m/s and an acceleration of 10 m/s ²	2 500 000; Cable carrier compliant for 2.5 million bending cycles with a bending radius of 52 mm, a speed of 3 m/s and an acceleration of 10 m/s ²	2 500 000; Cable carrier compliant for 2.5 million bending cycles with a bending radius of 52 mm, a speed of 3 m/s and an acceleration of 10 m/s ²	2 500 000; Cable carrier compliant for 2.5 million bending cycles with a bending radius of 52 mm, a speed of 3 m/s and an acceleration of 10 m/s ²
Permissible bending radius, single bend, min.	26 mm	26 mm	26 mm	26 mm
Permissible bending radius, multiple bends, min.	52 mm	52 mm	52 mm	52 mm
Bending radius for continuous bending	52 mm	52 mm	52 mm	52 mm
Color of cable sheath	gray	gray	gray	gray
Color of core insulation of energy core	white / brown / blue / black	white / brown / blue / black	white / brown / blue / black	white / brown / blue / black
Weight per length	44 kg/km	44 kg/km	44 kg/km	44 kg/km
Mechanics/material				
Type of cable outlet	180 degree cable outlet	180 degree cable outlet	180 degree cable outlet	180 degree cable outlet
Material of housing	plastic	plastic	plastic	plastic
Material of cable sheath	PVC	PVC	PVC	PVC
Material of core insulation	PP	PP	PP	PP

Technical specifications (continued)

Article number	6ES7194-2AA00-0AA0 M8 POWER CONNECTOR	6ES7194-2AC00-0AA0 M8 POWER CONNECTOR, SOCKET
General information		
Product type designation	M8 POWER CONNECTOR	POWER CONNECTOR M8, SOCKET
Product description	M8 plug connector with high degree of protection, 4-pin, plastic version	M8 plug connector with high degree of protection, socket insert, 4-pin, plastic version
Suitability for use	For connection to ET 200AL for 24 V DC power supply	For connection to ET 200AL for 24 V DC power supply
Degree and class of protection		
Degree of protection acc. to EN 60529		
• IP65	Yes	Yes
• IP67	Yes	Yes
Ambient conditions		
Ambient temperature during assembly, min.	-30 °C	-30 °C
Ambient temperature during assembly, max.	85 °C	85 °C
Ambient temperature during storage/transportation		
• min.	-40 °C	-40 °C
• max.	85 °C	85 °C
Mechanics/material		
Type of cable outlet	180 degree cable outlet	180 degree cable outlet
Material of housing	plastic	plastic
Dimensions		
Width	14 mm	14 mm
Depth	47 mm	47 mm

Article number	6ES7194-2AB00-0AA0 M8 CONNECTOR ET-CONNECTION
General information	
Product type designation	M8 PLUG ET-CONNECTION
Product description	M8 plug connector with high degree of protection, 4-pin, metal version
Suitability for use	for connecting ET-CONNECTION nodes (e.g. SIMATIC ET 200AL) in degree of protection IP65 / 67
Degree and class of protection	
Degree of protection acc. to EN 60529	
• IP65	Yes
• IP67	Yes
Ambient conditions	
Ambient temperature during assembly, min.	-30 °C
Ambient temperature during assembly, max.	80 °C

Article number	6ES7194-2AB00-0AA0 M8 CONNECTOR ET-CONNECTION
Ambient temperature during storage/transportation	
• min.	-40 °C
• max.	80 °C
Mechanics/material	
Type of cable outlet	180 degree cable outlet
Material of housing	metal
Dimensions	
Width	14 mm
Depth	47 mm

Ordering data**Article No.****Article No.****Bus cable for backplane bus (ET connection)**

4-pin, shielded
Pre-assembled at both ends,
2 M8 connectors

0.19 m	6ES7194-2LH02-0AA0
0.3 m	6ES7194-2LH03-0AA0
1 m	6ES7194-2LH10-0AA0
2 m	6ES7194-2LH20-0AA0
5 m	6ES7194-2LH50-0AA0
10 m	6ES7194-2LN10-0AA0
15 m	6ES7194-2LN15-0AA0

PUR line, pre-assembled at both
ends, 2 M8 connectors

0.19 m	6ES7194-2MH02-0AA0
0.3 m	6ES7194-2MH03-0AA0
1 m	6ES7194-2MH10-0AA0
2 m	6ES7194-2MH20-0AA0
5 m	6ES7194-2MH50-0AA0
10 m	6ES7194-2MN10-0AA0
15 m	6ES7194-2MN15-0AA0

I/O systemsSIMATIC ET 200 systems without control cabinet
SIMATIC ET 200AL**Accessories > Cables and connectors**

Ordering data	Article No.		Article No.
Bus cable for backplane bus (ET connection) (continued)		PUR line, pre-assembled at both ends, M8 connector and M8 socket	
Pre-assembled at both ends, 2 M8 connectors, angled		0.19 m	6ES7194-2MH02-1AA0
0.3 m	6ES7194-2LH03-0AB0	0.3 m	6ES7194-2MH03-1AA0
1 m	6ES7194-2LH10-0AB0	1 m	6ES7194-2MH10-1AA0
2 m	6ES7194-2LH20-0AB0	2 m	6ES7194-2MH20-1AA0
5 m	6ES7194-2LH50-0AB0	5 m	6ES7194-2MH50-1AA0
10 m	6ES7194-2LN10-0AB0	10 m	6ES7194-2MN10-1AA0
15 m	6ES7194-2LN15-0AB0	15 m	6ES7194-2MN15-1AA0
PUR line, pre-assembled at both ends, 2 M8 connectors, angled		Pre-assembled at both ends, angled M8 connector and angled M8 socket	
0.3 m	6ES7194-2MH03-0AB0	0.3 m	6ES7194-2LH03-1AB0
1 m	6ES7194-2MH10-0AB0	1 m	6ES7194-2LH10-1AB0
2 m	6ES7194-2MH20-0AB0	2 m	6ES7194-2LH20-1AB0
5 m	6ES7194-2MH50-0AB0	5 m	6ES7194-2LH50-1AB0
10 m	6ES7194-2MN10-0AB0	10 m	6ES7194-2LN10-1AB0
15 m	6ES7194-2MN15-0AB0	15 m	6ES7194-2LN15-1AB0
Pre-assembled at one end, 1 M8 connector		PUR line, pre-assembled at both ends, angled M8 connector and angled M8 socket	
2 m	6ES7194-2LH20-0AC0	0.3 m	6ES7194-2MH03-1AB0
5 m	6ES7194-2LH50-0AC0	1 m	6ES7194-2MH10-1AB0
10 m	6ES7194-2LN10-0AC0	2 m	6ES7194-2MH20-1AB0
15 m	6ES7194-2LN15-0AC0	5 m	6ES7194-2MH50-1AB0
PUR line, pre-assembled at one end, 1 M8 connector		10 m	6ES7194-2MN10-1AB0
2 m	6ES7194-2MH20-0AC0	15 m	6ES7194-2MN15-1AB0
5 m	6ES7194-2MH50-0AC0	Pre-assembled at one end, M8 socket	
10 m	6ES7194-2MN10-0AC0	2 m	6ES7194-2LH20-1AC0
15 m	6ES7194-2MN15-0AC0	5 m	6ES7194-2LH50-1AC0
Connecting cable for bus cable for backplane bus (ET connection)		10 m	6ES7194-2LN10-1AC0
4-pin, shielded		15 m	6ES7194-2LN15-1AC0
Pre-assembled at both ends, 2 M8 connectors, 0.2 m	6ES7194-2LH02-0AD0	PUR line, pre-assembled at one end, M8 socket	
PUR line, pre-assembled at both ends, 2 M8 connectors, 0.2 m	6ES7194-2MH02-0AD0	2 m	6ES7194-2MH20-1AC0
M8 power cable		5 m	6ES7194-2MH50-1AC0
4-pin		10 m	6ES7194-2MN10-1AC0
Pre-assembled at both ends, M8 connector and M8 socket		15 m	6ES7194-2MN15-1AC0
0.19 m	6ES7194-2LH02-1AA0	M8 connector for ET connection	6ES7194-2AB00-0AA0
0.3 m	6ES7194-2LH03-1AA0	4-pin, shielded	
1 m	6ES7194-2LH10-1AA0	M8 power connector	
2 m	6ES7194-2LH20-1AA0	Male contact insert, 4-pin	6ES7194-2AA00-0AA0
5 m	6ES7194-2LH50-1AA0	Female contact insert, 4-pin	6ES7194-2AC00-0AA0
10 m	6ES7194-2LN10-1AA0	ET connection FastConnect stripping tool	6ES7194-2KA00-0AA0
15 m	6ES7194-2LN15-1AA0	Stripping tool for stripping the ET connection bus cable	

Overview

- Labels for the identification of channels, modules and slots of ET 200AL components
- Can be used for interface modules and I/O modules

Ordering data**Labels**

10 x 5 mm, RAL 9016;
5 frames with 40 labels each

Article No.

6ES7194-2BA00-0AA0

I/O systems

SIMATIC ET 200 systems without control cabinet

SIMATIC ET 200eco PN

Overview

- Compact block I/O for processing digital, analog and IO-Link signals for connecting to the PROFINET bus system
- Cabinet-free design in IP65/66/67 degree of protection with M12 connections
- Extremely rugged and resistant metal enclosure and casting

- Compact module in two types of enclosures:
 - 30 mm x 200 mm x 37 mm (W x H x D, long and narrow enclosure), with 4 x M12 for digital signals
 - 60 mm x 175 mm x 37 mm (W x H x D, short and wide enclosure), with 8 x M12 for digital signals and IO-Link
 - 60 mm x 175 mm x 37 mm (W x H x D, short and wide enclosure) with 4 x M12 or 8 x M12 for analog signals
- PROFINET connection: 2 x M12 and automatic PROFINET address assignment
- Data transmission rate 100 Mbps
- LLDP proximity detection without PG and fast startup (boot up within approx. 0.5 seconds)
- Supply and load voltage connection: 2 x M12
- Module variance:
 - 8 DI
 - 16 DI
 - 8 DO (2 A)
 - 8 DO (1.3 A)
 - 8 DO (0.5 A)
 - 16 DO (1.3 A)
 - 8 DI/DO (1.3 A)
 - 8 AI (U, I, TC, RTD)
 - 8 AI (TC, RTD)
 - 4 AO (U, I)
 - 4 IO-Link
 - 4 IO-Link + 8 DI + 4 DO (1.3 A)
- Channel-specific diagnostics
- Ambient temperature range -40 °C to 60 °C

Technical specifications

Article number	6ES7141-6BF00-0AB0	6ES7141-6BG00-0AB0	6ES7141-6BH00-0AB0
	ET 200ECO PN, 8DI, DC24V, 4XM12	ET 200ECO PN, 8DI, DC24V, 8XM12	ET 200ECO PN, 16DI, DC24V, 8XM12
General information			
Vendor identification (VendorID)	002AH	002AH	002AH
Device identifier (DeviceID)	0306H	0306H	0306H
Supply voltage			
Rated value (DC)	24 V	24 V	24 V
Reverse polarity protection	Yes	Yes	Yes
Input current			
Current consumption, typ.	100 mA	100 mA	100 mA
Encoder supply			
Number of outputs	4	8	8
Short-circuit protection	Yes; Electronic	Yes; Electronic	Yes; Electronic
Output current			
• Rated value	100 mA; per output	100 mA; per output	100 mA; per output
Power loss			
Power loss, typ.	5.5 W	4.5 W	6.5 W
Digital inputs			
Number of digital inputs	8	8	16
• in groups of	2	1	2
Input characteristic curve in accordance with IEC 61131, type 3	Yes	Yes	Yes
Number of simultaneously controllable inputs			
all mounting positions			
- up to 60 °C, max.	8	8	16

Technical specifications (continued)

Article number	6ES7141-6BF00-0AB0 ET 200ECO PN, 8DI, DC24V, 4XM12	6ES7141-6BG00-0AB0 ET 200ECO PN, 8DI, DC24V, 8XM12	6ES7141-6BH00-0AB0 ET 200ECO PN, 16DI, DC24V, 8XM12
Input voltage			
• Type of input voltage	DC	DC	DC
• Rated value (DC)	24 V	24 V	24 V
• for signal "0"	-3 to +5V	-3 to +5V	-3 to +5V
• for signal "1"	+11 to +30V	+11 to +30V	+11 to +30V
Input current			
• for signal "1", typ.	7 mA	7 mA	7 mA
Input delay (for rated value of input voltage) for standard inputs			
- at "0" to "1", max.	typically 3 ms	typically 3 ms	typically 3 ms
- at "1" to "0", max.	typically 3 ms	typically 3 ms	typically 3 ms
Cable length			
• unshielded, max.	30 m	30 m	30 m
Encoder			
Connectable encoders			
• 2-wire sensor	Yes	Yes	Yes
- permissible quiescent current (2-wire sensor), max.	1.5 mA	1.5 mA	1.5 mA
Interfaces			
Transmission procedure	100BASE-TX	100BASE-TX	100BASE-TX
Number of PROFINET interfaces	1	1	1
PROFINET IO			
• Autocrossing	Yes	Yes	Yes
• automatic detection of transmission rate	Yes	Yes	Yes
• Transmission rate, max.	100 Mbit/s	100 Mbit/s	100 Mbit/s
• integrated switch	Yes	Yes	Yes
PROFINET IO Device			
- IRT with the option "high flexibility"	Yes	Yes	Yes
- Prioritized startup	Yes	Yes	Yes
Protocols			
Supports protocol for PROFINET IO	Yes	Yes	Yes
PROFINET CBA	No	No	No
PROFIsafe	No	No	No
Protocols (Ethernet)			
• TCP/IP	No	No	No
• SNMP	Yes	Yes	Yes
• DCP	Yes	Yes	Yes
• LLDP	Yes	Yes	Yes
• ping	Yes	Yes	Yes
• ARP	Yes	Yes	Yes
Interrupts/diagnostics/ status information			
Status indicator	Yes; Green LED	Yes; Green LED	Yes; Green LED
Diagnostic functions	Yes	Yes	Yes
Alarms			
• Diagnostic alarm	Yes	Yes	Yes
Diagnostic messages			
• Diagnostic information readable	Yes	Yes	Yes
• Monitoring the supply voltage	Yes; Green "ON" LED	Yes; Green "ON" LED	Yes; Green "ON" LED
• Wire-break in signal transmitter cable	Yes	Yes	Yes
• Short-circuit encoder supply	Yes; Per channel group	Yes; Per channel group	Yes; Per channel group
• Group error	Yes; Red/yellow "SF/MT" LED	Yes; Red/yellow "SF/MT" LED	Yes; Red/yellow "SF/MT" LED

I/O systems

SIMATIC ET 200 systems without control cabinet

SIMATIC ET 200eco PN

Technical specifications (continued)

Article number	6ES7141-6BF00-0AB0 ET 200ECO PN, 8DI, DC24V, 4XM12	6ES7141-6BG00-0AB0 ET 200ECO PN, 8DI, DC24V, 8XM12	6ES7141-6BH00-0AB0 ET 200ECO PN, 16DI, DC24V, 8XM12
Potential separation			
between the load voltages	Yes	Yes	Yes
between load voltage and all other switching components	No	No	No
between Ethernet and electronics	Yes	Yes	Yes
Potential separation digital inputs			
• between the channels	No	No	No
Isolation			
tested with			
• 24 V DC circuits	707 V DC (type test)	707 V DC (type test)	707 V DC (type test)
• Interface	1 500 V; According to IEEE 802.3	1 500 V; According to IEEE 802.3	1 500 V; According to IEEE 802.3
Degree and class of protection			
IP degree of protection	IP65/67	IP67	IP67
Connection method			
Design of electrical connection	4/5-pin M12 circular connectors	4/5-pin M12 circular connectors	4/5-pin M12 circular connectors
Dimensions			
Width	30 mm	60 mm	60 mm
Height	200 mm	175 mm	175 mm
Depth	49 mm	49 mm	49 mm
Weights			
Weight (without packaging)	550 g	910 g	910 g

Article number	6ES7142-6BF50-0AB0 ET 200ECO PN, 8DO, DC24V/0.5A, 4XM12	6ES7142-6BF00-0AB0 ET 200ECO PN, 8DO, DC24V/1.3A, 4XM12	6ES7142-6BG00-0AB0 ET 200ECO PN, 8DO, DC24V/1.3A, 8XM12	6ES7142-6BR00-0AB0 ET 200ECO PN, 8 DO, DC24V/2A, 8XM12	6ES7142-6BH00-0AB0 ET 200ECO PN, 16DO, DC24V/1.3A, 8XM12
General information					
Vendor identification (VendorID)	002AH	002AH	002AH	002AH	002AH
Device identifier (DeviceID)	0306H	0306H	0306H	0306H	0306H
Supply voltage					
Rated value (DC)	24 V	24 V	24 V	24 V	24 V
Reverse polarity protection	Yes	Yes	Yes	Yes	Yes
Load voltage 2L+					
• Rated value (DC)	24 V	24 V	24 V	24 V	24 V
• Reverse polarity protection	Yes	Yes	Yes	Yes	Yes
Input current					
Current consumption, typ.	100 mA	100 mA	100 mA	100 mA	100 mA
from supply voltage 1L+, max.	4 A	4 A	4 A	4 A	4 A
from load voltage 2L+, max.	4 A	4 A	4 A	4 A	4 A
Power loss					
Power loss, typ.	3 W	5.5 W	5.5 W	5 W	5.5 W
Digital outputs					
Number of digital outputs	8	8	8	8	16
• in groups of	8	4	4	4	8
Short-circuit protection	Yes	Yes	Yes	Yes	Yes
• Response threshold, typ.	0.7 A	1.8 A	1.8 A	2.8 A	1.8 A
Limitation of inductive shutdown voltage to	Typ. (L1+, L2+) -47 V	Typ. (L1+, L2+) -47 V	Typ. (L1+, L2+) -47 V	Typ. (L1+, L2+) -47 V	Typ. (L1+, L2+) -47 V
Controlling a digital input	Yes	Yes	Yes	Yes	Yes
Switching capacity of the outputs					
• on lamp load, max.	5 W	5 W	5 W	10 W	5 W
Output current					
• for signal "1" rated value	0.5 A	1.3 A; Maximum	1.3 A; Maximum	2 A	1.3 A; Maximum
• for signal "0" residual current, max.	1.5 mA	1.5 mA	1.5 mA	1.5 mA	1.5 mA

Technical specifications (continued)

Article number	6ES7142-6BF50-0AB0 ET 200ECO PN, 8DO, DC24V/0.5A, 4XM12	6ES7142-6BF00-0AB0 ET 200ECO PN, 8DO, DC24V/1.3A, 4XM12	6ES7142-6BG00-0AB0 ET 200ECO PN, 8DO, DC24V/1.3A, 8XM12	6ES7142-6BR00-0AB0 ET 200ECO PN, 8 DO, DC24V/2A, 8XM12	6ES7142-6BH00-0AB0 ET 200ECO PN, 16DO DC24V/1.3A, 8XM12
Parallel switching of two outputs					
• for uprating	No	No	No	No	No
• for redundant control of a load	Yes	Yes	Yes	Yes	Yes
Switching frequency					
• with resistive load, max.	100 Hz	100 Hz	100 Hz	100 Hz	100 Hz
• with inductive load, max.	0.5 Hz	0.5 Hz	0.5 Hz	0.5 Hz	0.5 Hz
• on lamp load, max.	1 Hz	1 Hz	1 Hz	1 Hz	1 Hz
Total current of the outputs (per group)					
all mounting positions					
- up to 55 °C, max.		3.9 A			
- up to 60 °C, max.	4 A	2.6 A	3.9 A	3.9 A	3.9 A
Cable length					
• unshielded, max.	30 m	30 m	30 m	30 m	30 m
Interfaces					
Transmission procedure	100BASE-TX	100BASE-TX	100BASE-TX	100BASE-TX	100BASE-TX
Number of PROFINET interfaces	1	1	1	1	1
PROFINET IO					
• Autocrossing	Yes	Yes	Yes	Yes	Yes
• automatic detection of transmission rate	Yes	Yes	Yes	Yes	Yes
• Transmission rate, max.	100 Mbit/s	100 Mbit/s	100 Mbit/s	100 Mbit/s	100 Mbit/s
• integrated switch	Yes	Yes	Yes	Yes	Yes
PROFINET IO Device					
- IRT with the option "high flexibility"	Yes	Yes	Yes	Yes	Yes
- Prioritized startup	Yes	Yes	Yes	Yes	Yes
Protocols					
Supports protocol for PROFINET IO	Yes	Yes	Yes	Yes	Yes
PROFINET CBA	No	No	No	No	No
PROFIsafe	No	No	No	No	No
Protocols (Ethernet)					
• TCP/IP	No	No	No	No	No
• SNMP	Yes	Yes	Yes	Yes	Yes
• DCP	Yes	Yes	Yes	Yes	Yes
• LLDP	Yes	Yes	Yes	Yes	Yes
• ping	Yes	Yes	Yes	Yes	Yes
• ARP	Yes	Yes	Yes	Yes	Yes
Interrupts/diagnostics/status information					
Status indicator	Yes; Green LED	Yes; Green LED	Yes; Green LED	Yes; Green LED	Yes; Green LED
Diagnostic functions	Yes	Yes	Yes	Yes	Yes
Alarms					
• Diagnostic alarm	Yes	Yes	Yes	Yes	Yes
Diagnostic messages					
• Diagnostic information readable	Yes	Yes	Yes	Yes	Yes
• Monitoring the supply voltage	Yes; Green "ON" LED	Yes; Green "ON" LED	Yes; Green "ON" LED	Yes; Green "ON" LED	Yes; Green "ON" LED
• Wire-break in actuator cable	Yes	Yes	Yes	Yes	Yes
• Short-circuit	Yes	Yes	Yes	Yes	Yes
• Group error	Yes; Red/yellow "SF/MT" LED	Yes; Red/yellow "SF/MT" LED	Yes; Red/yellow "SF/MT" LED	Yes; Red/yellow "SF/MT" LED	Yes; Red/yellow "SF/MT" LED

I/O systems

SIMATIC ET 200 systems without control cabinet

SIMATIC ET 200eco PN

Technical specifications (continued)

Article number	6ES7142-6BF50-0AB0 ET 200ECO PN, 8DO, DC24V/0.5A, 4XM12	6ES7142-6BF00-0AB0 ET 200ECO PN, 8DO, DC24V/1.3A, 4XM12	6ES7142-6BG00-0AB0 ET 200ECO PN, 8DO, DC24V/1.3A, 8XM12	6ES7142-6BR00-0AB0 ET 200ECO PN, 8 DO, DC24V/2A, 8XM12	6ES7142-6BH00-0AB0 ET 200ECO PN, 16DO DC24V/1.3A, 8XM12
Potential separation					
between the load voltages	Yes	Yes	Yes	Yes	Yes
between load voltage and all other switching components	No	No	No	No	No
between Ethernet and electronics	Yes	Yes	Yes	Yes	Yes
Potential separation digital outputs					
• between the channels	No	No	No	No	No
Isolation					
tested with					
• 24 V DC circuits	707 V DC (type test)	707 V DC (type test)	707 V DC (type test)	707 V DC (type test)	707 V DC (type test)
• Interface	1 500 V; According to IEEE 802.3	1 500 V; According to IEEE 802.3	1 500 V; According to IEEE 802.3	1 500 V; According to IEEE 802.3	1 500 V; According to IEEE 802.3
Degree and class of protection					
IP degree of protection	IP67	IP65/67	IP67	IP67	IP67
Connection method					
Design of electrical connection	4/5-pin M12 circular connectors	4/5-pin M12 circular connectors	4/5-pin M12 circular connectors	4/5-pin M12 circular connectors	4/5-pin M12 circular connectors
Dimensions					
Width	30 mm	30 mm	60 mm	60 mm	60 mm
Height	200 mm	200 mm	175 mm	175 mm	175 mm
Depth	49 mm	49 mm	49 mm	49 mm	49 mm
Weights					
Weight (without packaging)	550 g	550 g	910 g	910 g	910 g

Article number	6ES7147-6BG00-0AB0 ET 200ECO PN, 8 DIO, DC24V/1.3A, 8XM12
General information	
Vendor identification (VendorID)	002AH
Device identifier (DeviceID)	0306H
Supply voltage	
Rated value (DC)	24 V
Reverse polarity protection	Yes
Load voltage 2L+	
• Rated value (DC)	24 V
• Reverse polarity protection	Yes
Input current	
Current consumption, typ.	100 mA
from supply voltage 1L+, max.	4 A
from load voltage 2L+, max.	4 A
Encoder supply	
Number of outputs	8
Short-circuit protection	Yes; Electronic
Output current	
• Rated value	100 mA; per output
Power loss	
Power loss, typ.	6.5 W
Digital inputs	
Number of digital inputs	8
• in groups of	4
Input characteristic curve in accordance with IEC 61131, type 3	Yes
Number of simultaneously controllable inputs	
all mounting positions	
- up to 60 °C, max.	8

Article number	6ES7147-6BG00-0AB0 ET 200ECO PN, 8 DIO, DC24V/1.3A, 8XM12
Input voltage	
• Type of input voltage	DC
• Rated value (DC)	24 V
• for signal "0"	-3 to +5V
• for signal "1"	+11 to +30V
Input current	
• for signal "1", typ.	7 mA
Input delay (for rated value of input voltage) for standard inputs	
- at "0" to "1", max.	typically 3 ms
- at "1" to "0", max.	typically 3 ms
Cable length	
• unshielded, max.	30 m
Digital outputs	
Number of digital outputs	8
• in groups of	4
Short-circuit protection	Yes; Electronic
• Response threshold, typ.	1.8 A
Limitation of inductive shutdown voltage to	Typ. (L1+, L2+) -47 V
Controlling a digital input	Yes
Switching capacity of the outputs	
• on lamp load, max.	5 W
Output current	
• for signal "1" rated value	1.3 A; Maximum
• for signal "0" residual current, max.	1.5 mA

Technical specifications (continued)

Article number	6ES7147-6BG00-0AB0 ET 200ECO PN, 8 DIO, DC24V/1.3A, 8XM12
Parallel switching of two outputs	
• for uprating	No
• for redundant control of a load	Yes
Switching frequency	
• with resistive load, max.	100 Hz
• with inductive load, max.	0.5 Hz
• on lamp load, max.	1 Hz
Total current of the outputs (per group)	
all mounting positions	
- up to 60 °C, max.	3.9 A
Cable length	
• unshielded, max.	30 m
Encoder	
Connectable encoders	
• 2-wire sensor	Yes
- permissible quiescent current (2-wire sensor), max.	1.5 mA
Interfaces	
Transmission procedure	100BASE-TX
Number of PROFINET interfaces	1
PROFINET IO	
• Autocrossing	Yes
• automatic detection of transmission rate	Yes
• Transmission rate, max.	100 Mbit/s
• integrated switch	Yes
PROFINET IO Device	
- IRT with the option "high flexibility"	Yes
- Prioritized startup	Yes
Protocols	
Supports protocol for PROFINET IO	Yes
PROFINET CBA	No
PROFIsafe	No
Protocols (Ethernet)	
• TCP/IP	No
• SNMP	Yes
• DCP	Yes
• LLDP	Yes
• ping	Yes
• ARP	Yes

Article number	6ES7147-6BG00-0AB0 ET 200ECO PN, 8 DIO, DC24V/1.3A, 8XM12
Interrupts/diagnostics/status information	
Status indicator	Yes; Green LED
Diagnostic functions	Yes
Alarms	
• Diagnostic alarm	Yes
Diagnostic messages	
• Diagnostic information readable	Yes
• Monitoring the supply voltage	Yes; Green "ON" LED
• Wire-break in actuator cable	Yes
• Wire-break in signal transmitter cable	Yes
• Short-circuit	Yes
• Short-circuit encoder supply	Yes
• Group error	Yes; Red/yellow "SF/MT" LED
Potential separation	
between the load voltages	Yes
between load voltage and all other switching components	No
between Ethernet and electronics	Yes
Potential separation digital inputs	
• between the channels	No
Potential separation digital outputs	
• between the channels	No
Isolation	
tested with	
• 24 V DC circuits	707 V DC (type test)
• Interface	1 500 V; According to IEEE 802.3
Degree and class of protection	
IP degree of protection	IP65/67
Connection method	
Design of electrical connection	4/5-pin M12 circular connectors
Dimensions	
Width	60 mm
Height	175 mm
Depth	49 mm
Weights	
Weight (without packaging)	910 g

I/O systems

SIMATIC ET 200 systems without control cabinet

SIMATIC ET 200eco PN

Technical specifications (continued)

Article number	6ES7144-6KD00-0AB0 ET 200ECO PN, 8AI; 4 U/I; 4 RTD/TC 8XM12	6ES7144-6KD50-0AB0 ET 200ECO PN, 8AI RTD/TC 8XM12
General information		
Vendor identification (VendorID)	002AH	002AH
Device identifier (DeviceID)	0306H	0306H
Supply voltage		
Rated value (DC)	24 V	24 V
Reverse polarity protection	Yes	Yes; against destruction
Input current		
Current consumption, typ.	110 mA	110 mA
Encoder supply		
Number of outputs	4	
Short-circuit protection	Yes; Electronic at 1.4 A	
Output current		
• Rated value	1 A; Maximum	
Power loss		
Power loss, typ.	2.8 W	2.8 W
Analog inputs		
Number of analog inputs	8	8
• For voltage/current measurement	4	
• For resistance/resistance thermometer measurement	4	8
permissible input voltage for voltage input (destruction limit), max.	28.8 V permanent, 35 V for max. 500 ms	
Input ranges (rated values), voltages		
• 0 to +10 V	Yes	
• 1 V to 5 V	Yes	
• -10 V to +10 V	Yes	
• -80 mV to +80 mV	Yes	Yes
Input ranges (rated values), currents		
• 0 to 20 mA	Yes	
• -20 mA to +20 mA	Yes	
• 4 mA to 20 mA	Yes	
Input ranges (rated values), thermocouples		
• Type E	Yes	Yes
• Type J	Yes	Yes
• Type K	Yes	Yes
• Type N	Yes	Yes
Input ranges (rated values), resistance thermometer		
• Ni 100	Yes	Yes
• Ni 1000	Yes	Yes
• Ni 120	Yes	Yes
• Ni 200	Yes	Yes
• Ni 500	Yes	Yes
• Pt 100	Yes	Yes
• Pt 1000	Yes	Yes
• Pt 200	Yes	Yes
• Pt 500	Yes	Yes
Input ranges (rated values), resistors		
• 0 to 150 ohms	Yes	Yes
• 0 to 300 ohms	Yes	Yes
• 0 to 600 ohms	Yes	Yes
• 0 to 3000 ohms	Yes	Yes

Technical specifications (continued)

Article number	6ES7144-6KD00-0AB0 ET 200ECO PN, 8AI; 4 U/I; 4 RTD/TC 8XM12	6ES7144-6KD50-0AB0 ET 200ECO PN, 8AI RTD/TC 8XM12
Thermocouple (TC)		
Temperature compensation		
- parameterizable	Yes	Yes
- internal temperature compensation	Yes	Yes
- external temperature compensation with compensations socket	Yes	Yes
- external temperature compensation with Pt100		Yes
- dynamic reference temperature value		Yes
- for definable comparison point temperature		Yes
Cable length		
• shielded, max.	30 m	30 m
Analog value generation for the inputs		
Analog value display	SIMATIC S7 format	SIMATIC S7 format
Measurement principle	integrating	integrating
Integration and conversion time/resolution per channel		
• Resolution (incl. overrange)	15 bit + sign	15 bit + sign
• Integration time, parameterizable	Yes	Yes
• Integration time (ms)	2/16.67/20/100 ms	2/16.67/20/100 ms
• Interference voltage suppression for interference frequency f1 in Hz	500 / 60 / 50 / 10 Hz	500 / 60 / 50 / 10 Hz
• Conversion time (per channel)	4 / 19 / 22 / 102 ms	4 / 19 / 22 / 102 ms
Smoothing of measured values		
• parameterizable	Yes	Yes
• Step: None	Yes; 1 x cycle time	Yes; 1 x cycle time
• Step: low	Yes; 4 x cycle time	Yes; 4 x cycle time
• Step: Medium	Yes; 16 x cycle time	Yes; 16 x cycle time
• Step: High	Yes; 64 x cycle time	Yes; 64 x cycle time
Encoder		
Number of connectable encoders, max.	8	8
Connection of signal encoders		
• for voltage measurement	Yes	
• for current measurement as 2-wire transducer	Yes	
• for current measurement as 4-wire transducer	Yes	
• for resistance measurement with two-wire connection	Yes	Yes
• for resistance measurement with three-wire connection	Yes	Yes
• for resistance measurement with four-wire connection	Yes	Yes
Errors/accuracies		
Linearity error (relative to input range), (+/-)	0.01 %	0.01 %
Temperature error (relative to input range), (+/-)	U: 0.0035%/°C; I:0.006%/°C; RTD: 0.0005%/°C; TC: 0.0035%/°C	RTD: 0.0005%/°C; TC: 0.0035%/°C
Crosstalk between the inputs, min.	85 dB	-85 dB
Repeat accuracy in steady state at 25 °C (relative to input range), (+/-)	0.008 %	0.008 %
Interference voltage suppression for $f = n \times (f1 \pm 1 \%)$, $f1 =$ interference frequency		
• Series mode interference (peak value of interference < rated value of input range), min.	46 dB	46 dB
• Common mode interference, min.	70 dB	70 dB

I/O systems

SIMATIC ET 200 systems without control cabinet

SIMATIC ET 200eco PN

Technical specifications (continued)

Article number	6ES7144-6KD00-0AB0 ET 200ECO PN, 8AI; 4 U/I; 4 RTD/TC 8XM12	6ES7144-6KD50-0AB0 ET 200ECO PN, 8AI RTD/TC 8XM12
Interfaces		
Transmission procedure	100BASE-TX	100BASE-TX
Number of PROFINET interfaces	1	1
PROFINET IO		
• Autocrossing	Yes	Yes
• automatic detection of transmission rate	Yes	Yes
• Transmission rate, max.	100 Mbit/s	100 Mbit/s
• integrated switch	Yes	Yes
PROFINET IO Device		
- IRT with the option "high flexibility"	Yes	
- Prioritized startup	Yes	Yes
Protocols		
Supports protocol for PROFINET IO	Yes	Yes
PROFINET CBA	No	No
PROFIsafe	No	No
Protocols (Ethernet)		
• TCP/IP	No	No
• SNMP	Yes	Yes
• DCP	Yes	Yes
• LLDP	Yes	Yes
• ping	Yes	Yes
• ARP	Yes	Yes
Interrupts/diagnostics/status information		
Status indicator	Yes	
Diagnostic functions	Yes	Yes
Alarms		
• Diagnostic alarm	Yes	Yes
Diagnostic messages		
• Diagnostic information readable	Yes	Yes
• Monitoring the supply voltage	Yes; Green "ON" LED	Yes; Green "ON" LED
• Short-circuit encoder supply	Yes; per module	
• Group error	Yes; Red/yellow "SF/MT" LED	Yes; Red/yellow "SF/MT" LED
• Overflow/underflow	Yes	Yes
Potential separation		
between the load voltages	Yes	Yes
between load voltage and all other switching components	No	No
between Ethernet and electronics	Yes	Yes
Potential separation analog inputs		
• between the channels	No	No
Permissible potential difference		
Between the inputs and MANA (UCM)	10 Vpp AC	10 Vpp AC
Isolation		
tested with		
• 24 V DC circuits	707 V DC (type test)	707 V DC (type test)
• Interface	1 500 V; According to IEEE 802.3	1 500 V; According to IEEE 802.3
Degree and class of protection		
IP degree of protection	IP65/67	IP65/67
Connection method		
Design of electrical connection	4/5-pin M12 circular connectors	4/5-pin M12 circular connectors
Dimensions		
Width	60 mm	60 mm
Height	175 mm	175 mm
Depth	49 mm	49 mm
Weights		
Weight (without packaging)	930 g	930 g

Technical specifications (continued)

Article number	6ES7145-6HD00-0AB0 ET 200ECO PN, 4AO U/I 4XM12
General information	
Vendor identification (VendorID)	002AH
Device identifier (DeviceID)	0306H
Supply voltage	
Rated value (DC)	24 V
Reverse polarity protection	Yes
Input current	
Current consumption, typ.	280 mA
Actuator supply	
Number of outputs	4
Short-circuit protection	Yes; Electronic at 1.4 A
Output current	
• Rated value	1 A; Maximum
Power loss	
Power loss, typ.	5.5 W
Analog outputs	
Number of analog outputs	4
Voltage output, short-circuit protection	Yes
Voltage output, short-circuit current, max.	30 mA
Current output, no-load voltage, max.	20 V
Output ranges, voltage	
• 0 to 10 V	Yes
• 1 V to 5 V	Yes
• -10 V to +10 V	Yes
Output ranges, current	
• 0 to 20 mA	Yes
• -20 mA to +20 mA	Yes
• 4 mA to 20 mA	Yes
Connection of actuators	
• for voltage output two-wire connection	Yes
• for current output two-wire connection	Yes
Load impedance (in rated range of output)	
• with voltage outputs, min.	1 kΩ
• with voltage outputs, capacitive load, max.	1 μF
• with current outputs, max.	600 Ω
• with current outputs, inductive load, max.	1 mH
Destruction limits against externally applied voltages and currents	
• Voltages at the outputs towards MANA	28.8 V permanent, 35 V for max. 500 ms
Cable length	
• shielded, max.	30 m
Analog value generation for the outputs	
Analog value display	SIMATIC S7 format
Conversion principle	Resistor network
Integration and conversion time/resolution per channel	
• Resolution (incl. overrange)	15 bit + sign
• Conversion time (per channel)	1 ms

Article number	6ES7145-6HD00-0AB0 ET 200ECO PN, 4AO U/I 4XM12
Settling time	
• for resistive load	2 ms
• for capacitive load	1.8 ms
• for inductive load	2 ms
Errors/accuracies	
Output ripple (relative to output range, bandwidth 0 to 50 kHz), (+/-)	U: ±0.6 mVrms; I: ±0.4 nArms
Linearity error (relative to output range), (+/-)	0.02 %
Temperature error (relative to output range), (+/-)	U: 0.001%/°C; I: 0.0025%/°C
Crosstalk between the outputs, min.	70 dB
Repeat accuracy in steady state at 25 °C (relative to output range), (+/-)	0.008 %
Interfaces	
Transmission procedure	100BASE-TX
Number of PROFINET interfaces	1
PROFINET IO	
• Autocrossing	Yes
• automatic detection of transmission rate	Yes
• Transmission rate, max.	100 Mbit/s
• integrated switch	Yes
PROFINET IO Device	
- IRT with the option "high flexibility"	Yes
- Prioritized startup	Yes
Protocols	
Supports protocol for PROFINET IO	Yes
PROFINET CBA	No
PROFIsafe	No
Protocols (Ethernet)	
• TCP/IP	No
• SNMP	Yes
• DCP	Yes
• LLDP	Yes
• ping	Yes
• ARP	Yes
Interrupts/diagnostics/status information	
Status indicator	Yes
Diagnostic functions	Yes
Substitute values connectable	Yes
Alarms	
• Diagnostic alarm	Yes
Diagnostic messages	
• Diagnostic information readable	Yes
• Monitoring the supply voltage	Yes; Green "ON" LED
• Wire-break	Yes; Channel-by-channel with current output
• Short-circuit	Yes; Channel-by-channel with voltage output
• Group error	Yes; Red/yellow "SF/MT" LED

I/O systems

SIMATIC ET 200 systems without control cabinet

SIMATIC ET 200eco PN

Technical specifications (continued)

Article number	6ES7145-6HD00-0AB0 ET 200ECO PN, 4AO U/I 4XM12
Potential separation	
between the load voltages	Yes
between load voltage and all other switching components	No
between Ethernet and electronics	Yes
Potential separation analog outputs	
• between the channels	No
Permissible potential difference	
between M internally and the outputs	10 Vpp AC

Article number	6ES7145-6HD00-0AB0 ET 200ECO PN, 4AO U/I 4XM12
Isolation	
tested with	
• 24 V DC circuits	707 V DC (type test)
• Interface	1 500 V; According to IEEE 802.3
Degree and class of protection	
IP degree of protection	IP65/67
Connection method	
Design of electrical connection	4/5-pin M12 circular connectors
Dimensions	
Width	60 mm
Height	175 mm
Depth	49 mm
Weights	
Weight (without packaging)	930 g

Article number	6ES7148-6JA00-0AB0 ET 200ECO PN: IO-LINK MASTER	6ES7148-6JD00-0AB0 ET 200eco PN: IO-Link master
General information		
Vendor identification (VendorID)	002AH	002AH
Device identifier (DeviceID)	0306H	0306H
Supply voltage		
Rated value (DC)	24 V	24 V
Reverse polarity protection	Yes	Yes
Load voltage 2L+		
• Rated value (DC)	24 V	24 V
• Reverse polarity protection	Yes	Yes; against destruction; load increasing
Input current		
Current consumption, typ.	200 mA	100 mA
from supply voltage 1L+, max.	4 A	4 A
from load voltage 2L+, max.	4 A	4 A
Encoder supply		
Number of outputs	6	4
Short-circuit protection	Yes	Yes; per channel, electronic
Output current		
• Rated value	200 mA; 100 mA per output to X5-X6	500 mA; Per channel
Power loss		
Power loss, typ.	8 W	4.8 W
Digital inputs		
Number of digital inputs	8	
Input characteristic curve in accordance with IEC 61131, type 3	Yes	
Number of simultaneously controllable inputs		
all mounting positions		
- up to 60 °C, max.	8	
Input voltage		
• Rated value (DC)	24 V	
• for signal "0"	-3 to +5V	
• for signal "1"	+11 to +30V	
Input current		
• for signal "0", max. (permissible quiescent current)	1.5 mA	
• for signal "1", typ.	7 mA	

Technical specifications (continued)

Article number	6ES7148-6JA00-0AB0 ET 200ECO PN: IO-LINK MASTER	6ES7148-6JD00-0AB0 ET 200eco PN: IO-Link master
Input delay (for rated value of input voltage) for standard inputs		
- at "0" to "1", max.	typically 3 ms	
- at "1" to "0", max.	typically 3 ms	
Cable length		
• unshielded, max.	30 m	
Digital outputs		
Number of digital outputs	4	
Short-circuit protection	Yes; Electronic	
• Response threshold, typ.	1.8 A	
Limitation of inductive shutdown voltage to	Typ. (L1+, L2+) -47 V	
Controlling a digital input	Yes	
Switching capacity of the outputs		
• on lamp load, max.	5 W	
Output current		
• for signal "1" rated value	1.3 A; Maximum	
• for signal "0" residual current, max.	1.5 mA	
Parallel switching of two outputs		
• for uprating	No	
• for redundant control of a load	Yes	
Switching frequency		
• with resistive load, max.	100 Hz	
• with inductive load, max.	0.5 Hz	
• on lamp load, max.	1 Hz	
Total current of the outputs (per group) all mounting positions		
- up to 60 °C, max.	3.9 A	
Cable length		
• unshielded, max.	30 m	
IO-Link		
Number of ports	4	4
• of which simultaneously controllable	4	4
IO-Link protocol 1.0	Yes	Yes
IO-Link protocol 1.1		Yes
Transmission rate	4.8 kBd (COM1); 38.4 kBd (COM2)	4.8 kBaud (COM1); 38.4 kBaud (COM2), 230 kBaud (COM3)
Size of process data, input per port	32 byte	32 byte
Size of process data, input per module	32 byte	128 bytes + 4 bytes PQI
Size of process data, output per port	32 byte	32 byte
Size of process data, output per module	32 byte	128 byte
Memory size for device parameter		2 kbyte; for each port
Master backup		Possible with function block IO_LINK_MASTER
Configuration without S7-PCT		Possible; autostart function
Cable length unshielded, max.	20 m	20 m
Operating modes		
• IO-Link	Yes	Yes
• DI	Yes	Yes
• DQ	Yes	Yes; max. 100 mA
Connection of IO-Link devices		
• Port type A	Yes	Yes; via 3-core cable
• Port type B		Yes; Additional device supply: max. 2 A per port, max. 4 A per module
• via three-wire connection	Yes	

I/O systems

SIMATIC ET 200 systems without control cabinet

SIMATIC ET 200eco PN

Technical specifications (continued)

Article number	6ES7148-6JA00-0AB0 ET 200ECO PN: IO-LINK MASTER	6ES7148-6JD00-0AB0 ET 200eco PN: IO-Link master
Interfaces		
Transmission procedure	100BASE-TX	100BASE-TX
Number of PROFINET interfaces	1	1
PROFINET IO		
• Autocrossing	Yes	Yes
• automatic detection of transmission rate	Yes	Yes
• Transmission rate, max.	100 Mbit/s	100 Mbit/s
• integrated switch	Yes	Yes
PROFINET IO Device		
- IRT with the option "high flexibility"	Yes	Yes
Protocols		
Supports protocol for PROFINET IO	Yes	Yes
PROFINET CBA	No	No
PROFIsafe	No	No
Protocols (Ethernet)		
• SNMP	Yes	Yes
• DCP	Yes	Yes
• LLDP	Yes	Yes
• ping	Yes	Yes
• ARP	Yes	Yes
Interrupts/diagnostics/ status information		
Status indicator	Yes; Green LED	Yes; Green LED
Diagnostic functions	Yes	Yes
Alarms		
• Diagnostic alarm	Yes	Yes
Diagnostic messages		
• Diagnostic information readable	Yes	Yes
• Monitoring the supply voltage	Yes; Green "ON" LED	Yes; Green "ON" LED
• Wire-break in actuator cable	Yes	
• Wire-break in signal transmitter cable	Yes	
• Short-circuit	Yes	Yes; Device supply to M
• Short-circuit encoder supply	Yes	
• Group error	Yes; Red/yellow "SF/MT" LED	Yes; Red/yellow "SF/MT" LED
Potential separation		
between the load voltages	Yes	Yes
between load voltage and all other switching components	No	No
between Ethernet and electronics	Yes	Yes
Potential separation digital inputs		
• between the channels	No	
Potential separation digital outputs		
• between the channels	No	
Isolation		
tested with		
• 24 V DC circuits	707 V DC (type test)	707 V DC (type test)
• Interface	1 500 V; According to IEEE 802.3	1 500 V; According to IEEE 802.3
Degree and class of protection		
IP degree of protection	IP65/67	IP65/67
Connection method		
Design of electrical connection		3/5-pin M12 round connectors
Dimensions		
Width	60 mm	30 mm
Height	175 mm	200 mm
Depth	49 mm	49 mm
Weights		
Weight (without packaging)	910 g	550 g

Ordering data	Article No.	Article No.
ET 200eco PN digital input modules <ul style="list-style-type: none"> 8 DI 24 V DC; 4 x M12, dual assignment, IP67 degree of protection 8 DI 24 V DC; 8 x M12, IP67 degree of protection 16 DI 24 V DC; 8 x M12, dual assignment, IP67 degree of protection 	6ES7141-6BF00-0AB0 6ES7141-6BG00-0AB0 6ES7141-6BH00-0AB0	PROFINET M12 connector, for user assembly IE FC M12 PRO connector, for user assembly <ul style="list-style-type: none"> 1 unit 8 units
ET 200eco PN digital output modules <ul style="list-style-type: none"> 8 DO 24 V DC/0.5 A; 4 x M12, dual assignment, 1 load voltage supply DO; IP67 degree of protection 8 DO 24 V DC/1.3 A; 4 x M12, dual assignment, IP67 degree of protection 8 DO 24 V DC/1.3 A; 8 x M12, IP67 degree of protection 8 DO 24 V DC/2 A; 8 x M12, IP67 degree of protection 16 DO 24 V DC/1.3 A; 8 x M12, dual assignment, IP67 degree of protection 	6ES7142-6BF50-0AB0 6ES7142-6BF00-0AB0 6ES7142-6BG00-0AB0 6ES7142-6BR00-0AB0 6ES7142-6BH00-0AB0	PROFINET M12 connecting cables Pre-assembled connecting cables with 2 M12 connectors (D-coded) in various lengths: <ul style="list-style-type: none"> 0.3 m 0.5 m 1.0 m 1.5 m 2.0 m 3.0 m 5.0 m 10.0 m 15.0 m
ET 200eco PN digital input/output modules <ul style="list-style-type: none"> 8 DI/DO 24 V DC/1.3 A; 8 x M12, IP67 degree of protection 	6ES7147-6BG00-0AB0	M12 connector for 24 V DC load power supply Connection socket for 24 V DC incoming supply; 4-pin, A-coded, 3 units Connector for loop-through of 24 V DC; 4-pin, A-coded, 3 units
ET 200eco PN analog input modules <ul style="list-style-type: none"> 8 AI 4 U/I + 4 RTD/TC; 8 x M12, IP67 degree of protection 8 AI RTD/TC; 8 x M12, IP67 degree of protection 	6ES7144-6KD00-0AB0 6ES7144-6KD50-0AB0	M12 plug-in power cables Pre-assembled plug-in power cables, fitted at each end with M12 socket and plug 4 x 0.75 mm ² , in various lengths: <ul style="list-style-type: none"> 0.3 m 0.5 m 1.0 m 1.5 m 2.0 m 3.0 m 5.0 m 10.0 m 15.0 m
ET 200eco PN analog output modules <ul style="list-style-type: none"> 4 AO U/I; 4 x M12, IP67 degree of protection 	6ES7145-6HD00-0AB0	M12 coupler plug Can be assembled, for connecting actuators or sensors, 5-pin
ET 200eco PN IO-Link master modules <ul style="list-style-type: none"> 4 IO-L + 8 DI + 4 DO, 24 V DC/1.3 A; 8 x M12, IP67 degree of protection, enclosure width 60 mm; for connecting up to 4 IO-Link devices according to IO-Link Specification V1.0 and port Class A as well as 8 digital inputs and 4 digital outputs 4 IO-L; 4 x M12, IP67 degree of protection, enclosure width 30 mm; for connecting up to 4 IO-Link devices according to IO-Link Specification V1.0 and V1.1 and port Class B 	6ES7148-6JA00-0AB0 6ES7148-6JD00-0AB0	M12 Y cable For double connection of I/O by means of single cable to ET 200, 5-pin
Accessories <ul style="list-style-type: none"> PD voltage distributor, 24 V DC; 1 X 7/8", 4 X M12 Terminal block for ET 200eco PN, 10 A insulation displacement terminals Spare fuses for terminal block, 10 units DIN rail 0.5 m Profile screw for DIN rail, 50 units M12 sealing cap for IP67 modules, 10 units Labels 10 x 7 mm, pastel turquoise, 816 units 	6ES7148-6CB00-0AA0 6ES7194-6CA00-0AA0 6ES7194-6HB00-0AA0 6ES7194-6GA00-0AA0 6ES7194-6MA00-0AA0 3RX9802-0AA00 3RT1900-1SB10	

I/O systems

SIMATIC ET 200 systems without control cabinet

ET 200eco PN IO-Link master

Overview



The ET 200eco PN IO-Link master module is part of the ET 200eco PN compact block I/O range and is characterized by:

- Compact block I/O for connection to IO-Link devices and the PROFINET bus system
- Cabinet-free installation in IP67 degree of protection with M12 connection system
- Extremely rugged and resistant metal enclosure and casting
- Compact module with enclosure width of 30 mm or 60 mm
- PROFINET connection: 2 x M12 and automatic PROFINET address assignment
- 100 Mbps data transmission rate
- LLDP proximity detection without the need for a programming device
- Supply and load voltage connection: 2 x M12
- Channel-specific diagnostics

Technical specifications

Article number	6ES7148-6JA00-0AB0 ET 200ECO PN: IO-LINK MASTER	6ES7148-6JD00-0AB0 ET 200eco PN: IO-Link master
General information		
Vendor identification (VendorID)	002AH	002AH
Device identifier (DeviceID)	0306H	0306H
Supply voltage		
Rated value (DC)	24 V	24 V
Reverse polarity protection	Yes	Yes
Load voltage 2L+		
• Rated value (DC)	24 V	24 V
• Reverse polarity protection	Yes	Yes; against destruction; load increasing
Input current		
Current consumption, typ.	200 mA	100 mA
from supply voltage 1L+, max.	4 A	4 A
from load voltage 2L+, max.	4 A	4 A
Encoder supply		
Number of outputs	6	4
Short-circuit protection	Yes	Yes; per channel, electronic
Output current		
• Rated value	200 mA; 100 mA per output to X5-X6	500 mA; Per channel
Power loss		
Power loss, typ.	8 W	4.8 W
Digital inputs		
Number of digital inputs	8	
Input characteristic curve in accordance with IEC 61131, type 3	Yes	
Number of simultaneously controllable inputs		
all mounting positions		
- up to 60 °C, max.	8	
Input voltage		
• Rated value (DC)	24 V	
• for signal "0"	-3 to +5V	
• for signal "1"	+11 to +30V	
Input current		
• for signal "0", max. (permissible quiescent current)	1.5 mA	
• for signal "1", typ.	7 mA	
Input delay (for rated value of input voltage)		
for standard inputs		
- at "0" to "1", max.	typically 3 ms	
- at "1" to "0", max.	typically 3 ms	

Technical specifications (continued)

Article number	6ES7148-6JA00-0AB0 ET 200ECO PN: IO-LINK MASTER	6ES7148-6JD00-0AB0 ET 200eco PN: IO-Link master
Cable length		
• unshielded, max.	30 m	
Digital outputs		
Number of digital outputs	4	
Short-circuit protection	Yes; Electronic	
• Response threshold, typ.	1.8 A	
Limitation of inductive shutdown voltage to	Typ. (L1+, L2+) -47 V	
Controlling a digital input	Yes	
Switching capacity of the outputs		
• on lamp load, max.	5 W	
Output current		
• for signal "1" rated value	1.3 A; Maximum	
• for signal "0" residual current, max.	1.5 mA	
Parallel switching of two outputs		
• for uprating	No	
• for redundant control of a load	Yes	
Switching frequency		
• with resistive load, max.	100 Hz	
• with inductive load, max.	0.5 Hz	
• on lamp load, max.	1 Hz	
Total current of the outputs (per group)		
all mounting positions		
- up to 60 °C, max.	3.9 A	
Cable length		
• unshielded, max.	30 m	
IO-Link		
Number of ports	4	4
• of which simultaneously controllable	4	4
IO-Link protocol 1.0	Yes	Yes
IO-Link protocol 1.1		Yes
Transmission rate	4.8 kBd (COM1); 38.4 kBd (COM2)	4.8 kBaud (COM1); 38.4 kBaud (COM2), 230 kBaud (COM3)
Size of process data, input per port	32 byte	32 byte
Size of process data, input per module	32 byte	128 bytes + 4 bytes PQI
Size of process data, output per port	32 byte	32 byte
Size of process data, output per module	32 byte	128 byte
Memory size for device parameter		2 kbyte; for each port
Master backup		Possible with function block IO_LINK_MASTER
Configuration without S7-PCT		Possible; autostart function
Cable length unshielded, max.	20 m	20 m
Operating modes		
• IO-Link	Yes	Yes
• DI	Yes	Yes
• DQ	Yes	Yes; max. 100 mA
Connection of IO-Link devices		
• Port type A	Yes	Yes; via 3-core cable
• Port type B		Yes; Additional device supply: max. 2 A per port, max. 4 A per module
• via three-wire connection	Yes	

I/O systems

SIMATIC ET 200 systems without control cabinet

ET 200eco PN IO-Link master**Technical specifications** (continued)

Article number	6ES7148-6JA00-0AB0 ET 200ECO PN: IO-LINK MASTER	6ES7148-6JD00-0AB0 ET 200eco PN: IO-Link master
Interfaces		
Transmission procedure	100BASE-TX	100BASE-TX
Number of PROFINET interfaces	1	1
PROFINET IO		
• Autocrossing	Yes	Yes
• automatic detection of transmission rate	Yes	Yes
• Transmission rate, max.	100 Mbit/s	100 Mbit/s
• integrated switch	Yes	Yes
PROFINET IO Device		
- IRT with the option "high flexibility"	Yes	Yes
Protocols		
Supports protocol for PROFINET IO	Yes	Yes
PROFINET CBA	No	No
PROFIsafe	No	No
Protocols (Ethernet)		
• SNMP	Yes	Yes
• DCP	Yes	Yes
• LLDP	Yes	Yes
• ping	Yes	Yes
• ARP	Yes	Yes
Interrupts/diagnostics/ status information		
Status indicator	Yes; Green LED	Yes; Green LED
Diagnostic functions	Yes	Yes
Alarms		
• Diagnostic alarm	Yes	Yes
Diagnostic messages		
• Diagnostic information readable	Yes	Yes
• Monitoring the supply voltage	Yes; Green "ON" LED	Yes; Green "ON" LED
• Wire-break in actuator cable	Yes	
• Wire-break in signal transmitter cable	Yes	
• Short-circuit	Yes	Yes; Device supply to M
• Short-circuit encoder supply	Yes	
• Group error	Yes; Red/yellow "SF/MT" LED	Yes; Red/yellow "SF/MT" LED
Potential separation		
between the load voltages	Yes	Yes
between load voltage and all other switching components	No	No
between Ethernet and electronics	Yes	Yes
Potential separation digital inputs		
• between the channels	No	
Potential separation digital outputs		
• between the channels	No	
Isolation		
tested with		
• 24 V DC circuits	707 V DC (type test)	707 V DC (type test)
• Interface	1 500 V; According to IEEE 802.3	1 500 V; According to IEEE 802.3
Degree and class of protection		
IP degree of protection	IP65/67	IP65/67
Connection method		
Design of electrical connection		3/5-pin M12 round connectors
Dimensions		
Width	60 mm	30 mm
Height	175 mm	200 mm
Depth	49 mm	49 mm
Weights		
Weight (without packaging)	910 g	550 g

Ordering data	Article No.	Article No.
ET 200eco PN IO-Link master <ul style="list-style-type: none"> • 4 IO-L + 8 DI + 4 DO, 24 V DC/1.3 A; 8 x M12, IP67 degree of protection, enclosure width 60 mm; for connecting up to 4 IO-Link devices according to IO-Link Specification V1.0 and Port Class A as well as 8 digital inputs and 4 digital outputs • 4 IO-L; 4 x M12, IP67 degree of protection, enclosure width 30 mm; for connecting up to 4 IO-Link devices according to IO-Link Specification V1.0 and V1.1 and port Class B 	6ES7148-6JA00-0AB0 6ES7148-6JD00-0AB0	M12 connector for 24 V DC load power supply Connection socket for 24 V DC incoming supply; 4-pin, A-coded, 3 units Connector for loop-through of 24 V DC; 4-pin, A-coded, 3 units 6GK1907-0DC10-6AA3 6GK1907-0DB10-6AA3
Accessories <ul style="list-style-type: none"> • PD voltage distributor, 24 V DC; 1 X 7/8", 4 X M12 • Terminal block for ET 200eco PN, 10 A insulation displacement terminals • Spare fuses for terminal block, 10 units • DIN rail 0.5 m • Profile screw for DIN rail, 50 units • M12 sealing cap for IP67 modules, 10 units • Labels 10 x 7 mm, pastel turquoise, 816 units 	6ES7148-6CB00-0AA0 6ES7194-6CA00-0AA0 6ES7194-6HB00-0AA0 6ES7194-6GA00-0AA0 6ES7194-6MA00-0AA0 3RK1901-1KA00 3RT1900-1SB10	M12 plug-in power cables Pre-assembled plug-in power cables, fitted at each end with M12 socket and plug 4 x 0.75 mm ² , in various lengths: 0.3 m 0.5 m 1.0 m 1.5 m 2.0 m 3.0 m 5.0 m 10.0 m 15.0 m 6XV1801-5DE30 6XV1801-5DE50 6XV1801-5DH10 6XV1801-5DH15 6XV1801-5DH20 6XV1801-5DH30 6XV1801-5DH50 6XV1801-5DN10 6XV1801-5DN15
PROFINET M12 connector, for user assembly IE FC M12 PRO connector, for user assembly <ul style="list-style-type: none"> • 1 unit • 8 units 	6GK1901-0DB20-6AA0 6GK1901-0DB20-6AA8	M12 Y cable For double connection of I/O by means of single cable to ET 200, 5-pin 6ES7194-6KA00-0XA0
PROFINET M12 connecting cables Pre-assembled connecting cables with 2 M12 connectors (D-coded), in various lengths: 0.3 m 0.5 m 1.0 m 1.5 m 2.0 m 3.0 m 5.0 m 10.0 m 15.0 m	6XV1870-8AE30 6XV1870-8AE50 6XV1870-8AH10 6XV1870-8AH15 6XV1870-8AH20 6XV1870-8AH30 6XV1870-8AH50 6XV1870-8AN10 6XV1870-8AN15	

I/O systems

I/O systems for heating units

Introduction

Overview



SIPLUS HCS heating control systems: Industrial heating processes – maximum precision and efficiency

In manufacturing processes where temperature plays a crucial role, deviations of just a few degrees can cause enormous quality problems. To avoid this and to minimize rejection rates, high-precision and reliable, individual control of the electrical heating elements is essential.

Nearly all industrially manufactured products undergo heat treatment. Even small deviations in the heating process can result in enormous negative effects on product quality.

To increase the quality and quantity of a heat-treated product, it is important to be able to focus the energy required with the highest level of spatial and temporal precision. The SIPLUS HCS ensures utmost precision in the control of electric heating units such as infrared heaters.

Three heating control systems are available:

- With integrated power outputs – compact design
- With integrated power outputs – modular design
- Without integrated power outputs

The SIPLUS HCS family of heating control systems saves time, costs and resources when it comes to configuring, commissioning, operation and maintenance.

This is achieved by:

- Simple integration into existing automation systems such as SIMATIC and SIMOTION
- Lower wiring costs and user-friendly engineering
- Intelligent diagnostics options for swift fault detection
- Service-friendly design thanks to ready-to-use function and data blocks
- Reduced volume in the control cabinet with space savings of up to 50%

For more information, see <http://www.siemens.com/siplus-hcs>.

Overview



SIPLUS HCS3200 heating control system with fixing brackets

The SIPLUS HCS3200 heating control system was developed as a compact solution for controlling linear heat emitter arrays.

Thanks to the high IP65 degree of protection, it can be used independently of a control cabinet at a distributed location near the emitters.

There are two versions:

- HCS3200 fan: For controlling 9 emitters and 1 output for switching an external fan on/off
- HCS3200: With UL Recognized Component certification for controlling 9 emitters

Technical specifications

Article number	6BK1932-0BA00-0AA0 SIPLUS HCS3200 Fan	6BK1932-0AA00-0AA0 SIPLUS HCS3200
General information		
Product brand name	SIPLUS	
Product designation	HCS3200 Fan	HCS3200
Type of control of heat emitters	Half-wave control	
Installation type/mounting		
Mounting type	screw fixing	
Mounting position	vertical	
Type of ventilation	Self-ventilation	
Supply voltage		
Type of supply voltage	AC	
Rated value (AC)	400 V	
Relative negative tolerance	10 %	
Relative positive tolerance	10 %	
Line frequency		
• Rated value 1	50 Hz	
• Rated value 2	60 Hz	
• Relative symmetrical tolerance	5 %	
Resistance thermometer (RTD)		
• Design of electrical connection for supply voltage	Connector, 4-pole + PE	Connector, 2-pole + PE
- Connectable conductor cross-sections, finely stranded with wire end processing	3x (6 ... 25 mm ²) and 1x PE (6 ... 16 mm ²)	2x (6 ... 25 mm ²) and 1x PE (6 ... 16 mm ²)
- Connectable conductor cross-sections for AWG cables	3x (8 ... 4)	2x (8 ... 4)
Power supply for the electronics		
Design of the power supply	external	
Type of voltage	DC	
Supply voltage for electronics	24 V	
Relative symmetrical tolerance of the input voltage	20 %	
Input current		
Current consumption for the electronics, max.	0.25 A	

I/O systems

I/O systems for heating units
with integrated power outputs – compact design

SIPLUS HCS3200 heating control system

Technical specifications (continued)

Article number	6BK1932-0BA00-0AA0 SIPLUS HCS3200 Fan	6BK1932-0AA00-0AA0 SIPLUS HCS3200
Power electronics		
Type of load	Ohmic load	
Power capacity, max.	25.2 kW	
Switching capacity current per phase, max.	63 A	
Breaking capacity maximum short-circuit current (I _{cu}) at 400 V	25 kA	
Heating power		
• Number of digital outputs	9	
• Number of heat emitters per output, max.	1	
• Output voltage for heating power	400 V	
• Power carrying capacity per output, min.	200 W	
• Power carrying capacity per output, max.	4 000 W	
• Output current for heating power	10 A	
• Design of short-circuit protection per output	Fuse 16 A	Fuse 15 A
Fan control		
• Output voltage for fan	230 V	
• Power carrying capacity per output, min.	60 W	
• Power carrying capacity per output, max.	500 W	
• Design of short-circuit protection	Fuse 4 A	
Integration and conversion time/resolution per channel		
• Design of electrical connection at output for heating and fan	Connector, 20-pole + PE	
- Connectable conductor cross-sections, finely stranded with wire end processing	20x (1.5 ... 4 mm ²), 1x PE (1.5 ... 16 mm ²)	18x (1.5 ... 4 mm ²), 1x PE (1.5 ... 16 mm ²)
- Connectable conductor cross-sections for AWG cables, stranded	20x (18 ... 12)	18x (18 ... 12)
Interfaces		
Interfaces/bus type	PROFIBUS DP	
PROFIBUS DP		
• Transmission rate, max.	12 Mbit/s	
• Design of electrical connection of PROFIBUS interface	ECOFAST	
Protocols		
PROFIBUS DP	Yes	
Interrupts/diagnostics/status information		
Number of status displays	2	
LED status display	LED green = status indicator, LED red = fault indicator	
Diagnostics function	Voltage diagnostics	
Diagnostic messages		
• Wire-break	Yes	
• Fuse blown	Yes	
• Heat emitter defect	Yes	
Integrated Functions		
Monitoring functions		
• Temperature monitoring	Yes	
• Type of temperature monitoring	NTC thermistor	
Measuring functions		
• Voltage measurement	Yes	
Potential separation		
Design of electrical isolation between the outputs	Optocoupler between main circuit and PELV No	
Isolation		
Overvoltage category	III	

Technical specifications (continued)

Article number	6BK1932-0BA00-0AA0 SIPLUS HCS3200 Fan	6BK1932-0AA00-0AA0 SIPLUS HCS3200
EMC		
EMC interference emission	in accordance with IEC 61000-6-4:2007 + A1:2011	
Electrostatic discharge acc. to IEC 61000-4-2	4 kV contact discharge / 8 kV air discharge	
Field-related interference acc. to IEC 61000-4-3	10 V/m (80 ... 1 000 MHz), 3 V/m (1.4 ... 2.0 GHz), 1 V/m (2.0 ... 2.7 GHz)	
Conducted interference due to burst acc. to IEC 61000-4-4	2 kV power supply lines / 1 kV signal lines	
Conducted interference due to surge acc. to IEC 61000-4-5	On supply lines: 1 kV symmetrical, 2 kV asymmetrical, (24 V DC supply only with external protective measure) for PROFIBUS cable : asymmetrical 1 kV	
Conducted interference due to high-frequency radiation acc. to IEC 61000-4-6	10 V (0.15 ... 80 MHz)	
Degree and class of protection		
IP degree of protection	IP65	
Standards, approvals, certificates		
Certificate of suitability	CE	CE, UL
Degree of pollution	2	
Device tag according to DIN EN 81346-2	Q	
Ambient conditions		
Ambient temperature during operation		
• min.	0 °C	
• max.	50 °C	
Ambient temperature during storage/transportation		
• Storage, min.	-40 °C	
• Storage, max.	70 °C	
• Transportation, min.	-40 °C	
• Transportation, max.	70 °C	
Air pressure acc. to IEC 60068-2-13		
• Operation, min.	860 hPa	
• Operation, max.	1 080 hPa	
• Storage, min.	660 hPa	
• Storage, max.	1 080 hPa	
• Installation altitude above sea level, max.	2 000 m	
Relative humidity		
• at 25 °C, max.	95 %	
• Operation at 50 %, max.	50 %	
Vibrations		
• Vibration resistance during operation acc. to IEC 60068-2-6	10 ... 58 Hz / 0.15 mm, 58 ... 150 Hz / 1 g	
• Vibration resistance during storage acc. to IEC 60068-2-6	5 ... 9 Hz / 3.5 mm, 9 ... 500 Hz / 1 g	
Shock testing		
• Shock resistance acc. to IEC 60068-2-27	15 g / 11 ms / 3 shocks/axis	
• Shock resistance acc. to IEC 60068-2-29	25 g / 6 ms / 1 000 shocks/axis	
Dimensions		
Width	300 mm	
Height	380 mm	
Depth	200 mm	

Ordering data**SIPLUS HCS3200 heating control system**

SIPLUS HCS3200 fan
SIPLUS HCS3200 UL-certified

Article No.

6BK1932-0BA00-0AA0
6BK1932-0AA00-0AA0

Article No.**Accessories**

SIPLUS HCS3200 fan as spare part
Installation kit for wall mounting

6BK1932-6AA00-0AA0
6BK1932-6BA00-0AA0

I/O systems

I/O systems for heating units
with integrated power outputs – modular design

SIPLUS HCS4200 heating control system

Overview

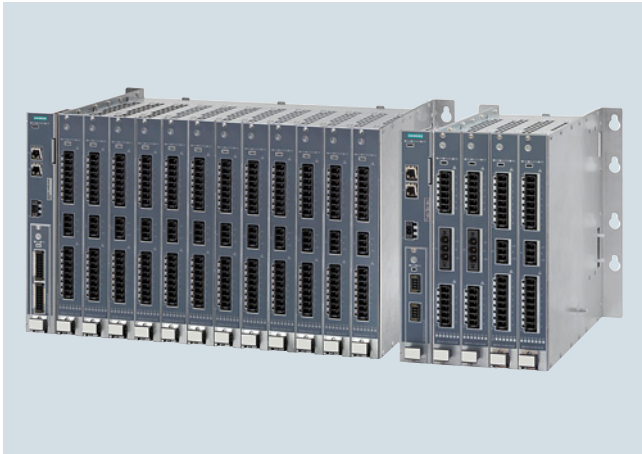

SIPLUS HCS4200 rack for 12/4 POMs

The SIPLUS HCS4200 heating control system controls and switches heat emitter arrays and other resistive loads in 230 V AC voltage supply systems in industrial environments.

Communication takes place via PROFINET, and together with the SIMATIC S7, SIMOTION or industrial PC, forms a modern and powerful automation system. The modular, compact and space-saving distributed I/O system can be adapted individually to suit the application.

Overview

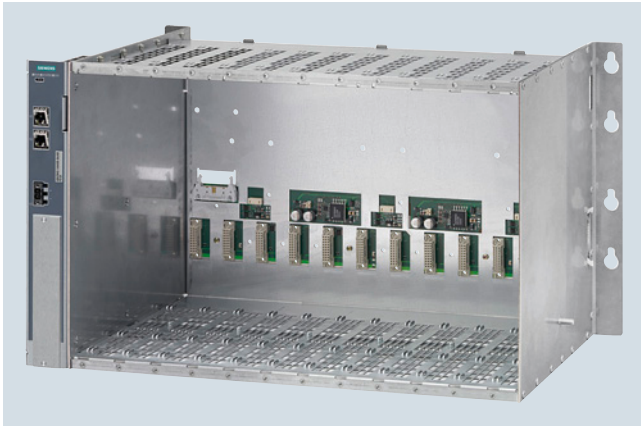

SIPLUS HCS4200 heating control system

The rack constitutes the basic mechanical structure of SIPLUS HCS4200.

Technical specifications

Article number	6BK1942-0AA00-0AA0	6BK1942-0BA00-0AA0
	HCS Rack4200 for 12 POM	HCS Rack4200 for 4 POM
General information		
Product brand name	SIPLUS	
Product designation	Rack4200 for 12 POMs	RACK4200 for 4 POMs
Installation type/mounting		
Mounting type	Control cabinet backplane	
Mounting position	Horizontal	
Type of ventilation	Self ventilation or forced ventilation	
Hardware configuration		
Type of power output connectable	POM4220	
Power capacity per rack with fan, max.	193 kW	64 kW
Power capacity per rack without fan, max.	88 kW	29 kW
Slots		
• Number of slots	12	4
Interfaces		
Interfaces/bus type	system interface	
EMC		
EMC interference emission	Limit value in accordance with IEC 61000-6-4:2007 + A1:2011	
Electrostatic discharge acc. to IEC 61000-4-2	4 kV contact discharge / 8 kV air discharge	
Field-related interference acc. to IEC 61000-4-3	10 V/m (80 ... 1 000 MHz), 3 V/m (1.4 ... 2.0 GHz), 1 V/m (2.0 ... 2.7 GHz)	
Degree and class of protection		
IP degree of protection	IP20	
Standards, approvals, certificates		
Degree of pollution	2	
Device tag according to DIN EN 81346-2	K	
Ambient conditions		
Ambient temperature during operation		
• min.	0 °C	
• max.	55 °C	
Ambient temperature during storage/transportation		
• Storage, min.	-25 °C	
• Storage, max.	70 °C	
• Transportation, min.	-25 °C	
• Transportation, max.	70 °C	

I/O systems

I/O systems for heating units
with integrated power outputs – modular design

SIPLUS HCS4200 heating control system > Rack

Technical specifications (continued)

Article number	6BK1942-0AA00-0AA0 HCS Rack4200 for 12 POM	6BK1942-0BA00-0AA0 HCS Rack4200 for 4 POM
Air pressure acc. to IEC 60068-2-13		
• Operation, min.	860 Pa	
• Operation, max.	1 080 Pa	
• Storage, min.	660 Pa	
• Storage, max.	1 080 Pa	
• Installation altitude above sea level, max.	2 000 m	
Relative humidity		
• Operation at 25 °C, max.	95 %	
• Operation at 50 °C, max.	50 %; 95 % at 25 °C, decreasing linearly to 50 % at 50 °C	
Vibrations		
• Vibration resistance during operation acc. to IEC 60068-2-6	10 ... 58 Hz / 0.075 mm, 58 ... 150 Hz / 1 g	
• Vibration resistance during storage acc. to IEC 60068-2-6	5 ... 8.5 Hz / 3.5 mm, 8.5 ... 500 Hz / 1 g	
Shock testing		
• Shock resistance during operation acc. to IEC 60068-2-27	15 g / 11 ms / 3 shocks/axis	
• Shock resistance during storage acc. to IEC 60068-2-29	25 g / 6 ms / 1 000 shocks/axis	
Dimensions		
Width	488 mm	204 mm
Height	285 mm	
Depth	293 mm	

Ordering data

	Article No.		Article No.
SIPLUS HCS4200 Rack for 12 POMs	6BK1942-0AA00-0AA0	Accessories	
Rack for accommodating up to 12 POM4320 power output modules		SIPLUS HCS4200 Fan Module	6BK1942-4AA00-0AA0
		Is attached to the top of the rack for accommodating up to 4 power output modules	
SIPLUS HCS4200 Rack for 4 POMs	6BK1942-0BA00-0AA0	Blanking cover (10 items)	6BK1942-6DA00-0AA0
Rack for accommodating up to 4 POM4320 power output modules		For covering unoccupied slots in the rack	

Overview

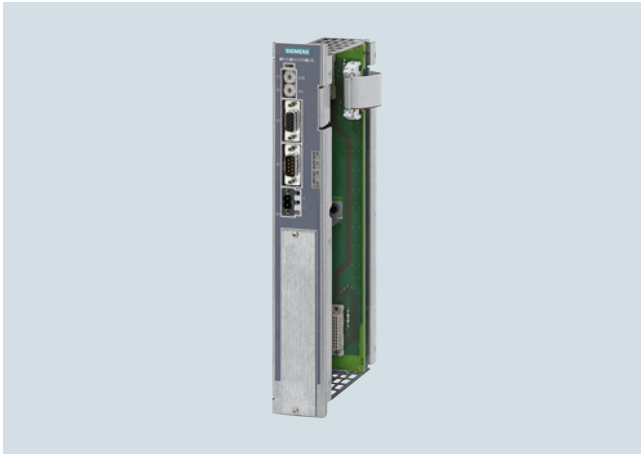

The Central Interface Module (CIM) is the intelligent processor module of the SIPLUS HCS4200 heating control system.

Technical specifications

Article number	6BK1942-1AA00-0AA0 HCS CIM4210 PROFINET	6BK1942-1BA00-0AA0 HCS CIM4210 PROFIBUS	6BK1942-1CA00-0AA0 HCS CIM4210 EtherNet/IP
General information			
Product brand name	SIPLUS		
Product designation	CIM4210 PROFINET	CIM4210 PROFIBUS	CIM4210 EtherNet/IP
Installation type/mounting			
Mounting type	Screw mounting to rack		
Mounting position	vertical		
Type of ventilation	Forced ventilation		
Supply voltage			
Type of supply voltage	DC		
Rated value (DC)	24 V		
Relative negative tolerance	20 %		
Relative positive tolerance	20 %		
Resistance thermometer (RTD)			
• Design of electrical connection for supply voltage	Connector 2x 2-pin with tension spring connection		
- Connectable conductor cross-sections, solid	1x (0.2 ... 2.5 mm ²)		
- Connectable conductor cross-sections, finely stranded with wire end processing	1x (0.2 ... 2.5 mm ²)		
- Connectable conductor cross-sections for AWG cables	1x (26 ... 12)		
Power			
Active power input	3 W		
Hardware configuration			
Type of power output connectable	POM4220		
Slots			
• Number of slots	1		
Interfaces			
Interfaces/bus type	PROFINET IO	PROFIBUS DP	EtherNet/IP
PROFINET IO			
• Transmission rate, max.	100 Mbit/s		
• Design of electrical connection of PROFINET interface	2 x RJ45		
PROFIBUS DP			
• Transmission rate, max.	12 Mbit/s		
• Design of electrical connection of PROFIBUS interface	9-pin sub D socket		
EtherNet/IP			
• Transmission rate, max.	100 Mbit/s		
• Design of EtherNet/IP interface electrical connection	2 x RJ45		

I/O systems

I/O systems for heating units
with integrated power outputs – modular design

SIPLUS HCS4200 heating control system > Central Interface Module (CIM)

Technical specifications (continued)

Article number	6BK1942-1AA00-0AA0 HCS CIM4210 PROFINET	6BK1942-1BA00-0AA0 HCS CIM4210 PROFIBUS	6BK1942-1CA00-0AA0 HCS CIM4210 EtherNet/IP
Protocols			
Supports protocol for PROFINET IO	Yes	No	
PROFIBUS DP	No	Yes	No
Further protocols			
• EtherNet/IP	No		Yes
Interrupts/diagnostics/ status information			
Number of status displays	3		
LED status display	LED green = ready, LED yellow = heating on/off, LED red = error display		
Isolation			
Overvoltage category	III		
EMC			
EMC interference emission	Limit value in accordance with IEC 61000-6-4:2007 + A1:2011		
Electrostatic discharge acc. to IEC 61000-4-2	4 kV contact discharging, 8 kV air discharging		
Field-related interference acc. to IEC 61000-4-3	10 V/m (80 ... 1 000 MHz), 3 V/m (1.4 ... 2.0 GHz), 1 V/m (2.0 ... 2.7 GHz)		
Conducted interference due to burst acc. to IEC 61000-4-4	2 kV power supply lines, 2 kV PROFINET cables	2 kV power supply lines / 2 kV PROFIBUS cables	2 kV power supply lines, 2 kV PROFINET cables
Conducted interference due to surge acc. to IEC 61000-4-5	DC supply lines: 0.5 kV symmetric and unsymmetric PROFINET cables: 1 kV unsymmetric	DC supply lines: 0.5 kV symmetrical and asymmetrical, PROFIBUS lines: 1 kV asymmetrical	DC supply lines: 0.5 kV symmetric and unsymmetric PROFINET cables: 1 kV unsymmetric
Conducted interference due to high-frequency radiation acc. to IEC 61000-4-6	10 V (0.15 ... 80 MHz)		
Degree and class of protection			
IP degree of protection	IP20		
Standards, approvals, certificates			
CE mark	Yes		
UL approval	Yes		
RCM (formerly C-TICK)	Yes		
KC approval	Yes		
EAC (formerly Gost-R)	Yes		
China RoHS compliance	Yes		
Degree of pollution	2		
Device tag according to DIN EN 81346-2	K		
Ambient conditions			
Ambient temperature during operation			
• min.	0 °C		
• max.	55 °C		
Ambient temperature during storage/transportation			
• Storage, min.	-25 °C		
• Storage, max.	70 °C		
• Transportation, min.	-25 °C		
• Transportation, max.	70 °C		
Air pressure acc. to IEC 60068-2-13			
• Operation, min.	860 hPa		
• Operation, max.	1 080 hPa		
• Storage, min.	660 hPa		
• Storage, max.	1 080 hPa		
• Installation altitude above sea level, max.	2 000 m		
Relative humidity			
• Operation at 25 °C, max.	95 %		
• Operation at 50 °C, max.	50 %; 95 % at 25 °C, decreasing linearly to 50 % at 50 °C		

Technical specifications (continued)

Article number	6BK1942-1AA00-0AA0 HCS CIM4210 PROFINET	6BK1942-1BA00-0AA0 HCS CIM4210 PROFIBUS	6BK1942-1CA00-0AA0 HCS CIM4210 EtherNet/IP
Vibrations			
• Vibration resistance during operation acc. to IEC 60068-2-6	10 ... 58 Hz / 0.075 mm, 58 ... 150 Hz / 1 g		
• Vibration resistance during storage acc. to IEC 60068-2-6	5 ... 8.5 Hz / 3.5 mm, 8.5 ... 500 Hz / 1 g		
Shock testing			
• Shock resistance during operation acc. to IEC 60068-2-27	15 g / 11 ms / 3 shocks/axis		
• Shock resistance during storage acc. to IEC 60068-2-29	25 g / 6 ms / 1 000 shocks/axis		
Dimensions			
Width	43 mm		
Height	285 mm		
Depth	136 mm		

Ordering data**Article No.****Article No.****SIPLUS HCS4200 CIM4210 PROFINET****6BK1942-1AA00-0AA0**

Central Interface Module with PROFINET communication

SIPLUS HCS4200 CIM4210 PROFIBUS**6BK1942-1BA00-0AA0**

Central Interface Module with PROFIBUS communication

SIPLUS HCS4200 CIM4210 Ethernet/IP**6BK1942-1CA00-0AA0**

Central Interface Module with EtherNet/IP

Accessories

SIPLUS HCS4200 connector set
As spare part, consisting of 20 x 2-pole connectors (24 V DC power supply)

6BK1942-6FA00-0AA0

SIPLUS HCS4000 temperature I/O module
For recording temperatures using temperature sensors, thermocouples and pyrometers

6BK1900-0AA00-0AA0

SIPLUS HCS4000 DI/DO I/O module
With 8 digital outputs and 8 configurable inputs/outputs

6BK1900-0BA00-0AA0

SIPLUS HCS4000 U/I I/O module
For current and voltage measurement (line voltage compensation)

6BK1900-0CA00-0AA0

I/O systems

I/O systems for heating units
with integrated power outputs – modular design

SIPLUS HCS4200 heating control system > Power Output Module (POM)

Overview



The Power Output Modules (POMs) are an essential component of the SIPLUS HCS4200 heating control system. Up to 24 power output modules can be operated on one CIM, split over two racks.

There are three power output module versions:

- POM4220 Low-end
- POM4220 Mid-range
- POM4220 Mid-range phase control

Technical specifications

Article number	6BK1942-2AA00-0AA0	6BK1942-2CA00-0AA0	6BK1942-2CA00-0AA1
General information			
Product brand name	SIPLUS		
Product designation	POM4220 Lowend	POM4220 Midrange	POM4220 mid-range phase control
Type of control of heat emitters	Half-wave control	Half-wave control and soft start	Half-wave control, phase control and soft start
Installation type/mounting			
Mounting type	Screw mounting to rack		
Mounting position	vertical		
Type of ventilation	Self ventilation or forced ventilation		
Supply voltage			
Type of supply voltage	AC		
Rated value (AC)	230 V	277 V	
Relative negative tolerance	10 %	25 %	
Relative positive tolerance	10 %	8 %	
Line frequency			
• Rated value 1	50 Hz		
• Rated value 2	60 Hz		
• Relative symmetrical tolerance	5 %		
Mains buffering			
• Recovery time after power failure, typ.	1 s		
Resistance thermometer (RTD)			
• Design of electrical connection for supply voltage	Connector, 3-pole with spring-loaded connection	Connector, 3-pin	
- Connectable conductor cross-sections, solid	1x (0.2 ... 10 mm ²)	1x (0.75 ... 16 mm ²)	
- Connectable conductor cross-sections, finely stranded with wire end processing	1x (0.25 ... 6 mm ²)	1x (0.75 ... 16 mm ²)	
- Connectable conductor cross-sections for AWG cables	1x (24 ... 8)	1x (18 ... 4)	
Power supply for the electronics			
Design of the power supply	Power supply via rack		
Power			
Active power input, max.	1 W		

Technical specifications (continued)

Article number	6BK1942-2AA00-0AA0	6BK1942-2CA00-0AA0	6BK1942-2CA00-0AA1
Power electronics			
Type of load	Ohmic load		
Power capacity, max.	16.1 kW	27.7 kW	
• for star connection with fan at 40 °C, max.	16.1 kW	27.7 kW	
• for star connection without fan at 40 °C, max.	7.3 kW	9 kW	
Switching capacity current per phase, max.	35 A	50 A	
Heating power			
• Number of digital outputs	16	12	
• Number of heat emitters per output, max.	1		
• Output voltage for heating power	230 V	277 V	
• Power carrying capacity per output, min.	100 W		
• Power carrying capacity per output, max.	1 449 W	3 324 W	4 432 W
- for heating elements with high inrush current, max.	750 W	1 600 W	
• Output current for heating power	6.3 A	12 A	16 A
• Melting I ² t value	57 A ² ·s	68 A ² ·s	120 A ² ·s
• Design of short-circuit protection per output	Safety fuse 6.3 A	Fuse 16 A	
• Design of overvoltage protection	Transil Diode		
Integration and conversion time/resolution per channel			
• Design of electrical connection at output for heating and fan	Connector, 8-pin with tension spring connection	Connector, 6-pole with spring-loaded connection	
- Connectable conductor cross-sections, solid	1x (0.2 ... 10 mm ²)		
- Connectable conductor cross-sections, finely stranded with wire end processing	1x (0.25 ... 6 mm ²)		
- Connectable conductor cross-sections for AWG cables, stranded	1x (24 ... 8)		
Interfaces			
Interfaces/bus type	system interface		
Interrupts/diagnostics/status information			
Number of status displays	19	15	
LED status display	LED green = ready, LED yellow = heating on/off, LED red = error display, LED red = error for each channel		
Diagnostics function	Voltage diagnostics		
Diagnostic messages			
• Wire-break	Yes		
• Fuse blown	Yes		
• Heat emitter defect	Yes		
Integrated Functions			
Monitoring functions			
• Temperature monitoring	Yes		
• Type of temperature monitoring	NTC thermistor		
Potential separation			
Design of electrical isolation between the outputs	Optocoupler and/or protective impedance between main circuit and PELV		
	No		
Isolation			
Overvoltage category	III		

I/O systems

I/O systems for heating units
with integrated power outputs – modular design

SIPLUS HCS4200 heating control system > Power Output Module (POM)

Technical specifications (continued)

Article number	6BK1942-2AA00-0AA0	6BK1942-2CA00-0AA0	6BK1942-2CA00-0AA1
EMC			
EMC interference emission	Limit value in accordance with IEC 61000-6-4:2007 + A1:2011		
Electrostatic discharge acc. to IEC 61000-4-2	4 kV contact discharge / 8 kV air discharge		
Field-related interference acc. to IEC 61000-4-3	10 V/m (80 ... 1 000 MHz), 3 V/m (1.4 ... 2.0 GHz), 1 V/m (2.0 ... 2.7 GHz)		
Conducted interference due to burst acc. to IEC 61000-4-4	2 kV power supply lines, 2 kV load lines		
Conducted interference due to surge acc. to IEC 61000-4-5	Supply and load lines: 1 kV symmetrical, 2 kV asymmetrical		
Conducted interference due to high-frequency radiation acc. to IEC 61000-4-6	10 V (0.15 ... 80 MHz)		
Degree and class of protection			
IP degree of protection	IP20		
Standards, approvals, certificates			
Degree of pollution	2		
Device tag according to DIN EN 81346-2	Q		
Ambient conditions			
Ambient temperature during operation			
• min.	0 °C		
• max.	55 °C		
Ambient temperature during storage/transportation			
• Storage, min.	-25 °C		
• Storage, max.	70 °C		
• Transportation, min.	-25 °C		
• Transportation, max.	70 °C		
Air pressure acc. to IEC 60068-2-13			
• Operation, min.	860 hPa		
• Operation, max.	1 080 hPa		
• Storage, min.	660 hPa		
• Storage, max.	1 080 hPa		
• Installation altitude above sea level, max.	2 000 m		
Relative humidity			
• Operation at 25 %, max.	95 %		
• Operation at 50 %, max.	50 %; 95 % at 25 °C, decreasing linearly to 50 % at 50 °C		
Vibrations			
• Vibration resistance during operation acc. to IEC 60068-2-6	10 ... 58 Hz / 0.075 mm, 58 ... 150 Hz / 1 g		
• Vibration resistance during storage acc. to IEC 60068-2-6	5 ... 8.5 Hz / 3.5 mm, 8.5 ... 500 Hz / 1 g		
Shock testing			
• Shock resistance during operation acc. to IEC 60068-2-27	15 g / 11 ms / 3 shocks/axis		
• Shock resistance during storage acc. to IEC 60068-2-29	25 g / 6 ms / 1 000 shocks/axis		
Dimensions			
Width	36 mm		
Height	285 mm		
Depth	281 mm		

I/O systems

I/O systems for heating units with integrated power outputs – modular design

SIPLUS HCS4200 heating control system > Power Output Module (POM)

Ordering data	Article No.	Accessories	Article No.
SIPLUS HCS4200 POM4220 Low-end Power output module with 16 outputs for connecting resistive loads	6BK1942-2AA00-0AA0	Spare fuse, 6.3 A/250 V, for POM4220 Low-end	6BK1942-6AA00-0AA0
SIPLUS HCS4200 POM4220 Mid-range Power output module with 12 outputs for connecting resistive loads	6BK1942-2CA00-0AA0	Spare fuse, 16 A/500 V, for the POM4220 Mid-range	6BK1942-6BA00-0AA0
SIPLUS HCS4200 POM4220 Mid-range phase control Power output module with 12 outputs for connecting resistive loads	6BK1942-2CA00-0AA1	Spare fuse, 16 A/500 V, for the POM4220 Mid-range	6BK1942-6HA00-0AA0
		SIPLUS HCS4200 connector set As accessory, comprising 10 con- nectors, 3-pin, for incoming supply, POM4220 Low-end	6BK1943-6AA00-0AA0
		SIPLUS HCS4200 connector set As accessory, comprising 5 con- nectors, 8-pin, for power outputs, POM4220 Low-end	6BK1942-6CA00-0AA0
		SIPLUS HCS4200 connector set As accessory, comprising 6 con- nectors, 3-pin, for incoming supply, POM4220 Mid-range	6BK1942-6GA00-0AA0
		SIPLUS HCS4200 connector set As accessory, comprising 5 con- nectors, 6-pin, for power outputs, POM4220 Mid-range	6BK1942-6EA00-0AA0

I/O systems

I/O systems for heating units
with integrated power outputs – modular design

SIPLUS HCS4300 heating control system

Overview



SIPLUS HCS4300 heating control systems

The SIPLUS HCS4300 heating control system controls and switches heat emitter arrays and other resistive loads in 400 V/480 V voltage supply systems in industrial environments.

Communication takes place via PROFINET and provides, together with the SIMATIC S7, for example, a highly modern and powerful automation system.

Overview



The Central Interface Module (CIM) is the intelligent processor module of the SIPLUS HCS4300 heating control system.

Technical specifications

Article number	6BK1943-1AA00-0AA0 HCS CIM4310 PROFINET	6BK1943-1BA00-0AA0 HCS CIM4310 PROFIBUS	6BK1943-1CA00-0AA0 HCS CIM4310 EtherNet/IP
General information			
Product brand name	SIPLUS		
Product designation	CIM4310 PROFINET	CIM4310 PROFIBUS	
Installation type/mounting			
Mounting type	Screw mounting to POM		
Mounting position	vertical		
Type of ventilation	Forced ventilation		
Supply voltage			
Type of supply voltage	DC		
Rated value (DC)	24 V		
Relative negative tolerance	20 %		
Relative positive tolerance	20 %		
Resistance thermometer (RTD)			
• Design of electrical connection for supply voltage	Connector 2x 2-pin with tension spring connection		
- Connectable conductor cross-sections, solid	1x (0.2 ... 2.5 mm ²)		
- Connectable conductor cross-sections, finely stranded with wire end processing	1x (0.2 ... 2.5 mm ²)		
- Connectable conductor cross-sections for AWG cables	1x (26 ... 12)		
Power			
Active power input	3 W		
Hardware configuration			
Type of power output connectable	POM4320		
Slots			
• Number of slots	1		
Interfaces			
Interfaces/bus type	PROFINET IO	PROFIBUS DP	EtherNet/IP
PROFINET IO			
• Transmission rate, max.	100 Mbit/s		
• Design of electrical connection of PROFINET interface	2 x RJ45		

I/O systems

I/O systems for heating units
with integrated power outputs – modular design

SIPLUS HCS4300 heating control system > Central Interface Module (CIM)

Technical specifications (continued)

Article number	6BK1943-1AA00-0AA0 HCS CIM4310 PROFINET	6BK1943-1BA00-0AA0 HCS CIM4310 PROFIBUS	6BK1943-1CA00-0AA0 HCS CIM4310 EtherNet/IP
PROFIBUS DP			
<ul style="list-style-type: none"> Transmission rate, max. Design of electrical connection of PROFIBUS interface 		12 Mbit/s 9-pin sub D socket	
EtherNet/IP			
<ul style="list-style-type: none"> Transmission rate, max. Design of EtherNet/IP interface electrical connection 			100 Mbit/s 2 x RJ45
Protocols			
Supports protocol for PROFINET IO	Yes	No	
PROFIBUS DP	No	Yes	No
Further protocols			
<ul style="list-style-type: none"> EtherNet/IP 			Yes
Interrupts/diagnostics/ status information			
Number of status displays	3		
LED status display	LED green = ready, LED yellow = heating on/off, LED red = error display		
Isolation			
Overvoltage category	III		
EMC			
EMC interference emission	Limit value in accordance with IEC 61000-6-4:2007 + A1:2011		
Electrostatic discharge acc. to IEC 61000-4-2	4 kV contact discharge / 8 kV air discharge		
Field-related interference acc. to IEC 61000-4-3	10 V/m (80 ... 1 000 MHz), 3 V/m (1.4 ... 2.0 GHz), 1 V/m (2.0 ... 2.7 GHz)		
Conducted interference due to burst acc. to IEC 61000-4-4	2 kV power supply lines, 2 kV PROFINET cables	2 kV power supply lines / 2 kV PROFIBUS cables	2 kV power supply lines, 2 kV PROFINET cables
Conducted interference due to surge acc. to IEC 61000-4-5	DC supply lines: 0.5 kV symmetric and unsymmetric PROFINET cables: 1 kV unsymmetric	DC supply lines: 0.5 kV symmetrical and asymmetrical, PROFIBUS lines: 1 kV asymmetrical	DC supply lines: 0.5 kV symmetric and unsymmetric PROFINET cables: 1 kV unsymmetric
Conducted interference due to high-frequency radiation acc. to IEC 61000-4-6	10 V (0.15 ... 80 MHz)		
Degree and class of protection			
IP degree of protection	IP20		
Standards, approvals, certificates			
Degree of pollution	2		
Device tag according to DIN EN 81346-2	K		
Ambient conditions			
Ambient temperature during operation			
<ul style="list-style-type: none"> min. max. 	0 °C 55 °C		
Ambient temperature during storage/transportation			
<ul style="list-style-type: none"> Storage, min. Storage, max. Transportation, min. Transportation, max. 	-25 °C 70 °C -25 °C 70 °C		
Air pressure acc. to IEC 60068-2-13			
<ul style="list-style-type: none"> Operation, min. Operation, max. Storage, min. Storage, max. Installation altitude above sea level, max. 	860 hPa 1 080 hPa 660 hPa 1 080 hPa 2 000 m		
Relative humidity			
<ul style="list-style-type: none"> Operation at 25 °C, max. Operation at 50 °C, max. 	95 % 50 %; 95 % at 25 °C, decreasing linearly to 50 % at 50 °C		

Technical specifications (continued)

Article number	6BK1943-1AA00-0AA0 HCS CIM4310 PROFINET	6BK1943-1BA00-0AA0 HCS CIM4310 PROFIBUS	6BK1943-1CA00-0AA0 HCS CIM4310 EtherNet/IP
Vibrations			
• Vibration resistance during operation acc. to IEC 60068-2-6	10 ... 58 Hz / 0.075 mm, 58 ... 150 Hz / 1 g		
• Vibration resistance during storage acc. to IEC 60068-2-6	5 ... 8.5 Hz / 3.5 mm, 8.5 ... 500 Hz / 1 g		
Shock testing			
• Shock resistance during operation acc. to IEC 60068-2-27	15 g / 11 ms / 3 shocks/axis		
• Shock resistance during storage acc. to IEC 60068-2-29	25 g / 6 ms / 1 000 shocks/axis		
Dimensions			
Width	56 mm		
Height	285 mm		
Depth	136 mm		

Ordering data

	Article No.		Article No.
SIPLUS HCS4300 CIM4310		SIPLUS HCS4000 temperature I/O module	6BK1900-0AA00-0AA0
Central Interface Module with PROFINET communication	6BK1943-1AA00-0AA0	For recording temperatures using temperature sensors, thermocouples and pyrometers	
Central Interface Module with PROFIBUS communication	6BK1943-1BA00-0AA0	SIPLUS HCS4000 DI/DO I/O module	6BK1900-0BA00-0AA0
Central Interface module with EtherNet/IP	6BK1943-1CA00-0AA0	With 8 digital outputs and 8 configurable inputs/outputs	
Accessories		SIPLUS HCS4000 U/I I/O module	6BK1900-0CA00-0AA0
SIPLUS HCS4300 EM4315	6BK1943-1AA50-0AA0	For current and voltage measurement (line voltage compensation)	
Expansion module for SIPLUS HCS4300, extends the configuration with 8 power output modules			

I/O systems

I/O systems for heating units
with integrated power outputs – modular design

SIPLUS HCS4300 heating control system > Power Output Module (POM)

Overview



- Module (encapsulated) in a metal enclosure
- 9 outputs for connecting resistive loads
- There are four versions:
 - POM4320 busbar mounting (IEC):
a current of up to 16 A can be used per output
 - POM4320 busbar mounting (UL):
a current of up to 15 A can be used per output
 - POM4320 rear panel mounting (IEC):
a current of up to 16 A can be used per output
 - POM4320 rear panel mounting (UL):
a current of up to 15 A can be used per output
- Connection of the phases via rear busbar adapter or connecting terminals
- Two-pole connection of heat emitters using mating connectors (mating connectors are included in the scope of supply!)
- Two fuses per output for supply and return line in a fuse module which can be plugged on and pulled off
- Heat dissipation by fan fitted to top of module
- Internal serial interface
- Three diagnostics LEDs for displaying module faults
- Nine diagnostics LEDs for displaying output errors

Technical specifications

Article number	6BK1943-2AA00-0AA0	6BK1943-2AA00-0AA2	6BK1943-2BA00-0AA0	6BK1943-2BA00-0AA2	6BK1943-2CA00-0AA0	6BK1943-2CA00-0AA2	6BK1943-2DA00-0AA0	6BK1943-2DA00-0AA2
	HCS POM4320 BUSBAR MOUNTING (IEC)	HCS POM4320 busbar mounting (IEC)	HCS POM4320 BUSBAR MOUNTING (UL)	HCS POM4320 busbar mounting (UL)	HCS POM4320 PANEL MOUNTING (IEC)	HCS POM4320 panel mounting (IEC)	HCS POM4320 PANEL MOUNTING (UL)	HCS POM4320 panel mounting (UL)
General information								
Product brand name	SIPLUS							
Product designation	POM4320 BUSBAR MOUNTING (IEC)		POM4320 BUSBAR MOUNTING (UL)		POM4320 rear panel mounting (IEC)		POM4320 rear panel mounting (UL)	
Type of control of heat emitters	Half-wave control and soft start							
Installation type/mounting								
Mounting type	Busbar mounting				Backplane mounting			
Mounting position	vertical							
Type of ventilation	Self-ventilation							
Supply voltage								
Type of supply voltage	AC							
Rated value (AC)	400 V							
Relative negative tolerance	10 %							
Relative positive tolerance	30 %							
Line frequency								
• Rated value 1	50 Hz							
• Rated value 2	60 Hz							
• Relative symmetrical tolerance	5 %							
Mains buffering								
• Recovery time after power failure, typ.	1 s							
Resistance thermometer (RTD)								
• Design of electrical connection for supply voltage	Busbar adapter, 3-pole + PE				Terminal, 3-pin			
- Connectable conductor cross-sections, solid					1x (1.5 ... 50 mm ²)			
- Connectable conductor cross-sections, finely stranded with wire end processing					1x (1.5 ... 35 mm ²)			
- Connectable conductor cross-sections for AWG cables					1x (16 ... 1)			
Power supply for the electronics								
Design of the power supply	Power supply via CIM							
Power								
Active power input, max.	8 W							

Technical specifications (continued)

Article number	6BK1943-2AA00-0AA0	6BK1943-2AA00-0AA2	6BK1943-2BA00-0AA0	6BK1943-2BA00-0AA2	6BK1943-2CA00-0AA0	6BK1943-2CA00-0AA2	6BK1943-2DA00-0AA0	6BK1943-2DA00-0AA2
	HCS POM4320 BUSBAR MOUNTING (IEC)	HCS POM4320 busbar mounting (IEC)	HCS POM4320 BUSBAR MOUNTING (UL)	HCS POM4320 busbar mounting (UL)	HCS POM4320 PANEL MOUNTING (IEC)	HCS POM4320 panel mounting (IEC)	HCS POM4320 PANEL MOUNTING (UL)	HCS POM4320 panel mounting (UL)
Power electronics								
Type of load	Ohmic load							
Power capacity, max.	69.1 kW		51.8 kW	64.8 kW	69.1 kW		51.8 kW	64.8 kW
• for delta connection with fan at 40 °C, max.	69.1 kW		51.8 kW	64.8 kW	69.1 kW		51.8 kW	64.8 kW
Switching capacity current per phase, max.	83 A		63 A	80 A	83 A		63 A	80 A
Short-time withstand current (SCCR) acc. to UL 508A			50 kA	100 kA			50 kA	100 kA
Heating power								
• Number of digital outputs	9							
• Number of heat emitters per output, max.	1							
• Output voltage for heating power	400 V							
• Power carrying capacity per output, min.	200 W							
• Power carrying capacity per output, max.	7 680 W		5 760 W	7 200 W	7 680 W		5 760 W	7 200 W
- for heating elements with high inrush current, max.	4 000 W		3 000 W	4 000 W			3 000 W	4 000 W
• Output current for heating power	16 A		12 A	15 A	16 A		12 A	15 A
• Peak current	150 A		100 A	150 A			100 A	150 A
• Melting I2t value	250 A ² ·s		225 A ² ·s	400 A ² ·s	250 A ² ·s		225 A ² ·s	400 A ² ·s
• Design of short-circuit protection per output	Fuse 16 A		Fuse 15 A	Melting fuse 20 A	Fuse 16 A		Fuse 15 A	Melting fuse 20 A
• Design of overvoltage protection	Transil Diode							
Integration and conversion time/resolution per channel								
• Design of electrical connection at output for heating and fan	Connector, 3-pole with spring-loaded connection							
- Connectable conductor cross-sections, solid	1x (0.2 ... 10 mm ²)							
- Connectable conductor cross-sections, finely stranded with wire end processing	1x (0.25 ... 6 mm ²)							
- Connectable conductor cross-sections for AWG cables, stranded	1x (24 ... 8)							
Interfaces								
Interfaces/bus type	system interface							
Interrupts/diagnostics/status information								
Number of status displays	12							
LED status display	LED green = ready, LED yellow = heating on/off, LED red = error display, LED red = error for each channel							
Diagnostics function	Voltage diagnostics							
Diagnostic messages								
• Wire-break	Yes							
• Fuse blown	Yes							
• Heat emitter defect	Yes							
Integrated Functions								
Monitoring functions								
• Temperature monitoring	Yes							
• Type of temperature monitoring	NTC thermistor							
Measuring functions								
• Voltage measurement	Yes							
Potential separation								
Design of electrical isolation between the outputs	Optocoupler and/or protective impedance between main circuit and PELV No							
Isolation								
Overvoltage category	III							

I/O systems

I/O systems for heating units
with integrated power outputs – modular design

SIPLUS HCS4300 heating control system > Power Output Module (POM)

Technical specifications (continued)

Article number	6BK1943-2AA00-0AA0	6BK1943-2AA00-0AA2	6BK1943-2BA00-0AA0	6BK1943-2BA00-0AA2	6BK1943-2CA00-0AA0	6BK1943-2CA00-0AA2	6BK1943-2DA00-0AA0	6BK1943-2DA00-0AA2
	HCS POM4320 BUSBAR MOUNTING (IEC)	HCS POM4320 busbar mounting (IEC)	HCS POM4320 BUSBAR MOUNTING (UL)	HCS POM4320 busbar mounting (UL)	HCS POM4320 PANEL MOUNTING (IEC)	HCS POM4320 panel mounting (IEC)	HCS POM4320 PANEL MOUNTING (UL)	HCS POM4320 panel mounting (UL)
EMC								
EMC interference emission	Limit value in accordance with IEC 61000-6-4:2007 + A1:2011							
Electrostatic discharge acc. to IEC 61000-4-2	4 kV contact discharge / 8 kV air discharge							
Field-related interference acc. to IEC 61000-4-3	10 V/m (80 ... 1 000 MHz), 3 V/m (1.4 ... 2.0 GHz), 1 V/m (2.0 ... 2.7 GHz)							
Conducted interference due to burst acc. to IEC 61000-4-4	2 kV power supply lines, 2 kV load lines							
Conducted interference due to surge acc. to IEC 61000-4-5	on supply and load lines: 1 kV symmetric, 2 kV unsymmetric							
Conducted interference due to high-frequency radiation acc. to IEC 61000-4-6	10 V (0.15 ... 80 MHz)							
Degree and class of protection								
IP degree of protection	IP20							
Standards, approvals, certificates								
Degree of pollution	2							
Device tag according to DIN EN 81346-2	Q							
Ambient conditions								
Ambient temperature during operation								
• min.	0 °C							
• max.	55 °C							
Ambient temperature during storage/transportation								
• Storage, min.	-25 °C							
• Storage, max.	70 °C							
• Transportation, min.	-25 °C							
• Transportation, max.	70 °C							
Air pressure acc. to IEC 60068-2-13								
• Operation, min.	860 hPa							
• Operation, max.	1 080 hPa							
• Storage, min.	660 hPa							
• Storage, max.	1 080 hPa							
• Installation altitude above sea level, max.	2 000 m							
Relative humidity								
• Operation at 25 °C, max.	95 %							
• Operation at 50 °C, max.	50 %; 95 % at 25 °C, decreasing linearly to 50 % at 50 °C							
Vibrations								
• Vibration resistance during operation acc. to IEC 60068-2-6	10 ... 58 Hz / 0.075 mm, 58 ... 150 Hz / 1 g							
• Vibration resistance during storage acc. to IEC 60068-2-6	5 ... 8.5 Hz / 3.5 mm, 8.5 ... 500 Hz / 1 g							
Shock testing								
• Shock resistance during operation acc. to IEC 60068-2-27	15 g / 11 ms / 3 shocks/axis							
• Shock resistance during storage acc. to IEC 60068-2-29	25 g / 6 ms / 1 000 shocks/axis							
Dimensions								
Width	104 mm							
Height	340 mm							
Depth	250 mm							
	344 mm							
	217 mm							

Ordering data	Article No.	Accessories	Article No.
SIPLUS HCS4300 POM4320			
Power Output Module with 9 outputs for connecting resistive loads		SIPLUS HCS4300 connecting cable from POM to POM	
IEC, busbar mounting	6BK1943-2AA00-0AA0	<ul style="list-style-type: none"> • Consisting of 10 items, 10 cm long • Consisting of 10 items, 25 cm long 	6BK1943-5AA00-0AA0 6BK1943-5BA00-0AA0
IEC, busbar mounting, redesign version with enhanced interference immunity	6BK1943-2AA00-0AA2	SIPLUS HCS4300 connector set	6BK1943-6AA00-0AA0
UL, busbar mounting	6BK1943-2BA00-0AA0	<ul style="list-style-type: none"> • Consisting of 10 x 3-pole connectors 	
UL, busbar mounting, redesign version with enhanced interference immunity and 100 kA SCCR	6BK1943-2BA00-0AA2	Spare fuse, 16 A/500 V, for POM4320	6BK1943-6BA00-0AA0
IEC, real panel mounting	6BK1943-2CA00-0AA0	Fan as spare part	6BK1700-2GA00-0AA0
IEC, rear panel mounting, redesign version with enhanced interference immunity	6BK1943-2CA00-0AA2		
UL, rear panel mounting	6BK1943-2DA00-0AA0		
UL, rear panel mounting, redesign version with enhanced interference immunity and 100 kA SCCR	6BK1943-2DA00-0AA2		

I/O systems

PROFIBUS components

Power Rail Booster

Overview



- The device for low-cost PROFIBUS DP transfer over contact conductors and slip rings to IP20 degree of protection
- Permissible baud rates from 9600 bit/s to 500 Kbps, self-optimizing
- Permissible busbar length:
From 25 m at 500 Kbps to 1200 m at 9600 bit/s
- Configuring with PRB Checker software
- Up to 125 nodes per segment
- Transparent for data communication:
The Power Rail Booster does not reserve DP addresses
- Easy to install due to connection without terminating resistor and filter element
- Diagnostics LED for power supply, bus activity and group errors
- Isolated electronic changeover contact for external group error display or diagnostic alarm
- Uninterruptible communication beyond segment limits using the "PRB segment controller"

Technical specifications

Degree of protection	IP20
Dimensions (W x H x D, with connector) in mm	90 x 132 x 75
Supply voltage	24 V DC
Power consumption	max. 20 W
Data transmission rate, max.	500 Kbps, self-adjusting
Cable length (depends on baud rate), max.	1200 m
Shock-hazard protected voltage	Yes, to EN 61131-2
Stations per PRB segment, max.	125
Operation without terminating resistance	Yes
Operation without filter	Yes
Wiring options: Line / star	Yes / Yes

Ordering data

Article No.

Power Rail Booster

Signal amplifier for PROFIBUS DP transmission over contact cables, max. 500 Kbps

6ES7972-4AA02-0XA0

PRB segment controller

Automatic change over switch between PRB segments

6ES7972-4AA50-0XA0

Overview

- RS 485 repeater with online line diagnostics for PROFIBUS DP
- PROFIBUS DP standard slave (DP-V1)
- Automatic determination of fault types and locations
- Data transmission rate 9.6 Kbps to 12 Mbps
- Connection through FastConnect using IDC

Technical specifications

Article number	6ES7972-0AB01-0XA0 SIMATIC S7, DIAGNOSIS-REPEATER
Supply voltage	
Rated value (DC)	24 V
permissible range, lower limit (DC)	20.4 V
permissible range, upper limit (DC)	28.8 V
Interfaces	
PROFIBUS DP	
• Transmission rate, max.	12 Mbit/s; 9.6 kbit/s to 12 Mbit/s
Degree and class of protection	
Degree of protection acc. to EN 60529	Yes
• IP20	

Article number	6ES7972-0AB01-0XA0 SIMATIC S7, DIAGNOSIS-REPEATER
Ambient conditions	
Ambient temperature during operation	
• min.	0 °C
• max.	60 °C
Ambient temperature during storage/transportation	
• min.	-40 °C
• max.	70 °C
Relative humidity	
• Operation, max.	95 %; at 25 °C
Connection method	
Power supply	Terminal block
Bus cables	FastConnect insulation displacement, 10 clamping cycles possible
Dimensions	
Width	80 mm
Height	125 mm
Depth	67.5 mm
Weights	
Weight, approx.	300 g

I/O systems

PROFIBUS components

Diagnostics

Diagnostics repeater for PROFIBUS DP

Ordering data	Article No.	Ordering data	Article No.
RS 485 diagnostics repeater For connection of 1 or 2 segments to PROFIBUS DP; with online diagnostics functions for monitoring the bus lines	6ES7972-0AB01-0XA0	PROFIBUS FastConnect RS 485 bus connector with angular cable outlet (35°) With insulation displacement terminals, max. transfer rate 12 Mbps <ul style="list-style-type: none"> • Without PG interface • With PG interface 	6ES7972-0BA61-0XA0 6ES7972-0BB61-0XA0
Accessories		PROFIBUS FastConnect stripping tool Preadjusted stripping tool for fast stripping of PROFIBUS FastConnect bus cables	6GK1905-6AA00
RS 485 bus connector with 90° cable outlet With screw terminals, max. transfer rate 12 Mbps <ul style="list-style-type: none"> • Without PG interface • With PG interface 	6ES7972-0BA12-0XA0 6ES7972-0BB12-0XA0	PROFIBUS FC standard cable Standard type with special design for quick mounting, 2-core, shielded, sold by the meter, max. delivery unit 1000 m, minimum order quantity 20 m	6XV1830-0EH10
PROFIBUS FastConnect RS 485 bus connector with 90° cable outlet With insulation displacement terminals, max. transfer rate 12 Mbps Without PG interface <ul style="list-style-type: none"> • 1 unit • 100 units With PG interface <ul style="list-style-type: none"> • 1 unit • 100 units without PG interface, grounding via control cabinet cover <ul style="list-style-type: none"> • 1 unit with PG interface, grounding via control cabinet cover <ul style="list-style-type: none"> • 1 unit 	6ES7972-0BA52-0XA0 6ES7972-0BA52-0XB0 6ES7972-0BB52-0XA0 6ES7972-0BB52-0XB0 6ES7972-0BA70-0XA0 6ES7972-0BB70-0XA0	S7 Manual Collection Electronic manuals on DVD, multilingual: S7-200, TD 200, S7-300, M7-300, C7, S7-400, M7-400, STEP 7, Engineering Tools, Runtime Software, SIMATIC DP (Distributed I/O), SIMATIC HMI (Human Machine Interface), SIMATIC NET (Industrial Communication)	6ES7998-8XC01-8YE0
RS 485 bus connector with angled cable outlet (35°) With screw terminals, max. transfer rate 12 Mbps <ul style="list-style-type: none"> • Without PG interface • With PG interface 	6ES7972-0BA42-0XA0 6ES7972-0BB42-0XA0	S7 Manual Collection update service for 1 year Scope of delivery: Current DVD "S7 Manual Collection" and the three subsequent updates	6ES7998-8XC01-8YE2
		Connecting cable for PROFIBUS 12 Mbps, for PG connection to PROFIBUS DP, pre-assembled with 2 x 9-pin sub D plug, 3.0 m	6ES7901-4BD00-0XA0

Overview

- RS 485 repeater with online line diagnostics for PROFIBUS DP
- PROFIBUS DP standard slave (DP-V1)
- Automatic determination of fault type and location
- Transmission rate from 9.6 Kbps to 12 Mbps
- Connection via FastConnect IDC

Note:

SIPLUS extreme products are based on SIMATIC standard products. The contents listed here were taken from the respective standard products. SIPLUS extreme-specific information was added.

SIPLUS diagnostics repeater for PROFIBUS DP

Article No.	6AG1972-0AB01-4XA0
BasedOn Article No.	6ES7972-0AB01-0XA0
Ambient temperature range	0 °C ... +60 °C
Conformal coating	Coating of the printed circuit boards and the electronic components.
Technical specifications	The technical data of the standard product applies except for the ambient conditions.
Ambient conditions	
Relative humidity	100%, condensation/frost permissible. No commissioning if condensation present.
Biologically active substances, compliance with EN 60721-3-3	Class 3B2 mold and fungal spores (excluding fauna). The supplied plug covers must remain in place over the unused interfaces during operation!
Chemically active substances, compliance with EN 60721-3-3	Class 3C4 incl. salt spray in accordance with EN60068-2-52 (degree of severity 3). The supplied plug covers must remain in place over the unused interfaces during operation!
Mechanically active substances, compliance with EN 60721-3-3	Class 3S4 incl. sand, dust. The supplied plug covers must remain in place over the unused interfaces during operation!
Air pressure (depending on the highest positive temperature range specified)	1 080 ... 795 hPa (-1 000 ... +2 000m) See ambient temperature range 795 ... 658 hPa (+2 000 ... +3 500m) Derating 10 K 658 ... 540 hPa (+3 500 ... +5 000 m) Derating 20 K

For technical documentation on SIPLUS, see:

<http://www.siemens.com/siplus-extreme>

Technical specifications

Article number	6AG1972-0AB01-4XA0
Based on	6ES7972-0AB01-0XA0 SIPLUS diagnostics repeater for PROFIBUS
Supply voltage	
Rated value (DC)	24 V
permissible range, lower limit (DC)	20.4 V
permissible range, upper limit (DC)	28.8 V
Interfaces	
PROFIBUS DP	
• Transmission rate, max.	12 Mbit/s; 9.6 kbit/s to 12 Mbit/s
Degree and class of protection	
Degree of protection acc. to EN 60529	
• IP20	Yes
Ambient conditions	
Ambient temperature during operation	
• min.	0 °C
• max.	60 °C
Ambient temperature during storage/transportation	
• min.	-40 °C
• max.	70 °C

Article number	6AG1972-0AB01-4XA0
Based on	6ES7972-0AB01-0XA0 SIPLUS diagnostics repeater for PROFIBUS
Connection method	
Power supply	Terminal block
Bus cables	FastConnect insulation displacement, 10 clamping cycles possible
Dimensions	
Width	80 mm
Height	125 mm
Depth	67.5 mm
Weights	
Weight, approx.	300 g

I/O systems

PROFIBUS components

Diagnostics

SIPLUS diagnostics repeater for PROFIBUS

Ordering data	Article No.	Accessories	Article No.
<p>SIPLUS RS 485 diagnostics repeater</p> <p>To connect up to 2 segments to PROFIBUS DP, with online diagnostics functions for monitoring the bus lines</p> <p>Exposure to media</p>	<p>6AG1972-0AB01-4XA0</p>	<p>RS 485 bus connector with 90° cable outlet</p> <p>Max. transfer rate 12 Mbps</p> <p>Extended temperature range and exposure to media</p> <ul style="list-style-type: none"> • without PG interface • with PG interface <p>RS 485 bus connector with angled cable outlet</p> <p>(Extended temperature range -40 °C ... +70 °C and exposure to media)</p> <p>Max. transfer rate 12 Mbps</p> <ul style="list-style-type: none"> • without PG interface • with PG interface <p>Additional accessories</p>	<p style="text-align: center; vertical-align: middle;"> 6AG1972-0BA12-2XA0 6AG1972-0BB12-2XA0 6AG1972-0BA42-7XA0 6AG1972-0BB42-7XA0 </p> <p>See SIMATIC RS 485 diagnostics repeater, page 9/358</p>

Overview

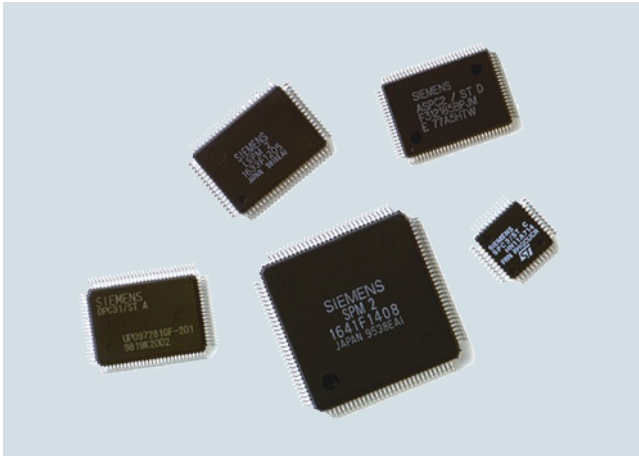

- Easy connection of field devices to PROFIBUS
- Integrated low-power management
- Different ASICs for the different functional requirements and application areas

Technical specifications

	LSPM 2	SPC 3	SPC 3LV	DPC 31
Protocol	PROFIBUS DP	PROFIBUS DP	PROFIBUS DP	PROFIBUS DP, PROFIBUS PA
Application range	simple slave application	intelligent slave application	intelligent slave application	intelligent slave application
Transmission rate, max.	12 Mbps	12 Mbps	12 Mbps	12 Mbps
Bus access	in ASIC	in ASIC	in ASIC	in ASIC
Automatic determination of transmission rate	yes	yes	yes	yes
Microprocessor required	no	yes	yes	integrated
Scope of firmware	not required	6 to 24 KB	6 to 24 KB	approx. 38 KB
Message buffer	-	1.5 KB	1.5 KB	6 KB
Power supply	5 V DC	5 V DC	3.3 V DC	3.3 V DC
Power loss, max.	0.35 W	0.5 W	<0.5 W	0.2 W
Permissible ambient temperature	-40 °C ... +75 °C	-40 °C ... +85 °C	-40 °C ... +85 °C	-40 °C ... +85 °C
Housing	MQFP, 80-pin	PQFP, 44-pin	PQFP, 44-pin	PQFP, 100-pin
Frame size	4 cm ²	2 cm ²	2 cm ²	4 cm ²
Delivery quantities (pcs.)	6/66/330/4950	6/96/750/960/4800	5/160/800/1000/4800	STEP B: 6/60/300/5100 STEP C1: 6/66/660/4620

	SPC 4-2	ASPC 2	SIM 1-2	FOCSI
Protocol	PROFIBUS DP PROFIBUS FMS PROFIBUS PA	PROFIBUS DP PROFIBUS FMS PROFIBUS PA	PROFIBUS PA	-
Application range	Intelligent slave application	Master application	Medium Attachment	Medium Management Unit
Transmission rate, max.	12 Mbps	12 Mbps	31.25 Kbps	12 Mbps
Bus access	in ASIC	in ASIC	-	-
Automatic determination of transmission rate	yes	yes	-	-
Microprocessor required	yes	yes	-	-
Scope of firmware	3 ... 30 KB	80 KB	not required	not required
Message buffer	3 KB	1 MB (external)	-	-
Voltage supply	5 V DC, 3.3 V	5 V DC	via bus	3.3 V DC
Power loss, max.	0.6 W at 5V 0.01 W at 3.3 V	0.9 W	0.05 W	0.75 W
Permissible ambient temperature	-40 °C ... +85 °C	-40 °C ... +85 °C	-40 °C ... +85 °C	-40 °C ... +85 °C
Housing	TQFP, 44-pin	P-MQFP, 100-pin	MLPQ, 40-pin	TQFP, 44-pin
Frame size	2 cm ²	4 cm ²	36 mm ²	2 cm ²
Delivery quantities (pcs.)	5/160	6/66/660/4620	30/60/1000	40

I/O systems

PROFIBUS components

PROFIBUS DP ASICs

Ordering data	Article No.	Article No.	
ASIC ASPC 2 For constructing master interfaces (quantity discount) <ul style="list-style-type: none"> • 6 units (lead-free) • 66 units (lead-free) • 660 units (lead-free) • 4620 units (lead-free) 	6ES7195-0AA05-0XA0 6ES7195-0AA15-0XA0 6ES7195-0AA25-0XA0 6ES7195-0AA35-0XA0	ASIC DPC 31 STEP C1 For constructing intelligent DP slave interfaces (quantity discount) <ul style="list-style-type: none"> • 6 units (lead-free) • 66 units (lead-free) • 660 units (lead-free) • 4620 units (lead-free) 	6ES7195-0BF02-0XA0 6ES7195-0BF12-0XA0 6ES7195-0BF22-0XA0 6ES7195-0BF32-0XA0
ASIC LSPM 2 For constructing simple slave interfaces (quantity discount) <ul style="list-style-type: none"> • 6 units (lead-free) • 66 units (lead-free) • 330 units (lead-free) • 4950 units (lead-free) 	6ES7195-0BA02-0XA0 6ES7195-0BA12-0XA0 6ES7195-0BA22-0XA0 6ES7195-0BA32-0XA0	ASIC SPC 4-2 For constructing intelligent DP slave interfaces (quantity discount) <ul style="list-style-type: none"> • 5 units for laboratory development (lead-free) • 160 units (lead-free, 1 tray) 	6GK1588-3AA00 6GK1588-3AA15
ASIC SPC 3 For constructing intelligent DP slave interfaces (quantity discount) <ul style="list-style-type: none"> • 6 units (lead-free) • 96 units (lead-free) • 960 units (lead-free) • 4800 units (lead-free) • 750 units (lead-free) (tape & reel) 	6ES7195-0BD04-0XA0 6ES7195-0BD14-0XA0 6ES7195-0BD24-0XA0 6ES7195-0BD34-0XA0 6ES7195-0BD44-0XA0	ASIC SIM 1-2 For connection according to IEC H1 for PROFIBUS PA with a transmission rate of 31.25 Kbps <ul style="list-style-type: none"> • 60 units (in tube) • 1000 units (tape & reel) 	6GK1588-3BB02 6GK1588-3BB21
ASIC SPC 3LV For constructing intelligent DP slave interfaces (quantity discount) <ul style="list-style-type: none"> • 5 units (lead-free) • 160 units (lead-free) • 800 units (lead-free) • 4800 units (lead-free) • 1000 units (lead-free) (tape & reel) 	6ES7195-0BG00-0XA0 6ES7195-0BG10-0XA0 6ES7195-0BG20-0XA0 6ES7195-0BG30-0XA0 6ES7195-0BG40-0XA0	Accessories Firmware for Siemens ASIC SPC 3 <ul style="list-style-type: none"> • DP firmware • DP-V1 firmware • DP-V1 firmware upgrade 	6ES7195-2BA00-0XA0 6ES7195-2BA01-0XA0 6ES7195-2BA02-0XA0
ASIC DPC 31 STEP B For constructing intelligent DP slave interfaces (quantity discount) <ul style="list-style-type: none"> • 6 units (lead-free) • 60 units (lead-free) • 300 units (lead-free) • 5100 units (lead-free) 	6ES7195-0BE02-0XA0 6ES7195-0BE12-0XA0 6ES7195-0BE22-0XA0 6ES7195-0BE32-0XA0	Firmware for Siemens ASIC DPC 31 <ul style="list-style-type: none"> • DP-V1 firmware 	6ES7195-2BB00-0XA0

Overview

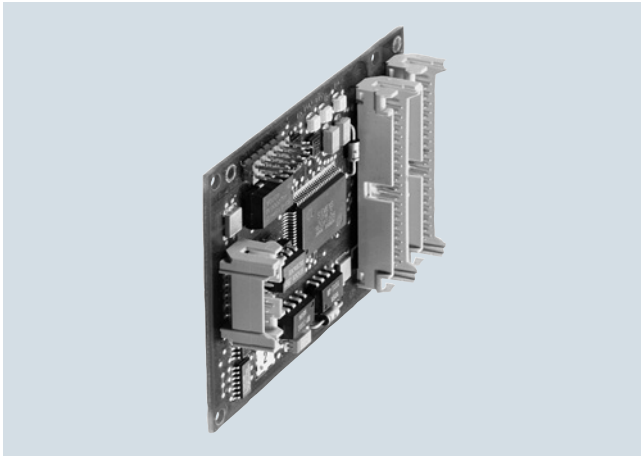

- IM 182-1 PC slave board for the connection of AT-compatible PCs as DP slaves

Technical specifications

Article number	6ES7182-0AA01-0XA0 IM 182-1 PC SLAVE BOARD F. PROFIBUS DP
General information	
Suitability for use	Slave applications
ASIC	SPC 3
• Scope of firmware	4 to 24 KB (incl. test program)
Supply voltage	
Rated value (DC)	5 V
Input current	
Current consumption, typ.	250 mA
Processor	
Microprocessor type	Processor of the PG/PC
Interfaces	
PROFIBUS DP	
• Transmission rate, max.	12 Mbit/s

Article number	6ES7182-0AA01-0XA0 IM 182-1 PC SLAVE BOARD F. PROFIBUS DP
Protocols	
PROFIBUS DP	Yes
Ambient conditions	
Ambient temperature during operation	
• min.	0 °C
• max.	60 °C
Dimensions	
Width	168 mm
Height	105 mm

Ordering data

Ordering data	Article No.
SIMATIC S5/S7 IM 182-1 PC slave board For PROFIBUS DP, max. 12 Mbps	6ES7182-0AA01-0XA0

Accessories	Article No.
Firmware for Siemens ASIC SPC 3 and IM 182-1	
• DP firmware	6ES7195-2BA00-0XA0
• DP-V1 firmware	6ES7195-2BA01-0XA0
• DP-V1 firmware upgrade	6ES7195-2BA02-0XA0

I/O systems

PROFIBUS components

Development kits

Overview

Development kit

With the help of development kits, PROFIBUS hardware and software applications can be developed and tested using the PROFIBUS ASICs SPC 3.

The comprehensive, perfectly interacting hardware and software components considerably reduce the development costs for a PROFIBUS device.

The kits provide a fully functional hardware development environment which development engineers can build on with their special requirements for hardware and software. Documentation is supplied on CD in English and German.

The kits are in the form of a PC module and make our PROFIBUS know-how accessible to other users. The development team is available to provide advice to new users even with their own developments – this consultancy service is also a component part of the development kit.

Following completion of a development, devices can be certified by our experts in the PROFIBUS interface centers – we can help new users here, too.

PROFIBUS DP/PA development kit

The kit facilitates the set up of PROFIBUS slaves with a variety of PROFIBUS standards:

- PROFIBUS DP-V1 (RS 485)
- PROFIBUS PA (IEC 1158) and
- PROFIBUS based on fiber-optic cables

The development environment shows how applications are implemented using PROFIBUS ASIC SPC 3.

Hardware included:

- IM 182-1 (PC module with SPC 3 and ISA interface); without SW

Software to be ordered separately:

- FW for SPC 3 (IM 183-1: evaluation board and IM 182)

When developing PROFIBUS PA applications, you will need to order a PROFIBUS DP/PA coupler (6ES7 157-0AC80-0XA0) separately. The DP/PA coupler converts the PROFIBUS DP physical specifications into those of PROFIBUS PA. This module is not included in the development kit!

PROFIsafe starter kit V3.4

The PROFIsafe starter kit V3.4 is compatible with version 2.4 of the PROFIsafe profile, as specified in IEC 61784-3-3. It meets a series of user requirements such as multi-instance capability and variable process data lengths at runtime.

Along with all of the PI specifications required for development, the PROFIsafe starter kit contains the source files for the PROFIsafe driver software (PSD) and a comprehensive implementation manual in English and German. In addition, it includes various CRC calculation tools and tools for creating GSD files with security-related parameters.

Examples of adaptation of the PSD (PROFIsafe Driver) to current PROFIBUS and PROFINET stack interfaces provide assistance for adaptations that may be necessary. Special "slow-motion monitors" allow the PROFIsafe protocol processes to be monitored in slow motion. A new feature is support for the iPar server and the TCI interface.

Example applications are provided on the CD-ROM for both PROFIBUS and PROFINET. The hardware components supplied in the development kits offer the user step-by-step access to the PROFIsafe world.

The PROFIsafe starter kit consists of the following components:

- Current PROFIsafe specifications with current PROFIsafe certificate
- PROFIsafe driver software (as core component of the development kit)
- Example GSD file for STEP7 (for PROFIBUS DP/PA development kit and DK-ERTEC 200 PN IO)
- Example project for S7-319F (for PROFIBUS DP/PA development kit and DK-ERTEC 200 PN IO)
- GSD tools (e.g. GSD editor and CRC calculation tool)
- iPar server software and instructions (FB24)
- Tool calling interface example and instructions
- F programming guidelines: Layer stacks (V1SL and PN IO)
- Example firmware (for PROFIBUS DP/PA development kit and DK-ERTEC 200 PN IO)
- Project for example development environment (for PROFIBUS DP/PA development kit and DK-ERTEC 200 PN IO)
- Slow-motion monitor (for PROFIBUS: PG-PC and CP5613, for PROFINET: PG-CP1616)
- Comprehensive documentation

Ordering data

Article No.

PROFIBUS DP/PA development kit

Comprising IM 182-1 (PC module with SPC 3 and ISA interface); without SW, additional firmware required

6ES7182-0AA01-0XA0

Article No.

Firmware with development environment for SPC 3

For IM 182-1 (ISA plug-in card) and IM 183-1 (evaluation board)

6ES7195-2BA00-0XA0

PROFIsafe starter kit V3.4

6ES7195-3BF02-0YA0

Overview

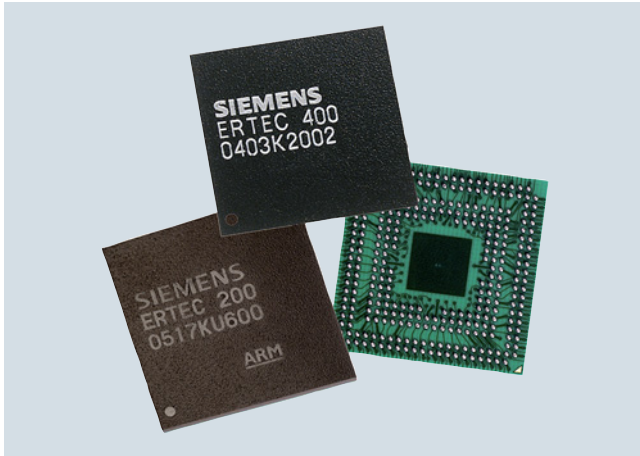

With the Industrial Ethernet ASICs of the ERTEC family (Enhanced Real-Time Ethernet Controllers), devices and systems can be connected to PROFINET without great effort. The high-performance Ethernet controllers with 32-bit microprocessor as well as integral real-time switch for Real Time Ethernet have been specially developed for industrial use.

These Ethernet controllers handle all the data transmission for PROFINET with Real-Time (RT) and Isochronous Real-Time (IRT) and thus offload the application processor. Thanks to the integral 2-port switch (ERTEC 200 and ERTEC 200P) or 4-port switch (ERTEC 400), there are no costs for external switches. Flexible topologies such as star, tree and linear topologies can be implemented without any other external network components.

- ERTEC 200P
with integral 2-port switch and maximum performance for compact and modular PROFINET field devices. The ERTEC 200P is designed for cycle times up to 31.25 μ s. In conjunction with a high-speed ARM 926 CPU, it meets all the requirements for powerful PROFINET implementation.
- ERTEC 200
with an integral 2-port switch for developing compact or modular PROFINET field devices.
- ERTEC 400
with 4 integral ports and one integral PCI interface for developing network components and field devices with specific requirements regarding communication capabilities.

The EK-ERTEC 200P PN IO, DK-ERTEC 200 PN IO and DK-ERTEC 400 PN IO development kits enable the uncomplicated development of PROFINET field devices thanks to fast and simple integration of the PROFINET IO functionalities based on the ERTEC.

Technical specifications

	ERTEC 400	ERTEC 200	ERTEC 200P
Transmission rate	10/100 Mbps	10/100 Mbps	100 Mbps
Interfaces			
• Ethernet / PHY interface	4 x PHY interface	2 x Ethernet interface (PHY integrated) or alternatively 2 x PHY interface (for connection of optical PHYs)	2 x Ethernet interface (PHY integrated) or alternatively 2 x PHY interface (for connection of optical PHYs)
- In connection with the corresponding PHY types:	• Half/full duplex Support for copper and fiber-optic cables; autosensing; autocrossover	• Half/full duplex Support for copper and fiber-optic cables (PHY for copper integrated); autosensing; autocrossover	Half/full duplex Support for copper and fiber-optic cables (PHY for copper integrated); autosensing; autocrossover
• Local Bus Unit (LBU)	Local bus master interface for connecting an external host with access to internal areas of the ERTEC; 16 bit data bit width	Local bus master interface for connecting an external host with access to internal areas of the ERTEC; 16 bit data bit width	XHIG (external host interface); 16/32 bit data bit width
• External memory interface (EMIF)			
- SDRAM controller	128 MB/16 bit or 256 MB/32 bit	64 MB/16 bit or 128 MB/32 bit	128 MB/16 bit or 256 MB/32 bit
- SRAM controller	4 x 16 MB for asynchronous blocks (SRAM, flash, I/O 8/16/32 bit)	4 x 16 MB for asynchronous blocks (SRAM, flash, I/O 8/16/32 bit)	4 x 16 MB for asynchronous blocks (SRAM, flash, I/O 8/16/32 bit)
- Chip-select support	yes	yes	yes
• IO interfaces	32 parameterizable I/O (GPIO); multifunctional outputs	45 parameterizable I/O (GPIO); multifunctional outputs	up to 96 parameterizable I/O (GPIO); multifunctional outputs
• Intelligent switching and PROFINET IRT prioritization/timing	yes	yes	yes
ARM processor			
• Integral ARM946 processor	32-bit ARM system	32-bit ARM system	32-bit ARM system
- Adjustable operating frequency	50/100/150 MHz	50/100/150 MHz	125/250 MHz

I/O systems

PROFINET components

Enhanced Real-Time Ethernet Controllers ERTEC**Technical specifications** (continued)

	ERTEC 400	ERTEC 200	ERTEC 200P
Supply voltage			
• Core (VDD Core)	1.5 V +/- 10 %	1.5 V +/- 10 %	1.2 V +5%/-0.1 V
• I/Os (VDD IO)	3.3 V +/- 10 %	3.3 V +/- 10 %	3.3 V +5%/-10%
• External host interface (XHIF)	-	-	1.8 V +5%/-10%
• PHY	-	-	1.5 V +5%/-10%
• External host interface (XHIF)	-	-	1.8 V/3.3 V +5%/-10%
Perm. ambient conditions			
• Operating temperature	-40 °C to +85 °C	-40 °C to +85 °C	-40 °C to +85 °C
• Transport/storage temperature	-40 °C to +85 °C	-40 °C to +85 °C	-40 °C to +85 °C
• Relative humidity	Max. 95 % at +25 °C	Max. 95 % at +25 °C	Max. 95 % at +25 °C
Constructional design			
• Housing	Plastic FBGA 304 Pin	Plastic FBGA 304 Pin	Plastic FBGA 400 Pin
• Pinning Ball Pitch	0.8 mm	0.8 mm	0.8 mm
Dimensions (W x H x D) in mm - ERTEC	19 x 1 x 19	19 x 1 x 19	17 x 1 x 17
Supported communications protocols			
• General Ethernet protocols	In accordance with the respective software implementation that uses the ERTEC as Ethernet controller	In accordance with the respective software implementation that uses the ERTEC as Ethernet controller	In accordance with the respective software implementation that uses the ERTEC as Ethernet controller
• PROFINET in combination with a PROFINET Software Stack	Real-Time communication (RT); Isochronous Real-Time communication (IRT)	Real-Time communication (RT); Isochronous Real-Time communication (IRT)	Real-Time communication (RT); Isochronous Real-Time communication (IRT)

Ordering data

	Article No.		Article No.
ERTEC 200P		ERTEC 200	
ASIC for connection to Switched Ethernet 100 Mbps, Ethernet controller with integral 2-port switch, ARM 926 processor and integral PHYs		ASIC ERTEC 200 for connection to Switched Ethernet 10/100 Mbps, Ethernet controller with integral 2-port switch, ARM 946 processor and integral PHYs	
• 10 units (evaluation pack)	6ES7195-0BH00-0XA0	• 70 units (single tray)	6GK1182-0BB01-0AA1
• 90 units (single tray)	6ES7195-0BH10-0XA0	• 350 units (drypack, 5 trays),	6GK1182-0BB01-0AA2
• 450 units (drypack, 5 trays)	6ES7195-0BH20-0XA0	• 3500 units (package, 10 dry-packs)	6GK1182-0BB01-0AA3
• 1 000 units (tape & reel)	6ES7195-0BH30-0XA0		
Evaluation Kit	6ES7195-3BE00-0YA0	ERTEC 400	
EK-ERTEC 200P PN IO		ASIC ERTEC 400 for connection to Switched Ethernet 10/100 Mbps, Ethernet controller with integrated 4-port switch, ARM 946 processor and PCI interface (V2.2), data preparation for real-time and isochronous real-time for PROFINET IO	
		• 70 units (single tray)	6GK1184-0BB01-0AA1
		• 350 units (drypack, 5 trays)	6GK1184-0BB01-0AA2

Overview



With the development packages for PROFINET, compact or modular PROFINET field devices can be developed quickly and with little effort. Depending on the application, different development packages are available.

The development packages for the ASICs of the ERTEC family (Enhanced Real-Time Ethernet Controllers) are suitable for the development of field devices with an integrated IRT switch (Isochronous Real-Time). The demand for real-time capability, linear topology capability, and for IT integration is therefore met perfectly.

With the help of the development package for standard Ethernet controllers, PROFINET devices can be developed on the basis of a standard Ethernet controller. Devices with RT (Real-Time) can be implemented in the field device without special hardware.

The PROFI-safe starter kit permits the implementation of fail-safe devices. In so doing, the PROFI-safe stack applicatively builds on the PROFINET stack.

Ordering data

Article No.

Article No.

ERTEC development kits / evaluation kits

Evaluation kit
EK-ERTEC 200P PN IO

6ES7195-3BE00-0YA0

Development kit
for standard Ethernet controllers

6ES7195-3BC00-0YA0

PROFI-safe starter kit V3.5
according to the PROFI-safe V2.6.1
profile

6ES7195-3BF03-0YA0**ERTEC ASICs****ERTEC 200P**

ASIC for connection to Switched
Ethernet 100 Mbps, Ethernet con-
troller with integral 2-port switch,
ARM 926 processor and integral
PHYs

- 10 units (evaluation pack)
- 90 units (single tray)
- 450 units (drypack, 5 trays)

6ES7195-0BH00-0XA0
6ES7195-0BH10-0XA0
6ES7195-0BH20-0XA0

ERTEC 200

ASIC ERTEC 200 for connection to
Switched Ethernet 10/100 Mbps,
Ethernet controller with integral
2-port switch, ARM 946 processor
and integral PHYs

- 70 units (single tray)
- 350 units (drypack, 5 trays)
- 3500 units (package, 10 dry-
packs)
- 1050 units (tape & reel)

6GK1182-0BB01-0AA1
6GK1182-0BB01-0AA2
6GK1182-0BB01-0AA3
6GK1182-0BB01-0AA4

ERTEC 400

ASIC ERTEC 400 for connection to
Switched Ethernet 10/100 Mbps,
Ethernet controller with integral
4-port switch, ARM 946 processor
and PCI interface (V2.2)

- 70 units (single tray)
- 350 units (drypack, 5 trays)

6GK1184-0BB01-0AA1
6GK1184-0BB01-0AA2

Accessories

PROFINET IO product line license
for one product line

6ES7195-3BC10-0YA0

I/O systems

PROFINET components

PROFINET Driver

Overview

- For connecting distributed I/O and drives to user-specific control applications via PROFINET
- Operation of the control software on a standard PC using the standard Ethernet interface of the PC
- Supplied as portable source code and can therefore be used with any operating system
- Sample application for Windows included in the scope of delivery; uses SIMATIC IPCs as example hardware

Note

You are provided with the source code of the PN driver V1.1, as well as the source code of the application examples. These codes are to be used for modifying and editing in conjunction with SIMATIC only. You are not permitted to use PN driver source codes or the application examples without SIMATIC, nor are you permitted to pass them on to third parties.

The application examples are not binding and do not claim to be complete regarding configuration, equipment or any eventualities. The application examples do not represent customer-specific solutions. They are only intended to provide support for typical tasks. You are responsible for ensuring that the described products are used correctly. These application examples do not relieve you of your responsibility to use safe practices in application, installation, operation and maintenance processes. By using these application examples, you agree that we cannot be held liable for any damages/claims beyond the liability clause

described. We reserve the right to make changes to these application examples at any time without prior notice. If there are any deviations between the recommendations provided in these application examples and other Siemens publications – e.g. Catalogs – the contents of the other documents have priority.

We do not accept any liability for the information contained in this document.

Any claims against us – based on whatever legal reason – resulting from the use of the examples, information, programs, engineering and performance data etc. described in this application example shall be excluded. Such an exclusion shall not apply in the case of mandatory liability, e.g. under the German Product Liability Act (“Produkthaftungsgesetz”), in case of intent, gross negligence, or injury to life, body or health, guarantee for the quality of a product, fraudulent concealment of a deficiency or breach of a condition which goes to the root of the contract (“wesentliche Vertragspflichten”). The damages for a breach of a substantial contractual obligation are, however, limited to the foreseeable damage, typical for the type of contract, except in the event of intent or gross negligence or injury to life, body or health. The above provisions do not imply a change of the burden of proof to your detriment.

Any form of duplication of these application examples or excerpts thereof is not permitted without the express consent of Siemens AG.

Ordering data

Article No.

PROFINET Driver

For connecting distributed I/O and drives to user-specific control applications via PROFINET

Development license

6ES7195-3AA00-0YA0

Runtime licenses

- 1 unit
- 10 units
- 50 units
- 200 units
- 500 units

6ES7195-3AA05-0XA0
6ES7195-3AA10-0XA0
6ES7195-3AA20-0XA0
6ES7195-3AA30-0XA0
6ES7195-3AA40-0XA0

Overview



- Terminates bus segments at data transmission rates of 9.6 Kbps to 12 Mbps
- Power supply independent of bus stations

Designed for Industry

- Terminal-independent bus termination through onboard power supply

Technical specifications

Article number	6ES7972-0DA00-0AA0 SIMATIC S7, RS 485 RESISTOR
Supply voltage	
Rated value (DC)	24 V
permissible range, lower limit (DC)	20.4 V
permissible range, upper limit (DC)	28.8 V
Input current	
Current consumption, typ.	30 mA
Power loss	
Power loss, max.	0.72 W
Interfaces	
PROFIBUS DP	
• Transmission rate, max.	12 Mbit/s; 9.6 kbit/s to 12 Mbit/s
Degree and class of protection	
Degree of protection acc. to EN 60529	
• IP20	Yes

Article number	6ES7972-0DA00-0AA0 SIMATIC S7, RS 485 RESISTOR
Ambient conditions	
Ambient temperature during operation	
• min.	0 °C
• max.	60 °C
Ambient temperature during storage/transportation	
• min.	-40 °C
• max.	70 °C
Relative humidity	
• Operation, max.	95 %; at +25 °C
Connection method	
Power supply	Screw terminal block
Bus cables	Screw terminal block
Dimensions	
Width	60 mm
Height	70 mm
Depth	43 mm
Weights	
Weight, approx.	95 g

Ordering data

Article No.

Active RS 485 terminating element for PROFIBUS

6ES7972-0DA00-0AA0

For terminating bus segments at transmission rates of 9.6 Kbps to 12 Mbps

I/O systems

Network components for PROFIBUS
Electrical networks (RS 485)

RS 485 repeater for PROFIBUS

Overview



- Automatic detection of transmission rates
- Transmission rates from 9.6 Kbps to 12 Mbps are possible, incl. 45.45 Kbps
- 24 V DC voltage display
- Indication of segment 1 and 2 bus activity
- The separation of segment 1 and segment 2 by means of switches is possible
- Separation of the right segment with an inserted terminating resistor
- Decoupling of segment 1 and segment 2 in the case of static interference

Designed for Industry

- For increasing the expansion
- Electrical isolation of segments
- Commissioning support
 - Switches for separation of segments
 - Bus activity display
 - Segment separation in the case of an incorrectly inserted terminating resistor

In this context, please also note the diagnostics repeater that provides extensive diagnostics functions for physical line diagnostics in addition to the normal repeater functionality. This is described on page 9/357.

Technical specifications

Article number	6ES7972-0AA02-0XA0 REPEATER RS 485 F. PROFIBUS/MPI
Supply voltage	
Rated value (DC)	24 V
permissible range, lower limit (DC)	20.4 V
permissible range, upper limit (DC)	28.8 V
Input current	
Current consumption, max.	100 mA; 100 mA without loads at PG/OP socket; 130 mA load at PG/OP socket (5 V/90 mA); 200 mA load at PG/OP socket (24 V/100 mA)
Power loss	
Power loss, typ.	0.7 W
Interfaces	
PROFIBUS DP	
• Transmission rate, max.	12 Mbit/s; 9.6 kbit/s to 12 Mbit/s
Degree and class of protection	
Degree of protection acc. to EN 60529	
• IP20	Yes

Article number	6ES7972-0AA02-0XA0 REPEATER RS 485 F. PROFIBUS/MPI
Ambient conditions	
Ambient temperature during operation	
• min.	0 °C
• max.	60 °C
Ambient temperature during storage/transportation	
• min.	-40 °C
• max.	70 °C
Relative humidity	
• Operation, max.	95 %; at 25 °C
Connection method	
Power supply	Terminal block
Bus cables	2 terminal blocks
Dimensions	
Width	45 mm
Height	128 mm
Depth	67 mm
Weights	
Weight, approx.	350 g

Ordering data

Article No.

RS 485 repeater for PROFIBUS **6ES7972-0AA02-0XA0**

Transfer rate up to max. 12 Mbps,
24 V DC, IP20 enclosure

SIPLUS DP active RS 485 terminating element

Overview



- Used to terminate bus segments at rates of 9.6 Kbps to 12 Mbps
- Power supply independent of the bus participants

Designed for Industry

- End-device – independent bus termination thanks to own power supply

Note:

SIPLUS extreme products are based on SIMATIC standard products. The contents listed here were taken from the respective standard products. SIPLUS extreme-specific information was added.

SIPLUS active RS 485 terminating element

Article No.	6AG1972-0DA00-2AA0
BasedOn Article No.	6ES7972-0DA00-0AA0
Ambient temperature range	-25 °C ... +60 °C
Conformal coating	Coating of the printed circuit boards and the electronic components.
Technical data	The technical data of the standard product applies except for the ambient conditions.
Ambient conditions	
Relative humidity	100%, condensation/frost permitted. No commissioning if condensation present.
Biologically active substances, compliance with EN 60721-3-3	Class 3B2 mold and fungal spores (excluding fauna). The supplied plug covers must remain in place over the unused interfaces during operation!
Chemically active substances, compliance with EN 60721-3-3	Class 3C4 incl. salt spray in accordance with EN60068-2-52 (degree of severity 3). The supplied plug covers must remain in place over the unused interfaces during operation!
Mechanically active substances, compliance with EN 60721-3-3	Class 3S4 incl. sand, dust. The supplied plug covers must remain in place over the unused interfaces during operation!
Air pressure (depending on the highest positive temperature range specified)	1 080...795 hPa (-1 000 ... +2 000 m) See ambient temperature range 795...658 hPa (+2 000 ... +3,500 m) Derating 10 K 658...540 hPa (+3 500 ... +5 000m) Derating 20K

For technical documentation on SIPLUS, see:

<http://www.siemens.com/siplus-extreme>

Ordering data

Article No.

SIPLUS active RS 485 terminating element for PROFIBUS

to complete bus segments at transmission rates of 9.6 Kbps to 12 Mbps

Extended temperature range and exposure to media

6AG1972-0DA00-2AA0

I/O systems

Network components for PROFIBUS
Electrical networks (RS 485)

SIPLUS RS 485 repeater

Overview



- Automatically detects transmission rate
- 45.45 Kbps transmission rate is possible
- 24 V DC voltage display
- Indication of segment 1 and 2 bus activity
- The separation of segment 1 and segment 2 by means of switches is possible
- Separation of the right segment with an inserted terminating resistor
- Decoupling of segment 1 and segment 2 in the case of static interference

Designed for Industry

- For increasing the number of participants and the expansion
- Electric isolation of segments
- Commissioning support
 - Switches for segment separation
 - Bus activity display
 - Segment separation in the case of an incorrectly inserted terminating resistor

In this context, please also note the diagnostics repeater that provides extensive diagnostics functions for physical line diagnostics in addition to the normal repeater functionality. This is described on page 9/359.

Note:

SIPLUS extreme products are based on SIMATIC standard products. The contents listed here were taken from the respective standard products. SIPLUS extreme-specific information was added.

For technical documentation on SIPLUS, see:

<http://www.siemens.com/siplus-extreme>

Technical specifications

Article number	6AG1972-0AA02-7XA0
Based on	6ES7972-0AA02-0XA0 SIPLUS DP RS 485-Repeater
Ambient conditions	
Ambient temperature during operation	
• min.	-25 °C
• max.	70 °C
Ambient temperature during storage/transportation	
• min.	-40 °C
• max.	70 °C
Extended ambient conditions	
• relative to ambient temperature-atmospheric pressure-installation altitude	Tmin ... Tmax at 1080 hPa ... 795 hPa (-1000 m ... +2000 m) // Tmin ... (Tmax - 10K) at 795 hPa ... 658 hPa (+2000 m ... +3500 m) // Tmin ... (Tmax - 20K) at 658 hPa ... 540 hPa (+3500 m ... +5000 m)
Relative humidity	
- With condensation, tested in accordance with IEC 60068-2-38, max.	100 %; RH incl. condensation/frost (no commissioning under condensation conditions)

Article number	6AG1972-0AA02-7XA0
Based on	6ES7972-0AA02-0XA0 SIPLUS DP RS 485-Repeater
Resistance	
- against biologically active substances / conformity with EN 60721-3-3	Yes; Class 3B2 mold, fungus and dry rot spores (with the exception of fauna). The supplied connector covers must remain on the unused interfaces during operation!
- against chemically active substances / conformity with EN 60721-3-3	Yes; Class 3C4 incl. salt spray. The supplied connector covers must remain on the unused interfaces during operation!
- against mechanically active substances / conformity with EN 60721-3-3	Yes; Class 3S4 incl. sand, dust. The supplied connector covers must remain on the unused interfaces during operation!
Connection method	
Power supply	Terminal block
Bus cables	2 terminal blocks
Dimensions	
Width	45 mm
Height	128 mm
Depth	67 mm
Weights	
Weight, approx.	350 g

Ordering data

Article No.

SIPLUS RS 485 repeater for PROFIBUS

Transfer rate up to max. 12 Mbps,
24 V DC, enclosure IP20

Extended temperature range and exposure to media

6AG1972-0AA02-7XA0

Overview



- Maximum data exchange of 256-byte input data and 256-byte output data between two PROFINET networks
- Maximum of 16 input/output ranges for the exchange of data
- Electrical isolation between the two PROFINET IO subnets
- Redundant power supply
- Supported Ethernet services
 - ping
 - arp
 - network diagnostics (SNMP/MIB-2)
- Diagnostic interrupts
- ReturnOfSubmodule interrupts

Technical specifications

Article number	6ES7158-3AD01-0XA0 PN/PN COUPLER
General information	
Product type designation	PN/PN coupler
Installation type/mounting	
Mounting	Mounting rail 7.5 mm and 15 mm
Supply voltage	
Rated value (DC)	24 V
permissible range, lower limit (DC)	20.4 V
permissible range, upper limit (DC)	28.8 V
Reverse polarity protection	Yes
Mains buffering	
• Mains/voltage failure stored energy time	20 ms
Input current	
from supply voltage 1L+, max.	400 mA
Power loss	
Power loss, typ.	6 W
Address area	
Addressing volume	
• Inputs	1 024 byte; Total, including outputs
• Outputs	1 024 byte; Total, including inputs
Interfaces	
PROFINET IO	
• automatic detection of transmission rate	Yes
• Transmission rate, max.	100 Mbit/s
• Services	Network management functions, network diagnostics (SNMP, MIB-2), ping, arp, PROFINET V2.0
• RJ 45	Yes; 4 RJ45 female connectors, 2 for each side
Protocols	
Supports protocol for PROFINET IO	Yes

Article number	6ES7158-3AD01-0XA0 PN/PN COUPLER
Isochronous mode	
Isochronous operation (application synchronized up to terminal)	No; For operation on isochronous bus
Interrupts/diagnostics/status information	
Status indicator	Yes
Alarms	Yes
Diagnostic functions	Yes
Diagnostics indication LED	
• Bus fault BF (red)	Yes; for each side
• Group error SF (red)	Yes; for each side
• Monitoring 24 V voltage supply ON (green)	Yes; for each side
• Connection to network LINK (green)	Yes; for each port
Potential separation	
between supply voltage and electronics	Yes; to power input 2
between Ethernet and electronics	Yes
Permissible potential difference	
between different circuits	500 V DC
Isolation	
Isolation tested with	500 V
Degree and class of protection	
Degree of protection acc. to EN 60529	
• IP20	Yes
Ambient conditions	
Ambient temperature during operation	
• min.	0 °C
• max.	60 °C
Dimensions	
Width	120 mm; Minimized with good handling
Height	119.5 mm
Depth	75 mm; with mounting rail
Weights	
Weight, approx.	283 g

I/O systems

Network transitions

PN/PN coupler

Ordering data	Article No.
PN/PN coupler For connecting two PROFINET networks	6ES7158-3AD01-0XA0
Power supply connector Spare part; for connecting the 24 V DC supply voltage <ul style="list-style-type: none">• with push-in terminals• with screw-type terminals	6ES7193-4JB00-0AA0 6ES7193-4JB50-0AA0

Overview



- For data exchange between PROFINET and CAN Bus 2.0A/B or CANopen Manager or Slave (according to CiA 301 & 302)
- CANopen features:
 - Node / lifeguarding
 - Heartbeat
 - SYNC (producer / consumer)
- Integrated in TIA via HSP, TIA Portal V14 or higher
- PROFINET switch and 9-pin sub D plug integrated for CAN
- Up to 126 CAN nodes
- 512 receiver/transmitter PDOs
- Electrical isolation between the two networks
- Diagnostic interrupts
- Controllers supported: S7-1200, S7-1500, ET 200SP, Open Controller

Technical specifications

Article number	6BK1620-0AA00-0AA0 SIMATIC PN/CAN LINK
General information	
Product type designation	SIMATIC PN/CAN LINK
Firmware version	
• FW update possible	Yes
Vendor identification (VendorID)	ID 09 00 00 53h acc. to CiA
Engineering with	
• STEP 7 TIA Portal configurable/ integrated as of version	STEP 7 V14 or higher
Installation type/mounting	
Mounting	DIN rail, wall mounting, portrait mounting
Mounting position	Any
Recommended mounting position	Horizontal
Supply voltage	
Type of supply voltage	24 V DC
Rated value (DC)	24 V
permissible range, lower limit (DC)	20.4 V
permissible range, upper limit (DC)	28.8 V
Reverse polarity protection	Yes
Oversvoltage protection	Yes
Short-circuit protection	Yes
Mains buffering	
• Mains/voltage failure stored energy time	10 ms
Input current	
Current consumption (rated value)	0.09 A
Current consumption, max.	0.11 A
Power loss	
Power loss, typ.	2.2 W

Article number	6BK1620-0AA00-0AA0 SIMATIC PN/CAN LINK
Interfaces	
Interfaces/bus type	2x Ethernet (RJ45), 1x Sub-D (9-pin)
PROFINET IO	
• automatic detection of transmission rate	No
• Transmission rate, max.	100 Mbit/s
• Number of RJ45 ports	2
• Number of FC (FastConnect) connections	2
PROFINET functions	
• Assignment of the IP address, supported	Yes
• Assignment of the device name, supported	Yes
Protocols	
• CAN operating modes	CAN Standard CAN 2.0A/B; CANopen Manager / Slave acc. to CiA
• Specification acc. to CiA	CiA 301 & CiA 302
• Transmission rate, min.	50 kbit/s
• Transmission rate, max.	1 000 kbit/s
• Number of slaves, max.	126
• Number of SDOs in parallel	16; Parallel
• Number of PDOs	512; Send / receive
Type	
- Node/life-guarding	Yes
- Heartbeat	Yes
- SYNC	Yes

I/O systems

Network transitions

PN/CAN LINK**Technical specifications** (continued)

Article number	6BK1620-0AA00-0AA0 SIMATIC PN/CAN LINK
1. Interface	
Interface type	CAN according to CiA 303-1
Physics	9-pin sub D socket
Isolated	Yes; 500 V AC or 707 V DC
Interface types	
• Number of ports	1
2. Interface	
Interface type	PROFINET
Physics	Ethernet, 2-port switch, 2*RJ45
Isolated	Yes; 1 500 V AC or 2 250 V DC
Interface types	
• Number of ports	2
• integrated switch	Yes
Functionality	
• PROFINET IO Device	Yes
Interrupts/diagnostics/ status information	
Status indicator	Yes
Alarms	Yes
Diagnostic functions	Yes
Diagnostics indication LED	
• RUN LED	Yes
• ERROR LED	Yes
• MAINT LED	Yes
• LINK LED	Yes
• RX/TX LED	Yes
Potential separation	
Potential separation exists	Yes
Degree and class of protection	
Degree of protection acc. to EN 60529	IP20

Article number	6BK1620-0AA00-0AA0 SIMATIC PN/CAN LINK
Standards, approvals, certificates	
CE mark	Yes
PNO certificate	Yes
RoHS conformity	Yes
Ambient conditions	
Ambient temperature during operation	
• horizontal installation, min.	-25 °C
• horizontal installation, max.	60 °C
• vertical installation, min.	-25 °C
• vertical installation, max.	55 °C
Ambient temperature during storage/transportation	
• min.	-40 °C
• max.	85 °C
Relative humidity	
• Operation, max.	95 %
Dimensions	
Width	70 mm
Height	112 mm
Depth	75 mm
Weights	
Weight, approx.	212 g

Ordering data**Article No.**

SIMATIC PN/CAN LINK
PROFINET network transition
according to CAN Bus 2.0A/B,
CANopen Manager according to
CiA301/302, CANopen Slave
according to CiA301/302; IP20

6BK1620-0AA00-0AA0

Overview

- For interconnecting two PROFIBUS DP networks
- The interchange of data between both DP networks takes place by internal copying in the coupler

Technical specifications

DP/DP transceiver	
PROFIBUS transmission rate	max. 12 Mbit/s
Interfaces	<ul style="list-style-type: none"> • PROFIBUS DP
Supply voltage	24 V DC
Current consumption typ.	150 mA
Mounting	Upright (DIP switches above)
Perm. environmental conditions	
• Operating temperature	
- horizontal mounting	0 °C ... +60 °C
- all other mounting positions	0 °C ... +40 °C
• Transport/storage temperature	-40 °C ... +70 °C
• Relative humidity	10-95 % at +25 °C
Design	
• Dimensions (W x H x D) in mm	40 x 127 x 117
• Weight	approx. 250 g
Degree of protection	IP20

Ordering data
Article No.
DP/DP coupler
6ES7158-0AD01-0XA0
Note:

The manual is available free on the Internet.

I/O systems

Network transitions

IE/AS-i Link PN IO

Overview



IE/AS-i Link PN IO: Single master (left) and double master (right)

The IE/AS-i Link PN IO is a compact router between PROFINET and AS-Interface, with the following features:

- Single and double AS-Interface master (according to AS-Interface Specification V3.0) for connection of 62 AS-Interface slaves or 124 AS-Interface slaves (with a double master)
- Integrated analog value transmission
- Integrated ground-fault monitoring for the AS-Interface cable
- User-friendly local diagnostics and start-up by means of a full graphic display and control keys or through a web interface with a standard browser on the PC screen
- Vertical integration (standard web interface) through Industrial Ethernet
- Supply via AS-Interface cable or with 24 V DC
- Suitable for AS-i Power24V and AS-Interface with 30 V voltage
- Module exchange without entering the connection parameters (IP address, etc.) using C-PLUG (optional)
- Costs saved by the double AS-Interface master when large volumes of project data are involved

Note

As an alternative to the IE/AS-i Link PN IO, a powerful network transition can be set up between PROFINET and AS-Interface by combining the CM AS-i Master ST and F-CM AS-i Safety ST modules in one ET 200SP station (for safety-related applications), see pages 9/89 and 9/130.

The IE/AS-i Link PN IO occupies the following address area:

- As a single master with full expansion: 62 bytes of input data and 62 bytes of output data in which the I/O data of the connected AS-Interface slaves (standard and A/B slaves) of an AS-i line is stored
- Double the number of bytes as double master
- Optional additional I/O bytes for data from analog slaves

The size of the input/output image can be compressed so that only the actually required I/O address area is occupied in the system of the IO controller.

The IE/AS-i Link PN IO is configured as follows:

- With STEP 7 (classic) V5.4 or higher: When configuring in STEP 7, the AS-Interface configuration can be uploaded in STEP 7 V5.4 SP2 and higher. Furthermore, AS-Interface slaves from Siemens can also be conveniently configured in HW Config (slave selection dialog).
- Alternatively, IE/AS-i Link PN IO can be integrated in the engineering tool by means of the PROFINET GSD file (e.g. for TIA Portal, for STEP 7 versions V5.4 SP2 and lower, or for non-Siemens engineering tools). Please observe the configuration notes in the TIA Portal, see <https://support.industry.siemens.com/cs/ww/en/view/109483764>.

Notes on safety

In order to protect plants, systems, machines and networks against cyber threats, it is necessary to implement – and continuously maintain – a holistic, state-of-the-art industrial security concept. Siemens products and solutions only represent one component of such a concept.

For more information on the topic of Industrial Security, see <http://www.siemens.com/industrialsecurity>.

Single master

The AS-i single master version of IE/AS-i Link PN IO is suitable for applications with typical volumes of data. The single master can operate up to 248 DI / 248 DO, using 62 A/B slaves with 4 DI / 4 DO each.

Double master

The AS-i double master version of IE/AS-i Link PN IO is suitable for applications with large volumes of data. In this case, twice the volume of project data can be used on two AS-i lines running independently of each other. The double master can operate up to 496 DI / 496 DO, using two AS-i networks each with 62 A/B slaves with 4 DI / 4 DO each.

Overview (continued)

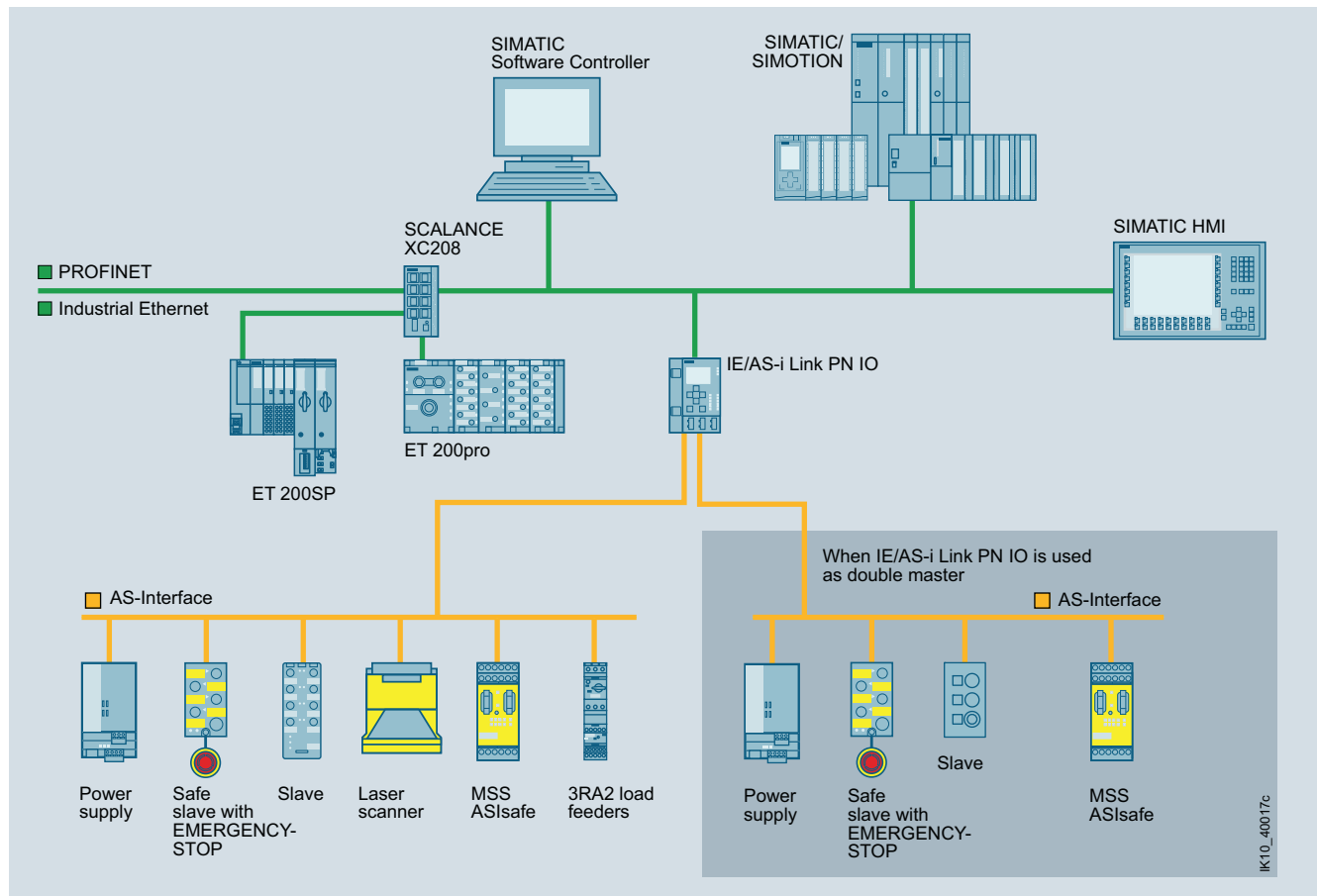

Integration of AS-Interface on PROFINET through IE/AS-i Link PN IO as single/double master

Ordering data

IE/AS-i Link PN IO

Router between PROFINET/Industrial Ethernet and AS-Interface in IP20 degree of protection; including COMBICON plug-in screw terminals for connecting an AS-Interface cable (two AS-Interface cables for a double master) and the optional 24 V supply; complies with AS-Interface Specification V3.0; dimensions (W x H x D / mm): 90 x 132 x 88.5

COMBICON connection

- Single master with display
- Double master with display

Article No.

6GK1411-2AB10
6GK1411-2AB20

Article No.

Accessories

C-PLUG

Exchange medium for the simple exchange of devices in the event of a fault; for accommodating configuration and application data; can be used in SIMATIC NET products with a C-PLUG slot

6GK1900-0AB00

IE FC RJ45 Plug 90

RJ45 plug-in connector for Industrial Ethernet, with robust metal enclosure and integrated insulation displacement contacts for connection of Industrial Ethernet FC installation cables; with 90° cable feeder

- 1 pack = 1 unit
- 1 pack = 10 units
- 1 pack = 50 units

6GK1901-1BB20-2AA0
6GK1901-1BB20-2AB0
6GK1901-1BB20-2AE0

More information

For manuals, see <https://support.industry.siemens.com/cs/ww/en/ps/15762/man>.

AS-Interface function block library for SIMATIC PCS 7 for easy connection of AS-Interface to PCS 7, see Catalog IC 10, Chapter 14, "Parameterization, Configuration and Visualization with SIRIUS".

I/O systems

Notes

SIMATIC control systems



10/2	FM 458-1 DP application module
10/2	Introduction
10/3	FM 458-1 DP basic module
10/5	EXM 438-1 input/output expansion
10/7	EXM 448-2 universal communication expansion
10/8	D7-SYS
10/8	Accessories
10/9	SIMATIC TDC multiprocessor control system
10/9	Introduction
10/9	UR6021 rack
10/10	CPU555, CPU551 processor module
10/11	MC5xx program memory module
10/11	CP50M1 communications module
10/12	CP51M1 communications module
10/12	CP53M0 coupling module
10/13	SM500 I/O module
10/15	GlobalDataMemory
10/16	Accessories

Brochures

For brochures serving as selection guides for SIMATIC products, refer to:
www.siemens.com/simatic/printmaterial

SIMATIC control systems

FM 458-1 DP application module

Introduction

Overview



SIMATIC FM 458-1 DP integrated in SIMATIC S7-400

- Designed for high-performance and user-configurable closed-loop control tasks in the SIMATIC S7-400.
- Can be adapted to individual requirements as required, such as:
Controlling, computing, closed-loop control as well as motion control. Can therefore be used flexibly for a wide variety of applications.
- Extensive library with approx. 300 function blocks:
E.g. simple functions such as AND, ADD and OR through to complex GMC (general motion control) blocks as virtual master or gear functions.
- User-friendly graphical configuration with the SIMATIC engineering tool CFC (Continuous Function Chart) and the D7-SYS add-on software package:
Optimum code generation by the compiler, therefore SCL is not required.
- PROFIBUS DP interface onboard.

SIMATIC FM 458-1 DP is based on more than 15 years experience with high-performance control systems and combines this know-how with the advantages of SIMATIC – the leading automation system for decades. In contrast to other function modules with static structures/functions, the FM 458-1 DP application module can be configured flexibly and adapted to individual requirements.

Overview



- Basic module for computing, closed-loop control and open-loop control tasks
- PROFIBUS DP interface for connection of distributed I/O and drives
- Modular design with expansion modules for I/O and communication

Technical specifications

Article number	6DD1607-0AA2 FM458-1 DP APPLICATION MODULE
Supply voltage	
Rated value (DC)	
• 5 V DC	Yes
• 24 V DC	Yes
permissible range (ripple included), lower limit (DC)	4.8 V
permissible range (ripple included), upper limit (DC)	5.25 V
Input current	
Current consumption, typ.	1.5 A
Current consumption, max.	3 A
Memory	
Backup	
• present	Yes; SRAM
Battery	
Backup battery	
• Battery operation	Yes
• Backup current, max.	15 µA
Hardware configuration	
Slots	
• required slots	1
Time of day	
Clock	
• Hardware clock (real-time)	Yes
• Resolution	500 ms
Digital inputs	
Number of digital inputs	8; Connector X2
Input voltage	
• Rated value (DC)	24 V
• for signal "0"	-1 to +6V
• for signal "1"	13.5 to 33V
Input current	
• for signal "0", max. (permissible quiescent current)	0 mA
• for signal "1", typ.	3 mA; at 24 V
Input delay (for rated value of input voltage) for standard inputs	
- at "0" to "1", max.	5 µs
Interfaces	
PROFIBUS DP	
• Equidistance	Yes; With connection to interrupt tasks
• Direct data exchange (slave-to-slave communication)	Yes
Interrupts/diagnostics/status information	
Alarms	Yes
Potential separation	
Potential separation digital inputs	
• Potential separation digital inputs	No; only via optional interface modules
Weights	
Weight, approx.	1 000 g

SIMATIC control systems

FM 458-1 DP application module

FM 458-1 DP basic module

Ordering data	Article No.	Ordering data	Article No.
FM 458-1 DP application module Basic module for computing, closed-loop control and open-loop control tasks; with PROFIBUS DP interface	6DD1607-0AA2	RS 485 bus connector with 90° cable outlet Max. transfer rate 12 Mbit/s Without PG interface With PG interface	6ES7972-0BA12-0XA0 6ES7972-0BB12-0XA0
Micro Memory Card For FM 458-1 DP basic module 2 MB 4 MB 8 MB	6ES7953-8LL31-0AA0 6ES7953-8LM31-0AA0 6ES7953-8LP31-0AA0	RS 485 bus connector with angled cable outlet Max. transfer rate 12 Mbit/s Without PG interface With PG interface	6ES7972-0BA42-0XA0 6ES7972-0BB42-0XA0
FM 458-1 DP Know-How-Protect For protection of technological application modules against unauthorized copying	6DD1607-0GA0	RS 485 bus connector with 90° cable outlet for FastConnect connection system Max. transfer rate 12 Mbit/s Without PG interface • 1 unit • 100 units With PG interface • 1 unit • 100 units	6ES7972-0BA52-0XA0 6ES7972-0BA52-0XB0 6ES7972-0BB52-0XA0 6ES7972-0BB52-0XB0
SC 64 interface cable To connect FM 458-1 to the serial port of a programming device/ PC	6DD1684-0GE0	PROFIBUS FastConnect bus cable Standard type with special design for quick mounting, 2-wire, shielded, sold by the meter; max. delivery unit 1000 m, minimum ordering quantity 20 m Preferred lengths: 20 m 50 m 100 m	6XV1830-0EH10 6XV1830-0EN20 6XV1830-0EN50 6XV1830-0ET10
SB10 interface module To connect 8 binary I/Os to FM 458-1 DP	6DD1681-0AE2		
SB61 interface module To connect 8 binary I/Os to FM 458-1 DP, input voltage: 24/48 V DC	6DD1681-0EB3		
SU12 interface module To connect 10 signals to FM 458-1 DP	6DD1681-0AJ1		

SIMATIC control systems

FM 458-1 DP application module

EXM 438-1 input/output expansion

Overview



- Optional plug-in expansion module for the FM 458-1 DP basic module
- For input and output of time-critical signals
- With digital and analog inputs/outputs
- Incremental and absolute encoders can be connected
- 4 high-resolution analog outputs
- Fan-free operation up to 40 °C

Technical specifications

Article number	6DD1607-0CA1 EXM 438-1 I/O EXPANSION
Supply voltage	
Rated value (DC)	
• 5 V DC	Yes
• 24 V DC	Yes; to be set up externally
Input current	
Current consumption, typ.	1.5 A
Encoder supply	
Type of output voltage	about 14 V (non-isolated)
Short-circuit protection	Yes; Electronic
Output current	
• Rated value	100 mA
Power loss	
Power loss, typ.	7.5 W
Hardware configuration	
Slots	
• required slots	1
Digital inputs	
Number of digital inputs	16
Input voltage	
• Rated value (DC)	24 V
• for signal "0"	-1 to +6 V or input open
• for signal "1"	+13 to +33V
Input current	
• for signal "0", max. (permissible quiescent current)	0 mA
• for signal "1", typ.	3 mA
Input delay (for rated value of input voltage) for standard inputs	
- at "0" to "1", max.	200 µs

Article number	6DD1607-0CA1 EXM 438-1 I/O EXPANSION
Digital outputs	
Number of digital outputs	8
Short-circuit protection	Yes; electronic/thermal
• Response threshold, typ.	250 mA
Limitation of inductive shutdown voltage to	Supply voltage +1 V
Output voltage	
• for signal "0", max.	3 V
• for signal "1", max.	Supply voltage -2.5 V
Output current	
• for signal "1" rated value	50 mA
• for signal "1" permissible range for 0 to 40 °C, min.	100 mA
• for signal "0" residual current, max.	20 µA
• Total switching current	80% at 50 °C all outputs 50 mA
Output delay with resistive load	
• "0" to "1", max.	15 µs
Analog inputs	
Number of analog inputs	5; Differential inputs
Input ranges (rated values), voltages	
• -10 V to +10 V	Yes; -10 V: +/-4 LSB; to +10 V: +/-4 LSB (1 LSB = 4.88 mV)
• Input resistance (-10 V to +10 V)	470 kΩ
Analog outputs	
Number of analog outputs	8; 4 outputs 16 bit; 4 outputs 12 bit
Voltage output, short-circuit protection	Yes; relative to frame
Voltage output, short-circuit current, max.	16 bits: 27 mA; 12 bits: 100 mA
Output ranges, voltage	
• -10 V to +10 V	Yes
Analog value generation for the inputs	
Integration and conversion time/resolution per channel	
• Resolution with overrange (bit including sign), max.	12 bit
• Conversion time (per channel)	45 µs
Analog value generation for the outputs	
Integration and conversion time/resolution per channel	
• Resolution with overrange (bit including sign), max.	4 AO: 16 bits, 4 AO: 12 bits
• Conversion time (per channel)	4 AO (16 bits): 2 µs; 4 AO (12 bits): 4 µs

SIMATIC control systems

FM 458-1 DP application module

EXM 438-1 input/output expansion

Technical specifications (continued)

Article number	6DD1607-0CA1 EXM 438-1 I/O EXPANSION
Encoder	
Number of connectable encoders, max.	12; 8 incremental encoders (synchronizable), 4 absolute encoders
Connectable encoders	
• Incremental encoder (symmetrical)	Yes
• Incremental encoder (asymmetrical)	Yes
• Absolute encoder (SSI)	Yes; Single or multiturn encoder with SSI (synchronous serial) or EnDat interface
Encoder signals, incremental encoder (symmetrical)	
• Trace mark signals	1) for tracks A and B (90° out of phase), poss. with zero pulse N; 2) for separate forward and backward track
• Input signal	With 0 signal: -5 to 0 V; with 1 signal: +3 to +5 V; permissible input voltage range: differential voltage -5 to +5 V; max. input current: 15 mA (important: not limited on module side!)
Encoder signals, incremental encoder (asymmetrical)	
• Trace mark signals	Track A and B (phase-shifted by 90 degrees), possibly with zero pulse N
• Input voltage	with 0 signal: -30 to +4 V (at 15 mA load); with 1 signal: +8 to 30 V (at 15 mA load); permissible input voltage range: differential voltage -30 to +30 V
Encoder signals, absolute encoder (SSI)	
• Input signal	5 V acc. to RS 422
• Data signal	Dual-, Gray-, Gray-Excess-Code
• Clock frequency, max.	2 MHz; 100 kHz to 2 MHz (depending on cable length)
Errors/accuracies	
Linearity error (relative to output range), (+/-)	(+/- 1 LSB)
Potential separation	
Potential separation digital inputs	
• Potential separation digital inputs	No
Potential separation digital outputs	
• Potential separation digital outputs	No
Potential separation analog inputs	
• Potential separation analog inputs	No
Potential separation analog outputs	
• Potential separation analog outputs	No
Weights	
Weight, approx.	1 kg

Ordering data

Article No.

EXM 438-1 input/output expansion	6DD1607-0CA1
For direct exchange of digital and analog signals between FM 458-1 DP and the plant	
SB10 interface module	6DD1681-0AE2
To connect 8 binary inputs or outputs to FM 458-1 DP	
SB61 interface module	6DD1681-0EB3
To connect 8 binary inputs to FM 458-1 DP, input voltage: 24/48 V DC	
SB71 interface module	6DD1681-0DH1
To connect 8 binary outputs to FM 458-1 DP, output voltage: 24/48 V DC	
SU12 interface module	6DD1681-0AJ1
To connect 10 signals to FM 458-1 DP	
SU13 interface module	6DD1681-0GK0
To connect 50 signals to FM 458-1 DP	
SC62 interface cable	6DD1684-0GC0
To connect EXM 438-1 with up to 5 SBxx or SU12	
SC63 interface cable	6DD1684-0GD0
To connect EXM 438-1 with an SU13	

Overview



- Optional plug-in expansion module for the FM 458-1 DP basic module
- For high-speed communication over up to 2 SIMOLINK interfaces
- For coupling several FM 458-1 DP application modules in synchronism with the sampling time

Technical specifications

Article number	6DD1607-0EA2 SIMATIC S7-400 EXM 448-2 COMM.-EXPANS.
Supply voltage	
Rated value (DC)	
• 5 V DC	Yes
Input current	
Current consumption, typ.	0.6 A
Hardware configuration	
Slots	
• required slots	1
Weights	
Weight, approx.	0.9 kg

Ordering data

Article No.

EXM 448-2 universal communication expansion

For high-speed communication with drives; for establishing two SIMOLINK fiber optic connections

6DD1607-0EA2

SIMATIC control systems

FM 458-1 DP application module

D7-SYS

Overview

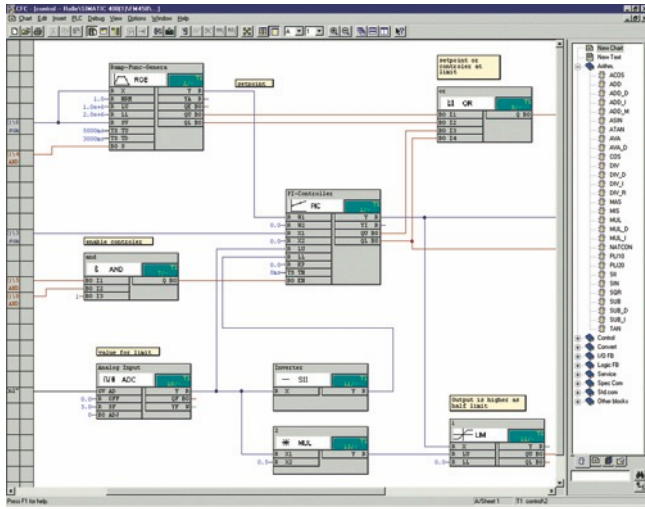

- Optional package for STEP 7 V5.5 for configuring closed-loop control and automation tasks with SIMATIC TDC, FM 458-1 DP and T400
- Extensive block library
- Generation of user libraries in ANSI C with D7-FB-GEN function block generator

Ordering data

Article No.

SIMATIC D7-SYS V8.1

Reference hardware:
SIMATIC TDC, FM 458-1 DP, T400

Requirement:

MS Windows 7 Professional/
Enterprise/Ultimate + SP1
(32/64-bit);
MS Windows XP Professional SP3
(32-bit);
MS Windows Server 2003 R2 SP2
(32-bit) / 2008 R2 SP1 (64-bit);
STEP 7 V5.5 SP4 or higher

Type of delivery:

on DVD, German, English,
with electronic documentation

Floating license

Upgrade license V7.x and higher

Software Update Service¹⁾

SIMATIC Manual Collection

Electronic manuals on DVD,
multilingual: LOGO!, SIMADYN,
SIMATIC bus components, SIMATIC
C7, SIMATIC distributed I/O,
SIMATIC HMI, SIMATIC Sensors,
SIMATIC NET, SIMATIC PC Based
Automation, SIMATIC PCS 7,
SIMATIC PG/PC, SIMATIC S7,
SIMATIC Software, SIMATIC TDC

SIMATIC Manual Collection update service for 1 year

Current "Manual Collection" DVD
and the three subsequent updates

6ES7852-0CC04-0YA5

6ES7852-0CC04-0YE5

6ES7852-0CC01-0YL5

6ES7998-8XC01-8YE0

6ES7998-8XC01-8YE2

¹⁾ For more information on the software update service, see page 11/2.

Accessories

Overview

- Interface modules and interface cables for the FM 458-1 DP application modules

Note:

For information on interface cables SC62, SC63, SC64 and interface modules SB10, SB61, SB71, SU12 and SU13, see SIMATIC TDC multiprocessor control system, accessories, page 10/16.

SIMATIC control systems

SIMATIC TDC multiprocessor control system

Introduction, UR6021 rack

Overview



SIMATIC TDC (Technology and Drives Control) is a digital automation system featuring very high computing power and the ability to process very large programs. An extensive library with approx. 300 ready-made function blocks is available for fast engineering.

Overview UR6021 rack



- UR6021 rack as the base component for SIMATIC TDC
- Integrated system power supply and system fan
- With high-performance 64-bit backplane bus for high-speed data exchange between the inserted modules
- Requirement for operating the CPU555

Ordering data

Article No.

UR6021 racks	6DD1682-0CH3
Spare-part compatible successor of 6DD1682-0CH2	
Accessories	
Slot cover SR51	6DD1682-0DA1
Spare parts	
Backup battery	6ES7971-0BA00
Fan insert for UR6021	6DD1683-0CH3

SIMATIC control systems

SIMATIC TDC multiprocessor control system

CPU555, CPU551 processor module

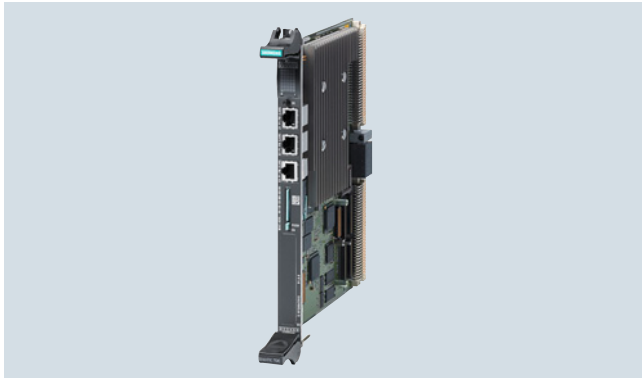
Overview CPU555 processor module

- Graphic freely configurable processor module
- For implementing highly dynamic open and closed-loop control functions

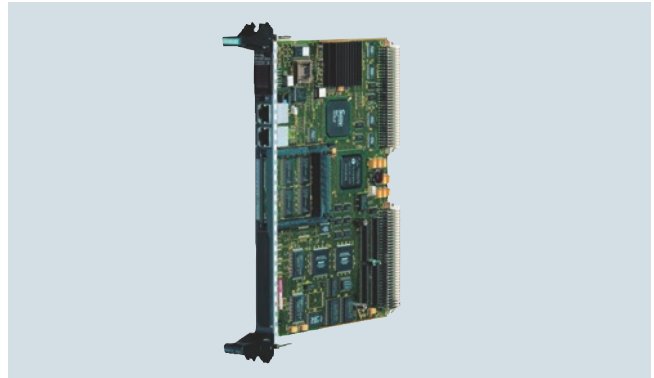
Overview CPU551 processor module

High-performance CPU module for open and closed-loop control and arithmetic tasks.

Ordering data**Article No.**

CPU555 processor module	6DD1600-0BB0
Accessories	
SIMATIC Micro Memory Card	
2 MB	6ES7953-8LL31-0AA0
4 MB	6ES7953-8LM31-0AA0
8 MB	6ES7953-8LP31-0AA0
Crossed twisted pair cables 4x2 with RJ45 connectors	
0.5 m	6XV1870-3RE50
1 m	6XV1870-3RH10
2 m	6XV1870-3RH20
6 m	6XV1870-3RH60
10 m	6XV1870-3RN10

Technical specifications

CPU551	
Required space / width	1 slot
Weight	0.6 kg
Display	5x7 LED
Local service interface	Serial RS232 interface
Sampling intervals	from 100 µs
SDRAM	128 MB
Synchronous cache	8 MB
Clock frequency	500 MHz
CPU	64 Bit RISC CPU with floating point unit
SRAM	512 KB, battery buffered
Power supply	
Voltage / Power supply (at 250°C)	+3.3 V, 2.0 A typical +5 V, 1.5 A typical +12 V, 0.04 A typical -12 V, 0.04 A typical
Buffer battery	3.0 V, 3 µA typical
Power loss, typical	15 W
Digital inputs	
Number	8 inputs, 4 with alarm capability
Galvanic isolation	Only through optional interface modules
Input voltage	
• Rated voltage	24 V
• For 0-signal	-1 V ... +6 V
• For 1-signal	+13.5 V ... +33 V
Input power	
• At 0-signal	0 mA
• At 1-signal	3 mA
Delay time	100 µs
Real-time clock, resolution	0.1 ms

Ordering data**Article No.**

CPU551 processor module	6DD1600-0BA3
Accessories	
MC500 memory module (4 MB)	6DD1610-0AH4
MC510 memory module (8 MB)	6DD1610-0AH6
MC521 memory module (2 MB)	6DD1610-0AH3

SIMATIC control systems

SIMATIC TDC multiprocessor control system

MC5xx program memory module, CP50M1 communications module

Overview MC5xx program memory module

Program memory module for the program designed with CFC.

Ordering data

Article No.

MC500 memory module (4 MB)	6DD1610-0AH4
MC510 memory module (8 MB)	6DD1610-0AH6
MC521 memory module (2 MB)	6DD1610-0AH3

Overview CP50M1 communications module

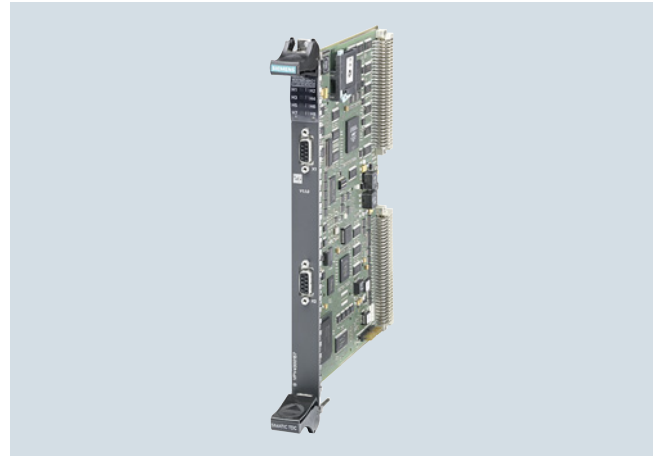

The CP50M1 communications module provides two PROFIBUS DP/MPI interfaces and an 8 MB interprocessor memory for inter-CPU communication. The interfaces can be used as PROFIBUS DP master, slave, as master and slave simultaneously or as MPI node.

Technical specifications

Power supply	
Voltage / Power supply	+5 V, 1.0 A typical
Power loss, typical	5 W
Required space / width	1 slot
Weight	0.34 kg

Ordering data

Article No.

CP50M1 communications module	6DD1661-0AD1
------------------------------	--------------

SIMATIC control systems

SIMATIC TDC multiprocessor control system

CP51M1 communications module, CP53M0 coupling module

Overview CP51M1 communications module

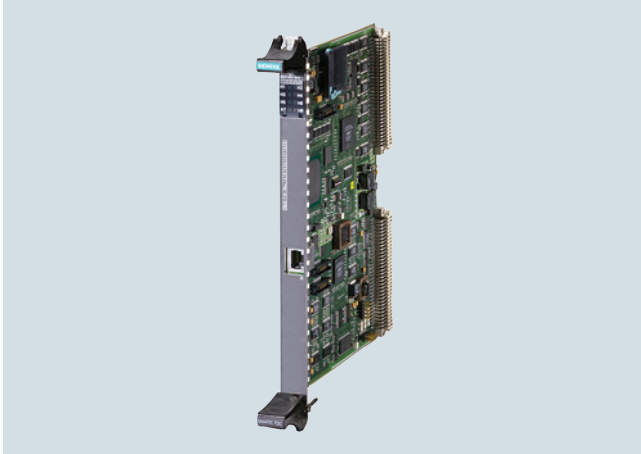

The CP51M1 communications module is an Industrial Ethernet interface for the SIMATIC TDC automation system.

Technical specifications

Up-to-date technical specifications can be taken from the user documentation provided at the start of delivery

Required space / width	1 slot
Weight	
Connection for Industrial Ethernet	RJ45
Protocols	TCP/IP and/or UDP
Message frame lengths	can be larger than 2 KB
Modes of transfer	Refresh, Handshake, Multiple and Select
Autosensing	for 10 Mbit or 100 Mbit network
Default router	adjustable

Ordering data

Ordering data	Article No.
CP51M1 communications module	6DD1661-0AE1

Overview CP53M0 coupling module

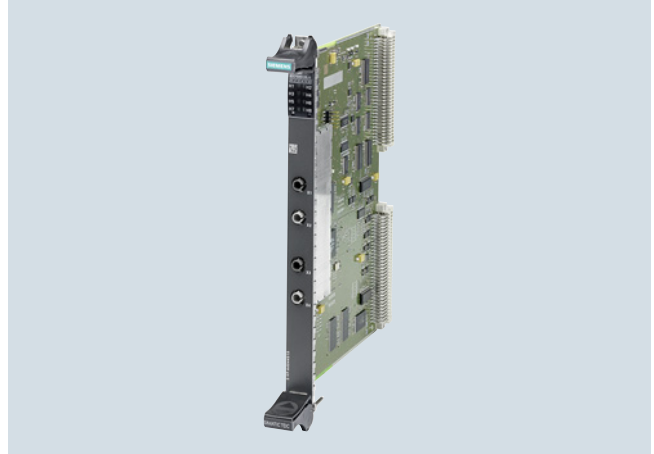

The CP53M0 coupling module allows coupling of a SIMATIC TDC system to a SIMADYN D system for fast data exchange, e.g. when expanding existing SIMADYN D systems.

Technical specifications

CP53M0 coupling module	
Memory	
Communication memory	SRAM, 128 KB
Communications buffer	SDRAM, 8 MB
FOC interface	
Number	2 (master mode) 1 (slave mode)
Data transfer rate	96 Mbit/s
Coding	5B/6B
Voltage, currents	
Voltages / currents	+5 V / 0.3 A 3.3 V / 0.5 A
Power loss	
Power loss, typical	3.1 W
Dimensions	
Number of slots required in rack	1
Dimensions W x H x D (in mm)	20 x 233 x 160
Weight	0.6 kg

Ordering data

Ordering data	Article No.
CP53M0 coupling module	6DD1660-0BJ0
For connection of a SIMATIC TDC system to a SIMADYN D system or to two further SIMATIC TDC racks	

Overview

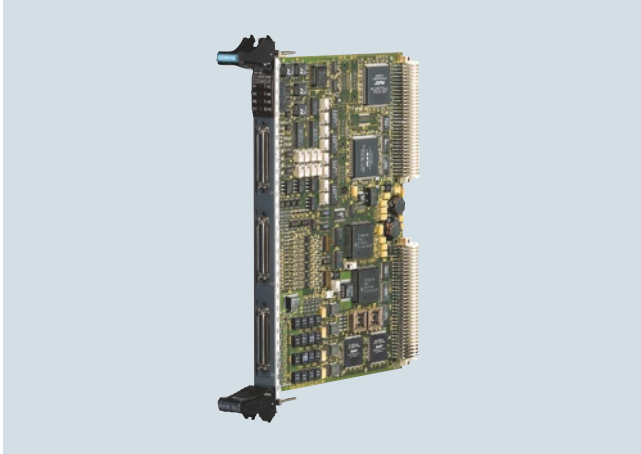

The SM500 I/O module provides analog and digital inputs/outputs as well as incremental and absolute value encoder connections.

Technical specifications

Power supply

Voltage / Power supply (at 25°C)	+5 V typically 1.0 A +3.3 V typically 0.05 A +12 V typically 0.3 A -12 V typically 0.3 A
Typical power loss	12.5 W
Required space / width	1 slot
Weight	0.7 kg

Analog outputs

Number	8
Version	Output with associated ground
Galvanic isolation	No
Output voltage range	-10 V to +10 V
Output current	±10 mA
Resolution	12 bit
Typical conversion time per channel	4 µs
Accuracy:	
• Max. differential linearity error	± 1 LSB (monotony guaranteed)
• Max. amplification error	± 0.3 %
• Max. offset error	± 24 LSB
Slew rate	Approx. 3.5 V/µs
Voltage output:	
• Short-circuit protection to ground	yes
• Short-circuit current	Approximately 100 mA

Analog inputs

Number	8
Version	Differential inputs
Galvanic isolation	No
Input voltage range	-10 V to +10V
Resolution	12 bit
Max. conversion time per channel	Approx. 20 µs
Accuracy:	
• Max. differential linearity error	± 1 LSB (no missing code)
• Max. amplification error	± 0.3 %
• Max. offset error	± 5 LSB
Input resistance	20 kΩ
Input filter	34 kHz
Reverse polarity protection	Yes, as differential inputs are used

Integrating analog inputs (V/f)

Number	4
Version	Differential inputs
Galvanic isolation	No
Input voltage range	-10 V to +10 V
Resolution	Depending on the integration time, e.g. 15 bits for a 4 ms integration time.
Max. integration time per channel	Configurable
Accuracy:	
• Max. amplification error	0.05 %
• Max. integral linearity error	1 %
• Max. offset error	± 2 LSB (software adjustment)
Input resistance	470 kΩ
Input filter	2 kHz
Reverse polarity protection	Yes, as differential inputs are used

Digital outputs

Number	16
Galvanic isolation	Only through optional interface modules
External power supply:	
• Nominal voltage	24 V
• Permissible range	20 to 30
• Short-term	35 V for max. 0.5 s
• Max. current consumption, without load	40mA
Output voltage range:	
• With 0 signal, max.	3 V
• With 1 signal, min.	ext. supply voltage -2.5 V
Output current:	
• With 0 signal, min.	- 20 µA
• With 1 signal	
- Rated value	50 mA
- Permissible range, max.	100 mA
Delay time	100µs
Max. switching frequency of the outputs under resistive load	6 kHz
Short-circuit protection to	
• Mass	yes
• Ext. power supply	No
Max. short-circuit current	250 mA
Total current of outputs (up to 60°C)	16 x 50mA
Limiting of inductive cut-off voltage.	External power supply +1 V

SIMATIC control systems

SIMATIC TDC multiprocessor control system

SM500 I/O module**Technical specifications (continued)****Digital inputs**

Number	16
Electrical isolation	Only through optional interface modules
Input voltage:	
• Nominal voltage	24 V
• For 0-signal	-1 V to +6 V
• For 1-signal	+13.5 V to +33 V
Input current:	
• With 0 signal	0 mA
• With 1 signal	3 mA
Delay time	100 µs

Incremental encoder

Number	4
Connectable types	Incremental encoders with 90 degree track phase offset
Version	Differential inputs, switchable between 15 V (HTL) and 5 V (TTL) encoder signals
Track signals	Tracks A, B with or without zero pulse
Min. phase difference of the track signals	200 ns
Max. pulse frequency (track frequency)	1 MHz
Input voltage:	
• 15 V encoder	
- Permissible range	- 30 V to + 30 V
- With 0 signal	- 30 V to + 4 V
- With 1 signal	+ 8 V to +30 V
• 5 V encoder	
- Permissible range	- 7 V to + 7 V
- With 0 signal	- 7 V to - 0.7 V
- With 1 signal	+1.5 V to + 7 V
Input current	
• With 15 V encoder (typical, absolute)	5.0 mA
• With 5 V encoder (typical, absolute)	1.5 mA
Monitoring output	Not available
Monitoring input	Specification as for digital input
Interrupt reset output	
• Short-circuit protection against ground	yes
- Ext. power supply	No
- Max. short-circuit current	20 mA
Alarm input:	
• Input voltage (permissible range)	0 V to 5 V
- 0 signal, max.	< 0.5 V
- 1 signal, min.	> 2.0 V
• Input current	
- 0 signal	- 2.8 mA
- 1 signal	1.6 mA

Sensor supply voltage

Number	1
Electrical isolation	No
Typical output voltage	13.5 V
Max. output current	150 mA, short-circuit-proof against ground, short-circuit current approx. 250 mA

Absolute encoder inputs

Number	4
Version	Differential inputs, RS485 signal level
Connectable types	Single or multitrack encoder
Protocols	SSI, EnDat
Data formats	Gray code, binary
Data direction	
• Unidirectional	SSI
• Bi-directional	EnDat
Data bits	SSI: 13+Parity, 25+Parity EnDat: variable
Max. pulse frequency	2 MHz, depending on cable length
Input voltage	
• Permissible range	RS485 signal level

Ordering data**Article No.****SM500 I/O module****6DD1640-0AH0**

Overview

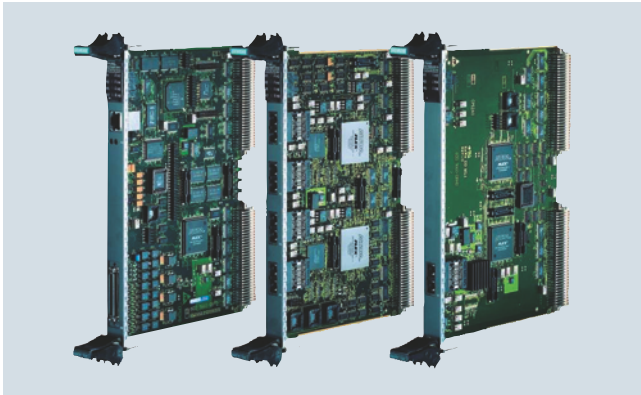

GlobalDataMemory

Data can be exchanged between all of the CPU modules in the system, over all of the networked subracks, using the memory in the GlobalDataMemory (GDM).

Up to 44 subracks can be coupled in synchronism through the central memory. This means that a maximum of 836 CPU modules can be used.

Technical specifications

CP52M0	
Power supply	
Voltage/current supply (at 25 °C)	+5 V typ. 0.4 A +3.3 V typ. 0.7 A +12 V typ. 0.01 A -12 V typ. 0.01 A
Power loss, typical	4.5 W
Space requirement / width	1 slot
Weight	0.6 kg
Digital outputs	
Number	16
Electrical isolation	No
External power supply voltage	
• Rated value	24 V
• Permissible range	20 to 30
• Briefly	35 V, for max. 0.5 s
• Max. current drain (without load)	40 mA
Output voltage range	
• For a 0-signal, max.	3 V
• For a 1-signal min	External power supply -2.5 V
• Output current	
• For a 0-signal, min.	-20 µA
• For a 1-signal	
- Nominal value	50 mA
- Permissible range, max.	100 mA
Delay time	100 µs
Max. switching frequency of the outputs for an ohmic load	6 kHz
Short-circuit protection with respect to	
• Ground	Yes
• Ext. power supply	No
Max. short-circuit current	250 mA
Summed current of the outputs (up to 60 °C)	16 x 50 mA
Limiting, of inductive switch-off voltages	External power supply voltage + 1 V

CP52IO

Power supply

Voltage/current supply (at 25 °C) +5 V typ. 3 A
+3.3 V typ. 0.8 A

Power loss, typical 18 W

Space requirement / width 1 slot

Weight 0.6 kg

CP52A0

Power supply

Voltage/current supply (at 25 °C) +5 V typ. 1.5 A
+3.3 V typ. 0.4 A

Power loss, typical 9 W

Space requirement / width 1 slot

Weight 0.6 kg

Ordering data

Article No.

CP52M0 memory module	6DD1660-0BF0
CP52IO interface module	6DD1660-0BG0
CP52A0 access module	6DD1660-0BH0

SIMATIC control systems

SIMATIC TDC multiprocessor control system

Accessories

Overview SB10 interface module

Similar to figure.

The interface module is used to connect 8 digital inputs or outputs.

Overview SB70 interface module

The interface module is used to connect 8 digital outputs with conversion of the 24 V DC voltage on the module side to a max. of 120 V DC/AC on the plant side using relays.

Overview SB60 interface module

Interface module for connecting 8 digital inputs with 120 V DC/AC to 24 V DC conversion.

Overview SB71 interface module

The interface module is used to connect 8 digital outputs with conversion of the 24 V DC voltage on the module side to a max. of 24/48 V DC/AC on the plant side using transistors.

Overview SB61 interface module

It is used to connect 8 digital inputs with conversion from 24/48 V DC to 24 V DC.

Overview SC62 interface cable

This cable is used to connect the SIMATIC TDC SM500 I/O module or the SIMATIC S7-400 EXM 438-1 expansion module to up to 5 interface modules SB10, SB60, SB70, SB61 SB71 and/ or SU12.

Overview SC63 interface cable



This cable is used to connect the SIMATIC TDC SM500 I/O module or the SIMATIC S7-400 EXM 438-1 expansion module to a SU13 interface module.

Overview SC64 interface cable



(Similar to figure)

Interface cable for FM 458-1 DP basic module and SB10, SB60, SB61 and SU12 interface modules.

Overview SC66 interface cable



Interface cable for the SIMATIC TDC CPU551 processor module and the SB10, SB60, SB61 and SU12 interface modules

Overview SU12 interface module



The interface module is used to connect 10 signals; there is no electronic conversion.

Overview SC67 service cable



Service cable for the SIMATIC TDC CPU551 module and a local configuration / service PC.

Overview SU13 interface module



This interface module can be used to connect 50 signals; there is no electronic conversion.

SIMATIC control systems

SIMATIC TDC multiprocessor control system

Accessories

Technical specifications

Technical data for interface module SB 10

Number of digital inputs/outputs	8
Galvanic isolation	No
Connectable conductor cross-section	1.5 mm ²
Dimensions (W x H x D) in mm	45 x 130 x 156
Weight	0.3 kg

Technical data for interface module SB 60

Number of digital inputs	8
• Input voltage	120 V DC/AC
Insulation voltage	<ul style="list-style-type: none"> • Safe isolation assured between inputs and outputs • Galvanic isolation assured between input circuits • 1125 V AC test voltage
Connectable conductor cross-section	1.5 mm ²
Dimensions (W x H x D) in mm	45 x 130 x 156
Weight	0.31 kg

Technical data for interface module SB 61

Number of digital inputs	8
• Input voltage	24/48 V DC
Galvanic isolation	Yes, via optocoupler
Connectable conductor cross-section	1.5 mm ²
Dimensions (W x H x D) in mm	45 x 130 x 156
Weight	0.32 kg

Technical data for interface module SB 70

Number of digital outputs	8
• Output voltage, max.	120 V DC/AC
Relay switching current	
• At 120 V AC	2 A
• At 120 V DC	0.2 A
Galvanic isolation	via relay
Insulation voltage	<ul style="list-style-type: none"> • Safe isolation assured between inputs and outputs • Galvanic isolation assured between input circuits • 1125 V AC test voltage
Connectable conductor cross-section	1.5 mm ²
Dimensions (W x H x D) in mm	45 x 130 x 156
Weight	0.32 kg

Technical data for interface module SB 71

Number of digital outputs	8
• Output voltage, max.	24/48 V DC
Output current, max.	40 mA, short-circuit proof
Galvanic isolation	Yes, via optocoupler
Connectable conductor cross-section	1.5 mm ²
Dimensions (W x H x D) in mm	45 x 130 x 156
Weight	0.32 kg

Technical data for interface module SU 12

Number of connectable signal lines	10
Signal strength per signal, max.	60 V, 0.5 A
Galvanic isolation	No
Connectable conductor cross-section	1.5 mm ²
Dimensions (W x H x D) in mm	45 x 130 x 156
Weight	0.28 kg

Technical data for interface module SU 13

Number of connectable signal lines	50
Signal strength per signal, max.	60 V, 0.5 A
Galvanic isolation	No
Connectable conductor cross-section	1.5 mm ²
Dimensions (W x H x D) in mm	45 x 130 x 156
Weight	0.3 kg

Ordering data

Article No.

SB10 interface module	6DD1681-0AE2
8 digital inputs/outputs, 24 V DC	
SB60 interface module	6DD1681-0AF4
8 digital inputs, 120 V AC	
SB61 interface module	6DD1681-0EB3
8 digital inputs, 24/48 V DC	
SB70 interface module	6DD1681-0AG2
8 digital outputs with relays	
SB71 interface module	6DD1681-0DH1
8 digital outputs with transistors, 24/48 V DC	
SC62 interface cable	6DD1684-0GC0
between SM500 or EXM 438-1 module and max. 5 SB10, SB60, SB70, SB61, SB71 and/or SU12 interface modules, 2 m long	
SC63 interface cable	6DD1684-0GD0
between SM500 or EXM 438-1 module and SU13 interface module, 2 m long	
SC64 interface cable	6DD1684-0GE0
between FM 458-1 DP (X2) module with SBxx or SU12 interface module, 2 m long	
SC66 interface cable	6DD1684-0GG0
between CPU551 and interface module SB10, SB60, SB61 or SU12, 2 m long	
SC67 service cable	6DD1684-0GH0
between CPU551 and PG/PC, 7 m long	
SU12 interface module	6DD1681-0AJ1
with plug-in connector, 10-pole	
SU13 interface module	6DD1681-0GK0
with screw-type plug-in connector	

Software for SIMATIC Controllers

**11/2 Introduction**

- 11/2 Information on software licensing
- 11/2 Software Update Service

11/3 TIA Portal

- 11/3 PLC programming
- 11/3 STEP 7 Basic V14 (TIA Portal)
- 11/5 STEP 7 Professional V14 (TIA Portal)
- 11/8 STEP 7 (TIA Portal) options
 - STEP 7 Safety (TIA Portal)
 - S7-PLCSIM Advanced
 - Target 1500S for Simulink
 - PID Professional (TIA Portal)
 - Easy Motion Control (TIA Portal)
 - OPC UA S7-1500
- 11/14 TIA Portal options
- 11/14 TIA Portal Multiuser Engineering
- 11/14 TIA Portal Cloud Connector
- 11/15 TIA Portal Teamcenter Gateway
- 11/15 SIMATIC ProDiag
- 11/16 SIMATIC Visualization Architect

11/17 STEP 7 V5.x

- 11/17 Basic software and editors
- 11/17 STEP 7
- 11/19 STEP 7 Professional
- 11/22 S7-SCL
- 11/24 S7-GRAPH
- 11/26 S7-PLCSIM
- 11/27 Options for programming and design
- 11/27 CFC
- 11/29 S7 Distributed Safety
- 11/30 S7 F/FH systems
 - S7 F Systems
 - SIMATIC Safety Matrix
- 11/34 Software redundancy
- 11/35 SIMATIC iMap
- 11/37 DOCPRO
- 11/38 Options for diagnostics and service
- 11/38 S7-PDIAG
- 11/39 TeleService
- 11/43 PRODAVE
- 11/44 Options for technology and drive systems
- 11/44 Loadable function blocks
 - Standard PID Control
 - Modular PID Control
 - PID Self-Tuner
- 11/50 S7 Technology
- 11/51 Easy Motion Control
- 11/52 D7-SYS
- 11/53 Drive ES engineering software
- 11/54 Additional software
- 11/54 KNX/EIB2S7

11/55 Software for common tasks

- 11/55 For network planning/commissioning
- 11/55 SINETPLAN network planning
- 11/56 For maintenance
- 11/56 SIMATIC PDM
- 11/61 For administration
- 11/61 Version Cross Manager
- 11/62 Version Trail

Brochures

For brochures serving as selection guides for SIMATIC products, refer to:
www.siemens.com/simatic/printmaterial

Software for SIMATIC Controllers

Introduction

Information on software licensing, Software Update Service

Overview Licensing

Siemens Digital Factory offers various types of software license.

For more information, see catalog section 16, page 16/16.

Overview Software Update Service

- Service for automatic dispatch of all new software versions during contract lifetime
- Reduced logistics effort thanks to automatic contract extension
- Reduced costs as updates are provided free of charge

Ordering

- The Software Update Service is ordered in the same way as any other product. The corresponding order number is given in the ordering information of the software product in question.
- You must own the current version of the software.
- One Software Update Service is ordered for each software license installed.
- The Software Update Service runs for 1 year from date of order.
- It is extended automatically by a further year in each case, as long as it is not canceled 3 months before it expires.
- An annual lump sum is invoiced per license.

Application

SIMATIC software is continuously enhanced and improved. The **Software Update Service** is the easiest way to regularly take advantage of these improvements. This service automatically sends new software updates when they are released so you always have the latest version.

The Software Update Service

- Saves time and effort:
Once it is ordered, the Software Update Service is automatically renewed every year.
- Lowers costs:
The service pays for itself after the first update as it costs less than an individually ordered update.
- Makes budgeting easier:
Software expenditures can be accounted for early in the budgeting process and they are easier to write off.

Design

Scope of delivery

- All software versions released after ordering the Software Update Service (usually several consignments per year)
- SIMATIC Customer Support Knowledge Base CD-ROM with FAQs, tips & tricks and downloads (several issues per year)

Overview

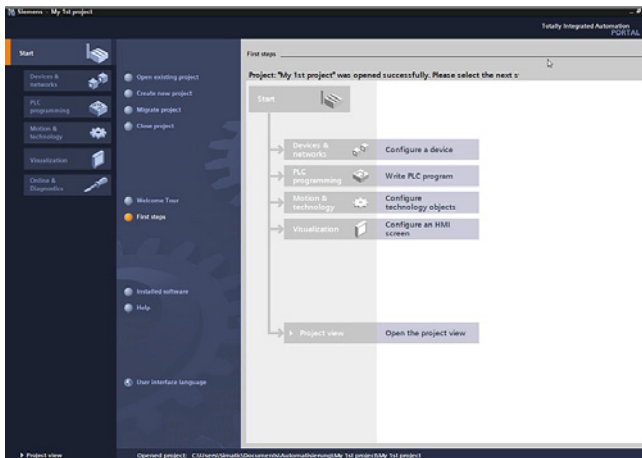

STEP 7 Basic V14 SP1 (TIA Portal), portal view

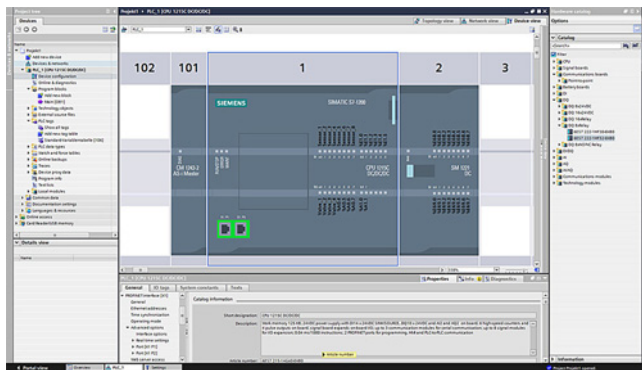

STEP 7 Basic V14 SP1 (TIA Portal), device view: configuring and parameterizing in realistic photo-quality representation

Intuitive, efficient and future-oriented - the engineering software for programming SIMATIC controllers

SIMATIC STEP 7 Basic V14 is the engineering system for the S7-1200.

STEP 7 Basic V14 is based on the Totally Integrated Automation Portal (TIA Portal) central engineering framework which offers users a uniform, efficient and intuitive solution to all automation tasks.

New with V14

- Useful function extensions in the language editors for LAD/FBD and SCL
- Systematic further development of language elements for programming (Array[*], Array of multi-instances, etc.)
- Higher-level measurement with Trace
- New configuring of toolbar in the DB Editor
- New system functions, e.g. global search and extended cross-reference information
- Multiple usability expansions for efficient engineering

New with V14 SP1

- Further useful function expansions of the language editors (e.g. password-based block write-protection)
- Function expansions in the Devices and Networks Editor (e.g. simplified renaming of PROFINET I/O devices)
- New functions, e.g. Polyline, SCATTER, GATHER
- Individual commenting by UDT instances and array members
- Simplified upgrading of types (blocks, PLC data types) in an existing project library
- Import and export of CAx data by means of the AutomationML format
- Modification of the hardware configuration via the TIA Portal Openness API

Technical specifications

	STEP 7 Basic V14 (TIA Portal)
Type of license	Floating license
Software class	A
Current version	V14 SP1
Target system	SIMATIC S7-1200
Minimum software and hardware requirements	
Processor	Intel Core i3-6100M 2.30 GHz or higher
RAM	4 GB
Hard disk	SATA with at least 8 GB storage space
Network	100 Mbit or more
Screen resolution	1024 x 768
Operating systems	Windows 7 (64-bit) <ul style="list-style-type: none"> • Windows 7 Home Premium SP1 • Windows 7 Professional SP1 • Windows 7 Enterprise SP1 • Windows 7 Ultimate SP1 Windows 8.1 (64-bit) <ul style="list-style-type: none"> • Windows 8.1 • Windows 8.1 Professional • Windows 8.1 Enterprise Windows 10 (64-bit) <ul style="list-style-type: none"> • Windows 10 Home Version 1607 • Windows 10 Professional Version 1607 • Windows 10 Enterprise Version 1607 • Windows 10 Enterprise 2016 LTSB • Windows 10 Enterprise 2015 LTSB Windows Server (64-bit) <ul style="list-style-type: none"> • Windows Server 2008 R2 StdE SP1 (full installation) • Windows Server 2012 R2 StdE (full installation) • Windows Server 2016 Standard (full installation)
Recommended PC hardware	
Computer	SIMATIC Field PG M5 Advanced or higher (or comparable PC)
Processor	Intel Core i5-6440EQ (up to 3.4 GHz)
RAM	16 GB or more (32 GB for large projects)
Hard disk	SSD with at least 50 GB storage space available
Network	1 Gbit (for multi-user)
Screen	15.6" full HD display (1920 x 1080 or higher)

Software for SIMATIC Controllers

TIA Portal

PLC programming

STEP 7 Basic V14 (TIA Portal)

Technical specifications (continued)

Compatibility with other SIMATIC products

STEP 7 Professional / Basic V14 SP1 (incl. WinCC Basic V14 SP1) can be installed on a PC in parallel with other versions of STEP 7 V11 to V13 SP2, STEP 7 V5.5 SP4, STEP 7 Micro/WIN V4.0 SP9, WinCC flexible 2008 SP3 and WinCC (from V7.2).

A project upgrade to TIA Portal V14 is carried out exclusively on the basis of TIA Portal V13 SP1 projects (latest update recommended). In order to provide you with the best possible support here, the current version of V13 SP2 is included with the V14 products. A compatibility mode is not supported.

Ordering data

STEP 7 Basic V14 SP1

Target system:

SIMATIC S7-1200

Requirement:

Windows 7 Home Premium SP1 (64-bit), Windows 7 Professional SP1 (64-bit), Windows 7 Enterprise SP1 (64-bit), Windows 7 Ultimate SP1 (64-bit), Windows 8.1 (64-bit), Windows 8.1 Professional (64-bit), Windows 8.1 Enterprise (64-bit), Windows 10 Home Version 1607, Windows 10 Professional Version 1607, Windows 10 Enterprise Version 1607, Windows 10 Enterprise 2016 LTSB, Windows 10 Enterprise 2015 LTSB, Windows Server 2008 R2 StdE (full installation), Windows Server 2012 StdE (full installation), Windows Server 2016 Standard (full installation);
Type of delivery:
German, English, Chinese, Italian, French, Spanish

STEP 7 Basic V14 SP1, floating license

6ES7822-0AA04-0YA5

STEP 7 Basic V14 SP1, floating license, software download incl. license key¹⁾

6ES7822-0AE04-0YA5

Email address required for delivery

STEP 7 Basic V14 SP1, trial license

6ES7822-0AA04-0YA7

Upgrade STEP 7 Basic V12/V13 to STEP 7 Basic V14 SP1, floating license

6ES7822-0AA04-0YE5

Upgrade STEP 7 Basic V12/V13 to STEP 7 Basic V14 SP1, floating license, software download incl. license key¹⁾

6ES7822-0AE04-0YE5

Email address required for delivery

Powerpack STEP 7 Basic V14 SP1 to STEP 7 Professional V14 SP1, floating license

6ES7822-1AA04-0YC5

Powerpack STEP 7 Basic V14 SP1 to STEP 7 Professional V14 SP1, floating license, software download incl. license key¹⁾

6ES7822-1AE04-0YC5

Email address required for delivery

Article No.

Software Update Service

For a period of 12 months and for a fixed price, the customer is automatically provided with all upgrades and service packs for each installed software package. The contract is automatically extended by a further year unless canceled at least 12 weeks prior to expiration. Requires the current software version

Software Update Service (Standard Edition)²⁾

The delivery is implemented according to the number of ordered SUS products (e.g. 10 upgrade packages with 10 DVDs, 10 USB sticks, etc.)

- STEP 7 Basic

6ES7822-0AA00-0YL0

Software Update Service (Compact Edition)²⁾

The delivery items are combined. For several contracts, only 1 package with 1 data storage medium set, 1 USB stick with the corresponding number of licenses and the corresponding number of COLs will be supplied.

Delivery items to be combined must be ordered as one item.

- STEP 7 Basic

6ES7822-0AA00-0YM0

Software Update Service (download)²⁾

The upgrades and service packs are available for downloading.

Email address required for delivery

- STEP 7 Basic

6ES7822-0AE00-0YY0

¹⁾ For up-to-date information and download availability, see: <http://www.siemens.com/tia-online-software-delivery>

²⁾ For more information on the Software Update Service, see page 11/2.

Overview

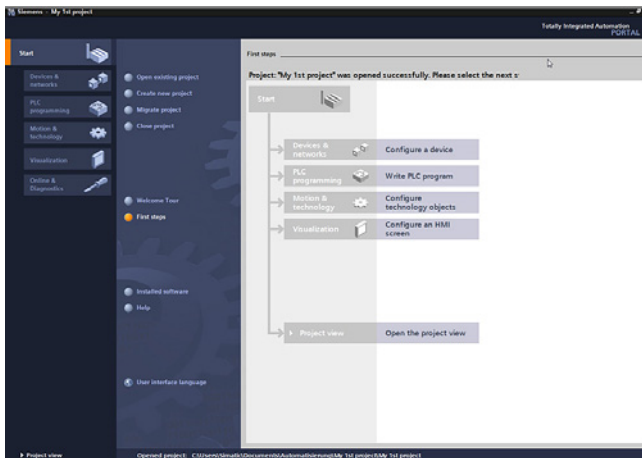

STEP 7 Professional V14 SP1 (TIA Portal), portal view

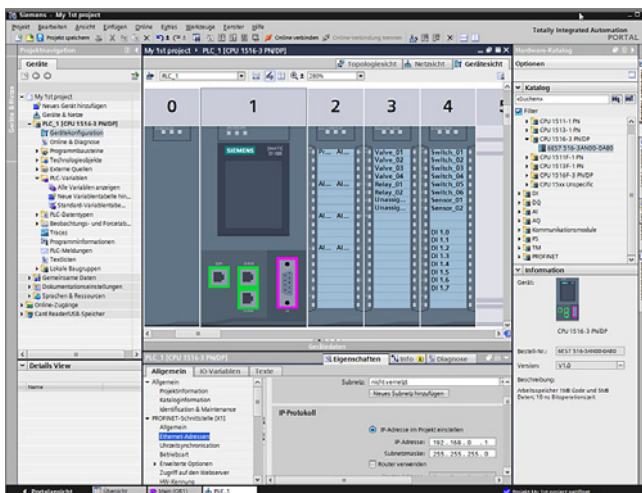

STEP 7 Professional V14 SP1 (TIA Portal), device view configuring and parameterizing in realistic photo-quality representation

Intuitive, efficient and future-oriented - the engineering software for programming the SIMATIC controllers

SIMATIC STEP 7 Professional V14 is the engineering system for the SIMATIC S7-1200, S7-1500, S7-300, S7-400 Controllers, WinAC and Software Controllers.

STEP 7 V14 is based on the Totally Integrated Automation Portal (TIA Portal) central engineering framework, which offers users a uniform, efficient and intuitive solution for all automation tasks.

New with V14

- Supports new S7-1500T family, CPU 1518(F)-4 PN/DP ODK, CPU 1516pro (F)-2 PN and S7-1500 fail-safe Software Controllers
- Useful function extensions in the language editors for LAD/FBD, S7-Graph and SCL
- Systematic further development of language elements for programming (Array[*], Array of multi-instances, etc.)
- Preconfigured and integrated connection and configuring of the SINAMICS V90 PN drive to a SIMATIC S7-1500 motion control technology object
- Higher-level measurement with Trace
- New configuring of toolbar in the DB Editor
- New system functions, e.g. global search and extended cross-reference information
- Multiple usability expansions for efficient engineering

New with V14 SP1

- Useful function extensions in the language editors for LAD/FBD and SCL
- Systematic further development of language elements for programming (Array[*], Array of multi-instances, etc.)
- Higher-level measurement with Trace
- New configuring of toolbar in the DB Editor
- New system functions, e.g. global search and extended cross-reference information
- Multiple usability expansions for efficient engineering

Software for SIMATIC Controllers

TIA Portal

PLC programming

STEP 7 Professional V14 (TIA Portal)

Technical specifications

STEP 7 Professional V14 (TIA Portal)	
Type of license	Floating license
Software class	A
Current version	V14 SP1
Target system	SIMATIC S7-1200, S7-1500, S7-300, S7-400, WinAC, software controllers
Minimum software and hardware requirements	
Processor	Intel Core i3-6100M 2.30 GHz or higher
RAM	4 GB
Hard disk	SATA with at least 8 GB storage space
Network	100 Mbit or more
Screen resolution	1024 x 768
Operating systems	Windows 7 (64-bit) <ul style="list-style-type: none"> • Windows 7 Professional SP1 • Windows 7 Enterprise SP1 • Windows 7 Ultimate SP1 Windows 8.1 (64-bit) <ul style="list-style-type: none"> • Windows 8.1 Professional • Windows 8.1 Enterprise Windows 10 (64-bit) <ul style="list-style-type: none"> • Windows 10 Professional Version 1607 • Windows 10 Enterprise Version 1607 • Windows 10 Enterprise 2016 LTSC • Windows 10 Enterprise 2015 LTSC Windows Server (64-bit) <ul style="list-style-type: none"> • Windows Server 2008 R2 StdE SP1 (full installation) • Windows Server 2012 R2 StdE (full installation) • Windows Server 2016 Standard (full installation)
Recommended PC hardware	
Computer	SIMATIC Field PG M5 Advanced or higher (or comparable PC)
Processor	Intel Core i5-6440EQ (up to 3.4 GHz)
RAM	16 GB or more (32 GB for large projects)
Hard disk	SSD with at least 50 GB storage space available
Network	1 Gbit (for multi-user)
Screen	15.6" full HD display (1920 x 1080 or higher)

Compatibility with other SIMATIC products

STEP 7 Professional / Basic V14 SP1 (incl. WinCC Basic V14 SP1) can be installed on a PC in parallel with other versions of STEP 7 V11 to V13 SP2, STEP 7 V5.5 SP4, STEP 7 Micro/WIN V4.0 SP9, WinCC flexible 2008 SP3 and WinCC (from V7.2).

A project upgrade to TIA Portal V14 is carried out exclusively on the basis of TIA Portal V13 SP1 projects (latest update recommended). In order to provide you with the best possible support here, the current version of V13 SP2 is included with the V14 products. A compatibility mode is not supported.

Ordering data

Article No.

STEP 7 Professional V14 SP1

Target system:
SIMATIC S7-1200, S7-1500, S7-300, S7-400, WinAC

Requirement:
Windows 7 Professional SP1 (64-bit),
Windows 7 Enterprise SP1 (64-bit),
Windows 7 Ultimate SP1 (64-bit),
Windows 8.1 Professional (64-bit),
Windows 8.1 Enterprise (64-bit),
Windows 10 Professional Version 1607,
Windows 10 Enterprise Version 1607,
Windows 10 Enterprise 2016 LTSC,
Windows 10 Enterprise 2015 LTSC,
Windows Server 2008 R2 StdE (full installation),
Windows Server 2012 StdE (full installation),
Windows Server 2016 Standard (full installation);

Type of delivery:
German, English, Chinese, Italian, French, Spanish

STEP 7 Professional V14 SP1, floating license

6ES7822-1AA04-0YA5

STEP 7 Professional V14 SP1, floating license, software download incl. license key ¹⁾

6ES7822-1AE04-0YA5

Email address required for delivery

STEP 7 Professional V14 SP1, trial license

6ES7822-1AA04-0YA7

Conversion package STEP 7 Professional V14 SP1

Only valid if ordered together with software update service 6ES7810-5CC04-0YE2 (STEP 7 Professional and STEP 7 Professional in TIA Portal).

- PowerPack & upgrade from STEP 7 V5.5 to STEP 7 Professional 2010/V14 SP1, floating license. Prerequisite is an existing STEP 7 Software Update Service.
- PowerPack & upgrade from STEP 7 V5.5 to STEP 7 Professional 2010/V14 SP1, floating license. Prerequisite is an existing STEP 7 Software Update Service. Software download incl. license key ¹⁾
Email address required for delivery

6ES7822-1AA04-0XC2

6ES7822-1AE04-0XC2

¹⁾ For up-to-date information and download availability, see: <http://www.siemens.com/tia-online-software-delivery>

Ordering data	Article No.	Article No.
Upgrade from STEP 7 Professional V11...13 to STEP 7 Professional V14 SP1 or STEP 7 Professional V11... V13/2010 Combo to V14 SP1/2010 combo, floating license	6ES7822-1AA04-0YE5	Software Update Service For a period of 12 months and for a fixed price, the customer is automatically provided with all upgrades and service packs for each installed software package. The contract is automatically extended by a further year unless canceled at least 12 weeks prior to expiration. Requires the current software version
Upgrade from STEP 7 Professional V11...13 to STEP 7 Professional V14 SP1 or STEP 7 Professional V11... V13/2010 Combo to V14 SP1/2010 combo, floating license, software download incl. license key¹⁾ Email address required for delivery	6ES7822-1AE04-0YE5	
Upgrade from STEP 7 Professional 2006/2010 to STEP 7 Professional 2010/V14 SP1 combo, floating license	6ES7822-1AA04-0XE5	Software Update Service (Standard Edition)²⁾ The delivery is implemented according to the number of ordered SUS products (e.g. 10 upgrade packages with 10 DVDs, 10 USB flash drives, etc.) <ul style="list-style-type: none"> STEP 7 Professional V1x STEP 7 Professional and STEP 7 Professional in the TIA Portal
Upgrade from STEP 7 Professional 2006/2010 to STEP 7 Professional 2010/V14 SP1 combo, floating license, software download incl. license key¹⁾ Email address required for delivery	6ES7822-1AE04-0XE5	
PowerPack STEP 7 Professional V14 SP1 Trial 365 to STEP 7 Prof. V14 SP1, floating license. Only valid if ordered together with Software Update Service 6ES7822-1AE00-0YY0 (STEP 7 Professional V1x) Prerequisite is a STEP 7 V13 Trial 365 license. License key download ¹⁾ Email address required for delivery	6ES7822-1BE04-0YC5	Software Update Service (Compact Edition)²⁾ The delivery items are combined. For several contracts, only 1 package with 1 data storage medium set, 1 USB flash drive with the corresponding number of licenses and the corresponding number of COLs will be supplied. Delivery items to be combined must be ordered as one item. <ul style="list-style-type: none"> STEP 7 Professional V1x STEP 7 Professional and STEP 7 Professional in the TIA Portal
Fifty hours of engineering with STEP 7 Professional Combo, WinCC Professional (incl. WinCC flexible 2008) and STEP 7 Safety Advanced (incl. Distributed Safety)	6ES7823-1GE04-0YA5	
PowerPack & upgrade from STEP 7 V5.4/V5.5 to STEP 7 Professional 2010/V14 SP1 combo, floating license	6ES7822-1AA04-0XC5	Software Update Service (download)²⁾ The upgrades and service packs are available for downloading. Email address required for delivery <ul style="list-style-type: none"> STEP 7 Professional V1x STEP 7 Professional and STEP 7 Professional in the TIA Portal
PowerPack & upgrade from STEP 7 V5.4/V5.5 to STEP 7 Professional 2010/V14 SP1 combo, floating license, software download incl. license key¹⁾ Email address required for delivery	6ES7822-1AE04-0XC5	

¹⁾ For up-to-date information and download availability, see: <http://www.siemens.com/tia-online-software-delivery>

²⁾ For more information on the Software Update Service, see page 11/2.

Software for SIMATIC Controllers

TIA Portal
PLC programming

STEP 7 (TIA Portal) options > STEP 7 Safety (TIA Portal)

Overview

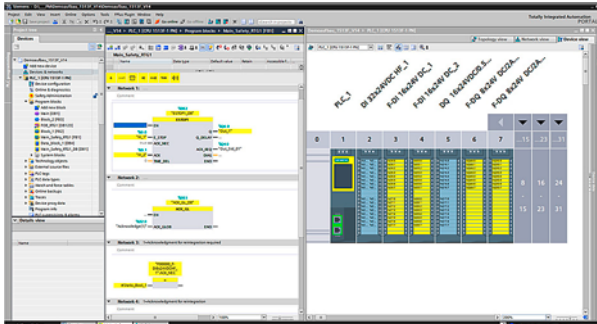

STEP 7 Safety Advanced V14 SP1, configuration and programming

- For creating safety-related programs on the STEP 7 operator interface
- For seamless and easy to use integration of safety-related functions into the standard automation
- All the required configuration and programming tools are integrated into the STEP 7 operator interface and utilize a common project structure
- STEP 7 Safety Basic option package for parameter assignment and programming of the fail-safe S7-1200
- STEP 7 Safety Advanced option package for all fail-safe TIA SIMATIC controller classes (S7-1200, S7-1500, S7-300, S7-400, WinAC)

Ordering data

Article No.

Article No.

STEP 7 Safety Advanced V14 SP1

Task:

Engineering tool for configuring and programming fail-safe user programs for SIMATIC S7-1200 FC, S7-1500F, S7-1500F Software Controllers, S7-300F, S7-400F, WinAC RTX F, ET 200SP F Controllers and the fail-safe ET 200SP, ET 200S, ET 200M, ET 200iSP, ET 200pro and ET 200eco I/O

Requirement:

STEP 7 Professional V14 SP1

Floating license for 1 user, software and documentation on DVD; license key on USB flash drive

Floating license for 1 user, software, documentation and license key for download²⁾; Email address required for delivery

Software Update Service (Standard Edition)¹⁾

The delivery is implemented according to the number of ordered SUS products (e.g. 10 upgrade packages with 10 DVDs, 10 USB flash drives, etc.). Requires the current software version.

Software Update Service (Compact Edition)¹⁾

The delivery items are combined. For several contracts, only 1 package with 1 data storage medium set, 1 USB flash drive with the corresponding number of licenses and the corresponding number of COLs will be supplied. The deliveries that are to be grouped together must be ordered as a single item. Requires the current software version.

Minimum order quantity: 3 units

Software Update Service (Download)¹⁾

Requires the current software version.

Email address required for delivery.

6ES7833-1FA14-0YA5

6ES7833-1FA14-0YH5

6ES7833-1FC00-0YX2

6ES7833-1FC00-0YM2

6ES7833-1FC00-0YY0

STEP 7 Safety Advanced Upgrade

Upgrade from Distributed Safety V5.4 SP5 to STEP 7 Safety Advanced V14 SP1 for parallel use of both versions; upgrade of combo license for 1 user; software and documentation on DVD, license key on USB flash drive

Upgrade from Distributed Safety V5.4 SP5 to STEP 7 Safety Advanced V14 SP1 for parallel use of both versions; upgrade of combo license for 1 user; software, license key and documentation for download²⁾; Email address required for delivery

Upgrade from STEP 7 Safety Advanced V11 ... V13 to STEP 7 Safety Advanced V14 SP1 for parallel use of versions; upgrade of license for 1 user; software and documentation on DVD, license key on USB flash drive

Upgrade from STEP 7 Safety Advanced V11 ... V13 to STEP 7 Safety Advanced V14 SP1 for parallel use of versions; upgrade of license for 1 user; software, license key and documentation for download²⁾; Email address required for delivery

STEP 7 Safety Advanced PowerPack

PowerPack STEP 7 Safety Basic V14 SP1 to STEP 7 Safety Advanced V14 SP1; floating license for 1 user; license key on USB flash drive

PowerPack STEP 7 Safety Basic V14 SP1 to STEP 7 Safety Advanced V14 SP1; floating license for 1 user; license key for download²⁾; Email address required for delivery

6ES7833-1FA14-0YF5

6ES7833-1FA14-0YY5

6ES7833-1FA14-0YE5

6ES7833-1FA14-0YK5

6ES7833-1FA14-0YC5

6ES7833-1FA14-0YJ5

¹⁾ For more information on the Software Update Service, see page 11/2.

²⁾ For up-to-date information and download availability, see: <http://www.siemens.com/tia-online-software-delivery>

Ordering data	Article No.	Article No.
<p>STEP 7 Safety Advanced V14 SP1 Trial</p> <p>Trial license, valid for 21 days; software and documentation on DVD; executable with TIA Portal V14 SP1 from STEP 7 Professional V14 or higher; for configuring S7-1200 FC, S7-1500F, S7-1500F Software Controllers, S7-300F, S7-400F, WinAC F</p>	6ES7833-1FA14-0YA8	<p>STEP 7 Safety Basic Upgrade</p> <p>Upgrade from STEP 7 Safety Basic V13 SP1 to STEP 7 Safety Basic V14 SP1 for parallel use of the versions; upgrade license for 1 user; software and documentation on DVD, license key on USB flash drive</p> <p>Upgrade from STEP 7 Safety Basic V13 SP1 to STEP 7 Safety Basic V14 SP1 for parallel use of the versions; upgrade license for 1 user; software, license key and documentation for download²⁾; Email address required for delivery</p> <p><u>Software Update Service (Standard Edition)</u>¹⁾</p> <p>The delivery is implemented according to the number of ordered SUS products (e.g. 10 upgrade packages with 10 DVDs, 10 USB flash drives, etc.). Requires the current software version.</p> <p><u>Software Update Service (Compact Edition)</u>¹⁾</p> <p>The delivery items are combined. For several contracts, only 1 package with 1 data storage medium set, 1 USB flash drive with the corresponding number of licenses and the corresponding number of COLs will be supplied. The deliveries that are to be grouped together must be ordered as a single item. Requires the current software version.</p> <p>Minimum order quantity: 3 units</p> <p><u>Software Update Service (Download)</u>¹⁾</p> <p>Requires the current software version.</p> <p>Email address required for delivery.</p>
<p>STEP 7 Safety Basic V14 SP1</p> <p>Task: Engineering tool for configuring fail-safe user programs for SIMATIC S7-1200 FC</p> <p>Requirement: STEP 7 Basic V14 SP1 and higher</p> <p>Floating license for 1 user, software and documentation on DVD, license key on USB flash drive</p> <p>Floating license for 1 user, software, documentation and license key for download²⁾; Email address required for delivery</p>	<p>6ES7833-1FB14-0YA5</p> <p>6ES7833-1FB14-0YH5</p>	<p>6ES7833-1FB14-0YE5</p> <p>6ES7833-1FB14-0YK5</p> <p>6ES7833-1FD00-0YX2</p> <p>6ES7833-1FD00-0YM2</p> <p>6ES7833-1FD00-0YN2</p>

¹⁾ For more information on the Software Update Service, see page 11/2.

²⁾ For up-to-date information and download availability, see: <http://www.siemens.com/tia-online-software-delivery>

Software for SIMATIC Controllers

TIA Portal

PLC programming

STEP 7 (TIA Portal) options > S7-PLCSIM Advanced, Target 1500S for Simulink

Overview SIMATIC S7-PLCSIM Advanced

With SIMATIC S7-PLCSIM Advanced, virtual controllers can be used for simulation of S7-1500 and ET 200SP Controllers and for extensive function simulation.

The virtual controllers can also be tested and validated in conjunction with a plant/machine. An extensive API is available for interfacing plant/machine simulations.

Technical specifications

Minimum requirements for use

Hardware / software	Requirements
Processor	2.2 GHz Intel Celeron Dual Core
RAM	<ul style="list-style-type: none"> 4 GB for one instance 8 GB for 4 instances
Free hard disk space	5 GB
Operating system (64-bit version)	<ul style="list-style-type: none"> Windows 7 Home Premium SP1 Windows 7 Professional SP1 Windows 7 Enterprise SP1 Windows 7 Ultimate SP1 Windows Server 2012 R2 StdE
Screen resolution	1024 x 768

Ordering data

Article No.

SIMATIC S7-PLCSIM Advanced

Option for simulation of S7-1500 and ET200 SP

Floating license, software and documentation on DVD; license key on USB flash drive

6ES7823-1FA00-0YA5

Floating license, software, documentation and license key for download ¹⁾

6ES7823-1FE00-0YA5

Email address required for delivery

Software Update Service

For a period of 12 months and for a fixed price, the customer is automatically provided with all upgrades and service packs for each installed software package. The contract is automatically extended by a further year unless canceled at least 12 weeks prior to expiration. Requires the current software version.

6ES7823-1FA00-0YL5

Software Update Service: Upgrades and service packs are provided in the form of DVDs, USB flash drives etc.

Software Update Service (download)²⁾:

6ES7823-1FE00-0YL5

Upgrades and service packs are available for downloading.

Email address required for delivery

¹⁾ For up-to-date information and download availability, see: <http://www.siemens.com/tia-online-software-delivery>

²⁾ For more information on the Software Update Service, see page 11/2.

Overview SIMATIC Target 1500S

The SIMATIC Target 1500S is an add-on for the Simulink[®] software from The MathWorks. This makes it possible to also use model-based design with MATLAB[®] and Simulink for SIMATIC S7-1500 controllers. For this purpose, executable code for all ODK-compatible S7-1500 controllers (S7-1500 Software Controllers, ET 200SP Open Controllers and CPU 1518 ODK) is generated directly from Simulink via the target 1500S.

Technical specifications

Requirements at the MATLAB end

MATLAB 2016a (64-bit) or more recent version	<ul style="list-style-type: none"> MATLAB 9.0 MATLAB Coder 3.1 Simulink 8.7 Simulink Coder 8.10
--	---

Requirements at the SIMATIC end

SIMATIC ODK 1500S V2.0	Must be installed together with target 1500S, MATLAB and Simulink on the same PC
STEP 7 Professional from V14	For configuration of the S7-1500 CPUs, not essentially on the same PC as the target 1500S
Supported CPUs	<ul style="list-style-type: none"> CPU 1507S(F) with firmware V2.0 or higher CPU 1515SP PC (F) with firmware V2.0 or higher CPU 1518 (F) ODK

Ordering data

Article No.

SIMATIC Target 1500S for Simulink V1.0

6ES7823-1BE00-0YA5

Download incl. license key ¹⁾

Email address required for delivery

SIMATIC target + ODK 1500S bundle

6ES7823-1BE10-0YA0

Download incl. license key ¹⁾

Email address required for delivery

¹⁾ For up-to-date information and download availability, see: <http://www.siemens.com/tia-online-software-delivery>

Overview

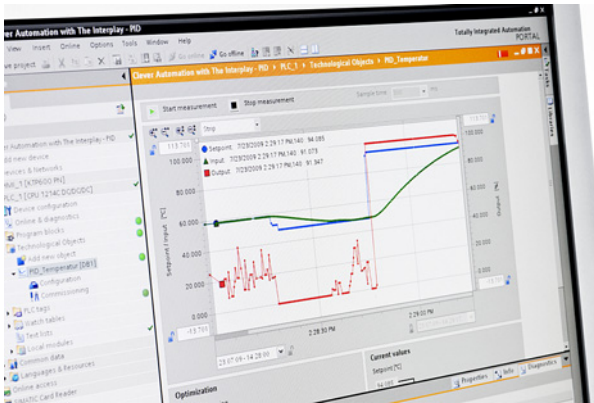

- PID Professional combines the two option packages Modular PID Control and Standard PID Control in the TIA Portal.
- Permits the simple integration of continuous PID controllers, pulse controllers and step controllers in the application program
- Can be used for simple to complex closed-loop control tasks in SIMATIC S7-300 (CPU 313 or higher), S7-400, and WinAC.
- The engineering software for PID Professional is already included in the STEP 7 package in V13 or higher.
- Tuning functionality by means of PID Self-Tuner (part of STEP 7 as of V11 SP1).
- Reduces engineering costs thanks to time-saving parameterization and optimization of the controller

Ordering data

Article No.

PID Professional for TIA Portal

Task:

Function blocks and editors for PID controllers

Requirement:

STEP 7 V13 or higher

Delivery package:

Licenses on USB flash drive/
downloadable

Floating license for the engineering
and single license for runtime

6ES7860-1XA02-0XA5

Upgrade license from Standard
PID Control or Modular PID Control
V5.1 to PID Professional for
TIA Portal

6ES7860-1XA02-0XE5

Single license (Certificate of
License) for runtime;
per CPU (all versions)

6ES7860-1XA01-0XB0

Floating license for the engineering;
Download (email address required
for delivery)¹⁾

6ES7860-1XA01-0XH5

Upgrade from Standard PID Control
or Modular PID Control V5.1 to PID
Professional for TIA Portal;
download (email address required
for delivery)¹⁾

6ES7860-1XA01-0XK5

¹⁾ For up-to-date information and download availability, see:
<http://www.siemens.com/tia-online-software-delivery>

Software for SIMATIC Controllers

TIA Portal

PLC programming

STEP 7 (TIA Portal) options > Easy Motion Control (TIA Portal)

Overview



- Low-priced package for simple, controlled positioning and simple geared synchronous motion
- For use with any standard variable-speed drive, such as frequency converter or servo drive
- For incremental and absolute encoders

Technical specifications

Supported hardware:

Easy Motion Control is runnable on the following CPUs:

- S7-300.
- S7-400.
- WinAC.
- ET 200S.
- ET 200pro.

Supported modules for the measuring of actual values:

- CPU 314C (FW version 2.0 of the CPU or higher).
- ET 200S 1 Count 5V/500 kHz.
- ET 200S 1 Count 24V/100kHz.
- ET 200S 1SSI.
- SM 338.
- FM 350-1, FM 450-1.
- SIMODRIVE sensor with PROFIBUS DP.
- IM 174.
- Other modules for measuring actual values (using free driver).

Supported modules for setpoint output:

- ET 200S 2AO U.
- SM 332.
- SM 432.
- IM 174.
- Other modules for setpoint output (using free driver).

Supported drives using PROFIBUS DP:

- Micromaster 4.
- SINAMICS G120.
- SINAMICS S120.

Storage space requirements

Required work memory in byte

Block	Required work memory per block	Additional work memory required per instance
MC_Init	1086	-
MC_MoveAbsolute	3924	112
MC_MoveRelative	2982	110
MC_MoveJog	3110	110
MC_Home	2886	104
MC_StopMotion	1114	70
MC_Control	1756	58
MC_Simulation	410	64
MC_GearIn	3476	128
Input driver	1416 ... 2654	76 ... 128
Output driver	384 ... 1242	52 ... 68
Axis data block	-	294

Ordering data

Article No.

Easy Motion Control for TIA Portal

Requirement:
STEP 7 from V12 SP1;
software included in STEP 7 V13

Floating license and single license (Runtime)

6ES7864-2XA02-0XA5

Type of delivery:
CoL for the configuration software,
USB flash drive with a license key for the configuration software,
CoL for a runtime license; without software or documentation

Floating license download by email, valid for V11 or higher (email address required for delivery¹⁾); without software or documentation

6ES7864-2XA01-0XH5

Easy Motion Control Runtime License

Type of delivery:
CoL for one runtime single license (valid for Easy Motion Control V2.x and V11 or higher), without software or documentation

6ES7864-0AF01-0YX0

¹⁾ For up-to-date information and download availability, see: <http://www.siemens.com/tia-online-software-delivery>

Overview

The vendor- and platform-independent OPC Unified Architecture (UA) is the communication standard for Industry 4.0 and is the standard mechanism for accessing S7-1500 data from non-Siemens devices.

Technical specifications**Can be used for**

SIMATIC OPC UA S7-1500

For all S7-1500 CPUs and ET200SP CPUs with FW V2.0 and higher (incl. S/F/T versions) and PLCSIM Advanced

Ordering data**Article No.****SIMATIC OPC UA S7-1500 Small**

Single runtime license

License certificate for OPC UA server (data access)

6ES7823-0BA00-1BA0Download incl. license certificate for OPC UA server (data access) ¹⁾**6ES7823-0BE00-1BA0**

Email address required for delivery

SIMATIC OPC UA S7-1500 Medium

Single runtime license

License certificate for OPC UA server (data access)

6ES7823-0BA00-1CA0Download incl. license certificate for OPC UA server (data access) ¹⁾**6ES7823-0BE00-1CA0**

Email address required for delivery

SIMATIC OPC UA S7-1500 Large

Single runtime license

License certificate for OPC UA server (data access)

6ES7823-0BA00-1DA0Download incl. license certificate for OPC UA server (data access) ¹⁾**6ES7823-0BE00-1DA0**

Email address required for delivery

¹⁾ For up-to-date information and download availability, see: <http://www.siemens.com/tia-online-software-delivery>

Software for SIMATIC Controllers

TIA Portal

TIA Portal options

TIA Portal Multiuser Engineering, TIA Portal Cloud Connector

Overview TIA Portal Multiuser Engineering

TIA Portal Multiuser Engineering allows several users to work on the same project simultaneously. This results in a significant reduction in configuration times, and projects can be commissioned faster.

The basic principle:

The project administration is handled by an autonomous server application. This can be installed independent of a TIA Portal.

Ordering data

Article No.

TIA Portal Multiuser Engineering V14

Software is component of STEP 7 / WinCC V14 and higher. Only the Certificates of License (CoL) are delivered with the license.

Data storage medium package

6ES7823-1AA04-0YA5

Download incl. license key ¹⁾

6ES7823-1AE04-0YA5

Email address required for delivery

Software Update Service ²⁾

Data storage medium package

6ES7823-1AA00-0YL5

Download ¹⁾

6ES7823-1AE00-0YL5

Email address required for delivery

¹⁾ For up-to-date information and download availability, see: <http://www.siemens.com/tia-online-software-delivery>

²⁾ For more information on the Software Update Service, see page 11/2.

Overview TIA Portal Cloud Connector

The TIA Portal Cloud Connector enables access to local PG/PC interfaces and connected SIMATIC hardware from the TIA Portal Engineering while the engineering is taking place via a remote desktop on a server of a private cloud.

Ordering data

Article No.

TIA Portal Cloud Connector

Single license; software is component of STEP 7 / WinCC V14 and higher.

Only the Certificates of License (CoL) are delivered with the license.

- Data medium package
- Download including license key ¹⁾
Email address required for the delivery

6ES7823-1CA00-0YA0

6ES7823-1CE00-0YA0

¹⁾ For up-to-date information and download availability, see: <http://www.siemens.com/tia-online-software-delivery>

Overview TIA Portal Teamcenter Gateway

The Teamcenter Gateway permits storage and management of TIA Portal projects and global libraries in Teamcenter. Program handling is integrated into the TIA Portal.

Technical specifications

Can be used with

TIA Portal Teamcenter Gateway V14

- TIA Portal V14
- Teamcenter V11

Ordering data

Article No.

TIA Portal Teamcenter Gateway

Data storage medium package

6ES7823-1EA00-0YA5

Download incl. license certificate for TIA Portal Teamcenter Gateway V14 ¹⁾

6ES7823-1EE00-0YA5

Email address required for delivery

Software Update Service²⁾

For a period of 12 months and for a fixed price, the customer is automatically provided with all upgrades and service packs for each installed software package. The contract is automatically extended by a further year unless canceled at least 12 weeks prior to expiration. Requires the current software version

Data storage medium package

6ES7823-1EA00-0YL5

Download¹⁾

6ES7823-1EE00-0YL5

Email address required for delivery

¹⁾ For up-to-date information and download availability, see: <http://www.siemens.com/tia-online-software-delivery>

²⁾ For more information on the Software Update Service, see page 11/2.

Overview SIMATIC ProDiag

The TIA Portal option ProDiag makes it possible to monitor a machine or plant and to intervene in the event of a fault. The monitoring messages which can be generated for the various faults provide specific information on the monitoring mode, location and cause of the fault. Information on troubleshooting can be provided in addition. Plant operators can then not only recognize faults, they can also identify any potential danger in advance and take appropriate countermeasures.

Technical specifications

Can be used for

SIMATIC ProDiag S7-1500

For all S7-1500 CPUs and ET200SP CPUs with FW V2.0 and higher

Ordering data

Article No.

SIMATIC ProDiag S7-1500 for 250 monitoring functions

For SIMATIC S7-1500 CPUs and ET 200SP CPUs with FW 2.0 and higher. Independent of the TIA Portal version.

Package with data storage medium

6ES7823-0AA00-1AA0

Download incl. license key ¹⁾

6ES7823-0AE00-1AA0

Email address required for delivery

SIMATIC ProDiag S7-1500 for SIMATIC Comfort Panels / Multi Panels

Package with data storage medium

6AV2107-0UP00-0BB0

Download incl. license key ¹⁾

6AV2107-0UP00-0BH0

Email address required for delivery

SIMATIC ProDiag S7-1500 for SIMATIC WinCC Runtime Advanced

Package with data storage medium

6AV2107-0UA00-0BB0

Download incl. license key ¹⁾

6AV2107-0UA00-0BH0

Email address required for delivery

SIMATIC ProDiag S7-1500 for SIMATIC WinCC Runtime

Package with data storage medium

6AV2107-0UB00-0BB0

Download incl. license key ¹⁾

6AV2107-0UB00-0BH0

Email address required for delivery

¹⁾ For up-to-date information and download availability, see: <http://www.siemens.com/tia-online-software-delivery>

Software for SIMATIC Controllers

TIA Portal

TIA Portal options

SIMATIC Visualization Architect

Overview

SIMATIC Visualization Architect

Challenge:

- To standardize the user interfaces of the visualizations throughout the plant
- To significantly reduce the engineering costs for the generation of the visualizations

Solution:

- Automatic generation and creation of the visualizations, based on the program code of the controller and corresponding visualization objects as part of the comprehensive library concepts.

Technical specifications

SIMATIC Visualization Architect

Operating system requirements	In accordance with the requirements of the TIA Portal components: <ul style="list-style-type: none"> • SIMATIC STEP 7 (TIA Portal) • SIMATIC WinCC Professional, Advanced, Comfort, Basic
Supported STEP 7 version	SIMATIC STEP 7 V14
Supported WinCC versions	SIMATIC WinCC V14 Professional, Advanced, Comfort, Basic

Ordering data

Article No.

SIMATIC Visualization Architect V14

As package

- SIMATIC Visualization Architect V14
- SIMATIC Visualization Architect V14 Rental
- SIMATIC Visualization Architect V14 Trial
Download in Customer Support Portal

Download

- SIMATIC Visualization Architect V14
- SIMATIC Visualization Architect V14 Rental
- SIMATIC Visualization Architect V14 Trial
Download in Customer Support Portal

6AV2107-0PX04-0AA5**6AV2107-0PX04-0AA6****6AV2107-0PX04-0AA7****6AV2107-0PX04-0AH5****6AV2107-0PX04-0AH6**

Download in Customer Support Portal

Overview

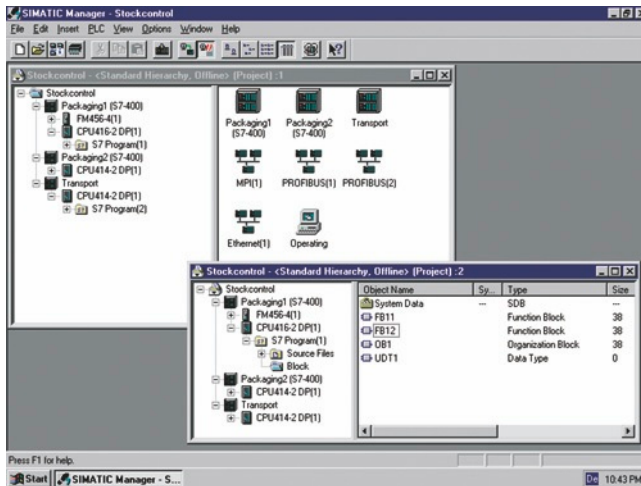

- STEP 7 basic software:
The standard tool for the SIMATIC S7, SIMATIC C7 and SIMATIC WinAC automation systems.
- Makes use of the full performance capabilities of the systems
- User-friendly functions for all phases of an automation project:
 - Configuring and parameterizing the hardware
 - Definition of communication
 - Programming
 - Testing, commissioning and service
 - Documentation, archiving
 - Operating, diagnostics functions

Technical specifications

Article number	6GK1571-0BA00-0AA0
Product type designation	PC adapter USB A2
Transmission rate	
Transfer rate	9.6 kbit/s ... 12 Mbit/s
• at the 1st interface acc. to PROFIBUS	
Interfaces	
Number of electrical connections	1
• at the 1st interface acc. to PROFIBUS	
Number of interfaces acc. to USB	1
Type of electrical connection	9-pin Sub-D socket (RS 485)
• at the 1st interface acc. to PROFIBUS	
• of the USB interface	Standard-B socket
Standard for interfaces USB 2.0	Yes
Supply voltage, current consumption, power loss	
Type of voltage of the supply voltage	DC
Type of voltage supply optional external supply	No
Supply voltage	5 V
• from USB	
• Note	Supply direct from USB
Relative symmetrical tolerance at DC	5 %
• at 5 V	
Consumed current	0.2 A
• from USB	
Power loss [W]	1 W
Permitted ambient conditions	
Ambient temperature	0 ... 60 °C
• during operation	
• during storage	-40 ... +70 °C
• during transport	-40 ... +70 °C
Relative humidity at 30 °C during operation maximum	95 %
Protection class IP	IP20
Design, dimensions and weight	
Module format	USB V2.0 adapter
Width	58 mm
Height	26 mm
Depth	105 mm
Net weight	365 g
Mounting type 35 mm DIN rail mounting	No
Number of plug-in cards of same design plug-in per PC station	1
Number of units Note	-
Performance data	
Product functions Diagnosis	
Product function	
• Port diagnostics	Yes
Standards, specifications, approvals	
Standard	
• for EMC	2004/108/EC
• for safety from CSA and UL	cULus, UL 60950-1, CSA22.2
• for emitted interference	EN 61000-6-3, EN 61000-6-4
• for interference immunity	EN 61000-6-1, EN 61000-6-2
Certificate of suitability	
• CE marking	Yes
• C-Tick	Yes

Software for SIMATIC Controllers

STEP 7 V5.x

Basic software and editors

STEP 7

Ordering data

STEP 7 Version 5.5

Target system:
SIMATIC S7-300/400, SIMATIC C7,
SIMATIC WinAC

Requirement:
Windows XP Prof.,
Windows 7 Professional / Ultimate
Type of delivery:
German, English, French, Spanish,
Italian; incl. license key on USB
flash drive, with electronic
documentation

Floating license on DVD

6ES7810-4CC10-0YA5

Floating license, license key
download without software and
documentation¹⁾; email address
required for delivery

6ES7810-4CE10-0YB5

Rental license for 50 hours

6ES7810-4CC10-0YA6

Rental license for 50 hours, license
key download without software and
documentation¹⁾; email address
required for delivery

6ES7810-4CE10-0YB6

Upgrade floating license 3.x/4.x/5.x
to V5.5; on DVD

6ES7810-4CC10-0YE5

Trial license STEP 7 V5.5;
on DVD, 14 day trial

6ES7810-4CC10-0YA7

STEP 7 Version 5.5 Japanese

Target system:
SIMATIC S7-300/400, SIMATIC C7,
SIMATIC WinAC

Requirement:
Windows XP Professional Japanese
Type of delivery:
English, Japanese; incl. license key
on USB flash drive, with electronic
documentation

Floating license Japanese on DVD

6ES7810-4CC10-0JA5

Upgrade floating license Japanese
3.x/4.x/5.x to V5.5; on DVD

6ES7810-4CC10-0JE5

STEP 7 Version 5.5, Chinese

Target system:
SIMATIC S7-300/400, SIMATIC C7,
SIMATIC WinAC

Requirement:
Windows XP Professional Chinese
Type of delivery:
English, Chinese; incl. license key
on USB flash drive, with electronic
documentation

Floating license Chinese on DVD

6ES7810-4CC10-0KA5

Upgrade floating license Chinese
3.x/4.x/5.x to V5.5; on DVD

6ES7810-4CC10-0KE5

Documentation package STEP 7 basic information

Comprising Getting Started,
hardware configuration manual,
programming manual, migration
manual

German

6ES7810-4CA10-8AW0

English

6ES7810-4CA10-8BW0

French

6ES7810-4CA10-8CW0

Spanish

6ES7810-4CA10-8DW0

Italian

6ES7810-4CA10-8EW0

Article No.

STEP 7 reference manuals

Consisting of STL, LAD and FBD
manuals as well as a reference
manual for standard and system
functions for SIMATIC S7-300/400

German

6ES7810-4CA10-8AW1

English

6ES7810-4CA10-8BW1

French

6ES7810-4CA10-8CW1

Spanish

6ES7810-4CA10-8DW1

Italian

6ES7810-4CA10-8EW1

SIMATIC Manual Collection

Electronic manuals on DVD,
multilingual: LOGO!, SIMADYN,
SIMATIC bus components, SIMATIC
C7, SIMATIC distributed I/O,
SIMATIC HMI, SIMATIC Sensors,
SIMATIC NET, SIMATIC PC Based
Automation, SIMATIC PCS 7,
SIMATIC PG/PC, SIMATIC S7,
SIMATIC Software, SIMATIC TDC

6ES7998-8XC01-8YE0

SIMATIC Manual Collection update service for 1 year

Current "Manual Collection" DVD
and the three subsequent updates

6ES7998-8XC01-8YE2

EPROM programming device, USB prommer

For programming SIMATIC Memory
Cards and EPROM modules

6ES7792-0AA00-0XA0

MPI cable

For linking SIMATIC S7 and PG
through MPI (5 m)

6ES7901-0BF00-0AA0

Components for connecting a PC to MPI and PROFIBUS

For PCs with a free PCI slot:

CP 5612

6GK1561-2AA00

For PCs without a free PCI slot:

USB A2 PC adapter

6GK1571-0BA00-0AA0

for connecting a PG/PC or Note-
book to PROFIBUS or MPI; USB
cable included in scope of delivery

Components for connecting the PC to Industrial Ethernet

For PCs with a free PCI slot:

Layer 2 Ethernet cards

For PCs with a free PCMCIA slot:

SOFTNET-IE RNA V7.1
(Win XP/Vista/Server2003)

6GK1704-1PW71-3AA0

SOFTNET-IE RNA V8.2
(Win 7/server2008)

6GK1704-1PW08-2AA0

¹⁾ For up-to-date information and download availability, see:
<http://www.siemens.com/tia-online-software-delivery>

Overview



STEP 7 Professional supports all IEC languages.

In addition to the languages familiar from STEP 7:

- LAD,
- FBD and
- STL,

these languages are also available:

- "sequential function chart"
- "structured text".

An offline simulation of user programs created with these languages is included. STEP 7 Professional thus replaces the combination of the individual packages STEP 7, S7-GRAPH, S7-SCL and S7-PLCSIM.

A POWERPACK (conversion package) is available for customers who use STEP 7 already and wish to change. A valid STEP 7 license is required for purchasing the POWERPACK. A separate update service can be purchased for STEP 7 Professional.

Technical specifications

Article number	6GK1571-0BA00-0AA0
Product type designation	PC adapter USB A2
Transmission rate	
Transfer rate	
• at the 1st interface acc. to PROFIBUS	9.6 kbit/s ... 12 Mbit/s
Interfaces	
Number of electrical connections	
• at the 1st interface acc. to PROFIBUS	1
Number of interfaces acc. to USB	1
Type of electrical connection	
• at the 1st interface acc. to PROFIBUS	9-pin Sub-D socket (RS 485)
• of the USB interface	Standard-B socket
Standard for interfaces USB 2.0	Yes

Article number	6GK1571-0BA00-0AA0
Product type designation	PC adapter USB A2
Supply voltage, current consumption, power loss	
Type of voltage of the supply voltage	DC
Type of voltage supply optional external supply	No
Supply voltage	
• from USB	5 V
• Note	Supply direct from USB
Relative symmetrical tolerance at DC	
• at 5 V	5 %
Consumed current	
• from USB	0.2 A
Power loss [W]	1 W
Permitted ambient conditions	
Ambient temperature	
• during operation	0 ... 60 °C
• during storage	-40 ... +70 °C
• during transport	-40 ... +70 °C
Relative humidity at 30 °C during operation maximum	95 %
Protection class IP	IP20
Design, dimensions and weight	
Module format	USB V2.0 adapter
Width	58 mm
Height	26 mm
Depth	105 mm
Net weight	365 g
Mounting type 35 mm DIN rail mounting	No
Number of plug-in cards of same design plug-in per PC station	1
Number of units Note	-
Performance data	
Product functions Diagnosis	
Product function	
• Port diagnostics	Yes
Standards, specifications, approvals	
Standard	
• for EMC	2004/108/EC
• for safety from CSA and UL	cULus, UL 60950-1, CSA22.2
• for emitted interference	EN 61000-6-3, EN 61000-6-4
• for interference immunity	EN 61000-6-1, EN 61000-6-2
Certificate of suitability	
• CE marking	Yes
• C-Tick	Yes

Software for SIMATIC Controllers

STEP 7 V5.x

Basic software and editors

STEP 7 Professional

Ordering data	Article No.	Article No.
STEP 7 Professional 2010/V13 Target system: SIMATIC S7-300/400, SIMATIC C7, SIMATIC WinAC Requirement: Windows XP Prof. (32-bit), Windows 7 Professional / Ultimate (32/64-bit) Type of delivery: German, English, French, Spanish, Italian; license key on USB flash drive, with electronic documentation		Software Update Service For a period of 12 months and for a fixed price, the customer is automatically provided with all upgrades and service packs for each installed software package. The contract is automatically extended by a further year unless canceled at least 12 weeks prior to expiration. Requires the current software version
Floating combo license on DVD	6ES7810-5CC11-0YA5	
Floating license, license key download²⁾ without software and documentation; email address required for delivery	6ES7810-5CE11-0YB5	
Rental license for 50 hours	6ES7810-5CC11-0YA6	
Rental license for 50 hours, license key download²⁾ without software and documentation; email address required for delivery	6ES7810-5CE11-0YB6	
Upgrade of floating license to 2010 Edition; on DVD	6ES7810-5CC11-0YE5	
Powerpack floating license for upgrading from STEP 7 to STEP 7 Professional	6ES7810-5CC11-0YC5	
Trial license STEP 7 Professional 2010; on DVD, runs for 14 days	6ES7810-5CC11-0YA7	
		Software Update Service (Standard Edition)¹⁾ The delivery is implemented according to the number of ordered SUS products (e.g. 10 upgrade packages with 10 DVDs, 10 USB flash drives, etc.) • STEP 7 Professional and STEP 7 Professional in the TIA Portal
		6ES7810-5CC04-0YE2
		Software Update Service (Compact Edition)¹⁾ The delivery items are combined. For multiple contracts, only 1 package with 1 data medium set, 1 USB flash drive with the corre- sponding number of licenses and the corresponding number of COLs will be supplied. Delivery items to be combined must be ordered as one item. • STEP 7 Professional and STEP 7 Professional in the TIA Portal
		6ES7810-5CC00-0YM2
		Software Update Service (download)¹⁾ The upgrades and service packs are available for downloading. Email address required for delivery • STEP 7 Professional and STEP 7 Professional in the TIA Portal
		6ES7810-5CC04-0YY2

¹⁾ For more information on the Software Update Service, see page 11/2.

²⁾ For up-to-date information and download availability, see:
<http://www.siemens.com/tia-online-software-delivery>

Ordering data	Article No.	Article No.
Documentation package STEP 7 basic information Comprising Getting Started, hardware configuration manual, programming manual, migration manual German English French Spanish Italian	6ES7810-4CA10-8AW0 6ES7810-4CA10-8BW0 6ES7810-4CA10-8CW0 6ES7810-4CA10-8DW0 6ES7810-4CA10-8EW0	EPROM programming device, USB prommer For programming SIMATIC Memory Cards and EPROM modules 6ES7792-0AA00-0XA0
STEP 7 reference manuals Consisting of STL, LAD and FBD manuals as well as a reference manual for standard and system functions for SIMATIC S7-300/400 German English French Spanish Italian	6ES7810-4CA10-8AW1 6ES7810-4CA10-8BW1 6ES7810-4CA10-8CW1 6ES7810-4CA10-8DW1 6ES7810-4CA10-8EW1	MPI cable For linking SIMATIC S7 and PG through MPI (5 m) 6ES7901-0BF00-0AA0
SIMATIC Manual Collection Electronic manuals on DVD, multilingual: LOGO!, SIMADYN, SIMATIC bus components, SIMATIC C7, SIMATIC distributed I/O, SIMATIC HMI, SIMATIC Sensors, SIMATIC NET, SIMATIC PC Based Automation, SIMATIC PCS 7, SIMATIC PG/PC, SIMATIC S7, SIMATIC Software, SIMATIC TDC	6ES7998-8XC01-8YE0	Components for connecting a PC to MPI and PROFIBUS <i>For PCs with a free PCI slot:</i> CP 5612 6GK1561-2AA00 <i>For PCs without a free PCI slot:</i> USB A2 PC adapter for connecting a PG/PC or Notebook to PROFIBUS or MPI; USB cable included in scope of delivery 6GK1571-0BA00-0AA0
SIMATIC Manual Collection update service for 1 year Current "Manual Collection" DVD and the three subsequent updates	6ES7998-8XC01-8YE2	Components for connecting the PC to Industrial Ethernet <i>For PCs with a free PCI slot:</i> Layer 2 Ethernet cards <i>For PCs with a free PCMCIA slot:</i> SOFTNET-IE RNA V7.1 (Win XP/Vista/Server2003) 6GK1704-1PW71-3AA0 SOFTNET-IE RNA V8.2 (Win 7/server2008) 6GK1704-1PW08-2AA0

Software for SIMATIC Controllers

STEP 7 V5.x

Basic software and editors

S7-SCL

Overview

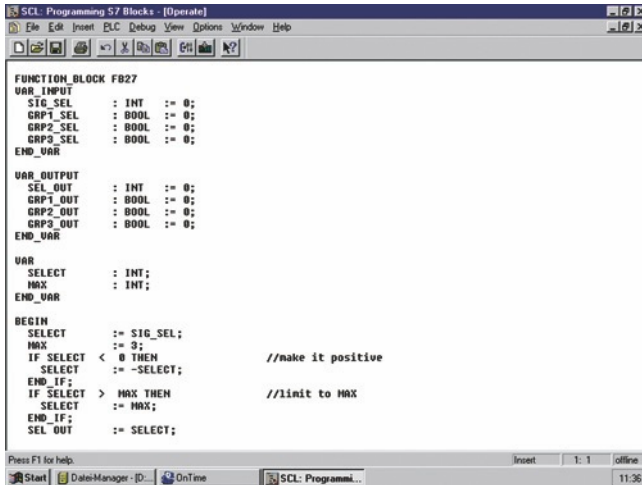

```

FUNCTION_BLOCK FB27
VAR_INPUT
  S10_SEL : INT := 0;
  GRP1_SEL : BOOL := 0;
  GRP2_SEL : BOOL := 0;
  GRP3_SEL : BOOL := 0;
END_VAR

VAR_OUTPUT
  SEL_OUT : INT := 0;
  GRP1_OUT : BOOL := 0;
  GRP2_OUT : BOOL := 0;
  GRP3_OUT : BOOL := 0;
END_VAR

VAR
  SELECT : INT;
  MAX : INT;
END_VAR

BEGIN
  SELECT := S10_SEL;
  MAX := 0;
  IF SELECT < 0 THEN
    SELECT := -SELECT; //make it positive
  END_IF;
  IF SELECT > MAX THEN
    SELECT := MAX; //limit to MAX
  END_IF;
  SEL_OUT := SELECT;

```

- PASCAL-type high-level language
- Optimized for programming programmable controllers
- With PLCopen Base Level certificate
- For use in SIMATIC S7-300 (recommended for CPU 314 and CPU 312C or higher), S7-400, C7 and WinAC



Technical specifications

Engineering Tool	S7-SCL
Current version	V5.3
Software class	A
Application areas	
Can be used for	Text-based high-level language programming of simple and complex calculations. CASE, loop, jump, and comparison functions
Marketing message	Programming of algorithms and calculations made easy!
Advantages	<ul style="list-style-type: none"> • Clear and easy-to-read programs • Functional, module-based programming • CASE instruction replaces a large number of jump and comparison functions • Easily understood by PLC programmers, as the programming philosophy of LAD/FBD/STL is retained • Easy switchover to PLC programming for PC programmers • Exchangeability (porting) of subroutines in accordance with IEC 61131-3 • Less time required for engineering compared to LAD/FBD/STL: Up to 20% for simple programs; at least 50% for demanding program structures
Sectors	<ul style="list-style-type: none"> • Labeling machines • Chemical plants (e.g. oxygen extraction, evaluation of measured values) • Rubber and plastics machines • Woodworking machines • Storage and logistics systems • Paper and printing machinery • Punching and cutting machines • Water industry • Coilers
Target systems	
Can be used in	S7-300 (CPU 313 or higher and CPU 312C or higher recommended) S7-400 C7 (C7-626 or higher recommended) WinAC
System prerequisites	
Operating system	Windows XP Professional Windows 7 Ultimate/Professional (S7-SCL V5.3 SP5 and higher)
Required hard drive memory in the PG/PC	50 MB
Required software	STEP 7 V5.4 or higher

Technical specifications (continued)		Ordering data	Article No.
Engineering Tool	S7-SCL	SIMATIC S7 SCL, Version 5.3	
Properties		Task: High-level language programming	
Monitoring tags	Yes	Target system: SIMATIC S7-300 (CPU 314 and higher), SIMATIC S7-400, SIMATIC C7, SIMATIC WinAC	
Controlling tags	Yes	Requirement: STEP 7 V5.4 SP5 and higher	
Single-step processing	Yes	Type of delivery: on CD; German, English, French, Spanish, Italian; incl. authorization diskette, with electronic documentation	
Integration in CFC	Yes	Floating license	6ES7811-1CC05-0YA5
Program runtimes		Software Update Service (requires current software version) ¹⁾	6ES7811-1CA01-0YX2
with S7-300 (typical)	Similar to LAD/FBD/STL	Upgrade floating to V5.3	6ES7811-1CC05-0YE5
with S7-400 (typical)	Similar to LAD/FBD/STL	SIMATIC Manual Collection	6ES7998-8XC01-8YE0
Diagnostics		Electronic manuals on DVD, multilingual: LOGO!, SIMADYN, SIMATIC bus components, SIMATIC C7, SIMATIC distributed I/O, SIMATIC HMI, SIMATIC Sensors, SIMATIC NET, SIMATIC PC Based Automation, SIMATIC PCS 7, SIMATIC PG/PC, SIMATIC S7, SIMATIC Software, SIMATIC TDC	
Integration of diagnostic data in ProAgent	-	SIMATIC Manual Collection update service for 1 year	6ES7998-8XC01-8YE2
Integration of diagnostic data in ProTool/Pro	-	Current "Manual Collection" DVD and the three subsequent updates	
Integration of diagnostic data in WinCC	-		
Supported standards			
IEC 61131-3	PLCopen certification • Base level ST available • Reusability Level ST available		
Available versions/licenses			
Floating license	CD-ROM with • Tool • Electronic manual • Getting Started guide • Examples License on USB stick Certificate of License Product information		
Upgrade (floating license)	CD-ROM with • Tool • Electronic manual • Getting Started guide • Examples License on USB stick Certificate of License Product information		
Software Update Service (SUS)			
Also a component part of			
STEP 7 Professional	Yes		
S7 Trainer Package	Yes		
PCS 7	Yes		
D7-SYS	-		

¹⁾ For more information on the Software Update Service, see page 11/2.

Software for SIMATIC Controllers

STEP 7 V5.x

Basic software and editors

S7-GRAPH

Overview

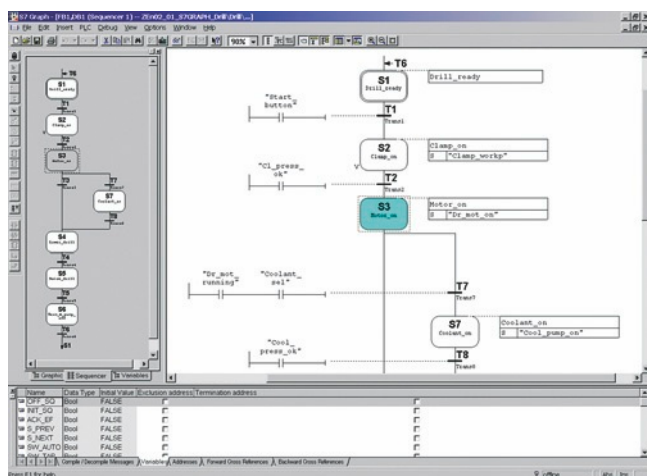

- For configuring and programming sequential processes using sequencers
- Standardized representation to EN 1131-3
- Clearly comprehensible program thanks to structuring of the process into separate steps
- With extensive diagnostics functions, integrated into the SIMATIC diagnostics concept
- With PLCopen Base Level certificate
- For use in SIMATIC S7-300 (recommended for CPU 315 and CPU 312C or higher), S7-400, C7 and WinAC



Technical specifications

Engineering Tool	S7-GRAPH
Current version	V5.3
Software class	A
Application areas	
Can be used for	Graphical programming of sequential controllers and sequencers
Marketing message	
	Fast, elegant way to program sequential processes easily and transparently!
Advantages	
	<ul style="list-style-type: none"> • Can be used to optimum effect even during the design phase • Less configuration effort thanks to graphical structuring and programming • Quick and easy familiarization • Precise fault localization thanks to integrated diagnostics in combination with ProAgent for ProTool/Pro and WinCC • Less time required for engineering compared to LAD/FBD/STL: approx. 40 to 70%
Sectors	
	<ul style="list-style-type: none"> • Automotive industry (e.g. body-in-white, final assembly) • Electrical equipment manufacture • Rubber and plastics machines • Pick-and-place machines • Woodworking machines • Metalworking machines • Paper and printing machinery • Testing machines • Rolling mills • Coilers • Leisure and entertainment facilities
Target systems	
Can be used in	S7-300 (CPU 314 or higher and CPU 312C or higher recommended) S7-400 C7 (C7-626 or higher recommended) WinAC
System prerequisites	
Operating system	Windows XP Professional Windows 7 Professional Windows 7 Ultimate
Required hard drive memory in the PG/PC	50 MB
Required software	STEP 7 V5.4 with SP4 or SP5 or STEP 7 V5.5 with or without SP1
Properties	
Monitoring tags	Yes
Controlling tags	Yes
Single-step processing	Yes
Integration in CFC	-
Program runtimes	
with S7-300 (typical)	3 ms per block + 1 ms per active step
with S7-400 (typical)	0.4 ms per block + 0.06 ms per active step
Diagnostics	
Integration of diagnostic data in ProAgent	Yes
Integration of diagnostic data in ProTool/Pro	Via ProAgent
Integration of diagnostic data in WinCC	Via ProAgent

Technical specifications (continued)

Engineering Tool	S7-GRAPH
Supported standards	
IEC 61131-3	PLCopen certification • Base Level SFC available
Status of PLCopen activities	-
Available versions/licenses	
Floating license	CD-ROM with • Tool • Electronic manual • Getting Started guide • Examples License key on USB stick Certificate of License Product information
Upgrade (floating license)	CD-ROM with • Tool • Electronic manual • Getting Started guide • Examples License key on USB stick Certificate of License Product information
Software Update Service (SUS)	
Also a component part of	
STEP 7 Professional	Yes
S7 Trainer Package	Yes
PCS 7	-
D7-SYS	-

Ordering data**Article No.****SIMATIC S7-GRAPH, Version 5.3**

Task:
Configuring and programming of sequences

Target system:
SIMATIC S7-300, SIMATIC S7-400, SIMATIC C7, SIMATIC WinAC

Requirement:
STEP 7 V5.4 or higher with SP4/SP5 or STEP 7 V5.5 with or without SP1

Type of delivery:
on CD; German, English, French, Spanish, Italian; including license key on USB flash drive, with electronic documentation

Floating license **6ES7811-0CC06-0YA5**

Software Update Service (requires current software version)¹⁾ **6ES7811-0CA01-0YX2**

Floating license upgrade to V5.3 **6ES7811-0CC06-0YE5**

SIMATIC Manual Collection **6ES7998-8XC01-8YE0**

Electronic manuals on DVD, multilingual: LOGO!, SIMADYN, SIMATIC bus components, SIMATIC C7, SIMATIC distributed I/O, SIMATIC HMI, SIMATIC Sensors, SIMATIC NET, SIMATIC PC Based Automation, SIMATIC PCS 7, SIMATIC PG/PC, SIMATIC S7, SIMATIC Software, SIMATIC TDC

SIMATIC Manual Collection update service for 1 year **6ES7998-8XC01-8YE2**

Current "Manual Collection" DVD and the three subsequent updates

¹⁾ For more information on the Software Update Service, see page 11/2.

Software for SIMATIC Controllers

STEP 7 V5.x

Basic software and editors

S7-PLCSIM

Overview

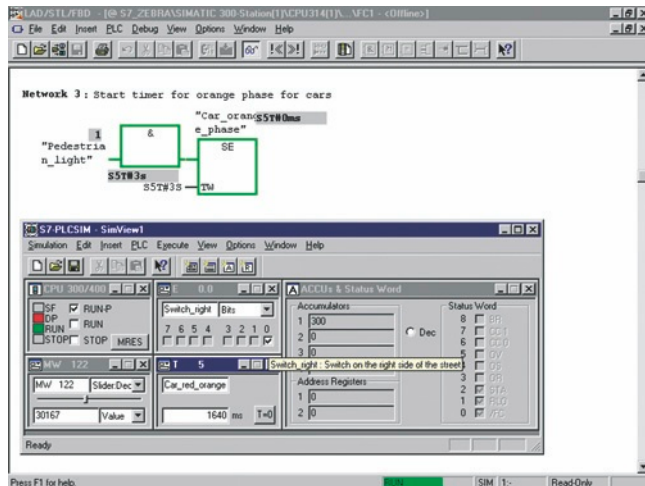

- For functional testing of the generated SIMATIC S7 user blocks on the PG/PC, independent of the availability of the target hardware
- To transfer detection and elimination of program faults to an early phase of program development
- Permits accelerated, cost-reduced initial commissioning, and an increase in program quality
- Can be used for LAD, FBD, STL, S7-GRAPH, S7-HiGraph, S7-SCL, CFC, S7-PDIAG, WinCC (local installation)

Technical specifications

Engineering Tool	S7-PLCSIM
Type of license	Floating license
Software class	A
Current version	V5.4
Target system (recommended)	SIMATIC S7-300 SIMATIC S7-400 SIMATIC C7
Operating system	Windows XP Professional Windows 7 Professional Windows 7 Ultimate
Required software packages	STEP 7 V5.4 with SP4 or SP5 or STEP 7 V5.5 with or without SP1
Disk space required in PG/PC	5 MB

Ordering data

Article No.

S7-PLCSIM, Version 5.4

Task:

Functional testing of SIMATIC S7 user blocks on PG/PC

Target system:

SIMATIC S7-300, SIMATIC S7-400, SIMATIC C7

Requirement:

STEP 7 V5.4 or higher incl. SP4/SP5 or STEP 7 V5.5 with or without SP1

Type of delivery:

on CD; English, German, French, Spanish, Italian; license key on USB flash drive, with electronic documentation

Floating license

6ES7841-0CC05-0YA5

Software Update Service (requires current software version)¹⁾

6ES7841-0CA01-0YX2

Floating license upgrade to V5.4

6ES7841-0CC05-0YE5

SIMATIC Manual Collection

6ES7998-8XC01-8YE0

Electronic manuals on DVD, multilingual: LOGO!, SIMADYN, SIMATIC bus components, SIMATIC C7, SIMATIC distributed I/O, SIMATIC HMI, SIMATIC Sensors, SIMATIC NET, SIMATIC PC Based Automation, SIMATIC PCS 7, SIMATIC PG/PC, SIMATIC S7, SIMATIC Software, SIMATIC TDC

SIMATIC Manual Collection update service for 1 year

6ES7998-8XC01-8YE2

Current "Manual Collection" DVD and the three subsequent updates

¹⁾ For more information on the Software Update Service, see page 11/2.

Overview

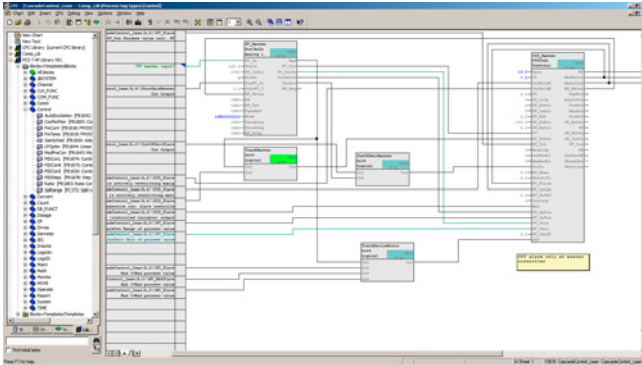

- For the generation of automation programs by drawing a technology chart
- With extensive libraries of ready-made software blocks to which user-created blocks can be added
- Minimized outlay and reduced error susceptibility due to the interconnection of ready-made blocks
- Optimized integration in the world of automation, for example, through guaranteed compatibility with all STEP 7 tools
- Can be used for SIMATIC S7-300 (recommended for CPU 316 or CPU 314C or higher), SIMATIC S7-400, SIMATIC WinAC and D7-SYS

Technical specifications

EngineeringTool	CFC
Current version	V8.2
Software class	A
Application areas	
Can be used for	Graphical creation, interconnection and parameterization of (preconfigured) blocks and functions
Marketing message	Simply interconnect and configure instead of programming!
Advantages	<ul style="list-style-type: none"> • Can be used to optimum effect even during the design phase • Reduced configuration effort thanks to graphical interconnection • High degree of reusability of diagrams that have already been created • Quick and easy familiarization • Quick and transparent interconnection of ready-made functions • Technological creation of the program as a whole • Clear representation of control loop structures • Short commissioning time • High plant availability • Less time required for engineering compared to LAD/FBD/STL: up to 50%
Sectors	<ul style="list-style-type: none"> • Automotive industry (e.g. thermostats, tire production processes) • Chemicals • Power engineering and supply • Rubber and plastics machines • Metalworking machines • Food and beverage machines • Petrochemicals • Rolling mills • Water industry • Coilers
Target systems	
Can be used in	S7-300 S7-400 F/H systems WinAC
System prerequisites	
Operating system	MS Windows XP Professional SP3 MS Windows Server 2003 SP2 Standard MS Windows Server 2003 R2 SP2 MS Windows 7 SP1 Ultimate 32-bit MS Windows 7 SP1 Ultimate 64-bit MS Windows Server 2008 SP2 32-bit MS Windows Server 2008 R2 SP1 64-bit MS Windows 7 Professional SP1 32-bit MS Windows 7 Professional SP1 64-bit MS Windows Vista 32-bit SP2 Ultimate MS Windows Vista 32-bit SP2 Business
Required hard drive memory in the PG/PC	approx. 80 MB
Required software	STEP 7 V5.4 SP5 or higher

Software for SIMATIC Controllers

STEP 7 V5.x

Options for programming and design

CFC

Technical specifications (continued)

EngineeringTool	CFC
Properties	
Monitoring tags	Yes
Controlling tags	Yes
Single-step processing	-
Integration in CFC	Yes
Program runtimes	
with S7-300 (typical)	Depending on the interconnected blocks
with S7-400 (typical)	Depending on the interconnected blocks
Diagnostics	
Integration of diagnostic data in ProAgent	-
Integration of diagnostic data in ProTool/Pro	-
Integration of diagnostic data in WinCC	-
Supported standards	
IEC 61131-3	based on the IEC standard
Status of PLCOpen activities	-
Available versions/licenses	
Floating license	<ul style="list-style-type: none"> • 1 CD • 1 license key memory stick • 1 Certificate of License
Upgrade (floating license)	<ul style="list-style-type: none"> • 1 CD • 1 license key memory stick • 1 Certificate of License
Software Update Service (SUS)	
Also a component part of	
STEP 7 Professional	-
S7 Trainer Package	-
PCS 7	Yes
D7-SYS	Yes

Ordering data

Article No.

SIMATIC CFC, Version 8.2

Task:

Graphic configuring and programming of automation applications in the form of technology-oriented diagrams

Target system:

SIMATIC S7-300/400, SIMATIC WinAC, D7-SYS

Requirements:

STEP 7 V5.4 SP5 and higher

Type of delivery:

Engineering software and electronic documentation on CD-ROM, License Key on USB flash drive, Certificate of License

Floating license

6ES7658-1EX28-0YA5

Floating license upgrade from V8.x to V8.2

6ES7658-1EX28-0YE5

Software Update Service (requires current software version)¹⁾

6ES7658-1EX00-2YL8

Software Update Service for multiple orders (requires current software version); the delivery items are combined. For multiple contracts, only 1 package (1 data medium set and the corresponding number of licenses) will be supplied. Can be ordered with 5 or more contracts¹⁾

6ES7658-1EX00-2YM8

The delivery items to be combined must be ordered as one item.

SIMATIC Manual Collection

6ES7998-8XC01-8YE0

Electronic manuals on DVD, multilingual: LOGO!, SIMADYN, SIMATIC bus components, SIMATIC C7, SIMATIC distributed I/O, SIMATIC HMI, SIMATIC Sensors, SIMATIC NET, SIMATIC PC Based Automation, SIMATIC PCS 7, SIMATIC PG/PC, SIMATIC S7, SIMATIC Software, SIMATIC TDC

SIMATIC Manual Collection update service for 1 year

6ES7998-8XC01-8YE2

Current "Manual Collection" DVD and the three subsequent updates

¹⁾ For more information on the Software Update Service, see page 11/2.

Overview

- For creating safety-oriented automation applications with SIMATIC S7 in LAD or FBD (STEP 7 required)
- Implementation of safety functions by making simple connections between function blocks
- With preconfigured function block library
- User-defined blocks can be created
- Optimum embedding in the automation world due to guaranteed integration with STEP 7 tools
- Scope of supply:
 - Distributed Safety editor
 - Code generator
 - Debugger
 - Libraries of standard blocks

Ordering data**Article No.****S7 Distributed Safety V5.4 programming tool****Task:**

Engineering tool for configuring fail-safe user programs for SIMATIC S7-300F, S7-400F, WinAC RTX F, ET 200S, ET 200M, ET 200iSP, ET 200pro, ET 200eco

Requirement:

STEP 7 V5.3 SP3 and higher

Floating license for 1 user

6ES7833-1FC02-0YA5

Floating license for 1 user, license key download without software or documentation¹⁾; email address required for delivery

6ES7833-1FC02-0YH5**S7 Distributed Safety upgrade**

From V5.x to V5.4; floating license for 1 user

6ES7833-1FC02-0YE5

¹⁾ For up-to-date information and download availability, see: <http://www.siemens.com/tia-online-software-delivery>

Software for SIMATIC Controllers

STEP 7 V5.x

Options for programming and design

S7 F/FH systems

Overview

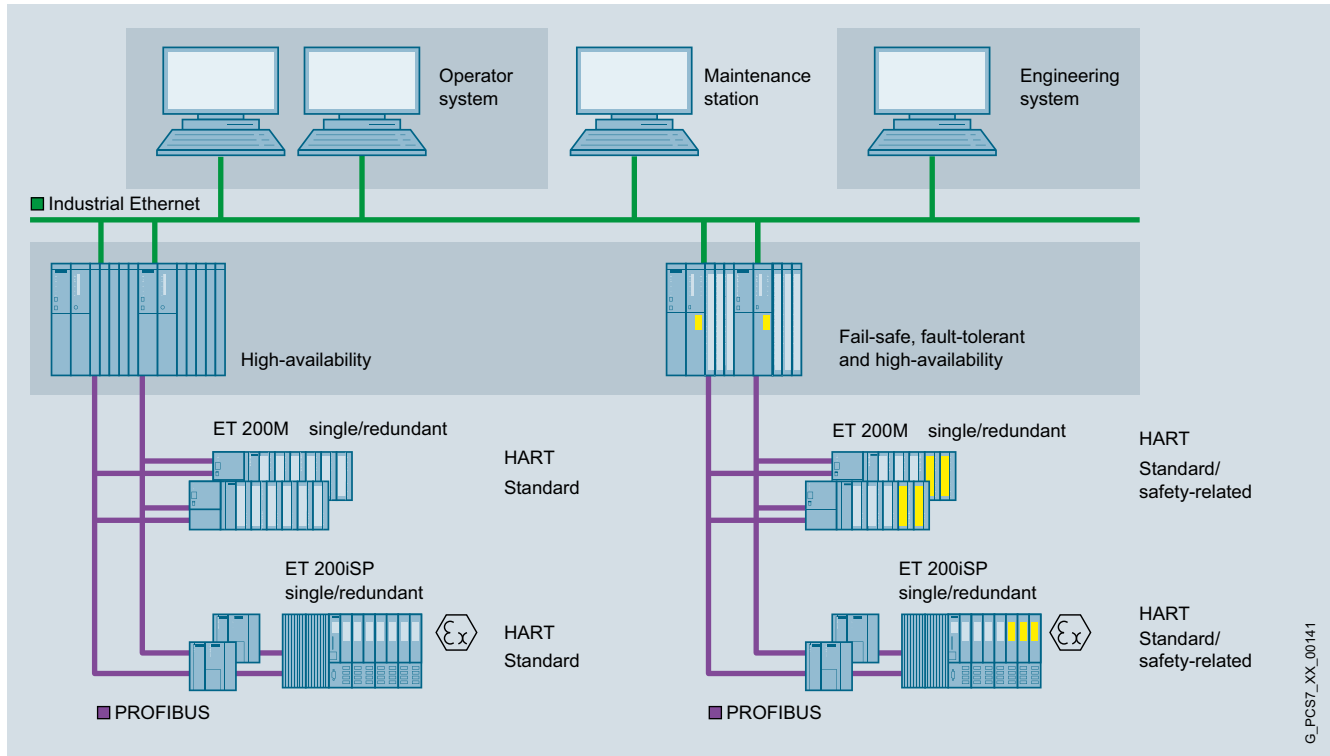

Common engineering system for basic process control system and safety instrumented system

The process industry frequently features complex technological sequences with high safety demands, and faults and failures in the process automation could have fatal consequences for personnel, machines, plants and the environment. Therefore process safety is of particular significance. The safety technology used must reliably detect errors in the process and also its own internal errors, and automatically set the plant/application to a safe state if an error is detected.

S7 F/FH Systems is the comprehensive range of products and services from Siemens for safe, fault-tolerant applications in the process industry. This is characterized by:

- Safe communication via PROFIBUS with PROFIsafe
- Safe communication also via PROFIBUS PA with PROFIsafe
- ET 200 distributed I/O systems with safety-related I/O modules
- User-friendly process visualization, including safety-relevant fault messages, via the optional operator system
- Engineering system with S7 F Systems software package and SIMATIC Safety Matrix

- AS 412F/FH, AS 414F/FH and AS 417F/FH safety-related automation systems
The safety-related automation systems of the S7 F/FH-System are based on the hardware of the CPU 412H, CPU 414H or CPU 417H automation systems that are extended with the S7 F Systems software package to include safety functions. All F/FH systems listed are TÜV-certified and comply with the safety requirements up to SIL 3 according to IEC 61508. There are two design variants:
 - Single-channel (with one CPU, safety-related)
 - High-availability (with redundant CPUs, safety-related and fault-tolerant)

G_FCS7_XX_00141

Overview

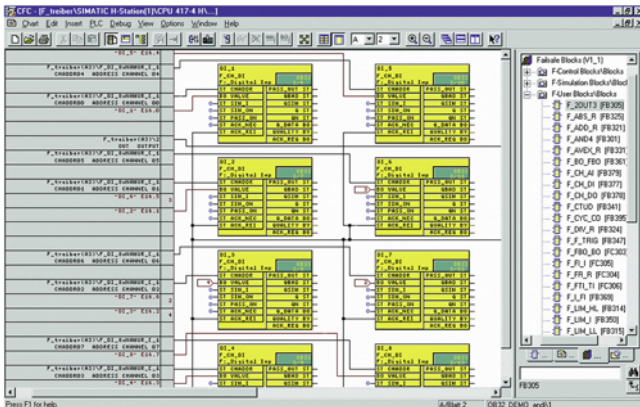

The S7 F Systems engineering tool integrated in the SIMATIC Manager can be used to configure an S7 F/H System. With this tool you can:

- Parameterize CPU and F-signal modules
- Create safety-related applications in the CFC.

Predefined, TÜV-approved blocks are available for this purpose. The safety-related blocks save the user having to perform redundant programming for detecting and reacting to errors.

Ordering data

Article No.

Article No.

S7 F Systems RT license

For processing safety-related application programs, for one AS 412F/FH, AS 414F/FH or AS 417F/FH

6ES7833-1CC00-6YX0

S7 F Systems V6.2

Programming and configuration environment for creating and using safety-related STEP 7 programs.

2 languages (English, German), software class A, runs on the engineering station under Windows 7 SP1 64-bit (Professional, Enterprise, Ultimate) or Windows Server 2008 R2 SP1 Standard 64-bit; on operator station additionally under Windows 7 SP1 32-bit (Enterprise, Ultimate), Windows 10 Enterprise 2015 LTSB 64-bit or Windows Server 2012 R2 Standard 64-bit,

Floating license for 1 user

No SIMATIC PCS 7 Software Media Package

Type of delivery:

Goods delivery
License key on USB flash drive and certificate of license, bundled with
1 x SIMATIC S7 F Systems Software Media Package per order item

Type of delivery:

Online delivery
License key download and online certificate of license, combined with SIMATIC S7 F Systems Software Media Package (software download and online certificate of license)

Note:
email address required

6ES7833-1CC02-0YA5

6ES7833-1CC26-0YA5

6ES7833-1CC26-0YH5

SIMATIC S7 F Systems V6.2 Upgrade Package

For S7 F Systems upgrade from V6.0/V6.1 to V6.2

2 languages (English, German), software class A, runs on the engineering station under Windows 7 SP1 64-bit (Professional, Enterprise, Ultimate) or Windows Server 2008 R2 SP1 Standard 64-bit; on operator station additionally under Windows 7 SP1 32-bit (Enterprise, Ultimate), Windows 10 Enterprise 2015 LTSB 64-bit or Windows Server 2012 R2 Standard 64-bit,

Floating license for 1 user

No SIMATIC PCS 7 Software Media Package

Type of delivery:

Goods delivery
License key on USB flash drive and certificate of license, bundled with
1 x SIMATIC S7 F Systems Software Media Package per order item

Type of delivery:

Online delivery
License key download and online certificate of license, combined with SIMATIC S7 F Systems Software Media Package (software download and online certificate of license)

Note:
email address required

6ES7833-1CC26-0YE5

6ES7833-1CC26-0YK5

Software for SIMATIC Controllers

STEP 7 V5.x

Options for programming and design

S7 F/FH systems > S7 F Systems

Ordering data	Article No.	Type of delivery:	Article No.
<p>SIMATIC S7 F Systems V6.1 Upgrade Package</p> <p>For S7 F Systems upgrade from V5.x/V6.0 to V6.1 (including SP)</p> <p>2 languages (English, German), software class A, runs on Windows XP Professional 32-bit, Windows Server 2003 32-bit, Windows 7 Ultimate 32/64-bit or Windows Server 2008 R2 Standard 64-bit,</p> <p>Floating license for 1 user</p> <p>No SIMATIC PCS 7 Software Media Package</p> <p>Note: In the case of an S7 F Systems upgrade from V5.x to V6.1, the type of S7 F Systems license changes from single license to floating license.</p>		<p>Goods delivery License key on USB flash drive and certificate of license, bundled with 1 × SIMATIC S7 F Systems Software Media Package per order item</p> <p>Online delivery License key download and online certificate of license combined with SIMATIC S7 F Systems Software Media Package (software download and online certificate of license) Note: email address required</p>	<p>6ES7833-1CC02-0YE5</p> <p>6ES7833-1CC02-0YK5</p>

Overview

Input Tag	Func.	Limit/Trip	EngUnit	Cause Description	Num	1	2	3	4	5	6	7	8	9	10	11	12	13	14
PS_100	FALSE			Feed Pump High Pressure Switch	1	N													
LSH_100	TRUE			Tank_100 Level switch high	2	S	S	S	R	2N									
LSL_200	TRUE			Hopper_200 Level switch Low	3	N	N	N	2S										
PSH_200	TRUE			Hopper_200 High Pressure	4	N	N	N	V										
PT_100	H 38.00	PSIG		Feed pressure	5	S	S	S	S										
LT_100	H 50.00	Feet		Tank Level	6	2S	N	N		2N									
PT_101	H 26.00			Tank Pressure	7				N										
PT_102	D 3.0		in_H2O																
PT_103																			
LT_200	H 50.00	ft		Hopper Level	8			2S											
TS_101	FALSE																		
TS_102	AND	FALSE																	
TS_103	FALSE			Tank_100 High Temperature switch	9								3S						

The SIMATIC Safety Matrix which can be used in addition to the CFC is an innovative safety lifecycle tool from Siemens that can be used not only for user-friendly configuration of safety applications, but also for their operation and service. The tool, which is based on the proven principle of a cause & effect matrix, is ideally suited to processes where defined statuses require specific safety reactions.

The SIMATIC Safety Matrix not only means that programming of the safety logic is significantly simpler and more convenient, but also much faster than in the conventional manner. During the risk analysis of a plant, the configuration engineer can assign exactly defined reactions (effects) to events (causes) which may occur during a process.

Ordering data

Article No.

SIMATIC Safety Matrix Tool V6.2

Creation, configuration, compilation, loading and online monitoring of the Safety Matrix in a SIMATIC PCS 7 environment

Including SIMATIC Safety Matrix Viewer for SIMATIC PCS 7, for operation and monitoring of the Safety Matrix in a SIMATIC PCS 7 environment with multiple operator control levels

1 language (English), executes with Windows XP Professional,

Type of supply:

Certificate of License and authorization diskette for Safety Matrix Tool and Safety Matrix Viewer; software and electronic documentation on CD

Floating license for 1 installation

6ES7833-1SM02-0YA5

Floating license upgrade from V5.x/V6.x to V6.2

6ES7833-1SM02-0YE5

SIMATIC Safety Matrix Editor V6.2

Creation and checking of the Safety Matrix logic on an external computer without a SIMATIC PCS 7 or STEP 7 environment

1 language (English), executes with Windows 2000 Professional or Windows XP Professional, single license for 1 installation

Type of supply:

Certificate of License and authorization diskette; software and electronic documentation on CD

SIMATIC Safety Matrix Viewer V6.2 for SIMATIC PCS 7

Operation and monitoring of the Safety Matrix in the SIMATIC PCS 7 environment with multiple operating levels

Bilingual (English/German), runs on Windows 2000 Professional or Windows XP Professional, Windows 2003 Server

Type of supply:

Certificate of License and authorization diskette; software and electronic documentation on CD

Floating license for 1 installation

6ES7833-1SM62-0YA5

Floating license upgrade from V6.x to V6.2

6ES7833-1SM62-0YE5

Software for SIMATIC Controllers

STEP 7 V5.x

Options for programming and design

Software redundancy

Overview

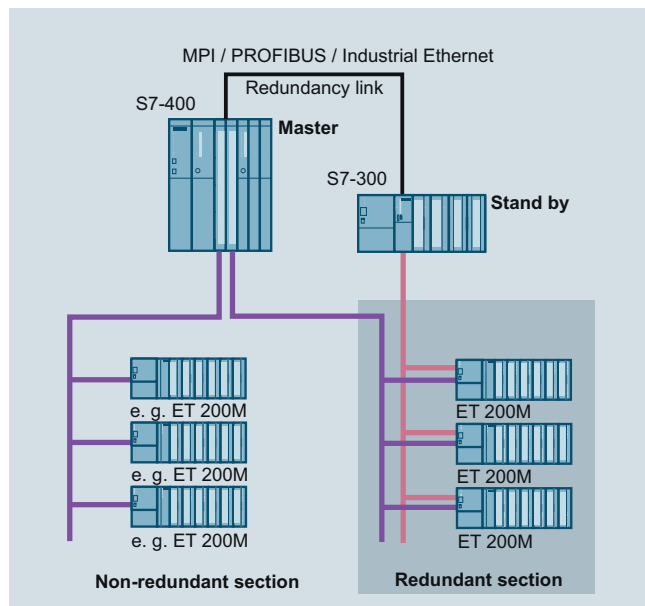

- Software package for assembling fault-tolerant control systems based on software
- Designed for control systems with single-channel distributed I/O
- For use in applications with low demands on changeover speed, such as the control of hydroelectric power plants, cooling circuits, traffic flows, level control, measured data acquisition
- Inexpensive thanks to the use of standard S7-300 and S7-400 components
- I/O linking with PROFIBUS DP in redundant configuration
- Optional control via WinCC operator station

Technical specifications

Technical specifications	
Hardware requirements	
CPU	S7-300: CPU 313C-2 DP, 314C-2 DP, 315-2 DP, 316-2 DP, 318-2 DP S7-400: all CPUs
Redundancy link of the CPUs	MPI, PROFIBUS, Industrial Ethernet; existing connections can also be used.
Suitable modules for ET 200M	IM 153-2; all DI/O, AI/O for ET 200M; FM 350-1 counter module CP 341
Software requirements	
Configuring/programming	STEP 7 V4.0
Communication configuration for redundant PROFIBUS DP	NCM S7 for PROFIBUS

Ordering data

Article No.

Program package software redundancy V1.2

Task:

Configuring a redundant control.

Target system:

SIMATIC S7-300, S7-400

Requirement:

STEP 7 V5.2,

NCM S7 for PROFIBUS

Delivery package:

incl. electronic documentation

(English, German, French, Spanish, Italian), 4 application examples and faceplate for WinCC on CD-ROM

Single license (for 2 CPUs)

6ES7862-0AC01-0YA0

Single license, without software and documentation

6ES7862-0AC01-0YA1

SIMATIC Manual Collection

6ES7998-8XC01-8YE0

Electronic manuals on DVD, multilingual: LOGO!, SIMADYN, SIMATIC bus components, SIMATIC C7, SIMATIC distributed I/O, SIMATIC HMI, SIMATIC Sensors, SIMATIC NET, SIMATIC PC Based Automation, SIMATIC PCS 7, SIMATIC PG/PC, SIMATIC S7, SIMATIC Software, SIMATIC TDC

SIMATIC Manual Collection update service for 1 year

6ES7998-8XC01-8YE2

Current "Manual Collection" DVD and the three subsequent updates

Overview

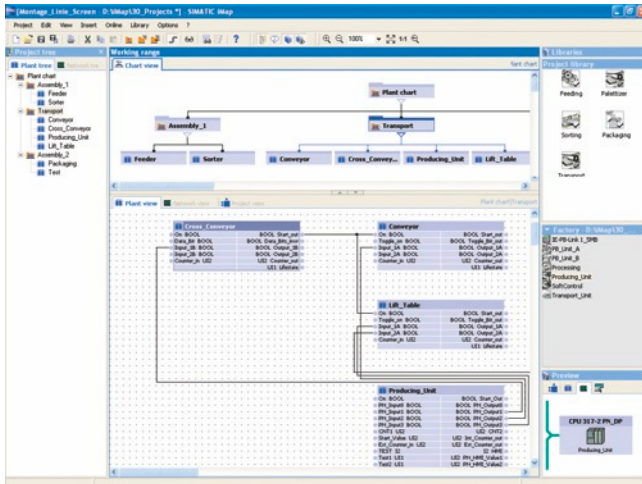

- Component-based software tool for configuring the communication in distributed automation solutions
- For easy graphical configuration of the communication between subsystems and machine-to-machine communication in the production line
- Based on the PROFINET standard
- Open for PROFINET devices from various manufacturers on Industrial Ethernet
- Runs under Windows XP Professional and Windows 7 Ultimate/Professional

Technical specifications

Engineering tool	SIMATIC iMap
Current version	V3.0
Software class	A
Application areas	
Keyword	SIMATIC iMap is an engineering tool for configuring communication between automation and field devices in distributed automation solutions.
Marketing message	"Time and cost savings in modular machine and plant construction with Component Based Automation." "Modularization and machine-to-machine communication along the production line."
Advantages	<ul style="list-style-type: none"> • Open component-based engineering tool to the PROFINET standard. • Simple communication between intelligent automation and field devices on PROFIBUS DP and on Ethernet. • Graphical configuration of communication on PROFIBUS DP and on Ethernet • Extremely high reusability of software components (technology modules) • Graphical structuring of the plant using "chart-in-chart" function • Convenient navigation through the project tree • Easy creation and structuring of technology libraries • PROFIBUS and Ethernet in the overview of the network view • Fast start-up thanks to downloading and testing directly on Ethernet (also of PROFIBUS slaves) • Online display of values of the technology modules on the interfaces and in the variable table • Diagnosis of communication in the diagnostics window
Sectors	<ul style="list-style-type: none"> • Automotive industry (especially in assembly, conveyor systems and in the paint shop) • Complex food and packaging machines • Conveyor systems based on PROFIBUS DP • Production lines with several interlinked machines

Software for SIMATIC Controllers

STEP 7 V5.x

Options for programming and design

SIMATIC iMap

Technical specifications (continued)

Engineering tool	SIMATIC iMap
Target systems	<ul style="list-style-type: none"> • SIMATIC S7 CPU 31x-2 PN/DP and SIMATIC S7 CPU 319-3 PN/DP (with integrated PROFINET interface. This can be used as a proxy function for the devices of a complete PROFIBUS segment, one line only) • SIMATIC WinAC PN (can be used as a proxy function for the devices of a complete PROFIBUS segment, one line only) • SIMATIC NET IE/PB Link (can be used as a proxy function for the devices of a complete PROFIBUS segment) • SIMATIC NET CP 343-1 and CP 343-1 Advanced (for connecting SIMATIC S7-300 to Ethernet), CP443-1 Advanced (for connecting SIMATIC S7-400 to Ethernet) • Distributed I/O stations with separate CPU (all intelligent field devices on PROFIBUS such as SIMATIC CPU 313C-2DP, CPU 314C-2DP, CPU 315-2DP, CPU 316-2DP, ET 200 IM 151 CPU, ET 200S BM 147 CPU), • PROFINET CBA OPC Server (for access from PC applications to data in PROFINET devices) • Devices on Industrial Ethernet based on the PROFINET CBA standard • SIMATIC OPs (within the components) • SIMATIC ProTool/Pro, WinCC or any other visualization system with OPC client function
System prerequisites	
Operating system	Windows XP Prof. with Service Pack 2 or Windows 7 Ultimate/Professional; PC administration rights are required for installation
PG/PC hardware	Pentium processor, 1 GHz or higher
Recommended expansion of main memory in PG/PC	RAM: 512 MB or more
Hard disk space required in PG/PC	Approx. 200 MB
Software required	<ul style="list-style-type: none"> • STEP 7 V5.3 Service Pack 3 or higher • PN OPC-Server V6.3 or higher <p>The following software must be installed before iMap (included in the iMap package):</p> <ul style="list-style-type: none"> • MS Internet Explorer V6.0 Service Pack 1 and higher • Adobe Acrobat Reader V5.0
Delivery format	
Languages	English, German, French, Italian and Spanish
Single License (SL)	Yes
Upgrade License (UL)	Yes, from V2.0 to V3.0
Paper manuals	Electronically on CD
Authorization/licenses	
Authorization	Yes
Single License (SL)	Yes
Upgrade License (UL)	Yes
Software Update Service	Yes
Unlock Copy License	No

Ordering data

Article No.

SIMATIC iMap V3.0

Target system:

CPU 31x-2 PN/DP,
CPU 319-3 PN/DP,
SIMATIC WinAC PN,
SIMATIC NET IE/PB Link,
SIMATIC NET CP 343-1,
SIMATIC NET CP 343-1 Advanced,
SIMATIC NET CP 443-1 Advanced,
distributed I/O devices with own CPU, PROFINET CBA OPC server, devices on Industrial Ethernet based on the PROFINET CBA standard, SIMATIC OPs, SIMATIC ProTool/Pro

Requirements:

Windows XP Prof. with Service Pack 2 or higher or Windows 7 Ultimate/Professional; on PG or PC with Pentium processor, min. 1 GHz; STEP 7 V5.3 Service Pack 3 or higher, PN OPC Server V6.3 or higher

Type of delivery:

German, English, with electronic documentation

Floating license

Software Update Service (requires current software version)¹⁾

Upgrade to V3.0, floating license

6ES7820-0CC04-0YA5

6ES7820-0CC01-0YX2

6ES7820-0CC04-0YE5

¹⁾ For more information on the Software Update Service, see page 11/2.

Overview

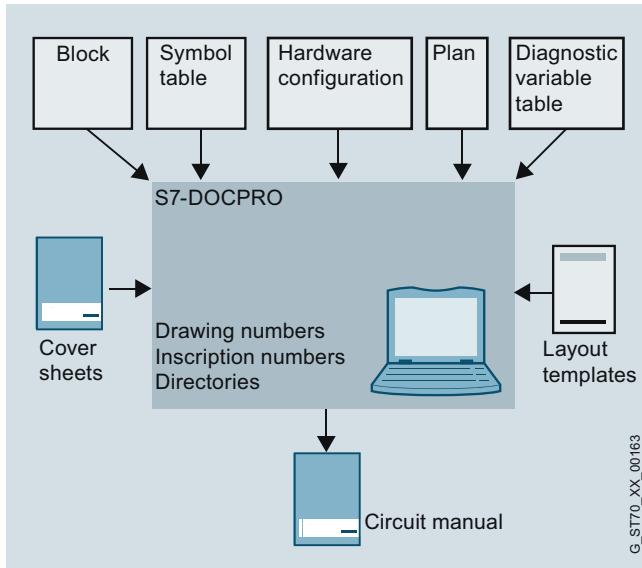

- For creating and managing plant documentation
- Permits structuring of project data, the preparation in the form of wiring manuals, and the printout in a unified print image.
- For use in SIMATIC S7-300, S7-400 and C7

Technical specifications

Engineering Tool	DOCPRO
Type of license	Floating license
Software class	A
Current version	V5.4
Target system (recommended)	SIMATIC S7-300/400 SIMATIC C7
Operating system	Windows XP Professional Windows 7 Ultimate/Professional from DOCPRO V5.4 SP1
Required software packages	STEP 7, V5.4 and higher; for operation under Windows 7 STEP 7, V5.5 and higher
Disk space required in PG/PC	5 MB

Ordering data

Article No.

DOCPRO, Version 5.4

Task:
Creation of circuit manuals for plant documentation management

Target system:
SIMATIC S7-300, SIMATIC S7-400, SIMATIC C7

Requirement:
from STEP 7 V5.4

Delivery package:
on CD; German, English, French, Spanish, Italian; incl. authorization diskette, with electronic documentation

Floating license

6ES7803-0CC03-0YA5

Software Update Service (requires current software version)¹⁾

6ES7803-0CA01-0YX2

Floating license upgrade to V5.4

6ES7803-0CC03-0YE5

SIMATIC Manual Collection

6ES7998-8XC01-8YE0

Electronic manuals on DVD, multilingual: LOGO!, SIMADYN, SIMATIC bus components, SIMATIC C7, SIMATIC distributed I/O, SIMATIC HMI, SIMATIC Sensors, SIMATIC NET, SIMATIC PC Based Automation, SIMATIC PCS 7, SIMATIC PG/PC, SIMATIC S7, SIMATIC Software, SIMATIC TDC

SIMATIC Manual Collection update service for 1 year

6ES7998-8XC01-8YE2

Current "Manual Collection" DVD and the three subsequent updates

¹⁾ For more information on the Software Update Service, see page 11/2.

Software for SIMATIC Controllers

STEP 7 V5.x

Options for diagnostics and service

S7-PDIAG

Overview

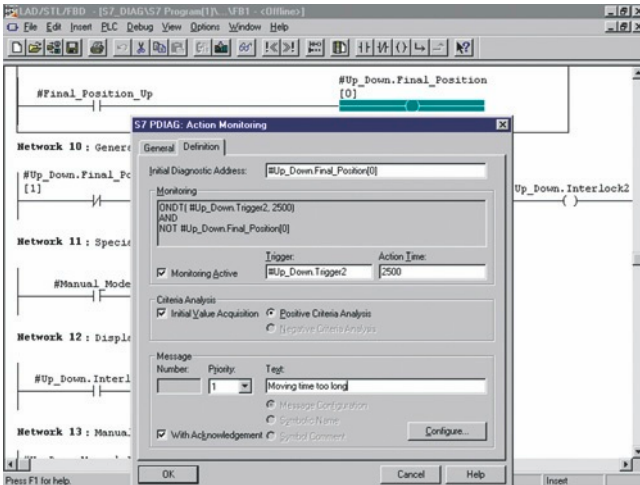

- For configuration of process diagnostics with SIMATIC S7
- Increases the availability of machines and production plants and supports with fault analysis and elimination on site
- For use on the SIMATIC S7-300, S7-400

Technical specifications

Engineering Tool	S7-PDIAG
Type of license	Floating license
Software class	A
Current version	V5.3
Target system (recommended)	SIMATIC S7-300 (CPU 314 or higher) SIMATIC S7-400
Operating system	Windows XP Professional Windows 7 Ultimate/Professional
Required software packages	STEP 7 V5.4 or higher
Disk space required in PG/PC	6 MB

Ordering data

Article No.

S7-PDIAG, Version 5.3

Task:
Configuring of process diagnostics for LAD/FBD/STL

Target system:
SIMATIC S7-300 (CPU 314 and higher); SIMATIC S7-400

Requirement:
STEP 7 V5.4 or higher

Type of delivery:
on CD; German, English, French, Spanish, Italian; incl. authorization diskette, with electronic documentation

Floating license

6ES7840-0CC04-0YA5

Software Update Service (requires current software version)¹⁾

6ES7840-0CA01-0YX2

Upgrade to V5.3

6ES7840-0CC04-0YE5

SIMATIC Manual Collection

6ES7998-8XC01-8YE0

Electronic manuals on DVD, multilingual: LOGO!, SIMADYN, SIMATIC bus components, SIMATIC C7, SIMATIC distributed I/O, SIMATIC HMI, SIMATIC Sensors, SIMATIC NET, SIMATIC PC Based Automation, SIMATIC PCS 7, SIMATIC PG/PC, SIMATIC S7, SIMATIC Software, SIMATIC TDC

SIMATIC Manual Collection update service for 1 year

6ES7998-8XC01-8YE2

Current "Manual Collection" DVD and the three subsequent updates

¹⁾ For more information on the Software Update Service, see page 11/2.

Overview

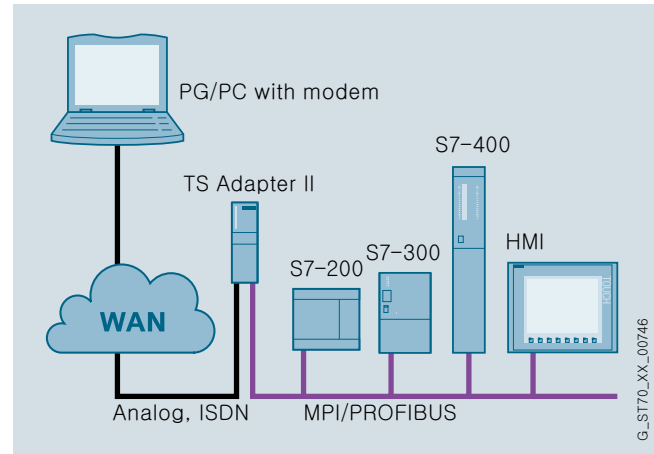
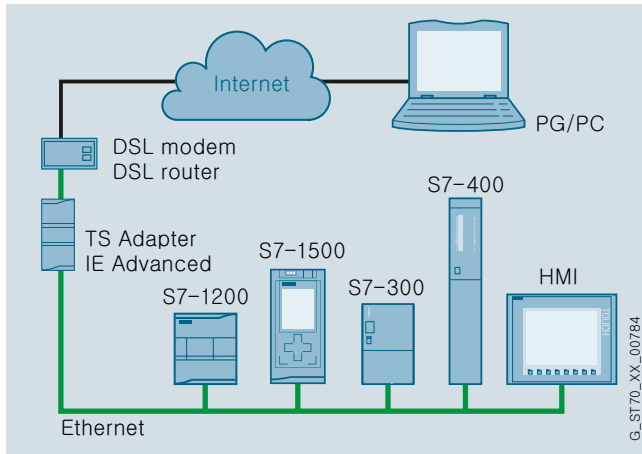

Teleservice with TS Adapter II

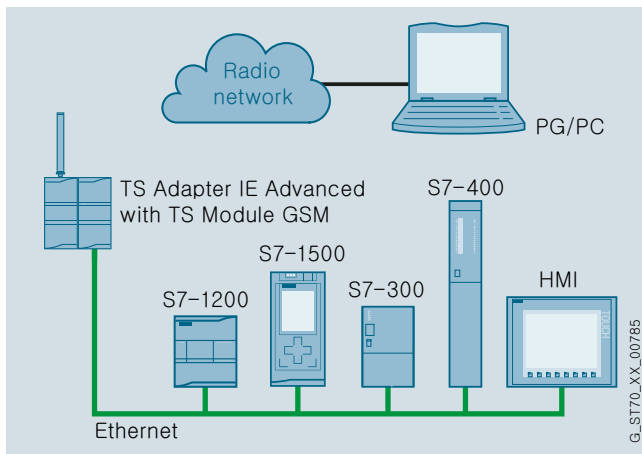

Teleservice with TS Adapter IE Advanced

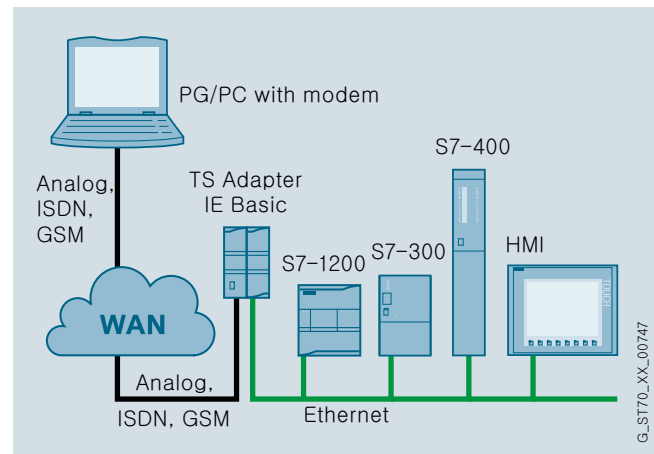

Teleservice with TS Adapter IE Basic

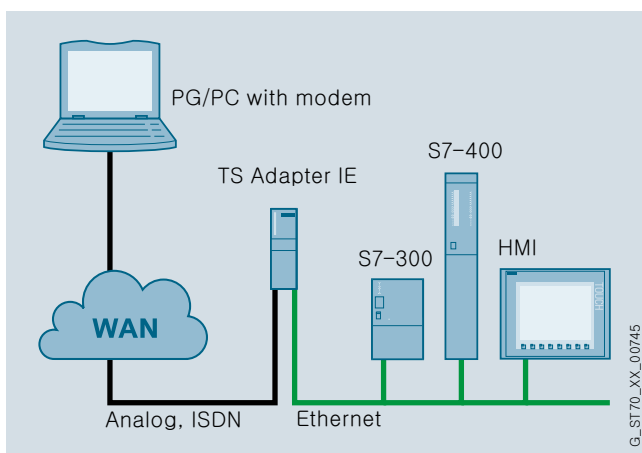

Teleservice with TS Adapter IE

- For performing remote maintenance:
A programming device/PC with an engineering tool such as STEP 7, or the TIA Portal can access automation components (e.g. S7 CPUs) which are connected to the appropriate adapters over Industrial Ethernet or PROFIBUS.
- Comprising the TeleService software and various adapters:
 - TS Adapter II for connection to PPI, MPI or PROFIBUS DP
 - TS Adapter IE, TS Adapter IE Basic or TS Adapter IE Advanced for connection to Industrial Ethernet
- Additional functions with TS Adapter II:
 - Establishing a connection from/to remote plants, e.g. for calling up process data from an automation system (PG-to-AS remote coupling).
 - Exchanging data between plants (AS-to-AS remote coupling):
Exchange of process data between two SIMATIC automation systems.
 - Sending a text message:
Sending a text message from a SIMATIC automation system via a GSM wireless modem.

Software for SIMATIC Controllers

STEP 7 V5.x

Options for diagnostics and service

TeleService

Overview (continued)

- Additional functions with TS Adapter IE:
 - Remote operation of HMI devices:
Access to the HMI device via an Internet browser installed on the adapter
 - Sending emails:
Establishing a modem link to a dial-up server (e.g. to an Internet service provider): A SIMATIC CPU can send emails over an email server that can be accessed in this manner.
 - Standard routing:
A modem link can be established to an Internet service provider for accessing data on the Internet.
- Additional functions with TS Adapter IE Advanced:
 - Remote connection via the Internet

Technical specifications

TS Adapter II

Dimensions (W x H x D) in mm	125 x 110 x 40
Weight, approx.	250 g
Interfaces	
• to S7/C7	RS 485 (up to 12 Mbit/s)
• to the PC	USB 1.1 (12 Mbit/s)
• to an external modem	RS 232 (up to 115 kbaud)
• to the analog telephone network	RJ12
• to the ISDN telephone network	RJ45
Supply voltage, external or via MPI interface	24 V DC
Current consumption	60 mA (typ.) / 120 mA (max.)
Switch-on current, max.	0.7 A; 8 μ s
Degree of protection	IP20
Temperature	
• Operation	± 0 °C to +60 °C
• Storage/transport	-40 °C to +70 °C

TS Adapter IE

Dimensions (W x H x D) in mm	125 x 110 x 40
Weight, approx.	approx. 370 g
Interfaces	
• Ethernet	RJ45 (10/100 Mbit/s)
• to an external modem	RS 232 (up to 115 kbaud)
• to the analog telephone network	RJ12
• to the ISDN telephone network	RJ45
Supply voltage, external or via MPI interface	24 V DC
Current consumption of the TSA-IE ISDN	typ. 170 mA / max. 230 mA
Current consumption of the modem TSA IE	typ. 180 mA (typ.) / max. 240 mA
Switch-on current, max.	0.7 A; 8 μ s
Degree of protection	IP20
Temperature	
• Operation	± 0 °C to +60 °C
• Storage/transport	-40 °C to +70 °C

TS Adapter IE Basic (basic unit)

Dimensions (W x H x D) in mm	30 x 100 x 75
Weight, approx.	100 g
Interfaces	
• Ethernet	RJ45 (10/100 Mbit/s)
• To the TS module	Proprietary (can only be used for TS modules)
Supply voltage, external	24 V DC
Current consumption	
• With TS module modem	typ. 50 mA, max. 80 mA
• with TS module ISDN	typ. 50 mA, max. 80 mA
• with TS module RS232	typ. 40 mA, max. 60 mA
• with TS module GSM	typ. 100 mA, max. 180 mA
Switch-on current, max.	240 mA
Degree of protection	IP20
Temperature	
• Operation	± 0 °C to +60 °C (horizontal installation) ± 0 °C to +40 °C (vertical installation)
• Storage	-40 °C to +70 °C

Technical specifications (continued)

TS module modem	
Dimensions (W x H x D) in mm, approximately	30 x 100 x 75
Weight, approx.	98 g
ITU transmission standards	<ul style="list-style-type: none"> V.21, V.22, V.22bis, V.23, V.32, V.32bis, V.34, V.34x, K56flex, V.90, V.92
Other features	<ul style="list-style-type: none"> Error correction and data compression a/b interface Hayes (AT) command set All data formats Dial procedures: dual-tone multiple-frequency (DTMF), pulse dialing

TS module ISDN	
Dimensions (W x H x D) in mm	30 x 100 x 75
Weight, approx.	92 g
Reports	<ul style="list-style-type: none"> D channel protocols B channel protocols
Other features	<ul style="list-style-type: none"> DSS1 (Euro-ISDN), 1TR6 V.110 (9600 bit/s, 19200 bit/s, 38400 bit/s) V.120 (64 Kbit/s) X.75 (64 Kbit/s) Multiple subscriber number (MSN) AT command interpreter

TS module RS232	
Dimensions (W x H x D) in mm	30 x 100 x 75
Weight, approx.	100 g
Operating mode	Full duplex, asynchronous
Signals	TXD, RXD, DSR, CTS, RTS, DTR, DCD
Data transmission rate	2 400 ... 115 200 bit/s
Message frame	8 data bits (LSB first), no parity bit, 1 stop bit
Rule	according to RS232 standard
Connector	D-sub 9-pin, male (PC COMx)

TS module GSM	
Dimensions (W x H x D) in mm	30 x 100 x 75
Weight, approx.	118 g
Transmission rate	<ul style="list-style-type: none"> GPRS Multislot Class 10 - Up to 2 uplinks - Up to 4 downlinks
Interfaces	<ul style="list-style-type: none"> SIM interface Antenna connection
Frequency ranges	Quad band: 850, 900, 1800, 1900 MHz
Transmitted output power	2 W at 850 MHz, 900 MHz 1 W at 1800 MHz, 1900 MHz

TS Adapter IE Advanced	
General information	
<u>Engineering with</u>	
STEP 7 TIA Portal can be configured/integrated as of version	V12 SP1
<u>Installation</u>	
Rail mounting possible	Yes
Wall/direct mounting possible	Yes
<u>Supply voltage</u>	
24 V DC	Yes
Permissible range	+19.2 V ... +28.8 V
<u>Input current</u>	
Current consumption, typ.	100 mA
Current consumption, max.	200 mA; incl. TS module GSM
Switch-on current, max.	4.3 A
Activation time, max.	3.1 ms
<u>Power loss</u>	
Power loss, typ.	2.4 W
Interfaces	
<u>Industrial Ethernet</u>	
Industrial Ethernet interface	3x Ethernet (RJ45), 100 Mbit
Interrupts/diagnostics/status information	
Diagnostics display LED	RUN LED, ERROR LED, MAINT LED, LINK LED, ONLINE LED, VPN LED, RX/TX LED
Insulation	
Insulation tested at	707 V DC (type test)
Dimensions	
W x H x D	55 x 117 x 75 mm
Weight	
Weight, approx.	225 g

Software for SIMATIC Controllers

STEP 7 V5.x

Options for diagnostics and service

TeleService

Ordering data	Article No.		Article No.
TeleService, Version 6.1		TS Adapter IE Basic	6ES7972-0EB00-0XA0
Task: Remote maintenance by means of wired or radio network		Basic unit	
Target system: SIMATIC S7-200, SIMATIC S7-300, SIMATIC S7-400, SIMATIC C7		TS module modem	6ES7972-0MM00-0XA0
Requirement: TS Adapter (STEP 7 not required)		TS module ISDN	6ES7972-0MD00-0XA0
Delivery package: on CD, German, English, French, Spanish, Italian; with electronic documentation		TS module RS232	6ES7972-0MS00-0XA0
Floating license	6ES7842-0CE00-0YE0	TS module GSM	6GK7972-0MG00-0XA0
Floating license Upgrade (from each previous version)	6ES7842-0CE00-0YE4	TS Adapter IE Advanced	6ES7972-0EA00-0XA0
Software Update Service (requires current software version) ¹⁾	6ES7842-0CA01-0YX2	for accessing automation components via the Internet (GSM, DLS, WAN)	
TS Adapter II modem	6ES7972-0CB35-0XA0	S7 DIN rail adapter	6ES7972-0SE00-7AA0
With MPI connection and RS 232; 9-pin, male		For mounting the TS Adapter IE Basic on S7-300 DIN rail, width 60 mm	
TS Adapter II ISDN	6ES7972-0CC35-0XA0	SIMATIC Manual Collection	6ES7998-8XC01-8YE0
With MPI connection and RS 232; 9-pin, male		Electronic manuals on DVD, multilingual: LOGO!, SIMADYN, SIMATIC bus components, SIMATIC C7, SIMATIC distributed I/O, SIMATIC HMI, SIMATIC Sensors, SIMATIC NET, SIMATIC PC Based Automation, SIMATIC PCS 7, SIMATIC PG/PC, SIMATIC S7, SIMATIC Software, SIMATIC TDC	
		SIMATIC Manual Collection update service for 1 year	6ES7998-8XC01-8YE2
		Current "Manual Collection" DVD and the three subsequent updates	

¹⁾ For more information on the Software Update Service, see page 11/2.

Overview

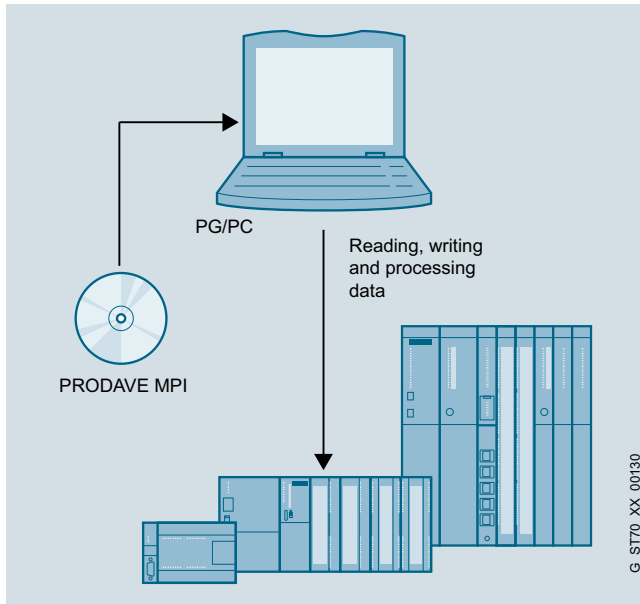

- The toolbox for exchange of process data between SIMATIC S7, SIMATIC C7 and a PG/PC
- For autonomous handling of data traffic over MPI/PPI, PROFIBUS and Industrial Ethernet

Technical specifications

Parameterization software	PRODAVE
Type of license	Simple license, copy license
Software class	A
Current version	V6.2
Target system	SIMATIC S7-200 SIMATIC S7-300 SIMATIC S7-400 SIMATIC C7
Operating system	Windows XP Professional, Windows 7 Professional and Ultimate (32 and 64-bit in each case)
Required software packages	-
Main memory configuration in target system	8 MB on PG/PC
Disk space required in PG/PC	2 MB
Standard FBs	
Required libraries	-

Ordering data

Article No.

PRODAVE MPI/IE V6.2 for Windows XP Professional, Windows 7 Professional and Ultimate (32 and 64-bit in each case)

Task:

Data link between PG/PC and SIMATIC S7/C7 via MPI (S7-200 via PPI) or Industrial Ethernet

Requirements:

Windows XP Professional, Windows 7 Professional and Ultimate (32 and 64-bit in each case); CP 5611, integrated MPI or PC adapter

Delivery package:

CD incl. electr. documentation (German, English)

Single license

6ES7807-4BA03-0YA0

Copy license, without software and documentation

6ES7807-4BA03-0YA1

PRODAVE MPI Mini V6.0 for Windows 95/98/ME/NT 4.0/ 2000 Prof./XP Prof.

Task:

Data link between PG/PC and SIMATIC S7/C7 over MPI (S7-200 over PPI); with reduced functional scope

Requirement:

Windows 95/98/ME/NT 4.0/ 2000 Prof./XP Prof.; CP 5611, integrated MPI or PC adapter

Delivery package:

CD incl. electr. documentation (German, English)

Single license

6ES7807-3BA01-0YA0

Copy license, without software and documentation

6ES7807-3BA01-0YA1

SIMATIC Manual Collection

6ES7998-8XC01-8YE0

Electronic manuals on DVD, multilingual: LOGO!, SIMADYN, SIMATIC bus components, SIMATIC C7, SIMATIC distributed I/O, SIMATIC HMI, SIMATIC Sensors, SIMATIC NET, SIMATIC PC Based Automation, SIMATIC PCS 7, SIMATIC PG/PC, SIMATIC S7, SIMATIC Software, SIMATIC TDC

SIMATIC Manual Collection update service for 1 year

6ES7998-8XC01-8YE2

Current "Manual Collection" DVD and the three subsequent updates

Software for SIMATIC Controllers

STEP 7 V5.x

Options for technology and drive systems

Loadable function blocks > Standard PID Control

Overview

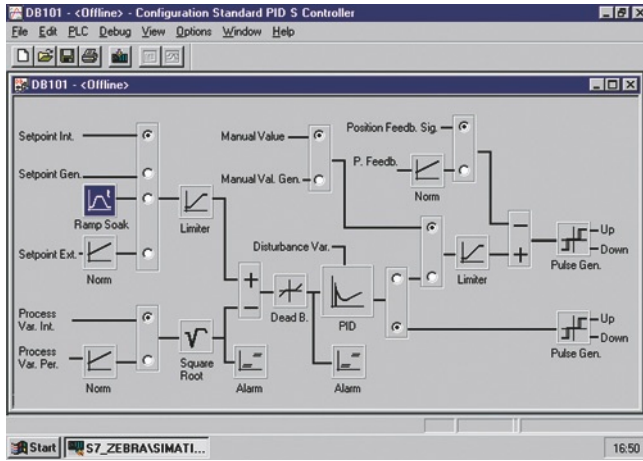

- For integrating continuous PID controllers, pulse controllers and step controllers in the application program
- Reduces engineering costs thanks to time-saving parameterization and optimization of the controller
- For use in SIMATIC S7-300 (CPU 313 or higher), S7-400 and WinAC

Technical specifications

Parameterization software	Standard PID Control					
Type of license	Single license					
Software class	A					
Current version	V 5.2					
Target system	SIMATIC S7-300 (CPU 313 or higher) SIMATIC S7-400 SIMATIC C7					
Required software packages	STEP 7 V5.3 SP2 or higher					
Main memory configuration in PG/PC	16 MB					
Disk space required in PG/PC	1.85 MB					
Standard function blocks	PID_CP (FB 1)		PID_ES (FB 2)		LP_SCHED (FC 1)	
Storage space requirements	Load memory	Work memory	Load memory	Work memory	Load memory	Work memory
• FB length in the memory	8956 bytes	7796 bytes	9104 bytes	7982 bytes	1064 bytes	976 bytes
• DB length in the memory	1168 bytes	510 bytes	1124 bytes	484 bytes	184 bytes ²⁾	100 bytes ²⁾
Runtimes						
• In S7-300 ¹⁾	0.18 - 4.4 ms		0.2 - 5.1 ms		0.03 - 0.3 ms	
• In S7-400 ¹⁾	0.13 - 0.35 ms		0.16 - 0.35 ms		0.03 - 0.08 ms	
Required libraries	Standard PID Control FBs					
Licensing forms	Simple license and 1 runtime license; 1 runtime license					
Software class	A					
Current version	V 5.2					
Target system	SIMATIC S7-300 (CPU 313 or higher) SIMATIC S7-400 SIMATIC C7					
Required software packages	STEP 7 V5.3 SP2 or higher					
Main memory configuration in PG/PC	16 MB					
Disk space required in PG/PC	1.85 MB					

¹⁾ Depending on the CPU

²⁾ With 5 control loops

Ordering data	Article No.		Article No.
<p>Standard PID Control parameterization tool, V5.2</p> <p>Task: Parameter assignment tool for standard controllers</p> <p>Requirement: STEP 7, V5.3 SP2 or higher</p> <p>Delivery package: With electronic manual/Getting Started English, German; incl. authorization diskette</p> <p>Floating license</p> <p>Upgrade license from V5.x to V5.2</p>	<p>6ES7830-2AA22-0YX0</p> <p>6ES7830-2AA22-0YX4</p>	<p>SIMATIC Manual Collection</p> <p>Electronic manuals on DVD, multilingual: LOGO!, SIMADYN, SIMATIC bus components, SIMATIC C7, SIMATIC distributed I/O, SIMATIC HMI, SIMATIC Sensors, SIMATIC NET, SIMATIC PC Based Automation, SIMATIC PCS 7, SIMATIC PG/PC, SIMATIC S7, SIMATIC Software, SIMATIC TDC</p>	<p>6ES7998-8XC01-8YE0</p>
<p>Standard function blocks for Standard PID Control, V5.2</p> <p>Task: Standard FBs for standard controllers</p> <p>Target system: SIMATIC S7-300 (CPU 313 or higher), S7-400</p> <p>Type of delivery: With electronic manual/Getting Started English, German</p> <p>Single license</p> <p>Single license without software and documentation</p>	<p>6ES7860-2AA21-0YX0</p> <p>6ES7860-2AA21-0YX1</p>	<p>SIMATIC Manual Collection update service for 1 year</p> <p>Current "Manual Collection" DVD and the three subsequent updates</p>	<p>6ES7998-8XC01-8YE2</p>

Software for SIMATIC Controllers

STEP 7 V5.x

Options for technology and drive systems

Loadable function blocks > Modular PID Control

Overview



- For creating complex closed-loop control structures
- Preferred for implementation in closed-loop control equipment in mid-range and high-end applications and in process engineering
- For use in SIMATIC S7-300 (CPU 313 or higher), S7-400 and WinAC

Technical specifications

Parameterization software	Modular PID Control
Type of license	Single license
Software class	A
Current version	V 5.1
Target system	SIMATIC S7-300 (CPU 313 or higher) SIMATIC S7-400 SIMATIC C7
Required software packages	STEP 7 V5.3 SP2 or higher

Parameterization software	Modular PID Control
Main memory configuration in PG/PC	16 MB
Disk space required in PG/PC	1.85 MB
Processor, at least	486
Windows swap area, approx.	20 MB (max. possible)

Standard function blocks	A_DEAD_B		CRP_IN		CPR_OUT	
	Load memory	Work memory	Load memory	Work memory	Load memory	Work memory
Storage space requirements						
• FB length in the memory	898 bytes	692 bytes	182 bytes	70 bytes	206 bytes	96 bytes
• DB length in the memory	186 bytes	44 bytes	122 bytes	20 bytes	114 bytes	14 bytes
Runtimes in S7-300	0.13 to 0.17 ms		0.06 ms		0.18 to 0.22 ms	
Runtimes in S7-400	0.01 to 0.03 ms		0.01 to 0.02 m		0.01 to 0.04 ms	
Target system	SIMATIC S7-300 (CPU 313 and higher), S7-400, WinAC		SIMATIC S7-300 (CPU 313 and higher), S7-400, WinAC		SIMATIC S7-300 (CPU 313 and higher), S7-400, WinAC	

Standard function blocks	DEAD_T		DEAD_BAND		DIF	
	Load memory	Work memory	Load memory	Work memory	Load memory	Work memory
Storage space requirements						
• FB length in the memory	532 bytes	394 bytes	232 bytes	120 bytes	410 bytes	268 bytes
• DB length in the memory	142 bytes	22 bytes	114 bytes	16 bytes	158 bytes	30 bytes
Runtimes in S7-300	0.26 to 0.33 ms		0.16 to 0.21 ms		0.55 to 0.71 ms	
Runtimes in S7-400	0.02 to 0.06 m		0.01 to 0.03 ms		0.03 to 0.09 ms	
Target system	SIMATIC S7-300 (CPU 313 and higher), S7-400, WinAC		SIMATIC S7-300 (CPU 313 and higher), S7-400, WinAC		SIMATIC S7-300 (CPU 313 and higher), S7-400, WinAC	

Technical specifications (continued)

Standard function blocks	ERR_MON		INTEG		LAG1ST	
Storage space requirements	Load memory	Work memory	Load memory	Work memory	Load memory	Work memory
• FB length in the memory	558 bytes	360 bytes	488 bytes	314 bytes	534 bytes	368 bytes
• DB length in the memory	206 bytes	52 bytes	168 bytes	36 bytes	156 bytes	30 bytes
Runtimes in S7-300	0.27 to 0.35 ms		0.40 to 0.51 ms		0.52 to 0.67 ms	
Runtimes in S7-400	0.01 to 0.05 ms		0.02 to 0.07 ms		0.03 to 0.09 ms	
Target system	SIMATIC S7-300 (CPU 313 and higher), S7-400, WinAC		SIMATIC S7-300 (CPU 313 and higher), S7-400, WinAC		SIMATIC S7-300 (CPU 313 and higher), S7-400, WinAC	
Standard function blocks	LAG2ND		LIMALARM		LIMITER	
Storage space requirements	Load memory	Work memory	Load memory	Work memory	Load memory	Work memory
• FB length in the memory	690 bytes	516 bytes	390 bytes	240 bytes	262 bytes	140 bytes
• DB length in the memory	190 bytes	46 bytes	152 bytes	28 bytes	124 bytes	20 bytes
Runtimes in S7-300	0.88 to 1.14 ms		0.47 to 0.61 ms		0.14 to 0.17 ms	
Runtimes in S7-400	0.04 to 0.16 ms		0.02 to 0.07 ms		0.03 to 0.01 ms	
Target system	SIMATIC S7-300 (CPU 313 and higher), S7-400, WinAC		SIMATIC S7-300 (CPU 313 and higher), S7-400, WinAC		SIMATIC S7-300 (CPU 313 and higher), S7-400, WinAC	
Standard function blocks	LMNGEN_C		LMNGEN_S		NONLIN	
Storage space requirements	Load memory	Work memory	Load memory	Work memory	Load memory	Work memory
• FB length in the memory	1576 bytes	1280 bytes	2578 bytes	2152 bytes	826 bytes	672 bytes
• DB length in the memory	276 bytes	80 bytes	360 bytes	110 bytes	138 bytes	18 bytes
Runtimes in S7-300	0.32 to 0.41 ms		1.16 to 1.47 ms		0.32 to 0.41 ms	
Runtimes in S7-400	0.02 to 0.06 ms		0.06 to 0.18 ms		0.02 to 0.07 ms	
Target system	SIMATIC S7-300 (CPU 313 and higher), S7-400, WinAC		SIMATIC S7-300 (CPU 313 and higher), S7-400, WinAC		SIMATIC S7-300 (CPU 313 and higher), S7-400, WinAC	
Standard function blocks	NORM		OVERRIDE		PARA_CTL	
Storage space requirements	Load memory	Work memory	Load memory	Work memory	Load memory	Work memory
• FB length in the memory	234 bytes	122 bytes	362 bytes	214 bytes	406 bytes	232 bytes
• DB length in the memory	130 bytes	24 bytes	146 bytes	28 bytes	234 bytes	82 bytes
Runtimes in S7-300	0.33 to 0.43 ms		0.15 to 0.18 ms		0.12 to 0.15 ms	
Runtimes in S7-400	0.02 to 0.07 ms		0.01 to 0.04 ms		0.01 to 0.03 ms	
Target system	SIMATIC S7-300 (CPU 313 and higher), S7-400, WinAC		SIMATIC S7-300 (CPU 313 and higher), S7-400, WinAC		SIMATIC S7-300 (CPU 313 and higher), S7-400, WinAC	
Standard function blocks	PID		PULSEGEN		RMP_SOAK	
Storage space requirements	Load memory	Work memory	Load memory	Work memory	Load memory	Work memory
• FB length in the memory	1560 bytes	1242 bytes	1110 bytes	872 bytes	1706 bytes	1500 bytes
• DB length in the memory	340 bytes	98 bytes	190 bytes	34 bytes	212 bytes	62 bytes
Runtimes in S7-300	1.15 to 1.46 ms		0.17 to 0.20 ms		0.16 to 0.20 ms	
Runtimes in S7-400	0.06 to 0.18 ms		0.01 to 0.05 ms		0.01 to 0.04 ms	
Target system	SIMATIC S7-300 (CPU 313 and higher), S7-400, WinAC		SIMATIC S7-300 (CPU 313 and higher), S7-400, WinAC		SIMATIC S7-300 (CPU 313 and higher), S7-400, WinAC	

Software for SIMATIC Controllers

STEP 7 V5.x

Options for technology and drive systems

Loadable function blocks > Modular PID Control

Technical specifications (continued)

Standard function blocks	ROC_LIM		SCALE		SP_GEN	
	Load memory	Work memory	Load memory	Work memory	Load memory	Work memory
Storage space requirements						
• FB length in the memory	1242 bytes	980 bytes	136 bytes	32 bytes	658 bytes	484 bytes
• DB length in the memory	222 bytes	50 bytes	114 bytes	16 bytes	164 bytes	40 bytes
Runtimes in S7-300	0.53 to 0.68 ms		0.10 to 0.13 ms		0.27 to 0.35 ms	
Runtimes in S7-400	0.02 to 0.09 ms		0.01 to 0.02 ms		0.02 to 0.06 ms	
Target system	SIMATIC S7-300 (CPU 313 and higher), S7-400, WinAC		SIMATIC S7-300 (CPU 313 and higher), S7-400, WinAC		SIMATIC S7-300 (CPU 313 and higher), S7-400, WinAC	

Standard function blocks	SPLT_RAN		SWITCH		LP_SCHED	
	Load memory	Work memory	Load memory	Work memory	Load memory	Work memory
Storage space requirements						
• FB length in the memory	304 bytes	180 bytes	238 bytes	116 bytes	1104 bytes	972 bytes ¹⁾
• DB length in the memory	138 bytes	28 bytes	118 bytes	18 bytes	234 bytes	64 bytes ¹⁾
Runtimes in S7-300	0.09 to 0.11 ms		0.07 to 0.09 ms		0.28 to 0.34 ms	
Runtimes in S7-400	0.01 to 0.02 ms		0.01 to 0.03 ms		0.03 to 0.08 ms	
Target system	SIMATIC S7-300 (CPU 313 and higher), S7-400, WinAC		SIMATIC S7-300 (CPU 313 and higher), S7-400, WinAC		SIMATIC S7-300 (CPU 313 and higher), S7-400, WinAC	

¹⁾ With 5 control loops

Standard FBs in general	
Required libraries	Modular PID Control FBs
Licensing forms	Simple license and 1 runtime license; 1 runtime license
Software class	A
Current version	V 5.1
Required software packages	STEP 7 V5.3 SP2 or higher
Main memory configuration in PG/PC	16 MB
Disk space required in PG/PC	1.85 MB

Ordering data

Article No.

Article No.

Modular PID Control commissioning tool, V5.1 for SIMATIC S7 and WinAC

Task:
Start-up tool for modular PID controllers
Requirement:
STEP 7, V5.3 SP2 or higher
Delivery package:
With electronic manual, English, German; incl. authorization diskette

Floating license

6ES7830-1AA11-0YX0

Upgrade license from V5.0 to V5.1

6ES7830-1AA11-0YX4

Standard function blocks for Modular PID Control, V5.1

Task:
Standard FBs for modular PID controllers
Target system:
SIMATIC S7-300 (CPU 313 or higher), S7-400, WinAC
Type of delivery:
English, German;
with electronic manual

Single license

6ES7860-1AA10-0YX0

Single license, without software and documentation

6ES7860-1AA10-0YX1

SIMATIC Manual Collection

Electronic manuals on DVD, multilingual: LOGO!, SIMADYN, SIMATIC bus components, SIMATIC C7, SIMATIC distributed I/O, SIMATIC HMI, SIMATIC Sensors, SIMATIC NET, SIMATIC PC Based Automation, SIMATIC PCS 7, SIMATIC PG/PC, SIMATIC S7, SIMATIC Software, SIMATIC TDC

6ES7998-8XC01-8YE0

SIMATIC Manual Collection update service for 1 year

Current "Manual Collection" DVD and the three subsequent updates

6ES7998-8XC01-8YE2

Overview

- PID Self-Tuner: For expanding existing PID controllers to create self-tuning PI or PID controllers.
- Optimization of PI or PID controllers with 3-step action (HEATING – OFF – COOLING)
- Convenient online initial setting and online adaptation during operation
- Ideally applicable to temperature controllers, but also suitable for level and flow controllers
- Can be used with SIMATIC S7-300 (CPU 313 or higher), SIMATIC S7-400 and WinAC; in combination with PID control (integrated in STEP 7), Standard PID Control, Modular PID Control, FM 355, FM 455 as well as with any PID algorithm

Technical specifications

Parameterization software	PID Self-Tuner			
Type of license	-			
Software class	-			
Current version	-			
Target system	-			
Operating system	-			
Required software packages	-			
Main memory configuration in PG/PC	-			
Disk space required in PG/PC	-			
Standard FBs	-			
PID Self-Tuner	TUN_EC		TUN_ES	
Storage space requirements	Load memory	Work memory	Load memory	Work memory
• FB length in the memory	approx. 6542 bytes	approx. 5956 bytes	6332 bytes	5714 bytes
• DB length in the memory	644 bytes	294 bytes	638 bytes	288 bytes
Runtimes				
• In S7-300	1.0 ms to 1.5 ms ¹⁾		1.0 ms to 1.5 ms ¹⁾	
• In S7-400	0.06 ms to 0.19 ms ¹⁾		0.06 ms to 0.19 ms ¹⁾	
Required libraries	PID Self-Tuner FBs V5.0			
Licensing forms	-			
Software class	A			
Current version	V5.0			
Target system	SIMATIC S7-300 (CPU 313 or higher) SIMATIC S7-400 SIMATIC C7-620			
Required software packages	STEP 7 V3.2 or higher			
Main memory configuration in PG/PC	-			
Disk space required in PG/PC	-			

¹⁾ Depending on the CPU selected

Ordering data

PID Self Tuner V5.1

Task:
Online tuning for PID controller
Target system:
SIMATIC S7-300 (CPU 313 or higher), S7-400, WinAC
Type of delivery:
Standard function blocks, electronic manual and Getting Started English/German

Single license

6ES7860-4AA01-0YX0

Single license, without software and documentation

6ES7860-4AA01-0YX1

SIMATIC Manual Collection

Electronic manuals on DVD, multilingual: LOGO!, SIMADYN, SIMATIC bus components, SIMATIC C7, SIMATIC distributed I/O, SIMATIC HMI, SIMATIC Sensors, SIMATIC NET, SIMATIC PC Based Automation, SIMATIC PCS 7, SIMATIC PG/PC, SIMATIC S7, SIMATIC Software, SIMATIC TDC

Article No.

6ES7998-8XC01-8YE0

SIMATIC Manual Collection update service for 1 year

Current "Manual Collection" DVD and the three subsequent updates

6ES7998-8XC01-8YE2

Software for SIMATIC Controllers

STEP 7 V5.x

Options for technology and drive systems

S7 Technology

Overview

- Option package for creating motion control tasks for CPU 31xT-2 DP and CPU 317TF-2 DP
- Optimal embedding in the automation world thanks to total integration in the STEP 7 tools
- Programming in the standard SIMATIC programming languages LAD, FBD and STL
- Additional Engineering Tools such as S7-SCL or S7-GRAPH can be used

Ordering data

Article No.

S7 Technology V4.2

Task:

Optional package for configuring and programming of technology tasks with SIMATIC S7 CPU 31xT-2 DP and SIMATIC S7 CPU 317TF-2 DP

Requirement:

STEP 7 V5.5 SP2 or higher

Type of delivery:

on DVD;
incl. documentation for CPU 31xT-2 DP, CPU 317TF-2 DP (included on DVD)

Floating license

6ES7864-1CC42-0YA5

Floating license for 1 user, license key download without software or documentation¹⁾;
email address required for delivery

6ES7864-1CC42-0XH5

Upgrade to V4.2

6ES7864-1CC42-0YE5

Trial license

6ES7864-1CC42-0YA7

¹⁾ For up-to-date information and download availability, see: <http://www.siemens.com/tia-online-software-delivery>

Overview



- Low-priced package for simple, controlled positioning and simple geared synchronous motion
- For use with any standard variable-speed drive, such as frequency converter or servo drive
- For incremental and absolute encoders

Technical specifications

Supported hardware:

Easy Motion Control is runnable on the following CPUs:

- S7-300.
- S7-400.
- WinAC.
- ET 200S.
- ET 200pro.

Supported modules for the measuring of actual values:

- CPU 314C (FW version 2.0 of the CPU or higher).
- ET 200S 1 Count 5V/500 kHz.
- ET 200S 1 Count 24V/100kHz.
- ET 200S 1SSI.
- SM 338.
- FM 350-1, FM 450-1.
- SIMODRIVE sensor with PROFIBUS DP.
- IM 174.
- Other modules for measuring actual values (using free driver).

Supported modules for setpoint output:

- ET 200S 2AO U.
- SM 332.
- SM 432.
- IM 174.
- Other modules for setpoint output (using free driver).

Supported drives using PROFIBUS DP:

- Micromaster 4.
- SINAMICS G120.
- SINAMICS S120.

Storage space requirements

Required work memory in byte

Block	Required work memory per block	Additional work memory required per instance
MC_Init	1086	-
MC_MoveAbsolute	3924	112
MC_MoveRelative	2982	110
MC_MoveJog	3110	110
MC_Home	2886	104
MC_StopMotion	1114	70
MC_Control	1756	58
MC_Simulation	410	64
MC_GearIn	3476	128
Input driver	1416 ... 2654	76 ... 128
Output driver	384 ... 1242	52 ... 68
Axis data block	-	294

Ordering data

Article No.

Easy Motion Control V2.1

6ES7864-0AC01-0YX0

Requirement:

STEP 7 V5.3 SP2

Type of delivery:

Software und documentation in 2 languages (English, German) on CD and CoL for one runtime single license

Easy Motion Control Runtime License

6ES7864-0AF01-0YX0

Type of delivery:

CoL for one runtime single license (valid for Easy Motion Control V2.x and V11 or higher), without software or documentation

For up-to-date information and download availability, see:

<http://www.siemens.com/tia-online-software-delivery>

Software for SIMATIC Controllers

STEP 7 V5.x

Options for technology and drive systems

D7-SYS

Overview

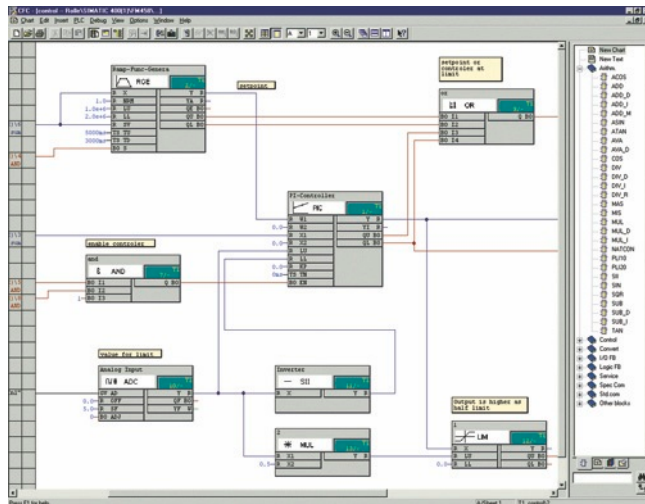

- Optional package for STEP 7 V5.5 for configuring closed-loop control and automation tasks with SIMATIC TDC, FM 458-1 DP and T400
- Extensive block library
- Generation of user libraries in ANSI C with D7-FB-GEN function block generator

Ordering data

Article No.

SIMATIC D7-SYS V8.1

Reference hardware:
SIMATIC TDC, FM 458-1 DP, T400

Requirement:

MS Windows 7 Professional/
Enterprise/Ultimate + SP1
(32/64-bit);
MS Windows XP Professional SP3
(32-bit);
MS Windows Server 2003 R2 SP2
(32-bit) / 2008 R2 SP1 (64-bit);
STEP 7 V5.5 SP4 or higher

Type of delivery:

on DVD, German, English, with
electronic documentation

Floating license

Upgrade license V7.x and higher

Software Update Service¹⁾

SIMATIC Manual Collection

Electronic manuals on DVD,
multilingual: LOGO!, SIMADYN,
SIMATIC bus components, SIMATIC
C7, SIMATIC distributed I/O,
SIMATIC HMI, SIMATIC Sensors,
SIMATIC NET, SIMATIC PC Based
Automation, SIMATIC PCS 7,
SIMATIC PG/PC, SIMATIC S7,
SIMATIC Software, SIMATIC TDC

SIMATIC Manual Collection update service for 1 year

Current "Manual Collection" DVD
and the three subsequent updates

6ES7852-0CC04-0YA5

6ES7852-0CC04-0YE5

6ES7852-0CC01-0YL5

6ES7998-8XC01-8YE0

6ES7998-8XC01-8YE2

¹⁾ For more information on the Software Update Service, see page 11/2.

Overview

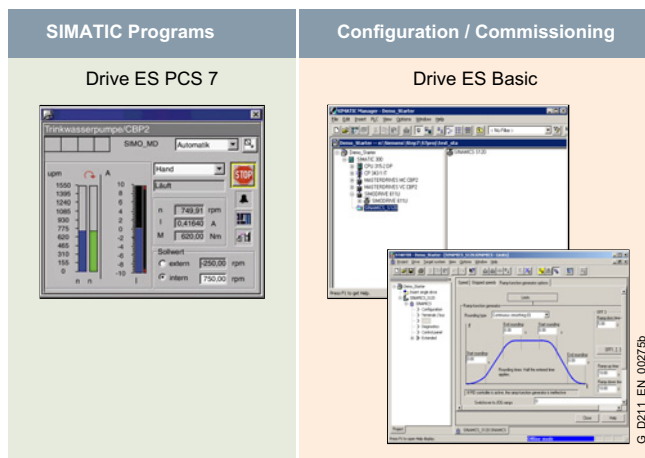

Drive ES is the engineering system used to integrate the communication, configuration and data management functions of Siemens drive technology into the SIMATIC automation world easily, efficiently and cost-effectively.

Various software packages are available for selection:

- Drive ES Basic (phase-out product)
- Drive ES Basic Maintenance (available soon)
- Drive ES PCS 7

Drive ES (**Drive Engineering Software**) fully integrates drives from Siemens into the world of Totally Integrated Automation.

Ordering data

Article No.

Article No.

Drive ES PCS 7 V8.0 SPx *)

Block library for PCS 7 for the integration of drives in Classic Style (as predecessor)

Requirement: PCS 7 V8.0 and higher

Type of delivery: CD-ROM

Languages: Ger, Eng, Fr, It, Sp with electronic documentation

- Single-user license incl. 1 runtime license
- Runtime license (without data storage medium)
- Update service for single-user license
- Upgrade from V6.x to V8.0 SPx *)

6SW1700-8JD00-0AA0

6SW1700-5JD00-1AC0

6SW1700-0JD00-0AB2

6SW1700-8JD00-0AA4

Drive ES PCS 7 APL V8.0 SPx *)

Block library for PCS 7 for the integration of drives in APL Style (Advanced Process Library)

Requirement: PCS 7 V8.0 and higher

Type of delivery: CD-ROM

Languages: Ger, Eng, Fr, It, Sp with electronic documentation

- Single-user license incl. 1 runtime license
- Runtime license (without data storage medium)
- Update service for single-user license
- Upgrade of APL V8.0 to V8.0 SP1 or Drive ES PCS7 V6.x, V7.x, V8.x classic to Drive ES PCS7 APL V8.0 SPx *)

6SW1700-8JD01-0AA0

6SW1700-5JD00-1AC0

6SW1700-0JD01-0AB2

6SW1700-8JD01-0AA4

Drive ES PCS 7 V8.1 SPx *)

Block library for PCS 7 for the integration of drives in Classic Style (as predecessor)

Requirement: PCS 7 V8.1 and higher

Type of delivery: CD-ROM

Languages: Ger, Eng, Fr, It, Sp with electronic documentation

- Single-user license incl. 1 runtime license
- Runtime license (without data storage medium)
- Update service for single-user license
- Upgrade from V6.x/V7.x/V8.x to V8.1 SPx *)

6SW1700-8JD00-1AA0

6SW1700-5JD00-1AC0

6SW1700-0JD00-0AB2

6SW1700-8JD00-1AA4

Drive ES PCS 7 APL V8.1 SPx *)

Block library for PCS 7 for the integration of drives in APL Style (Advanced Process Library)

Requirement: PCS 7 V8.1 and higher

Type of delivery: CD-ROM

Languages: Ger, Eng, Fr, It, Sp with electronic documentation

- Single-user license incl. 1 runtime license
- Runtime license (without data storage medium)
- Update service for single-user license
- Upgrade of APL V8.x to V8.1 SPx *) or Drive ES PCS 7 V6.x, V7.x, V8.x classic to Drive ES PCS 7 APL V8.1 SPx *)

6SW1700-8JD01-1AA0

6SW1700-5JD00-1AC0

6SW1700-0JD01-0AB2

6SW1700-8JD01-1AA4

Drive ES PCS 7 V8.2 SPx *)

Block library for PCS 7 for the integration of drives in Classic Style (as predecessor)

Requirement: PCS 7 from V8.2 and higher

Type of delivery: CD-ROM

Languages: Ger, Eng, Fr, It, Sp with electronic documentation

- Single-user license incl. 1 runtime license
- Runtime license (without data storage medium)
- Update service for single-user license
- Upgrade from V6.x/V7.x/V8.x to V8.2 SPx *)

6SW1700-8JD00-2AA0

6SW1700-5JD00-1AC0

6SW1700-0JD00-0AB2

6SW1700-8JD00-2AA4

Drive ES PCS 7 V8.2 SPx *)

Block library for PCS 7 for the integration of drives in APL Style (Advanced Process Library)

Requirement: PCS 7 from V8.2 and higher

Type of delivery: CD-ROM

Languages: Ger, Eng, Fr, It, Sp with electronic documentation

- Single-user license incl. 1 runtime license
- Runtime license (without data storage medium)
- Update service for single-user license
- Upgrade of APL V8.x to V8.2 SPx*) or Drive ES PCS 7 V6.x, V7.x, V8.x classic to Drive ES PCS 7 APL V8.2 SPx *)

6SW1700-8JD01-2AA0

6SW1700-5JD00-1AC0

6SW1700-0JD01-0AB2

6SW1700-8JD01-2AA4

*) Orders are automatically supplied with the latest Service Pack (SP).

Software for SIMATIC Controllers

STEP 7 V5.x

Additional software

KNX/EIB2S7

Overview



- Software for SIMATIC S7 communication with components of a building automation unit
- For use of industry automation components in building automation
- Allows the integration of actuators/sensors on a KNX/EIB bus in automation solutions with SIMATIC S7
- For the use of information from building automation for the automation of a production plant

Ordering data

Article No.

KNX/EIB2S7 program package

6AV6643-7AC10-0AA1

Task:

Software for connecting KNX/EIB building technology components to SIMATIC S7;

package includes:

Editor, function blocks for SIMATIC S7, samples, documentation on CD; license for editor on USB flash memory

Overview

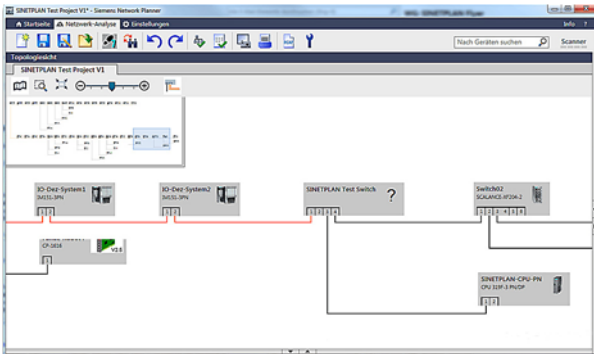

SINETPLAN topology view

The Siemens Network Planner SINEPLAN

- supports planners of automation systems based on PROFINET and
- facilitates the professional and proactive simulation of a plant / system network.

Technical specifications

SINETPLAN V1.0 can be used on the following operating systems (32-bit and 64-bit each):

- Microsoft Windows 7 Professional SP1
- Microsoft Windows 7 Enterprise SP1
- Microsoft Windows 7 Ultimate SP1

Ordering data

Article No.

Siemens Network Planner SINETPLAN V1.0

Software for the simulation of PROFINET networks;
bilingual de/en, executable under Windows 7 (32-bit / 64-bit)

- Floating license; software and documentation on DVD, license key on USB flash drive
- Floating license; software download incl. license key¹⁾
Email address required for the delivery

6ES7853-0AA00-0YA5

6ES7853-0AE00-0YA5

¹⁾ For up-to-date information and download availability, see:
<https://support.industry.siemens.com/cs/ww/en/view/109739454>

Software for SIMATIC Controllers

Software for common tasks
For maintenance

SIMATIC PDM

Overview

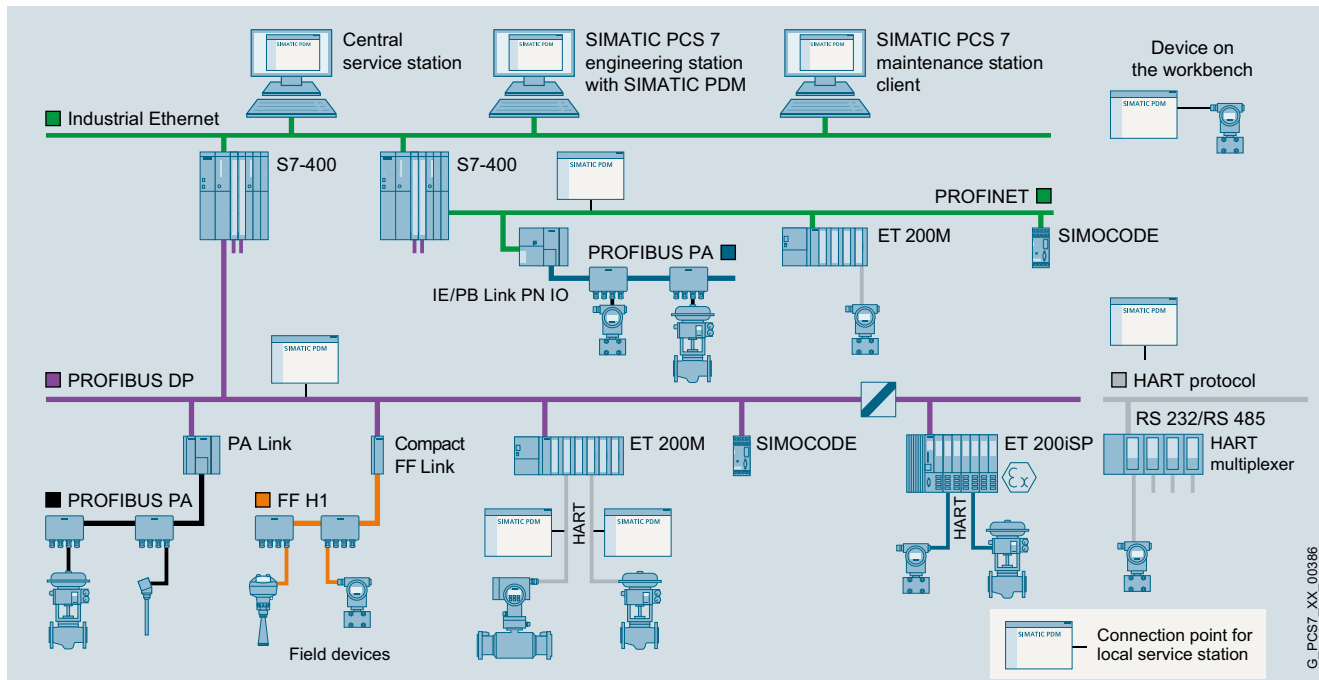

Configuration options with SIMATIC PDM

SIMATIC PDM (Process Device Manager) is a universal, vendor-independent tool for the configuration, parameter assignment, commissioning, diagnostics and servicing of intelligent field devices (sensors and actuators) and field components (remote I/Os, multiplexers, control-room devices, compact controllers), which in the following sections will be referred to simply as devices.

With *one* software product, SIMATIC PDM enables users to work with over 3 500 devices and device variants of Siemens and over 200 other manufacturers worldwide on a *single* homogeneous user interface.

The user interface satisfies the requirements of the VDI/VDE GMA 2187 and IEC 65/349/CD directives. Parameters and functions for all supported devices are displayed in a consistent and uniform fashion independent of their communications interface. Even complex devices with several hundred parameters can be represented clearly and processed quickly. Using SIMATIC PDM it is very easy to navigate in highly complex stations such as remote I/Os and even connected field devices.

From the viewpoint of device integration, SIMATIC PDM is the most powerful open process device manager on the global market. Devices which previously were not supported can be integrated in SIMATIC PDM by importing their device descriptions (EDD). This provides security for your investment and saves you investment costs, training expenses and follow-up costs.

SIMATIC PDM supports the operative system management in particular through:

- Uniform presentation and operation of devices
- Uniform representation of diagnostics information
- Indicators for preventive maintenance and servicing
- Detection of changes in the project and device
- Increasing the operational reliability
- Reducing the investment, operating and maintenance costs

Maintenance personnel can assign field device parameters using Microsoft Internet Explorer at mobile and stationary workstations with SIMATIC PDM. Practically every workstation integrated in the production plant can be used for configuration. Service personnel are thus able to work directly at the location of the field device, while data is stored centrally in the engineering station or maintenance station. This leads to a significant shortening of maintenance and travel times.

When a maintenance station is configured in the SIMATIC PCS 7 process control system, SIMATIC PDM is integrated in it and transmits parameter data and diagnostic information. You can switch directly to the SIMATIC PDM views from the diagnostics faceplates in the maintenance station.

A SIMATIC PDM user administration system based on SIMATIC Logon is used to assign various roles with defined function privileges to users. These function privileges refer to SIMATIC PDM system functions, e.g. writing to the device.

For all devices described per Electronic Device Description (EDD), SIMATIC PDM delivers a range of information for display and further processing on the maintenance station, e.g.:

- Device type information (electronic rating plate)
- Detailed diagnostics information (manufacturer information, information on error diagnostics and troubleshooting, further documentation)
- Results of internal condition monitoring functions
- Status information (e.g. local configuration changes)
- Information on changes (audit trail report)
- Parameter information

Technical specifications

SIMATIC PDM V9.0

Hardware	<ul style="list-style-type: none"> PG/PC/notebook with processor corresponding to operating system requirements
Operating system (alternatives)	<p>Can be used generally:</p> <ul style="list-style-type: none"> Windows 7 Professional/Ultimate/Enterprise SP1, 32-bit/64-bit <p>Only with integration in SIMATIC PCS 7:</p> <ul style="list-style-type: none"> Windows Server 2008 R2 SP1 Standard Edition, 64-bit Windows Server 2012 R2 SP1 Standard Edition, 64-bit

SIMATIC PDM V9.0

Integration in STEP 7/PCS 7	<ul style="list-style-type: none"> SIMATIC PCS 7 V8.0+SP2 (without Communication FOUNDATION Fieldbus) SIMATIC PCS 7 V8.1/V8.2 (with/without ServicePack) STEP 7 V5.5+SP4
SIMATIC PDM Client	<ul style="list-style-type: none"> Internet Explorer 10 or 11

Ordering data

SIMATIC PDM Stand alone product packages

Minimum configuration

SIMATIC PDM Single Point V9.0 including 1 TAG; product package for operation and configuration of one field device; communication via PROFIBUS DP/PA, HART (modem, RS 232, PROFIBUS/PROFINET), Modbus, Ethernet or PROFINET

Additional functions or SIMATIC PDM TAGs are not possible

6 languages (English, German, French, Italian, Spanish, Chinese), software class A, runs on Windows 7 Ultimate 32/64-bit, Windows Server 2008 R2 Standard 64-bit, or Windows Server 2012 R2 Standard 64-bit, floating license for 1 user

- Goods delivery (without SIMATIC PCS 7 Software Media Package)
License key on USB flash drive and certificate of license, bundled with 1 x SIMATIC PDM Software Media Package per ordering position
- Online delivery (without SIMATIC PCS 7 Software Media Package)
License Key download and online certificate of license combined with SIMATIC PDM Software Media Package (SIMATIC PDM and device library software download)
Note: Email address required!

Article No.

6ES7658-3HA58-0YA5

6ES7658-3HA58-0YH5

Article No.

Basic configuration for individual product package as well as local service and parameter assignment stations

SIMATIC PDM Basic V9.0

including 4 TAGs; product package for operation and configuration of field devices and components; communication via PROFIBUS DP/PA, HART (modem, RS 232, PROFIBUS/PROFINET), Modbus, Ethernet or PROFINET

6 languages (English, German, French, Italian, Spanish, Chinese), software class A, runs on Windows 7 Ultimate 32/64-bit, Windows Server 2008 R2 Standard 64-bit, or Windows Server 2012 R2 Standard 64-bit, floating license for 1 user

- Goods delivery (without SIMATIC PCS 7 Software Media Package)
License key on USB flash drive and certificate of license, bundled with 1 x SIMATIC PDM Software Media Package per ordering position
- Online delivery (without SIMATIC PCS 7 Software Media Package)
License key download and online certificate of license combined with SIMATIC PDM Software Media Package (SIMATIC PDM and device library software download)
Note: Email address required!

6ES7658-3AB58-0YA5

6ES7658-3AB58-0YH5

Software for SIMATIC Controllers

Software for common tasks

For maintenance

SIMATIC PDM

Ordering data

Configuration for local service and parameter assignment station

SIMATIC PDM Service V9.0

Product package for service and measuring circuit tests on a local service station, with

- SIMATIC PDM Basic incl. 4 TAGs
- 50 TAGs

6 languages (English, German, French, Italian, Spanish, Chinese), software class A, runs on Windows 7 Ultimate 32/64-bit, Windows Server 2008 R2 Standard 64-bit, or Windows Server 2012 R2 Standard 64-bit, floating license for 1 user

- Goods delivery (without SIMATIC PCS 7 Software Media Package)
License key on USB flash drive and certificate of license, bundled with 1 x SIMATIC PDM Software Media Package per ordering position
- Online delivery (without SIMATIC PCS 7 Software Media Package)
License key download and online certificate of license combined with SIMATIC PDM Software Media Package (SIMATIC PDM and device library software download)
Note: Email address required!

6ES7658-3JD58-0YA5

6ES7658-3JD58-0YH5

Configuration for central service and parameter assignment station

SIMATIC PDM Stand alone Server V9.0

Product package for service and device management in plant units, with

- SIMATIC PDM Basic incl. 4 TAGs
- SIMATIC PDM Extended
- SIMATIC PDM Server
- 2 x SIMATIC PDM 1 Client
- 100 TAGs

6 languages (German, English, French, Italian, Spanish, Chinese), software class A, runs with Windows 7 Ultimate 32/64-bit, Windows Server 2008 R2 Standard 64-bit, or Windows Server 2012 R2 Standard 64-bit, single license for 1 installation

- Goods delivery (without SIMATIC PCS 7 Software Media Package)
License key on USB flash drive and certificate of license, bundled with 1 x SIMATIC PDM Software Media Package per ordering position
- Online delivery (without SIMATIC PCS 7 Software Media Package)
License key download and online certificate of license combined with SIMATIC PDM Software Media Package (SIMATIC PDM and device library software download)
Note: Email address required!

6ES7658-3TX58-0YA5

6ES7658-3TX58-0YH5

Article No.

SIMATIC PDM system-integrated product packages

Configuration for local SIMATIC S7 engineering and service station

SIMATIC PDM S7 V9.0

Product package for use in a SIMATIC S7 configuration environment, with

- SIMATIC PDM Basic incl. 4 TAGs
- SIMATIC PDM Extended
- SIMATIC PDM integration in STEP 7/PCS 7
- 100 TAGs

6 languages (English, German, French, Italian, Spanish, Chinese), software class A, runs on Windows 7 Ultimate 32/64-bit, Windows Server 2008 R2 Standard 64-bit, or Windows Server 2012 R2 Standard 64-bit, floating license for 1 user

- Goods delivery (without SIMATIC PCS 7 Software Media Package)
License key on USB flash drive and certificate of license, bundled with 1 x SIMATIC PDM Software Media Package per ordering position
- Online delivery (without SIMATIC PCS 7 Software Media Package)
License key download and online certificate of license combined with SIMATIC PDM Software Media Package (SIMATIC PDM and device library software download)
Note: Email address required!

6ES7658-3KD58-0YA5

6ES7658-3KD58-0YH5

Configuration for central SIMATIC PCS 7 engineering and service stations

SIMATIC PDM PCS 7 V9.0

Product package for use in a SIMATIC PCS 7 configuration environment

6 languages (German, English, French, Italian, Spanish, Chinese), software class A, runs with Windows 7 Ultimate 32/64-bit, Windows Server 2008 R2 Standard 64-bit, or Windows Server 2012 R2 Standard 64-bit

Floating license for 1 user, with

- SIMATIC PDM Basic incl. 4 TAGs
- SIMATIC PDM Extended
- SIMATIC PDM integration in STEP 7/PCS 7
- SIMATIC PDM Routing
- 100 TAGs

- Goods delivery (without SIMATIC PCS 7 Software Media Package)
License key on USB flash drive and certificate of license, bundled with 1 x SIMATIC PDM Software Media Package per ordering position
- Online delivery (without SIMATIC PCS 7 Software Media Package)
License Key download and online certificate of license combined with SIMATIC PDM Software Media Package (SIMATIC PDM and device library software download)
Note: Email address required!

6ES7658-3LD58-0YA5

6ES7658-3LD58-0YH5

Ordering data	Article No.	Article No.	Article No.
<p>SIMATIC PDM PCS 7-FF V9.0 Product package for use in a SIMATIC PCS 7 configuration environment, including FOUNDATION Fieldbus H1 communication</p> <p>6 languages (German, English, French, Italian, Spanish, Chinese), software class A, runs with Windows 7 Ultimate 32/64-bit, Windows Server 2008 R2 Standard 64-bit, or Windows Server 2012 R2 Standard 64-bit</p> <p>Floating license for 1 user, with</p> <ul style="list-style-type: none"> - SIMATIC PDM Basic incl. 4 TAGs - SIMATIC PDM Extended - SIMATIC PDM integration in STEP 7/PCS 7 - SIMATIC PDM Routing - SIMATIC PDM Communication FOUNDATION Fieldbus - 100 TAGs <ul style="list-style-type: none"> • Goods delivery (without SIMATIC PCS 7 Software Media Package) License key on USB flash drive and certificate of license, bundled with 1 × SIMATIC PDM Software Media Package per ordering position • Online delivery (without SIMATIC PCS 7 Software Media Package) License key download and online certificate of license combined with SIMATIC PDM Software Media Package (SIMATIC PDM and device library software download) <u>Note:</u> Email address required! 	<p>6ES7658-3MD58-0YA5</p> <p>6ES7658-3MD58-0YH5</p>	<p>Optional product components for SIMATIC PDM</p> <p>SIMATIC PDM Extended V9.0 For enabling additional system functions</p> <p>6 languages (English, German, French, Italian, Spanish, Chinese), software class A, runs on Windows 7 Ultimate 32/64-bit, Windows Server 2008 R2 Standard 64-bit, or Windows Server 2012 R2 Standard 64-bit, floating license for 1 user</p> <ul style="list-style-type: none"> • Goods delivery (without SIMATIC PCS 7/SIMATIC PDM Software Media Package) License key on USB flash drive and certificate of license • Online delivery (without SIMATIC PCS 7/SIMATIC PDM Software Media Package) License key download and online certificate of license <u>Note:</u> Email address required! 	<p>6ES7658-3NX58-2YB5</p> <p>6ES7658-3NX58-2YH5</p>
<p>SIMATIC PDM PCS 7 Server V9.0 Product package for use in a SIMATIC PCS 7 configuration environment, including server functionality</p> <p>6 languages (German, English, French, Italian, Spanish, Chinese), software class A, runs with Windows 7 Ultimate 32/64-bit, Windows Server 2008 R2 Standard 64-bit, or Windows Server 2012 R2 Standard 64-bit</p> <p>Single license for 1 installation, with</p> <ul style="list-style-type: none"> - SIMATIC PDM Basic incl. 4 TAGs - SIMATIC PDM Extended - SIMATIC PDM integration in STEP 7/PCS 7 - SIMATIC PDM Routing - SIMATIC PDM Server - 100 TAGs <ul style="list-style-type: none"> • Goods delivery (without SIMATIC PCS 7 Software Media Package) License key on USB flash drive and certificate of license, bundled with 1 × SIMATIC PDM Software Media Package per ordering position • Online delivery (without SIMATIC PCS 7/SIMATIC PDM Software Media Package) License key download and online certificate of license combined with SIMATIC PDM Software Media Package (SIMATIC PDM and device library software download) <u>Note:</u> Email address required! 	<p>6ES7658-3TD58-0YA5</p> <p>6ES7658-3TD58-0YH5</p>	<p>SIMATIC PDM Integration in STEP 7/SIMATIC PCS 7 V9.0 For integration in a SIMATIC S7/SIMATIC PCS 7 configuration environment</p> <p>6 languages (English, German, French, Italian, Spanish, Chinese), software class A, runs on Windows 7 Ultimate 32/64-bit, Windows Server 2008 R2 Standard 64-bit, or Windows Server 2012 R2 Standard 64-bit, floating license for 1 user</p> <ul style="list-style-type: none"> • Goods delivery (without SIMATIC PCS 7/SIMATIC PDM Software Media Package) License key on USB flash drive and certificate of license • Online delivery (without SIMATIC PCS 7/SIMATIC PDM Software Media Package) License key download and online certificate of license <u>Note:</u> Email address required! 	<p>6ES7658-3BX58-2YB5</p> <p>6ES7658-3BX58-2YH5</p>
<p>SIMATIC PDM PCS 7 Server V9.0 Product package for use in a SIMATIC PCS 7 configuration environment, including server functionality</p> <p>6 languages (German, English, French, Italian, Spanish, Chinese), software class A, runs with Windows 7 Ultimate 32/64-bit, Windows Server 2008 R2 Standard 64-bit, or Windows Server 2012 R2 Standard 64-bit</p> <p>Single license for 1 installation, with</p> <ul style="list-style-type: none"> - SIMATIC PDM Basic incl. 4 TAGs - SIMATIC PDM Extended - SIMATIC PDM integration in STEP 7/PCS 7 - SIMATIC PDM Routing - SIMATIC PDM Server - 100 TAGs <ul style="list-style-type: none"> • Goods delivery (without SIMATIC PCS 7 Software Media Package) License key on USB flash drive and certificate of license, bundled with 1 × SIMATIC PDM Software Media Package per ordering position • Online delivery (without SIMATIC PCS 7/SIMATIC PDM Software Media Package) License key download and online certificate of license combined with SIMATIC PDM Software Media Package (SIMATIC PDM and device library software download) <u>Note:</u> Email address required! 	<p>6ES7658-3TD58-0YA5</p> <p>6ES7658-3TD58-0YH5</p>	<p>SIMATIC PDM Routing V9.0 For plant-wide navigation to field devices</p> <p>6 languages (English, German, French, Italian, Spanish, Chinese), software class A, runs on Windows 7 Ultimate 32/64-bit, Windows Server 2008 R2 Standard 64-bit, or Windows Server 2012 R2 Standard 64-bit, floating license for 1 user</p> <ul style="list-style-type: none"> • Goods delivery (without SIMATIC PCS 7/SIMATIC PDM Software Media Package) License key on USB flash drive and certificate of license • Online delivery (without SIMATIC PCS 7/SIMATIC PDM Software Media Package) License key download, online certificate of license <u>Note:</u> Email address required! 	<p>6ES7658-3CX58-2YB5</p> <p>6ES7658-3CX58-2YH5</p>

Software for SIMATIC Controllers

Software for common tasks

For maintenance

SIMATIC PDM

Ordering data

SIMATIC PDM Server V9.0

For activating the server functionality

6 languages (German, English, French, Italian, Spanish, Chinese), software class A, runs with Windows 7 Ultimate 32/64-bit, Windows Server 2008 R2 Standard 64-bit, or Windows Server 2012 R2 Standard 64-bit, single license for 1 installation

- Goods delivery (without SIMATIC PCS 7/SIMATIC PDM Software Media Package) License key on USB flash drive, certificate of license
- Online delivery (without SIMATIC PCS 7/SIMATIC PDM Software Media Package) License key download and online certificate of license
Note: Email address required!

6ES7658-3TX58-2YB5

6ES7658-3TX58-2YH5

SIMATIC PDM Communication FOUNDATION Fieldbus V9.0

For communication with field devices on FOUNDATION Fieldbus H1

6 languages (English, German, French, Italian, Spanish, Chinese), software class A, runs on Windows 7 Ultimate 32/64-bit, Windows Server 2008 R2 Standard 64-bit, or Windows Server 2012 R2 Standard 64-bit, floating license for 1 user

- Goods delivery (without SIMATIC PCS 7/SIMATIC PDM Software Media Package) License key on USB flash drive and certificate of license
- Online delivery (without SIMATIC PCS 7/SIMATIC PDM Software Media Package) License key download and online certificate of license
Note: Email address required!

6ES7658-3QX58-2YB5

6ES7658-3QX58-2YH5

SIMATIC PDM HART Server V9.0

For using HART multiplexers as well as for configuration of wireless HART field devices

6 languages (English, German, French, Italian, Spanish, Chinese), software class A, runs on Windows 7 Ultimate 32/64-bit, Windows Server 2008 R2 Standard 64-bit, or Windows Server 2012 R2 Standard 64-bit, floating license for 1 user

- Goods delivery (without SIMATIC PCS 7/SIMATIC PDM Software Media Package) License key on USB flash drive and certificate of license
- Online delivery (without SIMATIC PCS 7/SIMATIC PDM Software Media Package) License key download and online certificate of license
Note: Email address required!

6ES7658-3EX58-2YB5

6ES7658-3EX58-2YH5

Article No.

SIMATIC PDM 1 Client

Cumulative client license for SIMATIC PDM configurations with SIMATIC PDM Server, software class A, single license for 1 installation

- Goods delivery License key on USB flash drive and certificate of license
- Online delivery License key download and online certificate of license
Note: Email address required!

6ES7658-3UA00-2YB5

6ES7658-3UA00-2YH5

SIMATIC PDM TAGs

TAG licenses for expanding the available TAG volume, cumulative, software class A, floating license for 1 user

- Goods delivery License key on USB flash drive and certificate of license
 - 10 TAGs
 - 100 TAGs
 - 1 000 TAGs
- Online delivery License key download and online certificate of license
Note: Email address required!
 - 10 TAGs
 - 100 TAGs
 - 1 000 TAGs

6ES7658-3XC00-2YB5

6ES7658-3XD00-2YB5

6ES7658-3XE00-2YB5

6ES7658-3XC00-2YH5

6ES7658-3XD00-2YH5

6ES7658-3XE00-2YH5

SIMATIC PDM Software Media Package

SIMATIC PDM Software Media Package V9.0

Installation software without license, 6 languages (German, English, French, Italian, Spanish, Chinese), software class A, runs with Windows 7 Ultimate 32/64-bit, Windows Server 2008 R2 Standard 64-bit, or Windows Server 2012 R2 Standard 64-bit

Note:
Can only be used in conjunction with a valid license or in demo mode!

- Goods delivery (without SIMATIC PCS 7 Software Media Package) SIMATIC PDM and device library software on DVD
- Online delivery (without SIMATIC PCS 7 Software Media Package) SIMATIC PDM and device library software download
Note: Email address required!

6ES7658-3GX58-0YT8

6ES7658-3GX58-0YG8

Software for SIMATIC Controllers

Software for common tasks
For administration

Version Trail

Overview

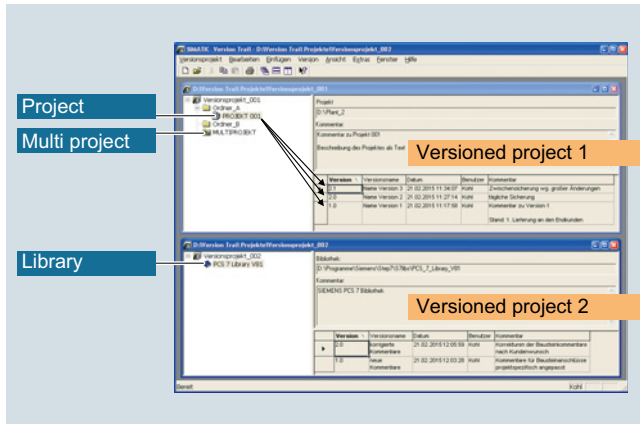

SIMATIC Version Trail is a software option for engineering which, together with the SIMATIC Logon central user administration, can assign a version history to libraries, projects and multi-projects.

Ordering data

Article No.

SIMATIC Version Trail V8.2

6 languages (English, German, French, Italian, Spanish, Chinese), software class A, runs with Windows 7 Professional/Ultimate 32/64-bit or Windows Server 2008 R2 Standard 64-bit, floating license for 1 user

No SIMATIC PCS 7 Software Media Package

- Physical delivery
License key on USB flash drive, certificate of license and TIA Engineering Toolset CD
- Online delivery
License key download, online certificate of license
Note: Email address required!

6ES7658-1FX28-2YA5

6ES7658-1FX28-2YH5

Upgrade package (only for TIA applications)

SIMATIC Version Trail Upgrade from V8.0/8.1 to V8.2

6 languages (English, German, French, Italian, Spanish, Chinese), software class A, runs with Windows 7 Professional/Ultimate 32/64-bit or Windows Server 2008 R2 Standard 64-bit, floating license for 1 user

No SIMATIC PCS 7 Software Media Package

- Physical delivery
License key on USB flash drive, certificate of license
- Online delivery
License key download and online certificate of license
Note: Email address required!

6ES7658-1FX28-2YE5

6ES7658-1FX28-2YK5

SIMATIC programming devices



12/2

12/2

12/6

12/6

12/7

12/7

12/9

Programming devices

Field PG M5

Accessories

External prommer

Communications software

SOFTNET for PROFIBUS

SOFTNET for Industrial Ethernet

Brochures

For brochures serving as selection guides for SIMATIC products, refer to:

www.siemens.com/simatic/printmaterial

SIMATIC programming devices

Programming devices

Field PG M5

Overview



- The mobile, industry-standard programming device for automation engineers with a powerful, sixth-generation Intel® Core™ i processor (Skylake) and high-speed RAM (DDR4 RAM)
- Elegant, robust enclosure made of light-weight stable injection-molded magnesium with rubber-protected corners and retractable carry-handle
- Can optimally be used both for engineering in the office and for the commissioning, service or maintenance of automation systems
- Industrial notebook with all commonly used interfaces for industrial applications
- Can be used immediately thanks to pre-installed SIMATIC engineering software

Technical specifications

Article number	6ES7717-.....-0... SIMATIC FIELD PG M5
General information	
Design of the programming device	Notebook
Display	
Design of display	15.6" full HD display in 16:9 format
Resolution (pixels)	
• Horizontal image resolution	1 920 Pixel
• Vertical image resolution	1 080 Pixel
General features	
• Non-reflecting	Yes
• Luminance	300 cd/m ²
Backlighting	
• Type of backlighting	LED
Control elements	
Keyboard fonts	
• Design	QWERTZ/QWERTY or AZERTY (French); 87 keys
Touch operation	
• Integrated touch pad	Yes; Clickpad
Supply voltage	
Design of the power supply	External wide-range power supply; 3-pole
permissible range, lower limit (AC)	100 V; +/- 10%, sinusoidal
permissible range, upper limit (AC)	240 V; +/- 10%, sinusoidal
Line frequency	
• permissible range, lower limit	47 Hz
• permissible range, upper limit	63 Hz
Processor	
Processor type	Intel Core i5-6440EQ (2.7 GHz to 3.4 GHz, 4 cores, 6 MB Smart Cache) or i7-6820EQ (2.8 GHz to 3.5 GHz, 4 cores, 8 MB Smart Cache)
Chipset	Mobile Intel QM170
Hyper-threading	Yes; for Intel Core i7 processor
Turbo Boost Technology 2.0	Yes

Article number	6ES7717-.....-0... SIMATIC FIELD PG M5
Graphic	
Graphics controller	Intel® HD graphics 530
Drives	
DVD-RW	Yes
Hard disk	Yes; Easy to replace
• Memory capacity	1 Tbyte; HDD
SSD	Yes; Easy to replace
• Memory capacity	512 Gbyte; up to 1 TB SSD
TPM Security Chip	Yes; 2.0 (version for China without TPM)
Memory	
Type of memory	DDR4-SDRAM SO-DIMM
Work memory	
• Number of slots	2; Can be equipped with 1x 8 GB, 1x 16 GB or 2x 16 GB
Accumulator	
Replaceable	Yes; Lithium-ion battery
Capacity	8.8 A·h
Hardware configuration	
Slots	
• Number of ExpressCard slots	1; Type 34
Interfaces	
PROFIBUS/MPI	1x PROFIBUS DP / MPI; 9-pin Sub-D socket; 9.6 kBaud to 12 MBaud
Number of USB interfaces	4; USB 3.0
• Type A	3; 1x USB port incl. integrated charging function for USB devices (e.g. smartphone) – also with device switched off
• Type C	1
Number of RS 232 interfaces	1; 25-pin socket
Number of chip-card readers	1; Smart Card Reader (ISO/IEC 7816)
Bluetooth radio standard	Yes; V4.0
Multimedia card/SD card slot	2 in 1 (SDHC UHS-II, MMC)
Card reader for SIMATIC memory cards	SIMATIC memory cards (for S7-300/400), SMC (for S7-1x00), SIMATIC micro memory card (for S7-300/C7/ET 200) - including programming interfaces
Universal Audio Jack	Yes; Audio socket for 3.5 mm jack

Technical specifications (continued)

Article number	6ES7717-.....-0... SIMATIC FIELD PG M5
Video interfaces	
• analog video signal (VGA)	Yes; via adapter from DVI to VGA
• DVI-I	Yes; 1x
• DisplayPort	Yes; 1x
Industrial Ethernet	
• Industrial Ethernet interface	2 x Ethernet (RJ45)
- 100 Mbps	Yes
- 1000 Mbps	Yes; Gigabit Ethernet; 2x RJ45 with 2 independent MAC/IP addresses
• Wake on LAN	Yes; Via Port 1
• IAMT (Intel Active Management Technology)	Yes
WLAN	
• Type	802.11ac
Integrated Functions	
Monitoring functions	
• Status LEDs	Battery status, device status, access to HDD/DVD, access to SD/MMC, MPI/DP, S5 and S7 modules / Card Reader (except Smart Card Reader), Num Lock, Caps Lock, WLAN active
EMC	
Interference immunity against discharge of static electricity	
• Interference immunity against discharge of static electricity acc. to IEC 61000-4-2	Yes; ± 4 kV contact discharge (to IEC 801-2/IEC 1000-4-2; ESD), ± 8 kV air discharge (to IEC 801-2/IEC 1000-4-2; ESD)
Interference immunity to cable-borne interference	
• Interference immunity on supply cables	± 2 kV (according to IEC 61000-4-4, burst); ± 1 kV (according to IEC 61000-4-5, surge pulse/line to line); ± 2 kV (according to IEC 61000-4-5, surge pulse/line to ground)
• Interference immunity on signal cables	± 1 kV (according to IEC 61000-4-4, burst, length < 30 m); ± 2 kV (according to IEC 61000-4-4, burst, length > 30 m); ± 2 kV (according to IEC 61000-4-5, surge sym./line to ground, length > 30 m)
Standards, approvals, certificates	
CE mark	Yes
CSA approval	Yes
UL approval	Yes
DIN/ISO 9001	Yes
Ambient conditions	
Ambient temperature during operation	
• min.	5 °C; Max. 10 °C/h (no condensation)
• max.	40 °C; Max. 10 °C/h (no condensation)
Ambient temperature during storage/transportation	
• min.	-20 °C; Max. 20 °C/h (no condensation)
• max.	60 °C; Max. 20 °C/h (no condensation)

Article number	6ES7717-.....-0... SIMATIC FIELD PG M5
Relative humidity	
• Operation, min.	5 %; At 30 °C/h (no condensation); Tested according to IEC 60068-2-78, IEC 60068-2-30, IEC 60068-2-14
• Operation, max.	85 %; At 30 °C/h (no condensation); Tested according to IEC 60068-2-78, IEC 60068-2-30, IEC 60068-2-14
Vibrations	
• Operation, tested according to IEC 60068-2-6	Yes
Shock testing	
• tested according to IEC 60068-2-27	Yes
Operating systems	
Additional info on operating system	Multi-Language User Interface (MUI): 6 languages (English, German, French, Spanish, Italian, Chinese)
pre-installed operating system	
• Windows 7	Yes; Ultimate 64 bit, SP1
Software	
Preinstalled	
• STEP 7 Professional 2010	Yes; Software version: SR4
• STEP 7 Professional (TIA Portal)	Yes
• WinCC flexible Advanced 2008	Yes; Software version: SP3
• WinCC Advanced (TIA Portal)	Yes
Mechanics/material	
Material of housing	metal
Handle	Yes; retractable
Socket for Kensington lock	Yes
rubber corner guards	Yes
Dimensions	
Width	385 mm
Height	53 mm
Depth	275 mm
Weights	
Weight, approx.	3.4 kg; incl. rechargeable battery
Scope of supply	
Accumulator	Yes
Power supply	Yes
Backpack	Yes
SIMATIC Software	Yes
Recovery media	Yes; Restore & Recovery
Other	
free hotline	Yes
Warranty period	24 mo; except for: rechargeable battery (6 months)
Note:	Made in Germany: development and production in Germany

SIMATIC programming devices

Programming devices

Field PG M5

Ordering data

Article No.

Field PG M5 Comfort programming device

6ES7717- 0 0 0 -0 A 1

Intel i5-6440EQ processor,
6 MB cache, 2.7 to 3.4 GHz,
15.6" display, full HD (1920x1080),
multistandard DVD+-R/+-RW drive,
Intel HD graphics, WLAN 802.11ac,
Bluetooth v4.0;
Windows 7 Ultimate SP1, 64-bit
(EN, DE, FR, ES, IT selectable);
without SIMATIC S5 interface,
without SIMATIC S5-EPROMMER

RAM

- 1 x 8 GB DDR4 SDRAM SO-DIMM **A**
- 1 x 16 GB DDR4 SDRAM SO-DIMM **B**
- 2 x 16 GB DDR4 SDRAM SO-DIMM **C**

Hard disk

- 1 TB HDD SATA **A**
- 512 GB SSD SATA **B**
- 1 TB SSD SATA **C**

Keyboard and power cable (essential)

- Keyboard: QWERTY (& German); power supply cable: Germany, France, the Netherlands, Spain, Belgium, Austria, Sweden, Finland **0**
- Keyboard: AZERTY (France); power supply cable: Germany, France, the Netherlands, Spain, Belgium, Austria, Sweden, Finland **1**
- Keyboard: QWERTY (& German); power supply cable: Italy **2**
- Keyboard: QWERTY (& German); power supply cable: Switzerland **3**
- Keyboard: QWERTY (& German); power supply cable: USA **4**
- Keyboard: QWERTY (& German); power supply cable: United Kingdom **5**
- Keyboard: QWERTY (& German); power supply cable: China; approvals for China (CCC) **6**
- Keyboard: QWERTY (& German); without power supply cable **7**

SIMATIC Software licenses

- Trial license: STEP 7 Prof. Combo (STEP 7 Prof. V14 and STEP 7 Prof. 2010), WinCC Adv. Combo (WinCC V14 and WinCC flexible 2008) **A**
- License: STEP 7 Prof. V14, WinCC Adv. V14 **B**
- License: STEP 7 Prof. Combo (STEP 7 Prof. V14 and STEP 7 Prof. 2010), WinCC Adv. Combo (WinCC V14 and WinCC flexible 2008) **C**

Article No.

Field PG M5 Advanced programming device

6ES7717- 1 1 1 -0 A 1

Intel i7-6820EQ processor,
8 MB cache, 2.8 to 3.5 GHz,
15.6" display, full HD (1920x1080),
multistandard DVD+-R/+-RW drive,
Intel HD graphics, WLAN 802.11ac,
Bluetooth v4.0;
Windows 7 Ultimate SP1, 64-bit
(EN, DE, FR, ES, IT selectable);
without SIMATIC S5 interface,
without SIMATIC S5-EPROMMER

RAM

- 1 x 8 GB DDR4 SDRAM SO-DIMM **A**
- 1 x 16 GB DDR4 SDRAM SO-DIMM **B**
- 2 x 16 GB DDR4 SDRAM SO-DIMM **C**

Hard disk

- 1 TB HDD SATA **A**
- 512 GB SSD SATA **B**
- 1 TB SSD SATA **C**

SIMATIC S5 interface

- Without S5 interface, without S5 EPROMMER **0**
- With S5 interface, with S5 EPROMMER; incl. STEP 5 license, S5 PLC cable and EPROM adapter **1**

Keyboard and power cable (essential)

- Keyboard: QWERTY (& German); power supply cable: Germany, France, the Netherlands, Spain, Belgium, Austria, Sweden, Finland **0**
- Keyboard: AZERTY (France); power supply cable: Germany, France, the Netherlands, Spain, Belgium, Austria, Sweden, Finland **1**
- Keyboard: QWERTY (& German); power supply cable: Italy **2**
- Keyboard: QWERTY (& German); power supply cable: Switzerland **3**
- Keyboard: QWERTY (& German); power supply cable: USA **4**
- Keyboard: QWERTY (& German); power supply cable: United Kingdom **5**
- Keyboard: QWERTY (& German); power supply cable: China; approvals for China (CCC) **6**
- Keyboard: QWERTY (& German); without power supply cable **7**

SIMATIC Software licenses

- Trial license: STEP 7 Prof. Combo (STEP 7 Prof. V14 and STEP 7 Prof. 2010), WinCC Adv. Combo (WinCC V14 and WinCC flexible 2008) **A**
- License: STEP 7 Prof. V14, WinCC Adv. V14 **B**
- License: STEP 7 Prof. Combo (STEP 7 Prof. V14 and STEP 7 Prof. 2010), WinCC Adv. Combo (WinCC V14 and WinCC flexible 2008) **C**

Ordering data	Article No.	Article No.
Accessories		
Memory expansion		
8 GB RAM	6ES7648-2AK70-0PA0	
16 GB RAM	6ES7648-2AK80-0PA0	
AC/DC external power supply unit	6ES7798-0GA04-0XA0	
For Field PG M5 only; spare part, included in the scope of supply of the Field PG M5		
Power cord (length 3 m)		
For Field PG M2/M4/M5 only		
For Germany, France, the Netherlands, Spain, Belgium, Austria, Sweden, Finland	6ES7900-5AA00-0XA0	
For Great Britain	6ES7900-5BA00-0XA0	
For Switzerland	6ES7900-5CA00-0XA0	
For the USA	6ES7900-5DA00-0XA0	
For Italy	6ES7900-5EA00-0XA0	
For China	6ES7900-5FA00-0XA0	
Spare battery (lithium ion, 8.8 Ah)¹⁾	6ES7798-0AA08-0XA0	
For Field PG M5 only; spare part, included in the scope of supply of the Field PG M5		
MPI cable	6ES7901-0BF00-0AA0	
For connecting a PG and SIMATIC S7 via MPI; 5 m		
S5 EPROM programming adapter	6ES7798-0CA00-0XA0	
For SIMATIC S5 EPROM programming using the Field PG		
S5 connection cable	6ES5734-2BF00	
For connecting programming devices to SIMATIC S5 PLCs, 5 m		
Replaceable hard disk kit	6ES7791-2BA02-0AA0	
Replaceable hard disk 1 TB serial ATA; with protective pocket and torx screwdriver; for Field PG M4/M5		
Replaceable SSD kit		
Replaceable SSD 512 GB serial ATA; with protective pocket and torx screwdriver; for Field PG M5	6ES7791-2BA22-0AA0	
Replaceable SSD 1 TB serial ATA; with protective pocket and torx screwdriver; for Field PG M5	6ES7791-2BA23-0AA0	
		Adapter serial ATA to USB 3.0
		6ES7790-1AA01-0AA0
		For using the removable hard disk in the hard disk kit as an external hard disk (only for Field PG M4/M5)
		Backpack for Field PG M4/M5
		6ES7798-0DA02-0XA0
		SIMATIC IPC Image & Partition Creator V3.5
		6ES7648-6AA03-5YA0
		Software tool for very easy preventive data backup and efficient partition management on SIMATIC IPCs
		Software Update Service (Standard Edition)²⁾
		The delivery is implemented according to the number of ordered SUS products (e.g. 10 upgrade packages with 10 DVDs, 10 USB flash drives, etc.)
		• STEP 7 Professional V1x
		6ES7822-1AA00-0YL5
		• STEP 7 Professional Combo (STEP 7 Prof. V1x (TIA Portal) and STEP 7 Prof.)
		6ES7810-5CC04-0YE2
		• SIMATIC WinCC Advanced
		6AV6613-0AA00-0AL0
		Software Update Service (download)²⁾
		The upgrades and service packs are available for downloading. Email address required for delivery
		• STEP 7 Professional V1x
		6ES7822-1AE00-0YY0
		• STEP 7 Professional Combo (STEP 7 Prof. V1x (TIA Portal) and STEP 7 Prof.)
		6ES7810-5CC04-0YY2
		• SIMATIC WinCC Advanced
		6AV6613-0AA00-0AY0

¹⁾ The capacity of the battery decreases for technological reasons with each charging/discharging cycle and also as the result of being stored at excessively high or low temperatures. The running time per charge decreases therefore over the course of time. With normal use, the battery can be charged and discharged over a period of six months from when the Field PG is purchased. Loss of capacity is not covered by the warranty. For the battery's operation we grant a warranty of six months. We recommend replacing the battery with an original Siemens battery at the end of these six months if there is a significant drop in performance.

²⁾ For more information on the Software Update Service, see page 11/2.

SIMATIC programming devices

Programming devices

Accessories

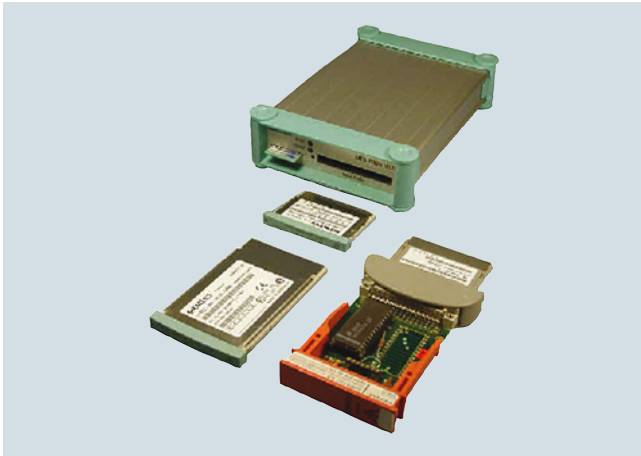
External prommer**Overview**

- External EPROM programming device
- For programming SIMATIC Memory Cards, SIMATIC Micro Memory Cards as well as SIMATIC EPROM and EEPROM modules
- For connection to the PC via the USB interface

Technical specifications

Article number	6ES7792-0AA00-0XA0 USB PROMMER, 115/220V
General information	
Design of the programming device	Desktop device
Display	
Design of display	without
Supply voltage	
Design of the power supply	90 to 264 V; 47 to 63 Hz; wide range power supply unit
Ambient conditions	
Ambient temperature during operation	
• min.	5 °C
• max.	40 °C
Ambient temperature during storage/transportation	
• min.	-20 °C
• max.	60 °C
Dimensions	
Width	172 mm
Height	40 mm
Depth	121 mm
Weights	
Weight, approx.	400 g

Ordering data**Article No.****EPROM programming device
USB-Prommer****6ES7792-0AA00-0XA0**For programming SIMATIC Memory
Cards and EPROM modules

Overview

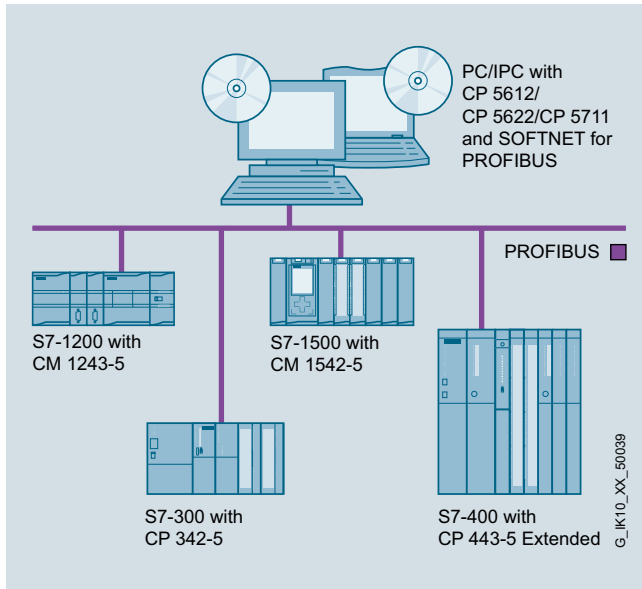

DP-M	DP-S	FMS	OPC	PG/OP	S7/S5
●	●		●	●	●

©_IK10_XX_1008

- Software for connecting PCs/programming devices and notebooks to automation systems
- Communication services:
 - PROFIBUS DP master Class 1 and 2 with acyclic expansions
 - PROFIBUS DP slave
 - PG/OP communication
 - S7 communication
 - Open communication (SEND/RECEIVE) based on the FDL interface
- The appropriate OPC servers and configuration tools are included in the scope of supply of the respective communications software

Technical specifications

Performance data	CP 5612/CP 5622/CP 5711
<u>Mono protocol mode</u>	
Number of connectable DP slaves	max. 60
Number of FDL tasks waiting	max. 50
Number of PG/OP and S7 connections	max. 8
• DP master	DP-V0, DP-V1 with SOFTNET-PB DP
• DP slave	DP-V0, DP-V1 with SOFTNET-PB DP slave

SIMATIC programming devices

Programming devices

Accessories

Communications software > SOFTNET for PROFIBUS

Ordering data	Article No.	Ordering data	Article No.
SOFTNET-PB S7 Software for S7 communication, incl. FDL protocol with OPC server and configuration tool, runtime software, software and electronic manual on DVD-ROM, license key on USB stick, Class A; for CP 5612 (Win 7 and higher), CP 5622 (Win 7 and higher), CP 5711		SOFTNET-PB DP slave Software for DP slave, with OPC server and configuration tool, single license for one installation, runtime software, software and electronic manual on DVD-ROM, license key on USB stick, Class A; for CP 5612 (Win 7 and higher), CP 5622 (Win 7 and higher), CP 5711	
SOFTNET-PB S7 V14 For 32/64-bit: Windows 7 SP1 Professional/Ultimate; For 64-bit: Windows 8.1 Pro; For 64-bit: Windows Server 2008 R2 SP1; For 64-bit: Windows Server 2012 R2; German/English • Single license for one installation	6GK1704-5CW14-0AA0	SOFTNET-PB DP slave V14 For 32/64-bit: Windows 7 SP1 Professional/Ultimate; For 64-bit: Windows 8.1 Pro; For 64-bit: Windows Server 2008 R2 SP1; For 64-bit: Windows Server 2012 R2; German/English • Single license for one installation	6GK1704-5SW14-0AA0
Software Update Service For 1 year, with automatic extension; requirement: current software version	6GK1704-5CW00-3AL0	Software Update Service For 1 year, with automatic extension; requirement: current software version	6GK1704-5SW00-3AL0
Upgrade • From Edition 2006 to SOFTNET-S7 Edition 2008 or V14 • From V6.0, V6.1, V6.2 or V6.3 to SOFTNET-S7 Edition 2008 or V14	6GK1704-5CW00-3AE0 6GK1704-5CW00-3AE1	Upgrade • From Edition 2006 to SOFTNET-DP slave Edition 2008 or V14 • From V6.0, V6.1, V6.2 or V6.3 to SOFTNET-DP slave Edition 2008 or V14	6GK1704-5SW00-3AE0 6GK1704-5SW00-3AE1
SOFTNET-PB DP Software for DP protocol (master Class 1 and 2), incl. FDL protocol with OPC server and configuration tool; runtime software, software and electronic manual on DVD-ROM, license key on USB stick; for CP 5612 (Win 7 and higher), CP 5622 (Win 7 and higher), CP 5711			
SOFTNET-PB DP V14 For 32/64-bit: Windows 7 SP1 Professional/Ultimate; For 64-bit: Windows 8.1 Pro; For 64-bit: Windows Server 2008 R2 SP1; For 64-bit: Windows Server 2012 R2; German/English • Single license for one installation	6GK1704-5DW14-0AA0		
Software Update Service For 1 year, with automatic extension; requirement: current software version	6GK1704-5DW00-3AL0		
Upgrade • From Edition 2006 to SOFTNET-DP Edition 2008 or V14 • From V6.0, V6.1, V6.2 or V6.3 to SOFTNET-DP Edition 2008 or V14	6GK1704-5DW00-3AE0 6GK1704-5DW00-3AE1		

Note:

The Windows XP software version is still available for older CPs; see the Industry Mall:

<http://www.siemens.com/industrymall>.

Overview

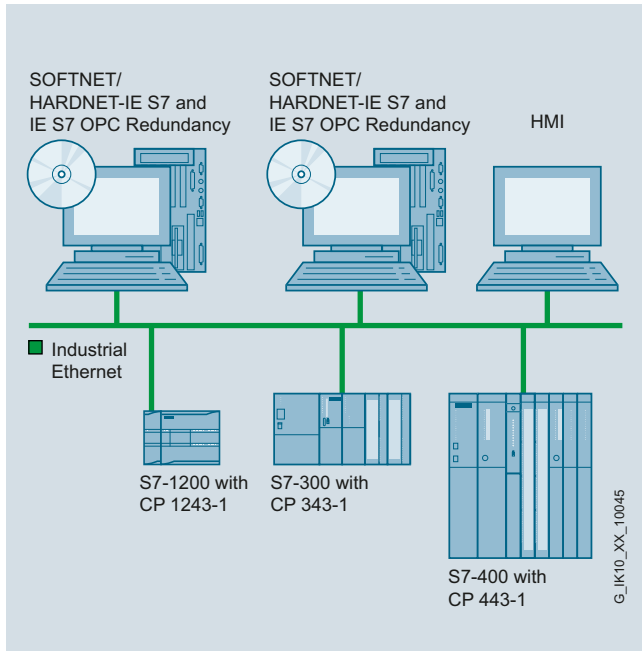

System configuration SOFTNET for Industrial Ethernet

ISO	TCP/UDP	PN	MRP	OPC	PG/OP	S7/S5	IT
●	●			●	●	●	

G_ILK10_XX_10045

- Software for coupling programming devices/workstations to automation systems
- Communication services:
 - PG/OP communication
 - S7 communication
 - Open communication (SEND/RECEIVE)
- Can be used with
 - Layer 2 Ethernet card (PCI/PCIe), e.g. CP 1612 A2
 - Integrated Industrial Ethernet interface
 - Modem/ISDN (Remote Access Service RAS)
- Complete protocol stack as a software package
- Increased availability thanks to additional option packages such as OPC Server Redundancy

Technical specifications

Performance data

S7 and PG/OP communication (number of operable connections)

- | | |
|--------------------------|--|
| • SOFTNET-IE S7 Extended | Max. 255 (S7-300 / S7-400)
Max. 512 (S7-1200 / S7-1500) |
| • SOFTNET-IE S7 | Max. 64 |
| • SOFTNET-IE S7 Lean | Max. 8 |

SIMATIC programming devices

Programming devices

Accessories

Communications software > SOFTNET for Industrial Ethernet

Ordering data	Article No.	Article No.	
SOFTNET S7 for Industrial Ethernet Software for S7 and open communication, incl. OPC server, PG/OP communication, and NCM PC/STEP 7 Professional V12, runtime software, software and electronic manual on CD-ROM, license key on a USB stick, Class A			
SOFTNET-IE S7 V14 For 32/64-bit: Windows 7 SP1 Professional/Ultimate; For 64-bit: Windows 8.1 Pro; For 64-bit: Windows Server 2008 R2 SP1; For 64-bit: Windows Server 2012 R2; German/English Up to 64 connections; single license for one installation <ul style="list-style-type: none"> • On DVD • Download ¹⁾ 	6GK1704-1CW14-0AA0 6GK1704-1CW14-0AK0	SOFTNET-IE S7 Lean Edition V14 For 32/64-bit: Windows 7 SP1 Professional/Ultimate; For 64-bit: Windows 8.1 Pro; For 64-bit: Windows Server 2008 R2 SP1; For 64-bit: Windows Server 2012 R2; Up to eight connections; German/English; single license for one installation <ul style="list-style-type: none"> • On DVD • Download ¹⁾ 	6GK1704-1LW14-0AA0 6GK1704-1LW14-0AK0
Software Update Service For 1 year with automatic extension; requirement: current software version	6GK1704-1CW00-3AL0	Software Update Service For 1 year with automatic extension; requirement: current software version	6GK1704-1LW00-3AL0
Upgrade <ul style="list-style-type: none"> • From Edition 2006 to Edition 2008 or V14 • From V6.0, V6.1, V6.2 or V6.3 to Edition 2008 or V14 	6GK1704-1CW00-3AE0 6GK1704-1CW00-3AE1	Upgrade <ul style="list-style-type: none"> • From Edition 2006 to Edition 2008 or V14 • From V6.0, V6.1, V6.2 or V6.3 to Edition 2008 or V14 	6GK1704-1LW00-3AE0 6GK1704-1LW00-3AE1
SOFTNET-IE S7 REDCONNECT VM V14 Software for fail-safe S7 communication via redundant networks, incl. S7 OPC server, runtime software, software and electronic manual on CD-ROM, license key on USB stick, Class A For 32/64-bit: Windows 7 SP1 Professional/Ultimate; For 64-bit: Windows 8.1 Pro; For 64-bit: Windows Server 2008 R2 SP1; For 64-bit: Windows Server 2012 R2; German/English <ul style="list-style-type: none"> • Single license for one installation 	6GK1704-0HB14-0AA0	IE S7 OPC Redundancy Software for redundant OPC servers in the environment of Industrial Ethernet software, S7 products, runtime software, software and electronic manual on CD-ROM, license key on USB stick, Class A	
		IE S7 OPC Redundancy V14 For 64-bit: Windows 2008 Server R2 SP1; German/English <ul style="list-style-type: none"> • Single license for one installation 	6GK1706-1CW14-0AA0

¹⁾ For more details of online software delivery, visit: <http://www.siemens.com/tia-online-software-delivery> under Ordering Data.

Products for specific requirements

13/2 Telecontrol systems for comprehensive applications

- 13/2 Introduction
- 13/3 SIPLUS RIC substations for IEC protocol
- 13/4 SIPLUS RIC libraries for SIMATIC S7-1500 and ET 200SP
- 13/5 SIPLUS RIC libraries for SIMATIC ET 200S
- 13/6 SIPLUS RIC libraries for SIMATIC S7-300
- 13/7 SIPLUS RIC libraries for SIMATIC S7-400
- 13/8 SIPLUS RIC libraries for PC-based Automation

13/9 Automatic door controls

- 13/9 Introduction
- 13/10 Automatic door controls for elevators
- 13/11 Controllers
 - 13/11 SIDOOR AT12 elevator door drive
 - 13/13 SIDOOR AT40 elevator door drive
 - 13/16 SIDOOR ATD400V elevator door drive
 - 13/18 SIDOOR ATE500E elevator door drive
- 13/21 Power supplies
 - 13/21 Power transformer
 - 13/22 Switched-mode power supply
- 13/23 Additional units
 - 13/23 Software kit
 - 13/23 Service tool
- 13/24 Geared motors
- 13/26 Direct drives
- 13/27 Accessories
- 13/31 Automatic door controls for industry applications
- 13/31 Introduction
- 13/32 Controllers
 - 13/32 SIDOOR ATD400K cold room gate drive
 - 13/34 SIDOOR ATD401W machine tool door drive
 - 13/36 SIDOOR ATD410W machine tool door drive
 - 13/39 SIDOOR ATD420W machine tool door drive
 - 13/42 SIDOOR ATD430W machine tool door drive
- 13/45 Power supplies
 - 13/45 Power transformer
 - 13/45 Switched-mode power supply
- 13/46 SITOP PSU8200 3-phase, 36 V DC/13 A
- 13/48 Additional units
 - 13/48 Software kit
 - 13/48 Service tool
- 13/49 Geared motors
- 13/51 Accessories

- 13/54 Automatic door controls for railway applications
- 13/54 Introduction
- 13/55 Controllers
 - 13/55 Platform screen door drive
 - 13/58 Interior railway door drive
- 13/60 Power supplies
 - 13/60 Power transformer
 - 13/60 Switched-mode power supply
- 13/61 Additional units
 - 13/61 Software kit
 - 13/61 Service tool
- 13/62 Geared motors
- 13/64 Direct drives
- 13/65 Accessories

13/68 Condition monitoring systems

- 13/68 Introduction
- 13/68 SIPLUS CMS1200 Condition Monitoring System
- 13/69 SIPLUS CMS1200 SM 1281 Condition Monitoring
 - 13/71 Accessories
- 13/73 SIPLUS CMS2000 Condition Monitoring System
- 13/74 Basic units
- 13/76 Expansion modules
- 13/78 Accessories

13/80 Time synchronisation

- 13/80 Introduction
- 13/81 Wireless receivers
 - 13/81 Central plant clocks
 - 13/83 GPS receivers
- 13/85 Pulse converters
- 13/87 Accessories
- 13/88 Bundles

Brochures

For brochures serving as selection guides for SIMATIC products, refer to:
www.siemens.com/simatic/printmaterial

Products for specific requirements

Telecontrol systems for comprehensive applications

Introduction

Overview

Telecontrol systems for controlling and monitoring widely distributed plants usually consist of a supervisory control system (telecontrol center) and one or more outstations connected over large distances for the automation of distributed plant sections.

SIPLUS RIC is a versatile telecontrol system that uses the internationally standardized telecontrol protocols:

- Serial transmission IEC 60870-5-101
- Ethernet (TCP/IP) IEC 60870-5-104
- Connection of protection devices IEC 60870-5-103

It provides secure communication with reduced data volume for reliable operation in the Wide Area Network (WAN) thanks to event-driven, time-stamped transmission and monitored output of commands.

Application

SIPLUS RIC offers maximum functionality and modularity to meet the requirements made upon the monitoring and control of spatially distributed systems, even under extreme environmental conditions.

It is therefore suitable for sectors such as oil, gas, water, wastewater, power generation/distribution, and transportation.

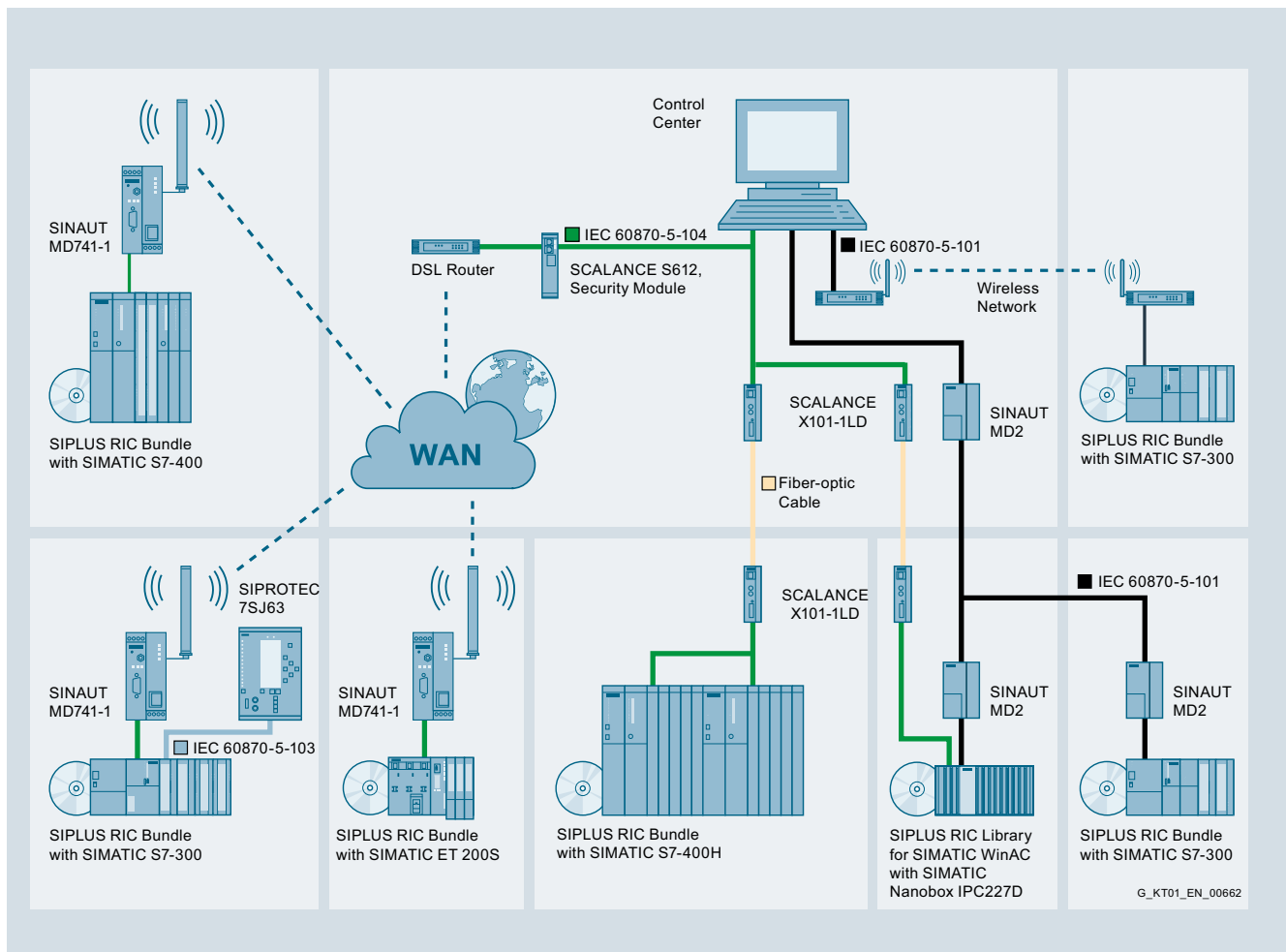

G_KT01_EN_00662

Overview

IEC 60870-5-101, IEC 60870-5-103 and IEC 60870-5-104 are standardized vendor-independent protocols. With SIPLUS RIC, they can be parameterized with the SIMATIC Manager or TIA Portal V13 SP1 without the need for additional installations.

The IEC 60870-5-101 protocol supports standard WLAN connections via dedicated lines; in the automation system the modems are coupled via RS 232 to the 1SI, CP 340, CP 341, CP 441, CP 1540 or CP 1541 communication modules.

The protocol IEC 60870-5-103 permits serial communication with protection devices, e.g. SIPROTEC. Coupling takes place via the 1SI, CP 340, CP 341, CP 441, CM PTP, CP1540 or CP1541 communication modules and RS 485 interface with fiber-optic cables.

The IEC 60870-5-104 protocol supports TCP/IP-based WAN connections such as Internet/DSL or GPRS/UMTS/LTE. Either the PN interfaces of the CPUs or the CP 343-1CX10/-1EX30/-1GX30 and CP 1543 communication modules are used as interfaces. Redundancy groups and substitute routes (combinations of serial and Ethernet transmission paths) are both possible and enabled via the interfaces.

The libraries for the IEC 60870-5-101 and -104 protocols are supplied as master and slave including activation for PN-CPU and CP interface. The IEC 60870-5-103 is only provided as master.

SIMATIC Controllers can also communicate with third-party products by means of the IEC protocols.

Information can be forwarded both from lower-level stations and protection devices to the control centers. Automatic updating of the information objects can take place which can then be forwarded with the information object and ASDU address unchanged. These addresses can however also be changed by means of parameter assignment.

Products for specific requirements

Telecontrol systems for comprehensive applications
SIPLUS RIC substations for IEC protocol

SIPLUS RIC libraries for SIMATIC S7-1500 and ET 200SP

Overview



If a SIMATIC S7-1500/ET 200SP-based system is to communicate with a Siemens control center, e.g. SIMATIC PCS 7 TeleControl, WinCC TeleControl, WinCC OA, or a control center of a third-party supplier using the IEC 60870-5 telecontrol standard, the IEC 60870-5-101 (serial), -103 (protection) or -104 (TCP/IP) telecontrol protocols can be used in the SIMATIC automation systems.

SIPLUS RIC libraries offer an integrated, scalable system based on SIMATIC S7-1500/ET 200SP functions, for the following data volumes:

- 200 information points, for use with CPU 1510SP-1 PN, CPU 1511-1 PN and CPU 1511C-1 PN
- 800 information points, for use with CPU 1512SP-1 PN and CPU 1512C-1 PN
- 1000 information points, for use with CPU 1513-1 PN
- 2000 information points, for use with CPU 1515-2 PN
- 4000 information points, for use with CPU 1516-3 PN/DP
- 5000 information points, for use with CPU 1517-3 PN/DP and with CPU 1518-4 PN/DP

The work memory for data is used for buffering the message frames. Longer communication failure times can thus be bridged. The SIPLUS RIC software libraries are based on the standard TIA Portal and can be used on various, mutually compatible types of SIMATIC S7 devices, thus saving hardware costs and programming overhead.

The libraries on CD are supplied together with a SIMATIC Memory Card, which can be used on all CPUs. Four versions with different memory sizes are available for selection.

With SIPLUS extreme hardware, telecontrol devices for an extended ambient temperature range (-25 ... +70 °C) and exceptional exposure to media (conformal coating) can be implemented using the telecontrol protocols.

A license certificate with the activation of all telecontrol protocols IEC 60870-5-101 (serial), -103 (protection) or -104 (TCP/IP) is supplied for the SIMATIC Memory Card included in the scope of delivery.

Ordering data

SIPLUS RIC libraries for SIMATIC S7-1500/ET 200SP

Runtime license;
CD with software and documentation

- with SIMATIC Memory Card; 12 MB
- with SIMATIC Memory Card; 24 MB
- with SIMATIC Memory Card; 256 MB
- with SIMATIC Memory Card; 2 GB

Article No.

6AG6003-8CF00-0LE0

6AG6003-7CF00-0LF0

6AG6003-7CF00-0LL0

6AG6003-7CF00-0LP0

Products for specific requirements

Telecontrol systems for comprehensive applications
SIPLUS RIC substations for IEC protocol

SIPLUS RIC libraries for SIMATIC ET 200S

Overview



If a SIMATIC ET 200S-based system is to communicate with a Siemens control center, e.g. SIMATIC PCS 7 TeleControl, WinCC TeleControl, WinCC OA, or a control center of a third-party supplier using the IEC 60870-5 telecontrol standard, the IEC 60870-5-101 (serial), -103 (protection) or -104 (TCP/IP) telecontrol protocols can be used in the SIMATIC automation systems.

SIPLUS RIC libraries offer an integrated, scalable system based on SIMATIC ET 200S functions, for up to 200 information points.

The non-retain memory can also be used for buffering message frames. Longer communication failure times can thus be bridged. The SIPLUS RIC software libraries are based on the standard SIMATIC Manager or TIA Portal and can be used on various, mutually compatible types of SIMATIC S7 devices – this saves hardware costs and programming overhead.

The libraries on CD are supplied together with a SIMATIC Memory Card, which can be used on all CPUs. Two versions with different memory sizes are available for selection.

With SIPLUS Extreme Hardware, telecontrol devices for an extended ambient temperature range (-25 ... +70 °C) and exceptional exposure to media (conformal coating) can be implemented using the telecontrol protocols.

A license certificate with the activation of all telecontrol protocols IEC 60870-5-101 (serial), -103 (protection) or -104 (TCP/IP) is supplied for the SIMATIC Memory Card included in the scope of delivery.

Note:

The SIPLUS RIC libraries for ET 200S completely replace the previous SIPLUS RIC ET 200S bundles und SIPLUS RIC ET 200S extreme bundles.

Ordering data

SIPLUS RIC libraries for SIMATIC ET 200S

Runtime license;
CD with software and
documentation

- with SIMATIC Memory Card,
512 KB
- with SIMATIC Memory Card,
2 MB

Article No.

6AG6003-5CF00-0CA0

6AG6003-5CF00-0DA0

Products for specific requirements

Telecontrol systems for comprehensive applications
SIPLUS RIC substations for IEC protocol

SIPLUS RIC libraries for SIMATIC S7-300

Overview



If a SIMATIC S7-300-based system is to communicate with a Siemens control center, e.g. SIMATIC PCS 7 TeleControl, WinCC TeleControl, WinCC OA, or a control center of a third-party supplier using the IEC 60870-5 telecontrol standard, the IEC 60870-5-101 (serial), -103 (protection) or -104 (TCP/IP) telecontrol protocols can be used in the SIMATIC automation systems.

SIPLUS RIC libraries offer an integrated, scalable system based on SIMATIC S7-300 functions, for the following data quantities:

- 200 information points, for use with CPU 314
- 1 000 information points, for use with CPU 315
- 2 000 information points, for use with CPU 317
- 5 000 information points, for use with CPU 319

The non-retain memory can also be used for buffering message frames. Longer communication failure times can thus be bridged. The SIPLUS RIC software libraries are based on the standard SIMATIC Manager or TIA Portal and can be used on various, mutually compatible types of SIMATIC S7 devices – this saves hardware costs and programming overhead.

The libraries on CD are supplied together with a SIMATIC Memory Card, which can be used on all CPUs. Two versions with different memory sizes are available for selection.

With SIPLUS Extreme Hardware, telecontrol devices for an extended ambient temperature range (-25 ... +70 °C) and exceptional exposure to media (conformal coating) can be implemented using the telecontrol protocols.

A license certificate with the activation of all telecontrol protocols IEC 60870-5-101 (serial), -103 (protection) or -104 (TCP/IP) is supplied for the SIMATIC Memory Card included in the scope of delivery.

Note:

The SIPLUS RIC libraries for S7-300 completely replace the previous SIPLUS RIC S7-300 bundles und SIPLUS RIC S7-300 extreme bundles.

Ordering data

SIPLUS RIC libraries for SIMATIC S7-300

Runtime license;
CD with software and documentation

- with SIMATIC Memory Card, 512 KB
- with SIMATIC Memory Card, 2 MB

Article No.

6AG6003-1CF00-0CA0

6AG6003-1CF00-0DA0

Products for specific requirements

Telecontrol systems for comprehensive applications
SIPLUS RIC substations for IEC protocol

SIPLUS RIC libraries for SIMATIC S7-400

Overview



If a SIMATIC S7-400-based system is to communicate with a Siemens control center, e.g. SIMATIC PCS 7 TeleControl, WinCC TeleControl, WinCC OA, or a control center of a third-party supplier using the IEC 60870-5 telecontrol standard, the IEC 60870-5-101 (serial), -103 (protection) or -104 (TCP/IP) telecontrol protocols can be used in the SIMATIC automation systems.

SIPLUS RIC libraries offer an integrated, scalable system based on SIMATIC S7-400 functions, for the following data quantities:

- 1 000 information points, for use with CPU 412 or CPU 412H
- 2 000 information points, for use with CPU 414 or CPU 414H
- 5 000 information points, for use with CPU 416 or CPU 416H

The non-retain memory can also be used for buffering message frames. Longer communication failure times can thus be bridged. The SIPLUS RIC software libraries are based on the standard SIMATIC Manager or TIA Portal and can be used on various, mutually compatible types of SIMATIC S7 devices – this saves hardware costs and programming overhead.

The libraries are supplied on a CD and can be used on all CPUs.

With SIPLUS Extreme Hardware, telecontrol devices for an extended ambient temperature range (-25 ... +70 °C) and exceptional exposure to media (conformal coating) can be implemented using the telecontrol protocols.

A memory card or a CPU (CPU V4.x or higher and CPU 410H) is licensed. All IEC 60870-5-101 (serial), -103 (protection) or -104 (TCP/IP) telecontrol protocols are activated via the email address siplus-ric.automation@siemens.com.

Note:

The SIPLUS RIC libraries for S7-400 completely replace the previous SIPLUS RIC S7-400 bundles, SIPLUS RIC S7-400 extreme bundles, and IEC 60870 libraries for SIMATIC PCS 7.

Ordering data

SIPLUS RIC libraries for SIMATIC S7-400

Runtime license for SIMATIC S7-400 firmware version 4.x or higher;
CD with software and documentation;
note:
If used in S7-400H systems, a license will be required for both CPUs

Article No.

6AG6003-3CF00-0AA0

Products for specific requirements

Telecontrol systems for comprehensive applications
SIPLUS RIC substations for IEC protocol

SIPLUS RIC libraries for PC-based Automation

Overview



If a SIMATIC WinAC RTX-/S7-1500 Software Controller/ Open Controller-based system is to communicate with a Siemens control center, e.g. SIMATIC PCS 7 TeleControl, WinCC TeleControl, WinCC OA, or a control center of a third-party supplier using the IEC 60870-5 telecontrol standard, the IEC 60870-5-101 (serial), -103 (protection) or -104 (TCP/IP) telecontrol protocols can be used in the SIMATIC automation systems.

The SIPLUS RIC software libraries are based on the standard SIMATIC Manager or TIA Portal and can be used on various, mutually compatible types of SIMATIC S7 devices – this saves hardware costs and programming overhead.

The libraries are supplied on a CD and can be used for all WinAC-RTX-/S7-1500 Software Controller/Open Controller systems.

With SIPLUS Extreme Hardware, telecontrol devices for an extended ambient temperature range (-25 ... +70 °C) and exceptional exposure to media (conformal coating) can be implemented using the telecontrol protocols.

All IEC 60870-5-101 (serial), -103 (protection) or -104 (TCP/IP) telecontrol protocols are activated via the email address siplus-ric.automation@siemens.com.

Note:

The SIPLUS RIC libraries for PC-based Automation include SIPLUS RIC libraries for:

- SIMATIC ET 200SP Open Controller, CPU 1515SP PC
- SIMATIC S7-1500 Software Controller
- SIMATIC WinAC

Ordering data

SIPLUS RIC libraries for PC-based Automation

Runtime license;
CD with software and documentation

Article No.

6AG6003-0CF00-0AA0

Overview



SIDOOR door control systems

Door control system is the general term for a controller of an access system.

The SIDOOR product family is primarily intended for the operation of sliding doors, whereby these doors can be operated both horizontally and vertically.

Door control systems are characterized by the fact that there are always two defined states for the open and closed position of the door.

The door is always controlled, regulated and moved between these two positions in accordance with the guidelines of the respective application.

In a defined learn run via "Single-button operation", the door system independently determines the values for the door width, the dynamic door weight and the drive direction of the geared motor and stores these data in a non-volatile memory.

The optimum drive characteristics at the door are automatically calculated and are consistently adhered to.

The travel curve transitions are rounded off so that the door movement is smooth and jerk-free.

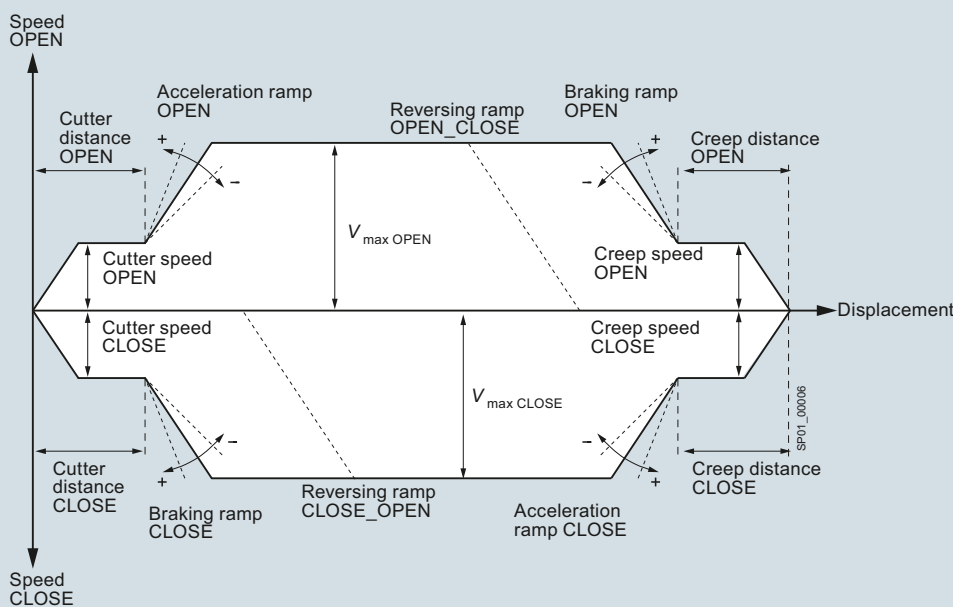

Creep speed	Reduced speed in the vicinity of the OPEN position of the elevator door (creep distance)
Cutter speed	Reduced speed in the vicinity of the CLOSED position of the elevator door (cutter distance)
Creep distance	Range of door travel in the vicinity of the OPEN position
Cutter distance	Range of door travel in the vicinity of the CLOSED position
V_{max}	Maximum permissible door speed

Reversing ramp OPEN_CLOSE	Travel reverses from the OPEN to the CLOSE direction
Reversing ramp CLOSE_OPEN	Travel reverses from the CLOSE to the OPEN direction

Note:

When reversing from the open to the close direction, the door is braked with the reversing ramp OPEN_CLOSE, and starts the closing movement with the acceleration ramp CLOSE.

Travel curve

Products for specific requirements

Automatic door controls

For elevators

Overview

The elevator door drive is comprised of a controller and a maintenance-free drive unit, geared motor or gearless EC technology direct drive motor.

Controllers are electronic controllers connected to the power supply via either an internal power supply unit (SIDOOR AT12) or an external power supply unit (SIDOOR NT40, SIDOOR Transformer). They are generally connected to the higher-level controller via digital or fieldbus interfaces, and can be configured via a user interface.

The SIDOOR AT12, SIDOOR AT40 and SIDOOR ATE500E controllers can be used to operate horizontally operated cabin and shaft doors at adjustable speeds and accelerations.

The SIDOOR ATD400V controller for rising doors and rolling shutters enables the operation of vertical door systems on elevators at adjustable speeds and accelerations.

Geared motors form the maintenance-free drive unit in the door drive. The geared motors are DC motors with non-self-locking gearing, and are speed-controlled. The set force and speed limits are not exceeded. The gearless motor (direct drive) is the maintenance-free drive unit of the door drive.

Operation of the named door drives does not require limit switches. The door width and the "OPEN"/"CLOSE" positions are determined automatically.

The power is transmitted by a toothed belt. The toothed belt passes over a deflector pulley and can be fitted with 2 door clutch holders. This enables it to drive both one-sided and centrally opening doors. The accessories are not included in the scope of supply, see "Accessories".

Design

The product-specific property of the elevator door controllers is based on the fact that the closing weights/closing springs integrated in the shaft doors are also taken into account.

These weights/springs are integrated in the shaft doors so that open doors close automatically if the cabin is not at the relevant floor.

They must also be moved by the elevator door drive in their opening direction and support it their closing movement.

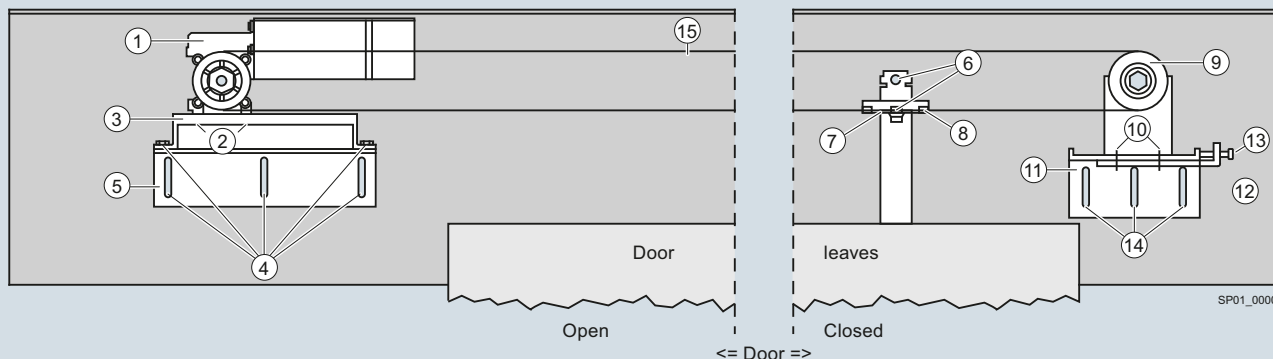

Complete motor mounting

- ① Geared motor
- ② 4 x locking hexagonal safety bolts M5 x 10
- ③ Rubber-metal anti-vibration mount
- ④ 10 x locking hexagonal safety bolts M6 x 16
- ⑤ Mounting bracket for the motor mounting

Mounting material for door clutch holder

- ⑥ 2 x locking hexagonal safety bolts M6 x 12
- ⑦ Door clutch holder
- ⑧ Clamping plate

Deflector unit and clamping device

- ⑨ Deflector unit
- ⑩ 2 x locking hexagonal safety bolts M6 x 12
- ⑪ Mounting bracket for the deflector unit and tensioning device
- ⑫ Tensioning lug for the deflector unit and tensioning device
- ⑬ Tensioning screw M6 x 30
- ⑭ 10 x locking hexagonal safety bolts M6 x 16
- ⑮ Toothed belt (length 4 m)

Mounting suggestion for door control systems

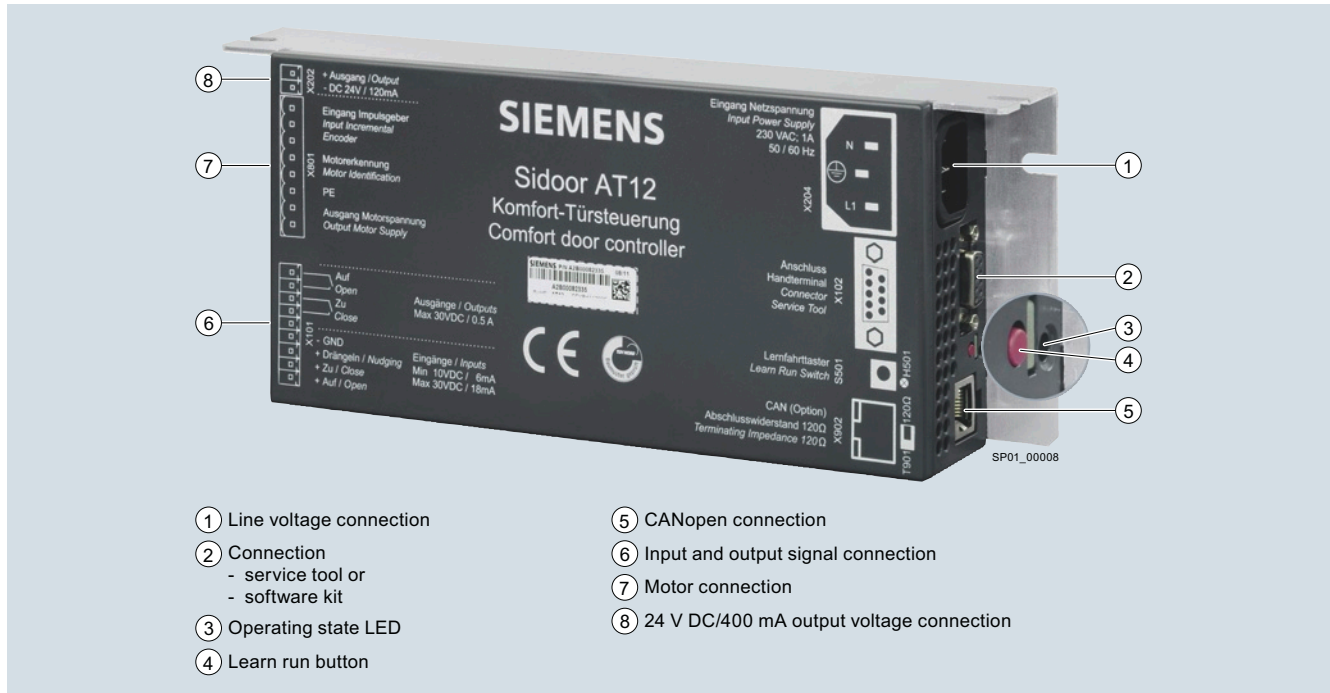
Overview

- | | |
|---|--|
| ① Line voltage connection | ⑤ CANopen connection |
| ② Connection
- service tool or
- software kit | ⑥ Input and output signal connection |
| ③ Operating state LED | ⑦ Motor connection |
| ④ Learn run button | ⑧ 24 V DC/400 mA output voltage connection |

SIDOOR AT12 elevator door drive

SIDOOR AT12 – SIDOOR enables the quick, easy and versatile installation, configuration and operation of a wide range of elevator door systems.

- For dynamic door weights up to 120 kg
- 4 kg maximum counterweight
- Operating temperature 0 to +50 °C
- Opening width 0.3 to 2.4 m

- Integrated switched-mode power supply
- Auxiliary voltage output 24 V DC, 120 mA (short-circuit-proof)
- CANopen interface (integrated in the controller)
- IP20 degree of protection

Technical specifications

Article number	6FB1111-1AT20-1AT1 SIDOOR AT12
General information	
Product brand name	SIDOOR
Product designation	Door controller
Product version	AT12
Manufacturer's article no. of the usable motor	6FB1103-0AT10-5MA0, 6FB1103-0AT11-5MA0
Supply voltage	
Type of power supply	230 V AC
Supply voltage (AC)	230 V
Line frequency	
• permissible range, lower limit	50 Hz
• permissible range, upper limit	60 Hz
Input current	
Current consumption, max.	10 A
I ² t, min.	30 A ² ·s
Operational current of fuse protection at input, min.	6 A
Operational current of fuse protection at input, max.	10 A

Article number	6FB1111-1AT20-1AT1 SIDOOR AT12
Power	
Active power input	80 W
Active power input, max.	160 W
Active power input (standby mode)	3 W
Digital inputs	
Control inputs isolated	Yes
Control inputs p-switching	Yes
Input voltage	
• per DC input, min.	10 V; Observe polarity !
• per DC input, max.	28 V; Observe polarity !
Input current	
• per DC input, min.	6 mA
• per DC input, max.	18 mA

Products for specific requirements

Automatic door controls
for elevators

Controllers > SIDOOR AT12 elevator door drive

Technical specifications (continued)

Article number	6FB1111-1AT20-1AT1 SIDOOR AT12
Digital outputs	
short-circuit proof	Yes
Overload-proof	Yes
Remark	Ensure correct polarity! CAUTION: Do not supply with external voltage!
Output voltage	
• Output voltage (DC)	24 V
Output current	
• For output (24 V DC), max.	120 mA
Relay outputs	
Switching capacity of contacts	
- at 30 V DC, min.	0.01 A
- at 30 V DC, max.	0.5 A
Mechanical data	
Opening width of door, min.	0.3 m
Opening width of door, max.	2.4 m
Weight of door, max.	120 kg
Operating cycle frequency of door, max.	180 1/h
Counterforce, max.	40 N
Kinetic energy, max.	15 J
Counterweight	
• with SIDOOR M2 geared motor, max.	4 kg

Article number	6FB1111-1AT20-1AT1 SIDOOR AT12
Interfaces	
Interfaces/bus type	CANopen, CiA standard 301, profile 417
Number of bus nodes	32
Isolation	
Overvoltage category	2
Degree and class of protection	
IP degree of protection	IP20
Standards, approvals, certificates	
Certificate of suitability according to EN 81	Yes
CE mark	Yes
UL approval	No
EAC (formerly Gost-R)	Yes
TÜV Inspectorate approval	Yes
TÜV prototype tested	Yes
Standard for EMC	EN 12015 / EN 12016
Standard for safety	EN 60950-1 / EN 81-20
Ambient conditions	
Ambient temperature during operation	
• min.	0 °C
• max.	50 °C
Ambient temperature during storage/transportation	
• Storage, min.	-20 °C
• Storage, max.	85 °C
Dimensions	
Width	260 mm
Height	45 mm
Depth	105 mm

Ordering data

Article No.

SIDOOR AT12 elevator door drive	6FB1111-1AT20-1AT1
Controller with integrated switch-mode power supply	

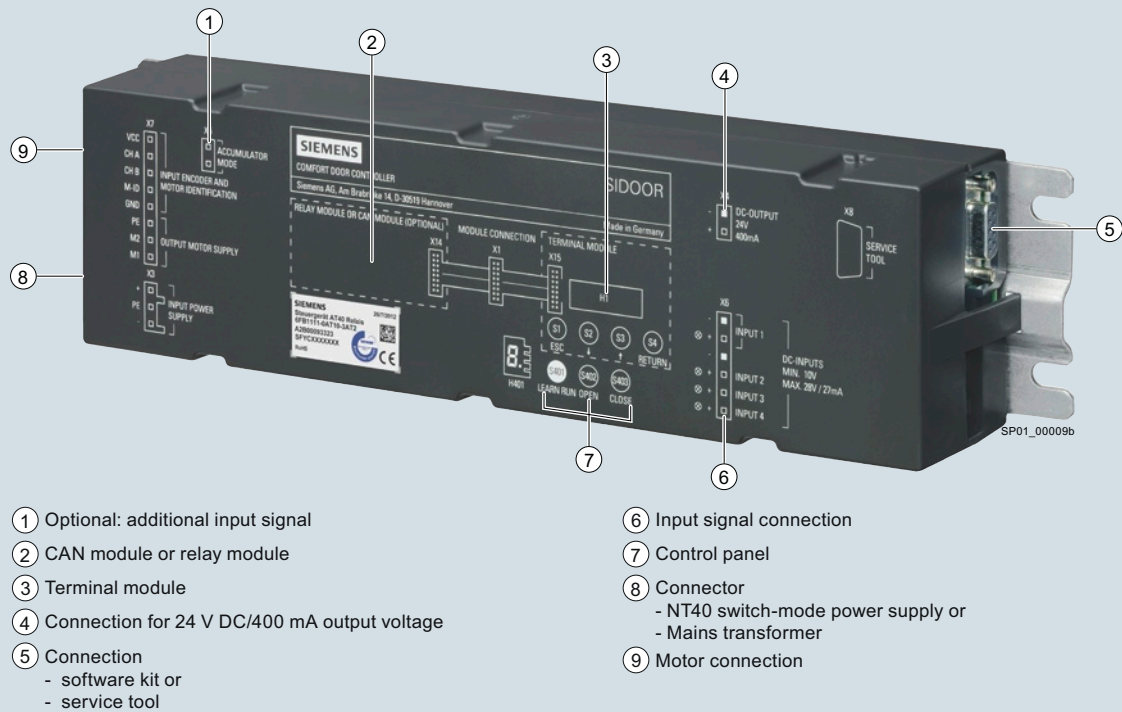
Overview

- | | |
|---|--|
| <ul style="list-style-type: none"> ① Optional: additional input signal ② CAN module or relay module ③ Terminal module ④ Connection for 24 V DC/400 mA output voltage ⑤ Connection <ul style="list-style-type: none"> - software kit or - service tool | <ul style="list-style-type: none"> ⑥ Input signal connection ⑦ Control panel ⑧ Connector <ul style="list-style-type: none"> - NT40 switch-mode power supply or - Mains transformer ⑨ Motor connection |
|---|--|

SIDOOR AT40 elevator door drive (relay module version)

SIDOOR AT40 – SIDOOR enables the quick, easy and versatile installation, configuration and operation of a wide range of elevator door systems.

- Version:
 - Relay module
 - CAN module
- For dynamic door weights up to 600 kg
- Automatic door weight detection
- 4 to 8 kg maximum counterweight (depending on motor version)
- Operating temperature -20 to +50 °C
- Flexible motor management (four different motor types), automatic detection
- Opening width 0.3 to 5 m
- Auxiliary power output 24 V DC ± 15 %; 0.4 A (short-circuit-proof)
- Output stage short-circuit-proof
- Supports power-optimized operation in the elevator cabin
- Vandal-proof
- IP54 degree of protection for 180 to 600 kg motor versions, gear unit IP40 (SIDOOR M5: entirely IP54)
- The current operating states are indicated via a 7-segment display directly in the elevator door drive or externally using the software kit or service tool, [see "Additional units"](#).

Products for specific requirements

Automatic door controls
for elevators

Controllers > SIDOOR AT40 elevator door drive

Technical specifications

Article number	6FB1111-0AT10-3AT2	6FB1111-1AT10-3AT3
	SIDOOR AT40 RELAY	SIDOOR AT40 CAN
General information		
Product brand name	SIDOOR	
Product designation	Door controller	
Product version	AT40 relay	AT40 CAN
Manufacturer's article no. of the usable motor	6FB1103-0AT10-5MA0, 6FB1103-0AT11-5MA0, 6FB1103-0AT10-4MB0, 6FB1103-0AT11-4MB0, 6FB1103-0AT10-3MC0, 6FB1103-0AT11-3MC0, 6FB1103-0AT10-3MD0, 6FB1103-0AT11-3MD0	
Manufacturer's article no. of the usable power supply unit	6FB1112-0AT20-2TR0, 6FB1112-0AT20-3PS0	
Supply voltage		
Type of power supply	via SIDOOR mains transformer / NT40	
Input current		
Current consumption, max.	10 A	
I ² t, min.	30 A ² ·s	
Power		
Active power input	80 W	
Active power input, max.	540 W	
Active power input (standby mode)	5 W	6 W
Digital inputs		
Control inputs isolated	Yes	
Control inputs p-switching	Yes	
Input voltage		
• per DC input, min.	10 V; Observe polarity !	
• per DC input, max.	28 V; Observe polarity !	
Input current		
• per DC input, min.	9 mA	
• per DC input, max.	27 mA	

Article number	6FB1111-0AT10-3AT2	6FB1111-1AT10-3AT3
	SIDOOR AT40 RELAY	SIDOOR AT40 CAN
Digital outputs		
short-circuit proof	Yes	
Remark	Ensure correct polarity! CAUTION: Do not supply with external voltage!	
Output voltage		
• Output voltage (DC)	24 V	
Output current		
• For output (24 V DC), max.	400 mA	
Relay outputs		
Switching capacity of contacts		
- at 30 V DC, min.	0.01 A	
- at 30 V DC, max.	1 A	0.5 A
- at 50 V DC, min.	0.01 A; 50 V DC switching voltage not released for NFPA-relevant countries	
- at 50 V DC, max.	1 A; 50 V DC switching voltage not released for NFPA-relevant countries	
- at 230 V AC, min.	0.01 A	
- at 230 V AC, max.	1 A	
Mechanical data		
Opening width of door, min.	0.3 m	
Opening width of door, max.	5 m	
Weight of door, max.	600 kg	
Operating cycle frequency of door, max.	180 1/h	
Counterforce, max.	80 N	
Kinetic energy, max.	100 J	
Counterweight		
• with SIDOOR M2 geared motor, max.	4 kg	
• with SIDOOR M3 geared motor, max.	6 kg	
• with SIDOOR M4 geared motor, max.	8 kg	
• with SIDOOR M5 geared motor, max.	8 kg	

Technical specifications (continued)

Article number	6FB1111-0AT10-3AT2	6FB1111-1AT10-3AT3
	SIDOOR AT40 RELAY	SIDOOR AT40 CAN
Interfaces		
Interfaces/bus type	without	CANopen, CiA standard 301, profile 417
Number of bus nodes		32
Isolation		
Overvoltage category	2	
Degree and class of protection		
IP degree of protection	IP20	
Standards, approvals, certificates		
Certificate of suitability according to EN 81	Yes	
CE mark	Yes	
UL approval	No	
EAC (formerly Gost-R)	Yes	
TÜV Inspectorate approval	Yes	
TÜV prototype tested	Yes	
Standard for EMC	EN 12015 / EN 12016	
Standard for safety	EN 60950-1 / EN 81-20	

Article number	6FB1111-0AT10-3AT2	6FB1111-1AT10-3AT3
	SIDOOR AT40 RELAY	SIDOOR AT40 CAN
Ambient conditions		
Ambient temperature during operation		
• min.	-20 °C	
• max.	50 °C	
Ambient temperature during storage/transportation		
• Storage, min.	-40 °C	
• Storage, max.	50 °C	
Air pressure acc. to IEC 60068-2-13		
• Installation altitude above sea level, max.	2 000 m	
Relative humidity		
• No condensation, min.	10 %	
• No condensation, max.	93 %	
Dimensions		
Width	320 mm	
Height	60 mm	
Depth	80 mm	

Ordering data

Article No.

SIDOOR AT40 elevator door drive

Controller with relay module

6FB1111-0AT10-3AT2

Controller with CAN module

6FB1111-1AT10-3AT3

Products for specific requirements

Automatic door controls
for elevators

Controllers > SIDOOR ATD400V elevator door drive

Overview

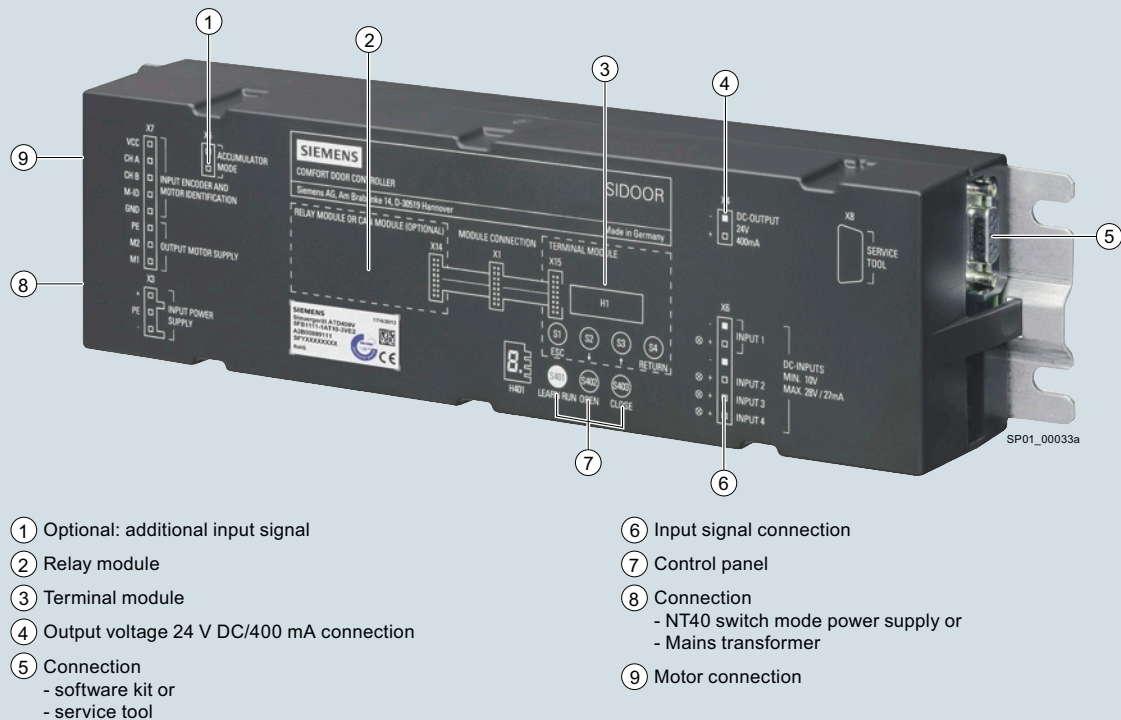

SIDOOR ATD400V elevator door drive

SIDOOR ATD400V – The SIDOOR ATD400V elevator door drive enables the quick, easy and versatile installation, configuration and operation of vertical elevator door systems, such as rising doors and roller shutters.

- Relay module design
- For dynamic door weights up to 400 kg
- Automatic door weight detection
- Operating temperature -20 to +50 °C
- Opening width 0.3 to 4 m

- Auxiliary power output 24 V DC \pm 15 %; 0.4 A (short-circuit-proof)
- Output stage short-circuit-proof
- Vandal-proof
- Degree of protection:
 - motor IP54
 - gear unit IP40

The current operating states are indicated via a 7-segment display directly in the elevator door drive or externally using the software kit or service tool, see "Additional units".

Technical specifications

Article number	6FB1111-1AT10-3VE2 SIDOOR ATD400V RELAY
General information	
Product brand name	SIDOOR
Product designation	Door controller
Product version	ATD400V relay
Optional product expansion	Mains transformer (6FB1112-0AT20-2TR0)
Manufacturer's article no. of the usable motor	6FB1103-0AT10-3MCO, 6FB1103-0AT11-3MCO
Manufacturer's article no. of the usable power supply unit	6FB1112-0AT20-2TR0, 6FB1112-0AT20-3PS0
Supply voltage	
Type of power supply	via SIDOOR mains transformer / NT40
Input current	
Current consumption, max.	10 A
I ² t, min.	30 A ² ·s

Article number	6FB1111-1AT10-3VE2 SIDOOR ATD400V RELAY
Power	
Active power input	80 W
Active power input, max.	540 W
Active power input (standby mode)	5 W
Digital inputs	
Control inputs isolated	Yes
Control inputs p-switching	Yes
Input voltage	
• per DC input, min.	10 V; Observe polarity !
• per DC input, max.	28 V; Observe polarity !
Input current	
• per DC input, min.	9 mA
• per DC input, max.	27 mA

Products for specific requirements

Automatic door controls for elevators

Controllers > SIDOOR ATD400V elevator door drive

Technical specifications (continued)

Article number	6FB1111-1AT10-3VE2 SIDOOR ATD400V RELAY
Digital outputs	
short-circuit proof	Yes
Remark	Ensure correct polarity! CAUTION: Do not supply with external voltage!
Output voltage	
• Output voltage (DC)	24 V
Output current	
• For output (24 V DC), max.	400 mA
Relay outputs	
Switching capacity of contacts	
- at 50 V DC, min.	0.01 A; 50 V DC switching voltage not released for NFPA-relevant countries
- at 50 V DC, max.	1 A; 50 V DC switching voltage not released for NFPA-relevant countries
- at 230 V AC, min.	0.01 A
- at 230 V AC, max.	1 A
Mechanical data	
Opening width of door, min.	0.3 m
Opening width of door, max.	4 m
Weight of door, max.	400 kg
Operating cycle frequency of door, max.	180 1/h
Counterforce, max.	80 N
Kinetic energy, max.	100 J
Counterweight	
• with SIDOOR M4 geared motor, max.	8 kg
Interfaces	
Interfaces/bus type	without
Degree and class of protection	
IP degree of protection	IP20

Article number	6FB1111-1AT10-3VE2 SIDOOR ATD400V RELAY
Standards, approvals, certificates	
Certificate of suitability according to EN 81	Yes
CE mark	Yes
UL approval	No
EAC (formerly Gost-R)	Yes
TÜV Inspectorate approval	Yes
TÜV prototype tested	Yes
Standard for EMC	EN 12015 / EN 12016
Standard for safety	EN 60950-1 / EN 81-20
Ambient conditions	
Ambient temperature during operation	
• min.	-20 °C
• max.	50 °C
Ambient temperature during storage/transportation	
• Storage, min.	-40 °C
• Storage, max.	50 °C
Air pressure acc. to IEC 60068-2-13	
• Installation altitude above sea level, max.	2 000 m
Relative humidity	
• No condensation, min.	10 %
• No condensation, max.	93 %
Dimensions	
Width	320 mm
Height	60 mm
Depth	80 mm

Ordering data

Article No.

SIDOOR ATD400V elevator door drive

Controller with relay module for
rising gates and roller shutters,
for vertical door systems

6FB1111-1AT10-3VE2

Products for specific requirements

Automatic door controls
for elevators

Controllers > SIDOOR ATE500E elevator door drive

Overview

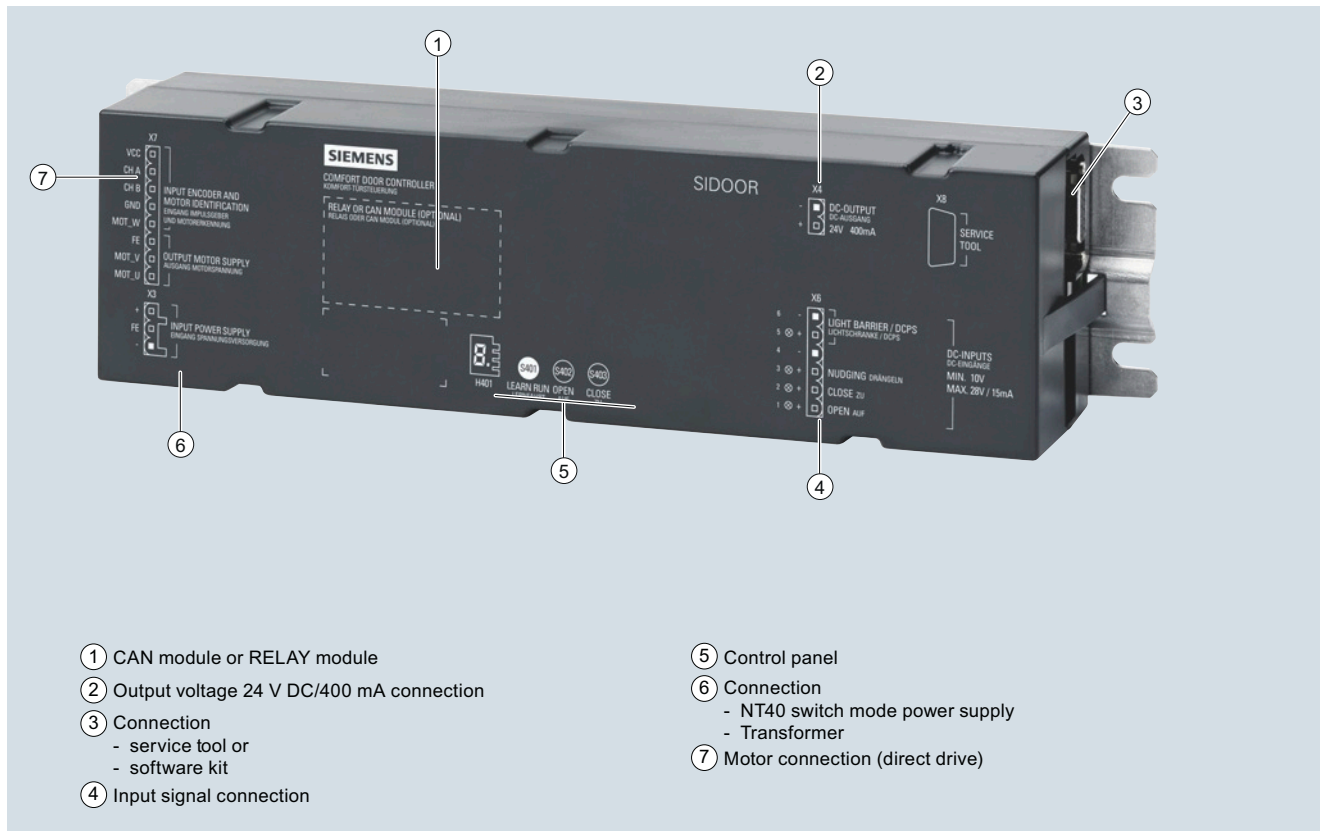

SIDOOR ATE500E elevator door drive

The SIDOOR ATE500E elevator door drive enables the quick, easy and versatile installation, configuration and operation of EC technology gearless elevator door systems.

- Design:
 - Relay module
 - CAN module
- For dynamic door weights up to 280 kg
- High control performance und optimized drive characteristic transitions
- Automatic door weight detection (single-button commissioning)
- 6 kg maximum counterweight of the coupled floor door

- Operating temperature -25 to +50 °C without restrictions
- Automatic identification of the connected motor
- Opening width 0.3 to 5 m
- Auxiliary voltage output 24 V DC \pm 15 %; 0.4 A (short-circuit-proof)
- Output stage short-circuit-proof
- Optimized energy consumption during cabin operation (DCPS)
- Vandal-proof
- IP20 degree of protection
- The current operating states are indicated via a 7-segment display directly in the elevator door drive or externally using the software kit or service tool, see [Additional units](#).

Technical specifications

Article number	6FB1211-5AT10-7AT2 SIDOOR ATE500E RELAY	6FB1211-1AT10-7AT3 SIDOOR ATE500E CAN
General information		
Product brand name	SIDOOR	
Product designation	Door controller	
Product version	ATE500E Relais	ATE500E CAN
Optional product expansion	Mains transformer (6FB1112-0AT20-2TR0), NT40 (6FB1112-0AT20-3PS0)	
Manufacturer's article no. of the usable motor	6FB1203-0AT12-7DA0	
Manufacturer's article no. of the usable power supply unit	6FB1112-0AT20-2TR0, 6FB1112-0AT20-3PS0	
Installation type/mounting		
Installation and mounting instructions	No direct sunlight, requirements specific to the end application must be observed. NFPA industry environment: Installation outside a control cabinet only horizontal. NFPA elevator environment: Must be installed in a fire protection enclosure	
Supply voltage		
Type of power supply	via SIDOOR mains transformer / NT40 or via DC	
Rated value (DC)	36 V; with MED280: At 24 V DC max. door speed of 500 mm/s; at 28.8 V DC max. door speed of 800 mm/s	
permissible range, lower limit (DC)	19.2 V	
permissible range, upper limit (DC)	38 V	
Input current		
I _{pt} , min.	30 A ² ·s	
Power		
Active power input	85 W	
Active power input, max.	540 W	
Active power input (standby mode)	5 W	6 W
Digital inputs		
Control inputs isolated	Yes	
Control inputs p-switching	Yes	
Fuse protection at DC end (recommendation)	Use of a circuit breaker in the supply path according to 60898-1, 8A, C-characteristic type SIEMENS: 5SY4108-7 or 5SY4108-7KK11	
Input voltage		
• per DC input, min.	10 V; Observe polarity !	
• per DC input, max.	28 V; Observe polarity !	
Input current		
• per DC input, min.	3 mA	
• per DC input, max.	15 mA	

Article number	6FB1211-5AT10-7AT2 SIDOOR ATE500E RELAY	6FB1211-1AT10-7AT3 SIDOOR ATE500E CAN
Digital outputs		
short-circuit proof	Yes	
Overload-proof	Yes	
Remark	Ensure correct polarity! CAUTION: Do not supply with external voltage!	
Output voltage		
• Output voltage (DC)	24 V	
Output current		
• For output (24 V DC), max.	400 mA	
Relay outputs		
Switching capacity of contacts		
- at 30 V DC, min.	0.01 A	
- at 30 V DC, max.	1 A	0.5 A
- at 50 V DC, min.	0.01 A; 50 V DC switching voltage not released for NFPA-relevant countries	
- at 50 V DC, max.	1 A; 50 V DC switching voltage not released for NFPA-relevant countries	
- at 230 V AC, min.	0.01 A	
- at 230 V AC, max.	1 A	
Mechanical data		
Opening width of door, min.	0.3 m	
Opening width of door, max.	5 m	
Weight of door, max.	280 kg	
Operating cycle frequency of door, max.	180 1/h	
Kinetic energy, max.	75 J	
Counterweight		
• with SIDOOR MED280 direct drive, max.	6 kg	
Interfaces		
Interfaces/bus type	without	CANopen, CiA standard 301, profile 417
Number of bus nodes	32	
Isolation		
Overvoltage category	2	
Degree and class of protection		
IP degree of protection	IP20	

Products for specific requirements

Automatic door controls
for elevators

Controllers > SIDOOR ATE500E elevator door drive

Technical specifications (continued)

Article number	6FB1211-5AT10-7AT2	6FB1211-1AT10-7AT3
	SIDOOR ATE500E RELAY	SIDOOR ATE500E CAN
Standards, approvals, certificates		
Certificate of suitability according to EN 81	Yes	
CE mark	Yes	
UL approval	Yes	
EAC (formerly Gost-R)	Yes	
TÜV Inspectorate approval	Yes	
TÜV prototype tested	Yes	
Standard for EMC	EN 12015 / EN 12016 / EN 61000-6-2 / EN 61000-6-4 / EN 61326-3-1	
Standard for safety	EN 60335-1 / EN 60950-1 / EN 81-20 / UL61010-1 / UL61010-2-201 / EN ISO 13849-1 Cat. 2 PL d / IEC 62061: SIL2	
Ambient conditions		
Ambient temperature during operation		
• min.	-25 °C	
• max.	50 °C	
• Remark	Bolt the controller onto a metal mounting surface so that thermal conductivity is ensured	

Article number	6FB1211-5AT10-7AT2	6FB1211-1AT10-7AT3
	SIDOOR ATE500E RELAY	SIDOOR ATE500E CAN
Ambient temperature during storage/transportation		
• Storage, min.	-40 °C	
• Storage, max.	85 °C	
Air pressure acc. to IEC 60068-2-13		
• Installation altitude above sea level, max.	2 000 m	
Relative humidity		
• No condensation, min.	10 %	
• No condensation, max.	93 %	
Mechanics/material		
Service life		
• Mean time between failures (MTBF)	19 y	
Dimensions		
Width	320 mm	
Height	60 mm	
Depth	80 mm	

Ordering data

Article No.

SIDOOR ATE500E elevator door drive

Controller with relay module
Controller with CAN module

6FB1211-5AT10-7AT2
6FB1211-1AT10-7AT3

Overview



The SIDOOR Transformer power supply is a standard power supply unit operated with 220-240 V AC, 50/60 Hz, from the SIDOOR product range. It can be used for all controllers without an integrated power supply unit. The SIDOOR AT12 elevator door drive has an integrated power supply unit, for example.

Technical specifications

Article number	6FB1112-0AT20-2TR0 SIDOOR TRANSFORMER
General information	
Product brand name	SIDOOR
Product designation	Power transformer
Product version	Transformer
Supply voltage	
relative symmetrical tolerance of the supply voltage	15 %
Mains filter	
• present	Yes
Input current	
Current consumption, max.	2.2 A
Operational current of fuse protection at input, min.	6 A
Operational current of fuse protection at input, max.	10 A
Output voltage	
Rated value (DC)	unsmoothed
RMS value (pulsating DC voltage at full load)	17.3 V
RMS value (pulsating DC voltage at 20 mA)	23 V
Output current	
Rated value, max.	15.9 A
Degree and class of protection	
IP degree of protection	IP54
Standards, approvals, certificates	
Standard for EMC	EMC Directive 2004/108/EC, EN 12015, EN 12016, EN 61000-6-2, EN 61000-6-3

Article number	6FB1112-0AT20-2TR0 SIDOOR TRANSFORMER
Ambient conditions	
Ambient temperature during operation	
• min.	-20 °C
• max.	55 °C
• Remark	No direct exposure to the sun
Ambient temperature during storage/transportation	
• Storage, min.	-20 °C
• Storage, max.	70 °C
• Transportation, min.	-40 °C
• Transportation, max.	70 °C
Air pressure acc. to IEC 60068-2-13	
• Installation altitude above sea level, max.	2 000 m
Cables	
Cable length	
• Input side	2 m
• Output side	1.5 m
Connection method	
Design of electrical connection at input	SCHUKO connector DIN 49.441, CEE7/VII
Design of electrical connection at output	WAGO 721-103/026
Dimensions	
Height	65 mm
Diameter	126 mm

Ordering data

Article No.

SIDOOR Transformer power supply	6FB1112-0AT20-2TR0
---------------------------------	---------------------------

Products for specific requirements

Automatic door controls
for elevators

Power supplies > Switched-mode power supply

Overview

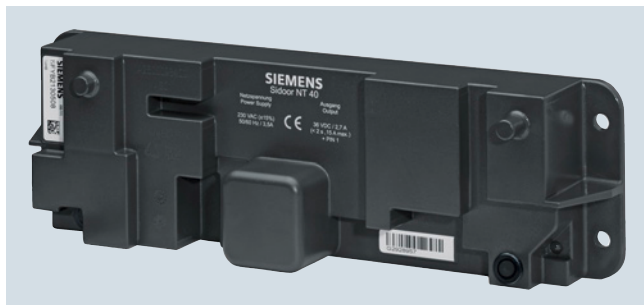

The SIDOOR NT40 switched-mode power supply is operated with 230 V AC ($\pm 15\%$), 50/60 Hz, to power the following SIDOOR door controllers:

- SIDOOR AT40 and SIDOOR ATD400V elevator door drives
- SIDOOR ATD400K cold room gate drives
- SIDOOR ATD4xxW machine tool door drives

It is especially suitable for door systems with high door weights.

On the output side, the power supply unit delivers a voltage of 36 V DC ($\pm 3\%$) SELV at a rated output power of < 100 W.

In order to enable fast acceleration/deceleration of the doors by the controller, the device can briefly (< 2 s) deliver a current of 15 A (corresponds to a short-time power output of 540 W).

Technical specifications

Article number	6FB1112-0AT20-3PS0 SIDOOR NT40
General information	
Product brand name	SIDOOR
Product designation	Switched-mode power supply
Product version	NT40
Installation type/mounting	
Mounting type	Four 5 mm screws
Supply voltage	
relative symmetrical tolerance of the supply voltage	15 %
Input current	
Current consumption for 2 s, max.	3.5 A
Operational current of fuse protection at input, min.	6 A
Operational current of fuse protection at input, max.	10 A
Tripping characteristic class of fuse protection at input	B
Output voltage	
Rated value (DC)	36 V; SELV
Relative symmetrical tolerance of the output voltage	3 %
Output current	
Rated value, min.	0 A
Rated value, max.	2.5 A
Temporary overload current (for 2 s maximum)	15 A
Power	
Active apparent power, max.	650 V·A
Emitted active power, max.	100 W
Emitted active power (restricted to 2 s)	540 W
Efficiency at 230 V AC (with 100 W emitted active power)	90 %
Isolation	
Overvoltage category	2

Article number	6FB1112-0AT20-3PS0 SIDOOR NT40
Degree and class of protection	
IP degree of protection	IP54
Equipment protection class	I
Standards, approvals, certificates	
Standard for EMC	EMC Directive 2004/108/EC, EN 12015, EN 12016
Standard for safety	EN 60950-1:2006
Ambient conditions	
Ambient temperature during operation	
• min.	-20 °C
• max.	55 °C
• Remark	No direct exposure to the sun
Ambient temperature during storage/transportation	
• Storage, min.	-20 °C
• Storage, max.	70 °C
• Transportation, min.	-40 °C
• Transportation, max.	70 °C
Air pressure acc. to IEC 60068-2-13	
• Installation altitude above sea level, max.	2 000 m
Relative humidity	
• No condensation, min.	10 %
• No condensation, max.	93 %
Cables	
Cable length	
• Input side	2 m
• Output side	1.5 m
Connection method	
Design of electrical connection at input	SCHUKO connector DIN 49.441, CEE7/VII
Design of electrical connection at output	WAGO 721-103/026
Dimensions	
Width	270 mm
Height	55 mm
Depth	80 mm

Ordering data

Article No.

SIDOOR NT40 switched-mode power supply

6FB1112-0AT20-3PS0

Overview SIDOOR software kit**SIDOOR software kit**

The scope of delivery of the SIDOOR software kit includes an installation CD.

Note:

Some firmware updates are offered as free downloads in the Siemens Industry Online Support. For information on the availability and acquisition of more firmware, please contact Technical Support.

The following functionalities are included on the CD:

SIDOOR User Software	The component that enables the door control system to be configured, parameters to be assigned, and analyzed.
Siemens HCS12 Firmware Loader	This component is used to update the operating software of the door controller.
SIDOOR USB to UART Bridge Driver	This driver is essential for operation of the USB adapter.

Ordering data**Article No.**

SIDOOR software kit	6FB1105-0AT01-6SW0
----------------------------	---------------------------

Overview SIDOOR service tool

The service tool can be used to input run commands, change run parameters and read out learned parameters, door states, input/output signals and service data.

The service tool is connected to the various controllers by the respective cable.

- SIDOOR AT12, SIDOOR AT40 and SIDOOR ATD400V elevator door drives
- SIDOOR ATD400K Cold Room Gate Drive, SIDOOR ATD400W and SIDOOR ATD410W machine tool door drives
- SIDOOR ATD400S and SIDOOR ATE250S platform screen door drives

You do not need to open the cover of the controller to do this.

Note:

If the service tool is in the "Quick adjustment" or "Total adjustment" menu, the run commands of the controller are blocked via the command inputs.

Ordering data**Article No.**

SIDOOR service tool
Hand-held terminal for parameter assignment of controllers

6FB1105-0AT01-6ST0

Products for specific requirements

Automatic door controls
for elevators

Geared motors

Overview

SIDOOR geared motors are a combination of gear unit, motor and sensor. They are easy to connect to the controller via the interface provided and are automatically detected during commissioning.

The maintenance-free, variable speed drive unit comprises a DC motor with non-self-locking gearing.

The geared motors must be selected according to the dynamic door weight. Two different versions are available for each of the SIDOOR M2 to SIDOOR M5 geared motors:

- SIDOOR M2 geared motors (max. door weight 120 kg)
 - SIDOOR M2 L (pinion left) 6FB1103-0AT10-5MA0
 - SIDOOR M2 R (pinion right) 6FB1103-0AT11-5MA0
- SIDOOR M3 geared motors (max. door weight 180 kg)
 - SIDOOR M3 L (pinion left) 6FB1103-0AT10-4MB0
 - SIDOOR M3 R (pinion right) 6FB1103-0AT11-4MB0
- SIDOOR M4 geared motors (max. door weight 400 kg)
 - SIDOOR M4 L (pinion left) 6FB1103-0AT10-3MC0
 - SIDOOR M4 R (pinion right) 6FB1103-0AT11-3MC0
- SIDOOR M5 geared motors (max. door weight 600 kg)
 - SIDOOR M5 L (pinion left) 6FB1103-0AT10-3MD0
 - SIDOOR M5 R (pinion right) 6FB1103-0AT11-3MD0

The gear outlet direction is defined as left or right when viewing the gear unit from the front.



Geared motors:
SIDOOR M2 L 6FB1103-0AT10-5MA0 (version with pinion left),
SIDOOR M3 L 6FB1103-0AT10-4MB0 (version with pinion left),
SIDOOR M4 L 6FB1103-0AT10-3MC0 (version with pinion left),
SIDOOR M5 L 6FB1103-0AT10-3MD0 (version with pinion left)
(Images are shown in the order from bottom to top)

Technical specifications

Article number	6FB1103-0AT10-5MA0	6FB1103-0AT11-5MA0	6FB1103-0AT10-4MB0	6FB1103-0AT11-4MB0	6FB1103-0AT10-3MC0	6FB1103-0AT11-3MC0	6FB1103-0AT10-3MD0	6FB1103-0AT11-3MD0
	SIDOOR M2 L	SIDOOR M2 R	SIDOOR M3 L	SIDOOR M3 R	SIDOOR M4 L	SIDOOR M4 R	SIDOOR M5 L	SIDOOR M5 R
General information								
Product brand name	SIDOOR							
Product designation	Motor for door control							
Product version	M2 L	M2 R	M3 L	M3 R	M4 L	M4 R	M5 L	M5 R
Supply voltage								
Supply voltage (DC)	24 V		30 V					
Input current								
Operational current (rated value)	1.8 A		4 A				7.5 A	
Power								
Active power input	43 W		120 W				225 W	
Mechanical data								
Torque of the rotary operating mechanism (rated value)	1.05 N·m		3 N·m				6.8 N·m	
Speed, max.	0.5 m/s		0.65 m/s		0.75 m/s		0.5 m/s	
Gear ratio	15							
Number of pulses per revolution, max.	100							
Weight of door, max.	120 kg		180 kg		400 kg		600 kg	
Degree and class of protection								
IP degree of protection								
• of the motor	IP20		IP54				IP54	
• of the gear unit	IP20		IP40				IP54	

Technical specifications (continued)

Article number	6FB1103-0AT10-5MA0 SIDOOR M2 L	6FB1103-0AT11-5MA0 SIDOOR M2 R	6FB1103-0AT10-4MB0 SIDOOR M3 L	6FB1103-0AT11-4MB0 SIDOOR M3 R	6FB1103-0AT10-3MC0 SIDOOR M4 L	6FB1103-0AT11-3MC0 SIDOOR M4 R	6FB1103-0AT10-3MD0 SIDOOR M5 L	6FB1103-0AT11-3MD0 SIDOOR M5 R
Ambient conditions								
Ambient temperature during operation								
• min.	-20 °C							
• max.	50 °C							
Ambient temperature during storage/transportation								
• Storage, min.	-40 °C							
• Storage, max.	85 °C							
Dimensions								
Height of motor	90 mm		98 mm		115 mm		124 mm	
Length of motor	207 mm		236 mm		275 mm		344 mm	
Diameter of motor	48 mm		63 mm				80 mm	
Width of gear unit, including drive pinion	90 mm		85 mm		105 mm		111 mm	

Ordering data

	Article No.		Article No.
SIDOOR M2 geared motors		SIDOOR M4 geared motors	
M2 L	6FB1103-0AT10-5MA0	M4 L	6FB1103-0AT10-3MC0
M2 R	6FB1103-0AT11-5MA0	M4 R	6FB1103-0AT11-3MC0
SIDOOR M3 geared motors		SIDOOR M5 geared motors	
M3 L	6FB1103-0AT10-4MB0	M5 L	6FB1103-0AT10-3MD0
M3 R	6FB1103-0AT11-4MB0	M5 R	6FB1103-0AT11-3MD0

Products for specific requirements

Automatic door controls
for elevators

Direct drives

Overview



SIDOOR MED280 direct drive

SIDOOR direct drives are a combination of motor and sensor. They are easy to connect to the controller via the interface provided and are automatically detected during commissioning.

The maintenance-free drive unit consists of a gearless, speed-controlled, electronically commutated motor with non-self-locking gearing.

Direct drives are designed for certain maximum dynamic door weights and can control both drive directions.

- SIDOOR MED280 direct drive for dynamic door weights up to 280 kg (6FB1203-0AT12-7DA0)

Technical specifications

Article number	6FB1203-0AT12-7DA0 SIDOOR MED280
General information	
Product brand name	SIDOOR
Product designation	Motor for door control
Product version	MED280
Supply voltage	
Supply voltage (DC)	24 V
Input current	
Operational current (rated value)	9.7 A
Power	
Active power input	233 W
Mechanical data	
Torque of the rotary operating mechanism (rated value)	4.7 N·m
Speed, max.	0.8 m/s
Number of pulses per revolution, max.	1 024
Weight of door, max.	280 kg
Degree and class of protection	
IP degree of protection	
• of the motor	IP54
Ambient conditions	
Ambient temperature during operation	
• min.	-25 °C
• max.	70 °C
Ambient temperature during storage/transportation	
• Storage, min.	-40 °C
• Storage, max.	85 °C
Dimensions	
Width of motor	160 mm
Height of motor	140 mm
Length of motor	56 mm
• including drive pinion	91 mm

Ordering data

Article No.

SIDOOR MED280 direct drive	6FB1203-0AT12-7DA0
Motor for door control	

Overview***A range of accessories is available for SIDOOR elevator door drive systems with geared motors:***

This is necessary to ensure low-noise operation of the door by the controller. The geared motors can be optimally integrated into the respective door drive system.

Rubber-metal anti-vibration mounts for geared motors

To ensure low-noise door operation, SIDOOR geared motors are integrated in the door system using rubber-metal anti-vibration mounts.

- Rubber-metal anti-vibration mount 6FB1104-0AT02-0AD0 for geared motors with a door weight of less than 300 kg
- Rubber-metal anti-vibration mount 6FB1104-0AT01-0AD0 for geared motors with a door weight of 300 kg or more



Rubber-metal anti-vibration mount 6FB1104-0AT02-0AD0

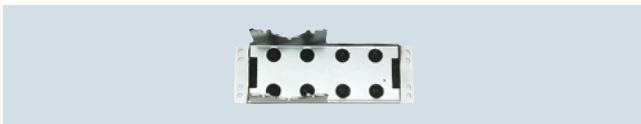

Rubber-metal anti-vibration mount 6FB1104-0AT01-0AD0

Mounting brackets

Two different mounting brackets are available with elongated holes:

- Mounting bracket 6FB1104-0AT01-0AS0 for the geared motors for flexible accommodation of the rubber-bonded metal
- Mounting bracket 6FB1104-0AT02-0AS0 for the deflector unit. This enables the toothed belt to be set to the required belt tension.



Mounting bracket 6FB1104-0AT01-0AS0 for mounting the geared motor



Mounting bracket 6FB1104-0AT02-0AS0 for the deflector unit

Door clutch holder

The door clutch holder serves to connect the respective door leaf by means of a toothed belt while also functioning as a toothed-belt lock. One door clutch holder per door leaf is required. The toothed-belt lock can accommodate both open ends of the toothed belt.

A door clutch holder is available for each toothed belt width:

- Width 12 mm: 6FB1104-0AT01-0CP0
- Width 14 mm: 6FB1104-0AT02-0CP0



Door clutch holder 6FB1104-0AT01-0CP0 (packing size = 1 unit)

Deflector unit

The deflector unit 6FB1104-0AT03-0AS0 contains an embedded belt pulley which can be mounted on the door system.

The STS toothed belt is redirected via this deflector unit.

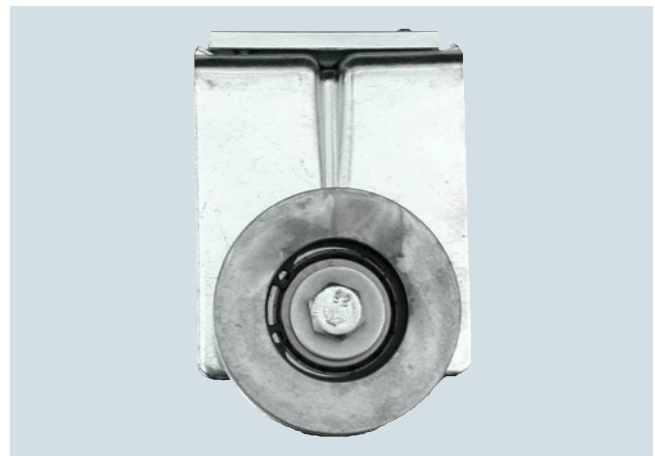

Deflector unit 6FB1104-0AT03-0AS0

Products for specific requirements

Automatic door controls
for elevators

Accessories

Overview (continued)

STS toothed belt

The door system is moved between the end positions of the door using the STS toothed belts. Two different toothed belt lengths can be ordered for each toothed belt width.

Toothed belt width 12 mm:

- Length 4 m: 6FB1104-0AT01-0AB0
- Length 45 m: 6FB1104-0AT02-0AB0

Toothed belt width 14 mm:

- Length 4 m: 6FB1104-0AT03-0AB0
- Length 55 m: 6FB1104-0AT04-0AB0

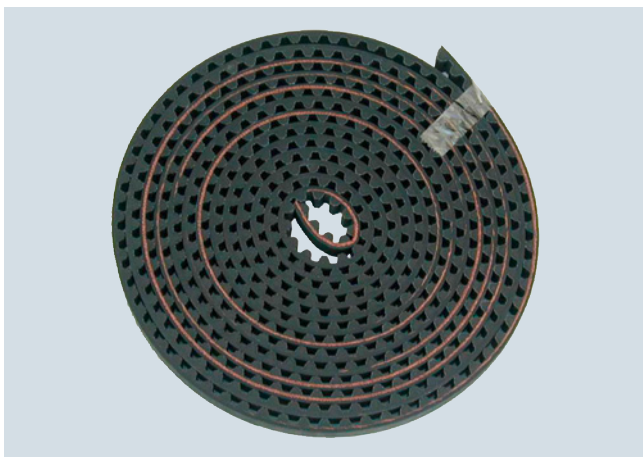

Toothed belt 6FB1104-0AT01-0AB0, length 4 m

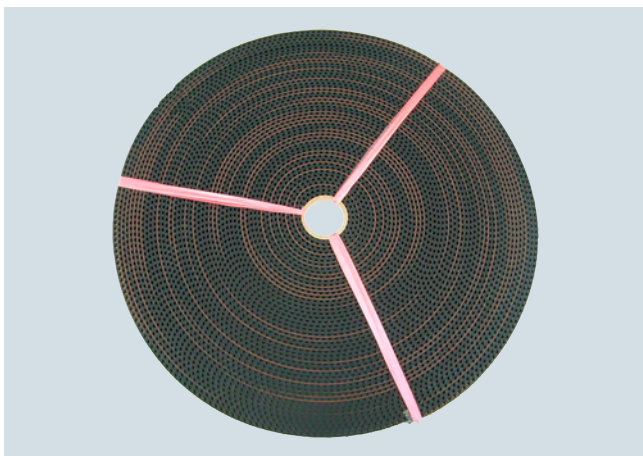

Toothed belt 6FB1104-0AT02-0AB0, length 45 m

A range of accessories is available for SIDOOR elevator door systems with EC technology:

Motor holder 6FB1104-0AT03-0AD0 for accommodation of the SIDOOR MED280 direct drive.

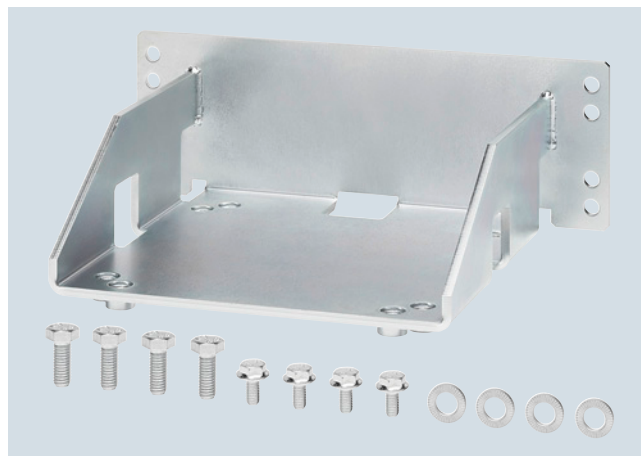

Mounting bracket:

- For mounting the SIDOOR motor holder 6FB1104-0AT01-0AS0



- With tensioning device for mounting the deflector unit and setting the toothed belt to the required tension (large) 6FB1104-0AT05-0AS4



SIDOOR mounting bracket, large

- With tensioning device for mounting the deflector unit and setting the toothed belt to the required tension (small) 6FB1104-0AT05-0AS5



SIDOOR mounting bracket, small

Overview (continued)Door clutch holder

- For attaching both ends of the toothed belt and connecting the respective door panel to the toothed belt, width 20 mm 6FB1104-0AT05-0AS1



SIDOOR door clutch holder

Deflector unit:

For attaching the SIDOOR toothed belt and fixing to the door 6FB1104-0AT07-0AS0



SIDOOR deflector unit

Toothed belt STD

As a connection between the door system and the end positions of the door

Toothed belt width 20 mm. Length 4 m 6FB1104-0AT05-0AB0

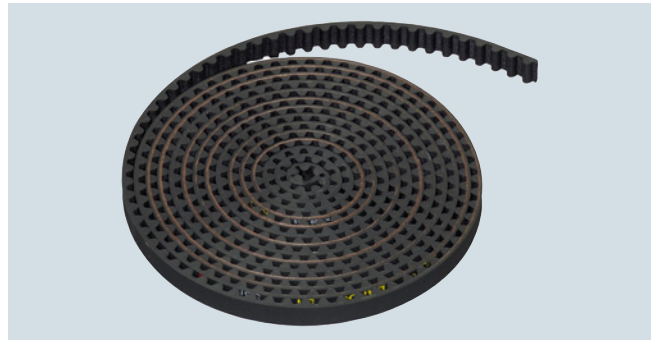

SIDOOR toothed belt, small

Toothed belt width 20 mm. Length 45 m 6FB1104-0AT06-0AB1



SIDOOR toothed belt, large

Products for specific requirements

Automatic door controls
for elevators

Accessories

Ordering data	Article No.	Ordering data	Article No.
Elevator door systems with EC technology		Elevator door systems with geared motors	
Motor holder for SIDOOR MED280 direct drive	6FB1104-0AT03-0AD0	Rubber-metal anti-vibration mounts for geared motors	
Mounting bracket for mounting the motor holder	6FB1104-0AT01-0AS0	<ul style="list-style-type: none"> SIDOOR rubber-metal anti-vibration mount for geared motors for door weights up to 300 kg 	6FB1104-0AT02-0AD0
Mounting bracket with tensioning device for mounting the deflector unit		<ul style="list-style-type: none"> SIDOOR rubber-metal anti-vibration mount for geared motors for door weights from 300 kg 	6FB1104-0AT01-0AD0
<ul style="list-style-type: none"> Large Small 	6FB1104-0AT05-0AS4 6FB1104-0AT05-0AS5	Mounting bracket	
SIDOOR door clutch holder	6FB1104-0AT05-0AS1	<ul style="list-style-type: none"> SIDOOR mounting bracket for geared motor 	6FB1104-0AT01-0AS0
For toothed belt, width 20 mm		<ul style="list-style-type: none"> SIDOOR mounting bracket with tensioning device for deflector pulley 	6FB1104-0AT02-0AS0
SIDOOR deflector unit	6FB1104-0AT07-0AS0	SIDOOR door clutch holder	
SIDOOR STD toothed belt		<ul style="list-style-type: none"> For toothed belt, width 12 mm For toothed belt, width 14 mm 	6FB1104-0AT01-0CP0 6FB1104-0AT02-0CP0
Width 20 mm	6FB1104-0AT05-0AB0 6FB1104-0AT06-0AB1	SIDOOR deflector unit	6FB1104-0AT03-0AS0
<ul style="list-style-type: none"> 4 m 55 m 		SIDOOR STS toothed belt	
		Width 12 mm	
		<ul style="list-style-type: none"> 4 m 45 m 	6FB1104-0AT01-0AB0 6FB1104-0AT02-0AB0
		SIDOOR STS toothed belt	
		Width 14 mm	
		<ul style="list-style-type: none"> 4 m 55 m 	6FB1104-0AT03-0AB0 6FB1104-0AT04-0AB0

Overview

The machine tool door drive consists of a controller and a maintenance-free drive unit, the geared motors.

Controllers are electronic controllers connected to the power supply via an external power supply unit (SIDOOR NT40, SIDOOR Transformer). They are generally connected to the higher-level controller via digital or fieldbus interfaces, and can be configured via a user interface.

Three controllers are available for selection for machine tool doors:

- SIDOOR ATD401W, connected to the higher-level controller via the digital interface (relay module), up to 600 kg door weight
- SIDOOR ATD410W, connected to the higher-level controller via a USS bus interface (USS module), up to 600 kg door weight
- SIDOOR ATD420W, connected to the higher-level controller via a PROFIBUS interface (PROFIBUS module), up to 600 kg door weight

The safe functions – force limitation, energy limitation and end position detection – fulfill the requirements according to EN ISO 13849-1:2008 for Category 2 and Performance Level d. The drives are suitable for power-operated guards according to EN 953:1997+A1:2009 Section 5.2.5.2 "Actuating forces".

Geared motors form the maintenance-free drive unit in the door drive. The geared motors are DC motors with non-self-locking gearing, and are speed-controlled. The set force and speed limits are not exceeded.

Operation of the named door drives does not require limit switches. The door width and the "OPEN"/"CLOSE" positions are determined automatically.

The power is transmitted by a toothed belt. The toothed belt passes over a deflector pulley and can be fitted with 2 door clutch holders. This enables it to drive both one-sided and centrally opening doors. The accessories are not included in the scope of delivery, see "Accessories".

Products for specific requirements

Automatic door controls
for industry applications

Controllers > SIDOOR ATD400K cold room gate drive

Overview

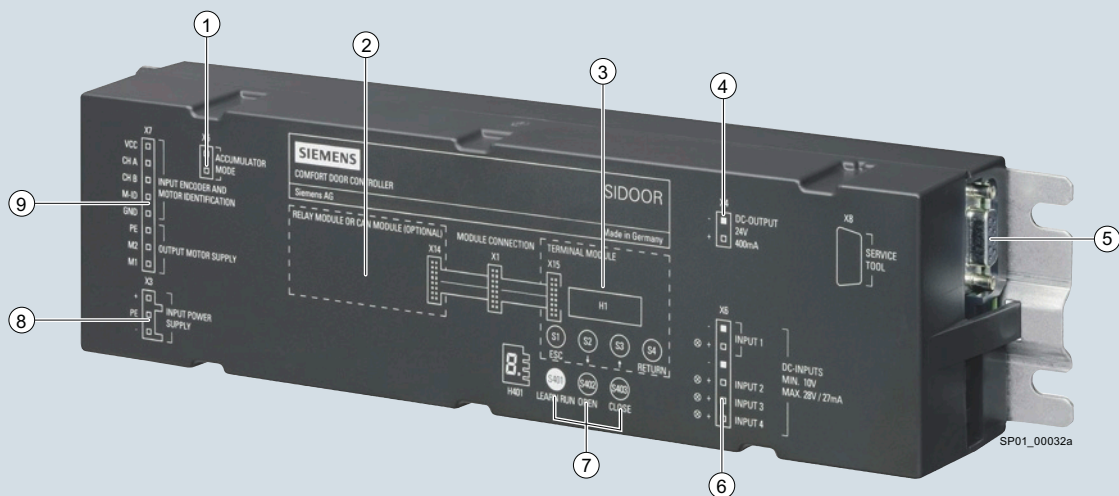

- | | |
|---|---|
| ① Emergency power module connection | ⑥ Input signal connection |
| ② Relay module, USS module or PROFIBUS module (according to requirements) | ⑦ Control panel |
| ③ Terminal module | ⑧ Input voltage connection 16.8 to 36 V DC for connection of power supply |
| ④ Output voltage 24 V DC/400 mA connection | ⑨ Motor connection |
| ⑤ Connection
- software kit or
- service tool | |

SIDOOR ATD400K cold room gate drive

The SIDOOR ATD400K door controller enables the optimally controlled movement of horizontally opening cold room gates with dynamic weights of up to 400 kg.

Both drive variants offer a range of assignment options for the digital inputs here:

- Relay module design
 - SIDOOR ATD400K RELAY LB for connection of a light barrier
 - SIDOOR ATD400K RELAY RC for connection of a gate interlock
- For dynamic door weights up to 400 kg
- Operator terminal/seven-segment display
- 4 digital inputs, 3 relay contacts
- Automatic door weight detection
- Operating temperature from -20 to +50 °C
- Flexible motor management with automatic motor recognition
- Opening width 0.3 to 4 m
- Closing speeds of up to 0.5 m/s

- Emergency power input via special emergency power module 24 V DC \pm 15 %
- Auxiliary power output 24 V DC \pm 15 %; 0.4 A (short-circuit-proof)
- Output stage short-circuit-proof
- Vandal-proof
- IP54 degree of protection for 180 to 400 kg motor versions, gear unit IP40
- The "cord-operated switch" function is supported. Pulling the cord opens the door to an adjustable width.
- Pulse operation: The door control signal remains active until a new command arrives.
- Hold-open time can be parameterized
- A higher force can be set for the first 10 cm of the opening movement (boosting the door)

Technical specifications

Article number	6FB1141-1AT10-3KU2	6FB1141-1AT11-3KU2
	SIDOOR ATD400K RELAY LB	SIDOOR ATD400K RELAY RC
General information		
Product brand name	SIDOOR	
Product designation	Door controller	
Product version	ATD400K relay LS	ATD400K relay RC
Optional product expansion	Mains transformer (6FB1112-0AT20-2TR0)	
Manufacturer's article no. of the usable motor	6FB1103-0AT10-4MB0, 6FB1103-0AT11-4MB0, 6FB1103-0AT10-3MCO, 6FB1103-0AT11-3MCO	
Manufacturer's article no. of the usable power supply unit	6FB1112-0AT20-2TR0	
Supply voltage		
Type of power supply	via SIDOOR mains transformer	
Input current		
Current consumption, max.	10 A	
I ² t, min.	30 A ² ·s	
Power		
Active power input	80 W	
Active power input, max.	540 W	
Active power input (standby mode)	5 W	
Digital inputs		
Control inputs isolated	Yes	
Control inputs p-switching	Yes	
Input voltage		
• per DC input, min.	10 V; Observe polarity !	
• per DC input, max.	28 V; Observe polarity !	
Input current		
• per DC input, min.	9 mA	
• per DC input, max.	27 mA	
Digital outputs		
short-circuit proof	Yes	
Remark	Ensure correct polarity! CAUTION: Do not supply with external voltage!	
Output voltage		
• Output voltage (DC)	24 V	
Output current		
• For output (24 V DC), max.	400 mA	
Relay outputs		
Switching capacity of contacts		
- at 50 V DC, min.	0.01 A; 50 V DC switching voltage not released for NFPA-relevant countries	
- at 50 V DC, max.	1 A; 50 V DC switching voltage not released for NFPA-relevant countries	
- at 230 V AC, min.	0.01 A	
- at 230 V AC, max.	1 A	

Article number	6FB1141-1AT10-3KU2	6FB1141-1AT11-3KU2
	SIDOOR ATD400K RELAY LB	SIDOOR ATD400K RELAY RC
Mechanical data		
Opening width of door, min.	0.3 m	
Opening width of door, max.	4 m	
Weight of door, max.	400 kg	
Operating cycle frequency of door, max.	180 1/h	
Interfaces		
Interfaces/bus type	without	
Isolation		
Overvoltage category	2	
Degree and class of protection		
IP degree of protection	IP20	
Standards, approvals, certificates		
CE mark	Yes	
UL approval	No	
TÜV Inspectorate approval	Yes	
TÜV prototype tested	Yes	
Requirement class for protective devices according to EN 12453, section 5.5.1	Protection level C	
Standard for EMC	EN 61000-6-2 / EN 61000-6-3	
Standard for safety	EN ISO 13849-1 Cat. 2 PL d	
Ambient conditions		
Ambient temperature during operation		
• min.	-20 °C	
• max.	50 °C	
Ambient temperature during storage/transportation		
• Storage, min.	-40 °C	
• Storage, max.	50 °C	
Relative humidity		
• No condensation, min.	10 %	
• No condensation, max.	93 %	
Dimensions		
Width	320 mm	
Height	60 mm	
Depth	80 mm	

Ordering data

Article No.

SIDOOR ATD400K

- SIDOOR ATD400K RELAY LB with light barrier function support
- SIDOOR ATD400K RELAY RC with gate interlock function support

6FB1141-1AT10-3KU2

6FB1141-1AT11-3KU2

Products for specific requirements

Automatic door controls
for industry applications

Controllers > SIDOOR ATD401W machine tool door drive

Overview

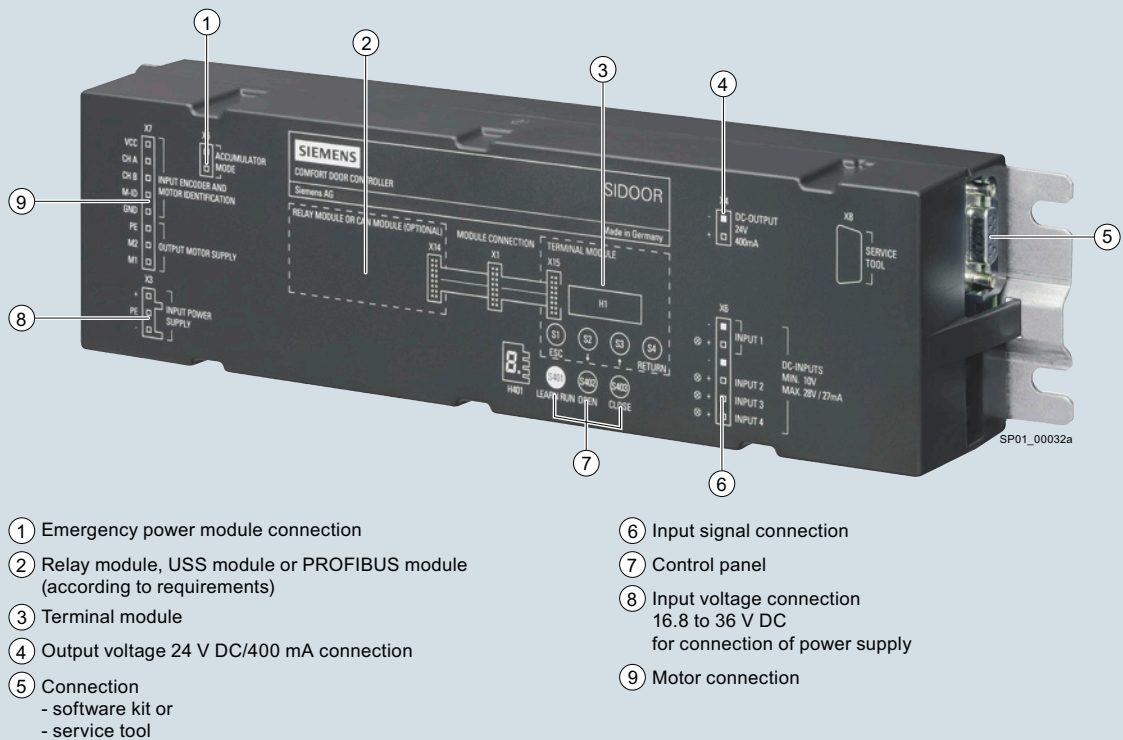

SIDOOR ATD401W machine tool door drive

The SIDOOR ATD401W machine tool door drive enables the quick, easy and versatile installation, configuration and operation of a wide range of industrial door drive systems.

- Relay module design
- For dynamic door weights up to 600 kg
- Automatic determination of the door weight and friction during the learn run
- Digital inputs, for example for direct connection of a light barrier as type 2 ESPE (electro-sensitive protective equipment) according to EN 61496-1

- 3 relay outputs for position feedback and reversing feedback
- Operating temperature -20 to +50 °C
- Flexible motor management, automatic recognition of the geared motor
- Opening width 0.3 to 5 m
- Auxiliary voltage output 24 V DC $\pm 15\%$; 0.4 A (short-circuit-proof)
- Output stage for the motor control is short-circuit-proof
- Indicates the current operating states on a 7-segment display directly on the controller or using the software kit or service tool

Technical specifications

Article number	6FB1141-1AT11-3WE2 SIDOOR ATD401W
General information	
Product brand name	SIDOOR
Product designation	Door controller
Product version	ATD401W
Optional product expansion	Mains transformer (6FB1112-0AT20-2TR0), NT40 (6FB1112-0AT20-3PS0), DIN rail holder (6FB1144-0AT00-3AS0)
Manufacturer's article no. of the usable motor	6FB1103-0AT11-3MCO, 6FB1103-0AT10-4MB0, 6FB1103-0AT10-3MCO, 6FB1103-0AT11-3MCO, 6FB1103-0AT14-3MCO, 6FB1103-0AT13-4MB0, 6FB1103-0AT14-4MB0, 6FB1103-0AT14-3MCO, 6FB1103-0AT13-3MCO, 6FB1103-0AT11-3MDO, 6FB1103-0AT10-3MDO
Manufacturer's article no. of the usable power supply unit	6FB1112-0AT20-2TR0, 6FB1112-0AT20-3PS0, 6EP3446-8SB10-0AY0
Installation type/mounting	
Installation and mounting instructions	No direct sunlight, requirements specific to the end application must be observed. NFPA industry environment: Installation outside a control cabinet only horizontal
Supply voltage	
Type of power supply	via SIDOOR mains transformer / NT40 / SITOP PSU8200 13 A, 6 V or via DC
Rated value (DC)	36 V
permissible range, lower limit (DC)	19.2 V
permissible range, upper limit (DC)	38 V
Input current	
I ² t, min.	30 A ² ·s
Power	
Active power input	145 W
Active power input, max.	540 W
Active power input (standby mode)	5 W
Digital inputs	
Control inputs isolated	Yes
Control inputs p-switching	Yes
Fuse protection at DC end (recommendation)	Use of a circuit breaker in the supply path according to 60898-1, 8A, C-characteristic type SIEMENS: 5SY4108-7 or 5SY4108-7KK11
Input voltage	
• per DC input, min.	10 V; Observe polarity !
• per DC input, max.	28 V; Observe polarity !
Input current	
• per DC input, min.	9 mA
• per DC input, max.	27 mA
Digital outputs	
short-circuit proof	Yes
Overload-proof	Yes
Remark	Ensure correct polarity! CAUTION: Do not supply with external voltage!

Article number	6FB1141-1AT11-3WE2 SIDOOR ATD401W
Output voltage	
• Output voltage (DC)	24 V
Output current	
• For output (24 V DC), max.	400 mA
Relay outputs	
Switching capacity of contacts	
- at 30 V DC, min.	0.01 A
- at 30 V DC, max.	1 A
Mechanical data	
Opening width of door, min.	0.3 m
Opening width of door, max.	5 m
Weight of door, max.	600 kg
Operating cycle frequency of door, max.	180 1/h
Counterforce, max.	75 N
Kinetic energy, max.	100 J
Interfaces	
Interfaces/bus type	without
Isolation	
Overvoltage category	2
Degree and class of protection	
IP degree of protection	IP20
Standards, approvals, certificates	
Certificate of suitability according to EN 81	No
CE mark	Yes
UL approval	Yes
EAC (formerly Gost-R)	Yes
TÜV Inspectorate approval	Yes
Standard for EMC	EN 61000-6-2 / EN 61000-6-4
Standard for safety	EN 60950-1 / UL61010-1 / UL61010-2-201 / EN ISO 13849-1 Cat. 2 PL d
Ambient conditions	
Ambient temperature during operation	
• min.	-20 °C
• max.	50 °C
Ambient temperature during storage/transportation	
• Storage, min.	-40 °C
• Storage, max.	70 °C
Air pressure acc. to IEC 60068-2-13	
• Installation altitude above sea level, max.	2 000 m
Relative humidity	
• No condensation, min.	10 %
• No condensation, max.	93 %
Dimensions	
Width	320 mm
Height	60 mm
Depth	80 mm

Ordering data

Article No.

SIDOOR ATD401W

6FB1141-1AT11-3WE2

Controller for machine tool doors,
relay module design

Products for specific requirements

Automatic door controls
for industry applications

Controllers > SIDOOR ATD410W machine tool door drive

Overview

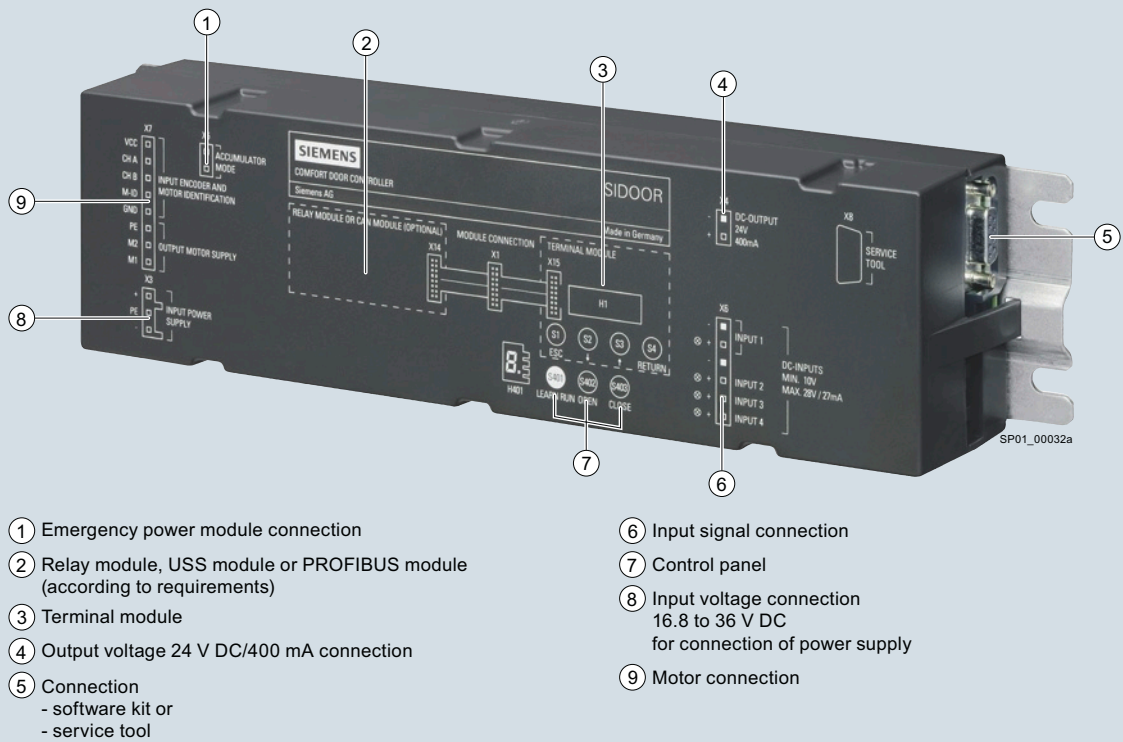

SIDOOR ATD410W machine tool door drive

The SIDOOR ATD410W machine tool door drive can be used to operate horizontal sliding doors. The drive system has been specifically designed for use in a very wide range of machine tools. The communication-capable ATD410W controller offers complete flexibility for integration with a machine tool via the USS protocol (universal serial interface protocol).

- For dynamic door weights up to 600 kg
- USS module design: USS communications interface for connection to ET 200-type higher-level controllers, SIMATIC S7-1200, SIMATIC S7-1500 and SIMATIC S7-300 via USS interface
- 5 freely parameterizable digital inputs for signal acquisition, of which one input is optionally parameterizable for:
 - Connection of a light barrier as type 2 ESPE (electro-sensitive protective equipment) according to EN 61496-1
 - Connection of a pressure-sensitive edge according to ISO 13856-22, relay contacts for additional position signals

- Automatic determination of the door weight and friction during the learn run
- Operating temperature -20 to +50 °C
- Flexible motor management, i.e. automatic recognition of the geared motor
- Assisted drive (motor-assisted movement of the door)
- Impulse stop (door stopped automatically by applying light force)
- Impulse drive (automatic door movement by applying light force)
- Opening width 0.3 to 5 m
- Auxiliary voltage output 24 V DC \pm 15 %; 0.4 A (short-circuit-proof)
- Output stage for the motor control short-circuit-proof
- Displays the current operating states on a 7-segment display directly on the controller or with the software kit or service tool
- All door parameters can be assigned via the PROFdrive profile with the function block provided. For details, see the System Manual "SIDOOR AT40, ATD400V, ATD400K, ATD400W, ATD410W, ATD400S, ATE250S, ATD400T", <http://support.automation.siemens.com/WW/view/en/58531074>

Technical specifications

Article number	6FB1141-4AT10-3WE2 SIDOOR ATD410W
General information	
Product brand name	SIDOOR
Product designation	Door controller
Product version	ATD410W
Optional product expansion	Mains transformer (6FB1112-0AT20-2TR0), NT40 (6FB1112-0AT20-3PS0), DIN rail holder (6FB1144-0AT00-3AS0)
Manufacturer's article no. of the usable motor	6FB1103-0AT11-3MCO, 6FB1103-0AT10-4MB0, 6FB1103-0AT10-3MCO, 6FB1103-0AT11-3MCO, 6FB1103-0AT14-3MCO, 6FB1103-0AT13-4MB0, 6FB1103-0AT14-4MB0, 6FB1103-0AT14-3MCO, 6FB1103-0AT13-3MCO, 6FB1103-0AT11-3MDO, 6FB1103-0AT10-3MDO
Manufacturer's article no. of the usable power supply unit	6FB1112-0AT20-2TR0, 6FB1112-0AT20-3PS0, 6EP3446-8SB10-0AY0
Installation type/mounting	
Installation and mounting instructions	No direct sunlight, requirements specific to the end application must be observed. NFPA industry environment: Installation outside a control cabinet only horizontal
Supply voltage	
Type of power supply	via SIDOOR mains transformer / NT40 / SITOP PSU8200 13 A, 6 V or via DC
Rated value (DC)	36 V
permissible range, lower limit (DC)	19.2 V
permissible range, upper limit (DC)	38 V
Input current	
I^2t , min.	30 A ² ·s
Power	
Active power input	145 W
Active power input, max.	540 W
Active power input (standby mode)	5 W
Digital inputs	
Control inputs isolated	Yes
Control inputs p-switching	Yes
Fuse protection at DC end (recommendation)	Use of a circuit breaker in the supply path according to 60898-1, 8A, C-characteristic type SIEMENS: 5SY4108-7 or 5SY4108-7KK11
Input voltage	
• per DC input, min.	10 V; Observe polarity !
• per DC input, max.	28 V; Observe polarity !
Input current	
• per DC input, min.	9 mA
• per DC input, max.	27 mA

Article number	6FB1141-4AT10-3WE2 SIDOOR ATD410W
Digital outputs	
short-circuit proof	Yes
Overload-proof	Yes
Remark	Ensure correct polarity! CAUTION: Do not supply with external voltage!
Output voltage	
• Output voltage (DC)	24 V
Output current	
• For output (24 V DC), max.	400 mA
Relay outputs	
Switching capacity of contacts	
- at 30 V DC, min.	0.01 A
- at 30 V DC, max.	0.5 A
Mechanical data	
Opening width of door, min.	0.3 m
Opening width of door, max.	5 m
Weight of door, max.	600 kg
Operating cycle frequency of door, max.	180 1/h
Counterforce, max.	75 N
Kinetic energy, max.	100 J
Interfaces	
Interfaces/bus type	USS according to EIA 485, IEC 61800-7-200 Type 3
Number of bus nodes	32
Isolation	
Overvoltage category	2
Degree and class of protection	
IP degree of protection	IP20
Standards, approvals, certificates	
Certificate of suitability according to EN 81	No
CE mark	Yes
UL approval	No
EAC (formerly Gost-R)	Yes
TÜV Inspectorate approval	Yes
Standard for EMC	EN 61000-6-2 / EN 61000-6-4
Standard for safety	EN 60950-1 / EN ISO 13849-1 2008 Cat. 2 PL d

Products for specific requirements

Automatic door controls
for industry applications

Controllers > SIDOOR ATD410W machine tool door drive

Technical specifications (continued)

Article number	6FB1141-4AT10-3WE2 SIDOOR ATD410W
Ambient conditions	
Ambient temperature during operation	
• min.	-20 °C
• max.	50 °C
Ambient temperature during storage/transportation	
• Storage, min.	-40 °C
• Storage, max.	70 °C
Air pressure acc. to IEC 60068-2-13	
• Installation altitude above sea level, max.	2 000 m
Relative humidity	
• No condensation, min.	10 %
• No condensation, max.	93 %
Dimensions	
Width	320 mm
Height	60 mm
Depth	80 mm

Ordering data

SIDOOR ATD410W
Controller for machine tool doors,
with USS interface for connection to
higher-level controllers

Article No.

6FB1141-4AT10-3WE2

Overview

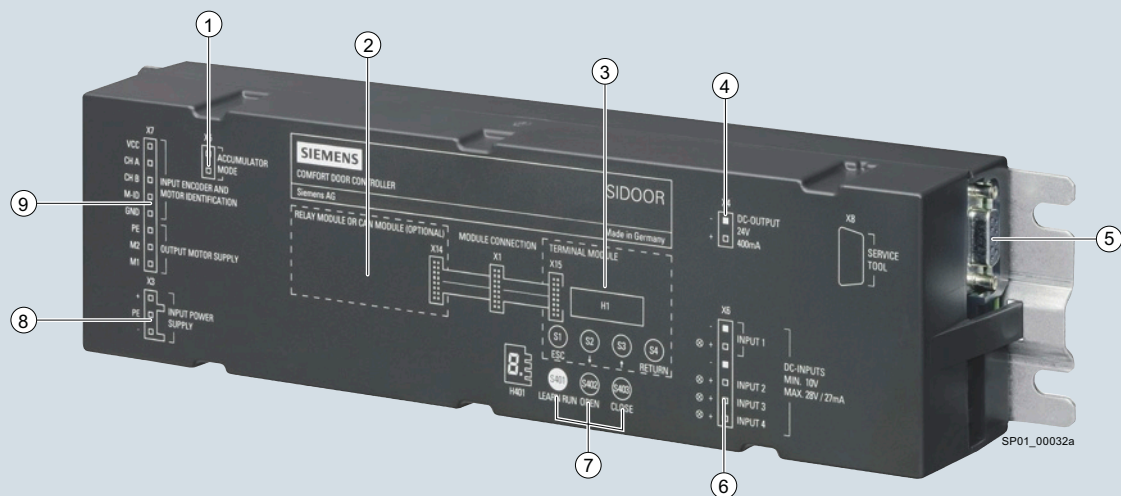

- | | |
|---|---|
| ① Emergency power module connection | ⑥ Input signal connection |
| ② Relay module, USS module or PROFIBUS module (according to requirements) | ⑦ Control panel |
| ③ Terminal module | ⑧ Input voltage connection
16.8 to 36 V DC
for connection of power supply |
| ④ Output voltage 24 V DC/400 mA connection | ⑨ Motor connection |
| ⑤ Connection
- software kit or
- service tool | |

SIDOOR ATD420W machine tool door drive

The SIDOOR ATD420W machine tool door drive can be used to operate horizontal sliding doors. The drive system has been specially designed for use in a very wide range of machine tools. The communication-capable ATD420W controller offers complete flexibility for integration with a machine tool.

- For dynamic door weights up to 600 kg
- 5 freely parameterizable digital inputs for signal acquisition, of which one input is optionally parameterizable for
 - Connection of a light barrier as type 2 ESPE (electro-sensitive protective equipment) according to EN 61496-1
 - Connection of a pressure-sensitive edge according to ISO 13856-2
- 2 relay contacts for additional position signals
- Automatic determination of the door weight and friction during the learn run
- Parameter assignment and analysis of the door parameters via PROFIdrive
- Operating temperature -20 to +50 °C

- Flexible motor management, i.e. automatic recognition of the geared motor
- Assisted drive (motor-assisted movement of the door)
- Impulse stop (door stopped automatically by applying light force)
- Impulse drive (automatic door movement after applying light force)
- Opening width 0.3 to 5 m
- Auxiliary power output 24 V DC $\pm 15\%$ and 0.4 A (short-circuit-proof)
- Output stage short-circuit-proof
- Displays the current operating states on a 7-segment display directly on the controller or with the software kit or service tool
- All door parameters can be assigned via the PROFIdrive profile with the function block provided. For details see the System Manual "SIDOOR AT40, ATD400V, ATD400K, ATD400W, ATD410W, ATD400S, ATE250S, ATD400T" <http://support.automation.siemens.com/WW/view/en/58531074>

Products for specific requirements

Automatic door controls
for industry applications

Controllers > SIDOOR ATD420W machine tool door drive

Technical specifications

Article number	6FB1141-2AT10-3WE2 SIDOOR ATD420W
General information	
Product brand name	SIDOOR
Product designation	Door controller
Product version	ATD420W
Optional product expansion	Mains transformer (6FB1112-0AT20-2TR0), NT40 (6FB1112-0AT20-3PS0), DIN rail holder (6FB1144-0AT00-3AS0)
Manufacturer's article no. of the usable motor	6FB1103-0AT11-3MC0, 6FB1103-0AT10-4MB0, 6FB1103-0AT10-3MC0, 6FB1103-0AT11-3MC0, 6FB1103-0AT14-3MC0, 6FB1103-0AT13-4MB0, 6FB1103-0AT14-4MB0, 6FB1103-0AT14-3MC0, 6FB1103-0AT13-3MC0, 6FB1103-0AT11-3MD0, 6FB1103-0AT10-3MD0
Manufacturer's article no. of the usable power supply unit	6FB1112-0AT20-2TR0, 6FB1112-0AT20-3PS0, 6EP3446-8SB10-0AY0
Installation type/mounting	
Installation and mounting instructions	No direct sunlight, requirements specific to the end application must be observed. NFPA industry environment: Installation outside a control cabinet only horizontal
Supply voltage	
Type of power supply	via SIDOOR mains transformer / NT40 / SITOP PSU8200 13 A, 6 V or via DC
Rated value (DC)	36 V
permissible range, lower limit (DC)	19.2 V
permissible range, upper limit (DC)	38 V
Input current	
I^2t , min.	30 A ² ·s
Power	
Active power input	145 W
Active power input, max.	540 W
Active power input (standby mode)	5 W

Article number	6FB1141-2AT10-3WE2 SIDOOR ATD420W
Digital inputs	
Control inputs isolated	Yes
Control inputs p-switching	Yes
Fuse protection at DC end (recommendation)	Use of a circuit breaker in the supply path according to 60898-1, 8A, C-characteristic type SIEMENS: 5SY4108-7 or 5SY4108-7KK11
Input voltage	
• per DC input, min.	10 V; Observe polarity !
• per DC input, max.	28 V; Observe polarity !
Input current	
• per DC input, min.	9 mA
• per DC input, max.	27 mA
Digital outputs	
short-circuit proof	Yes
Overload-proof	Yes
Remark	Ensure correct polarity! CAUTION: Do not supply with external voltage!
Output voltage	
• Output voltage (DC)	24 V
Output current	
• For output (24 V DC), max.	400 mA
Relay outputs	
Switching capacity of contacts	
- at 30 V DC, min.	0.01 A
- at 30 V DC, max.	0.5 A
Mechanical data	
Opening width of door, min.	0.3 m
Opening width of door, max.	5 m
Weight of door, max.	600 kg
Operating cycle frequency of door, max.	180 1/h
Counterforce, max.	75 N
Kinetic energy, max.	100 J
Interfaces	
Interfaces/bus type	PROFIBUS according to IEC 61784-3
Number of bus nodes	32
Isolation	
Overvoltage category	2
Degree and class of protection	
IP degree of protection	IP20

Technical specifications (continued)

Article number	6FB1141-2AT10-3WE2 SIDOOR ATD420W
Standards, approvals, certificates	
Certificate of suitability according to EN 81	No
CE mark	Yes
UL approval	Yes
EAC (formerly Gost-R)	Yes
TÜV Inspectorate approval	Yes
PNO certificate	Yes
Standard for EMC	EN 61000-6-2 / EN 61000-6-4
Standard for safety	EN 60950-1 / UL61010-1 / UL61010-2-201 / EN ISO 13849-1 Cat. 2 PL d
Ambient conditions	
Ambient temperature during operation	
• min.	-20 °C
• max.	50 °C
Ambient temperature during storage/transportation	
• Storage, min.	-40 °C
• Storage, max.	70 °C
Air pressure acc. to IEC 60068-2-13	
• Installation altitude above sea level, max.	2 000 m
Relative humidity	
• No condensation, min.	10 %
• No condensation, max.	93 %
Dimensions	
Width	320 mm
Height	60 mm
Depth	80 mm

Ordering data

SIDOOR ATD420W
Controller for machine tool doors,
integrated PROFIBUS interface

Article No.

6FB1141-2AT10-3WE2

Products for specific requirements

Automatic door controls
for industry applications

Controllers > SIDOOR ATD430W machine tool door drive

Overview

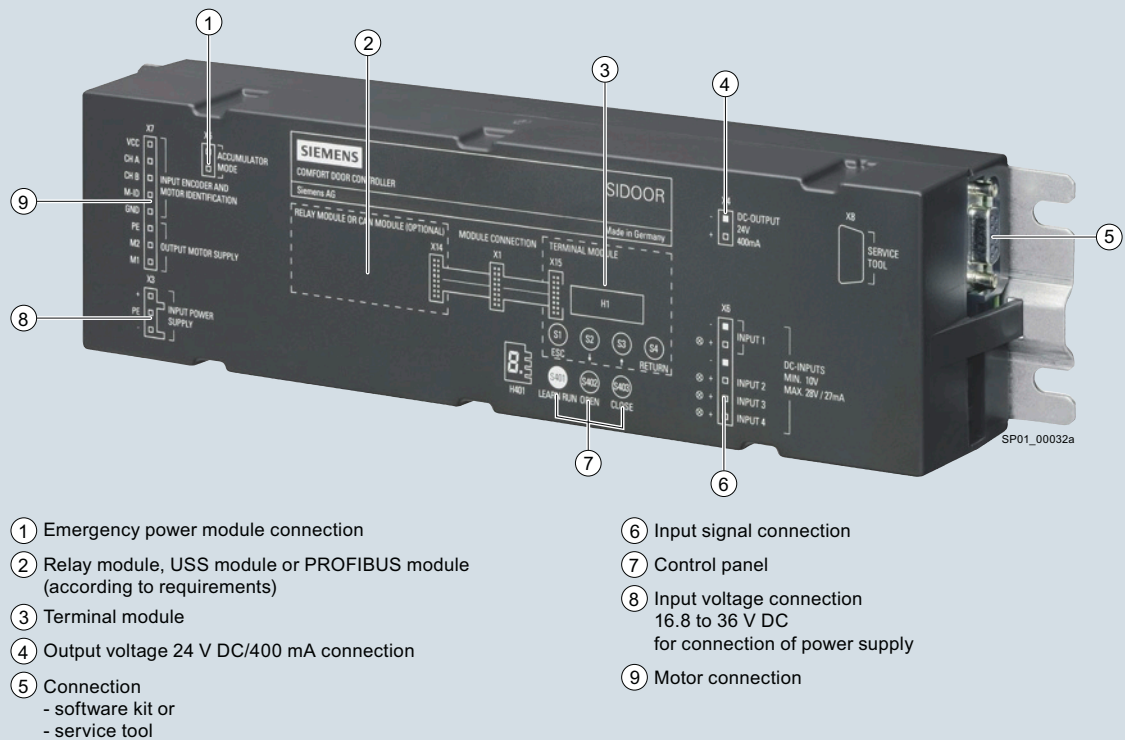

SIDOOR ATD430W machine tool door drive

The SIDOOR ATD430W machine tool door drive can be used to operate horizontal sliding doors. The drive system has been specially designed for use in a very wide range of machine tools. The communication-capable ATD430W controller offers complete flexibility for integration into a machine tool via PROFINET.

- For dynamic door weights up to 600 kg
- Integrated PROFINET interface (2 RJ45 ports)
- 5 freely parameterizable digital inputs for signal acquisition, of which one input is optionally parameterizable for:
 - Connecting a light barrier as type 2 ESPE (electro-sensitive protective equipment) according to EN 61496-1
 - Connecting a pressure-sensitive edge according to ISO 13856-22, relay contacts for additional position signals
- 2 relay contacts for additional position signals
- Automatic determination of the door weight and friction during the learn run
- Parameter assignment and analysis of the door parameters via PROFIdrive
- Operating temperature -20 to +50 °C

- Flexible motor management, i.e. automatic recognition of the geared motor
- Assisted drive (motor-assisted door movement)
- Impulse stop (door stopped automatically by applying light force)
- Impulse drive (automatic door movement after applying light force)
- Opening width 0.3 to 5 m
- Auxiliary power output 24 V DC $\pm 15\%$ and 0.4 A (short-circuit-proof)
- Output stage for the motor control is short-circuit-proof
- Indicates the current operating states on a 7-segment display directly on the controller or using the software kit or service tool
- All door parameters can be assigned via the PROFIdrive profile with the function block provided. For details, see System Manual "SIDOOR AT40, ATD400V, ATD400K, ATD4xxW, ATD400S, ATE250S, ADT400T", <http://support.automation.siemens.com/WW/view/en/58531074>

Technical specifications

Article number	6FB1141-3AT10-3WE2 SIDOOR ATD430W
General information	
Product brand name	SIDOOR
Product designation	Door controller
Product version	ATD430W
Optional product expansion	Mains transformer (6FB1112-0AT20-2TR0), NT40 (6FB1112-0AT20-3PS0), DIN rail holder (6FB1144-0AT00-3AS0)
Manufacturer's article no. of the usable motor	6FB1103-0AT11-3MC0, 6FB1103-0AT10-4MB0, 6FB1103-0AT10-3MC0, 6FB1103-0AT11-3MC0, 6FB1103-0AT14-3MC0, 6FB1103-0AT13-4MB0, 6FB1103-0AT14-4MB0, 6FB1103-0AT14-3MC0, 6FB1103-0AT13-3MC0, 6FB1103-0AT11-3MD0, 6FB1103-0AT10-3MD0
Manufacturer's article no. of the usable power supply unit	6FB1112-0AT20-2TR0, 6FB1112-0AT20-3PS0, 6EP3446-8SB10-0AY0
Installation type/mounting	
Installation and mounting instructions	No direct exposure to the sun
Supply voltage	
Type of power supply	via SIDOOR mains transformer / NT40 / SITOP PSU8200 13 A, 6 V or via DC
Rated value (DC)	36 V
permissible range, lower limit (DC)	19.2 V
permissible range, upper limit (DC)	38 V
Input current	
I ² t, min.	30 A ² ·s
Power	
Active power input	145 W
Active power input, max.	540 W
Active power input (standby mode)	5 W

Article number	6FB1141-3AT10-3WE2 SIDOOR ATD430W
Digital inputs	
Control inputs isolated	Yes
Control inputs p-switching	Yes
Fuse protection at DC end (recommendation)	Use of a circuit breaker in the supply path according to 60898-1, 8A, C-characteristic type SIEMENS: 5SY4108-7 or 5SY4108-7KK11
Input voltage	
• per DC input, min.	10 V; Observe polarity !
• per DC input, max.	28 V; Observe polarity !
Input current	
• per DC input, min.	9 mA
• per DC input, max.	27 mA
Digital outputs	
short-circuit proof	Yes
Overload-proof	Yes
Remark	Ensure correct polarity! CAUTION: Do not supply with external voltage!
Output voltage	
• Output voltage (DC)	24 V
Output current	
• For output (24 V DC), max.	400 mA
Relay outputs	
Switching capacity of contacts	
- at 30 V DC, min.	0.01 A
- at 30 V DC, max.	0.5 A
Mechanical data	
Opening width of door, min.	0.3 m
Opening width of door, max.	5 m
Weight of door, max.	600 kg
Operating cycle frequency of door, max.	180 1/h
Counterforce, max.	75 N
Kinetic energy, max.	100 J
Interfaces	
Interfaces/bus type	PROFINET IO according to Conformance Class C
Isolation	
Overvoltage category	2
Degree and class of protection	
IP degree of protection	IP20

Products for specific requirements

Automatic door controls
for industry applications

Controllers > SIDOOR ATD430W machine tool door drive

Technical specifications (continued)

Article number	6FB1141-3AT10-3WE2 SIDOOR ATD430W
Standards, approvals, certificates	
Certificate of suitability according to EN 81	No
CE mark	Yes
UL approval	Yes
TÜV Inspectorate approval	Yes
Standard for EMC	EN 61000-6-2 / EN 61000-6-4
Standard for safety	EN 60950-1 / UL61010-1 / UL61010-2-201 / EN ISO 13849-1 Cat. 2 PL d
Ambient conditions	
Ambient temperature during operation	
• min.	-20 °C
• max.	50 °C
• Remark	Screw control device thermally conductive onto a metallic mounting surface or standard rail mounting, otherwise the maximum operating temperature is only 40 °C
Ambient temperature during storage/transportation	
• Storage, min.	-40 °C
• Storage, max.	70 °C
Air pressure acc. to IEC 60068-2-13	
• Installation altitude above sea level, max.	2 000 m
Relative humidity	
• No condensation, min.	10 %
• No condensation, max.	93 %
Dimensions	
Width	320 mm
Height	60 mm
Depth	80 mm

Ordering data

SIDOOR ATD430W
Controller for machine tool doors,
integrated PROFINET interface
(2 RJ45 ports)

Article No.

6FB1141-3AT10-3WE2

Overview

The power supply units can be used for the various SIDOOR controllers:

SIDOOR Transformer power supply:

for masses of up to 400 kg and moderate performance.

- SIDOOR AT40, SIDOOR ATD400V and ATE500E elevator door drives
- SIDOOR ATD400K cold room gate drives
- SIDOOR ATD4xxW machine tool door drives
- SIDOOR ATE53xS platform screen door drives

SIDOOR NT40 switched-mode power supply:

for masses of up to 600 kg and maximum performance.

- SIDOOR AT40, SIDOOR ATD400V and ATE500E elevator door drives
- SIDOOR ATD4xxW machine tool door drives

SITOP PSU8200 3-phase stabilized power supply, 36 V DC/13 A:

for masses of up to 600 kg and maximum performance.

- SIDOOR ATD4xxW machine tool door drives

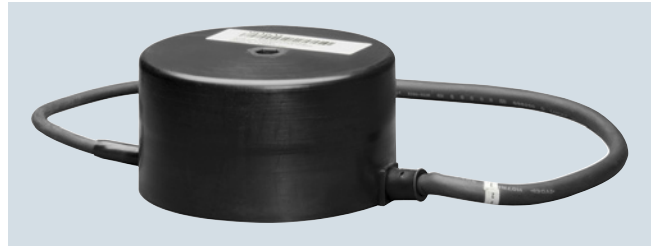
Overview Power transformer

The SIDOOR Transformer power supply is a standard power supply unit operated with 220-240 V AC, 50/60 Hz, from the SIDOOR product range. It can be used for all controllers without an integrated power supply unit. The SIDOOR AT12 elevator door drive has an integrated power supply unit, for example.

For more information, see page 13/21.

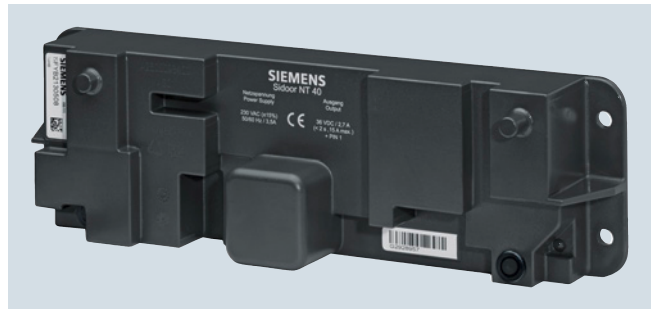
Overview Switched-mode power supply

The SIDOOR NT40 switched-mode power supply is operated with 230 V AC ($\pm 15\%$), 50/60 Hz, to power the following SIDOOR door controllers:

- SIDOOR AT40 and SIDOOR ATD400V elevator door drives
- SIDOOR ATD400K cold room gate drives
- SIDOOR ATD4xxW machine tool door drives

It is especially suitable for door systems with high door weights.

On the output side, the power supply unit delivers a voltage of 36 V DC ($\pm 3\%$) SELV at a rated output power of < 100 W.

In order to enable fast acceleration/deceleration of the doors by the controller, the device can briefly (< 2 s) deliver a current of 15 A (corresponds to a short-time power output of 540 W).

For more information, see page 13/22.

Products for specific requirements

Automatic door controls
for industry applications

Power supplies > SITOP PSU8200 3-phase, 36 V DC/13 A

Overview SITOP PSU8200 3-phase, 36 V DC/13 A



The 3-phase SITOP modular are technology power supplies for sophisticated solutions and offer maximum functionality for use in complex plants and machines. The wide-range input allows connection to almost any electrical power system worldwide and ensures a high degree of safety, even if there are large voltage fluctuations. The power boost provides up to three times the rated current for brief periods. In case of overload, you can choose between constant current with automatic restart or latching shutdown. The high degree of efficiency keeps energy consumption and heating in the control cabinet low, and the compact metal housing also saves space.

Main product highlights

- 36 V DC/13 A
- 3-phase AC input 400 to 500 volts
- Extremely slim design – no lateral installation clearances required
- Power boost with 3 times the rated current (for 25 ms) for tripping protective devices
- Extra power with 1.5 times the rated current (5 s/min) for brief functional overload
- Choice of constant current or latching shutdown short-circuit response
- Optional symmetrical load distribution for parallel operation
- Operating state on 3 LEDs
- Extremely high efficiency up to 94%
- Wide temperature range from -25 to +70 °C
- Comprehensive certifications, such as cULus, ATEX

Technical specifications

Article number	6EP3446-8SB10-0AY0
Product	SITOP PSU8200
Power supply, type	36 V/13 A
Input	
Input	3-phase AC
Rated voltage value $V_{in \text{ rated}}$	400 ... 500 V
Voltage range AC	320 ... 575 V
Wide-range input	Yes
Mains buffering at $I_{out \text{ rated}}$, min.	15 ms; at $V_{in} = 400 \text{ V}$
Rated line frequency 1	50 Hz
Rated line frequency 2	60 Hz
Rated line range	47 ... 63 Hz
Input current	
• at rated input voltage 400 V	1.2 A
• at rated input voltage 500 V	1 A
Switch-on current limiting (+25 °C), max.	16 A
I^2t , max.	0.8 A ² ·s
Built-in incoming fuse	none
Protection in the mains power input (IEC 898)	Required: 3-pole connected miniature circuit breaker 6 ... 16 A characteristic C or circuit breaker 3RV2011-1DA10 (setting 3 A) or 3RV2711-1DD10 (UL 489)
Output	
Output	Controlled, isolated DC voltage
Rated voltage $V_{out \text{ DC}}$	36 V
Total tolerance, static ±	3 %
Static mains compensation, approx.	0.1 %
Static load balancing, approx.	0.2 %
Residual ripple peak-peak, max.	100 mV
Spikes peak-peak, max. (bandwidth: 20 MHz)	200 mV
Adjustment range	36 ... 42 V
Product function Output voltage adjustable	Yes
Output voltage setting	via potentiometer; max. 480 W
Status display	Green LED for 36 V OK
Signaling	Relay contact (NO contact, rating 60 V DC/ 0.3 A) for 36 V OK
On/off behavior	No overshoot of V_{out} (soft start)
Startup delay, max.	2.5 s
Voltage increase time of the output voltage maximum	500 ms
Rated current value $I_{out \text{ rated}}$	13 A
Current range	0 ... 13 A
• Note	+60 ... +70 °C: Derating 2%/K
Supplied active power typical	468 W
Short-term overload current	
• at short-circuit during operation typical	39 A
Duration of overloading capability for excess current	
• at short-circuit during operation	25 ms
Constant overload current	
• on short-circuiting during the start-up typical	14 A
Parallel switching for enhanced performance	Yes; switchable characteristic
Numbers of parallel switchable units for enhanced performance	2

Technical specifications (continued)

Article number	6EP3446-8SB10-0AY0
Product	SITOP PSU8200
Power supply, type	36 V/13 A
Efficiency	
Efficiency at $V_{out\ rated}$, $I_{out\ rated}$, approx.	94 %
Power loss at $V_{out\ rated}$, $I_{out\ rated}$, approx.	30 W
Closed-loop control	
Dynamic mains compensation ($V_{in\ rated} \pm 15\%$), max.	0.1 %
Dynamic load smoothing (I_{out} : 50/100/50 %), $U_{out} \pm$ typ.	1 %
Load step setting time 50 to 100%, typ.	0.2 ms
Load step setting time 100 to 50%, typ.	0.2 ms
Dynamic load smoothing (I_{out} : 10/90/10 %), $U_{out} \pm$ typ.	2 %
Load step setting time 10 to 90%, typ.	0.2 ms
Load step setting time 90 to 10%, typ.	0.2 ms
Setting time maximum	10 ms
Protection and monitoring	
Output overvoltage protection	< 48 V
Current limitation, typ.	14 A
Property of the output Short-circuit proof	Yes
Short-circuit protection	Alternatively, constant current characteristic approx. 14 A or latching shutdown
Enduring short circuit current RMS value	
• typical	14 A
Overcurrent overload capability in normal operation	overload capability 150 % $I_{out\ rated}$ up to 5 s/min
Overload/short-circuit indicator	LED yellow for "overload", LED red for "latching shutdown"
Safety	
Primary/secondary isolation	Yes
Galvanic isolation	Safety extra low output voltage V_{out} according to EN 60950-1
Protection class	Class I
Leakage current	
• maximum	3.5 mA
• typical	0.9 mA
CE mark	Yes
UL/cUL (CSA) approval	cULus-Listed (UL 508, CSA C22.2 No. 107.1), File E197259
Explosion protection	No
FM approval	-
CB approval	Yes
Marine approval	GL, ABS
Degree of protection (EN 60529)	IP20

Article number	6EP3446-8SB10-0AY0
Product	SITOP PSU8200
Power supply, type	36 V/13 A
EMC	
Emitted interference	EN 55022 Class B
Supply harmonics limitation	EN 61000-3-2
Noise immunity	EN 61000-6-2
Operating data	
Ambient temperature	
• during operation	-25 ... +70 °C
- Note	with natural convection
• during transport	-40 ... +85 °C
• during storage	-40 ... +85 °C
Humidity class according to EN 60721	Climate class 3K3, no condensation
Mechanics	
Connection technology	screw-type terminals
Connections	
• Supply input	L1, L2, L3, PE: 1 screw terminal each for 0.2 ... 4 mm ² single-core/finely stranded
• Output	+, -: 2 screw terminals each for 0.2 ... 4 mm ²
• Auxiliary	13, 14 (alarm signal): 1 screw terminal each for 0.14 ... 1.5 mm ² ; 15, 16 (Remote): 1 screw terminal each for 0.14 ... 1.5 mm ²
Width of the enclosure	70 mm
Height of the enclosure	125 mm
Depth of the enclosure	125 mm
Required spacing	
• top	50 mm
• bottom	50 mm
• left	0 mm
• right	0 mm
Weight, approx.	1.2 kg
Product feature of the enclosure housing for side-by-side mounting	Yes
Installation	Snaps onto DIN rail EN 60715 35x7.5/15
Electrical accessories	Buffer module
Mechanical accessories	Device identification label 20 mm x 7 mm, pale turquoise 3RT1900-1SB20
Other information	Specifications at rated input voltage and ambient temperature +25 °C (unless otherwise specified)

Ordering data**Article No.**

**SITOP PSU8200 3-phase,
36 V DC/13 A**

6EP3446-8SB10-0AY0

Stabilized power supply
Input: 3 400 ... 500 V AC
Output: 36 V DC/13 A

Products for specific requirements

Automatic door controls
for industry applications

Additional units > Software kit, Service tool

Overview SIDOOR software kit



SIDOOR software kit

The scope of delivery of the SIDOOR software kit includes an installation CD which includes the following functionalities:

SIDOOR User Software	The component that enables the door control system to be configured, parameters to be assigned, and analyzed.
Siemens HCS12 Firmware Loader	This component is used to update the operating software of the door controller.
SIDOOR USB to UART Bridge Driver	This driver is essential for operation of the USB adapter.

Note:

Some firmware updates are offered as free downloads in the Siemens Industry Online Support (SIOS Service & Support Portal). For information on the availability and acquisition of more firmware, please contact Technical Support.

For more information, see page 13/23.

Overview SIDOOR service tool



The service tool can be used to input run commands, change run parameters and read out learned parameters, door states, input/output signals and service data.

The service tool is connected to the various controllers by the respective cable.

- SIDOOR AT12, SIDOOR AT40 and SIDOOR ATD400V elevator door drives
- SIDOOR ATD400K Cold Room Gate Drive, SIDOOR ATD400W and SIDOOR ATD410W machine tool door drives
- SIDOOR ATD400S and SIDOOR ATE250S platform screen door drives

You do not need to open the cover of the controller to do this.

Note:

If the service tool is in the "Quick adjustment" or "Total adjustment" menu, the run commands of the controller are blocked via the command inputs.

For more information, see page 13/23.

Overview

SIDOOR geared motors are a combination of gear unit, motor and sensor. They are easy to connect to the controller via the interface provided and are automatically detected during commissioning.

The maintenance-free, variable speed drive unit comprises a DC motor with non-self-locking gearing.

The geared motors must be selected according to the dynamic door weight. Two different versions are available for each of the SIDOOR MDG180, SIDOOR MDG400 and SIDOOR M3 to SIDOOR M5 geared motors:

- SIDOOR MDG180 geared motors (max. door weight of 180 kg)
 - SIDOOR MDG180 L (pinion left) 6FB1103-0AT14-4MB0
 - SIDOOR MDG180 R (pinion right) 6FB1103-0AT13-4MB0
- SIDOOR MDG400 geared motors (max. door weight of 400 kg)
 - SIDOOR MDG400 L (pinion left) 6FB1103-0AT14-3MC0
 - SIDOOR MDG400 R (pinion right) 6FB1103-0AT13-3MC0
- SIDOOR MDG400 NMS geared motors (max. door weight 400 kg)
 - Shaft with groove and feather key A5X5 acc. to DIN 6885 – without pinion
 - SIDOOR MDG400 NMS L (shaft left) 6FB1103-0AT14-3MC1
 - SIDOOR MDG400 NMS R (shaft right) 6FB1103-0AT13-3MC1
- SIDOOR M3 geared motors (max. door weight 180 kg)
 - SIDOOR M3 L (pinion left) 6FB1103-0AT10-4MB0
 - SIDOOR M3 R (pinion right) 6FB1103-0AT11-4MB0
- SIDOOR M4 geared motors (max. door weight 400 kg)
 - SIDOOR M4 L (pinion left) 6FB1103-0AT10-3MC0
 - SIDOOR M4 R (pinion right) 6FB1103-0AT11-3MC0
- SIDOOR M5 geared motors (max. door weight 600 kg)
 - SIDOOR M5 L (pinion left) 6FB1103-0AT10-3MD0
 - SIDOOR M5 R (pinion right) 6FB1103-0AT11-3MD0

The gear outlet direction is defined as left or right when viewing the gear unit from the front.



Geared motors (versions with pinion left) shown from bottom to top: SIDOOR MDG180 L, SIDOOR MDG400 L, SIDOOR M3 L, SIDOOR M4 L, SIDOOR M5 L

Technical specifications

Article number	6FB1103-0AT14-4MB0	6FB1103-0AT13-4MB0	6FB1103-0AT14-3MC0	6FB1103-0AT13-3MC0	6FB1103-0AT14-3MC1	6FB1103-0AT13-3MC1	6FB1103-0AT10-4MB0	6FB1103-0AT11-4MB0	6FB1103-0AT10-3MC0	6FB1103-0AT11-3MC0	6FB1103-0AT10-3MD0	6FB1103-0AT11-3MD0
	SIDOOR MDG180 L	SIDOOR MDG180 R	SIDOOR MDG400 L	SIDOOR MDG400 R	SIDOOR MDG400 NMS L	SIDOOR MDG400 NMS R	SIDOOR M3 L	SIDOOR M3 R	SIDOOR M4 L	SIDOOR M4 R	SIDOOR M5 L	SIDOOR M5 R
General information												
Product brand name	SIDOOR											
Product designation	Motor for door control											
Product version	MDG180 L	MDG180 R	MDG400 L	MDG400 R	MDG400 NMS L	MDG400 NMS R	M3 L	M3 R	M4 L	M4 R	M5 L	M5 R
Supply voltage												
Supply voltage (DC)	30 V											
Input current												
Operational current (rated value)	4 A										7.5 A	
Power												
Active power input	120 W										225 W	
Mechanical data												
Torque of the rotary operating mechanism (rated value)	3 N·m										6.8 N·m	
Speed, max.	0.65 m/s		0.75 m/s			0.65 m/s		0.75 m/s		0.5 m/s		
Gear ratio	15											
Number of pulses per revolution, max.	100											
Weight of door, max.	180 kg		400 kg			180 kg		400 kg		600 kg		

Products for specific requirements

Automatic door controls
for industry applications

Geared motors

Technical specifications (continued)

Article number	6FB1103-0AT14-4MB0	6FB1103-0AT13-4MB0	6FB1103-0AT14-3MC0	6FB1103-0AT13-3MC0	6FB1103-0AT14-3MC1	6FB1103-0AT13-3MC1	6FB1103-0AT10-4MB0	6FB1103-0AT11-4MB0	6FB1103-0AT10-3MC0	6FB1103-0AT11-3MC0	6FB1103-0AT10-3MD0	6FB1103-0AT11-3MD0
	SIDOOR MDG180 L	SIDOOR MDG180 R	SIDOOR MDG400 L	SIDOOR MDG400 R	SIDOOR MDG400 NMS L	SIDOOR MDG400 NMS R	SIDOOR M3 L	SIDOOR M3 R	SIDOOR M4 L	SIDOOR M4 R	SIDOOR M5 L	SIDOOR M5 R
Degree and class of protection												
IP degree of protection												
• of the motor	IP56						IP54					
• of the gear unit	IP56						IP40			IP54		
Ambient conditions												
Ambient temperature during operation												
• min.	-20 °C											
• max.	50 °C											
Ambient temperature during storage/transportation												
• Storage, min.	-40 °C											
• Storage, max.	85 °C											
Dimensions												
Height of motor	98 mm		115 mm				98 mm		115 mm		124 mm	
Length of motor	236 mm		275 mm				236 mm		275 mm		344 mm	
Diameter of motor	63 mm											
Width of gear unit, including drive pinion	85 mm		105 mm		106 mm		85 mm		105 mm		111 mm	

Ordering data

SIDOOR MDG180 geared motors

	Article No.
MDG180 L	6FB1103-0AT14-4MB0
MDG180 R	6FB1103-0AT13-4MB0

SIDOOR MDG400 geared motors

	Article No.
MDG400 L	6FB1103-0AT14-3MC0
MDG400 R	6FB1103-0AT13-3MC0

SIDOOR MDG400 NMS

	Article No.
MDG400 NMS L, without pinion	6FB1103-0AT14-3MC1
MDG400 NMS R, without pinion	6FB1103-0AT13-3MC1

SIDOOR M3 geared motors

	Article No.
M3 L	6FB1103-0AT10-4MB0
M3 R	6FB1103-0AT11-4MB0

SIDOOR M4 geared motors

	Article No.
M4 L	6FB1103-0AT10-3MC0
M4 R	6FB1103-0AT11-3MC0

SIDOOR M5 geared motors

	Article No.
M5 L	6FB1103-0AT10-3MD0
M5 R	6FB1103-0AT11-3MD0

Overview

An extensive range of accessories is available for the door control drives.

This is necessary to ensure low-noise operation of the door by the motor. The geared motors can be optimally integrated into the respective door drive system.

Accessories for all controllers for industrial applicationsRubber-metal anti-vibration mounts for geared motors

To ensure low-noise door operation, SIDOOR geared motors are integrated in the door system using rubber-metal anti-vibration mounts.

- Rubber-metal anti-vibration mount 6FB1104-0AT02-0AD0 for SIDOOR MDG180, SIDOOR M2 and SIDOOR M3 geared motors (door weights up to 180 kg)
- Rubber-metal anti-vibration mount 6FB1104-0AT01-0AD0 for SIDOOR MDG400 and SIDOOR M4 (door weights up to 400 kg), and SIDOOR M5 geared motors (door weights up to 600 kg)



Rubber-metal anti-vibration mount 6FB1104-0AT02-0AD0 for geared motors with door weights up to 180 kg

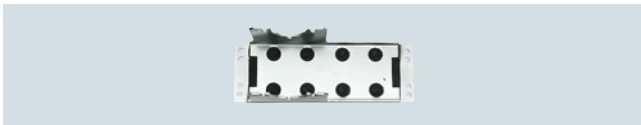

Rubber-metal anti-vibration mount 6FB1104-0AT01-0AD0 for geared motors with door weights up to 600 kg

Mounting bracket

Two different mounting brackets are available with elongated holes:

- Mounting bracket 6FB1104-0AT01-0AS0 for mounting SIDOOR geared motors, for flexible accommodation of the rubber-bonded metal
- Mounting bracket 6FB1104-0AT02-0AS0 for the deflector unit. This enables the toothed belt to be set to the required belt tension.



Mounting bracket 6FB1104-0AT01-0AS0 for mounting the geared motor



Mounting bracket 6FB1104-0AT02-0AS0 for the deflector unit

DIN rail holder

The standard DIN rail holder 6FB1144-0AT00-3SA0 is available for mounting controllers on the TH 35 standard DIN rail according to IEC 60715.

Door clutch holder

The door clutch holder serves to connect the respective door leaf by means of a toothed belt while also functioning as a toothed-belt lock. One door clutch holder per door leaf is required. The toothed-belt lock can accommodate both open ends of the toothed belt.

A door clutch holder is available for each toothed belt width:

- Width 12 mm: 6FB1104-0AT01-0CP0
- Width 14 mm: 6FB1104-0AT02-0CP0



Door clutch holder 6FB1104-0AT01-0CP0 (packing size = 1 unit)

Deflector unit

The deflector unit 6FB1104-0AT03-0AS0 contains an embedded belt pulley which can be mounted on the door system. The STS toothed belt is redirected via this deflector unit.

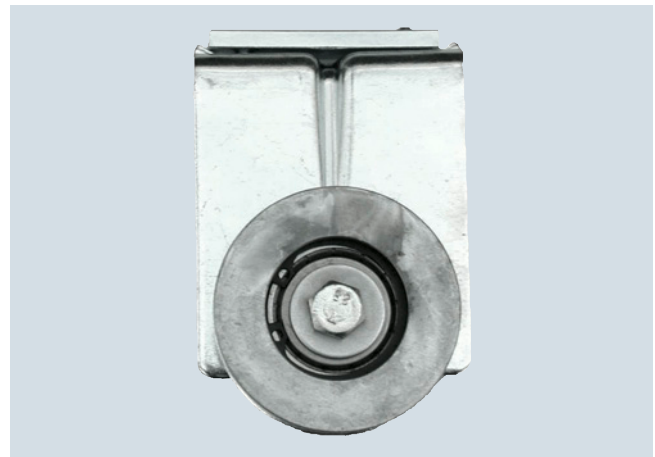

Deflector unit 6FB1104-0AT03-0AS0

Products for specific requirements

Automatic door controls
for industry applications

Accessories

Overview (continued)

STS toothed belt

The door system is moved between the end positions of the door using the STS toothed belts. Two different toothed belt lengths can be ordered for each toothed belt width.

- Toothed belt width 12 mm:
 - Length 4 m: 6FB1104-0AT01-0AB0
 - Length 45 m: 6FB1104-0AT02-0AB0
- Toothed belt width 14 mm:
 - Length 4 m: 6FB1104-0AT03-0AB0
 - Length 55 m: 6FB1104-0AT04-0AB0

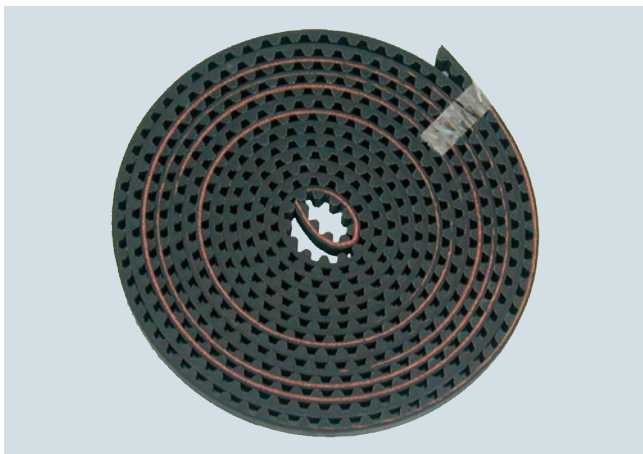

Toothed belt 6FB1104-0AT01-0AB0 (width 12 mm, length 4 m)

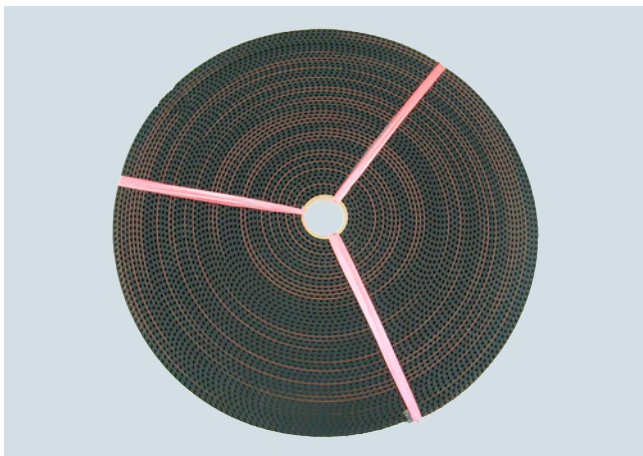

Toothed belt 6FB1104-0AT02-0AB0 (width 12 mm, length 45 m)

For machine tool door drives only

CABLE-MDG hybrid connecting cables

These connecting cables connect the machine tool door drives to the SIDOOR MDG geared motor. Various lengths are available.

- Length 0.5 m: 6FB1104-0AT00-0CB5
- Length 1.5 m: 6FB1104-0AT01-0CB5
- Length 5 m: 6FB1104-0AT05-0CB0
- Length 7 m: 6FB1104-0AT07-0CB0
- Length 10 m: 6FB1104-0AT10-0CB0
- Length 15 m: 6FB1104-0AT15-0CB0
- Length 20 m: 6FB1104-0AT20-0CB0

Machine tool door drives are connected to a higher-level SIMATIC controller via the PB FC RS 485 PLUG 180 connector (6GK1500-0FC10) and the PB FC Standard Cable GP (6XV1830-0EH10), a standard bus cable with a special design for quick mounting. A SIMATIC RS 485/USS communication module is required on the controller side, such as the ET 200S electronic module (6ES7138-4DF11-0AB0) for the SIMATIC ET 200.

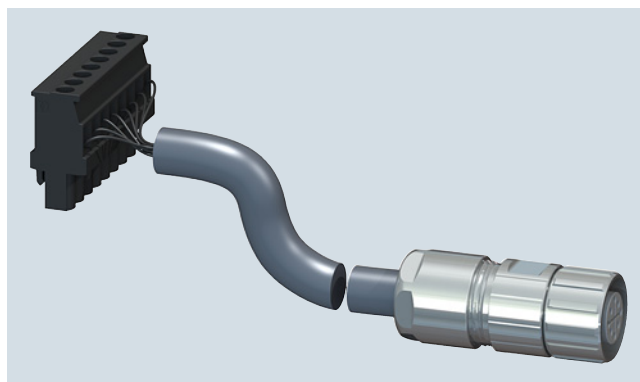

SIDOOR CABLE-MDG

Electronic module for ET 200S

1-channel module 6ES7138-4DF11-0AB0 for serial data exchange via point-to-point connection, for telegrams with a max. length of 224 bytes, RS 232C, RS 422, RS 485, 2 versions, ASCII and 3964(R) protocol, Modbus and USS protocol, parameter assignment via GSD file or STEP 7 (from V5.1)

CM PtP RS 422/485 BA communication module

Basic communication module 6ES7540-1AB00-0AA0 with one RS 422/485 interface, Freeport, 3964(R) and USS protocols, 15-pin sub D socket, max. 19.2 kbps, for SIMATIC S7-1500

CM 1241 communication module

Communication module 6ES7241-1CH32-0XB0 for point-to-point connection with one RS 422/RS 485 interface, 9-pin, sub D (pin), supports Freeport, for SIMATIC S7-1200

Ordering data	Article No.	Ordering data	Article No.
Rubber-metal anti-vibration mounts for geared motors		For machine tool drives only	
<ul style="list-style-type: none"> SIDOOR rubber-metal anti-vibration mount for geared motors for door weights up to 300 kg 	6FB1104-0AT02-0AD0	CABLE-MDG hybrid connecting cables	
<ul style="list-style-type: none"> SIDOOR rubber-metal anti-vibration mount for geared motors for door weights from 300 kg 	6FB1104-0AT01-0AD0	<ul style="list-style-type: none"> 0.5 m 1.5 m 5 m 7 m 10 m 15 m 20 m 	6FB1104-0AT00-0CB5 6FB1104-0AT01-0CB5 6FB1104-0AT05-0CB0 6FB1104-0AT07-0CB0 6FB1104-0AT10-0CB0 6FB1104-0AT15-0CB0 6FB1104-0AT20-0CB0
Mounting bracket		PB FC RS485 PLUG 180	6GK1500-0FC10
<ul style="list-style-type: none"> SIDOOR mounting bracket for geared motor 	6FB1104-0AT01-0AS0	PB FC Standard Cable GP	6XV1830-0EH10
<ul style="list-style-type: none"> SIDOOR mounting bracket with tensioning device for deflector pulley 	6FB1104-0AT02-0AS0	Electronic module for ET 200S	6ES7138-4DF11-0AB0
DIN rail holder		CM PtP RS422/485 BA communication module	6ES7540-1AB00-0AA0
For mounting controllers on the TH 35 standard DIN rail	6FB1144-0AT00-3AS0	CM 1241 communication module	6ES7241-1CH32-0XB0
SIDOOR door clutch holder		SIDOOR door clutch holder	
For toothed belt, width 12 mm	6FB1104-0AT01-0CP0	For toothed belt, width 14 mm	6FB1104-0AT02-0CP0
SIDOOR deflector unit	6FB1104-0AT03-0AS0		
SIDOOR STS toothed belt			
Width 12 mm			
<ul style="list-style-type: none"> 4 m 45 m 	6FB1104-0AT01-0AB0 6FB1104-0AT02-0AB0		
SIDOOR STS toothed belt			
Width 14 mm			
<ul style="list-style-type: none"> 4 m 55 m 	6FB1104-0AT03-0AB0 6FB1104-0AT04-0AB0		

Products for specific requirements

Automatic door controls

For railway applications

Overview

The product-specific application/requirement lies in complying with the special railway requirements concerning functional safety.

Interior railway doors have a closing spring which must always bring the door into the "CLOSED" position. This applies to either side, even when a train car is inclined at 10°.

These specific operating states are handled by the door controller.

Overview

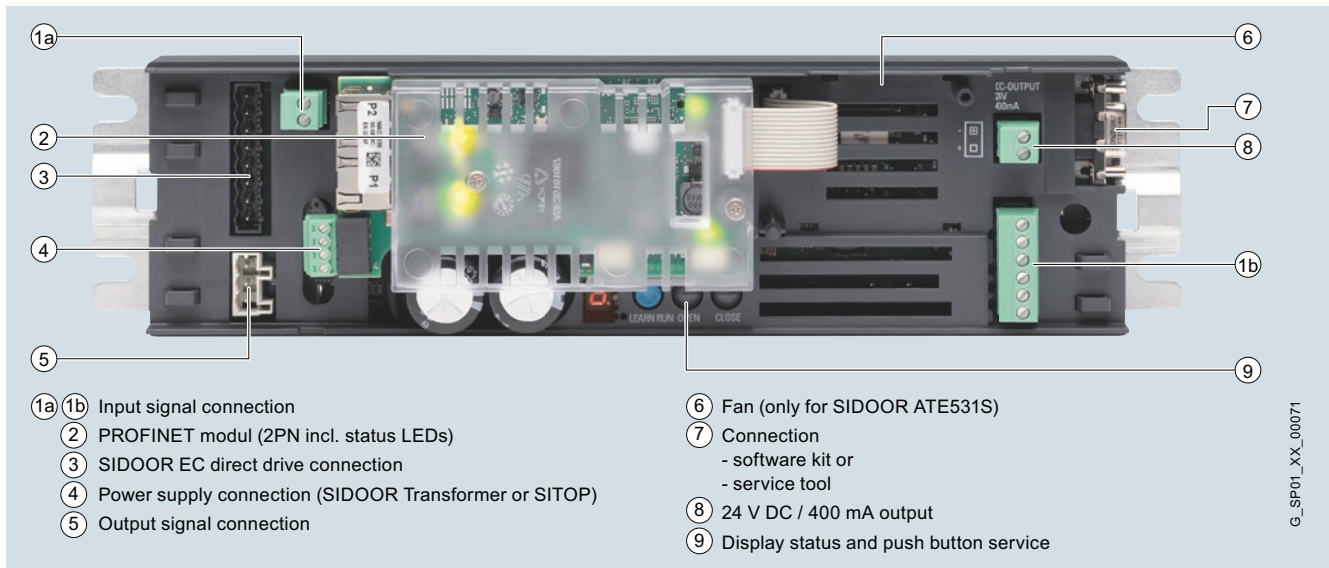

SIDOOR ATE530S/531S wiring diagram

The SIDOOR ATE53xS door controller is an “intelligent” door drive which can be used for safety-oriented operation of platform screen doors (PSD) according to individual requirements. Siemens has once again shown just how easy integration can be with the innovative SIDOOR ATE53xS platform screen door drive in conjunction with SIDOOR MED280 or MEG251 motors. The PROFINET module integrated in the SIDOOR ATE53xS enables standardized, certified connection to PROFINET IO systems.

- Use of standard automation components
- Full integration into TIA Portal and STEP 7 thanks to PROFINET connection
- Parameter assignment and monitoring of door control parameters via the PROFINET interface (function blocks available as example applications in SIOS).

- Application example:
Synchronization of two-panel and independent platform screen doors with SIDOOR ATE530S PROFINET EC door drive and S7-1500 CPU via TIA Portal
<https://support.industry.siemens.com/cs/ww/en/view/109480495>
- Application example:
Safety-oriented automation of platform screen doors with SIDOOR ATE530S PROFINET EC door drive and S7-1500 CPU via TIA Portal
<https://support.industry.siemens.com/cs/ww/en/view/109477186>
- Read-in of two safe signals (two-channel, antivalent)
- High level of system safety thanks to safe torque off (e.g. self-release in the event of a fault)
- Firmware update for all SIDOOR controllers on an entire platform possible centrally via TCP/IP
- SIL 2 according to IEC 62061

Products for specific requirements

Automatic door controls
for railway applications

Controllers > Platform screen door drive

Technical specifications

Article number	6FB1231-3BM10-7AT0 SIDOOR ATE530S	6FB1231-3BM12-7AT0 SIDOOR ATE530S COATED	6FB1231-3BM11-7AT0 SIDOOR ATE531S
General information			
Product brand name	SIDOOR		
Product designation	Door controller		
Product version	ATE530S	ATE530S with protective coating	ATE531 with protective coating and with temperature extension
Optional product expansion	Standard mounting rail holder 6FB1144-0AT00-3AS0		
Manufacturer's article no. of the usable motor	6FB1203-0AT12-7DA0		
Manufacturer's article no. of the usable power supply unit	6FB1112-0AT20-2TR0		
Installation type/mounting			
Installation and mounting instructions	No direct exposure to the sun		
Supply voltage			
Rated value (DC)	36 V; With MED280: At 24 V DC max. door speed of 500 mm/s, at 28.8 V DC max. door speed of 800 mm/s. With MEG251: At 24 V DC max. door speed of 500 mm/s, at 28.8 V DC max. door speed of 750 mm/s		
Power			
Active power input (standby mode)	7 W		
Digital inputs			
Control inputs isolated	Yes		
Control inputs p-switching	Yes		
Fuse protection at DC end (recommendation)	Use of a circuit breaker in the supply path according to 60898-1, 8A, C-characteristic type SIEMENS: 5SY4108-7 or 5SY4108-7KK11		
Input voltage			
• per DC input, min.	10 V; Observe polarity !		
• per DC input, max.	28 V; Observe polarity !		
Input current			
• per DC input, min.	3 mA		
• per DC input, max.	15 mA		
Digital outputs			
Overload-proof	Yes		
Remark	Ensure correct polarity! CAUTION: Do not supply with external voltage!		
Output current			
• For output (24 V DC), max.	400 mA		
Relay outputs			
Switching capacity of contacts			
- at 30 V DC, min.	0.01 A		
- at 30 V DC, max.	0.5 A		
Mechanical data			
Opening width of door, min.	0.35 m		
Opening width of door, max.	5 m		
Weight of door, max.	280 kg		
Operating cycle frequency of door, max.	180 1/h		
Kinetic energy, max.	75 J		
Interfaces			
Interfaces/bus type	PROFINET according to Conformance Class A, B, C; integrated switch for linear and ring structure		

Technical specifications (continued)

Article number	6FB1231-3BM10-7AT0 SIDOOR ATE530S	6FB1231-3BM12-7AT0 SIDOOR ATE530S COATED	6FB1231-3BM11-7AT0 SIDOOR ATE531S
Isolation			
Overvoltage category	2		
Degree and class of protection			
IP degree of protection	IP20		
Standards, approvals, certificates			
CE mark	Yes		No
UL approval	No		
TÜV Inspectorate approval	Yes		
Standard for EMC	EN 61000-6-2 / EN 61000-6-4 / EN 61326-3-1 / EN 50121-3-2 / EN50121-4 / EN50121-5		
Standard for safety	EN 60950-1 / EN 60335-1 / EN 14752 / EN ISO 13849-1 Cat. 2 PL d / IEC 62061: SIL 2		
Ambient conditions			
Ambient temperature during operation			
• min.	-25 °C		70 °C
• max.	50 °C		
• Remark	Screw control device thermally conductive onto a metallic mounting surface or standard rail mounting, otherwise the maximum operating temperature is only 40 °C		To ensure compliance with MTBF value, ensure that the ambient temperature is less than 50 °C for 90 % of operating time and screw the control unit onto a metallic mounting surface in a manner that ensures thermal conductivity or use standard rail mounting. At operating temperatures above 50 °C, the maximum output current of the 24 V DC output is a maximum of 0.1 A and the maximum number of cycles is 60/h.
Ambient temperature during storage/transportation			
• Storage, min.	-40 °C		
• Storage, max.	85 °C		
Air pressure acc. to IEC 60068-2-13			
• Installation altitude above sea level, max.	2 000 m		
Relative humidity			
• No condensation, min.	10 %		
• No condensation, max.	93 %		
Mechanics/material			
Service life			
• Mean time between failures (MTBF)	13 y		
Dimensions			
Width	320 mm		
Height	60 mm		
Depth	80 mm		

Ordering data**Article No.**

SIDOOR ATE530S P Platform Screen Door Drive	
SIDOOR ATE530S	6FB1231-3BM10-7AT0
SIDOOR ATE530S coated, version with protective coating	6FB1231-3BM12-7AT0
SIDOOR ATE531S Platform Screen Door Drive	
SIDOOR ATE531S, version with protective coating and extended temperature range	6FB1231-3BM11-7AT0

Products for specific requirements

Automatic door controls
for railway applications

Controllers > Interior railway door drive

Overview

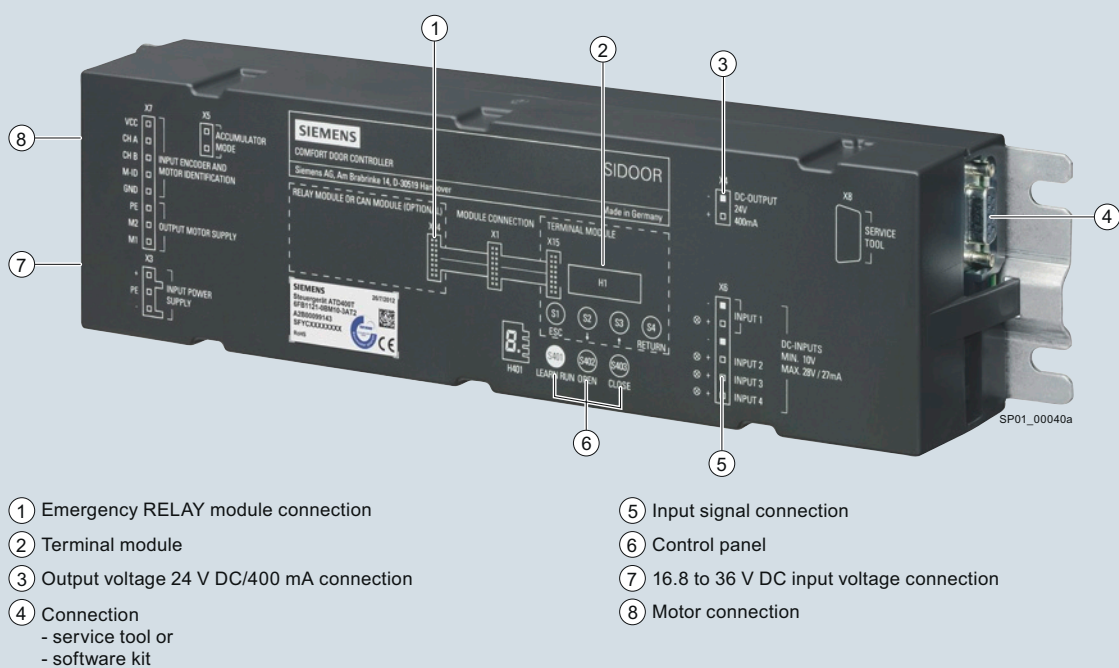

SIDOOR ATD400T interior railway door drive

The SIDOOR ATD400T interior railway door drive is an "intelligent" door drive which enables gangway doors to be opened and closed at adjustable speeds and accelerations.

- Relay module design
- For dynamic door weights up to 180 kg
- Automatic door weight detection
- Operating temperature -20 to +70 °C ¹⁾
- Flexible motor management (two different motor types), automatic detection
- Opening width 0.25 to 4 m
- Door can be operated with and without closing springs (60 to 80 N)
- With two identical door leaves, can be used up to a train inclination of 0 to 10%
- Forces and energies are limited in accordance with EN 14752
- EMC according to EN 50121-3-2
- Fulfills HL3 according to fire protection standard EN 45545-2 (Railway applications – Fire protection on rail vehicles)
- Vandal-proof

1) Note:

- Maximum output current at 24 V DC:
 - 0.4 A at ≤ 55 °C ambient temperature during operation
 - 0.1 A from 55 °C to 70 °C ambient temperature during operation, with restrictions at operating temperatures > 55 °C
- Maximum ambient temperature during operation:
 - 55 °C
 - 70 °C with restrictions at operating temperatures > 55 °C
- Restrictions at operating temperatures > 55 °C:
 - Only use the 24 V output voltage to operate control inputs (max. 0.1 A)
 - Use a sufficiently large (at least 350 x 350 mm), unpainted, metal mounting plate
 - The maximum drive parameters are restricted to the default values
 - If temperature class T3 according to EN 50155 is used, the maximum air temperature of 85 °C must not be exceeded near the printed-circuit board

Technical specifications

Article number	6FB1121-0BM13-3AT2 SIDOOR ATD400T RELAY
General information	
Product brand name	SIDOOR
Product designation	Door controller
Product version	ATD400T relay
Optional product expansion	EMC filter
Manufacturer's article no. of the usable motor	6FB1103-0AT10-5MA0, 6FB1103-0AT11-5MA0, 6FB1103-0AT10-4MB0, 6FB1103-0AT11-4MB0, 6FB1103-0AT10-3MC0, 6FB1103-0AT11-3MC0
Installation type/mounting	
Installation and mounting instructions	At operating temperatures > 55 °C a sufficiently large (at least 350 mm x 350 mm), unpainted, metal mounting plate must be used
Supply voltage	
Rated value (DC)	24 V
Input current	
Current consumption, max.	15 A
Digital inputs	
Control inputs isolated	Yes
Control inputs p-switching	Yes
Input voltage	
• per DC input, min.	10 V; Observe polarity !
• per DC input, max.	28 V; Observe polarity !
Input current	
• per DC input, min.	9 mA
• per DC input, max.	27 mA
Digital outputs	
Overload-proof	Yes
Remark	Ensure correct polarity! CAUTION: Do not supply with external voltage!
Output current	
• For output (24 V DC), max.	400 mA
• For output (24 V DC) at 55 to 70 °C, max.	100 mA
Relay outputs	
Switching capacity of contacts	
- at 50 V DC, min.	0.01 A; 50 V DC switching voltage not released for NFPA-relevant countries
- at 50 V DC, max.	1 A; 50 V DC switching voltage not released for NFPA-relevant countries
- at 230 V AC, min.	0.01 A
- at 230 V AC, max.	1 A

Article number	6FB1121-0BM13-3AT2 SIDOOR ATD400T RELAY
Mechanical data	
Opening width of door, min.	0.25 m
Opening width of door, max.	4 m
Weight of door, max.	400 kg
Operating cycle frequency of door, max.	180 1/h
Counterforce, max.	80 N
Counterweight	
• with SIDOOR M2 geared motor, max.	4 kg
• with SIDOOR M3 geared motor, max.	6 kg
• with SIDOOR M4 geared motor, max.	8 kg
Interfaces	
Interfaces/bus type	without
Isolation	
Overvoltage category	2
Degree and class of protection	
IP degree of protection	IP20
Standards, approvals, certificates	
CE mark	Yes
UL approval	No
Standard for EMC	EN 50121-3-2
Ambient conditions	
Ambient temperature class according to EN 50155	T3
Ambient temperature during operation	
• min.	-25 °C
• max.	70 °C; At operating temperatures > 55 °C the operating parameters are limited to default values
• Remark	At operating temperatures > 55 °C, the maximum air temperature of 85 °C must not be exceeded near the printed-circuit board if temperature class T3 according to EN 50155 is used
Ambient temperature during storage/transportation	
• Storage, min.	-40 °C
• Storage, max.	50 °C
Air pressure acc. to IEC 60068-2-13	
• Installation altitude above sea level, max.	2 000 m
Relative humidity	
• No condensation, min.	10 %
• No condensation, max.	93 %
Fire resistance	
• Behavior in fire	complies with EN 45545-2 Hazard Level HL3
Dimensions	
Width	320 mm
Height	60 mm
Depth	80 mm

Ordering data

Article No.

SIDOOR ATD400T

Controller for interior railway doors, relay module design

6FB1121-0BM13-3AT2

Products for specific requirements

Automatic door controls
for railway applications

Power supplies > Power transformer, Switched-mode power supply

Overview Power transformer



The SIDOOR Transformer power supply is a standard power supply unit operated with 220-240 V AC, 50/60 Hz, from the SIDOOR product range. It can be used for all controllers without an integrated power supply unit. The SIDOOR AT12 elevator door drive has an integrated power supply unit, for example.

For more information, see page 13/21.

Overview Switched-mode power supply

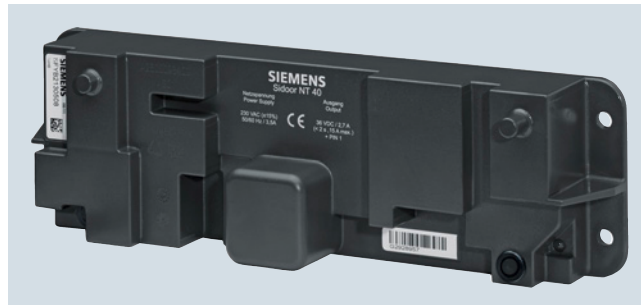

The SIDOOR NT40 switched-mode power supply is operated with 230 V AC ($\pm 15\%$), 50/60 Hz, to power the following SIDOOR door controllers:

- SIDOOR AT40 and SIDOOR ATD400V elevator door drives
- SIDOOR ATD400K cold room gate drives
- SIDOOR ATD4xxW machine tool door drives

It is especially suitable for door systems with high door weights.

On the output side, the power supply unit delivers a voltage of 36 V DC ($\pm 3\%$) SELV at a rated output power of < 100 W.

In order to enable fast acceleration/deceleration of the doors by the controller, the device can briefly (< 2 s) deliver a current of 15 A (corresponds to a short-time power output of 540 W).

For more information, see page 13/22.

Overview SIDOOR software kit

SIDOOR software kit

The scope of delivery of the SIDOOR software kit includes an installation CD which includes the following functionalities:

SIDOOR User Software	The component that enables the door control system to be configured, parameters to be assigned, and analyzed.
Siemens HCS12 Firmware Loader	This component is used to update the operating software of the door controller.
SIDOOR USB to UART Bridge Driver	This driver is essential for operation of the USB adapter.

Note:

Some firmware updates are offered as free downloads in the Siemens Industry Online Support (SIOS Service & Support Portal). For information on the availability and acquisition of more firmware, please contact Technical Support.

For more information, see page 13/23.

Overview SIDOOR service tool

The service tool can be used to input run commands, change run parameters and read out learned parameters, door states, input/output signals and service data.

The service tool is connected to the various controllers by the respective cable.

- SIDOOR AT12, SIDOOR AT40 and SIDOOR ATD400V elevator door drives
- SIDOOR ATD400K Cold Room Gate Drive, SIDOOR ATD400W and SIDOOR ATD410W machine tool door drives
- SIDOOR ATD400S and SIDOOR ATE250S platform screen door drives

You do not need to open the cover of the controller to do this.

Note:

If the service tool is in the "Quick adjustment" or "Total adjustment" menu, the run commands of the controller are blocked via the command inputs.

For more information, see page 13/23.

Products for specific requirements

Automatic door controls
for railway applications

Geared motors

Overview

SIDOOR motors are speed controlled, taking set force and speed limits into account. The gear outlet direction is defined as left or right when viewing the gear unit from the front. Force transmission is via a toothed belt. The toothed belt passes over a deflector pulley and can be fitted with two door clutch holders. This enables it to drive both single-side and centrally opening doors.

SIDOOR geared motors are available in two technological versions.

- 1. DC technology in version
(area of application: interior railway doors)
 - DC geared motor
SIDOOR geared motors are a combination of gear unit, motor, and encoder. They are easy to connect to the controller via the interface provided and are automatically detected during commissioning. The variable speed drive unit comprises a speed-controlled DC motor with non-self-locking gearing.
- 2. EC technology in version
(area of application: platform screen doors):
 - EC direct drive
SIDOOR direct drives are a combination of motor and sensor. They are easy to connect to the controller via the interface provided and are automatically detected during commissioning. The maintenance-free drive unit consists of a gearless, speed-controlled, electronically commutated motor. The EC direct drive can be fitted in various mounting orientations, facilitating reduced inventory management and minimizing assets.
 - EC geared motors
EC geared motors are electronically commutated DC motors with non-self-locking gearing and are speed-controlled. They are easy to connect to the controller via the interface provided and are automatically detected during commissioning. Due to the brushless drive technology, EC geared motors are subject to less abrasion compared with DC geared motors and thus have a longer service life. There is also less commutation noise thanks to the brushless technology, which means there is lower noise generation than with DC geared motors.

Motors for interior railway door drives

The following **DC geared motors** are available for interior railway door drives. They should be selected according to the dynamic door weight.

- SIDOOR MDG180 geared motors, compliance with fire protection standard EN 45545-2 (max. door weight 180 kg)
 - SIDOOR MDG180 L EN 45545-2 (pinion left) 6FB1103-0AT16-4MB0
 - SIDOOR MDG180 R EN 45545-2 (pinion right) 6FB1103-0AT15-4MB0
- SIDOOR M3 geared motors (max. door weight 180 kg)
 - SIDOOR M3 L (pinion left) 6FB1103-0AT10-4MB0
 - SIDOOR M3 R (pinion right) 6FB1103-0AT11-4MB0
- SIDOOR M4 geared motors (max. door weight 400 kg)
 - SIDOOR M4 L (pinion left) 6FB1103-0AT10-3MC0
 - SIDOOR M4 R (pinion right) 6FB1103-0AT11-3MC0

Motors for platform screen door drives

EC technology:

- SIDOOR MEG251 geared motors (max. door weight 250 kg)
 - SIDOOR MEG251 L (pinion left), 6FB1203-5AT00-7MP0
 - SIDOOR MEG251 R (pinion right), 6FB1203-5AT01-7MP0



Photo: DC geared motor SIDOOR M3 L, 6FB1103-0AT10-4MB0 or SIDOOR MDG180 L, 6FB1103-0AT16-4MB0. (version with pinion left)



Photo: EC geared motor SIDOOR MEG251 L, 6FB1203-5AT00-7MP0. (version with pinion left)

Technical specifications

Article number	6FB1103-0AT16-4MB0	6FB1103-0AT15-4MB0	6FB1103-0AT10-4MB0	6FB1103-0AT11-4MB0	6FB1103-0AT10-3MC0	6FB1103-0AT11-3MC0	6FB1203-5AT00-7MP0	6FB1203-5AT01-7MP0
	SIDOOR MDG180 L DIN EN 45545-2	SIDOOR MDG180 R DIN EN 45545-2	SIDOOR M3 L	SIDOOR M3 R	SIDOOR M4 L	SIDOOR M4 R	SIDOOR MEG251 L	SIDOOR MEG251 R
General information								
Product brand name	SIDOOR							
Product designation	Motor for door control							
Product version	MDG180 L DIN EN 45545-2	MDG180 R DIN EN 45545-2	M3 L	M3 R	M4 L	M4 R	MEG251 L	MEG251 R
Supply voltage								
Supply voltage (DC)	30 V						24 V	
Input current								
Operational current (rated value)	4 A						6.8 A	
Power								
Active power input	120 W						163 W	
Mechanical data								
Torque of the rotary operating mechanism (rated value)	3 N·m						4.1 N·m	
Speed, max.	0.65 m/s				0.75 m/s			
Gear ratio	15							
Number of pulses per revolution, max.	100							
Weight of door, max.	180 kg				400 kg		250 kg	
Degree and class of protection								
IP degree of protection								
• of the motor	IP54						IP40	
• of the gear unit	IP40							
Ambient conditions								
Ambient temperature during operation								
• min.	-20 °C							
• max.	50 °C						70 °C	
Ambient temperature during storage/transportation								
• Storage, min.	-40 °C							
• Storage, max.	85 °C							
Fire resistance								
• Behavior in fire	complies with EN 45545-2 Hazard Level HL3							
Dimensions								
Height of motor	98 mm				115 mm		100 mm	
Length of motor	236 mm				275 mm		249 mm	
Diameter of motor	63 mm						62 mm	
Width of gear unit, including drive pinion	85 mm				105 mm		86 mm	

Ordering data
Motors for interior railway door drives

SIDOOR MDG180 geared motors
 MDG180 L, EN 45545-2
 MDG180 R, EN 45545-2
 SIDOOR M3 geared motors
 M3 L
 M3 R
 SIDOOR M4 geared motors
 M4 L
 M4 R

Article No.

6FB1103-0AT16-4MB0
6FB1103-0AT15-4MB0
6FB1103-0AT10-4MB0
6FB1103-0AT11-4MB0
6FB1103-0AT10-3MC0
6FB1103-0AT11-3MC0

Article No.
Motors for platform screen doors

SIDOOR MEG251 EC technology geared motor
 MEG251 L
 MEG251 R

6FB1203-5AT00-7MP0
6FB1203-5AT01-7MP0

Products for specific requirements

Automatic door controls
for railway applications

Direct drives

Overview



SIDOOR MED280 direct drive

SIDOOR direct drives are a combination of motor and sensor. They are easy to connect to the controller via the interface provided and are automatically detected during commissioning.

The maintenance-free drive unit consists of a gearless, speed-controlled, electronically commutated motor with non-self-locking gearing.

Direct drives are designed for certain maximum dynamic door weights and can control both drive directions.

- SIDOOR MED280 direct drive for dynamic door weights up to 280 kg (6FB1203-0AT12-7DA0)

Technical specifications

Article number	6FB1203-0AT12-7DA0 SIDOOR MED280
General information	
Product brand name	SIDOOR
Product designation	Motor for door control
Product version	MED280
Supply voltage	
Supply voltage (DC)	24 V
Input current	
Operational current (rated value)	9.7 A
Power	
Active power input	233 W
Mechanical data	
Torque of the rotary operating mechanism (rated value)	4.7 N·m
Speed, max.	0.8 m/s
Number of pulses per revolution, max.	1 024
Weight of door, max.	280 kg
Degree and class of protection	
IP degree of protection	
• of the motor	IP54

Article number	6FB1203-0AT12-7DA0 SIDOOR MED280
Ambient conditions	
Ambient temperature during operation	
• min.	-25 °C
• max.	70 °C
Ambient temperature during storage/transportation	
• Storage, min.	-40 °C
• Storage, max.	85 °C
Dimensions	
Width of motor	160 mm
Height of motor	140 mm
Length of motor	56 mm
• including drive pinion	91 mm

Ordering data

Article No.

SIDOOR MED280 direct drive	6FB1203-0AT12-7DA0
Motor for door control	

Overview

A comprehensive range of accessories is available for the SIDOOR systems. This is necessary to ensure low-noise operation of the door by the controller.

Accessories for SIDOOR DC and EC geared motorsRubber-metal anti-vibration mount

To ensure low-noise door operation, the SIDOOR geared motors are integrated in the door system using rubber-metal anti-vibration mounts.

- Rubber-metal anti-vibration mount 6FB1104-0AT02-0AD0 for SIDOOR M3 and SIDOOR MDG180 DC geared motors (also for EN 45545-2) and SIDOOR MEG251 EC geared motors (door weights up to 250 kg)
- Rubber-metal anti-vibration mount 6FB1104-0AT01-0AD0 for SIDOOR M4 DC geared motors (door weights up to 400 kg)



Rubber-metal anti-vibration mount 6FB1104-0AT02-0AD0

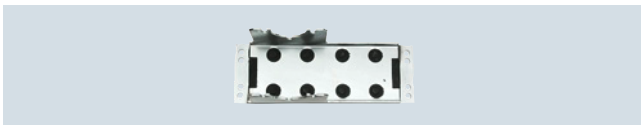

Rubber-metal anti-vibration mount 6FB1104-0AT01-0AD0

Mounting bracket

Two different mounting brackets are available with elongated holes:

- Mounting bracket 6FB1104-0AT01-0AS0 for SIDOOR M3 and SIDOOR MDG180 DC geared motors (also for EN 45545-2) and SIDOOR MEG251 EC geared motors for flexible accommodation of the rubber-bonded metal.
- Mounting bracket 6FB1104-0AT02-0AS0 for the deflector unit. This enables the toothed belt to be set to the required belt tension.



Mounting bracket 6FB1104-0AT01-0AS0 for mounting the geared motor



Mounting bracket 6FB1104-0AT02-0AS0 for the deflector unit

Door clutch holder

The door clutch holder 6FB1104-0AT01-0CP0 serves to connect the respective door leaf by means of a toothed belt while also functioning as a toothed-belt lock. One door clutch holder per door leaf is required. The toothed-belt lock can accommodate both open ends of the toothed belt.



Door clutch holder 6FB1104-0AT01-0CP0 (packing size = 1 unit)

Deflector unit

The deflector unit 6FB1104-0AT03-0AS0 contains an embedded belt pulley which can be mounted on the door system.

The STS toothed belt is redirected via this deflector unit.



Deflector unit 6FB1104-0AT03-0AS0

STS toothed belt

The door system is moved between the end positions of the door using the STS toothed belt 6FB1104-0AT0.-0AB0. Two different toothed belt lengths are available.

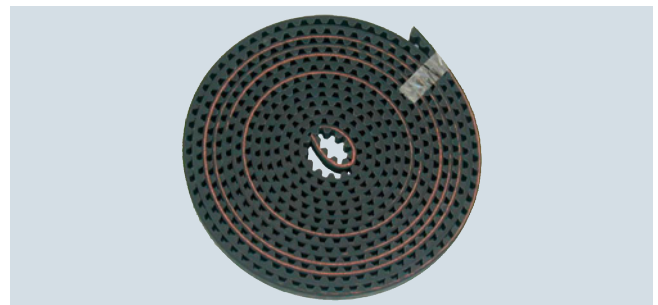

Toothed belt 6FB1104-0AT01-0AB0, length 4 m



Toothed belt 6FB1104-0AT02-0AB0, length 45 m

Products for specific requirements

Automatic door controls
for railway applications

Accessories

Overview (continued)

Accessories for the SIDOOR ATE530S/ATE531S platform screen door drive in conjunction with the SIDOOR MED280 EC direct drive

Motor holder

- Motor holder 6FB1104-0AT03-0AD0 for accommodation of the SIDOOR MED280 direct drive.

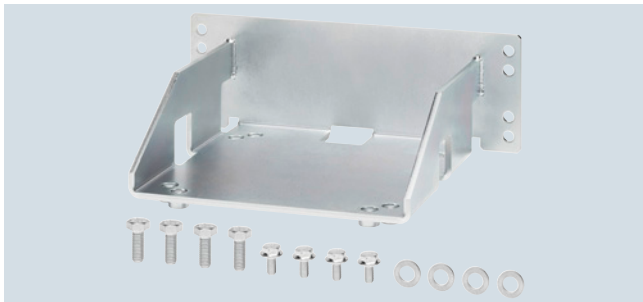

SIDOOR motor holder

Mounting bracket

- For mounting the SIDOOR motor holder 6FB1104-0AT01-0AS0. Identical to the mounting bracket 6FB1104-0AT01-0AS0 for DC geared motors.



Mounting bracket for geared motor

- With tensioning device for mounting the deflector unit and setting the toothed belt to the required tension (large) 6FB1104-0AT05-0AS4



SIDOOR mounting bracket, large

- With tensioning device for mounting the deflector unit and setting the toothed belt to the required tension (small) 6FB1104-0AT05-0AS5



SIDOOR mounting bracket, small

Door clutch holder

- For attaching both ends of the toothed belt and connecting the respective door panel to the toothed belt, width 20 mm, 6FB1104-0AT05-0AS1

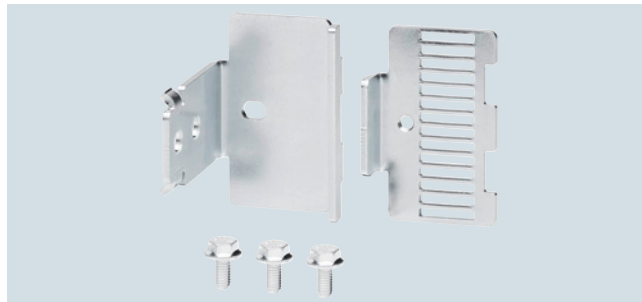

SIDOOR door clutch holder

Deflector unit

- For attaching the SIDOOR toothed belt and fixing to the door 6FB1104-0AT07-0AS0



SIDOOR deflector unit

STD toothed belt

- As a connection between the door system and the end positions of the door, toothed belt width 20 mm. Length 4 m, 6FB1104-0AT05-0AB0



SIDOOR toothed belt, small

- Toothed belt width 20 mm. Length 45 m 6FB1104-0AT06-0AB1



SIDOOR toothed belt, large

Ordering data	Article No.	Ordering data	Article No.
Accessories for the SIDOOR ATE530S/ATE531S platform screen door drive in conjunction with the SIDOOR MED280 EC direct drive		Accessories for SIDOOR DC and EC geared motors	
Motor holder for SIDOOR MED280 direct drive	6FB1104-0AT03-0AD0	Rubber-metal anti-vibration mounts for geared motors	
Mounting bracket for mounting the motor holder	6FB1104-0AT01-0AS0	<ul style="list-style-type: none"> SIDOOR rubber-metal anti-vibration mount for geared motors for door weights up to 300 kg 	6FB1104-0AT02-0AD0
Mounting bracket with tensioning device for mounting the deflector unit		<ul style="list-style-type: none"> SIDOOR rubber-metal anti-vibration mount for geared motors for door weights from 300 kg 	6FB1104-0AT01-0AD0
<ul style="list-style-type: none"> Large Small 	6FB1104-0AT05-0AS4 6FB1104-0AT05-0AS5	Mounting bracket	
SIDOOR door clutch holder		<ul style="list-style-type: none"> SIDOOR mounting bracket for geared motor 	6FB1104-0AT01-0AS0
<ul style="list-style-type: none"> For toothed belt, width 20 mm 	6FB1104-0AT05-0AS1	<ul style="list-style-type: none"> SIDOOR mounting bracket with tensioning device for deflector pulley 	6FB1104-0AT02-0AS0
SIDOOR deflector unit	6FB1104-0AT07-0AS0	SIDOOR door clutch holder	
SIDOOR STD toothed belt		<ul style="list-style-type: none"> For toothed belt, width 12 mm 	6FB1104-0AT01-0CP0
Width 20 mm		SIDOOR deflector unit	6FB1104-0AT03-0AS0
<ul style="list-style-type: none"> 4 m 5 m 	6FB1104-0AT05-0AB0 6FB1104-0AT06-0AB1	SIDOOR STS toothed belt	
		Width 12 mm	
		<ul style="list-style-type: none"> 4 m 45 m 	6FB1104-0AT01-0AB0 6FB1104-0AT02-0AB0

Products for specific requirements

Condition monitoring systems

Introduction, SIPLUS CMS1200 Condition Monitoring System

Overview



SIPLUS CMS family

With the Condition Monitoring System from Siemens you can constantly monitor your machines and plants. Maintenance procedures can be planned better and only performed when they are actually necessary – predictive maintenance.

Overview SIPLUS CMS1200

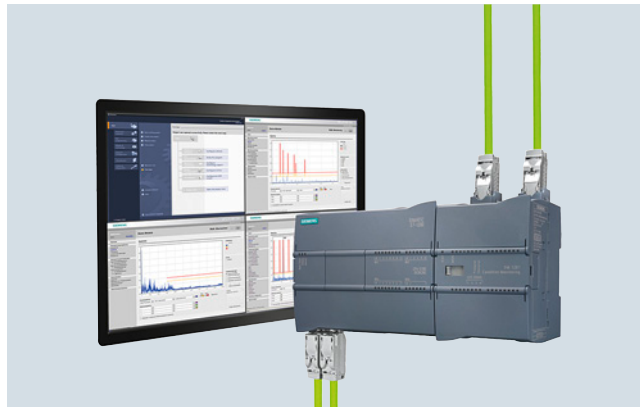

The SIPLUS CMS1200 Condition Monitoring System is part of SIMATIC S7-1200 and is designed for the early detection of mechanical damage.

It provides the following benefits:

- vRMS machine monitoring in acc. with ISO 10816-3
- aRMS machine monitoring
- Detailed identification of damage with frequency-selective diagnostics
- Raw data recording and export for SIPLUS CMS X-Tools
- Trend recording and analysis
- Signaling of limit violations
- Permanent monitoring to protect the machines
- Effective monitoring of important processes and systems
- Early detection of damage
- Scheduled maintenance instead of spontaneous repair
- Reduction in maintenance costs
- Increase in system availability
- Optimum utilization of the service life of the units

Products for specific requirements

Condition monitoring systems

SIPLUS CMS1200 Condition Monitoring System

SIPLUS CMS1200 SM 1281 Condition Monitoring

Overview



SIPLUS CMS1200 SM 1281 Condition Monitoring forms part of SIMATIC S7-1200 and is used for the:

- Monitoring of motors, generators, pumps, fans, or other mechanical components
- Recording and analysis of vibrations
- Expansion capability of up to 7 modules

Technical specifications

Article number	6AT8007-1AA10-0AA0 SM1281_Condition_Monitoring
General information	
Product brand name	SIPLUS
Product category	Condition Monitoring IEPE
Product designation	CMS1200 SM 1281 Condition Monitoring
Product description	S7-1200 module for the monitoring of vibrations on mechanical components based on parameters and frequency-selective analysis functions
Physical measuring principle	Vibration acceleration
Measurement range vibration frequency, min.	0.1 Hz
Measurement range vibration frequency, max.	10 000 Hz
Installation type/mounting	
Mounting type	Rail or wall mounting
Mounting position	Horizontal, vertical
Recommended mounting position	Horizontal
Supply voltage	
Type of supply voltage	DC
Rated value (DC)	
• 24 V DC	Yes
permissible range, lower limit (DC)	20.4 V
permissible range, upper limit (DC)	28.8 V
Input current	
Current consumption, typ.	200 mA
Current consumption, max.	250 mA
from backplane bus 5 V DC, typ.	80 mA
from backplane bus 5 V DC, max.	85 mA
Memory	
Total memory capacity	1 Gbyte
Hardware configuration	
Design of hardware configuration	Modular, up to 7 modules per CPU

Article number	6AT8007-1AA10-0AA0 SM1281_Condition_Monitoring
Speed input	
Number of speed inputs	1
Protocols	
• 24 V DC digital	Yes
Sensor input	
Number of IEPE sensor inputs	4
Sampling frequency, max.	46 875 Hz
Interfaces	
Type of data transmission	Exporting of raw data as WAV file for further analyses (e.g. using CMS X-Tools) can be downloaded via browser
Ethernet interface	Yes
Protocols	
Bus communication	Yes
Web server	
• HTTP	Yes
Interrupts/diagnostics/status information	
Alarms	
• Diagnostic alarm	Yes
Diagnostics indication LED	
• Status indicator digital input (green)	No
• for status of the inputs	Yes
• for maintenance	Yes

Products for specific requirements

Condition monitoring systems

SIPLUS CMS1200 Condition Monitoring System

SIPLUS CMS1200 SM 1281 Condition Monitoring

Technical specifications (continued)

Article number	6AT8007-1AA10-0AA0 SM1281_Condition_Monitoring
Integrated Functions	
Monitoring functions	
• Monitoring of the sensor inputs	Yes; Cable break and short-circuit
• Vibration characteristic monitoring via RMS value of the vibration speed	Yes
• Vibration characteristic monitoring via RMS value of the vibration acceleration	Yes
• Frequency-selective monitoring via vibration speed spectrum	Yes
• Frequency-selective monitoring via vibration acceleration spectrum	Yes
• Frequency-selective monitoring via envelope curve analysis	Yes
Degree and class of protection	
Degree of protection acc. to EN 60529	
• IP20	Yes
Standards, approvals, certificates	
Certificate of suitability	CE
CE mark	Yes
UL approval	Yes
EAC (formerly Gost-R)	Yes
China RoHS compliance	Yes
Device tag according to DIN EN 81346-2	P
Ambient conditions	
Free fall	
• Fall height, max.	0.3 m; five times, in product package
Ambient temperature during operation	
• horizontal installation, min.	-20 °C
• horizontal installation, max.	60 °C
• vertical installation, min.	-20 °C
• vertical installation, max.	45 °C

Article number	6AT8007-1AA10-0AA0 SM1281_Condition_Monitoring
Ambient temperature during storage/transportation	
• min.	-40 °C
• max.	70 °C
Air pressure acc. to IEC 60068-2-13	
• Operation, min.	795 hPa
• Operation, max.	1 080 hPa
• Storage/transport, min.	660 hPa
• Storage/transport, max.	1 080 hPa
Relative humidity	
• Operation without condensation, min.	5 %
• Operation without condensation, max.	95 %
Software	
Browser software required	Web browser Mozilla Firefox (ESR31) or Microsoft Internet Explorer (10/11)
Connection method	
required front connector	Yes
Design of electrical connection	Screw connection
Mechanics/material	
Material of housing	Plastic: polycarbonate, abbreviation: PC- GF 10 FR
Enclosure material (front)	
• Plastic	Yes
Dimensions	
Width	70 mm
Height	112 mm
Depth	75 mm
Weights	
Weight	260 g

Ordering data

Article No.

SIPLUS CMS1200 SM 1281 Condition Monitoring

Module for SIMATIC S7-1200 for monitoring vibrations in mechanical components based on characteristic values and frequency-selective analysis functions

6AT8007-1AA10-0AA0

Overview

SIPLUS CMS1200 SM 1281 shield clamp set

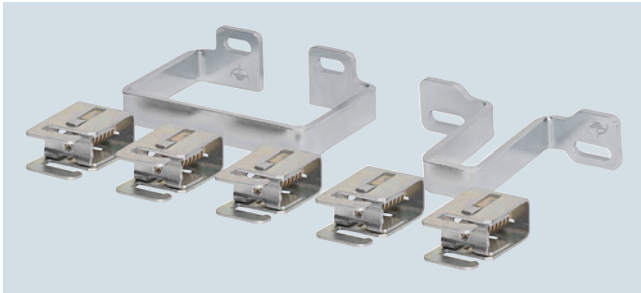

CMS1200 accessory

SIPLUS CMS1200 SM 1281 shield clamp set,
 6AT8007-1AA20-0AA0

An additional shield clamp set must be ordered for the EMC-compliant connection of cables to the SIPLUS CMS1200 SM 1281 Condition Monitoring system.

The SM 1281 shield clamp set comprises two shield clamps and five terminal clamps. One shield clamp is screwed on above and one below the module. The sensor cable shields are connected to the shield clamps by means of the terminal clamps.

VIB-SENSOR S01 vibration sensor



VIB-SENSOR S01 vibration sensor

VIB-SENSOR S01, 6AT8002-4AB00 vibration sensor

The VIB-SENSOR S01 vibration sensor with IEPE (integrated electronics piezoelectric) interface can be directly connected to the SIPLUS CM1200 SM1281 Condition Monitoring module.

The sensor detects vibration accelerations in the frequency range from 0.5 Hz to 15 kHz with a resolution of 100 mv/g.

A threaded screw with an M8 thread for mounting to the measuring point is included in the scope of supply. The connecting cable is connected to the vibration sensor via the MIL connector.

SIPLUS CABLE-MIL connecting cable



SIPLUS CABLE-MIL connecting cable

SIPLUS CABLE-MIL connecting cables, 6AT8002-4AC03,
 6AT8002-4AC10

The VIB-SENSOR S01 vibration sensor is connected to the SIPLUS CMS1200 SM1281 module by means of the SIPLUS CABLE-MIL connecting cable.

This high-quality industrial cable is made of black polyurethane and is pre-assembled on one end with a MIL connector (MIL-C5015). The open cable end of the shielded two-wire cable is connected directly to the screw terminals of the basic unit.

The connecting cable is available in lengths of 3 m and 10 m.

Products for specific requirements

Condition monitoring systems

SIPLUS CMS1200 Condition Monitoring System

Accessories

Technical specifications

Article number	6AT8007-1AA20-0AA0 SM 1281 shield clamp set
General information	
Product brand name	SIPLUS
Product designation	CMS1200 SM 1281 accessory set
Product description	For the EMC-compliant connection of cables to the SIPLUS CMS1200 SM 1281 Condition Monitoring Module
Installation type/mounting	
Mounting type	wall mounting
Connection method	
Number of signal cables connectable to the shield support	5

Article number	6AT8002-4AB00 SIPLUS CMS2000 VIB-SENSOR S01
General information	
Product brand name	SIPLUS CMS
Product designation	VIB SENSOR S01
Product description	Piezoelectric sensor for connection to the SIPLUS CMS2000 Basic Unit VIB or the SIPLUS CMS2000 VIB-MUX expansion module
Physical measuring principle	Piezo-quartz recorder with integrated evaluation electronics
Operating range of sensor at +/- 3 dB, min.	0.5 Hz
Operating range of sensor at +/- 3 dB, max.	15 000 Hz
Measurement range vibration acceleration, max.	50 gn
Sensitivity, typ.	100 mV/gn
Resolution of measured value of vibration acceleration, min.	0.002 gn
Resonance frequency	23 kHz
Installation type/mounting	
other mounting	incl. mounting bolts UNF1/4-28 on M8
Input current	
Type of power supply	IEPE 2 to 10 mA
Sensor input	
Encoder signals, IEPE	
• Signal voltage (DC), min.	10 V
• Signal voltage (DC), max.	14 V
Degree and class of protection	
IP degree of protection	IP65
Ambient conditions	
Ambient temperature during operation	
• Operating temperature range, min.	-50 °C
• Operating temperature range, max.	120 °C
Cables	
Cable length, max.	80 m
Connection method	
Type of connection	MIL-C5015
Mechanics/material	
Material of housing	Stainless steel

Ordering data

SIPLUS CMS1200 SM1281 shield clamp set	
For EMC-compliant connection of signal and encoder cables to SIPLUS CMS1200 SM 1281 Condition Monitoring.	6AT8007-1AA20-0AA0
VIB-SENSOR S01 vibration sensor	6AT8002-4AB00
Piezoelectric sensor for connection to SIPLUS CMS1200 SM 1281 Condition Monitoring.	

Article No.

Article No.

SIPLUS CABLE-MIL	
For connection of VIB-SENSOR S01 vibration sensor to SIPLUS CMS1200 SM 1281 Condition Monitoring.	
SIPLUS CABLE MIL-300; length 3 m	6AT8002-4AC03
SIPLUS CABLE MIL-1000; length 10 m	6AT8002-4AC10

Overview

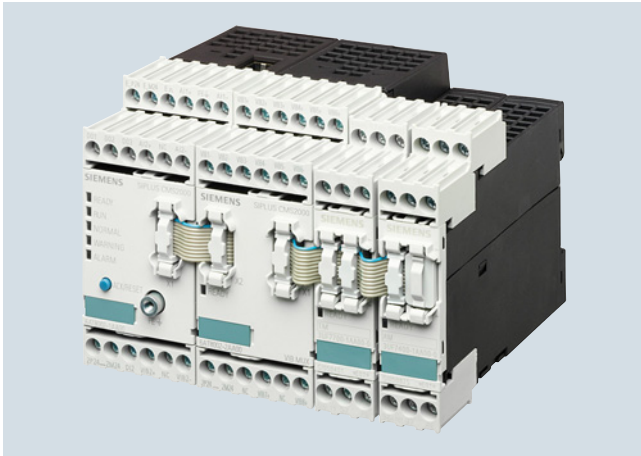

The modular and parameterizable SIPLUS CMS2000 Condition Monitoring System is an easy-to-parameterize, web-based system.

It provides the following benefits:

- Analysis of the status of rolling-contact bearings in accordance with VDI 3832 (DKW)
- RMS machine monitoring in accordance with DIN ISO 10816-3
- Detailed identification of damage with frequency-selective diagnostics
- Raw data recording and export for SIPLUS CMS X-Tools
- Trend recording and analysis
- Monitoring of process variables
- Signaling of limit violations
- Permanent monitoring to protect the machines
- Effective monitoring of important processes and systems
- Energy efficiency support
- Early detection of damage
- Scheduled maintenance instead of spontaneous repair
- Reduction in maintenance costs
- Increased system availability
- Optimum utilization of the service life of the units

The SIPLUS CMS2000 Condition Monitoring System is modularly expandable, e.g. with the

- SIPLUS CMS2000 VIB-MUX expansion module for expanding the IEPE vibration channels
- Temperature module for direct connection of temperature sensors (Pt100, Pt1000, etc.)

Products for specific requirements

Condition monitoring systems

SIPLUS CMS2000 Condition Monitoring System

Basic units

Overview



The SIPLUS CMS2000 Basic Unit VIB is used for:

- Monitoring of motors, generators, pumps, fans, or other mechanical components
- Recording and analysis of vibrations, speed, and temperature

It is modularly expandable via the system interface, e.g. using SIPLUS CMS2000 VIB-MUX expansion modules and temperature modules.

Technical specifications

Article number	6AT8002-1AA00 SIPLUS CMS2000 Basic Unit VIB
General information	
Product brand name	SIPLUS
Product designation	SIPLUS CMS2000 Basic Unit VIB
Product description	Basic unit for the monitoring of vibrations on mechanical components based on parameters and frequency-selective analysis functions for measuring category 0 acc. to EN 61010
Physical measuring principle	Vibration acceleration
Measurement range vibration frequency, min.	2 Hz
Measurement range vibration frequency, max.	10 000 Hz
Installation type/mounting	
Mounting type	standard rail
Mounting position	vertical
Recommended mounting position	vertical
Supply voltage	
Type of supply voltage	DC
Rated value (DC)	24 V
permissible range, lower limit (DC)	19.2 V
permissible range, upper limit (DC)	28.8 V
Power loss	
Power loss, typ.	2.6 W
Memory	
Total memory capacity	1 Gbyte
Hardware configuration	
Design of hardware configuration	modular construction, basic unit can be expanded by means of expansion modules
Digital inputs	
Number of disable inputs	1
Number of trigger inputs	1
Input voltage	
• At the 24 V DC disable input	Yes
• At the disable input (DC), max.	28.8 V
• At the trigger input 24 V DC	Yes
• At the trigger input (DC), max.	28.8 V

Article number	6AT8002-1AA00 SIPLUS CMS2000 Basic Unit VIB
Digital outputs	
Number of signaling outputs	3
Design of signaling outputs	Electronic
Output current	
• For signaling output, max.	0.1 A
Analog inputs	
Number of analog inputs	2
Input ranges (rated values), voltages	
• At DC, min.	-10 V
Input ranges (rated values), currents	
• 0 to 20 mA	No
• +/- 4 mA to +/- 20 mA	Yes
Speed input	
Number of speed inputs	1
Protocols	
• 24 V DC digital	Yes
• At DC, max.	28.8 V
• -10 V to +10 V	No
Protocols	
• 0 to 20 mA	No
• 4 mA to 20 mA	No
• permissible range, upper limit	0.1 A
• Short-circuit current	0.7 A
Sensor input	
Number of IEPE sensor inputs	2
Number of MEMS sensor inputs	0
Sampling frequency, max.	46 875 Hz
Interfaces	
Type of data transmission	Exporting of raw data as WAV file for further analyses (e.g. using CMS X-Tools) can be downloaded via browser
Ethernet interface	Yes
SIMOCODE interface	Yes

Technical specifications (continued)

Article number	6AT8002-1AA00 SIPLUS CMS2000 Basic Unit VIB
Protocols	
Bus communication	Yes
Open IE communication	
• TCP/IP	Yes
Web server	
• HTTP	Yes
Interrupts/diagnostics/ status information	
Diagnostics via e-mail	Yes
Integrated Functions	
Monitoring functions	
• Monitoring of the sensor inputs	Yes
• Vibration characteristic monitoring via RMS value of the vibration speed	Yes
• Vibration characteristic monitoring via diagnostic characteristic value	Yes
• Frequency-selective monitoring via vibration speed spectrum	Yes
• Frequency-selective monitoring via vibration acceleration spectrum	Yes
• Frequency-selective monitoring via envelope curve analysis	Yes
Isolation	
Overvoltage category	II
Degree and class of protection	
IP degree of protection	IP20
Standards, approvals, certificates	
Certificate of suitability	CE, UL 508, CSA C22.2 Nr.142, C-TICK (RCM)
Degree of pollution	2
Equipment marking according to EN 61346-2	P
Equipment marking according to DIN 40719, expanded according to IEC 204-2, according to IEC 750	P
Ambient conditions	
Ambient temperature during operation	
• min.	-20 °C
• max.	65 °C
Ambient temperature during storage/transportation	
• Storage, min.	-25 °C
• Storage, max.	85 °C
• Transportation, min.	-25 °C
• Transportation, max.	85 °C
Air pressure acc. to IEC 60068-2-13	
• Installation altitude above sea level, max.	1 500 m
Relative humidity	
• Operation without condensation, min.	5 %
• Operation without condensation, max.	95 %

Article number	6AT8002-1AA00 SIPLUS CMS2000 Basic Unit VIB
Software	
Browser software required	Webbrowser Mozilla Firefox, Google Chrome or Microsoft Internet Explorer
Connection method	
Design of electrical connection for the inputs and outputs	Screw connection
Design of electrical connection for auxiliary and control circuit	Screw connection
• Connectable conductor cross-section, solid or stranded, min.	0.5 mm ²
• Connectable conductor cross-section, solid or stranded, max.	4 mm ²
• Connectable conductor cross-section, finely stranded with end sleeve, min.	0.5 mm ²
• Connectable conductor cross-section, finely stranded with end sleeve, max.	2.5 mm ²
• Connectable cable cross-section finely stranded without end sleeve, min.	0.5 mm ²
• Connectable cable cross-section finely stranded without end sleeve, max.	2.5 mm ²
Terminals	
• Removable terminal for main circuit	Yes
• Removable terminal for auxiliary and control circuit	Yes
Mechanics/material	
Material of housing	plastic
Dimensions	
Width	45 mm
Height	106 mm
Depth	124 mm
Weights	
Weight	300 g

Ordering data**SIPLUS CMS2000 Basic Unit VIB**

Basic unit for monitoring vibrations in mechanical components based on characteristic values and frequency-selective analysis functions for measuring Category 0 according to EN 61010

Article No.**6AT8002-1AA00****Article No.****Shield connection**

For the EMC-compliant connection of signal and encoder cables to the basic unit VIB (packing unit = 2 pieces)

6AT8002-4AA00

Products for specific requirements

Condition monitoring systems

SIPLUS CMS2000 Condition Monitoring System

Expansion modules

Overview

SIPLUS CMS2000 VIB-MUX expansion modules and temperature modules can be connected to the SIPLUS CMS2000 Basic Unit VIB via the SIMOCODE system interface.

SIPLUS CMS2000 VIB-MUX expansion modules

Up to two SIPLUS CMS2000 VIB-MUX expansion modules can be connected to the SIPLUS CMS2000 Basic Unit VIB to expand the vibration channels. In this way, the number of vibration channels can be expanded modularly from 2 to a maximum of 16 channels.

The following configuration options are possible:

- Basic unit without expansion:
2 time-synchronous, continuously sampled vibration channels
- Basic unit with one SIPLUS CMS2000 VIB-MUX:
8 + 1: 8 channels via the SIPLUS CMS2000 VIB-MUX in multiplex mode, 1 channel continuous and independent of the channels connected on the SIPLUS CMS2000 VIB-MUX
- Basic unit with two SIPLUS CMS2000 VIB-MUX:
16 vibration channels in multiplex mode

SIMOCODE connecting cable for connecting the SIPLUS CMS2000 Basic Unit VIB to the SIPLUS CMS2000 VIB-MUX, see "Accessories".



SIPLUS CMS2000 VIB-MUX expansion module 6AT8002-2AA00

Temperature modules

Up to two temperature modules can be connected to the SIPLUS CMS2000 Basic Unit VIB.

Each temperature module has three inputs for the connection of up to three analog temperature sensors (sensor types: Pt100/Pt1000, KTY83/KTY84 or NTC).

SIMOCODE connecting cable for connecting the SIPLUS CMS2000 Basic Unit VIB to the temperature modules, see "Accessories".



Temperature module 3UF7700-1AA00-0

Technical specifications

Article number	6AT8002-2AA00 SIPLUS CMS2000 VIB-MUX
General information	
Product brand name	SIPLUS
Product designation	SIPLUS CMS2000 VIB-MUX
Product description	Up to two SIPLUS CMS2000 VIB-MUX expansion modules can be connected to the SIPLUS CMS2000 Basic Unit VIB. Up to 8 IEPE vibration channels can be connected for each expansion module.
Functional principle	Multiplexing of analog IEPE signals
Physical measuring principle	Vibration acceleration
Measurement range vibration frequency, min.	2 Hz
Measurement range vibration frequency, max.	10 000 Hz
Installation type/mounting	
Mounting type	standard rail
Mounting position	vertical
Recommended mounting position	vertical

Article number	6AT8002-2AA00 SIPLUS CMS2000 VIB-MUX
Supply voltage	
Type of supply voltage	DC
Rated value (DC)	24 V
Power	
Active power input, max.	2.4 W
Power loss	
Power loss, typ.	0.05 W
Digital outputs	
Number of digital outputs	1
Sensor input	
Number of IEPE sensor inputs	8
Number of MEMS sensor inputs	0
Interfaces	
SIMOCODE interface	Yes
Degree and class of protection	
IP degree of protection	IP20

Products for specific requirements

Condition monitoring systems

SIPLUS CMS2000 Condition Monitoring System

Expansion modules

Technical specifications (continued)

Article number	6AT8002-2AA00 SIPLUS CMS2000 VIB-MUX
Standards, approvals, certificates	
Certificate of suitability	CE, UL 508, CSA C22.2 Nr.142, C-TICK (RCM)
CE mark	Yes
RCM (formerly C-TICK)	Yes
KC approval	Yes
EAC (formerly Gost-R)	Yes
China RoHS compliance	Yes
Equipment marking according to EN 61346-2	P
Equipment marking according to DIN 40719, expanded according to IEC 204-2, according to IEC 750	P
Ambient conditions	
Ambient temperature during operation	
• min.	-20 °C
• max.	65 °C
Ambient temperature during storage/transportation	
• Storage, min.	-25 °C
• Storage, max.	85 °C
• Transportation, min.	-25 °C
• Transportation, max.	85 °C
Relative humidity	
• Operation without condensation, min.	5 %
• Operation without condensation, max.	95 %
Connection method	
Design of electrical connection for the inputs and outputs	Screw connection
Design of electrical connection for auxiliary and control circuit	Screw connection
• Connectable conductor cross-section, solid or stranded, min.	0.5 mm ²
• Connectable conductor cross-section, solid or stranded, max.	4 mm ²
• Connectable conductor cross-section, finely stranded with end sleeve, min.	0.5 mm ²
• Connectable conductor cross-section, finely stranded with end sleeve, max.	2.5 mm ²
• Connectable cable cross-section finely stranded without end sleeve, min.	0.5 mm ²
• Connectable cable cross-section finely stranded without end sleeve, max.	2.5 mm ²
Terminals	
• Removable terminal for main circuit	Yes
• Removable terminal for auxiliary and control circuit	Yes

Article number	6AT8002-2AA00 SIPLUS CMS2000 VIB-MUX
Mechanics/material	
Material of housing	plastic
Dimensions	
Width	45 mm
Height	106 mm
Depth	124 mm
Weights	
Weight	0.27 kg
Article number	3UF7700-1AA00-0
Product designation	temperature module
General technical data:	
Protection class IP	IP20
Ambient temperature	
• during storage	-40 ... +80 °C
• during operation	-25 ... +60 °C
• during transport	-40 ... +80 °C
Equipment marking	
• acc. to DIN 40719 extended according to IEC 204-2 acc. to IEC 750	A
• acc. to DIN EN 61346-2	B
Installation/ mounting/ dimensions:	
Installation altitude at height above sea level maximum	4 000 m
Mounting type	screw and snap-on mounting
Width	22.5 mm
Height	92 mm
Depth	124 mm
Inputs/ Outputs:	
Number of analog inputs	3
Connections:	
Type of electrical connection for auxiliary and control current circuit	screw-type terminals
Connectable conductor cross-section for auxiliary contacts	
• single or multi-stranded	0.5 ... 4
• finely stranded	
- with core end processing	0.5 ... 2.5
- without core end processing	0.5 ... 2.5
Standards:	
Certificate of suitability	CE / UL / CSA / CCC / C-Tick (RCM) / GOST / NOM / ABS / DNV / GL / LRS / RoHS

Ordering data

SIPLUS CMS2000 VIB-MUX expansion modules

Up to two expansion modules can be connected to the SIPLUS CMS2000 Basic Unit VIB.
Up to 8 IEPPE vibration channels can be connected for each expansion module.

Article No.

6AT8002-2AA00

Article No.

Temperature modules

Up to two temperature modules can be connected to the SIPLUS CMS2000 Basic Unit VIB.

3UF7700-1AA00-0

Products for specific requirements

Condition monitoring systems

SIPLUS CMS2000 Condition Monitoring System

Accessories

Overview

SIMOCODE connecting cables

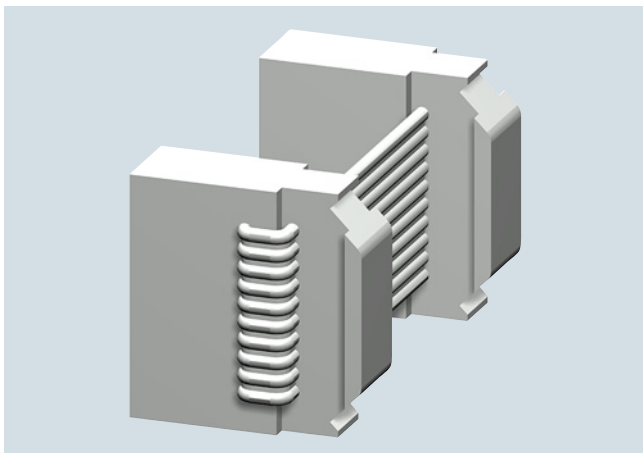

SIMOCODE connecting cable 3UF7930-0AA00-0

The connecting cable is used for connecting the SIPLUS CMS2000 Basic Unit VIB to the SIPLUS CMS2000 VIB-MUX expansion modules and the temperature modules via the SIMOCODE system bus interface.

The connecting cable with a length of 0.025 m must be used for side-by-side mounting of the basic unit and SIPLUS CMS2000 VIB-MUX expansion modules or temperature modules on a TH 35-15 standard DIN rail in accordance with IEC 60715.

Shield connection

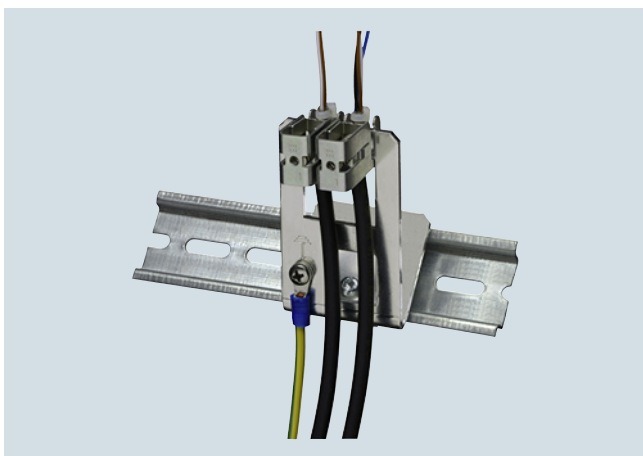

6AT8002-4AA00 shield connection

A separate shield connection must be ordered for the EMC-compliant connection of signal and encoder cables to the SIPLUS CMS2000 Basic Unit VIB and the SIPLUS CMS2000 VIB-MUX expansion module.

The shield connection comprises two shield clamps and five terminal clamps. One shield clamp each is attached to the DIN rail above and below the basic unit. The sensor cable shields are connected to the shield clamps by means of the terminal clamps.

VIB-SENSOR S01 vibration sensor



VIB-SENSOR S01 vibration sensor 6AT8002-4AB00

The VIB-SENSOR S01 vibration sensor with IEPE (integrated electronics piezo-electric) interface can be directly connected to the SIPLUS CMS2000 Basic Unit VIB and the SIPLUS CMS2000 VIB-MUX expansion module.

The sensor detects vibration accelerations in the frequency range from 0.5 Hz to 15 kHz with a resolution of 100 mV/g.

A threaded screw with an M8 male thread for mounting to the measuring point is included in the scope of delivery. The connecting cable is connected to the vibration sensor via the MIL connector.

CABLE-MIL connecting cables



CABLE-MIL connecting cables 6AT8002-4AC03, 6AT8002-4AC10

The VIB-SENSOR S01 vibration sensor is connected to the SIPLUS CMS2000 Basic Unit VIB or the SIPLUS CMS2000 VIB-MUX expansion module by means of the CABLE-MIL connecting cable.

This high-quality industrial cable is made of black polyurethane and is pre-assembled on one end with a MIL connector (MIL-C5015). The open cable end of the shielded two-wire cable is connected directly to the screw terminals of the basic unit.

The connecting cable is available in lengths of 3 m and 10 m.

Products for specific requirements

Condition monitoring systems

SIPLUS CMS2000 Condition Monitoring System

Accessories

Technical specifications

Article number	6AT8002-4AA00 CMS2000 SHIELD CONNECTION ACCESSORY	
General information		
Product brand name	SIPLUS	
Product designation	SIPLUS CMS2000 shield support	
Product description	For the EMC-compliant connection of signal and encoder cables to the SIPLUS CMS2000 Basic Unit VIB or the SIPLUS CMS2000 VIB-MUX expansion module	
Installation type/mounting		
Mounting type	standard rail	
Connection method		
Number of signal cables connectable to the shield support	3	
Article number	6AT8002-4AC03	6AT8002-4AC10
	SIPLUS CMS2000 CABLE 3m	SIPLUS CMS2000 CABLE 10m
General information		
Product brand name	SIPLUS CMS	
Product category	Industrial cable	
Product designation	Connecting cable CABLE-MIL-300	Connecting cable MIL-CABLE-1000
Product description	For connection of the VIB-SENSOR S01 vibration sensor to the SIPLUS CMS2000 Basic Unit VIB or the SIPLUS CMS2000 VIB-MUX expansion module	
Cables		
Type of insulation	black polyurethane	
Design of shield	Braided shielding with stranded drain wire	
Cable length	3 m	10 m
Connection method		
Type of connection	MIL-C5015 / open cable end	

Article number	6AT8002-4AB00 SIPLUS CMS2000 VIB-SENSOR S01	
General information		
Product brand name	SIPLUS CMS	
Product designation	VIB SENSOR S01	
Product description	Piezoelectric sensor for connection to the SIPLUS CMS2000 Basic Unit VIB or the SIPLUS CMS2000 VIB-MUX expansion module	
Physical measuring principle	Piezo-quartz recorder with integrated evaluation electronics	
Operating range of sensor at +/- 3 dB, min.	0.5 Hz	
Operating range of sensor at +/- 3 dB, max.	15 000 Hz	
Measurement range vibration acceleration, max.	50 gn	
Sensitivity, typ.	100 mV/gn	
Resolution of measured value of vibration acceleration, min.	0.002 gn	
Resonance frequency	23 kHz	
Installation type/mounting		
other mounting	incl. mounting bolts UNF1/4-28 on M8	
Input current		
Type of power supply	IEPE 2 to 10 mA	
Sensor input		
Encoder signals, IEPE		
• Signal voltage (DC), min.	10 V	
• Signal voltage (DC), max.	14 V	
Degree and class of protection		
IP degree of protection	IP65	
Cables		
Cable length, max.	80 m	
Connection method		
Type of connection	MIL-C5015	
Mechanics/material		
Material of housing	Stainless steel	

Ordering data

SIMOCODE connecting cable
For side-by-side mounting of SIPLUS CMS2000 Basic Unit VIB and SIPLUS CMS2000 VIB-MUX expansion modules or 3UF7700-1AA00-0 temperature modules

Article No.
3UF7930-0AA00-0

SIPLUS CMS2000 shield connection
For the EMC-compliant connection of signal and encoder cables to the SIPLUS CMS2000 Basic Unit VIB or to the SIPLUS CMS2000 VIB-MUX expansion module

Article No.
6AT8002-4AA00

VIB-SENSOR S01 vibration sensor
Piezoelectric sensor for connection to the SIPLUS CMS2000 Basic Unit VIB or to the SIPLUS CMS2000 VIB-MUX expansion module

Article No.
6AT8002-4AB00

CABLE-MIL connecting cable
For connection of the VIB-SENSOR S01 vibration sensor to the SIPLUS CMS2000 Basic Unit VIB or to the SIPLUS CMS2000-VIB-MUX expansion module

- CABLE-MIL-300 connecting cable, 3 m long
- CABLE-MIL-100 connecting cable, 10 m long

Article No.
6AT8002-4AC03

Article No.
6AT8002-4AC10

Products for specific requirements

Time synchronisation

Introduction

Overview



SICLOCK time synchronization

Introduction

In many applications it is becoming increasingly important to synchronize the time in plants and systems. Only if all network stations are supplied cyclically with a reliable time frame from a central location can optimum process operation be ensured. This results in benefits for the plant operator such as increased operational reliability, the possibility of tracing system faults in a targeted manner, increased economic efficiency due to fewer production outages, and increased productivity in manufacturing.

For this purpose, the SICLOCK product family offers a comprehensive range of optimally matched components for setting up highly reliable time synchronization systems.

Typical industries and fields of application for time synchronization systems are:

- Factory/process automation
- Power supply
- Building automation
- Transportation systems
- Safety engineering
- IT systems

The SICLOCK product range comprises the following product groups:

- Wireless receivers
- Central plant clocks
- Pulse converters
- Accessories

System description

Satellites or long-wave transmitters are used as primary time sources. The SICLOCK wireless receivers (e.g. SICLOCK GPS1000) receive these high-frequency signals and transmit the demodulated time signal to the central plant clock via a robust and interference-proof 2-wire connection.

The central plant clock converts the time signal into an Ethernet-based network frame (e.g. NTP, SIMATIC procedure) and thus provides all connected network stations with precise and uniform time information.

Furthermore, in the event of failure or loss of reception from the primary time source, the central plant clock ensures stable continuation of the clock time and tracking of the system time without time jumps as soon as reception is restored.

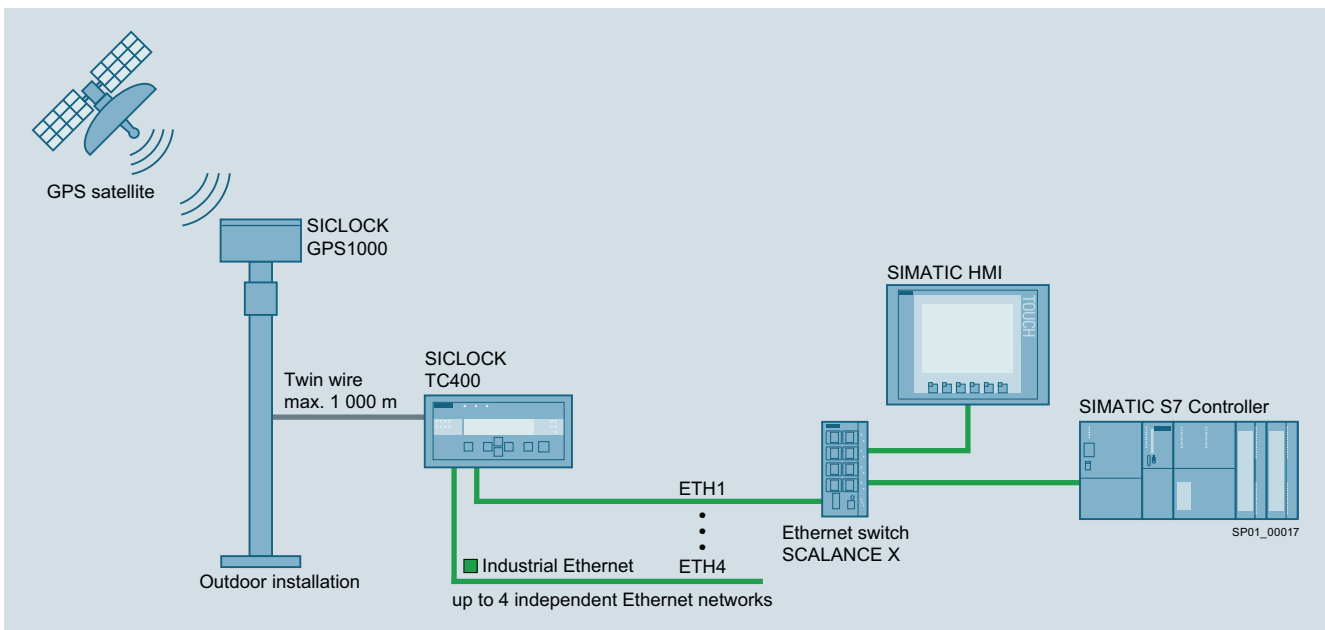

SICLOCK TC400 central plant clock with SICLOCK GPS1000 wireless receiver

Overview

The central plant clocks evaluate the clock time data that is transmitted from the wireless receiver and generate diverse output signals in order to synchronize the connected I/O devices.

If the wireless receiver fails or signal transmission is interrupted, the central plant clocks switch over to their internal high-precision quartz system and thus ensure reliable tracking of the clock time. When the input signal is available again, the central plant clock adjusts any time differences that may have occurred without time jumps by means of "microsteps".



SICLOCK TC100 and SICLOCK TC400 central plant clocks

Inputs and outputs

The high-precision SICLOCK TC100 and SICLOCK TC400 central plant clocks have one (SICLOCK TC100) or two (SICLOCK TC400) inputs for connection to wireless receivers.

The central plant clocks have one (SICLOCK TC100) or four (SICLOCK TC400) independent 10/100 Mbit Ethernet interfaces.

The network stations are synchronized using the proven SNTP standard and by means of the SIMATIC procedure.

The SICLOCK central plant clocks have two relay outputs for signaling alarms or warnings.

Alternatively and/or in addition, two TTY point-to-point connections (20 mA current interface) or one RS 422 (5 V level) connection can be set up for the SICLOCK TC400 central plant clock.

Operation

Parameterization of the interfaces, setting of the signal types, redundancy modes, and read-out of the status messages stored in the device are conveniently implemented via the integrated web interface.

LEDs and a display indicate operating states and show any error messages, which can also be read out via the web interface.

Note:

In order to use the comfort parameterization, you have to use a PC with Java Runtime software V1.4.0 or higher from Oracle. This software is not included in the scope of delivery and has to be acquired separately, which may incur additional cost.

Technical specifications

Article number	2XV9450-2AR22	2XV9450-2AR01
	SICLOCK_TC100_ Device	SICLOCK_TC400_ Single device
General information		
Product brand name	SICLOCK	
Product type designation	TC100	TC400
Product designation	Central plant clock	
Installation type/mounting		
Mounting type	DIN rail 35 mm or 19 inch rack	
Supply voltage		
Supply voltage (DC)	24 V	
Relative negative tolerance	15 %	
Relative positive tolerance	20 %	
Mains buffering		
• Buffering time, max.	3 ms	
Input current		
Continuous rated current, max.	0.5 A	0.7 A
Operating current of fuse protection at input, slow-blow	1 A	
Output current		
Design of outputs for supply of the antenna	20 mA to 40 mA at 48 V	
Power		
Power consumption, max.	9 W	15 W
Power loss		
Power loss, typ.	6 W	7.5 W

Article number	2XV9450-2AR22	2XV9450-2AR01
	SICLOCK_TC100_ Device	SICLOCK_TC400_ Single device
Time of day		
Design of the inputs	1x GPS1000 / DCFRS time input 48 V / 40 mA	2x GPS1000 / DCFRS time input 48 V / 40 mA
Clock		
• Time deviation relative to GPS signal, max.	50 µs	
• Time deviation relative to DCF77 signal, max.	1 000 µs	
• Time deviation of the GPS signal with jitter, max.	200 ns	
• Relative accuracy on loss of GPS signal, max.	0.0001 %	
• Relative accuracy on loss of DCF77 signal, max.	0.000001 %	
• Relative accuracy on power supply failure, max.	0.0004 %	
• Clock error compensation relative to 1 s	50 µs	
Digital outputs		
Relay outputs		
• Number of relay outputs		
- as NC contact for ALARM	1	
- as NC contact for WARNING	1	
Switching capacity of contacts		
- Current carrying capacity at 48 V DC	0.06 A	

Products for specific requirements

Time synchronisation

Wireless receivers

Central plant clocks

Technical specifications (continued)

Article number	2XV9450-2AR22 SICLOCK_TC100_ Device	2XV9450-2AR01 SICLOCK_TC400_ Single device
Interfaces		
Number of industrial Ethernet interfaces	1	4
Number of 20 mA interfaces (TTY)		
• As output		2
Number of RS 422 interfaces		
• As output		1
Industrial Ethernet		
• Transmission rate, min.	10 Mbit/s	
• Transmission rate, max.	100 Mbit/s	
Interface types		
RJ 45 (Ethernet)		
• Autonegotiation	Yes	
Protocols		
Bus protocol/transmission protocol	(S)NTP, DCF77	(S)NTP, DCF77, pulses, cycles, message frames
Potential separation		
between Ethernet and electronics	Yes	
Degree and class of protection		
IP degree of protection	IP20	
Equipment protection class	III (according to EN 60536)	
Standards, approvals, certificates		
Standard for EMC	EN 55022 Class A, FCC Class, EN 55024	
Standard for ambient influences		
• During operation	EN 60721-3-3 class 3K5	
• During storage	EN 60721-3-2 class 2K4	
• Relative humidity during operation	IEC 60068-2-78, IEC 60068-2-30	
• Relative humidity during storage	IEC 60068-2-78, IEC 60068-2-30	

Article number	2XV9450-2AR22 SICLOCK_TC100_ Device	2XV9450-2AR01 SICLOCK_TC400_ Single device
Ambient conditions		
Ambient temperature during operation		
• min.	0 °C	
• max.	55 °C	
• Permissible temperature change relative to one hour (without condensation)	10 °C	
Ambient temperature during storage/transportation		
• Storage, min.	-40 °C	
• Storage, max.	70 °C	
• Permissible temperature change relative to one hour (without condensation)	20 °C	
• Transportation, min.	-40 °C	
• Transportation, max.	70 °C	
Air pressure acc. to IEC 60068-2-13		
• permissible range, lower limit	795 hPa	
• permissible range, upper limit	1 080 hPa	
• Installation altitude, min.	-1 000 m	
• Installation altitude, max.	2 000 m	
Relative humidity		
• Operation at 25 °C without condensation, min.	10 %	
• Operation at 25 °C without condensation, max.	95 %	
• Storage at 25 °C without condensation, min.	10 %	
• Storage at 25 °C without condensation, max.	95 %	
Mechanics/material		
Service life		
• Battery (during operation), min.	10 y	12 y
• Battery unconnected (during storage), min.	10 y	12 y
• Battery connected (during storage), min.	6 y	
Dimensions		
Width	180 mm	
Height	89 mm	
Depth	47 mm	

Ordering data

Central plant clock

A wireless receiver supplies the central plant clocks with time data; these then generate signals which are used to synchronize the connected I/O devices.

SICLOCK TC400 central plant clock, single device

- 4 independent Ethernet interfaces
- 2 DCF77 inputs for antennas
- 2 DCF77 outputs for redundancy and extensions

Article No.

2XV9450-2AR01

Article No.

SICLOCK TC100 central plant clock, single device

- 1 Ethernet interface
- 1 DCF77 input for antennas

2XV9450-2AR22

Overview



SICLOCK GPS2000 wireless receiver with antenna base

The SICLOCK GPS1000 wireless receiver is designed to receive signals on the 1.575 GHz frequency from the GPS satellite system. The wireless receiver generates the time information (UTC – coordinated universal time) from this high-frequency signal and converts it on the output side into the DCF77 time signal. The wireless receiver can be used all over the world.

The SICLOCK GPS1000 wireless receiver is designed for direct connection to the SICLOCK TC100 and SICLOCK TC400 central plant clocks. The line current method used permits a distance of up to one kilometer between the wireless receiver and the central plant clock.

The antenna has to be installed outdoors for optimum reception of the satellite signals. The wireless receiver needs no parameter assignment or maintenance and, when used with the SICLOCK TC100 or SICLOCK TC400 central plant clocks, is supplied by them with the required operational energy.

The 2XV9450-1AR82 package is available for the direct synchronization of PCs. This package also includes the SICLOCK GPS1000 PS pulse converter for level conversion and the receiving software, which runs on PCs.

Note:

When ordering SICLOCK GPS1000 and bundles with GPS1000, the corresponding product will be delivered with SICLOCK GPS2000. SICLOCK GPS2000 is fully compatible with SICLOCK GPS1000. In the event of repairs, SICLOCK GPS2000 will be supplied as a replacement.

Technical specifications

Article number	2XV9450-1AR88-0AA0	2XV9450-1AR88-0AB0
	GPS2000 wireless receiver Cable length 2.5	GPS2000 wireless receiver Cable length 20m
General information		
Product brand name	SICLOCK	
Product type designation	GPS2000	
Product designation	GPS satellite receiver with TTY interface	
Installation type/mounting		
Mounting type	Outdoor installation	
Supply voltage		
Type of power supply	via basic unit	
Power		
Power consumption, max.	1 W	
Time of day		
Signal type	GPS	
Electrical input frequency of the antenna	1 574 MHz	
Clock		
• Time deviation relative to master clock, max.	1 000 µs	
Interfaces		
Number of 20 mA interfaces (TTY)		
• As output	1	
Degree and class of protection		
IP degree of protection	IP65	

Article number	2XV9450-1AR88-0AA0	2XV9450-1AR88-0AB0
	GPS2000 wireless receiver Cable length 2.5	GPS2000 wireless receiver Cable length 20m
Ambient conditions		
Ambient temperature during operation		
• min.	-40 °C	
• max.	60 °C	
Cables		
Length of the connecting cable	2.5 m	20 m
Connection method		
Design of electrical connection for the connecting cable	2x 1 mm ² shielded	
Dimensions		
Width of antenna head	160 mm	
Height of antenna head	85 mm	
Depth of antenna head	80 mm	
Width of attachment frame	160 mm	
Height of attachment frame	630 mm	

Products for specific requirements

Time synchronisation

Wireless receivers

GPS receivers

Ordering data	Article No.	Article No.
<p>GPS receivers</p> <p>SICLOCK GPS2000</p> <p>GPS radio clock for the time synchronization of PCs, programmable controllers, as well as the SICLOCK TC100 and SICLOCK TC400 central plant clocks</p> <ul style="list-style-type: none"> • Single device with 2.5 m connecting cable • Single device with 20 m connecting cable 	<p>2XV9450-1AR88-0AA0</p> <p>2XV9450-1AR88-0AB0</p>	<p>SICLOCK GPS2000 package with power supply</p> <p>GPS radio clock for the time synchronization of PCs as well as programmable controllers via RS 232 interface; in industrial environments with high levels of interference; for distances up to 1 000 m between the antenna and the device</p> <p>Package comprises</p> <ul style="list-style-type: none"> • SICLOCK GPS2000 GPS wireless receiver with 2.5 m connecting cable and lightning protection, extendable to 1 000 m • Lightning protection module 2XV9450-1AR83 • SICLOCK GPS1000 power supply 2XV9450-1AR85-0AA2 • Antenna holding frame for universal mounting • Distribution socket for connecting the control cable
<p>SICLOCK GPS2000 package with lightning protection</p> <p>GPS radio clock for the time synchronization of PCs, programmable controllers, as well as the SICLOCK TC100 and SICLOCK TC400 central plant clocks</p> <p>Package comprises</p> <ul style="list-style-type: none"> • GPS2000 wireless receiver with integrated electronics 2XV9450-1AR88-0AA0 • 2.5 m connecting cable with end sleeves • Lightning protection module 2XV9450-1AR83 	<p>2XV9450-1AR84-0AA0</p>	<p>SICLOCK GPS2000 package with 20 m connecting cable</p> <p>GPS radio clock for time synchronization with 20 m connecting cable for combination with GPS1000PS, TC100, TC400, PCON and EOPC</p> <p>Package comprises</p> <ul style="list-style-type: none"> • GPS2000 wireless receiver with integrated electronics • 20 m connecting cable with end sleeves, extendable to 1 000 m • Lightning protection module 2XV9450-1AR83 • Antenna holding frame for universal mounting • Distribution socket for connecting the control cable • Connecting cable to PC COM port (9-pin sub D) • CD containing operating instructions (German/English)
		<p>2XV9450-1AR82-0AA0</p> <p>2XV9450-2AR82-0AB0</p>

Overview

The pulse converter is available in three versions:

- SICLOCK PCON
- SICLOCK EOPC
- SICLOCK GPS1000 PS



SICLOCK GPS1000 PS, SICLOCK PCON and SICLOCK EOPC pulse converters

SICLOCK PCON pulse converter

The SICLOCK PCON is a single-channel, electrical-optical pulse converter. It enables electrical and optical time frames and pulses to be distributed.

The device has three inputs for electrical signals (RS 422, RS 232, etc.), one optical input, as well as five electrical outputs and one optical output. By using fiber-optic cables, longer distances can be bridged with very high interference immunity.

The SICLOCK PCON pulse converter can be operated in two modes:

- In transparent mode, the input signal is output at all outputs without any change.
- In pulse mode, an edge change at the input triggers a pulse with parameterizable length at all outputs.

The device is easily parameterized by means of DIP switches located directly on the device.

Inputs X1	Outputs X2
RS 422 (non-isolated)	RS 422 (non-isolated)
RS 232 (non-isolated)	RS 232 (non-isolated)
Pulse input 5 ... 35 V or 5 ... 70 V	Pulse output 24 V (non-isolated)
	Pulse output 24 ... 220 V (isolated)
FOC	FOC
BFOC connection system	BFOC connection system
	TTY 20 mA current interface

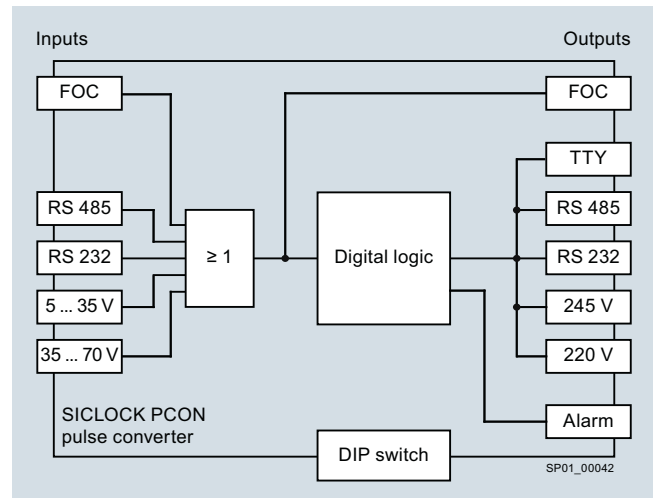

SICLOCK PCON pulse converter (functional diagram)

SICLOCK EOPC pulse converter

The SICLOCK EOPC is an electrical-optical converter and hub. It features two electrical inputs, which can be alternatively used, and transfers these signals at its 32 fiber-optic outputs. This pulse converter is therefore the ideal choice for applications with numerous nodes with optical pulse interface which have to be synchronized.

Inputs X1	Outputs
TTY 20 mA current interface	32 x BFOC 62.5/125 μm
Pulse input 10 ... 65 V	

Products for specific requirements

Time synchronisation

Pulse converters

Technical specifications

Article number	2XV9450-1AR72	2XV9450-1AR63-1SA3
	SICLOCK EOPC 24-60V DC	SICLOCK PCON E10433-E0415- H100
General information		
Product brand name	SICLOCK	
Product type designation	EOPC 24 V DC	PCON 24 - 230 V AC/DC, multimode
Product designation	Pulse converter	
Installation type/mounting		
Mounting type	DIN rail 35 mm or 19 inch rack	DIN rail 35 mm
Supply voltage		
permissible range, lower limit (DC)	20 V	24 V
permissible range, upper limit (DC)	28 V	230 V
permissible range, lower limit (AC)		24 V
permissible range, upper limit (AC)		230 V
Number of electrical connections for redundant power supply	2	
Power		
Power consumption, max.	60 W	
Digital inputs		
Number of voltage inputs	1	
Design of voltage inputs	10 - 60 V / 5 mA	5 - 35 V or 5 - 70 V
Number of inputs for FOC		1
Digital outputs		
Number of outputs (24 V DC)		1
Number of outputs (24 V ... 230 V AC/DC)		1
Number of outputs for FOC	32	1
Output current		
• For output (24 V DC)		0.8 A
• For output (24 V ... 230 V AC/DC)	6 A	0.1 A
Relay outputs		
• Number of relay outputs - As changeover contact for ALARM		1

Article number	2XV9450-1AR72	2XV9450-1AR63-1SA3
	SICLOCK EOPC 24-60V DC	SICLOCK PCON E10433-E0415- H100
Interfaces		
Number of RS 485 interfaces		
• As input		1
• As output		1
Number of 20 mA interfaces (TTY)		
• As input	2	
• As output		1
Number of RS 232 interfaces		
• As input		1
• As output		1
Degree and class of protection		
IP degree of protection	IP20	IP40
Ambient conditions		
Ambient temperature during operation		
• min.	0 °C	
• max.	50 °C	
Connection method		
Design of the FOC connection	BFOC	
Mechanics/material		
Design of the FOC	Glass fiber 62.5/126 µm, plastic 1 000 µm	
Material of optical fiber	Glass, plastic	
Dimensions		
Width	250 mm	100 mm
Height	140 mm	70 mm
Depth	135 mm	120 mm

Ordering data

Pulse converters	Article No.
SICLOCK PCON	2XV9450-1AR63-1SA3
Single-channel, electrical-optical pulse converter for industrial applications, 820 nm, 24 ... 230 V AC/DC, with multimode fiber-optic connection	

SICLOCK EOPC	Article No.
2XV9450-1AR72	
Electrical-optical pulse converter for industrial applications with 32 fiber-optic cable outlets for transparent operation and pulse mode, 24 ... 110 V DC	

Overview

Software

For less complex applications, the wireless receivers can even be operated without central plant clocks.

Two software packages are available for such applications to process the time information on Windows computers or in a SIMATIC PLC.

- 2XV9450-1AR28: SICLOCK DCF77 receiving service software for Windows XP, Windows Vista, Windows 7, Windows Server 2003/2008/2008 R2

Lightning protection

The 2XV9450-1AR83 lightning protection element is integrated by default into the connecting cable downstream of the wireless receiver and protects the components connected to it against overvoltage caused by lightning strikes.

Mounting hardware

For easy installation in 19" rack units, a 2XV9450-2AR81 mounting frame for two SICLOCK TC100 and/or SICLOCK TC400 central plant clocks each is available.

Technical specifications

Article number	2XV9450-2AR81	2XV9450-1AR28	2XV9450-1AR83
	SICLOCK TC400 19" kit	SICLOCK DCF77 DRIVER FOR WINDOWS	SICLOCK GPS1000 LIGHTNING PROTECTION
General information			
Product brand name	SICLOCK		
Product designation	19 inch frame for SICLOCK TC400 / TC100	DCF77 receiver software for Windows	Lightning protection for GPS1000 or DCFRS radio clock
Installation type/mounting			
19-inch installation	Yes		
Number of modular height units	3		
Time of day			
Signal type			
• At the input			
• At the output	DCF77		
Digital inputs			
Number of digital inputs	1		
Digital outputs			
Number of digital outputs	1		
Operating systems			
Required operating system	Microsoft Windows XP, Windows Vista, Windows 7, Windows Server 2003, Windows Server 2008/2008 R2		

Ordering data

	Article No.	Article No.
Accessories		
Software		
• Receiving service software for Windows	2XV9450-1AR28	
Lightning protection for antenna cable	2XV9450-1AR83	
Lightning protection for TTY connecting cable for SICLOCK GPS1000 or SICLOCK DCFRS wireless receivers		
		Mounting frame for SICLOCK TC100 and SICLOCK TC400 central plant clocks
		2XV9450-2AR81

Products for specific requirements

Time synchronisation

Bundles

Overview

The SICLOCK TC100 and SICLOCK TC400 central plant clocks can be operated with the SICLOCK GPS1000 or SICLOCK DCFRS wireless receivers.

With the bundles you order the complete unit comprising: the central plant clock, the antennas/wireless receivers and the accessories required.

Ordering data

Article No.

SICLOCK TC400 bundle

Complete solution, e.g. for use in PCS 7, package comprises

- SICLOCK TC400
- SICLOCK GPS2000 antenna with 2.5 m connecting cable, mounted, extendable to 1 000 m
- Antenna frame
- Distribution socket
- Lightning protection

2XV9450-2AR10-0AA0

SICLOCK TC100 bundle

Complete solution, e.g. for use in PCS 7, package comprises

- SICLOCK TC100
- SICLOCK GPS2000 antenna with 2.5 m connecting cable, mounted, extendable to 1 000 m
- Antenna frame
- Distribution socket
- Lightning protection

2XV9450-2AR50-0AA0

Overviews



14/2	SIMATIC HMI
14/4	PC-based Automation
14/5	SIMATIC PCS 7
14/8	SIMATIC NET
14/10	SIMATIC Ident

Brochures

For brochures serving as selection guides for SIMATIC products, refer to:

www.siemens.com/simatic/printmaterial

Overviews

SIMATIC HMI

Introduction

Overview



SIMATIC HMI operator control and monitoring systems – efficient machine-level operator control and monitoring

Equipment for monitoring and operator control is needed wherever people have to work with or on machinery and plants performing diverse tasks from cylinder driers to waste compactors. It is not difficult to find the right device for your specific task. The challenge is to find a solution that is future-proof and flexible, that can be integrated into higher-level networks, and that can also meet the ever-increasing demands for transparency and data provision. SIMATIC HMI Panels have proven their value in a variety of different applications in all industrial sectors over many years. The range of the systems in use is just as wide as that of the applications and technologies in the respective plants.

SIMATIC HMI stands for highly efficient machine-level operator control and monitoring and has some unique advantages:

- Efficient engineering
Visualization can be created more quickly and easily than ever before.
- Innovative design and operation
Visualization becomes the outstanding feature of the machine.
- Brilliant HMI operator panels
The right HMI operator panel for every application.
- Backup – with security
Protection for investments and know-how, secure operation.
- Commissioning in the fast lane
Lose no time with testing and servicing.

www.siemens.com/hmi

SIMATIC HMI software in the TIA Portal – a lot more than just visualization software

With the product families SIMATIC WinCC (TIA Portal), SIMATIC WinCC and SIMATIC WinCC Open Architecture, SIMATIC HMI covers the entire engineering and visualization software spectrum for the human machine interface.

- Almost the entire range of SIMATIC operator panels can be configured with SIMATIC WinCC (TIA Portal), the successor to SIMATIC WinCC flexible.
The functionality covers both visualization tasks at machine level and SCADA applications on PC-based multi-user systems.
- The current version 7.4 of SIMATIC WinCC is available for extremely complex process visualization tasks and SCADA applications, e.g. taking account of redundant solutions and vertical integration all the way to plant intelligence solutions.
- And, last but not least, WinCC Open Architecture addresses applications with high customer-specific demand for adaptation and specialized functional scope, even on non-Windows platforms.

www.siemens.com/wincc-tia-portal

SIMATIC HMI - Brilliant and rugged operator panel

Basic HMI - for the entry level

- Key Panels
Pre-assembled and ready for installation, for conventional operator panels.
<http://www.siemens.com/key-panels>
- Basic Panels
The entry level series for simple HMI applications.
<http://www.siemens.com/basic-panels>

Panel-based HMI Advanced - for more sophistication

- Comfort Panels
High-end functionality for demanding HMI applications.
<http://www.siemens.com/comfort-panels>
- Mobile Panels
Portable HMI operator panels for mobile deployment on site.
<http://www.siemens.com/mobile-panels>

Individual HMI devices in customized versions

<http://www.siemens.com/customized-automation>

Overview (continued)

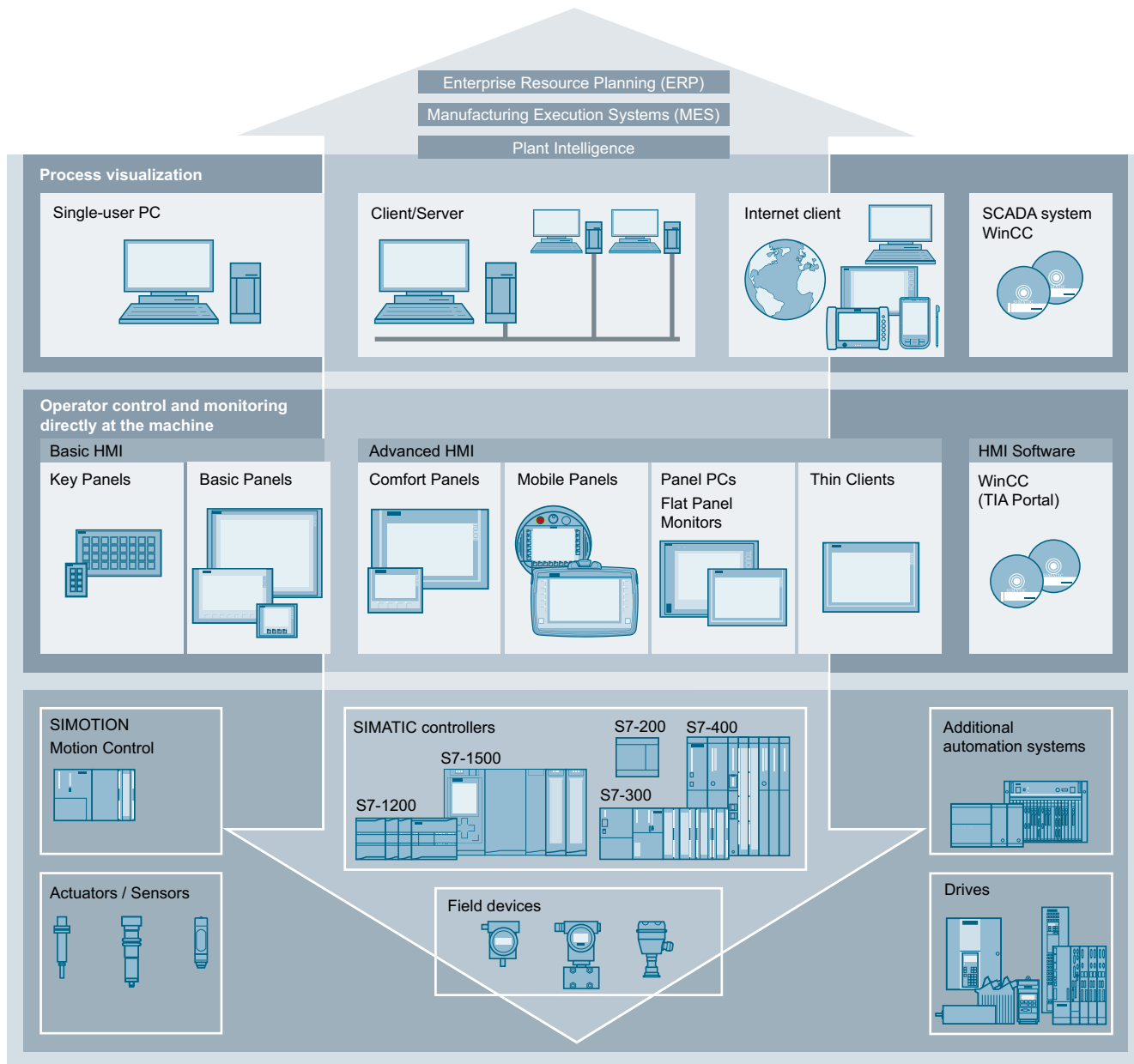

Overviews

PC-based Automation

Introduction

Overview

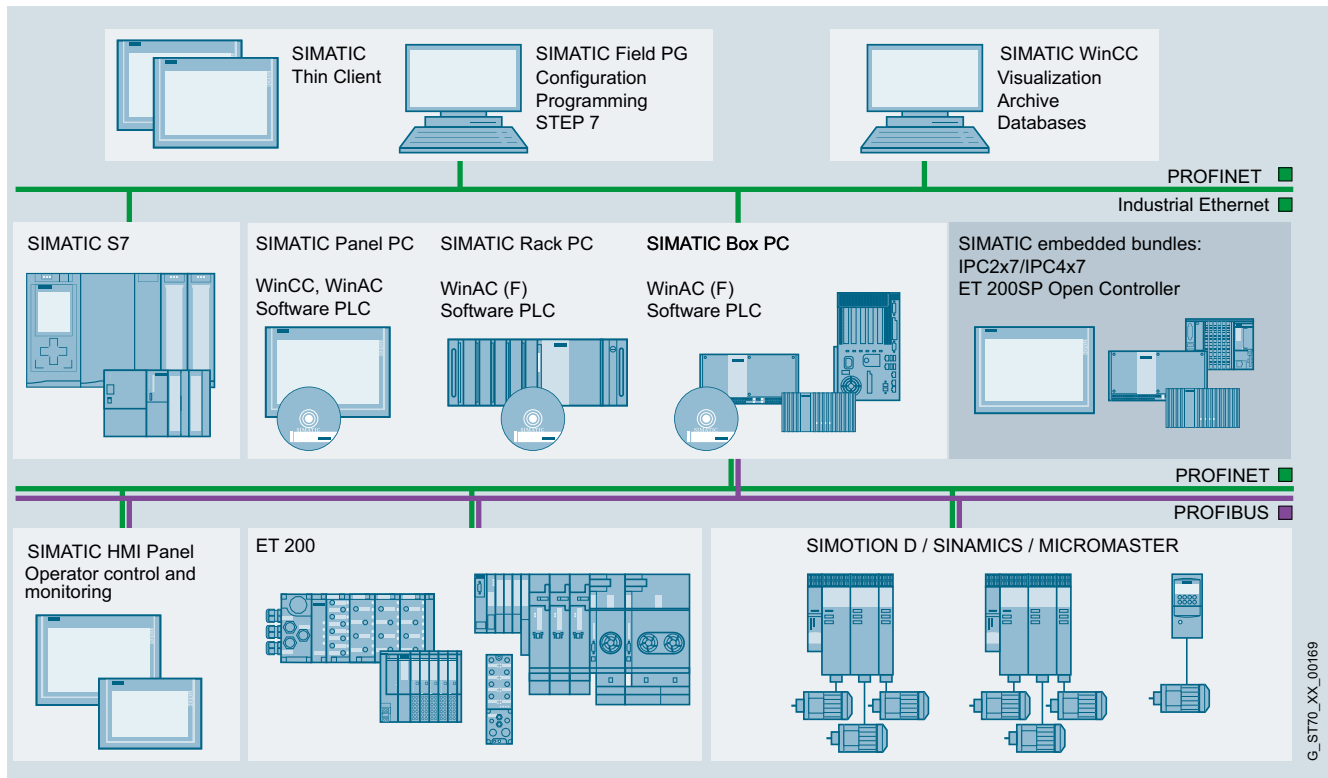

SIMATIC PC-based Automation

<http://www.siemens.com/pc-based>

Industrial IoT Gateway - SIMATIC IOT2000

An intelligent gateway which harmonizes communication between the various sources of data before analyzing and forwarding it to the corresponding recipients. An easy-to-implement solution.

www.siemens.com/iot2000

Industrial PC

Our reliable and innovative industrial PCs are the optimal PC hardware platform for PC-based Automation from Siemens.

- Rack PC
- Box PC
- Panel PC
- Tablet PC
- Industrial monitors and Thin Clients
- Devices for special requirements
 - Fully-enclosed IP65 devices
 - Devices with stainless steel front
 - Devices for hazardous areas
- IPC software
- Embedded bundles/software packages

www.siemens.com/simatic-ipc

Software Controller

The SIMATIC S7-1500 Software Controller realizes a SIMATIC S7-1500 controller on a SIMATIC IPC. It is particularly suitable for control solutions in special-purpose machine manufacturing which involve a high-performance implementation of complex control tasks, the integration of PC applications, or the realization of multiple tasks on a single device.

PC-based controllers

PC-based controllers combine the functions of a PC-based software controller with visualization, PC applications and central I/Os (inputs/outputs) in a single, compact device. The SIMATIC ET 200SP Open Controller is an industrial PC with the design of the ET 200SP I/O system and a pre-installed S7-1500 Software Controller.

www.siemens.com/open-controller

G_ST70_XX_00169

Overview

SIMATIC PCS 7 system architecture

Performance you trust

In process engineering plants, the process control system is the starting point for optimal value added: All procedures and processes can be operated, monitored and influenced with the process control system.

The more powerful the process control system, the more effectively this potential can be used. For this reason, performance is in the foreground with SIMATIC PCS 7, alongside scalability, flexibility, and integration. Starting with planning and engineering, the process control system offers powerful tools, functions and features for cost-effective and efficient plant operation through all phases of the plant life cycle.

Performance through integration

Integration is one of the special strengths of SIMATIC PCS 7. This has many aspects:

- Horizontal integration into TIA
- Vertical integration into hierarchical communication
- System-integrated tools for engineering tasks
- Integration of the field level, including drives, switchgear, etc.
- Integrated functions, e.g. for batch process automation, route control, process safety, energy management, telecontrol tasks, etc.

Horizontal integration

A system for integrated automation of the entire process chain, from incoming raw materials to outgoing goods – this is one of the decisive advantages resulting from the seamless integration of SIMATIC PCS 7 into Totally Integrated Automation.

The process control system is mainly responsible for automating the primary processes here, but it can do much more: All auxiliary facilities, as well as the electrical infrastructure in the form of low-voltage or medium-voltage switchgear and the building management system, can also be integrated into the system.

Integration of selected SIMATIC standard components – automation systems, industrial PCs, network components, or distributed process I/O – into the process control system guarantees optimum interaction of individual components, and secures economic benefits such as simple selection, reduced stock keeping, and global support.

Vertical integration

The hierarchical communication of a company encompasses the field level, the control level, and the process level, up to management and enterprise resource planning (ERP). Thanks to standardized interfaces – based on international industry standards as well as internal interfaces – SIMATIC PCS 7 is able to provide process data for analysis, planning, coordination, and optimization of plant sequences or production and business processes – in real time, and at any location in the company.

Overviews

SIMATIC PCS 7

Introduction

Overview (continued)

Central engineering

SIMATIC PCS 7 convinces with graded functional diversity, consistent operator control philosophy, and uniformly structured engineering and management tools. A central engineering system with a coordinated range of tools for integrated system engineering and configuring of batch automation, safety functions, material transport or telecontrol systems creates value added over the entire life cycle. Reductions in configuring and training costs result in minimization of total cost of ownership (TCO) over the entire plant life cycle.

Functional diversity

Depending on the typical process automation or customer-specific requirements, SIMATIC PCS 7 can be functionally expanded for the following, for example:

- Batch process automation (SIMATIC BATCH)
- Functional safety and protection functions (Safety Integrated for Process Automation)
- Route control for material transport (SIMATIC Route Control)
- Telecontrol of remote units (SIMATIC PCS 7 TeleControl)
- Automation of electrical switchgear (SIMATIC PCS 7 PowerControl)

Further additional functions that are also integrated, or can be integrated, seamlessly into the control system make optimization of processes and reductions in operating costs possible. SIMATIC PCS 7 has, for example, tools for energy and asset management, and it offers higher quality closed-loop control functions, as well as industry-specific automation solutions and libraries.

Customized performance

Thanks to a unique scalable system architecture, SIMATIC PCS 7 creates the ideal basis for cost-effective implementation of individual automation solutions and economic operation of process plants.

SIMATIC PCS 7 users derive sustained profit from a modular system platform based on standard SIMATIC components. Its uniformity enables flexible scaling of hardware and software, as well as perfect interaction both within the system and beyond system limits. The architecture of the SIMATIC PCS 7 Process Control System is designed in such a manner that instrumentation and control can be configured in accordance with customer requirements and optimally matched to the dimensions of the plant. The control system can be subsequently expanded or reconfigured at any time if there is an increase in capacity or a technological modification. When the plant grows, SIMATIC PCS 7 simply grows along with it – without the provision of expensive reserve capacities.

Performance in Engineering

With regard to planning and engineering, performance can be equated with minimizing time and costs. This is where the SIMATIC PCS 7 Plant Automation Accelerator offers its unique approach, with an integrated planning workflow from the process description to the automation program.

The object-oriented approach of the SIMATIC PCS 7 Plant Automation Accelerator makes it possible to work on a central data platform, thus ensuring completely integrated planning – from plant engineering through to automation – based on an electronic workflow. This modular engineering approach enhances efficiency and minimizes risks. Project planning and documentation takes place early during the quote and engineering phase, resulting in significant time and cost savings.

Engineering using other planning tools is also mastered extremely efficiently by SIMATIC PCS 7 by means of the Advanced Engineering System (AdvES). This can be used to import plant data from CAD/CAE tools without problems. It additionally allows automatic generation of the AS configuration thanks to simple multiplication of process tag types and model solutions, as well as parameter processing.

Performance in operation

Process control also becomes more complex due to the multi-layer nature of automation engineering and the increased merging with information technology. Intuitive and fault free operation is therefore more important than ever with regard to efficient working and the minimization of downtimes and servicing requirements. Using effective Advanced Process Control (APC) functions and an excellent operator system, SIMATIC PCS 7 supports optimization as well as user-friendly and safe control of the process. Monitoring of product quality and performance indicators additionally allows the process to be operated more economically. At the same time, SIMATIC PCS 7 convinces with high flexibility, plant availability, and investment security.

Process control and maintenance

SIMATIC PCS 7's operator system is used to monitor process operation using various views, and permits interventions when necessary. Its architecture is flexible and scalable – from single-user systems up to multi-user systems with a redundant client/server architecture. The operator interface takes account of the current specifications of NAMUR (user association of automation technology in the process industries) and PI (Profibus International) and offers a high level of user-friendliness for simple, intuitive interaction with the plant. Ergonomic symbols, task-oriented faceplates, uniform representation of status information, and optimized alarm functions allow safe process control.

The alarm management function integrated in SIMATIC PCS 7 is able to focus on essential alarms and to specifically guide the operator in exceptional circumstances. In this way, it systematically reduces the workload of operating staff.

Preventive and predictive maintenance strategies reduce total cost of ownership. With the SIMATIC PCS 7 Maintenance Station, maintenance personnel always have a watchful eye on critical production equipment such as pumps, valves, distillation columns or motors, and can carry out the relevant maintenance measures in good time before servicing is required – independent of the maintenance plan and without the risk of an unplanned plant standstill.

Overview (continued)

Process optimization

SIMATIC PCS 7 supports process optimization in many different manners, including:

- Control Performance Monitoring
- Advanced Process Control
- Process Historian

The Control Performance Monitoring function monitors and signals the control quality of the closed-loop control block. If the performance declines, the controller can be optimized in good time or specific maintenance measures can be initiated.

The integrated I&C libraries of SIMATIC PCS 7 also provide higher quality closed-loop control functions with which cost-effective Advanced Process Control applications can be implemented: multi-variable control, predictive control, or override control. It is thus possible to effectively improve profitability, product quality, safety, and environmental protection in small and medium-sized plants.

Current and historic process data form the basis of all optimization. Secure and user-friendly real-time data storage and analysis is handled using the Process Historian. The process values, messages, and batch data managed in the database of the Process Historian can be called extremely rapidly. User-specific processing and visualization of this historic data are supported by the information server, which is a reporting system based on the Microsoft Reporting Services.

SIMATIC PCS 7 system and technology components

With the rugged, high-performance SIMATIC PCS 7 system components from Catalog ST PCS 7, you already have a versatile platform for cost-effective implementation and economical operation of your process control systems. Perfect interplay of these system components makes it possible for you to sustain high-quality production and to establish new products significantly faster on the market.

With SIMATIC PCS 7 technology components from Catalog ST PCS 7 T that can be seamlessly integrated into the process control system, you can expand the functional scope of the system components in a carefully targeted manner for specific automation tasks.

This covers a wide spectrum, for example:

- Telecontrol for monitoring and controlling remote plant units
- Automation technology for electrical low-voltage or medium-voltage switchgear
- Industry-specific automation systems for the cement and mining industries, as well as for laboratory and training facilities
- Graphical objects for task-oriented optimization of process visualization
- Block libraries for technological functions, package unit and panel integration, monitoring and analyzing mechanical assets, as well as for building automation systems (heating, ventilation, air-conditioning – FMCS/HVAC)

- Editors and function blocks for the efficient configuration of small or medium-sized automation systems with simple parameter control and materials management
- Process analytical technology for quality assurance through optimization of development and production processes based on up-to-date measurements, and critical quality and performance attributes
- Simulation system for testing and commissioning of plant-specific application software
- Flexible, high-performance Manufacturing Execution System (MES)
- System expansion for operator systems for the integration of third-party controllers, programmable logic controllers and package units
- Products for migration of the process control systems TELEPERM M, APACS+/QUADLOG or Bailey INFI 90/NET 90 with SIMATIC PCS 7

SIMATIC PCS 7 technology components have been released for all versions and service packs of SIMATIC PCS 7 system components. Development and testing of SIMATIC PCS 7 technology components are dependent on the corresponding SIMATIC PCS 7 system components, so versioning and release is normally performed asynchronously, that is following a delay of between 3 and 6 months.

Additional functionality can be integrated using add-on products

Modularity, flexibility, scalability, and the openness of SIMATIC PCS 7 offer optimal prerequisites for integrating supplementary components and solutions in the process control system in an applicative manner and thus extend and round off its functionality.

Many supplementary add-on products for SIMATIC PCS 7 have been developed by Siemens as well as by external partners (see Catalog ST PCS 7 AO, Add-ons for the SIMATIC PCS 7 Process Control System). These software packages and hardware components authorized by the system manufacturer enable cost-effective implementation of SIMATIC PCS 7 for special automation tasks.

Overviews

SIMATIC NET

Introduction

Overview

SIMATIC NET Industrial communication – the backbone of automation

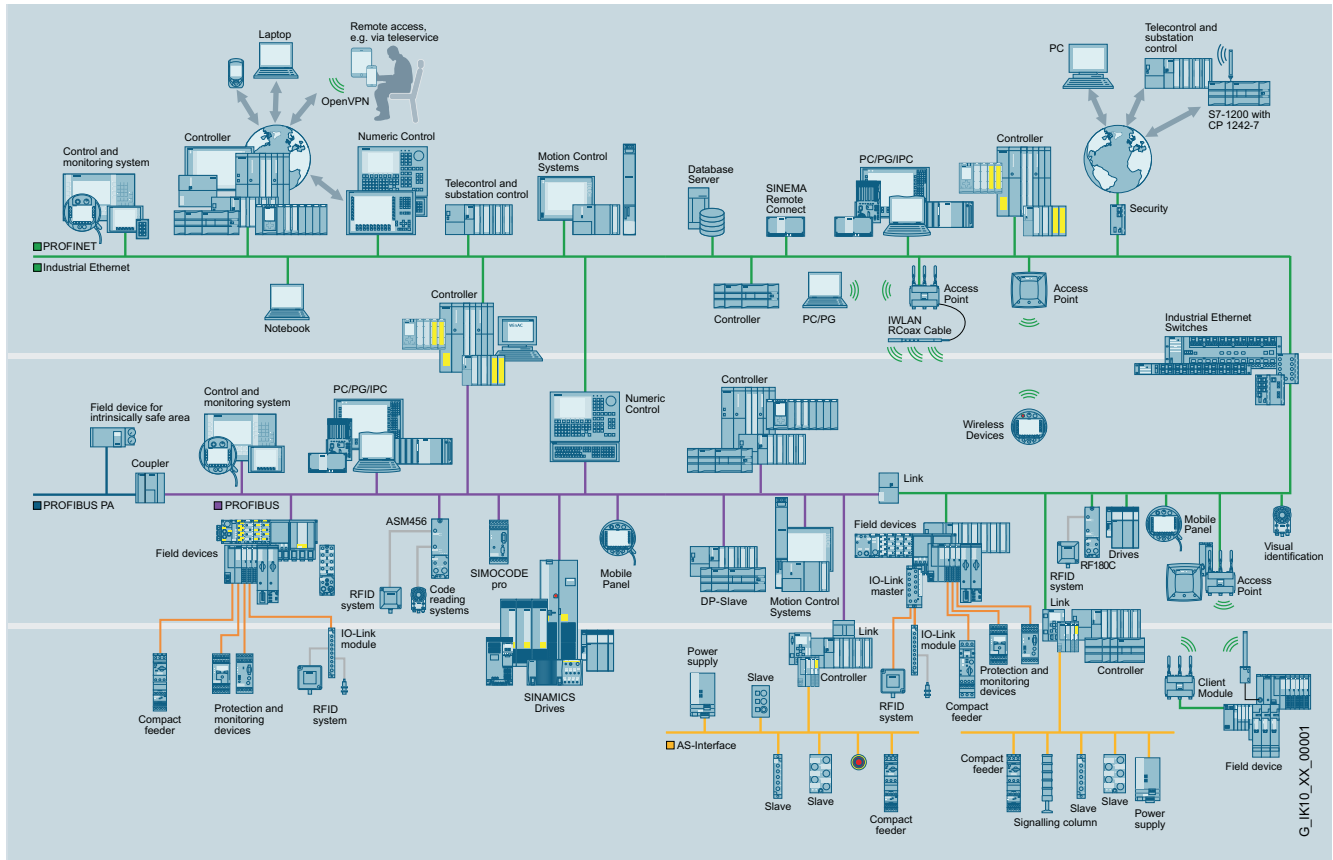

Powerful and open communication systems ensure trouble-free communication for automation systems, covering

- data communication or
- process or field communication.

Openness and flexibility of the individual communication systems in different topologies enable linking of a wide variety of systems and their subsequent expansions. By using standardized communication systems, it is possible to connect standardized components from different suppliers without any problems. This ensures maximum protection of investment, as existing networks can be extended without any adverse effects.

G_IK10_XX_00001

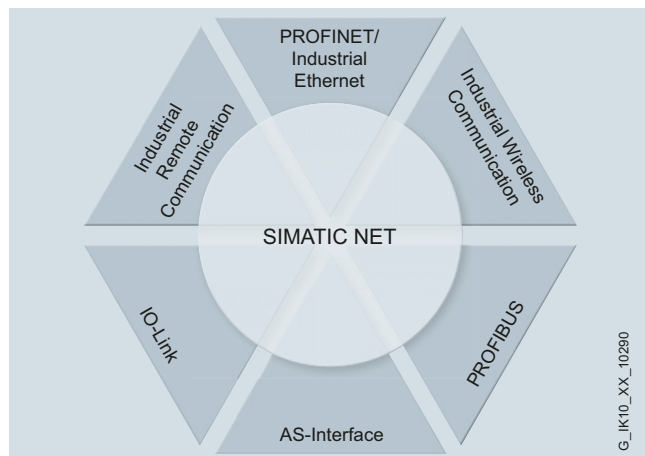
Overview (continued)

More information

- Catalog IK PI
- Catalog IC 10
- Catalog CA 01 on DVD
- Internet:
www.siemens.com/industrial-communication

SIMATIC NET provides components for an integrated overall solution beyond network boundaries.

These include:

- Passive network components, e.g. FastConnect cabling systems
- Active network components, e.g. SCALANCE X Industrial Ethernet switches
- Interfaces for connecting programmable controllers to the communication systems:
 - Integrated interfaces
 - Communications processors
- Components for wireless networks, e.g. Industrial Wireless LAN, SCALANCE W Access Points, and Client Modules
- Components for industrial security
- Components for Industrial Remote Communication, worldwide access to outlying plants, distant machines, and for mobile applications such as TeleControl.
- Components for the connection to remote networks, e.g. SCALANCE M and SINEMA Remote Connect
- Network transitions, e.g. IE/PB LINK PN IO
- Software for configuration, monitoring and diagnosis of the network, e.g. SINEMA Server

Overviews

SIMATIC Ident

Introduction

Overview

SIMATIC Ident – for more cost-effective production and logistics processes

To stay ahead in ever more dynamic markets and in the face of growing competition, stricter standards and statutory obligations, shorter product life cycles, more individual customer requirements, and increasingly globalized value-added, companies must be in a position to significantly boost the efficiency of their value added chains. In production control, asset management, tracking & tracing as well as in supply chain management. By using innovative identification technologies, companies can gain important advantages. Together with high-performance, reliable communication networks, this creates the infrastructure that prepares companies for the forthcoming industrial digitalization.

With SIMATIC Ident, we offer a unique portfolio for industrial identification which provides the perfect solution for your requirements while keeping you flexible for the future.

The right identification technology depends on factors such as sensing distance, lighting conditions, single or repeat markings, as well as environmental effects such as temperature and pollution.

Whether RFID, barcode, DMC or OCR: each technology has its specific strengths. For instance, optical character recognition is used for cases in which codes must also be readable for persons, such as use-by dates.

2D codes and RFID impress customers with their high level of data security and reliability, even in harsh industrial environments.

But the most important factor for your identification system is: your individual application.

Whatever your requirements – with our SIMATIC Ident Portfolio we can always provide the appropriate solution. Using communication modules and convenient function blocks, it is easy to connect SIMATIC Ident systems to PLCs, such as SIMATIC, or embed them in the IT landscape. This ensures that you have a system-wide, uniform software architecture, saving you considerable outlay and costs in engineering, commissioning and maintenance.

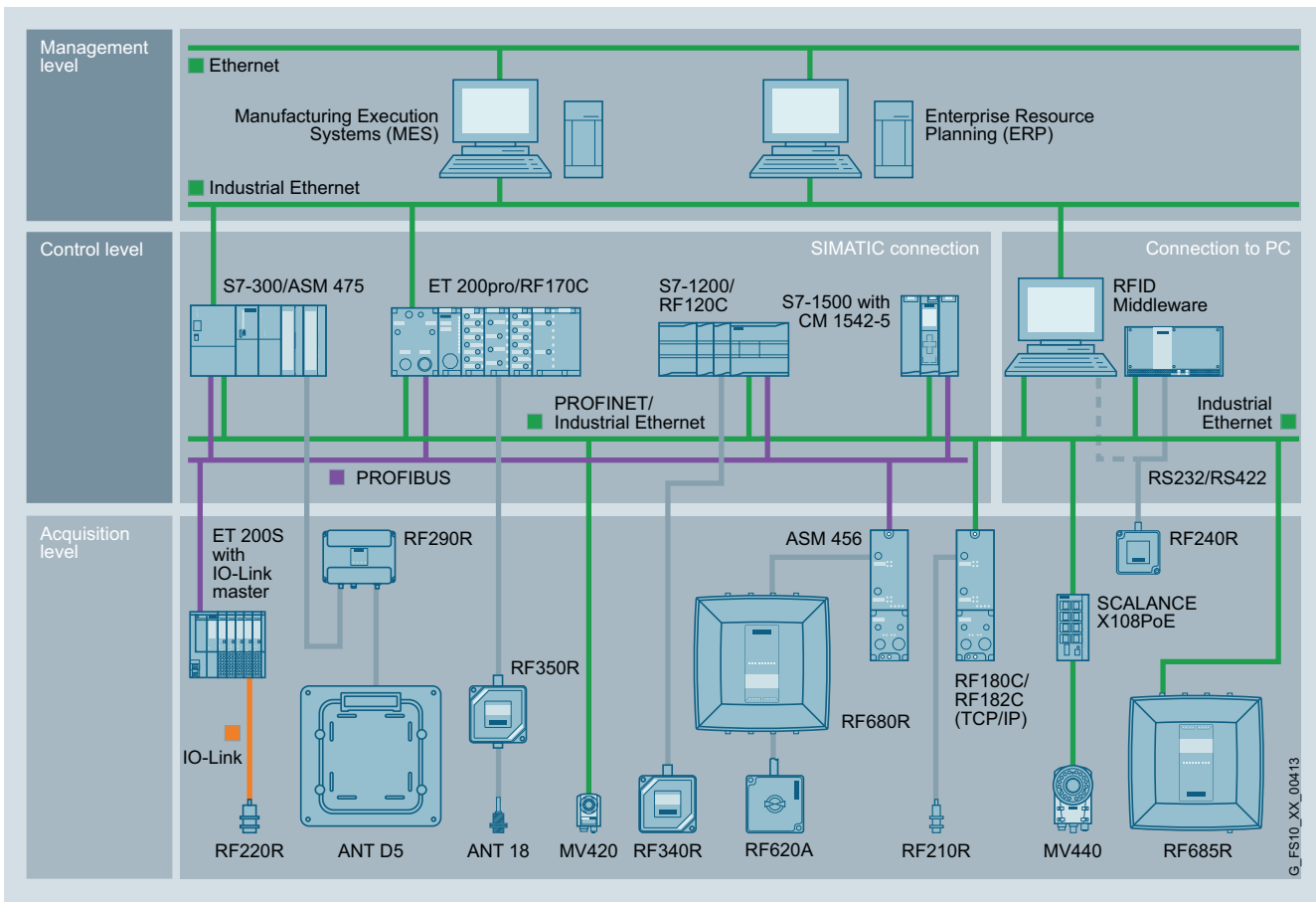

G_FS10_XX_00413

Overview (continued)

Identification, mobile data storage: RFID

RFID is the ideal solution when there is no line of sight between the reader and the marking, large volumes of data or wide ranges are required, or the stored information has to be changed. Here the product or object is fitted with a memory chip that can be programmed and read using radio techniques. With low-cost SmartLabels available for logistics, rugged data memories for assembly lines as well as transponders with a wide range, RFID is perfectly suited to a variety of different applications.

Our intelligent SIMATIC RF system family offers you transparency without gaps. Data is therefore available at any time along the complete production and distribution chain - for perfect control and optimization of material flow and logistics.

Identification, verification: Optical identification

When higher performance is required, 2D codes are recommended as an alternative to barcodes. 2D codes offer more memory capacity, higher reading rates, and enhanced reading security. They can be applied inexpensively, e.g. together with shipping labels. They also enable products to be marked directly (Direct Part Marking, DPM) using lasers, printing or dot-peening, which is extremely resistant to external influences. 2D codes can be read with complete reliability even from a small viewing angle or under difficult lighting conditions.

With our optical reading devices, we offer you the ideal solution for reading and verifying 1D and 2D codes as well as for text recognition (OCR) and object recognition (Pat-Genius) for the reliable tracing of production batches beyond the manufacturing plant.

More information

- Catalog ID 10
- Catalog CA 01 on DVD
- Internet: www.siemens.com/simatic-ident

Overviews

Notes

Supplementary components



15/2 15/2	Drive systems SINAMICS drive system
15/10 15/10	Overvoltage protection SICROWBAR overvoltage protection
15/11 15/11	Timing, coupling and monitoring relays SIRIUS relays
15/13 15/13	Measuring systems Motion Control Encoder Measuring Systems
15/13 15/13 15/15	Automation systems SIMOTION Motion Control System SINUMERIK 828D/ SINUMERIK 828D BASIC with SINAMICS S120 Combi
15/15	SINUMERIK 840D sl
15/16 15/16	System cabling Connection system MOTION-CONNECT

Brochures

For brochures serving as selection guides for SIMATIC products, refer to:
www.siemens.com/simatic/printmaterial

Supplementary components

Drive systems

SINAMICS drive system

Overview

The SINAMICS range



- Totally integrated range of drives for any application and every industry
- Wide range of power ratings from 0.12 kW to 120 MW
- Broad functional scope from simple U/f control through to highly dynamic servo control
- Designed for problem-free interaction with other Siemens automation components
- Shared platform concept with uniform functionality, engineering, commissioning, operation as well as a uniform diagnostics concept and communication mechanisms

SINAMICS V20 – The perfect solution for basic applications



- Power range from 0.12 kW to 30 kW
- Voltage:
 - 230 V 1AC: 200 V to 240 V 1 AC (-10 % to +10 %)
 - 400 V 3AC: 380 V to 480 V 3 AC (-15 % to +10 %)
- Integrated USS and Modbus RTU interfaces
- Integrated braking module for 7.5 kW to 30 kW
- Parameter readout and cloning without power supply
- Integrated connection and application macros
- ECO mode for U/f , U^2/f
- Integrated hibernation mode in the idle state
- Wireless commissioning, operation and diagnostics via mobile device or laptop thanks to the optional SINAMICS V20 Smart Access (Web server module)

More information

- SINAMICS V20 Brochure, Catalog D 31.1
- Interactive Catalog CA 01
- Internet:
 - <http://www.siemens.com/sinamics-v20>
 - <http://www.siemens.com/industrymall>

SINAMICS V90 basic servo drive system – the performance-optimized and easy-to-use servo drive system



- SINAMICS V90 and SIMOTICS S-1FL6 form an optimized servo drive system for positioning, as well as speed and torque control. Thanks to the optimized design, the system permits high servo performance with a high level of ruggedness in a simple, low-cost way.
- SINAMICS V90 is designed for all-purpose servo applications while taking into consideration the challenges for machine builders and system integrators in terms of costs and time-to-market.
- The SINAMICS V90 system can essentially be commissioned effortlessly by means of a simple plug-and-play procedure. The SINAMICS V90 drive offers optimum servo-performance, can be integrated quickly into SIMATIC PLC control systems and offers a high level of reliability. The connection is made, for example, via PROFINET by means of a pulse-direction interface or via analog inputs/outputs. A seamless drive system can be created by combining the SINAMICS V90 servo drive with our SIMOTICS S-1FL6 servomotor.
- SINAMICS V90 offers internal positioning, positioning with pulse sequence, and speed and torque control.
- With integral auto-tuning in real time and automatic suppression of machine resonances, the system automatically optimizes itself to achieve a highly dynamic performance and smooth operation. In addition, the pulse train input makes it easier to achieve high positioning accuracy due to its high frequency limit of up to 1 MHz.

More information

- SINAMICS V90 Brochure
- Interactive Catalog CA 01
- Internet:
 - <http://www.siemens.com/sinamics-v90>
 - <http://www.siemens.com/industrymall>

Overview (continued)
**SINAMICS G120P –
 the specialist for pumps, fans, and compressors**

- Power range from 0.37 kW to 630 kW
- Automatic switchover to mains operation at rated speed
- Numerous functions for pumps, fans and compressors, e. g. energy-saving mode, Pt1000/LG-Ni1000/DIN-Ni1000 temperature sensor interface, cascade connection, programmable timer switches, bypass mode, multi-zone control
- Communication: RS485, USS, Modbus RTU, BACnet MS/TP, PROFINET, EtherNet/IP, PROFIBUS DP
- Integrated in the TIA Portal with SINAMICS Startdrive
- Energy efficient through minimal apparent power losses, automatic adaptation of the motor current to the actual load conditions with ECO mode

More information

- Catalog D 35
- Interactive Catalog CA 01
- Internet:
<http://www.siemens.com/sinamics-g120p>
<http://www.siemens.com/industrymall>

**SINAMICS G120D –
 the distributed single-motor drive for high-performance solutions**

- Positioning capability
- Power range from 0.75 kW to 7.5 kW
- Energy efficient thanks to regenerative feedback and low line harmonic distortion
- Safety Integrated: STO, SS1, SDI, SSM and SLS encoderless
- Thanks to the modular design, electronics stocks are minimal
- Interchangeable memory card
- Communication via PROFIBUS DP, PROFINET, EtherNet/IP
- Integrated in the TIA Portal with SINAMICS Startdrive

More information

- Catalog D 31.2
- Interactive Catalog CA 01
- Internet:
<http://www.siemens.com/sinamics-g120d>
<http://www.siemens.com/industrymall>

Supplementary components

Drive systems

SINAMICS drive system

Overview (continued)

SINAMICS G120C – the compact and versatile inverter with optimum functionality



- Compact unit
- Highest power density in its class
- Power range from 0.55 kW to 132 kW
- Easy commissioning and maintenance
- With BOP-2 or IOP-2 operator panel
- Safety Integrated: STO
- Available communication: PROFIBUS DP, USS, Modbus RTU, PROFINET, EtherNet/IP
- Integrated in the TIA Portal with SINAMICS Startdrive

More information

- Catalog D 31.1
- Interactive Catalog CA 01
- Internet:
<http://www.siemens.com/sinamics-g120c>
<http://www.siemens.com/industrymall>

SINAMICS G120 – the modular single-motor drive for low to medium power ratings



- Power range from 0.37 kW to 250 kW
- Safety Integrated: STO, SS1, SBC, SLS, SDI and SSM encoderless
- Communication via PROFIBUS, PROFINET, EtherNet/IP, RS485, USS, Modbus RTU, CANopen, BACnet MS/TP
- Energy efficient thanks to regenerative feedback and low line harmonic distortion
- Parameter copy function for standard commissioning
- Integrated in the TIA Portal with SINAMICS Startdrive

More information

- Catalog D 31.1
- Interactive Catalog CA 01
- Internet:
<http://www.siemens.com/sinamics-g120>
<http://www.siemens.com/industrymall>

Overview (continued)**SINAMICS G110D –
the distributed single-motor drive for simple solutions**

- Continuous speed control of three-phase induction motors
- Meets all the requirements of conveyor applications with frequency control
- Distributed configuration – ideal for applications covering large areas
- Integrated into TIA via AS-Interface
- Wide power range from 0.75 kW to 7.5 kW

More information

- Catalog D 31.2
- Interactive Catalog CA 01
- Internet:
<http://www.siemens.com/sinamics-g110d>
<http://www.siemens.com/industrymall>

**SINAMICS G110M –
the distributed inverter integrated in the motor**

- Power range from 0.37 kW to 4 kW
- Integrated safety functions (STO locally via F-DI or via PROFIsafe)
- Integrated communication: USS, Modbus RTU, PROFIBUS, PROFINET, EtherNet/IP and AS-Interface
- Basic PLC functions and additional conveyor technology functions
- Local commissioning via DIP switch and potentiometer, memory card, USB interface or Intelligent Operator Panel (IOP-2)
- Integrated in the TIA Portal with SINAMICS Startdrive

More information

- Catalog D 31.2
- Interactive Catalog CA 01
- Internet:
<http://www.siemens.com/sinamics-g110m>
<http://www.siemens.com/industrymall>

Supplementary components

Drive systems

SINAMICS drive system

Overview (continued)

**SINAMICS G130/SINAMICS G150 –
the universal drive converter solution for single-motor
drives with a high power rating**



- Available as a standardized control cabinet or chassis unit
- Output range from 75 kW to 800 kW or 2700 kW with parallel switching
- Specifically tuned for drives with quadratic and constant load characteristics with medium performance requirements without regenerative feedback
- Service-friendly thanks to easy access to all modules
- Communication via PROFIBUS DP, PROFINET, Ethernet/IP, CANopen
- Energy-efficient due to variable-speed operation
- Sensorless vector control
- Safety Integrated: STO, SBC, SS1 with SBR/SAM; SLS, SSM, SDI, SBT
- Easy commissioning and parameterization by means of user-friendly AOP30 control panel or PC-controlled via the STARTER commissioning tool

More information

- Catalog D 11
- Interactive Catalog CA 01
- Internet:
<http://www.siemens.com/sinamics-g130>
<http://www.siemens.com/sinamics-g150>
<http://www.siemens.com/industrymall>

**SINAMICS S110 –
the specialist for simple positioning tasks**



- Servo control
- Power range from 0.55 kW to 132 kW
- Safety Integrated
- Integrated positioning functions
- Straightforward system interface with higher-level controllers (e.g. PLC) with PROFIBUS DP or PROFINET

More information

- Catalog D 31.1
- Interactive Catalog CA 01
- Internet:
<http://www.siemens.com/sinamics-s110>
<http://www.siemens.com/industrymall>

Overview (continued)

SINAMICS S120 –
the flexible, modular drive system for demanding single-axis
and multi-axis applications from the low-end to the high-end
performance range

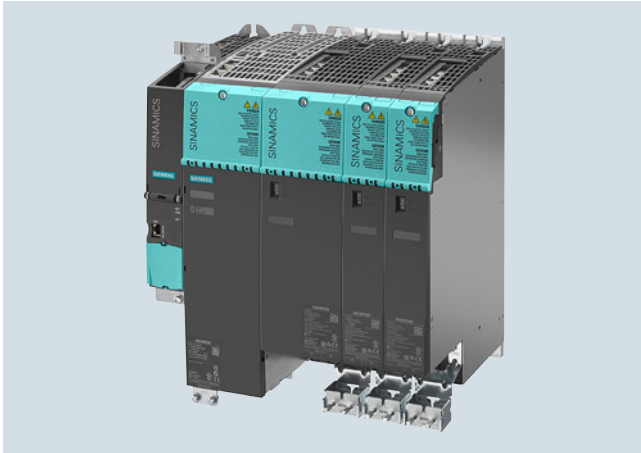

- Modular drive system for single-axis and multi-axis applications in all areas of machine and plant manufacturing
- Servo/vector control, U/f-control
- Power range from 0.12 kW to 5700 kW
- Various types of construction for different application areas
- Highly flexible due to, for example, modular system architecture, different cooling methods, support for a wide range of motors/encoders, easy expansion
- High degree of scalability with regard to performance, number of axes, functionality
- Integrated safety functions
- Comprehensive motion control functionality
- High availability and efficiency, even in unstable networks
- Automatic parameterization and easy drive commissioning/optimization

More information

- Catalogs NC 62, D 21.3, D 21.4
- Interactive Catalog CA 01
- Internet:
<http://www.siemens.com/sinamics-s120>
<http://www.siemens.com/industrymall>

SINAMICS S150 –
the sophisticated drive solution for mid to high-performance
single-motor drives



- Particularly suitable for applications with high requirements regarding precision and dynamic response in the mid to upper performance range, as well as for frequent braking cycles with high braking energies and four-quadrant operation
- Ready-to-operate control cabinet
- Power range from 75 kW to 1200 kW
- Straightforward configuring and commissioning provided by the SIZER for Siemens Drives and STARTER
- High availability and efficiency, even in unstable networks
- Economic operation due to standard energy recovery
- Line-friendly operation thanks to Clean Power Filter (line feedback < 1 %)
- Reactive power compensation possible
- Fitted as standard with PROFIBUS DP interface for connection to higher-level controls

More information

- Catalog D 21.3
- Internet:
<http://www.siemens.com/sinamics-s150>
<http://www.siemens.com/industrymall>



Supplementary components

Drive systems

SINAMICS drive system

Overview (continued)

SINAMICS GM150 – the universal drive solution for single-motor drives in the medium-voltage range



- Single-motor drive for applications with a square law and constant load characteristic without energy recovery
- Space-saving, simple and fast commissioning
- Ready-to-connect cabinet unit
- Ideally suited to the economical deployment of pumps, fans, extruders, mixers etc.
- Power section in HV-IGBT technology for outputs up to 13 MVA, output voltage 2.3 kV to 4.16 kV, with choice of air or water-cooling
- Power section in IGCT technology for outputs from 10 MVA to 24 MVA, output voltage 3.3 kV, water-cooled
- Optimum interaction with SIMATIC

More information

- Catalog D 12
- Internet:
<http://www.siemens.com/sinamics-gm150>

SINAMICS SM150 – the sophisticated drive solution for single- and multi-motor drives in the medium-voltage range



- Single- or multi-motor drive for regenerative, highly dynamic applications
- Roller drives (cold, hot), shaft conveyor drives, test benches, belt systems
- Power section in HV-IGBT technology for outputs from 3.4 MVA to 5.8 MVA, output voltage 3.3 kV and 4.16 kV, with choice of air or water-cooling
- Power section in IGCT technology for outputs from about 5 MVA to 31.5 MVA, output voltage 3.3 kV, water-cooled
- Ideal for direct power exchange via the common DC bus for multi-motor drives involving both regenerative and motor operation
- Optimum interaction with SIMATIC

More information

- Catalog D 12
- Internet:
<http://www.siemens.com/sinamics-sm150>

Overview (continued)**SINAMICS DCM –
the scalable drive system for basic and demanding
DC applications**

- In the power range from 6 kW to 30 MW for machines and plants in the industrial environment (steel/aluminum, plastics, printing, paper, cranes, mining, oil and gas, excitation equipment) in the new plant and retrofit businesses
- PROFIBUS DP as standard, PROFINET optional
- Control Unit variance
- Field power supply to suit requirements
- Electronics power supply for connection to 24 V DC
- Power section isolated with respect to ground (floating voltage sensing)
- Free function blocks and Drive Control Chart (DCC)
- Expandable functionality using SINAMICS components
- Single-phase operation possible
- Painted modules and nickel-plated copper rails
- Wide temperature range

More information

- Catalogs D 23.1
- Internet:
<http://www.siemens.com/sinamics-dcm>

Supplementary components

Overvoltage protection

SICROWBAR overvoltage protection

Overview

SICROWBAR AC

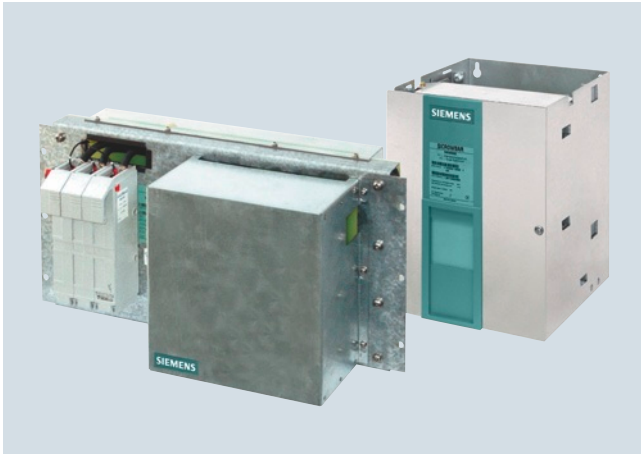

SICROWBAR AC is used to protect power semiconductors in converters (thyristors and diodes) against overvoltage that occurs between the phases of a three-phase network. The range of applications is not restricted to protecting DC drive converters, but also comprises infeed/regenerative feedback units of the AC drive technology that are equipped with thyristors.

Overvoltage that occurs on the AC side of converters is mainly caused by switching operations when disconnecting from the line supply at the transformer's primary side. This applies both to operational switching operations (shutdown at no-load) as well as in the case of a fault (shutdown under load).

The overvoltage protection is mainly used in the following configuration:

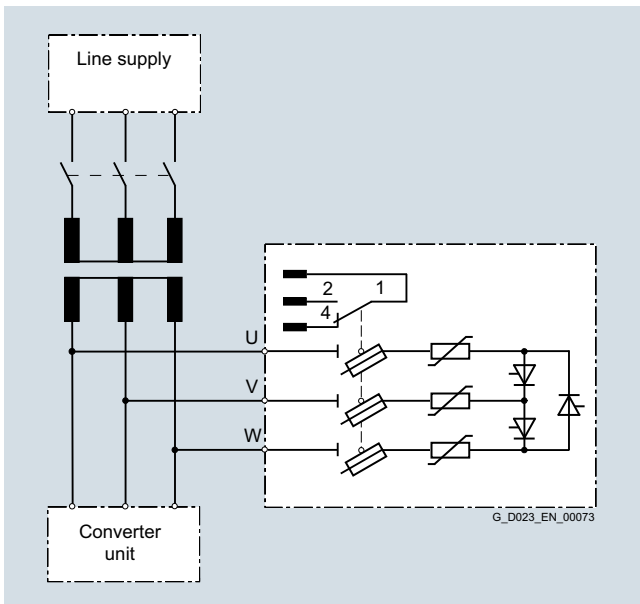

More information

- Catalog D 23.1
- Internet:
www.siemens.com/sinamics-dcm

SICROWBAR DC



SICROWBAR DC protects coils and converters against overvoltage conditions when they are used to supply large inductances, for instance, the excitation coils of synchronous machine motors, DC machine motors or hoisting solenoids. An appropriate de-excitation/discharge resistor must be provided. A thermostatic switch can be ordered as an option for the resistor from the manufacturer.

The fast de-excitation option G11 (module 7VV3003-7FG00) makes it possible to initiate fast de-excitation, triggered by a higher-level signal, for the 7VV3003-5... units.

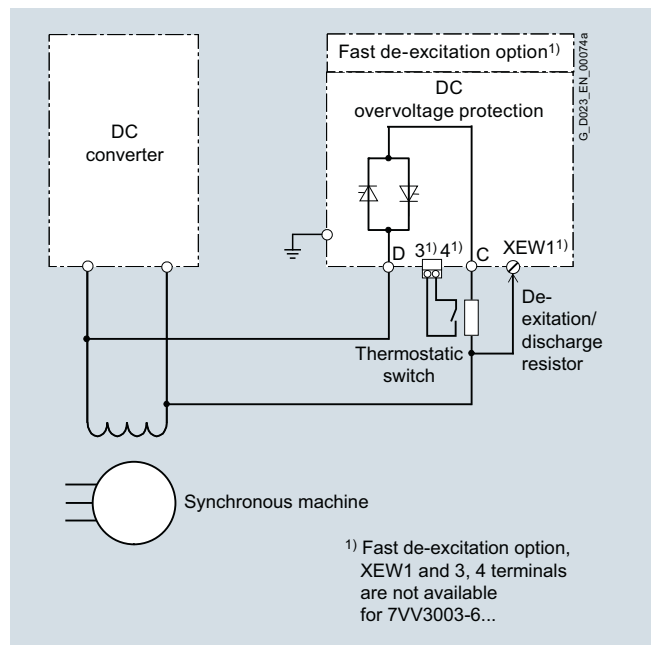

More information

- Catalog D 23.1
- Internet:
www.siemens.com/sinamics-dcm

Overview



SIRIUS relays – one range for every application

Our range of SIRIUS relays offers you everything you need for a motor feeder application. Easy and convenient – and all from one source. Whether you require compact timing relays or reliable monitoring relays, particularly narrow coupling relays, plug-in relays, low-noise power relays or signal converters – it will not be easy to find a more complete and comprehensive range of relays anywhere. Quite simply, there is one for every possible need. What is more: all SIRIUS relays are particularly easy to use. So take a closer look at our range and convince yourself – you will be surprised.

SIRIUS 3UG, 3RR, 3RN, 3RS monitoring relays Reliable monitoring and protection

SIRIUS relays from Siemens offer maximum protection for machines and plants, and they now also communicate with the control level thanks to IO-Link. The new SIRIUS relays for IO-Link reliably monitor network quality, power values, voltages, speeds and temperatures and at the same time they open up an even wider field of applications for you.

3RS temperature monitoring relays operate autonomously or in parallel with a closed temperature control loop and serve to monitor a defined limit temperature in solid, liquid or gaseous media.

3UG monitoring relays are used to monitor electric and non-electric variables which cannot (or should not) be directly recorded by an automation system.

- Monitoring of networks for overvoltage or undervoltage, direction of rotation, or asymmetry.
- Monitoring of loads using Cos-phi or current measurement.
- Monitoring for insulation faults and fault currents.
- Monitoring of levels or speeds of rotation.

The 3RR current monitoring relays are suitable not only for monitoring motors or other loads, but are also well suited to monitoring multiphase currents of the entire plant or the driven process. In this way, for example, an idling pump or an overload is promptly detected and reported in good time. The 3RR2 monitoring relays can be set up individually or integrated directly into the load feeder.

3RN thermistor motor protection devices monitor the winding temperature of motors fitted with a PTC sensor.

- Compliance with the ATEX directive 2014/34/EC through conformity with EN 50495 and EN 60947-8 standards.
- Compliance with the safety requirements for PL c according to ISO 13849 or SIL 1 according to IEC 61508
- Fast fault diagnostics through display of open-circuit and short-circuit.
- Solid-state compatible output due to hard gold-plated contacts.

Note:

The 3RN1 relays have been replaced by the 3RN2 thermistor motor protection devices.

SIRIUS speaks IO-Link

With the SIRIUS monitoring relay for IO-Link you are opting for maximum flexibility: As well as the autonomous monitoring function that is still available, measured values and data can also be transferred directly to the controller via IO-Link. Parameters can also be assigned locally or via IO-Link. This means that the SIRIUS relays for IO-Link are fully integrated into Totally Integrated Automation, our open system architecture for integrated automation. You also profit from significantly simplified device replacement – thanks to data matching and automatic re-parameterization via a parameter server.

SIRIUS 3RP, 7PV timing relays

Electronic timing relays are used for all delayed switching operations in open-loop control, starting, protection and closed-loop control circuits.

Thanks to their sophisticated and compact design, the 3RP timing relays are ideal timer modules for control cabinet, switchgear and controller manufacturers from the industry. Due to their narrower design, the 7PV timing relays are particularly suitable for use in heating, ventilation and air-conditioning systems and compressors.

SIRIUS 3RA28 function modules and solid-state time-delayed auxiliary switch blocks

The 3RA281 function modules permit the construction of starters and contactor combinations for direct and star-delta starting. They include the essential control functions that are needed for the respective feeder – for example, timing and electrical interlocking functions. Function modules that function as timing relays can easily and quickly be fitted to SIRIUS contactors – without any significant wiring effort. They permit both ON-delay and OFF-delay switching of contactors.

The 3RA283 solid-state time-delayed auxiliary switch blocks can be connected to contactors and are designed for contactor coil voltages in the 24 to 240 V AC/DC wide voltage range. Auxiliary switches for control and alarm signals are used specially for switching the smallest signals for electronics applications. They are used, for example, for allowing a pump or fan to run on, in a similar way to an OFF-delay relay or for the delayed activation of a gate drive. Simply by snapping and locking it into place, both the electrical and mechanical connection is made. To attenuate switching overvoltages of the contactor coil, a varistor is integrated in the time-delayed auxiliary switch.

Supplementary components

Timing, coupling and monitoring relays

SIRIUS relays

Overview (continued)

SIRIUS 3RQ3, 3RS18, 3TG10 and LZS coupling relays

As the successors to the familiar 3TX7 coupling relays, the **3RQ3 coupling relays** are now available in a new uniform enclosure design. With their narrow width of 6.2 mm and low installation depth/height, they are ideal for space-optimized use in control cabinets with short gaps between tiers, and in flat control boxes. All versions are available with screw-type or spring-loaded terminals (push-in technology). Wiring time is reduced because conductors are inserted and clamped from the front.

3RQ3 coupling relays are available as:

- Coupling relay with relay output (not plug-in)
- Coupling relay with plug-in relay
- Coupling relay with semiconductor output (not plug-in)

The **3RS18 coupling relays** set new standards: With a wide voltage range from 24 V to 240 V AC/DC they are the star attraction on the coupler market. In this series, we offer you devices in the field-proven 22.5 mm industrial enclosure with one, two or three changeover contacts – using screw-type or spring-loaded connections and for combination and wide-range voltage with hard gold-plated contacts for an especially high contact reliability – even at low current levels. Thanks to the well-proven industrial enclosure, you can enjoy the benefits of user-friendly connection systems with permanent wiring, just the same as with our timing relays. Two conductors can be connected at each terminal point.

3TG10 power relays/miniature contactors prove their worth wherever small, low-noise relays or contactors are required at a reasonable price. This makes them ideal for simple controllers, especially for use in large-series manufactured devices and controllers. For applications that do not require an overload relay and need only one auxiliary switch – and which therefore need more switching power, higher switching voltage, and a longer service life.

LZS coupling relays with plug-in relays are available as complete devices or as individual modules for self-assembly or spare parts requirements. This series is divided into three designs: RT, PT, and MT.

- Can be used for contact multiplication, adaptation of potential, or for switching small loads.
- Max. 4 changeover contacts in one device:
 - Wide-voltage versions with or without hard gold-plated contacts.
 - With screw-type or push-in spring-loaded terminals.

SIRIUS 3RS70 signal converters

The 3RS70 (previously 3RS17) signal converters (also innovated), share the enclosure concept with the 3RQ3 coupling relays. They are used mainly for the electrical isolation and conversion of analog signals. Sensors/actuators and controllers usually have different potentials and therefore require electrical isolation in the signal circuit. This is done either in the controller or by means of signal converters.

The conversion of one signal into another is required if, for example, a voltage signal has to be converted into a current signal for transmission over a longer distance, or if the output of a sensor and the input of a controller do not match.

The implemented frequency outputs offer another application. The input signal is converted to a proportional frequency here. This means that analog signals can be processed with digital inputs.

This is important if a controller offers no possibility for an analog input, or if all analog inputs are already occupied, for example, in the case of retrofits.

More information

- Catalog IC 10
- "SIRIUS relays" product brochure
- Internet: www.siemens.com/relays

Supplementary components

Measuring systems, Automation systems

Motion Control Encoder Measuring Systems

Overview



- Built-on encoders are available as both incremental and absolute encoders.
 - Incremental encoders:
 - Interfaces RS422 (TTL) , 1 V_{pp} and HTL.
 - Operating voltage 5 V DC or 10 V to 30 V DC.
 - Absolute encoders:
 - All absolute encoders are available in single-turn and multi-turn versions.
 - Synchronous serial interface (SSI) or connection for EnDat, PROFIBUS DP, PROFINET IO with RT/IRT and DRIVE-CLiQ.
 - Encoders with PROFIBUS DP support Class 1 ... 3 profiles as well as isochronous mode, direct communication and additional application-specific functions. They are designed to be parameterizable.
 - Encoders with PROFINET IO support Class 1 ... 4 profiles.
 - All measuring systems are available in both synchro flange and supported flange joint versions. The absolute encoders are available in a hollow-shaft version.
- More information
- Catalogs NC 62, NC 82, D 21.4
 - Interactive Catalog CA 01
 - Internet:
 - <http://www.siemens.com/sensor-systems>
 - <http://www.siemens.com/industrymall>
- Measuring systems are encoders for recording distances, angles of rotation and speeds.
 - They can be used on machines in various industries, such as production machines, handling equipment, machine tools and special-purpose machines.
 - Connectable to SIMATIC, SINAMICS, SINUMERIK and SIMOTION.
 - Available accessories for measuring systems include couplings, fixing materials, connectors and fully pre-assembled signal cables.

SIMOTION Motion Control System

Overview



SIMOTION system

The well-proven, modular and scalable SIMOTION Motion Control System with high-end functions for motion control is the ideal solution for applications in mechanical engineering, in which modularity, maximum precision and speed are vital.

SIMOTION ensures a high level of flexibility at low engineering outlay with the modular technology object approach. Object-oriented programming and a programming model with units and libraries enable the creation of reusable software modules and the effective implementation of large quantity structures.

SIMOTION simplifies the development and integration of standard modules in an executable project with libraries for industry-specific applications and the SIMOTION easyProject project generator.

Supplementary components

Automation systems

SIMOTION Motion Control System

Overview (continued)

The SIMOTION system is made up of three components:

Engineering system

The SCOUT engineering system enables Motion Control, PLC and technology functions to be incorporated in one comprehensive, integrated system and provides all the necessary tools: From programming and parameterization through testing and commissioning, to diagnostics.

SCOUT can be used in SIMATIC STEP 7, either with standardized data management and configuring procedures, or as a stand-alone engineering tool (SCOUT Stand-Alone). SCOUT TIA (SIMOTION in the TIA Portal) is available as an optional package for TIA Portal V13 and above and is included in the scope of supply of SCOUT.

The following options, for example, are available in the engineering system for programming:

- Graphic programming with Motion Control Chart (MCC)
- Ladder Diagram (LAD)/Function Block Diagram (FBD)
- High-level language Structured Text (ST), including object-oriented programming

Runtime system

The runtime system offers a high-performance execution system for cyclic and sequential tasks. The runtime software modules make the different PLC, Motion Control and technology functions available. By selecting the appropriate modules, the overall functionality of the system can be flexibly adapted to the machine.

Hardware platforms

The hardware platforms are the basis of the SIMOTION Motion Control System. The application created with the engineering system and the associated runtime software modules can be implemented on different hardware platforms. The scalable SIMOTION hardware supports centralized, distributed and mixed topologies for all machine designs with up to 128 axes per controller.

SIMOTION D – Compact and integrated in the drive

- The complete machine automation with drive control, PLC, Motion Control and technology functionality in one compact unit of SINAMICS S120 design.
- Particularly fast response
- Versatile networking options via PROFINET, PROFIBUS or Ethernet
- Scalable since multiple performance versions available
- SIMOTION D is available in two configurations:
 - As a single-axis system SIMOTION D410-2 with multi-axis option (blocksize configuration). The Control Units are available in D410-2 DP and D410-2 DP/PN versions and are snapped onto the SINAMICS S120 PM240-2 Power Modules in blocksize format.
 - As a multi-axis system SIMOTION D4x5-2 in four performance variants for as many as 128 axes (booksize format)
- Ideal for:
 - Compact machines
 - Distributed automation concepts, e.g. on machines with a large number of axes
 - Modular machines
 - Time-critical demands on the axis couplings

SIMOTION P – Open for other tasks

- This PC-based, open Motion Control System is available in two versions:
 - SIMOTION P320-4E for embedded PC solutions running on the Windows Embedded Standard 7 operating system
 - SIMOTION P320-4S for high-performance applications running on the Windows 7 Ultimate operating system
- Control, Motion Control, and HMI functions are executed together with standard PC applications on one platform. The advantage for the user: Using the PC platform and the Microsoft Windows operating system, with a real-time expansion for SIMOTION – the advantages of both worlds are combined in SIMOTION P:
 - Openness thanks to the Windows operating system
 - Real-time capability thanks to the SIMOTION operating system
- Ideal for:
 - Applications requiring an open PC world
 - Applications with particularly high performance requirements, e.g. hydraulics applications
 - Applications requiring control and visualization on one hardware system
 - Extensive data storage, evaluation and logging

SIMOTION C – Modularity and flexibility

- Controllers in SIMATIC S7-300-design
- 2 versions, optionally with PROFINET interface or with integrated drive interfaces for analog and stepper drives
- Onboard inputs/outputs expandable using I/O modules from the SIMATIC S7-300 range of products
- With integrated isochronous PROFIBUS interfaces
- Ideal for:
 - Highest possible level of freedom for drive selection
 - Broad range of process signals
 - Retrofit applications by means of integrated analog interfaces

More information

- Catalog PM 21
- Interactive Catalog CA 01
- Internet:
 - <http://www.siemens.com/simotion>
 - <http://www.siemens.com/industrymall>

Overview



SINUMERIK 828 – optimum scalability in the compact class

Alongside two high-performance CNC variants of SINUMERIK 828D, SINUMERIK 828D BASIC is an additional low-cost starter model in the compact class. SINUMERIK 828 therefore fits the performance requirements of standard machine concepts perfectly.

Compact, strong, simple – simply ingenious

The compact, operator-panel-based SINUMERIK 828 CNC systems are extremely rugged and very easy to maintain.

An operator panel front of die-cast magnesium, the panel-based CNC design with minimal interfaces and the high degree of protection make the SINUMERIK 828 CNC systems reliable partners even in harsh environments. Designed without a fan or hard disk, with NVRAM memory technology and no back-up battery, SINUMERIK 828 is a completely maintenance-free CNC.

Powerful CNC functions coupled with a unique 80-bit NANOPF accuracy permit excellent workpiece precision to be achieved in very short machining times. Thanks to a flexible CNC programming language as well as the unique machining step programming ShopTurn/ShopMill package, it is possible to program and machine both mass-production parts or single workpieces with the highest efficiency. Preconfigured technology-specific system software and unique service functions reduce the commissioning and servicing costs to an absolute minimum.

Technology tailor-made for use in standard turning and milling machines

SINUMERIK 828D is perfectly adapted for use in standard machines and provides optimum support for turning and milling technology. With two preconfigured system software variants for machining technology, the SINUMERIK 828 CNC systems are ready for use in turning and milling machines on dispatch from the factory.

An ideal basis for implementing a compact grinding machine

The G-Tech technology variant provides grinding machine manufacturers with a perfect platform on which to design grinding machines – it also supports cylindrical and surface grinding machines.

Since grinding machine manufacturers want to fully incorporate their specific process know-how so that it is even reflected in the operating philosophy of the CNC, the G-Tech variant of the SINUMERIK 828D offers a number of sophisticated grinding and dressing cycles for this purpose. Additionally, SINUMERIK Integrate for engineering Run MyScreens provides manufacturers with the option of designing their own HMI.

More information

- Catalog NC 82
- Interactive Catalog CA 01
- Internet:
<http://www.siemens.com/sinumerik>
<http://www.siemens.com/industrymall>

SINUMERIK 840D sl

Overview



The SINUMERIK 840D sl CNC offers modularity, openness, flexibility and uniform structures for operation, programming, and visualization. It provides a system platform with trend-setting functions for almost all technologies.

Integrated into the SINAMICS S120 drive system and complemented by the SIMATIC S7-300 automation system, the SINUMERIK 840D sl forms a complete digital system that is ideally suited for the mid to upper performance range.

SINUMERIK 840D sl is characterized by:

- A high degree of flexibility
- Excellent dynamic response and precision
- Optimum integration into networks

Supplementary components

Automation systems, System cabling

SINUMERIK 840D sl

Overview (continued)

Benefits

- Outstanding performance and flexibility for multi-axis systems of average to high complexity thanks to scalable hardware and software
- Universal openness of the user interface, the PLC and the NCK area to allow integration of your specialist know-how
- Integrated safety functions for man and machine: SINUMERIK Safety Integrated
- Comprehensive range of products for integrating machine tools into communication, engineering and production processes: SINUMERIK Integrate

Application

The SINUMERIK 840D sl can be deployed around the world for the following technologies:

- Turning
- Drilling
- Milling
- Grinding
- Laser machining

- Nibbling
- Punching
- Tool and mold making
- High-speed cutting applications
- Woodworking and glass processing
- Handling
- Transfer lines
- Rotary indexing machines
- Mass production
- JobShop production

The SINUMERIK 840DE sl is available as an export version for use in countries where approval is required.

More information

- Catalog NC 62
- Interactive Catalog CA 01
- Internet:
<http://www.siemens.com/sinumerik>
<http://www.siemens.com/industrymall>

Connection system MOTION-CONNECT

Overview

MOTION-CONNECT includes connection systems and components which are optimally tailored to individual areas of application. MOTION-CONNECT cables feature state-of-the-art connection systems to ensure fast, reliable connection of different components, and offer maximum quality as well as system-tested reliability.



MOTION-CONNECT power cable and signal cable

MOTION-CONNECT cables are available as fully-assembled power and signal cables or sold by the meter. The pre-assembled cables can be ordered in length units of 10 cm (3.94 in) and can be extended, if necessary.

Whatever your machine requirements, MOTION-CONNECT offers the solution.

- **Robust, high-performance and easy to use** thanks to pre-assembled cables with a rugged metal connector in degree of protection IP67 and reliable SPEED-CONNECT quick-release lock
- **Outstanding and proven quality** achieved by consistent quality management and system-tested cables

Cables are available in two different qualities – MOTION-CONNECT 500 and MOTION-CONNECT 800PLUS.

MOTION-CONNECT 500	MOTION-CONNECT 800PLUS
<ul style="list-style-type: none"> • Cost-effective solution for predominantly fixed installation • Tested for travel distances up to 5 m (16.4 ft) 	<ul style="list-style-type: none"> • Meets requirements for use in cable carriers • Oil-resistant • Tested for travel distances of up to 50 m (164 ft)

More information

- Catalogs D 21.4, NC 62, NC 82, PM 21
- Interactive catalog CA 01
- Internet:
<http://www.siemens.com/motion-connect>
<http://www.siemens.com/industrymall>

Appendix



16/2	SITRAIN – Training for Industry
16/2	Overview
16/3	Additional documentation
16/3	SIMATIC Manual Collection
16/4	Standards and approbations
16/4	CE marking
16/5	Certificates
16/5	Quality management
16/6	Partners at Siemens
16/6	Contacts worldwide
16/7	Siemens Partner Program
16/8	Siemens Automation Cooperates with Education
16/8	Simplify your education in automation
16/10	Online Services
16/10	Information and Ordering Options on the Internet and DVD
16/11	Information and Download Center, Social Media, Mobile Media
16/12	Industry Services
16/13	Portfolio overview
16/15	Online Support
16/16	Software licenses
16/18	Conditions of sale and delivery

Appendix

SITRAIN – Training for Industry

Overview



Your benefit from practical training directly from the manufacturer

SITRAIN – Training for Industry – provides you with comprehensive support in solving your tasks.

Training directly from the manufacturer enables you to make correct decisions with confidence.

Increased profits and lower costs:

- Shorter times for commissioning, maintenance and servicing
- Optimized production operations
- Reliable configuration and startup
- Shorten commissioning times, reduce downtimes, and faster troubleshooting
- Exclude expensive faulty planning right from the start.
- Flexible plant adaptation to market requirements
- Compliance with quality standards in production
- Increased employee satisfaction and motivation
- Shorter familiarization times following changes in technology and staff

Contact

Visit our site on the Internet at:
www.siemens.com/sitrain

or let us advise you personally. You can request our latest training catalog from:

SITRAIN – Training for Industry SITRAIN Customer Support Germany:

Tel.: +49 911 895-7575

Fax: +49 911 895-7576

Email: info@sitrain.com

Your benefits with SITRAIN – Training for Industry

Certified top trainers

Our trainers are skilled specialists with practical experience. Course developers have close contact with product development, and pass on their knowledge to the trainers and then to you.

Practical application with practice

Practice, practice, practice! We have designed the trainings with an emphasis on practical exercises. They take up to half of the course time in our trainings. You can therefore implement your new knowledge in practice even faster.

300 courses in more than 60 countries

We offer a total of about 300 classroom-based courses. You can find us at more than 50 locations in Germany, and in 62 countries worldwide. You can find which course is offered at which location at:

www.siemens.com/sitrain

Skills development

Do you want to develop skills and fill in gaps in your knowledge? Our solution: We will provide a program tailored exactly to your personal requirements. After an individual requirements analysis, we will train you in our training centers near you or directly at your offices. You will practice on the most modern training equipment with special exercise units. The individual training courses are optimally matched to each other and help with the continuous development of knowledge and skills. After finishing a training module, the follow-up measures make success certain, as well as the refreshment and deepening of the knowledge gained.

Overview

The SIMATIC manual collection brings together the manuals of Totally Integrated Automation in the smallest possible package. It is eminently suitable for startup and service, replaces the space-consuming paper version in the office and provides fast access to the information.

The manual collection contains manuals in 5 languages for

- LOGO!
- SIMADYN
- SIMATIC bus components
- SIMATIC C7
- SIMATIC Distributed I/O
- SIMATIC HMI
- SIMATIC Sensors
- SIMATIC NET
- SIMATIC PC Based Automation
- SIMATIC PCS 7
- SIMATIC PG/PC
- SIMATIC S7
- SIMATIC Software
- SIMATIC TDC

Manuals that are not yet available in all 5 languages will at least be included in English and German.

There is an update contract for the SIMATIC Manual Collection that encompasses supply of the up-to-date collection and three subsequent updates which is valid for one year. If the update contract is not cancelled, it is automatically extended and the list price will be charged to the customer.

Ordering data

SIMATIC Manual Collection

Electronic manuals on DVD, multilingual:
LOGO!, SIMADYN, SIMATIC bus components, SIMATIC C7, SIMATIC Distributed I/O, SIMATIC HMI, SIMATIC Sensors, SIMATIC NET, SIMATIC PC Based Automation, SIMATIC PCS 7, SIMATIC PG/PC, SIMATIC S7, SIMATIC Software, SIMATIC TDC

SIMATIC Manual Collection update service for 1 year

Current "Manual Collection" DVD and the three subsequent updates

Article No.

6ES7998-8XC01-8YE0

6ES7998-8XC01-8YE2

Appendix

Standards and approbations

CE marking

Overview

The electronic products described in this catalog comply with the requirements and protection objectives of the following EU directives insofar as they relate to the product concerned. They also comply with the corresponding harmonized European standards (EN) published for these products in the Official Journals of the European Community.

- 2014/30/EU "Electromagnetic Compatibility" (EMC Directive)
- 2014/35/EU "Electrical equipment designed for use within certain voltage limits" (Low Voltage Directive)
- 2014/34/EU "Equipment and protective systems intended for use in potentially explosive atmospheres" (Explosion Protection Directive)
- For ET 200SP fail-safe modules, the following also applies: 2006/42/EC "Machinery Directive"

The originals of the declarations of conformity are kept available by us for the responsible supervisory authorities.

Note on the EMC Directive:

In terms of their interference emissions, SIMATIC products are designed for industrial applications.

If individual products deviate from this specification, it is noted in the catalog with the products.

The installation instructions in the manuals must be adhered to when installing and operating the products described in this catalog. These contain, for example, important information on installation in cabinets and on the use of shielded cables.

Notes for machine manufacturers

The SIMATIC automation system is not a machine within the context of the EU machine guidelines. Therefore a declaration of conformity with regard to the EU machine directive 89/392/EEC or 2006/42/EU (new edition, applicable from end of 2009) may not be provided for SIMATIC.

The EU machine directive regulates the requirements placed on a machine or a part thereof. A machine is understood for the purposes of this guideline to be a combination of interconnected parts or mechanisms (see also EN 292-1, Paragraph 3.1).

SIMATIC is part of the electrical equipment of a machine, and must therefore be integrated into the evaluation of the complete machine by the machine manufacturer.

As electrical equipment, SIMATIC is subject to the low-voltage directive which, as a "total safety directive", covers all dangers just like the machine directive.

The EN 60204-1 standard (safety of machines, general requirements for the electrical equipment of machines) is applicable to the electrical equipment of machines.

The following table will help you in the provision of your declaration of conformity, and shows which criteria according to EN 60204-1 (2006-06) apply to SIMATIC. You can obtain further information from the enclosed declaration of conformity according to the low-voltage and EMC directives (with list of included standards).

EN 60204-1	Topic/criterion	Notes
Paragraph 4	General requirements	The requirements are met when the equipment is assembled/ installed in accordance with the installation guidelines. Please note the relevant information in the manuals.
Paragraph 11.2	Digital input/ output interfaces	The requirements are met
Paragraph 12.3	Programmable equipment	The requirements are met when the equipment is installed in lockable cabinets to protect against alteration of the memory contents by unauthorized persons
Paragraph 20.4	Voltage tests	The requirements are met

Certificates, authorizations, approbations, declarations of conformity

An overview of the certificates available for SIMATIC products (CE, UL, CSA, FM, shipping authorizations) can be found in the internet at

<http://www.siemens.com/simatic/certificates>

The lists are continuously updated. The data for products which have not yet been included in the overview is continuously collected and prepared for the subsequent edition.

You can also find certificates, approbations, verification certificates or characteristic curves under Product support "Entry list"

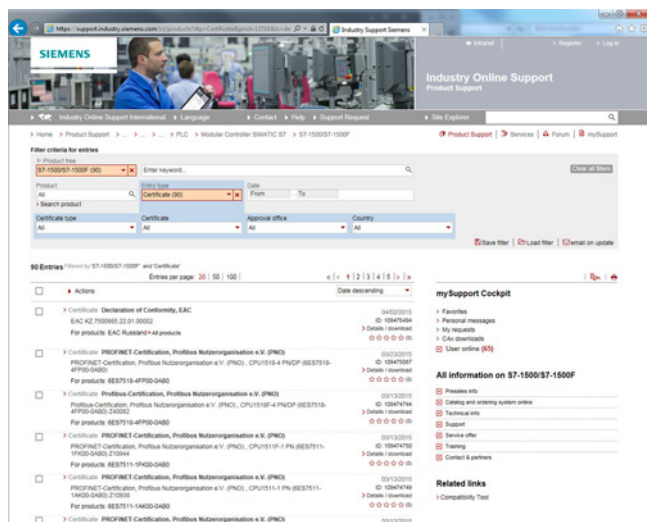

or by going directly to the Link Box:

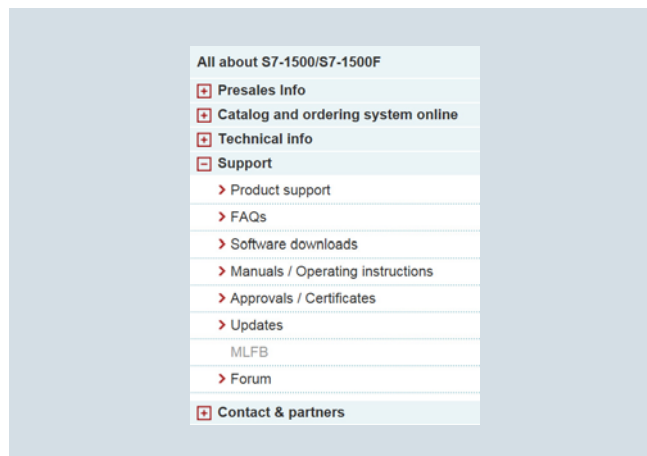

Quality management

The quality management system of the Industry Sector, Industry Automation Division, complies with the international standard ISO 9001.

The products and systems described in this catalog are sold under application of a quality management system certified by DQS in accordance with DIN EN ISO 9001.

The DQS certificate is recognized in all IQ Net countries.

DQS Registered Certificate No.:

Siemens AG

- DF FA
Reg. No.: 001323 QM08

Appendix

Partner at Siemens

Contacts worldwide

Overview

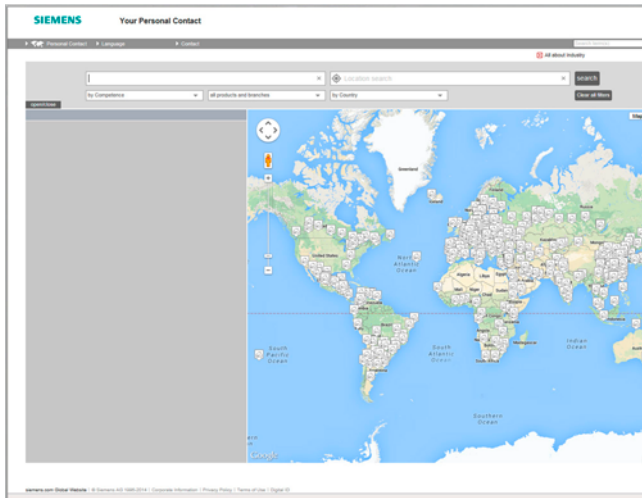

At Siemens we are resolutely pursuing the same goal: long-term improvement of your competitive ability. We are committed to this goal. Thanks to our commitment, we continue to set new standards in automation and drive technology. In all industries – worldwide.

At your service locally, around the globe for consulting, sales, training, service, support, spare parts ... on the entire Digital Factory and Process Industries and Drives.

Your personal contact can be found in our Contacts Database at: www.siemens.com/automation-contact

You start by selecting

- the required competence,
- products and branches,
- a country,
- a city

or by a

- location search or
- person search.

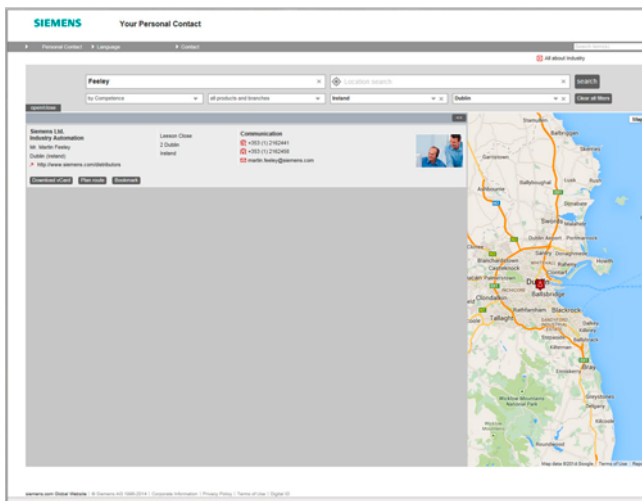
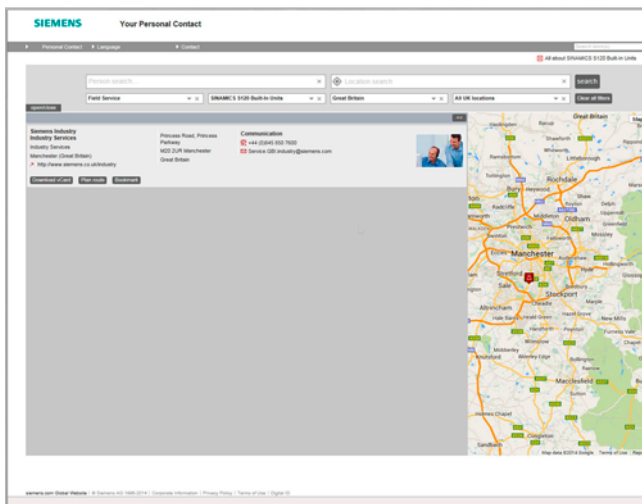

Overview

Siemens Solution und Approved Partners



Highest competence in automation and drive technology as well as power distribution

Siemens works closely together with selected partner companies around the world in order to ensure that customer requirements for all aspects of automation and drives, as well as power distribution, are fulfilled as best as possible – wherever you are, and whatever the time. It is for this reason that we systematically train and keep our partners well prepared, in addition to certifying them in specific technologies. It is our declared intention and goal to train and prepare our partners to the same standards as our own employees.

This approach is based on contractually agreed quality criteria as well as optimum support for our partners by providing clearly defined processes. This ensures that they possess all the qualities to meet customer requirements optimally. The partner emblem is the guarantee and indicator of proven quality.

Solution Partners and Approved Partners

The Siemens Partner Program distinguishes between Solution Partners and Approved Partners.

At present we are working with more than 1,400 Solution Partners worldwide. They represent countless tailored and future-proof automation and drive solutions in the most diverse industries.

With their extensive technical product knowledge, Siemens Approved Partners offer a combination of goods and services that include specialist technologies, customized modifications and the provision of high-quality system and product packages. They also provide qualified technical support and assistance

Partner Finder



In the Siemens global Solution Partner program, customers are certain to find the optimum partner for their specific requirements - with no great effort. The Partner Finder is basically a comprehensive database that showcases the profiles of all our solution partners.

Easy selection:

Set filters in the search screen form according to the criteria that are relevant to you. You can also directly enter the name of an existing partner.

Skills at a glance:

Gain a quick insight into the specific competencies of any particular partner with the reference reports.

Direct contact option:

Use our electronic query form:

www.siemens.com/partnerfinder

Additional information on the Siemens Solution Partner Program is available online at:

www.siemens.com/partner-program

Appendix

Siemens Automation Cooperates with Education

Simplify your education in automation

Unique support for educators and students in educational institutions

Cooperates
with Education

Automation

SIEMENS

Siemens Automation Cooperates with Education (SCE)

offers a global system for sustained support of technical skills. SCE supports educational institutions in their teaching assignment in the industrial automation sector and offers added value in the form of partnerships, technical expertise, and know-how. As the technological leader, our comprehensive range of services can support you in the knowledge transfer for Industry 4.0.

Our services at a glance

- Training curriculums for your lessons
- Trainer packages for hands-on learning
- Courses convey up-to-date specialist knowledge
- Support for your projects / textbooks
- Complete didactic solutions from our partners
- Personal contact for individual support

Training curriculums for your lessons



Use our profound industrial know-how for practice-oriented and individual design of your course. We offer you more than 100 didactically prepared training curriculums on the topics of automation and drives technology free of charge. These materials are perfectly matched to your curricula and syllabuses, and optimally suited for use with our trainer packages. This takes into account all aspects of a modern industrial solution: installation, configuration, programming, and commissioning. All documents, including projects, can be individually matched to your specific requirements.

Particular highlights:

- The new SIMATIC PCS 7 curriculums and trainer packages. Using plant simulation, you can pass on basic, practice-oriented PCS 7 knowledge at universities within about 60 hours (= 1 semester).

- The new TIA Portal training materials for SIMATIC S7-1500 / S7-1200 / S7-300 are available in English, German, French, Italian, Spanish, Portuguese and Chinese for download.

www.siemens.com/sce/curriculum

Trainer packages for hands-on learning



Our SCE trainer packages offer a specific combination of original industrial components which are perfectly matched to your requirements and can be conveniently used in your course. These price-reduced bundles available exclusively to schools include innovative and flexible hardware and software packages.

SCE currently offers more than 80 SCE trainer packages including related equipment e.g. Micro Memory. These cover both the factory and process automation sectors. You can use them to impart the complete course contents on industrial automation at a very low cost.

Trainer packages are available for:

- Introduction to automation technology with LOGO! logic module
- PLC engineering with SIMATIC S7 hardware and STEP 7 software (S7-1500, S7-1200, S7-300 and TIA Portal)
- Operator control and monitoring with SIMATIC HMI
- Industrial networking over bus systems with SIMATIC NET (PROFINET, PROFIBUS, IO-Link)
- Sensor systems with VISION, RFID and SIWAREX
- Process automation with SIMATIC PCS 7
- Networked drive and motion technologies with SINAMICS/SIMOTION
- Power Monitoring Devices SENTRON PAC 4200
- Motor Management SIMOCODE
- CNC programming with SinuTrain

Important ordering notes:

Only the following institutions are authorized to obtain trainer packages: vocational schools, Colleges and Universities, in-house vocational training departments, non commercial research institutions and non commercial training departments.

To purchase a trainer package, you require a specific end-use certificate, which you can obtain from your regional sales office.

www.siemens.com/sce/tp

Unique support for educators and students in educational institutions (continued)**Courses convey up-to-date specialist knowledge**

Profit from our excellent know-how as the leader in industrial technologies. We offer you specific courses for automation and drive technology worldwide. These support you in the practice-oriented transferring of product and system know-how, are in conformance with curriculums, and derived from the training fields. Compact technical courses especially for use at universities are also available.

Our range of courses comprises a wide variety of training modules based on the principle of Totally Integrated Automation (TIA). The focus is on the same subject areas as with the SCE trainer packages.

Every PLC and drive course is oriented on state-of-the-art technology. Your graduates can thus be prepared optimally for their future professional life.

In some countries we are offering classes based on our training curriculums. Please inquire with your SCE contact partner.

www.siemens.com/sce/courses

Support for your projects/textbooks

Automation and drive technology is characterized by continuous and rapid developments. Service and Support therefore play an important role.

We can provide you with consulting for selected projects and support from your personal SCE contact as well as our web-based and regional Customer Support.

As a particular service, SCE supports technical authors with our know-how as well as with intensive technical consulting. Siemens library of special textbooks covering the industrial automation sector provides an additional resource for you and your students. These can be found at the SCE web site.

www.siemens.com/sce/contact
www.siemens.com/sce/books

Complete didactic solutions from our partners

Our partners for learning systems offer a wide range of training systems and solutions for use in your courses or laboratory.

These models have been designed based on our trainer packages and thus save you the time and cost of selfconstruction of individual components. The Partner systems provide you with simple and effective help in the fulfillment of your teaching assignment.

www.siemens.com/sce/partner

Contact for individual support

You can find your personal SCE contact on our Internet site. Your local SCE Promoter will answer all your questions concerning the complete SCE offering, and provide you with timely and competent information about innovations. When you encounter challenges, you can profit from our global team of excellence.

If a direct SCE contact is not listed for your country, please contact your local Siemens office.

www.siemens.com/sce/contact

SCE Support Finder for your Internet request

You are an educator and need support on the topic of industry automation? Send us your request:

www.siemens.com/sce/supportfinder

Discover
SCE



Appendix

Online Services

Information and Ordering Options on the Internet and DVD

The Future of Manufacturing on the Internet



Detailed knowledge of the range of products and services available is essential when planning and engineering automation systems. It goes without saying that this information must always be as up-to-date as possible.

Industry is on the threshold of the fourth industrial revolution as digitization now follows after the automation of production. The goals are to increase productivity and efficiency, speed, and quality. In this way, companies can remain competitive on the path to the future of industry.

You will find everything you need to know about products, systems and services on the internet at:

www.siemens.com/industry

Product Selection Using the Interactive CA 01 Automation and Drives Catalog

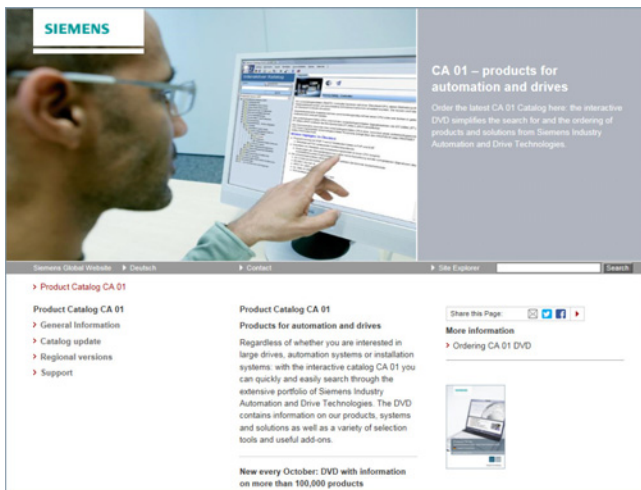

Detailed information together with user-friendly interactive functions:

The CA 01 interactive catalog covers more than 100,000 products, thus providing a comprehensive overview of the product range provided by Siemens.

You will find everything you need here for solving tasks in the fields of automation, switching, installation and drives. All information is provided over a user interface that is both user-friendly and intuitive.

You can order the CA 01 product catalog from your Siemens sales contact or in the Information and Download Center:

www.siemens.com/industry/infocenter

Information about the CA 01 interactive catalog can be found on the Internet at:

www.siemens.com/automation/ca01

or on DVD.

Easy Shopping with the Industry Mall

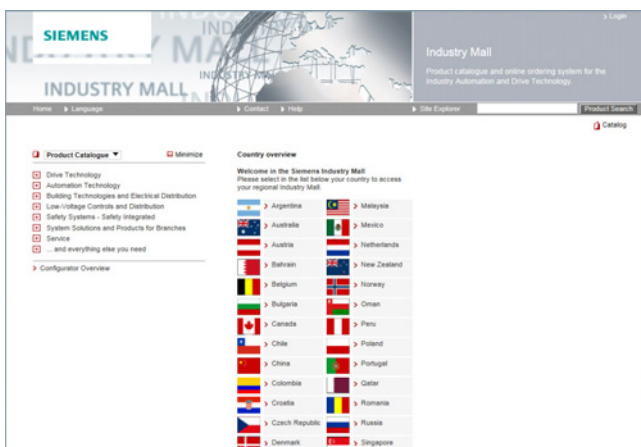

The Industry Mall is the electronic ordering platform of Siemens AG on the Internet. Here you have online access to a huge range of products presented in an informative and attractive way.

Data transfer via EDIFACT allows the whole procedure, from selection through ordering to tracking and tracing, to be carried out online. Availability checks, customer-specific discounts and bid creation are also possible.

Numerous additional functions are provided for your support. For example, powerful search functions make it easy to select the required products. Configurators enable you to configure complex product and system components quickly and easily. CAx data types are also provided here.

You can find the Industry Mall on the Internet at:

www.siemens.com/industrymall

Downloading Catalogs

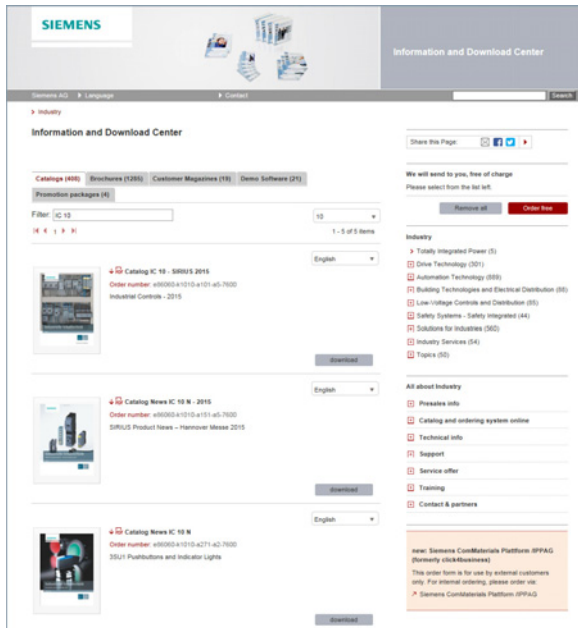

In addition to numerous other useful documents, you can also find the catalogs listed on the back inside cover of this catalog in the Information and Download Center. You can download these catalogs in PDF format without having to register.

The filter dialog above the first catalog displayed makes it possible to carry out targeted searches. If you enter "MD 3" for example, you will find both the MD 30.1 and MD 31.1 catalogs. If you enter "IC 10", both the IC 10 catalog and the associated news or add-ons are displayed.

Visit us at:

www.siemens.com/industry/infocenter

Social and Mobile Media

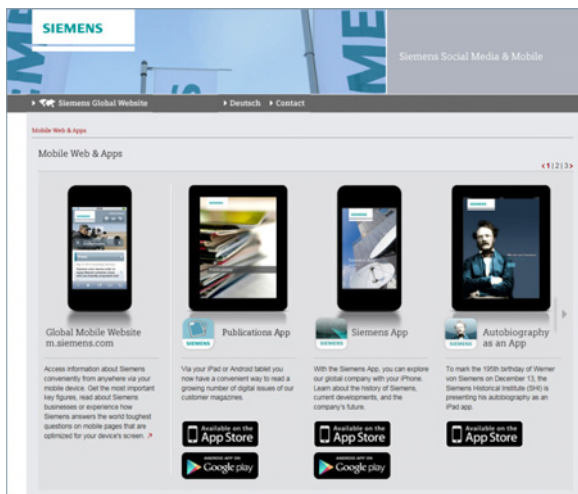

Connect with Siemens through social media: visit our social networking sites for a wealth of useful information, demos on products and services, the opportunity to provide feedback, to exchange information and ideas with customers and other Siemens employees, and much, much more. Stay in the know and follow us on the ever-expanding global network of social media.

To find out more about Siemens' current social media activities, visit us at:

www.siemens.com/socialmedia

Or via our product pages at:

www.siemens.com/automation or www.siemens.com/drives

Connect with Siemens Industry at our central access point to read all the news on the future of manufacturing, watch current videos and inform yourself about all the latest industry developments:

www.siemens.com/future-of-manufacturing

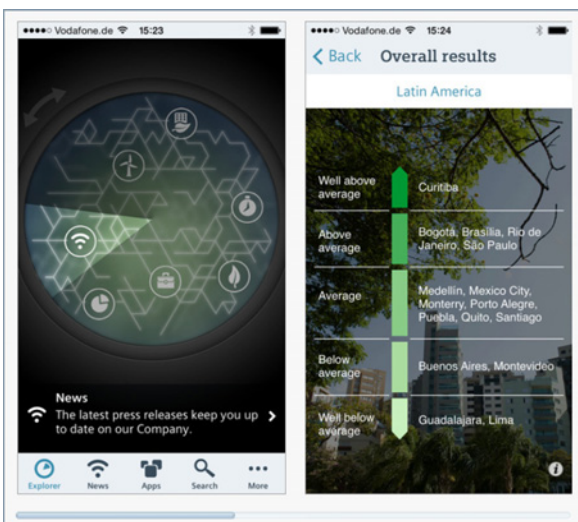

Discover the world of Siemens.

We are also constantly expanding our offering of cross-platform apps for smartphones and tablets. You will find the current Siemens apps at the App Store (iOS) or at Google Play (Android):

<https://itunes.apple.com/en/app/siemens/id452698392?mt=8>

<https://play.google.com/store/search?q=siemens>

The Siemens app, for example, tells you all about the history, latest developments and future plans of the company – with informative pictures, fascinating reports and the most recent press releases.

Appendix

Industry Services

Overview

Unleash potential – with services from Siemens

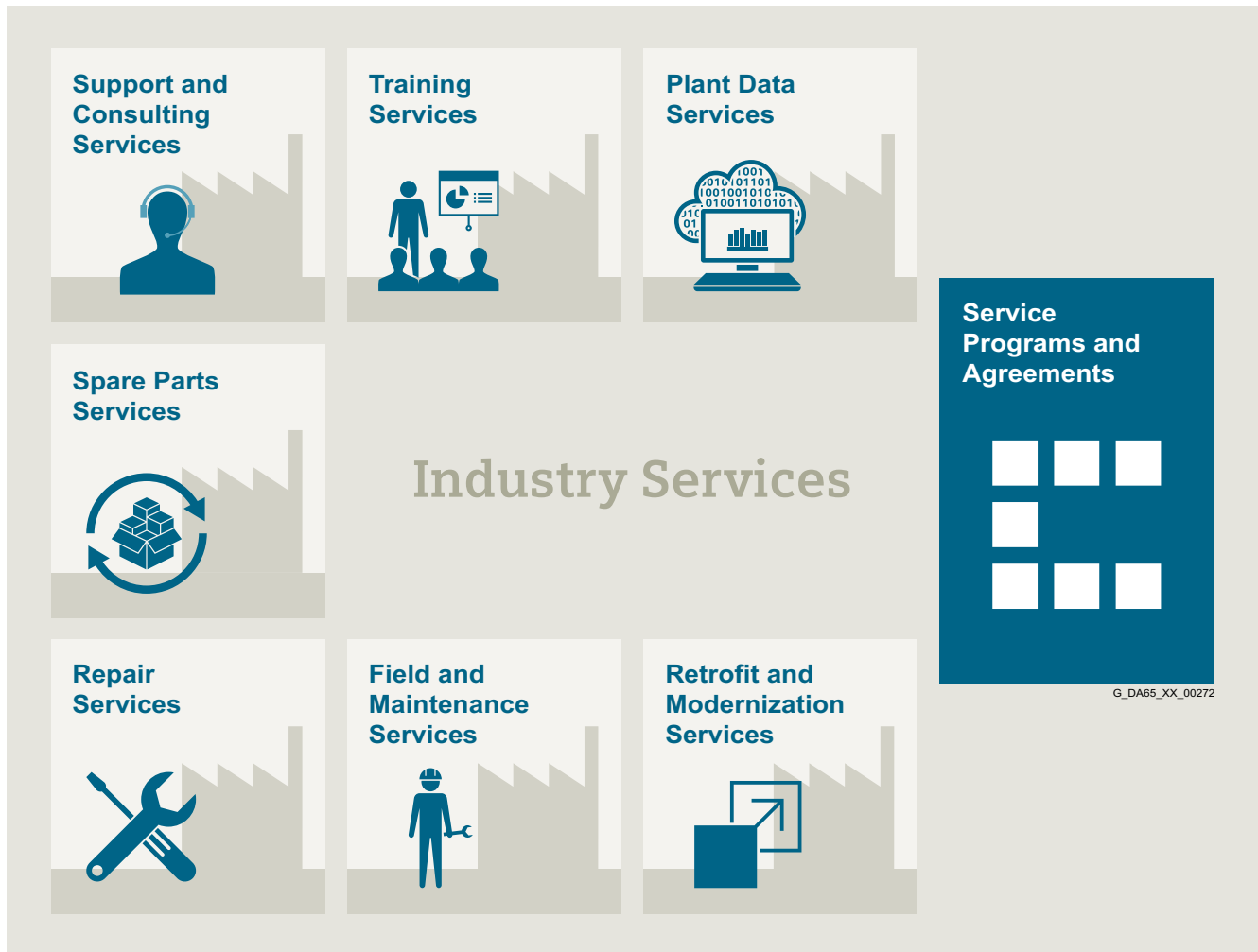

Increase your performance – with Industry Services

Optimizing the productivity of your equipment and operations can be a challenge, especially with constantly changing market conditions. Working with our service experts makes it easier. We understand your industry's unique processes and provide the services needed so that you can better achieve your business goals.

You can count on us to maximize your uptime and minimize your downtime, increasing your operations' productivity and reliability. When your operations have to be changed quickly to meet a new demand or business opportunity, our services give you the flexibility to adapt. Of course, we take care that your production is protected against cyber threats. We assist in keeping your operations as energy and resource efficient as possible and reducing your total cost of ownership. As a trendsetter, we ensure that you can capitalize on the opportunities of digitalization and by applying data analytics to enhance decision making: You can be sure that your plant reaches its full potential and retains this over the longer lifespan.

You can rely on our highly dedicated team of engineers, technicians and specialists to deliver the services you need – safely, professionally and in compliance with all regulations. We are there for you, where you need us, when you need us.

Overview

Plant Data Services



Make your industrial processes transparent to gain improvements in productivity, asset availability, and energy efficiency. Production data is generated, filtered and translated with intelligent analytics to enhance decision-making. This is done whilst taking data security into consideration and with continuous protection against cyber attack threats.

www.industry.siemens.com/services/global/en/portfolio/plant-data-services/Pages/index.aspx

Training Services



From the basics and advanced to specialist skills, SITRAIN courses provide expertise right from the manufacturer – and encompass the entire spectrum of Siemens products and systems for the industry.

Worldwide, SITRAIN courses are available wherever you need a training course in more than 170 locations in over 60 countries.

www.industry.siemens.com/services/global/en/portfolio/training/Pages/index.aspx

Support and Consulting Services



Industry Online Support site for comprehensive information, application examples, FAQs and support requests.

Technical and Engineering Support for advice and answers for all inquiries about functionality, handling, and fault clearance.

Information & Consulting Services, e.g. SIMATIC System Audit; clarity about the state and service capability of your automation system or Lifecycle Information Services; transparency on the lifecycle of the products in your plants.

www.industry.siemens.com/services/global/en/portfolio/support-consulting/Pages/index.aspx

Spare Parts Services



Are available worldwide for smooth and fast supply of spare parts – and thus optimal plant availability. Genuine spare parts are available for up to ten years. Logistic experts take care of procurement, transport, custom clearance, storage and order management. Reliable logistics processes ensure that components reach their destination as needed.

Asset optimization services help you design a strategy for parts supply where your investment and carrying costs are reduced and the risk of obsolescence is avoided.

www.industry.siemens.com/services/global/en/portfolio/spare_parts/Pages/index.aspx

Appendix

Industry Services

Industry Services – Portfolio overview

Overview (continued)

Repair Services



Are offered on-site and in regional repair centers for fast restoration of faulty devices' functionality.

Also available are extended repair services, which include additional diagnostic and repair measures, as well as emergency services.

www.industry.siemens.com/services/global/en/portfolio/repair_services/Pages/index.aspx

Retrofit and Modernization Services



Provide a cost-effective solution for the expansion of entire plants, optimization of systems or upgrading existing products to the latest technology and software, e.g. migration services for automation systems.

Service experts support projects from planning through commissioning and, if desired over the entire extended lifespan, e.g. Retrofit for Integrated Drive Systems for an extended lifetime of your machines and plants

www.industry.siemens.com/services/global/en/portfolio/retrofit-modernization/Pages/index.aspx

Field and Maintenance Services

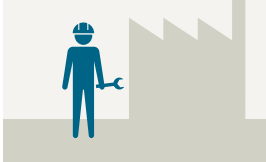

Siemens specialists are available globally to provide expert field and maintenance services, including commissioning, functional testing, preventive maintenance and fault clearance. All services can be included in customized service agreements with defined reaction times or fixed maintenance intervals.

www.industry.siemens.com/services/global/en/portfolio/field_service/Pages/index.aspx

Service Programs and Agreements

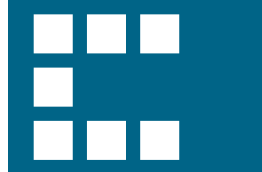

A technical Service Program or Agreement enables you to easily bundle a wide range of services into a single annual or multi-year agreement.

You pick the services you need to match your unique requirements or fill gaps in your organization's maintenance capabilities.

Programs and agreements can be customized as KPI-based and/or performance-based contracts.

www.industry.siemens.com/services/global/en/portfolio/service_programs/Pages/index.aspx

Overview

Online Support is a comprehensive information system for all questions relating to products, systems, and solutions that Siemens has developed for industry over time. With more than 300,000 documents, examples and tools, it offers users of automation and drive technology a way to quickly find up-to-date information. The 24-hour service enables direct, central access to detailed product information as well as numerous solution examples for programming, configuration and application.

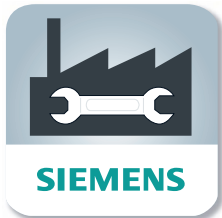
Online Support App

Using the Online Support app, you can access over 300,000 documents covering all Siemens industrial products – anywhere, any time. Regardless of whether you need help implementing your project, fault-finding, expanding your system or are planning a new machine.

You have access to FAQs, manuals, certificates, characteristic curves, application examples, product notices (e.g. announcements of new products) and information on successor products in the event that a product is discontinued.

Just scan the product code printed on the product directly using the camera of your mobile device to immediately see all technical information available on this product at a glance. The graphical CAx information (3D model, circuit diagrams or EPLAN macros) is also displayed. You can forward this information to your workplace using the e-mail function.

The search function retrieves product information and articles and supports you with a personalized suggestion list. You can find your favorite pages – articles you need frequently – under “mySupport”. You also receive selected news on new functions, important articles or events in the News section.

The content, in six languages, is increasingly multimedia-based – and now also available as a mobile app. Online support’s “Technical Forum” offers users the opportunity to share information with each other. The “Support Request” option can be used to contact Siemens’ technical support experts. The latest content, software updates, and news via newsletters and Twitter ensure that industry users are always up to date.

www.siemens.com/industry/onlinesupport

Scan the QR code
for information on
our Online Support
app.



The app is available free of charge from the Apple App Store (iOS) or from Google Play (Android).

<https://support.industry.siemens.com/cs/ww/en/sc/2067>

Appendix

Software licenses

Overview

Software types

Software requiring a license is categorized into types. The following software types have been defined:

- Engineering software
- Runtime software

Engineering software

This includes all software products for creating (engineering) user software, e.g. for configuring, programming, parameterizing, testing, commissioning or servicing.

Data generated with engineering software and executable programs can be duplicated for your own use or for use by third-parties free-of-charge.

Runtime software

This includes all software products required for plant/machine operation, e.g. operating system, basic system, system expansions, drivers, etc.

The duplication of the runtime software and executable programs created with the runtime software for your own use or for use by third-parties is subject to a charge.

You can find information about license fees according to use in the ordering data (e.g. in the catalog). Examples of categories of use include per CPU, per installation, per channel, per instance, per axis, per control loop, per variable, etc.

Information about extended rights of use for parameterization/configuration tools supplied as integral components of the scope of delivery can be found in the readme file supplied with the relevant product(s).

License types

Siemens Industry Automation & Drive Technologies offers various types of software license:

- Floating license
- Single license
- Rental license
- Rental floating license
- Trial license
- Demo license
- Demo floating license

Floating license

The software may be installed for internal use on any number of devices by the licensee. Only the concurrent user is licensed. The concurrent user is the person using the program. Use begins when the software is started. A license is required for each concurrent user.

Single license

Unlike the floating license, a single license permits only one installation of the software per license.

The type of use licensed is specified in the ordering data and in the Certificate of License (CoL). Types of use include for example per instance, per axis, per channel, etc.

One single license is required for each type of use defined.

Rental license

A rental license supports the "sporadic use" of engineering software. Once the license key has been installed, the software can be used for a specific period of time (the operating hours do not have to be consecutive).

One license is required for each installation of the software.

Rental floating license

The rental floating license corresponds to the rental license, except that a license is not required for each installation of the software. Rather, one license is required per object (for example, user or device).

Trial license

A trial license supports "short-term use" of the software in a non-productive context, e.g. for testing and evaluation purposes. It can be transferred to another license.

Demo license

The demo license support the "sporadic use" of engineering software in a non-productive context, for example, use for testing and evaluation purposes. It can be transferred to another license. After the installation of the license key, the software can be operated for a specific period of time, whereby usage can be interrupted as often as required.

One license is required per installation of the software.

Demo floating license

The demo floating license corresponds to the demo license, except that a license is not required for each installation of the software. Rather, one license is required per object (for example, user or device).

Certificate of License (CoL)

The CoL is the licensee's proof that the use of the software has been licensed by Siemens. A CoL is required for every type of use and must be kept in a safe place.

Downgrading

The licensee is permitted to use the software or an earlier version/release of the software, provided that the licensee owns such a version/release and its use is technically feasible.

Delivery versions

Software is constantly being updated. The following delivery versions

- PowerPack
- Upgrade

can be used to access updates.

Existing bug fixes are supplied with the ServicePack version.

PowerPack

PowerPacks can be used to upgrade to more powerful software. The licensee receives a new license agreement and CoL (Certificate of License) with the PowerPack. This CoL, together with the CoL for the original product, proves that the new software is licensed.

A separate PowerPack must be purchased for each original license of the software to be replaced.

Upgrade

An upgrade permits the use of a new version of the software on the condition that a license for a previous version of the product is already held.

The licensee receives a new license agreement and CoL with the upgrade. This CoL, together with the CoL for the previous product, proves that the new version is licensed.

A separate upgrade must be purchased for each original license of the software to be upgraded.

Overview**ServicePack**

ServicePacks are used to debug existing products. ServicePacks may be duplicated for use as prescribed according to the number of existing original licenses.

License key

Siemens Industry Automation & Drive Technologies supplies software products with and without license keys.

The license key serves as an electronic license stamp and is also the "switch" for activating the software (floating license, rental license, etc.).

The complete installation of software products requiring license keys includes the program to be licensed (the software) and the license key (which represents the license).

Software Update Service (SUS)

As part of the SUS contract, all software updates for the respective product are made available to you free of charge for a period of one year from the invoice date. The contract will automatically be extended for one year if it is not canceled three months before it expires.

The possession of the current version of the respective software is a basic condition for entering into an SUS contract.

You can download explanations concerning license conditions from www.siemens.com/automation/salesmaterial-as/catalog/en/terms_of_trade_en.pdf

Appendix

Conditions of sale and delivery

1. General Provisions

By using this catalog you can acquire hardware and software products described therein from Siemens AG subject to the following Terms and Conditions of Sale and Delivery (hereinafter referred to as "T&C"). Please note that the scope, the quality and the conditions for supplies and services, including software products, by any Siemens entity having a registered office outside Germany, shall be subject exclusively to the General Terms and Conditions of the respective Siemens entity. The following T&C apply exclusively for orders placed with Siemens Aktiengesellschaft, Germany.

1.1 For customers with a seat or registered office in Germany

For customers with a seat or registered office in Germany, the following applies subordinate to the T&C:

- the "General Terms of Payment"¹⁾ and,
- for software products, the "General License Conditions for Software Products for Automation and Drives for Customers with a Seat or Registered Office in Germany"¹⁾ and,
- for other supplies and services, the "General Conditions for the Supply of Products and Services of the Electrical and Electronics Industry"¹⁾.

1.2 For customers with a seat or registered office outside Germany

For customers with a seat or registered office outside Germany, the following applies subordinate to the T&C:

- the "General Terms of Payment"¹⁾ and,
- for software products, the "General License Conditions for Software Products for Automation and Drives for Customers with a Seat or Registered Office outside of Germany"¹⁾ and
- for other supplies and/or services, the "General Conditions for Supplies of Siemens Industry for Customers with a Seat or Registered Office outside of Germany"¹⁾.

2. Prices

The prices are in € (Euro) ex point of delivery, exclusive of packaging.

The sales tax (value added tax) is not included in the prices. It shall be charged separately at the respective rate according to the applicable statutory legal regulations.

Prices are subject to change without prior notice. We will charge the prices valid at the time of delivery.

To compensate for variations in the price of raw materials (e.g. silver, copper, aluminum, lead, gold, dysprosium and neodym), surcharges are calculated on a daily basis using the so-called metal factor for products containing these raw materials. A surcharge for the respective raw material is calculated as a supplement to the price of a product if the basic official price of the raw material in question is exceeded.

The metal factor of a product indicates the basic official price (for those raw materials concerned) as of which the surcharges on the price of the product are applied, and with what method of calculation.

An exact explanation of the metal factor can be downloaded at:

www.siemens.com/automation/salesmaterial-as/catalog/en/terms_of_trade_en.pdf

To calculate the surcharge (except in the cases of dysprosium and neodym), the official price from the day prior to that on which the order was received or the release order was effected is used.

To calculate the surcharge applicable to dysprosium and neodym ("rare earths"), the corresponding three-month basic average price in the quarter prior to that in which the order was received or the release order was effected is used with a one-month buffer (details on the calculation can be found in the explanation of the metal factor).

3. Additional Terms and Conditions

The dimensions are in mm. In Germany, according to the German law on units in measuring technology, data in inches apply only to devices for export.

Illustrations are not binding.

Insofar as there are no remarks on the individual pages of this catalog - especially with regard to data, dimensions and weights given - these are subject to change without prior notice.

4. Export regulations

We shall not be obligated to fulfill any agreement if such fulfillment is prevented by any impediments arising out of national or international foreign trade or customs requirements or any embargoes and/or other sanctions.

Export of goods listed in this catalog may be subject to licensing requirements. We will indicate in the delivery details whether licenses are required under German, European and US export lists. Goods labeled with "AL" not equal to "N" are subject to European or German export authorization when being exported out of the EU. Goods labeled with "ECCN" not equal to "N" are subject to US re-export authorization.

The export indications can be viewed in advance in the description of the respective goods on the Industry Mall, our online catalog system. Only the export labels "AL" and "ECCN" indicated on order confirmations, delivery notes and invoices are authoritative.

Even without a label, or with label "AL:N" or "ECCN:N", authorization may be required i .a. due to the final disposition and intended use of goods.

If you transfer goods (hardware and/or software and/or technology as well as corresponding documentation, regardless of the mode of provision) delivered by us or works and services (including all kinds of technical support) performed by us to a third party worldwide, you must comply with all applicable national and international (re-)export control regulations.

If required for the purpose of conducting export control checks, you (upon request by us) shall promptly provide us with all information pertaining to the particular end customer, final disposition and intended use of goods delivered by us respectively works and services provided by us, as well as to any export control restrictions existing in this relation.

The products listed in this catalog may be subject to European/German and/or US export regulations. Any export requiring approval is therefore subject to authorization by the relevant authorities.

Errors excepted and subject to change without prior notice.

1) The text of the Terms and Conditions of Siemens AG can be downloaded at www.siemens.com/automation/salesmaterial-as/catalog/en/terms_of_trade_en.pdf

Further information can be obtained from our branch offices listed at www.siemens.com/automation-contact

Interactive Catalog on DVD Products for Automation and Drives	<i>Catalog</i> CA 01	Low-Voltage Power Distribution and Electrical Installation Technology SENTRON · SIVACON · ALPHA Protection, Switching, Measuring and Monitoring Devices, Switchboards and Distribution Systems Standards-Compliant Components for Photovoltaic Plants Electrical Components for the Railway Industry TÜV-certified Power Monitoring System Components for Industrial Control Panels according to UL Standards 3WT Air Circuit Breakers up to 4000 A 3VT Molded Case Circuit Breakers up to 1600 A <i>Digital: SIVACON System Cubicles, System Lighting and System Air-Conditioning</i> <i>Digital: ALPHA Distribution Systems</i> ALPHA FIX Terminal Blocks SIVACON S4 Power Distribution Boards SIVACON 8PS Busbar Trunking Systems <i>Digital: DELTA Switches and Socket Outlets</i>	<i>Catalog</i> LV 10 LV 11 LV 12 LV 14 LV 16 LV 35 LV 36 LV 50 LV 51 LV 52 LV 56 LV 70 ET D1
Building Control GAMMA Building Control	ET G1	Motion Control SINUMERIK 840 Equipment for Machine Tools SINUMERIK 808 Equipment for Machine Tools SINUMERIK 828 Equipment for Machine Tools SIMOTION Equipment for Production Machines <i>Digital: Drive and Control Components for Cranes</i>	NC 62 NC 81.1 NC 82 PM 21 CR 1
Drive Systems SINAMICS G130 Drive Converter Chassis Units SINAMICS G150 Drive Converter Cabinet Units SINAMICS GM150, SINAMICS SM150 Medium-Voltage Converters SINAMICS PERFECT HARMONY GH180 Medium-Voltage Air-Cooled Drives (Germany Edition) SINAMICS G180 Converters – Compact Units, Cabinet Systems, Cabinet Units Air-Cooled and Liquid-Cooled SINAMICS S120 Chassis Format Units and Cabinet Modules SINAMICS S150 Converter Cabinet Units SINAMICS S120 and SIMOTICS SINAMICS DCM DC Converter, Control Module SINAMICS DCM Cabinet SINAMICS Inverters for Single-Axis Drives and SIMOTICS Motors <i>Digital: SINAMICS G120P and SINAMICS G120P Cabinet pump, fan, compressor converters</i> LOHER VARIO High Voltage Motors Flameproof, Type Series 1PS4, 1PS5, 1MV4 and 1MV5 Frame Size 355 to 1000, Power Range 80 to 7100 kW Three-Phase Induction Motors SIMOTICS HV, SIMOTICS TN High Voltage Three-phase Induction Motors SIMOTICS HV Series A-compact PLUS Three-Phase Induction Motors SIMOTICS HV, Series H-compact Synchronous Motors with Permanent-Magnet Technology, HT-direct DC Motors SIMOREG DC MASTER 6RA70 Digital Chassis Converters SIMOREG K 6RA22 Analog Chassis Converters <i>Digital: SIMOREG DC MASTER 6RM70 Digital Converter Cabinet Units</i> SIMOVERT PM Modular Converter Systems SIEMOSYN Motors MICROMASTER 420/430/440 Inverters MICROMASTER 411/COMBIMASTER 411 <u>Low-Voltage Three-Phase-Motors</u> SIMOTOCS S-1FG1 Servo geared motors SIMOTICS Low-Voltage Motors SIMOTICS FD Low-Voltage Motors LOHER Low-Voltage Motors MOTOX Geared Motors SIMOGEAR Geared Motors SIMOGEAR Gearboxes with adapter <u>Mechanical Driving Machines</u> FLENDER Standard Couplings FLENDER High Performance Couplings FLENDER Backlash-free Couplings FLENDER SIP Standard industrial planetary gear units	D 11 D 12 D 15.1 D 18.1 D 21.3 D 21.4 D 23.1 D 23.2 D 31 D 35 D 83.2 D 84.1 D 84.9 D 86.1 D 86.2 DA 12 DA 21.1 DA 21.2 DA 22 DA 45 DA 48 DA 51.2 DA 51.3 D 41 D 81.1 D 81.8 D 83.1 D 87.1 MD 50.1 MD 50.11 MD 10.1 MD 10.2 MD 10.3 MD 31.1	Power Supply SITOP Power supply	KT 10.1
Process Instrumentation and Analytics <i>Digital: Field Instruments for Process Automation</i> <i>Digital: Display Recorders SIREC D</i> <i>Digital: SIPART Controllers and Software</i> Products for Weighing Technology Process Analytical Instruments <i>Digital: Process Analytics, Components for Continuous Emission Monitoring</i>	FI 01 MP 20 MP 31 WT 10 AP 01 AP 11	Safety Integrated Safety Technology for Factory Automation	SI 10
		SIMATIC HMI / PC-based Automation Human Machine Interface Systems/ PC-based Automation	ST 80/ ST PC
		SIMATIC Ident Industrial Identification Systems	ID 10
		SIMATIC Industrial Automation Systems Products for Totally Integrated Automation SIMATIC PCS 7 Process Control System System components SIMATIC PCS 7 Process Control System Technology components Add-ons for the SIMATIC PCS 7 Process Control System SIMATIC S7-400 advanced controller	ST 70 ST PCS 7 ST PCS 7 T ST PCS 7 AO ST 400
		SIMATIC NET Industrial Communication	IK PI
		SIRIUS Industrial Controls SIRIUS Industrial Controls	IC 10
		<i>Digital: These catalogs are only available as a PDF.</i>	
		Information and Download Center Digital versions of the catalogs are available on the Internet at: www.siemens.com/industry/infocenter There you'll find additional catalogs in other languages. Please note the section "Downloading catalogs" on page "Online services" in the appendix of this catalog.	

Siemens AG
Digital Factory Division
Factory Automation
Postfach 48 48
90026 Nürnberg
Germany

© Siemens AG 2017
Subject to change without prior notice
Article No. E86060-K4670-A101-B6-7600
W-FPN7Z-DF-FAK06 / Dispo 07900
KG 0517 2.4 PAS 1368 En
Printed in Germany

The information provided in this catalog contains merely general descriptions or characteristics of performance which in case of actual use do not always apply as described or which may change as a result of further development of the products. An obligation to provide the respective characteristics shall only exist if expressly agreed in the terms of contract. Availability and technical specifications are subject to change without notice.

All product designations may be trademarks or product names of Siemens AG or supplier companies whose use by third parties for their own purposes could violate the rights of the owners.

Security information

Siemens provides products and solutions with industrial security functions that support the secure operation of plants, systems, machines and networks.

In order to protect plants, systems, machines and networks against cyber threats, it is necessary to implement – and continuously maintain – a holistic, state-of-the-art industrial security concept. Siemens' products and solutions constitute one element of such a concept.

Customers are responsible for preventing unauthorized access to their plants, systems, machines and networks. Such systems, machines and components should only be connected to an enterprise network or the internet if and to the extent such a connection is necessary and only when appropriate security measures (e.g. firewalls and/or network segmentation) are in place.

For additional information on industrial security measures that may be implemented, please visit <http://www.siemens.com/industrialsecurity>.

Siemens' products and solutions undergo continuous development to make them more secure. Siemens strongly recommends that product updates are applied as soon as they are available and that the latest product versions are used. Use of product versions that are no longer supported, and failure to apply the latest updates may increase customer's exposure to cyber threats.

To stay informed about product updates, subscribe to the Siemens Industrial Security RSS Feed under <http://www.siemens.com/industrialsecurity>.