

**SIEMENS**

*Ingenuity for life*

*Industry Online Support*

*Home*

# S7 Communication between SIMATIC S7-1500 and SIMATIC S7-300

STEP 7 V16 / BSEND / BRCV

<https://support.industry.siemens.com/cs/ww/en/view/18516182>

Siemens  
Industry  
Online  
Support



---

This entry originates from Siemens Industry Online Support. The conditions of use specified there apply ([www.siemens.com/nutzungsbedingungen](http://www.siemens.com/nutzungsbedingungen)).

## Security Information

Siemens provides products and solutions with industrial security functions that support the secure operation of plants, systems, machines and networks.

In order to protect plants, systems, machines and networks against cyber threats, it is necessary to implement – and continuously maintain – a holistic, state-of-the-art industrial security concept. Siemens' products and solutions only form one element of such a concept.

Customers are responsible to prevent unauthorized access to their plants, systems, machines and networks. Systems, machines and components should only be connected to the enterprise network or the internet if and to the extent necessary and with appropriate security measures (e.g. use of firewalls and network segmentation) in place.

Additionally, Siemens' guidance on appropriate security measures should be taken into account. For more information about industrial security, please visit <http://www.siemens.com/industrialsecurity>.

Siemens' products and solutions undergo continuous development to make them more secure. Siemens strongly recommends to apply product updates as soon as available and to always use the latest product versions. Use of product versions that are no longer supported, and failure to apply latest updates may increase the customer's exposure to cyber threats.

To stay informed about product updates, subscribe to the Siemens Industrial Security RSS Feed under <http://www.siemens.com/industrialsecurity>.

---

# Contents

|          |  |           |
|----------|--|-----------|
| <b>1</b> | <b>Introduction</b> .....  | <b>4</b>  |
| <b>2</b> | <b>Configuration</b> .....   | <b>6</b>  |
| 2.1      | Create the Hardware Configuration .....  | 6         |
| 2.1.1    | Create the Hardware Configuration in STEP 7 V16.....                               | 6         |
| 2.1.2    | Create Hardware Configuration in STEP 7 V5.....                                    | 8         |
| 2.2      | Configuration of the S7 Connection .....   | 13        |
| 2.2.1    | Graphical Configuration of the S7 Connection.....                                  | 13        |
| 2.2.2    | Configuration of the S7 Connection with Unspecified Partner .....                  | 16        |
| 2.3      | Permit Access with PUT/GET Communication from Remote Partner.....                  | 24        |
| <b>3</b> | <b>User Program of the S7 CPU</b> .....  | <b>25</b> |
| 3.1      | Overview.....  | 25        |
| 3.2      | Create Send and Receive Data Areas .....   | 26        |
| 3.2.1    | DB1 "RecvData" .....   | 26        |
| 3.2.2    | DB2 "SendData" .....   | 27        |
| 3.3      | Create Variables for Parameters of Function Blocks "BsendData" and "BrcvData"..... | 27        |
| 3.3.1    | PLC Data Type "typeBsend" .....  | 28        |
| 3.3.2    | PLC Data Type "typeBrcv" .....   | 28        |
| 3.3.3    | PLC Data Type "typeDiagnostic" .....   | 29        |
| 3.4      | FB "BsendData" .....   | 30        |
| 3.4.1    | S7-1500 CPU .....  | 30        |
| 3.4.2    | S7-300 CPU .....   | 32        |
| 3.4.3    | Assign Parameters of FB "BsendData" .....  | 33        |
| 3.5      | FB "BrcvData" .....  | 34        |
| 3.5.1    | S7-1500 CPU .....  | 34        |
| 3.5.2    | S7-300 CPU .....   | 36        |
| 3.5.3    | Assign Parameters of FB "BrcvData" .....   | 37        |
| 3.6      | Function.....  | 38        |
| 3.6.1    | Overview.....  | 38        |
| 3.6.2    | Description of the States .....  | 40        |
| 3.7      | Error Handling .....   | 43        |
| 3.7.1    | FB "BsendData" .....   | 43        |
| 3.7.2    | FB "BrcvData" .....  | 43        |
| <b>4</b> | <b>Information</b> .....   | <b>44</b> |
| 4.1      | Notes on using "BSEND" .....   | 44        |
| 4.2      | Notes on using "BRCV" .....  | 44        |
| 4.3      | Configuration of the "BSEND" and "BRCV" Instructions.....                          | 45        |

# 1 Introduction

You can use S7 Communication, for example, for data transfer via the integrated PROFINET interface and Industrial Ethernet interface of the S7 CPUs.

The following instructions are available for S7 Communication:

- BSEND for sending data
- BRCV for receiving data

The S7 connection has to be configured on both sides, because S7 communication via the "BSEND" and "BRCV" services is based on the client-client principle.

In STEP 7 V16 (TIA Portal) you will find the "BSEND" and "BRCV" instructions in the "Instructions" task card under "Communication > S7 Communication".

In STEP 7 V5, depending on the interface used for the data exchange, you call the following version of SFB/FB 12 "BSEND" and SFB/FB 13 "BRCV" in your user program:

- Integrated PROFINET interface of the S7-300, IM151-8 PN/DP or IM154-8 CPU: Use FB12 "BSEND" and FB13 "BRCV" from the Standard Library under "Communication Blocks > Blocks".
- CP 343-1 or CP 342-5: Use FB12 "BSEND" and FB13 "BRCV" from the "SIMATIC\_NET\_CP" library under "CP 300 Blocks".
- S7-400: Use SFB12 "BSEND" and SFB13 "BRCV" from the Standard Library under "System Function Blocks > Blocks".

The example describes how to configure an S7 connection between an S7-1500 CPU and an S7-300 CPU to exchange data between the S7-1500 CPU and the S7-300 CPU using the "BSEND" and "BRCV" instructions.

Figure 1-1

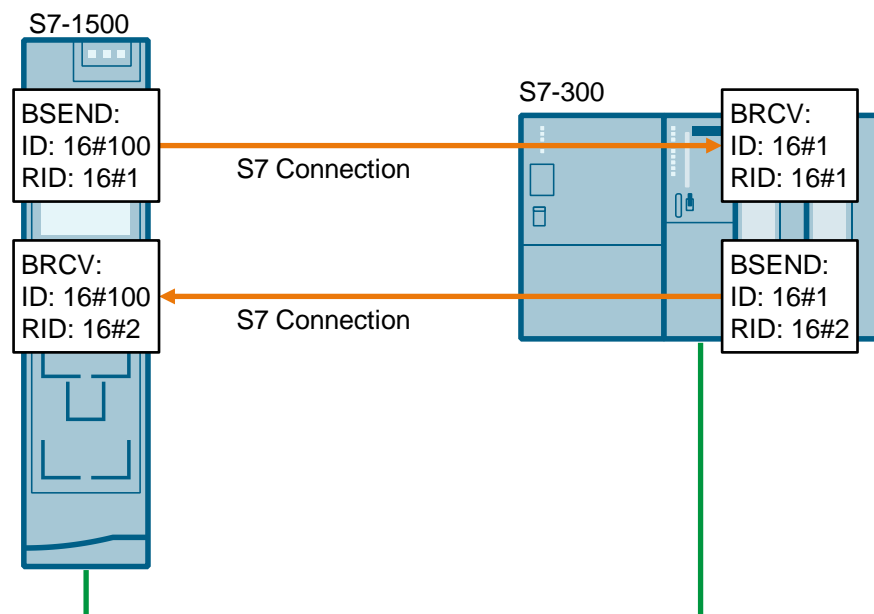

### User data size

If you use the "BSEND" and "BRCV" instructions for the data transfer, a larger amount of data can be transferred between the communication partners than is possible with all other communication instructions for configured S7 connections. You can transfer the following volumes of data:

- S7-300:
  - 32768 bytes via the communications processor (CP)
  - 65534 bytes via the integrated interface of the CPU
- S7-400: 65534 bytes via the integrated interface of the CPU or via the communications processor (CP)
- S7-1500:
  - 65534 bytes (standard access) via the integrated interface of the CPU or via the communications processor (CP)
  - 65535 bytes (optimized access) via the integrated interface of the CPU or via the communications processor (CP)

#### Note

The example also applies for data exchange between the following communication partners:

- Two S7-1500 CPUs
- Two S7-300 CPUs
- S7-1500 CPU and S7-400 CPU
- S7-300 CPU and S7-400 CPU

## 2 Configuration

### 2.1 Create the Hardware Configuration

#### 2.1.1 Create the Hardware Configuration in STEP 7 V16

##### Set the IP address of the CPU

1. In the network view of the "Devices & networks" editor you create the connection partners, an S7-1500 CPU and / or an S7-300 CPU, for example.
2. In the Device view or Network view you mark the S7 CPU. The properties of the S7 CPU are displayed in the inspector window.
3. In the "General" tab under "PROFINET interface [X1] > Ethernet addresses" you enter the IP address and subnet mask of the S7 CPU. The following IP addresses are used in this example.
  - S7-1500 CPU: 172.16.43.35
  - S7-300 CPU: 172.16.43.37
4. Assign a subnet to the Ethernet interface of the S7 CPU. You have two options:
  - Click the "Add new subnet" button to add a new subnet.
  - Select an existing subnet.

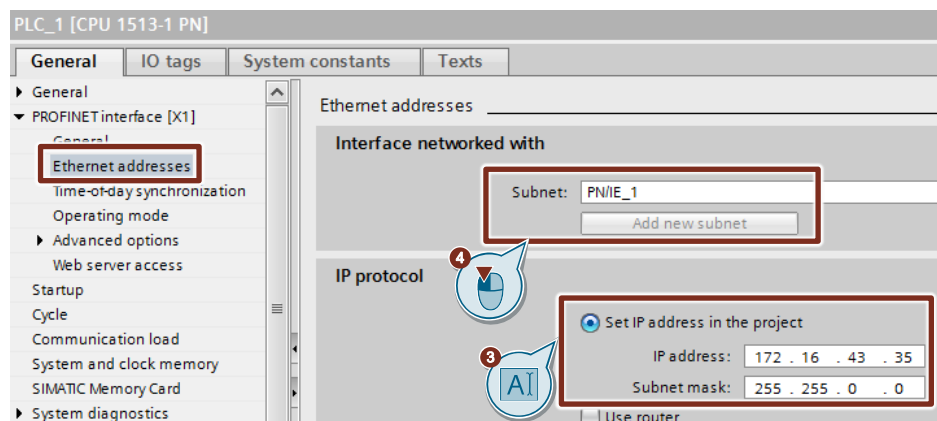

#### Hinweis

If you have configured the connection partners in the same STEP 7 project, you assign the same subnet to each connection partner.

### Set the IP address of the CP/CM

1. In the Device view or Network view of the "Devices & networks" editor you mark the CP/CM in the S7 station.  
The properties of the CP/CM are displayed in the inspector window.
2. In the "General" tab under "Ethernet interface [X1] > Ethernet addresses" you enter the IP address and the subnet mask of the CP/CM.
  - IP address: 172.16.43.42
  - Subnet mask: 255.255.0.0
3. Assign a subnet to the Ethernet interface of the CP/CM. You have two options:
  - Click the "Add new subnet" button to add a new subnet.
  - Select an existing subnet.

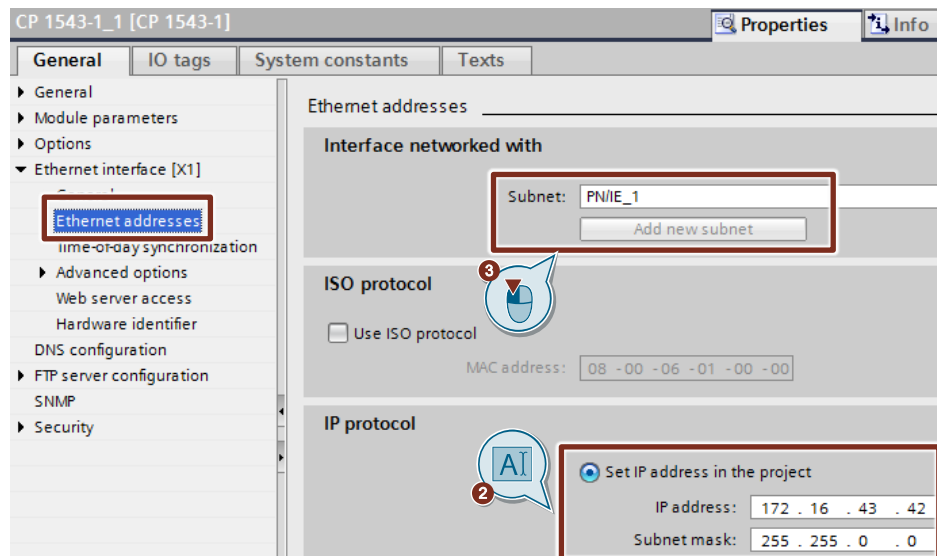

**Hinweis** If you have configured the connection partners in the same STEP 7 project, you assign the same subnet to each connection partner.

## 2.1.2 Create Hardware Configuration in STEP 7 V5

### Open the Hardware Configuration

1. In the SIMATIC Manager you mark the SIMATIC S7-300 station that you have added to your STEP 7 project.
2. Double-click the "Hardware" item. The Hardware Configuration opens.

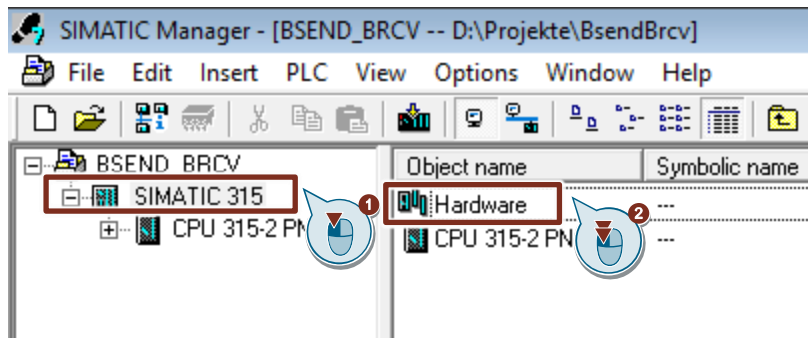

3. Drag and drop the relevant modules like Power Supply, CPU etc. from the hardware catalog into the S7-300 profile channel.

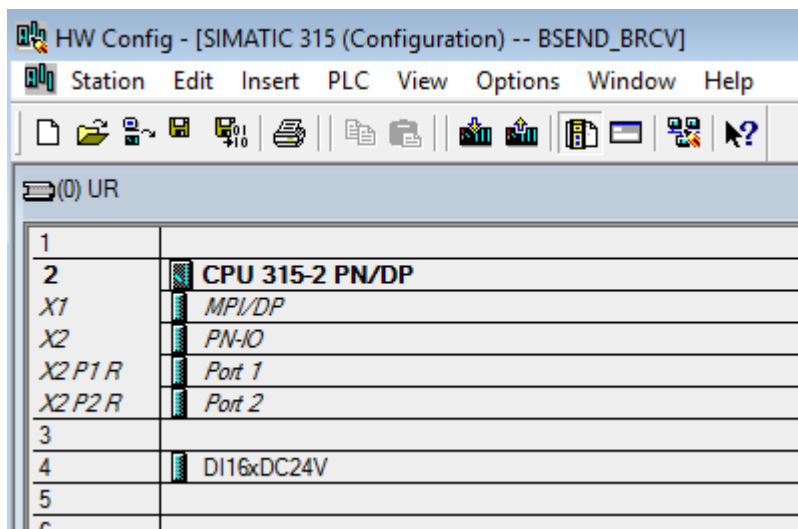



**Define IP address and Assign Subnet to the PROFINET interface of the CPU**

1. Double-click the PROFINET interface of the S7-300 CPU. The Properties dialog of the PROFINET interface opens.

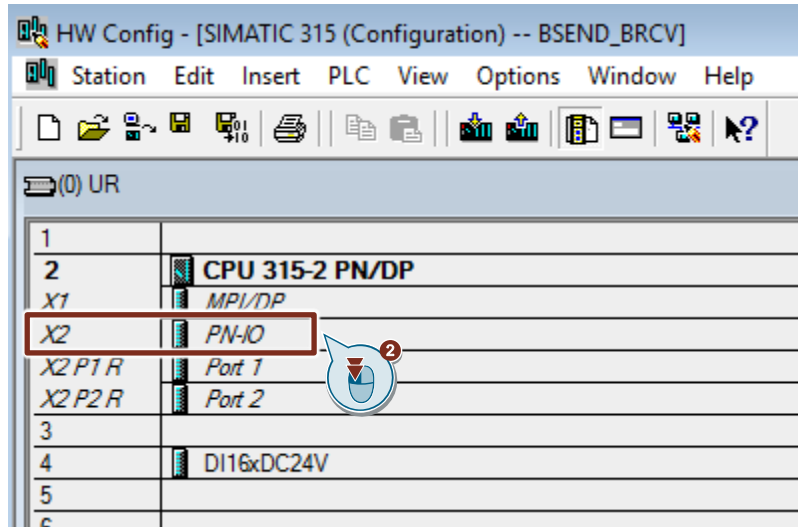

2. Click the "Properties" button to change the IP address and subnet mask and assign the subnet.

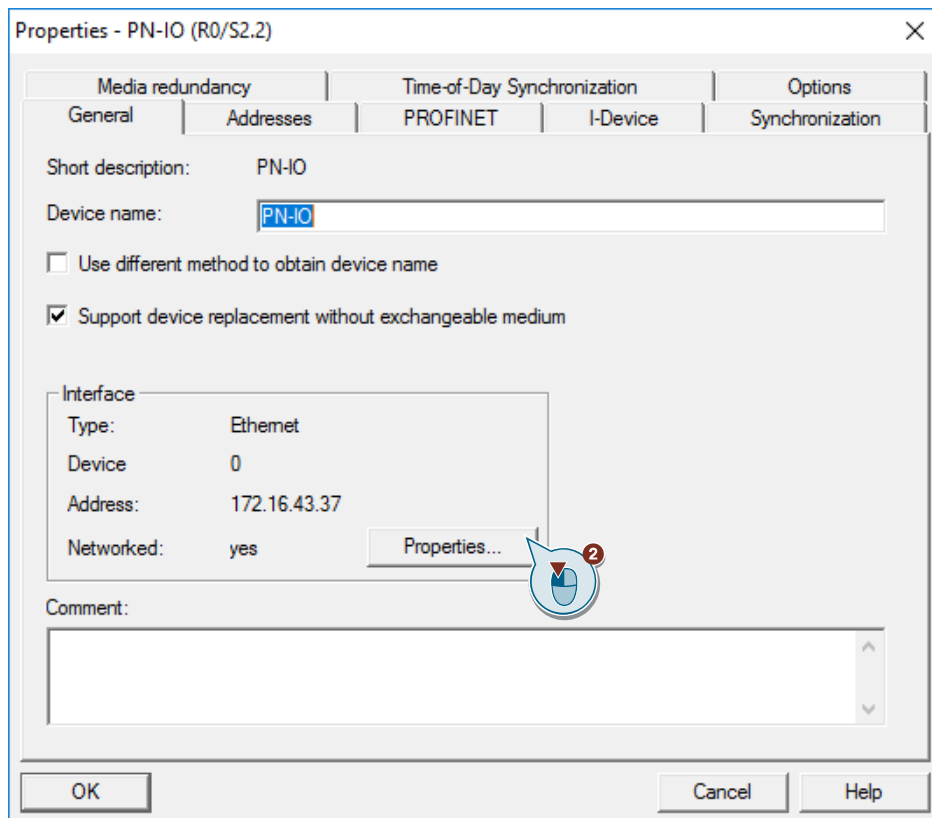

3. Enter the IP address and subnet mask, for example:
  - IP address: 172.16.43.37
  - Subnet mask: 255.255.0.0

4. Click the "New..." button to create a new subnet.
5. Select the new subnet or an existing subnet.
6. Click the "OK" button to apply the IP address and subnet mask and assign the selected subnet to the PROFINET interface of the S7-300 CPU.

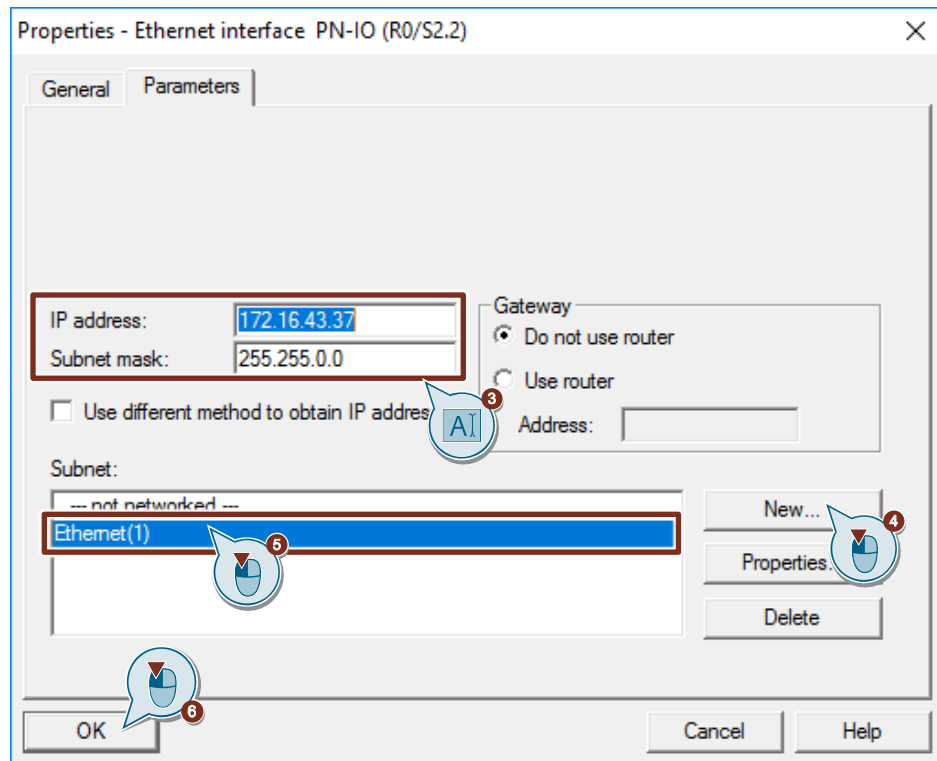

### Define IP address and Assign Subnet to the PROFINET interface of the CP

1. Double-click the PROFINET interface of the CP. The Properties dialog of the PROFINET interface opens.
2. Click the "Properties" button to change the IP address and subnet mask and assign the subnet.

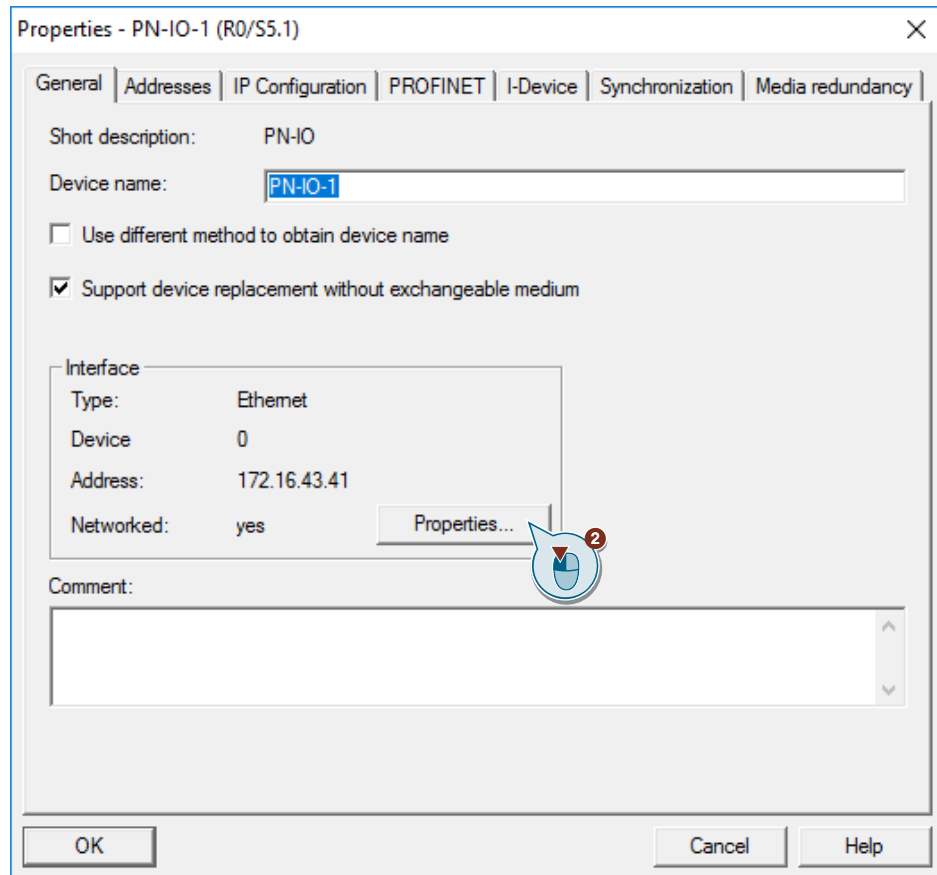

3. Enter the IP address and subnet mask, for example:
  - IP address: 172.16.43.41
  - Subnet mask: 255.255.0.0
4. Click the "New..." button to create a new subnet.
5. Select the new subnet or another existing subnet.
6. Click the "OK" button to apply the IP address and subnet mask and assign the selected subnet to the PROFINET interface of the CP.

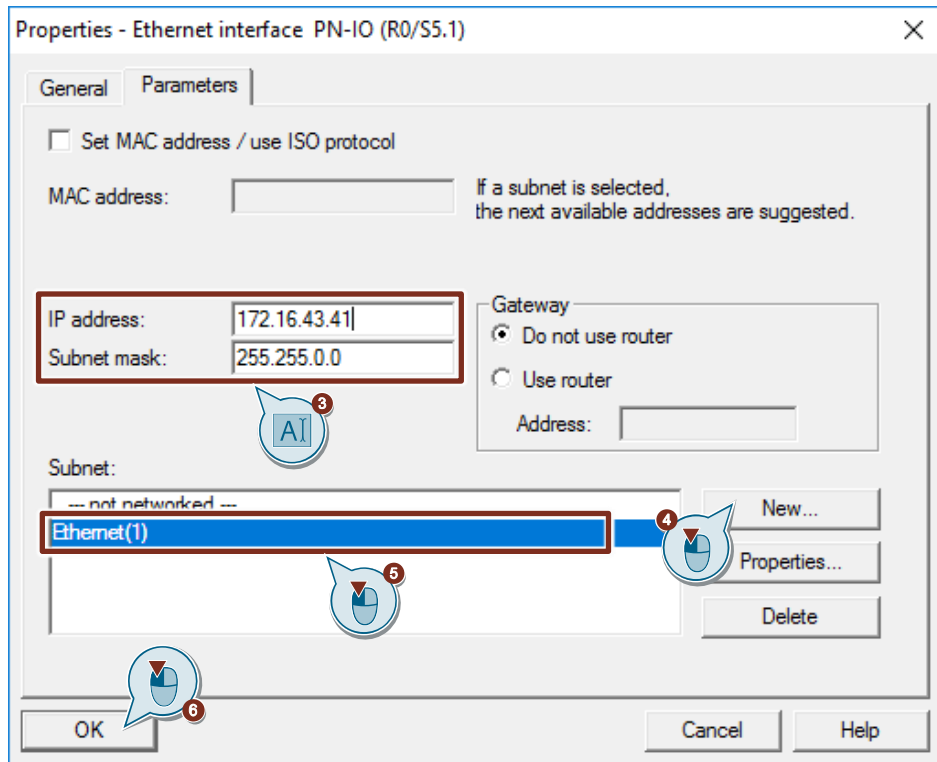

## 2.2 Configuration of the S7 Connection

### 2.2.1 Graphical Configuration of the S7 Connection

#### Requirements

To create the S7 connection graphically the communication partners have to be configured in the same project. If you create the S7 connection graphically, the connection is configured on both sides.

#### Instructions

Figure 2-1

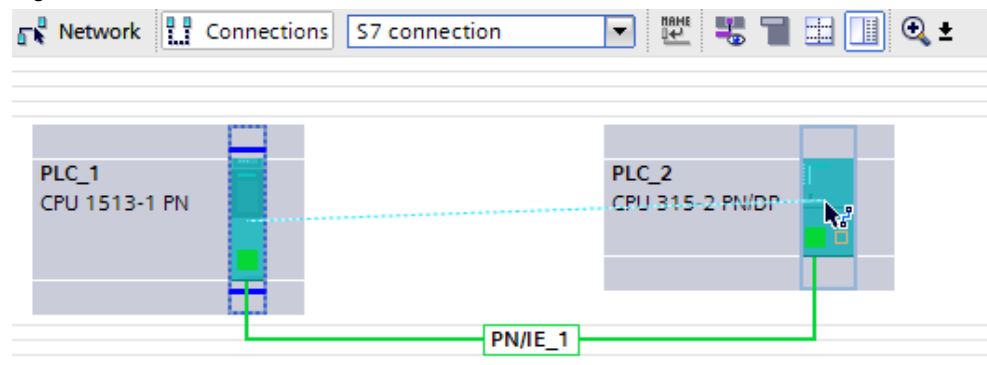

1. In the Network view you click the "Connections" icon to enable the Connection mode.
2. Select "S7 connection" as the connection type in the adjacent drop-down list box.  
In the Network view, all devices that are available for an S7 connection are highlighted in color.
3. With the button held down drag the mouse cursor from the module (CPU, CP or CM) where the S7 connection is to start (active connection establishment) to the module (CPU, CP or CM) where the S7 connection is to finish (passive connection establishment).
4. Release the mouse button when the cursor is on the target device to create the S7 connection between the communication partners.

**Result**

- An S7 connection configured on both sides is created.
- The connection path is displayed highlighted in the graphical area of the Network view.

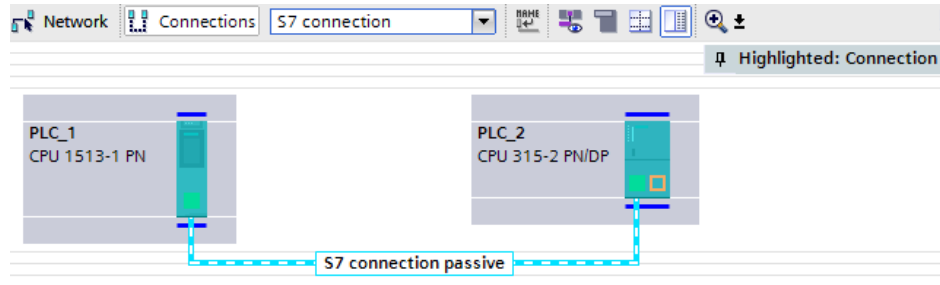

- The S7 connection is entered in the "Connections" table in the table area of the Network view. Since the S7 connection is configured on both sides two connections are created:
  - One S7 connection uses the S7-1500 CPU as local endpoint. This sets up the S7 connection actively.
  - The second S7 connection uses the S7-300 CPU as local endpoint. This participates passively in establishing the connection.

| Local connection name | Local end point         | Local ID (hex) | Partner ID (hex) | Partner                 | Connection type |
|-----------------------|-------------------------|----------------|------------------|-------------------------|-----------------|
| S7 connection active  | PLC_1 [CPU 1513-1 PN]   | 100            | 1                | PLC_2 [CPU 315-2 PN/DP] | S7 connection   |
| S7 connection passive | PLC_2 [CPU 315-2 PN/DP] | 1              | 100              | PLC_1 [CPU 1513-1 PN]   | S7 connection   |

**Setting the connection parameters**

1. In the "Connections" table you mark the S7 connection for which you want to set the connection parameters. The Properties of the marked S7 connection are displayed in the inspector window.
2. In the "General" tab under "General" you see the general connection parameters that identify the local endpoint. You can assign the connection route and specify the connection route in full.

- In the "General" tab under "Local ID" you see the local ID of the module from which the connection is viewed (local partner). You can change the local ID. You specify the local ID later at the "ID" input parameter of the "BSEND" and "BRCV" instructions. In this example we use the local ID with the value 100 (hex).

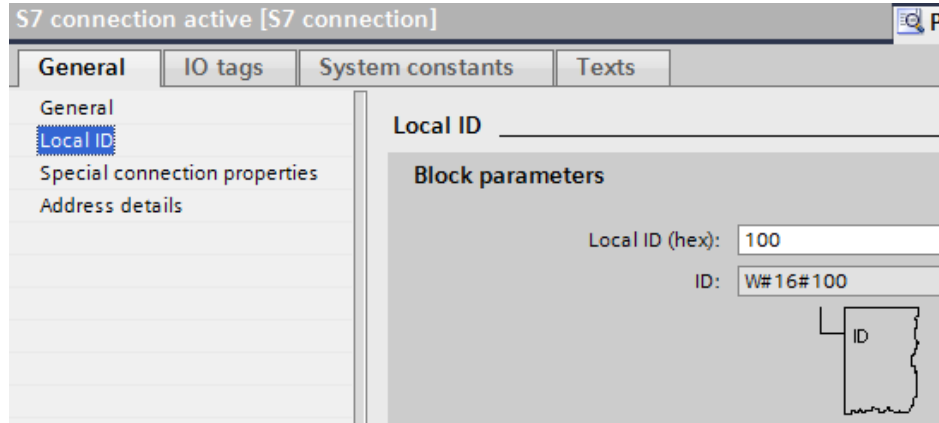

- In the "General" tab under "Special connection properties" you can set which connection partner actively establishes the connection.

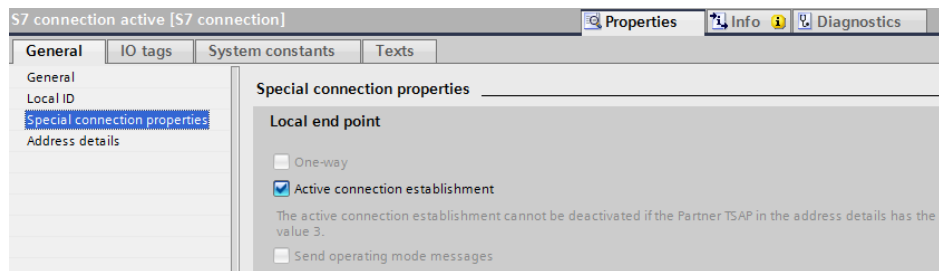

- The address details of the S7 connection are displayed in the "General" tab under "Address details". The values are taken from the current configuration. You have the option of changing the connection resource.

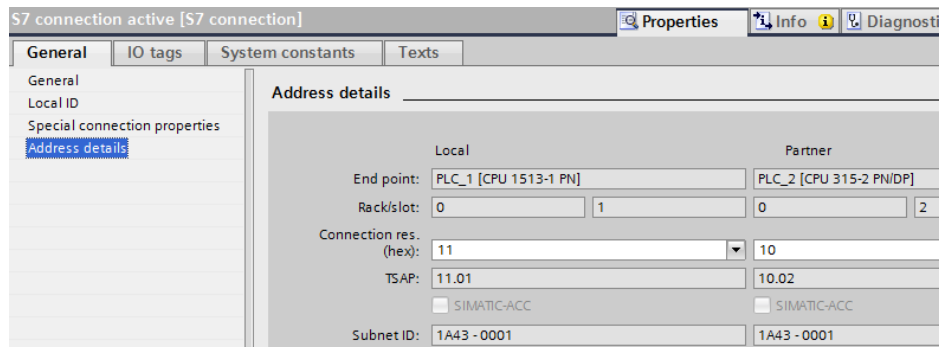

## 2.2.2 Configuration of the S7 Connection with Unspecified Partner

If you use the communication services "BSEND" and "BRCV" for the data exchange, you must create the S7 connection on both sides. The following instructions show you how to create the S7 connection on both sides when the communication partners are configured in different projects.

### Configuring the S7 connection in STEP 7 V16

1. In the Network view you click the "Connections" icon to enable the Connection mode.
2. Select "S7 connection" as the connection type in the adjacent drop-down list box.  
In the Network view, all devices that are available for an S7 connection are highlighted in color.
3. Right-click the S7 CPU.  
The pop-up menu opens.
4. Select the "Add new connection" item.  
The "Add new connection" dialog opens.

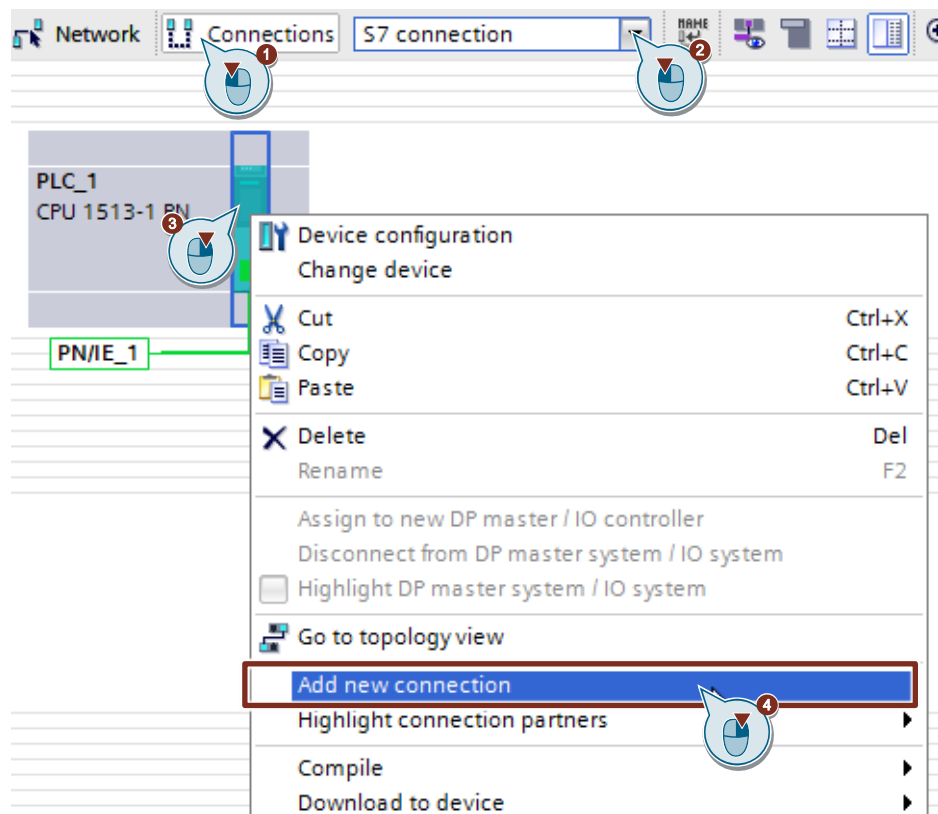

5. Specify the following connection partner: "Unspecified".
6. Select the local interface. In this example, the integrated interface of the S7-CPU is used. If the S7 connection is to be established via a CP/CM, select the CP/CM.
7. Enter the local ID for the S7 connection, 100 (hex), for example.
8. Click the "Add" button to add the unspecified S7 connection.
9. Click the "Close" button to end the dialog.



## 2 Configuration

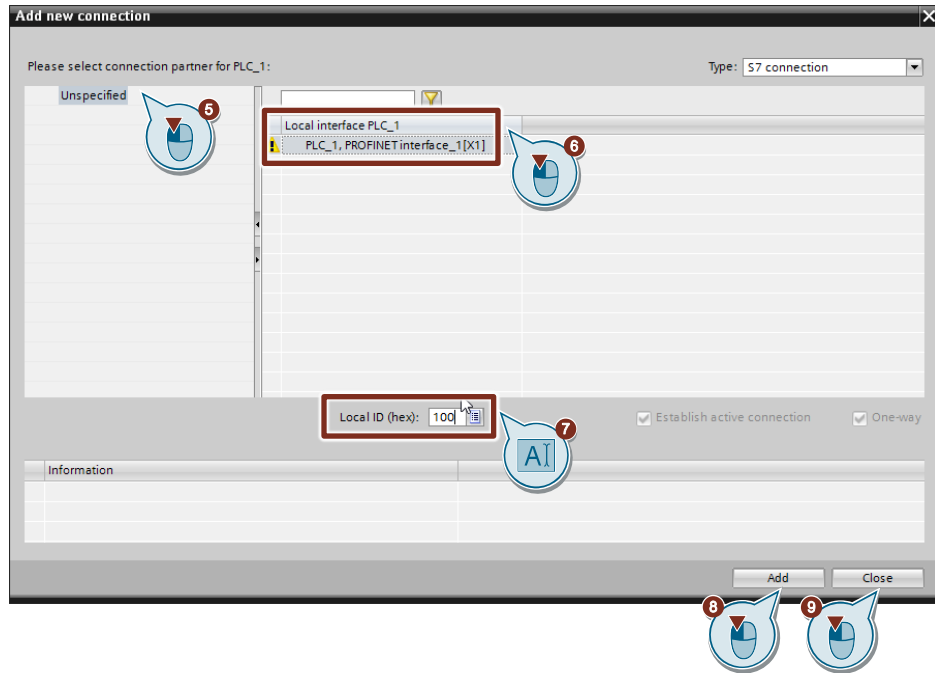

### Result

- An unspecified S7 connection is created.
- The connection path is displayed highlighted in the graphical area of the Network view.

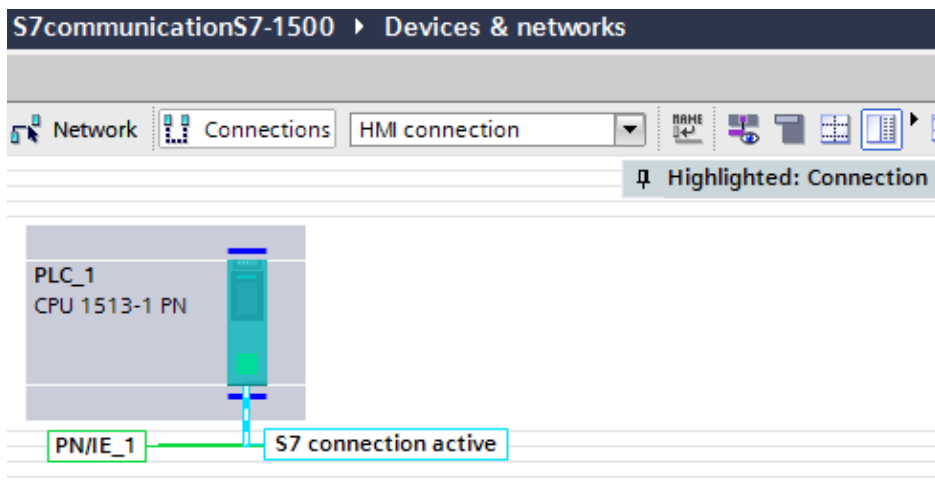

- The S7 connection is entered in the "Connections" table in the table area of the Network view.

| Local connection name | Local end point       | Local ID (hex) | Partner ID (hex) | Partner | Connection type |
|-----------------------|-----------------------|----------------|------------------|---------|-----------------|
| S7 connection active  | PLC_1 [CPU 1513-1 PN] | 100            |                  |         | S7 connection   |

### Setting the connection parameters

1. In the "Connections" table, mark the unspecified S7 connections.  
The Properties of the S7 connection are displayed in the inspector window.
2. In the "General" tab under "General" you see the general connection parameters that identify the local endpoint. Enter the address of the communication partner, 172.16.43.37, for example.

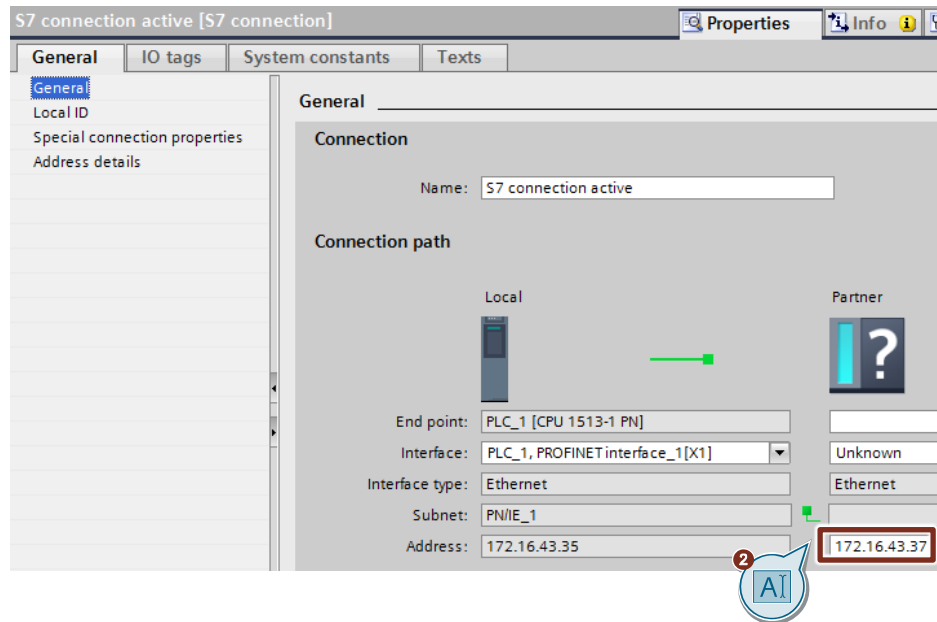

3. In the "General" tab under "Local ID" you see the local ID of the module from which the connection is viewed (local partner). You can change the local ID. You specify the local ID later at the "ID" input parameter of the "BSEND" and "BRCV" instructions.  
In this example we use the local ID with the value 100 (hex).

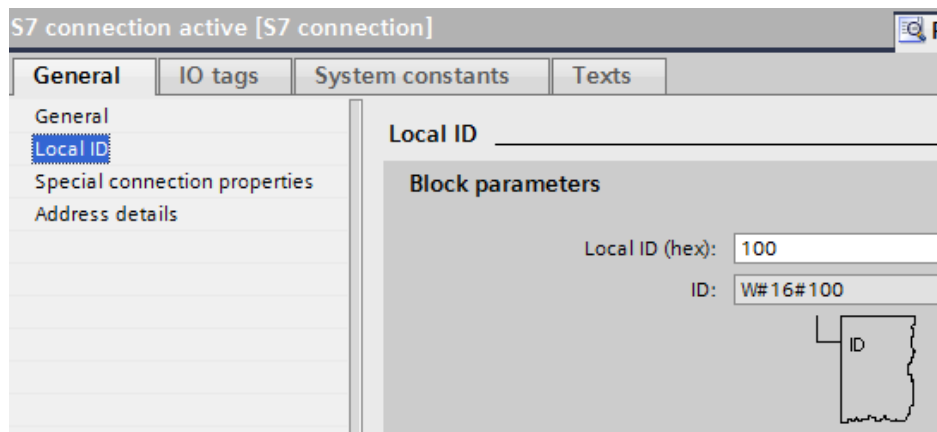

- In the "General" tab under "Special connection properties" you enable or disable the "Active connection establishment" option. If you enable the "Active connection establishment" option, you must disable the "Active connection establishment" option in the communication partner.

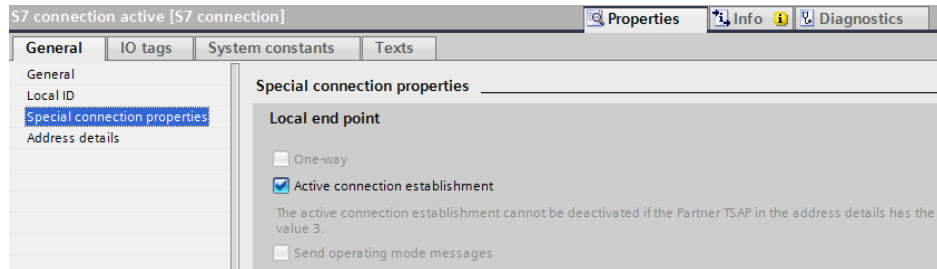

- In the "General" tab under "Address details" you enter the partner TSAP. The partner TSAP is composed as follows:  
 <Connection resource (hex)>.<Slot of CPU or CP/CM>
  - Connection resource (hex): Value range 10-DE, because the S7 connection is not configured unilaterally with an unspecified partner.
  - Slot of the CPU, for example:  
 S7-1500 CPU: Slot 1  
 S7-300 CPU: Slot 2  
 S7-400 CPU: Slot 3

The partner TSAP must match the local TSAP in the communication partner.

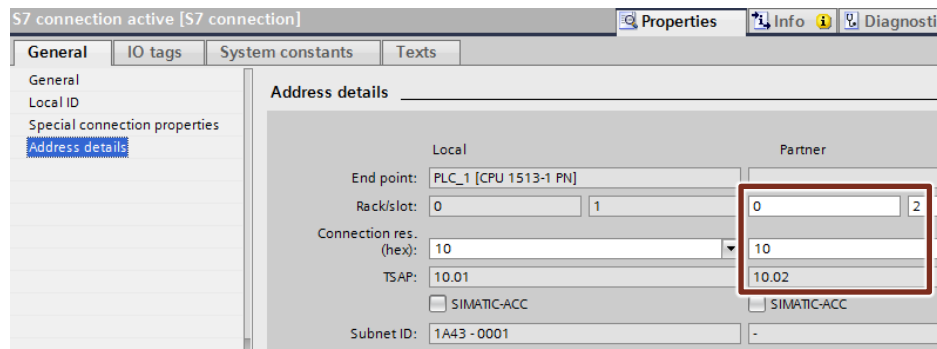

## Configuring the S7 connection in STEP 7 V5

### Add an S7 Connection

1. In the SIMATIC Manager you open the "NetPro" tool via the menu "Options > Configure Network". In "NetPro" you configure the S7 connection for the S7-300 CPU.

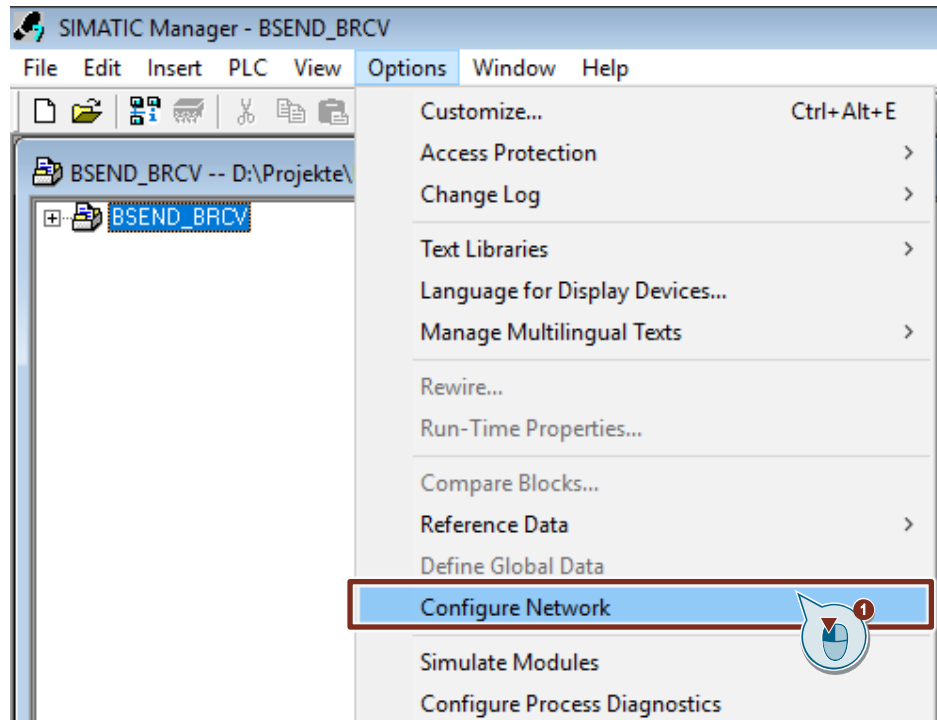

2. Mark the CPU in the SIMATIC S7-300 station.
3. Open the "Insert New Connection" dialog via the menu "Insert > New Connection...".

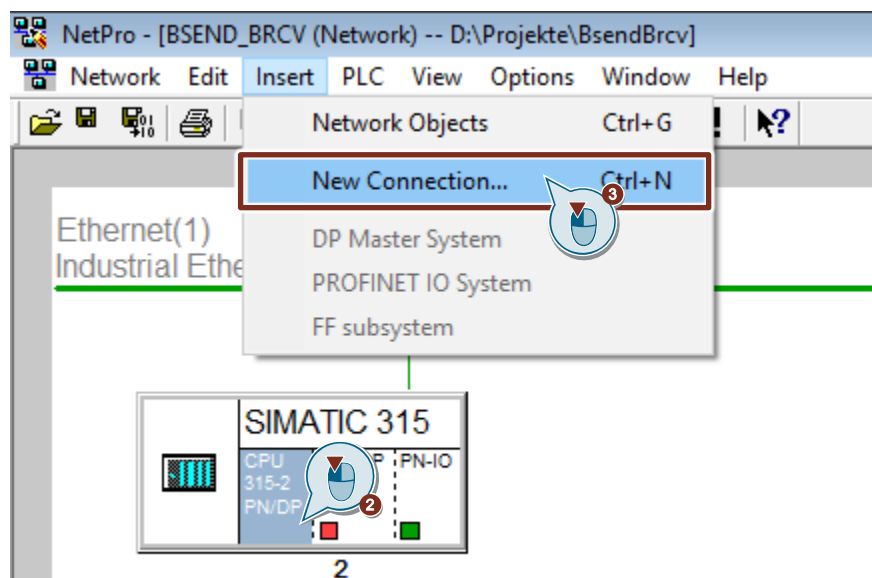

4. Select the "Unspecified" item under "Connection Partner".
5. Select "S7 connection" as the connection type.
6. Click "Apply". The Properties dialog of the S7 connection opens.

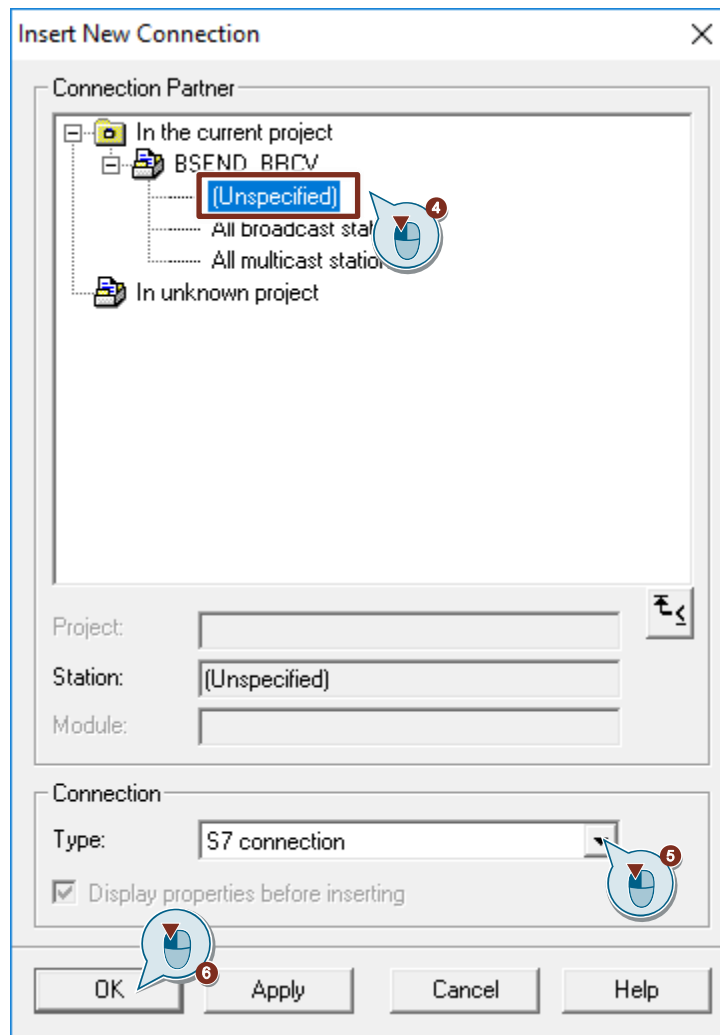

### Define connection parameters

In the Properties dialog of the S7 connection you define the connection parameters.

1. Enable or disable the "Active connection establishment" option. If you enable the "Active connection establishment" option, you must disable the "Active connection establishment" option in the communication partner.
2. Select the local interface. In this example, the integrated interface of the S7-300 CPU is used. If the S7 connection is to be established via a CP, select the CP.
3. Enter the IP address of the partner CPU or CP/CM, 172.16.43.35, for example.
4. You specify the local ID of the connection in the user program at the input parameter "ID" of the function blocks SFB/FB12 "BSEND" and SFB/FB13 "BRCV".
5. Click the "Address Details..." button. The "Address Details" dialog opens.

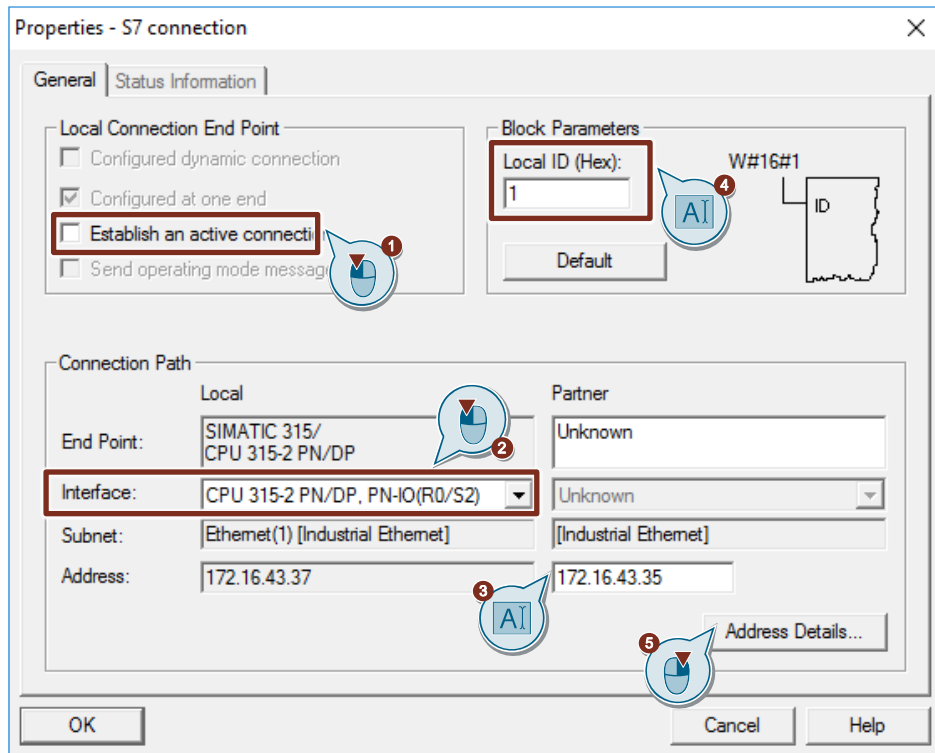

6. Enter the rack and slot of the partner CPU or CP/CM, Rack 0 and Slot 1, for example.
7. Select a connection resource from 10 (hex) onwards for the partner CPU because the S7 connection is configured on both sides. With these settings the TSAP in the partner CPU has the value 10.01. The partner TSAP must match the local TSAP in the communication partner.
8. Apply the settings with "OK".

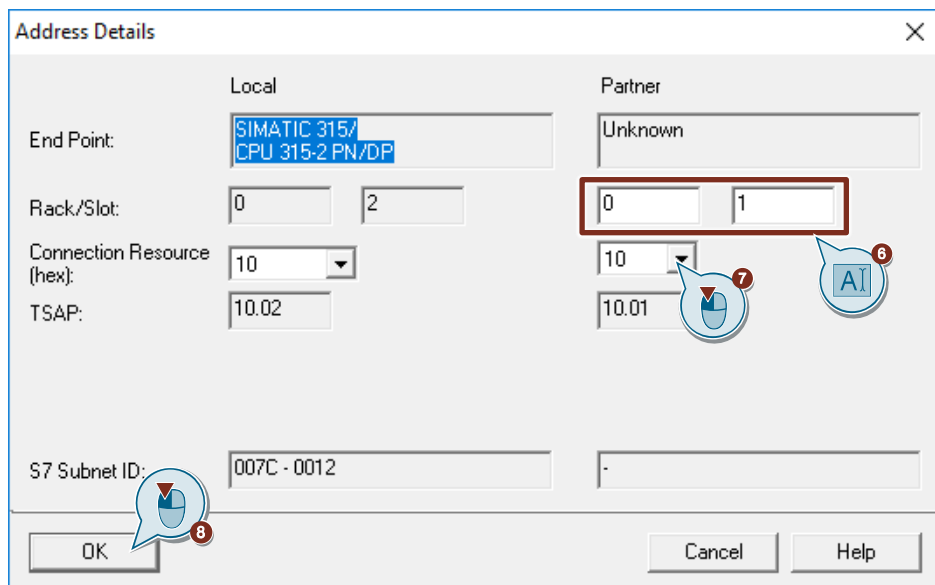

9. Likewise apply the settings in the Properties dialog of the S7 connection with "OK".

10. In the "Insert New Connection" dialog you click the "OK" button to close the dialog. The S7 connection is inserted in "NetPro".

**Load the S7 Connection**

1. In "NetPro" you mark the S7 CPU in the SIMATIC S7-300 station. The connection table shows all the connections configured for the S7-CPU.

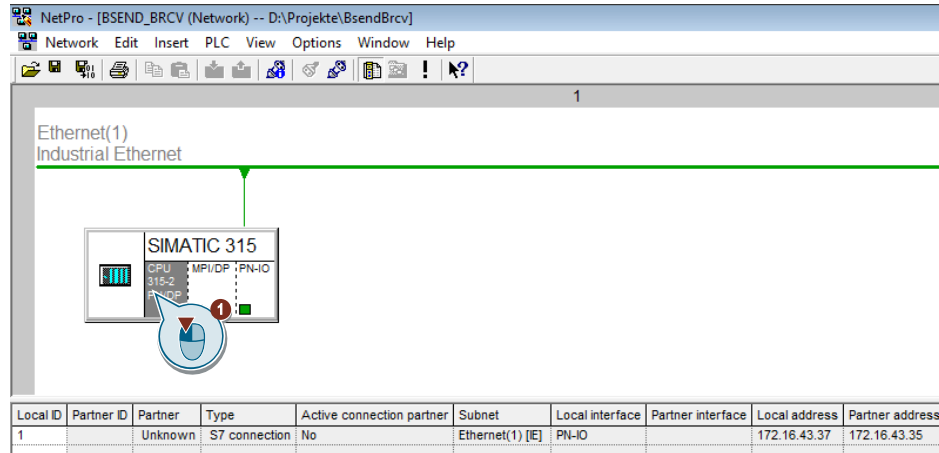

2. In "NetPro" you mark the SIMATIC S7-300 station.
3. In the toolbar you click the "Save and Compile" button to save and compile the connection configuration.
4. In the toolbar you click the "Load marked station(s)" button to load the connection configuration into the S7 CPU.

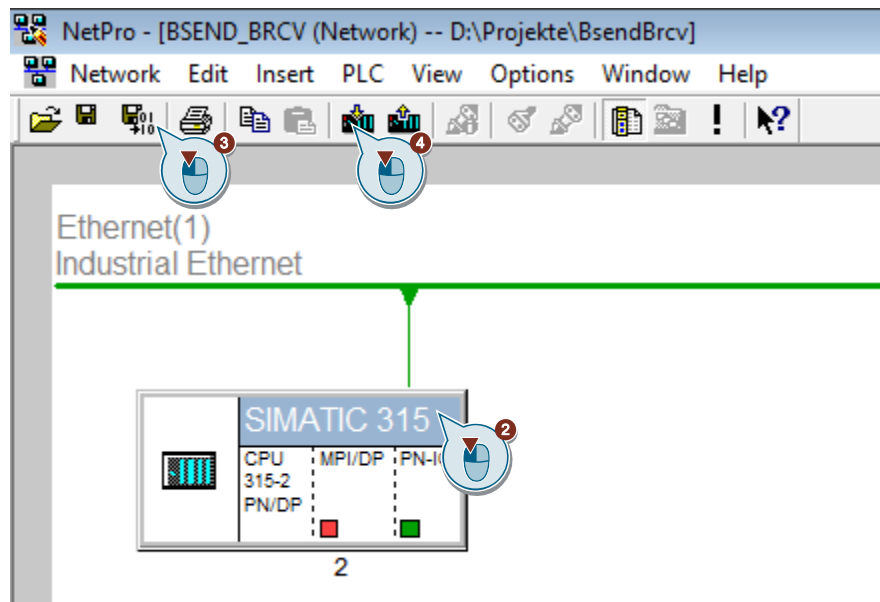

## 2.3 Permit Access with PUT/GET Communication from Remote Partner

In the S7-1500 CPU you enable the function "Permit access with PUT/GET communication from remote partner". This enables the partner CPU to access the data in the S7-1500 CPU using the "BSEND" and "BRCV" instructions.

1. In the Device view or Network view of the "Devices & networks" editor you mark the S7 CPU.
2. In the "General" tab, under "Protection & Security > Connection mechanisms" you enable the "Permit access with PUT/GET communication from remote partner" function.

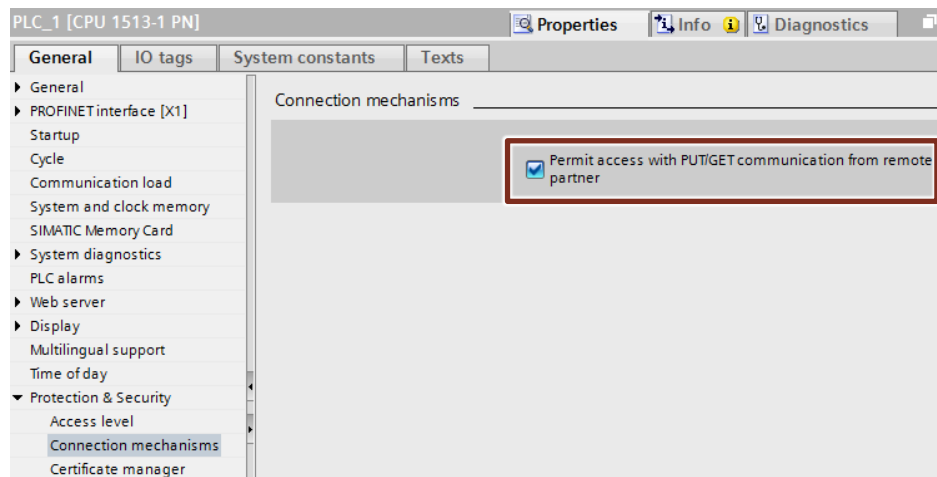



## 3 User Program of the S7 CPU

**NOTE**

The sample program can be used for S7 communication with "USEND" and "URCV". In FB "BsendData" call the system block "USEND" instead of "BSEND". In FB "BrcvData" call the system block "URCV" instead of "BRCV".

### 3.1 Overview

The following figure shows an overview of the user program in the S7 CPU.

Figure 3-1

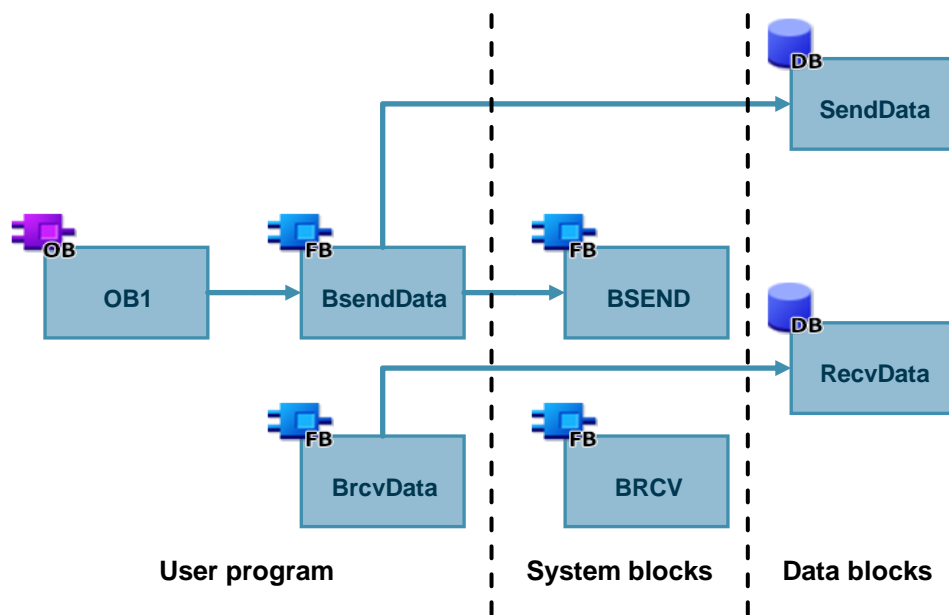

## 3.2 Create Send and Receive Data Areas

### 3.2.1 DB1 "RecvData"

The data received is stored in data block DB1 "RecvData".

In the Properties of DB1 "RecvData", under "Attributes" you can enable or disable the "Optimized block access" function.

Figure 3-2

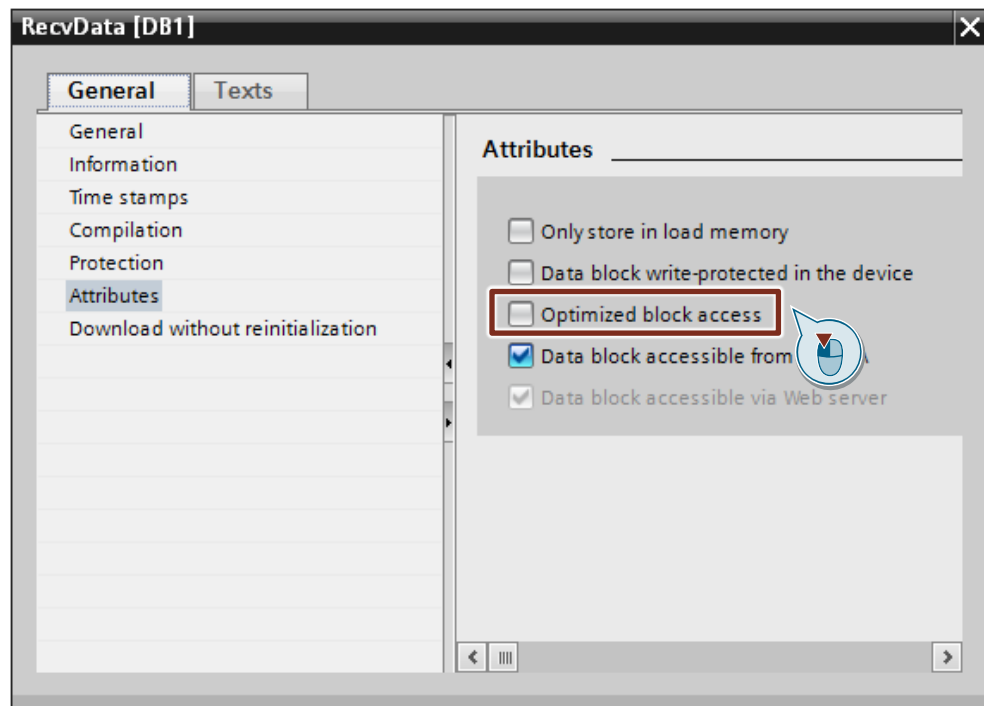

### 3.2.2 DB2 "SendData"

The data that is transferred to the partner CPU is stored in data block DB2 "SendData".

In the Properties of DB2 "SendData", under "Attributes" you can enable or disable the "Optimized block access" function.

Figure 3-3

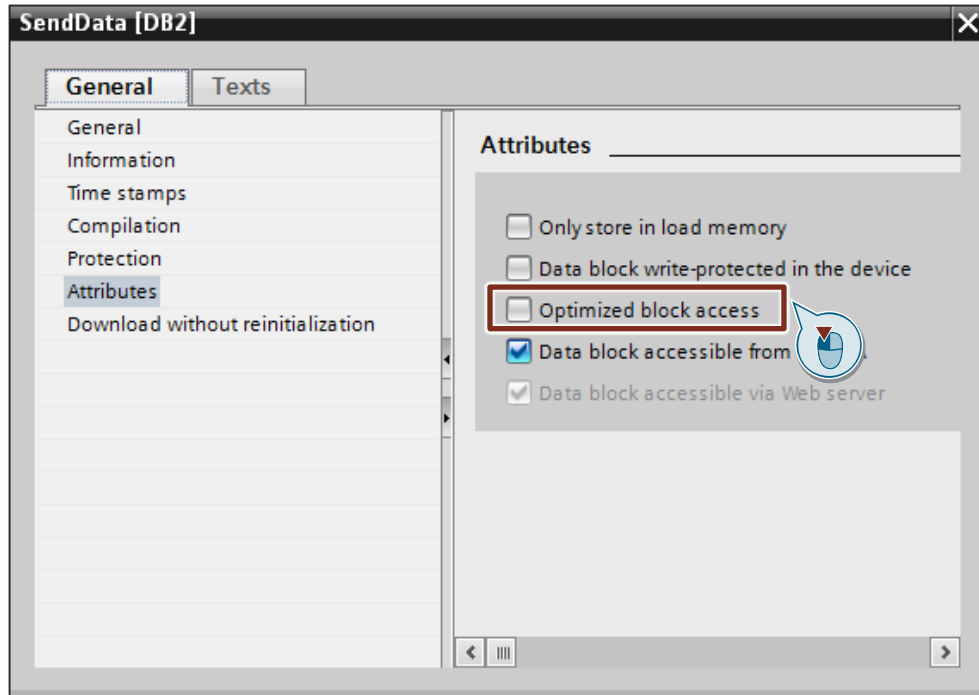

### 3.3 Create Variables for Parameters of Function Blocks "BsendData" and "BrcvData"

Create the following variables in DB10 "GeneralData" to assign the input and output parameters of the function blocks "BsendData" and "BrcvData". PLC data types are used as data type.

Table 3-1

| Variable   | PLC data type  | Description   |
|------------|----------------|---|
| send       | typeBsend      | Variables for parameterizing FB "BsendData".                                      |
| rcv        | typeBrcv       | Variables for parameterizing FB "BrcvData".                                       |
| diagnostic | typeDiagnostic | Variables to store the status of FBs "BsendData" and "BrcvData" in case of error. |

### 3.3.1 PLC Data Type "typeBsend"

The following table shows the structure of the PLC data type "typeBsend".

Table 3-2

| Parameter    | Data type  | Start value | Description   |
|--------------|--|-------------|---|
| execute      | Boolean  | false       | Control parameter   |
| abort        | Boolean  | false       | Control parameter   |
| connectionId | S7-1500:<br>CONN_PRG<br>S7-300/S7-400:<br>Word   | 16#0        | Addressing parameter for specifying the connection to the communication partner.  |
| rid          | S7-1500:<br>CONN_R_ID<br>S7-300/S7-400:<br>DWord | 16#0        | Addressing parameter for specifying the instruction pair "BSEND" and "BRCV".  |
| len          | Word   | 16#0        | Length in bytes of data block to be sent<br><b>Note for S7-1500</b><br>If "len" = 16#0, all the data is sent by "SD_1". |
| done         | Boolean  | false       | Status parameters   |
| busy         | Boolean  | false       | Status parameters   |
| error        | Boolean  | false       | Status parameters   |
| status       | Word   | 16#0        | Status parameters   |

### 3.3.2 PLC Data Type "typeBrcv"

The following table shows the structure of the PLC data type "typeBrcv".

Table 3-3

| Parameter    | Data type  | Start value | Description  |
|--------------|--|-------------|--|
| enable       | Boolean  | false       | Control parameter  |
| connectionId | S7-1500:<br>CONN_PRG<br>S7-300/S7-400:<br>Word   | 16#0        | Addressing parameter for specifying the connection to the communication partner. |
| rid          | S7-1500:<br>CONN_R_ID<br>S7-300/S7-400:<br>DWord | 16#0        | Addressing parameter for specifying the instruction pair "BSEND" and "BRCV".     |
| len          | Word   | 16#0        | Length in bytes of the data received so far.                                     |
| valid        | Boolean  | false       | Status parameters  |
| busy         | Boolean  | false       | Status parameters  |
| error        | Boolean  | false       | Status parameters  |
| status       | Word   | 16#0        | Status parameters  |

### 3.3.3 PLC Data Type "typeDiagnostic"

The following table shows the structure of the PLC data type "typeDiagnostic".

Table 3-4

| Parameter  | Data type | Start value | Description  |
|------------|-----------|-------------|--|
| statusSend | Word      | 16#0        | Parameter to store the status of FB "BsendData".           |
| statusRecv | Word      | 16#0        | Parameter to store the status of FB "BrcvData".            |
| lenRecv    | Word      | 16#0        | Parameter to store the length of the data received so far. |

### 3.4 FB "BsendData"

The FB "BsendData" calls the "BSEND" instruction to execute the following functions:

- Send data to the partner via the configured connection as soon as the input "execute" recognizes a positive edge. When the Send job is running, it is not possible to trigger a new Send job.
- Output the status of the FB and data transmission at the "status" output.

FB "BsendData" is called cyclically in OB1.

#### 3.4.1 S7-1500 CPU

##### Overview

Figure 3-4

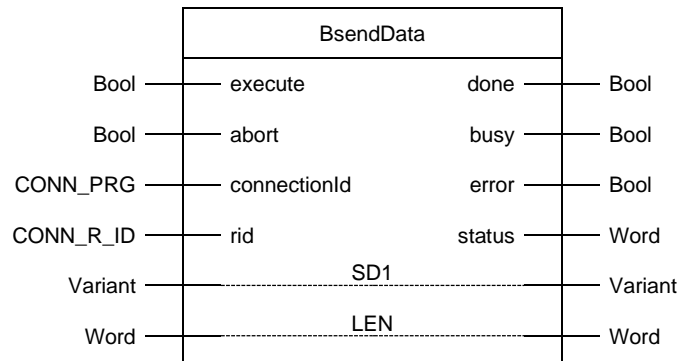

## Parameters

The following table shows the parameters of FB "BsendData".

Table 3-5

| Name         | P type | Data type | Comment  |
|--------------|--------|-----------|--|
| execute      | IN     | Bool      | Control parameter:<br>Enables the Send job on a rising edge.   |
| abort        | IN     | Bool      | Control parameter<br>Enables the abort of a running data exchange on a rising edge.  |
| connectionId | IN     | CONN_PRG  | Local ID:<br>Addressing parameter for specifying the connection to the partner CPU.<br><b>Note</b><br>The local ID is available in the Properties of the configured S7 connection.<br>The following local ID is used in this example: 100 (hex)  |
| rid          | IN     | CONN_R_ID | Addressing parameter for specifying the instruction pair "BSEND" and "BRCV".   |
| done         | OUT    | Bool      | TRUE: The Send job was executed error-free.  |
| busy         | OUT    | Bool      | TRUE: The Send job is running.   |
| error        | OUT    | Bool      | Status parameters "error" and "status":  |
| status       | OUT    | Word      | <ul style="list-style-type: none"> <li>• "error" = 0: <ul style="list-style-type: none"> <li>- "status" = 0000 (hex): neither warning nor error</li> <li>- "status" &lt;&gt; 0000 (hex): Warning<br/>The "status" parameter provides detailed information.</li> </ul> </li> <li>• "error" = 1: An error has occurred.<br/>The "status" parameter provides detailed information about the type of error.</li> </ul> |
| SD1          | IN_OUT | VARIANT   | Pointer to Send area<br><b>Note</b><br>When transferring structures, the structures on the sending and receiving sides must be identical.  |
| LEN          | IN_OUT | Word      | Length in bytes of data block to be sent.<br><b>Note</b><br>If "len" = 16#0, all the data is sent by "SD_1".   |

### 3.4.2 S7-300 CPU

#### Overview

Figure 3-5

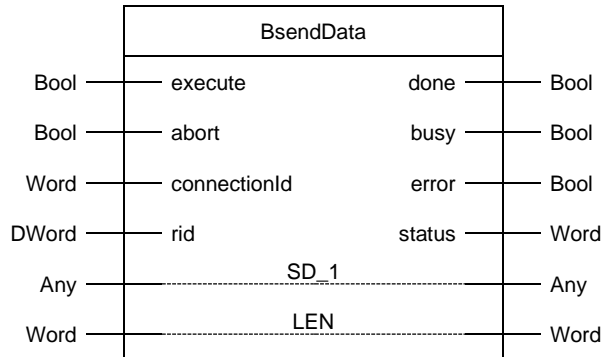

#### Parameters

The following table shows the parameters of FB "BsendData".

Table 3-6: Parameters of BsendData

| Name         | P type | Data type | Comment  |
|--------------|--------|-----------|--|
| execute      | IN     | Bool      | Control parameter:<br>Enables the Send job on a rising edge.   |
| abort        | IN     | Bool      | Control parameter<br>Enables the abort of a running data exchange on a rising edge.  |
| connectionId | IN     | Word      | Local ID:<br>Addressing parameter for specifying the connection to the partner CPU.<br><b>Note</b><br>The local ID is available in the Properties of the configured S7 connection.<br>The following local ID is used in this example: 1 (hex)  |
| rid          | IN     | DWord     | Addressing parameter for specifying the instruction pair "BSEND" and "BRCV".   |
| done         | OUT    | Bool      | TRUE: The Send job was executed error-free.  |
| busy         | OUT    | Bool      | TRUE: The Send job is running.   |
| error        | OUT    | Bool      | Status parameters "error" and "status":  |
| status       | OUT    | Word      | <ul style="list-style-type: none"> <li>"error" = 0:                             <ul style="list-style-type: none"> <li>"status" = 0000 (hex): neither warning nor error</li> <li>"status" &lt;&gt; 0000 (hex): Warning<br/>The "status" parameter provides detailed information.</li> </ul> </li> <li>"error" = 1: An error has occurred.<br/>The "status" parameter provides detailed information about the type of error.</li> </ul> |
| SD_1         | IN_OUT | Any       | Pointer to Send area<br><b>Note</b><br>When transferring structures, the structures on the sending and receiving sides must be identical.  |
| LEN          | IN_OUT | Word      | Length in bytes of data block to be sent.  |



### 3.4.3 Assign Parameters of FB "BsendData"

Assign the variables created in section [3.3](#) to the parameters of FB "BsendData".

The following table shows the assignment of the parameters of the "send" variable to the parameters of FB "BsendData".

Table 3-7

| Parameters of FB "BsendData" | Parameters of the "send" variable | Start value                        | Note   |
|------------------------------|-----------------------------------|------------------------------------|--|
| execute                      | execute                           | false                              | Set the "execute" parameter to the value "TRUE" to start the Send job. The Send job is started on a rising edge. Reset the "execute" parameter to the value "FALSE" if the Send job is completed with "done" = true or "error" = true. |
| abort                        | abort                             | false                              | Set the "abort" parameter to the value "TRUE" to abort the running exchange of data. Reset the "abort" parameter to the value "FALSE" if the Send job is aborted with "error" = true.  |
| connectionId                 | connectionId                      | S7-1500:<br>16#100<br>S7-300: 16#1 | Enter the local ID of the connection that you defined during the connection configuration.   |
| rid                          | rid                               | S7-1500: 16#1<br>S7-300: 16#2      | Enter a value to define the instruction pair "BSEND" and "BRCV".   |
| done                         | done                              | false                              | –  |
| busy                         | busy                              | false                              | –  |
| error                        | error                             | false                              | –  |
| status                       | status                            | 16#0                               | –  |
| SD_1                         | –                                 | P#DB2.DBX0.0<br>BYTE 8192          | –  |
| LEN                          | len                               | 16#0                               | Enter the length of the data block to be sent.<br>If you are using the start value "16#0", all the data is sent by "SD_1".   |

### 3.5 FB "BrcvData"

The FB "BrcvData" calls the "BRCV" instruction to execute the following functions:

- Receive data from the partner via the configured connection as soon as the input "enable" is set to the value "TRUE".
- Output the status of the FB and data transmission at the "status" output.

FB "BrcvData" is called cyclically in OB1.

#### 3.5.1 S7-1500 CPU

##### Overview

Figure 3-6

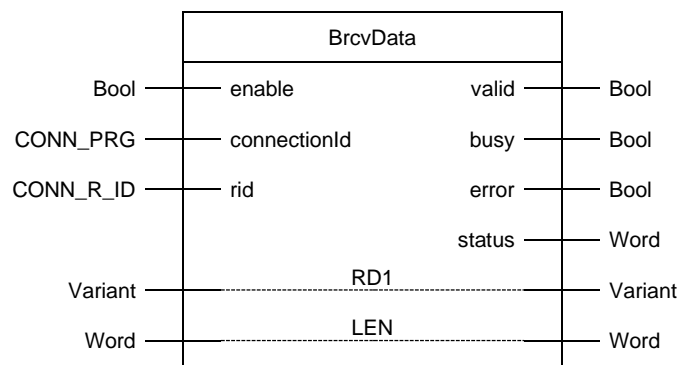

## Parameters

The following table shows the parameters of FB "BrcvData".

Table 3-8:

| Name         | P type | Data type | Comment   |
|--------------|--------|-----------|---|
| enable       | IN     | Bool      | Control parameter:<br>Signals the readiness to receive if the "enable" parameter has the value "TRUE".  |
| connectionId | IN     | CONN_PRG  | Local ID:<br>Addressing parameter for specifying the connection to the partner CPU.<br><b>Note</b><br>The local ID is available in the Properties of the configured S7 connection.<br>The following local ID is used in this example: 100 (hex)   |
| rid          | IN     | CONN_R_ID | Addressing parameter for specifying the instruction pair "BSEND" and "BRCV".  |
| valid        | OUT    | Bool      | TRUE: Readiness to receive is active, in other words data can be received.  |
| busy         | OUT    | Bool      | TRUE: FB is being processed.  |
| error        | OUT    | Bool      | Status parameters "error" and "status":<br><ul style="list-style-type: none"> <li>• "error" = 0: <ul style="list-style-type: none"> <li>- "status" = 0000 (hex): neither warning nor error</li> <li>- "status" &lt;&gt; 0000 (hex): Warning<br/>The "status" parameter provides detailed information.</li> </ul> </li> <li>• "error" = 1: An error has occurred.<br/>The "status" parameter provides detailed information about the type of error.</li> </ul> |
| status       | OUT    | Word      |   |
| RD1          | IN_OUT | Variants  | Pointer to the receive area<br><b>Note</b><br>When transferring structures, the structures on the sending and receiving sides must be identical.  |
| LEN          | IN_OUT | Word      | Length in bytes of the data received so far.  |

### 3.5.2 S7-300 CPU

#### Overview

Figure 3-7

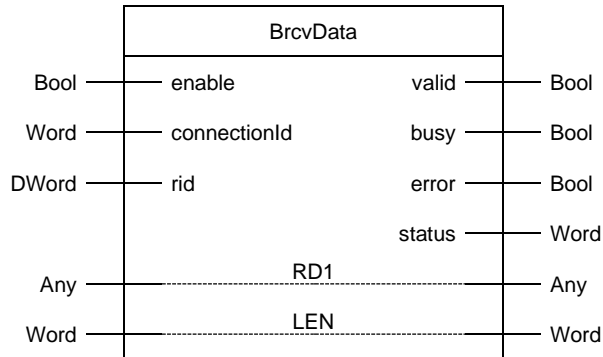

#### Parameters

The following table shows the parameters of FB "BrcvData".

Table 3-9

| Name         | P type | Data type | Comment   |
|--------------|--------|-----------|---|
| enable       | IN     | Bool      | Control parameter:<br>Signals the readiness to receive if the "enable" parameter has the value "TRUE".  |
| connectionId | IN     | Word      | Local ID:<br>Addressing parameter for specifying the connection to the partner CPU.<br><b>Note</b><br>The local ID is available in the Properties of the configured S7 connection.<br>The following local ID is used in this example: 1 (hex)   |
| rid          | IN     | DWord     | Addressing parameter for specifying the instruction pair "BSEND" and "BRCV".  |
| valid        | OUT    | Bool      | TRUE: Readiness to receive is active, in other words data can be received.  |
| busy         | OUT    | Bool      | TRUE: FB is being processed.  |
| error        | OUT    | Bool      | Status parameters "error" and "status":<br><ul style="list-style-type: none"> <li>"error" = 0:                             <ul style="list-style-type: none"> <li>"status" = 0000 (hex): neither warning nor error</li> <li>"status" &lt;&gt; 0000 (hex): Warning<br/>The "status" parameter provides detailed information.</li> </ul> </li> <li>"error" = 1: An error has occurred.<br/>The "status" parameter provides detailed information about the type of error.</li> </ul> |
| status       | OUT    | Word      |   |
| RD1          | IN_OUT | Any       | Pointer to the receive area<br><b>Note</b><br>When transferring structures, the structures on the sending and receiving sides must be identical.  |
| LEN          | IN_OUT | Word      | Length in bytes of the data received so far.  |

### 3.5.3 Assign Parameters of FB "BrcvData"

Assign the variables created in section [3.3](#) to the parameters of FB "BrcvData".

The following table shows the assignment of the parameters of the "rcv" variable to the parameters of FB "BrcvData".

Table 3-10

| Parameters of FB "BrcvData" | Parameters of the "rcv" variable | Start value                     | Note   |
|-----------------------------|----------------------------------|---------------------------------|--|
| enable                      | enable                           | false                           | Set the "enable" parameter to the value "TRUE" to signal readiness to receive.             |
| connectionId                | connectionId                     | S7-1500: 16#100<br>S7-300: 16#1 | Enter the local ID of the connection that you defined during the connection configuration. |
| rid                         | rid                              | S7-1500: 16#2<br>S7-300: 16#1   | Enter a value to define the instruction pair "BSEND" and "BRCV".                           |
| valid                       | done                             | false                           | –  |
| busy                        | busy                             | false                           | –  |
| error                       | error                            | false                           | –  |
| status                      | status                           | 16#0                            | –  |
| RD_1                        | –                                | P#DB1.DBX0.0<br>BYTE 8192       | –  |
| LEN                         | len                              | 16#0                            | –  |

## 3.6 Function

The FBs "BsendData" and "BrcvData" are implemented as a state machine. The design model of a state machine is particularly suitable for modeling more complex asynchronous processes, such as communication between partners, which can extend over several cycles.

A certain state is run through cyclically until a transition condition is fulfilled and the machine switches to the next subsequent state. This not only improves the clarity compared to conventional link control, but also makes it easier to find any errors in the program logic more quickly.

### 3.6.1 Overview

#### FB "BsendData"

The following figure shows the sequence of FB "BsendData".

Figure 3-8

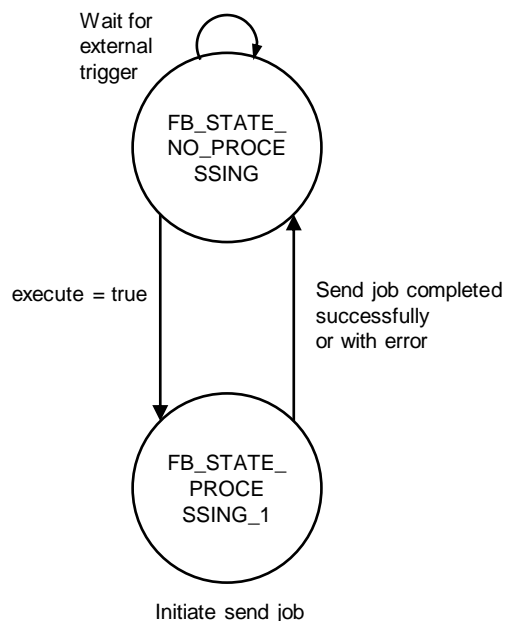

**FB "BrcvData"**

The following figure shows the sequence of FB "BrcvData".

Figure 3-9

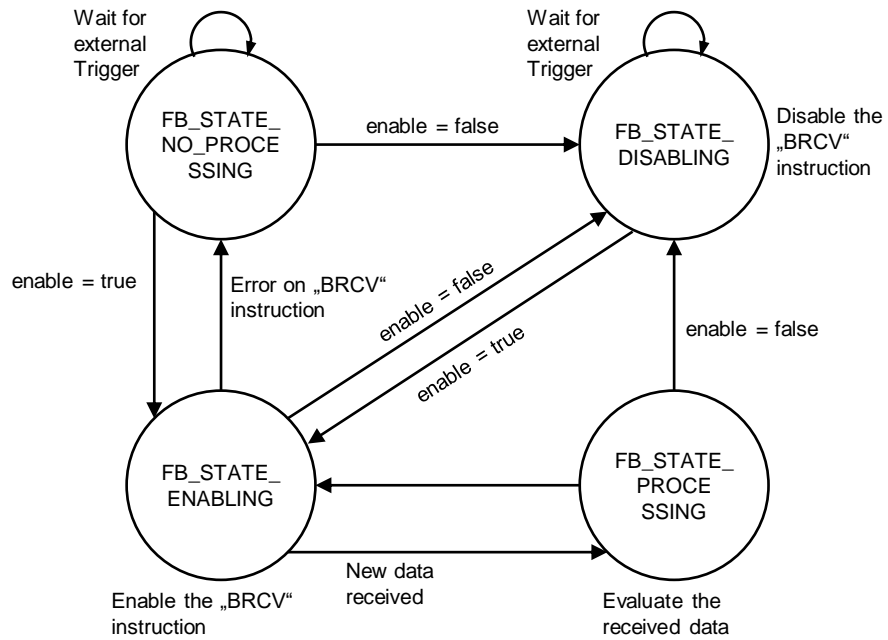

### 3.6.2 Description of the States

#### FB "BsendData"

The following table describes the implemented states and the possible transitions of FB "BsendData".

Table 3-11

| State                  | Description   | Transition  |
|------------------------|---|---|
| FB_STATE_NO_PROCESSING | In this state the FB has the following properties: <ul style="list-style-type: none"> <li>• No Send job is active.</li> <li>• The value 16#7000 is output at the "status" output of the FB.</li> </ul>  | The FB switches to the state "FB_STATE_PROCESSING_1" when a positive edge is detected at the "execute" input of the FB.   |
| FB_STATE_PROCESSING_1  | In this state the FB executes the following actions: <ul style="list-style-type: none"> <li>• The FB starts the Send job with the "BSEND" instruction.</li> <li>• The FB monitors whether the "BSEND" instruction has terminated successfully (DONE = true) or with an error (ERROR = true).</li> </ul> | The state is exited when the Send job is completed successfully or with an error. <ul style="list-style-type: none"> <li>• If the Send job is completed successfully, the following actions are performed:                             <ul style="list-style-type: none"> <li>- The "done" output is set to the value "true" for one cycle.</li> <li>- The FB switches to the state "FB_STATE_NO_PROCESSING"</li> </ul> </li> <li>• If the Send job is completed with an error, the following actions are performed:                             <ul style="list-style-type: none"> <li>- The "error" output is set to the value "true" for one cycle.</li> <li>- The status display of the "BSEND" instruction is output at the "status" output.</li> <li>- The FB switches to the state "FB_STATE_NO_PROCESSING"</li> </ul> </li> </ul> |



**FB "BrcvData"**

The following table describes the implemented states and the possible transitions of FB "BrcvData".

Table 3-12

| State                  | Description   | Transition  |
|------------------------|---|---|
| FB_STATE_NO_PROCESSING | <p>In this state the FB has the following properties:</p> <ul style="list-style-type: none"> <li>No readiness to receive, in other words no data can be received.</li> <li>The value 16#7000 is output at the "status" output of the FB.</li> </ul>   | <p>If the input "enable" of the FB is set to the value "TRUE", the following actions are performed:</p> <ul style="list-style-type: none"> <li>The "valid" output is set to the value "true".</li> <li>The "busy" output is set to the value "true".</li> <li>The "error" output is reset to the value "false".</li> <li>The FB switches to the state "FB_STATE_ENABLING"</li> </ul> <p>If a negative edge is recognized at the input "enable", the FB switches to the state "FB_STATE_DISABLING".</p>  |
| FB_STATE_ENABLING      | <p>In this state the FB executes the following actions:</p> <ul style="list-style-type: none"> <li>The input "EN_R" of the "BRCV" instruction is set to the value "true" to signal the readiness to receive.</li> <li>The FB monitors whether the "BRCV" instruction is receiving new data (NDR = true) or whether an error has occurred (ERROR = true).</li> </ul> | <p>The state is exited when one of the following conditions is met:</p> <ul style="list-style-type: none"> <li>New data is being received: <ul style="list-style-type: none"> <li>The FB switches to the state "FB_STATE_NO_PROCESSING"</li> </ul> </li> <li>An error occurs: <ul style="list-style-type: none"> <li>The "valid" output is reset to the value "false".</li> <li>The "busy" output is reset to the value "false".</li> <li>The "error" output is set to the value "true".</li> <li>The status display of the "BRCV" instruction is output at the "status" output.</li> <li>The FB switches to the state "FB_STATE_NO_PROCESSING".</li> </ul> </li> <li>A negative edge is recognized at the input "enable": <ul style="list-style-type: none"> <li>The FB switches to the state "FB_STATE_DISABLING".</li> </ul> </li> </ul> |

| State                   | Description  | Transition   |
|-------------------------|--|--|
| FB_STATE_<br>DISABLING  | <p>In this state the outputs of the FB are reset:</p> <ul style="list-style-type: none"> <li>• "valid" = false</li> <li>• "error" = false</li> <li>• "busy" = false</li> </ul> <p>In this state the FB has the following properties:</p> <ul style="list-style-type: none"> <li>• No readiness to receive, in other words no data can be received.</li> <li>• The value 16#7000 is output at the "status" output of the FB.</li> </ul> | <p>If the input "enable" of the FB is set to the value "TRUE", the following actions are performed:</p> <ul style="list-style-type: none"> <li>- The "valid" output is set to the value "true".</li> <li>- The "busy" output is set to the value "true".</li> <li>- The "error" output is reset to the value "false".</li> <li>- The FB switches to the state "FB_STATE_ENABLING"</li> </ul> |
| FB_STATE_<br>PROCESSING | <p>In this state the received data can be evaluated, for example.</p>  | <p>The FB switches back to the state "FB_STATE_ENABLING" without transition condition.</p> <p>If a negative edge is recognized at the input "enable", the FB switches to the state "FB_STATE_DISABLING".</p>   |

## 3.7 Error Handling

### 3.7.1 FB "BsendData"

If an error occurs in FB "BsendData", the cause of the error is written to the "status" output parameter.

Table 3-13

| error | status    | Description                                | Remedy   |
|-------|-----------|--|--|
| 0     | 16#7000   | FB "BsendData" is not active.              | Status information<br>Enable FB "BsendData" by setting the "execute" input to "true".  |
| 0     | 16#7001   | FB "BsendData" is initialized.             | Status information   |
| 0     | 16#7002   | Send job is running                        | Status information   |
| 1     | <>16#0000 | Status display of the "BSEND" instruction. | Detailed information is available in the STEP 7 Online Help or in the following manual:<br><a href="#">"SIMATIC STEP 7 Basic/Professional V16 and SIMATIC WinCC V16"</a> . |

### 3.7.2 FB "BrcvData"

If an error occurs in FB "BrcvData", the cause of the error is written to the "status" output parameter.

Table 3-14

| error | status    | Description                               | Remedy   |
|-------|-----------|---|--|
| 0     | 16#7000   | FB "BrcvData" is not active.              | Status information<br>Enable FB "BrcvData" by setting the "execute" input to "true".   |
| 0     | 16#7001   | FB "BrcvData" is initialized.             | Status information   |
| 0     | 16#7002   | Readiness to receive is active.           | Status information   |
| 1     | <>16#0000 | Status display of the "BRCV" instruction. | Detailed information is available in the STEP 7 Online Help or in the following manual:<br><a href="#">"SIMATIC STEP 7 Basic/Professional V16 and SIMATIC WinCC V16"</a> . |

## 4 Information

### NOTE

The parameters "ID" and "R\_ID" cannot be used dynamically because they are evaluated when "BSEND" or "BRCV" is called for the first time and defined for this instance. They cannot be changed in subsequent calls.

The outputs "DONE", "NDR", "ERROR" and "STATUS" are only available in the cycle in which the event occurred. For this reason, the evaluation and the event handling must be carried out in the same cycle or at least triggered.

### 4.1 Notes on using "BSEND"

1. A job is started with a positive edge at the "REQ" input. Do not reset the "REQ" input until the job has ended with "DONE" = true or "ERROR" = true. A send job can then be triggered again with a positive edge at "REQ" input. To ensure the function you must program at least one zero run at the "REQ" input of "BSEND".
2. If the "ERROR" output is set, you evaluate the "STATUS" output to retrieve any additional information available on the cause of the error and thus clear it directly. If necessary, the "STATUS" output can be evaluated generally, since in one case (job is still running, this means STATUS = 11 (dec.)) the "ERROR" output does not have to be set.
3. The "ID" parameter contains the local ID assigned when the connection was configured.
4. The "R\_ID" parameter has to be the same for both partner instructions ("BSEND" and "BRCV") and unique in the system.
5. The length specification in the parameter "SD\_1" is evaluated only the first time "BSEND" is called. The send buffer is made available on the basis of this value. This value specifies maximum volume of data that can be transferred for this instance. In subsequent calls only the "LEN" parameter is evaluated and transferred according to the data volume specified.

Detailed information about the "BSEND" instruction is given in the manual entitled ["SIMATIC STEP 7 Basic/Professional V16 and SIMATIC WinCC V16"](#).

### 4.2 Notes on using "BRCV"

1. It is recommended to set the input "EN\_R" continuously to "true", because "BRCV" works asynchronously. Conditional calls can mean that data sent by the partner cannot be received or accepted.
2. The "ID" parameter contains the local ID assigned when the connection was configured.
3. The "R\_ID" parameter has to be the same for both partner instructions ("BSEND" and "BRCV") and unique in the system.
4. The length specification in the parameter "RD\_1" is evaluated only the first time "BRCV" is called. The receive buffer is made available on the basis of this value. This value specifies maximum volume of data that can be transferred for this instance. In subsequent calls only the "LEN" parameter is evaluated and transferred according to the data volume specified.

5. A receive job is completed with "NDR" = true or "ERROR" = true. Only when the receive job has been completed with "NDR" = true can the data in the receive buffer be accessed (data consistency).
6. If the "ERROR" output is set, you evaluate the "STATUS" output to retrieve any additional information available on the cause of the error and thus clear it directly. If necessary, the "STATUS" output can be evaluated generally, since in one case (job is still running, this means STATUS = 11 (dec.)) the "ERROR" output does not have to be set.

Detailed information about the "BSEND" instruction is given in the manual entitled "[SIMATIC STEP 7 Basic/Professional V16 and SIMATIC WinCC V16](#)".

### 4.3 Configuration of the "BSEND" and "BRCV" Instructions

When you configure FB "BsendData" and FB "BrcvData" you define the following input parameters:

- "connectionId": Enter the connection ID of the configured S7 connection. The connection ID is used internally in the FB on the instructions "BSEND" and "BRCV".
- "rid": Enter the address parameter to define the instruction pair "BSEND" and "BRCV". The address parameter used internally in the FB on the instructions "BSEND" and "BRCV".