

SIEMENS

RUGGEDCOM RSG2100

Installation Guide

Preface

Introduction

1

Installing Device

2

Communication Ports

3

Technical Specifications

4

Dimension Drawings

5

Certification

6

Copyright © 2015 Siemens Canada Ltd.

All rights reserved. Dissemination or reproduction of this document, or evaluation and communication of its contents, is not authorized except where expressly permitted. Violations are liable for damages. All rights reserved, particularly for the purposes of patent application or trademark registration.

This document contains proprietary information, which is protected by copyright. All rights are reserved. No part of this document may be photocopied, reproduced or translated to another language without the prior written consent of Siemens Canada Ltd..

Disclaimer Of Liability

Siemens has verified the contents of this manual against the hardware and/or software described. However, deviations between the product and the documentation may exist.

Siemens shall not be liable for any errors or omissions contained herein or for consequential damages in connection with the furnishing, performance, or use of this material.

The information given in this document is reviewed regularly and any necessary corrections will be included in subsequent editions. We appreciate any suggested improvements. We reserve the right to make technical improvements without notice.

Registered Trademarks

ROX™, Rugged Operating System On Linux™, CrossBow™ and ELAN™ are trademarks of Siemens Canada Ltd. ROS® is a registered trademark of Siemens Canada Ltd.

Other designations in this manual might be trademarks whose use by third parties for their own purposes would infringe the rights of the owner.

Third Party Copyrights

Siemens recognizes the following third party copyrights:

- Copyright © 2004 GoAhead Software, Inc. All Rights Reserved.

Security Information

Siemens provides products and solutions with industrial security functions that support the secure operation of plants, machines, equipment and/or networks. They are important components in a holistic industrial security concept. With this in mind, Siemens' products and solutions undergo continuous development. Siemens recommends strongly that you regularly check for product updates.

For the secure operation of Siemens products and solutions, it is necessary to take suitable preventive action (e.g. cell protection concept) and integrate each component into a holistic, state-of-the-art industrial security concept. Third-party products that may be in use should also be considered. For more information about industrial security, visit <http://www.siemens.com/industrialsecurity>.

To stay informed about product updates as they occur, sign up for a product-specific newsletter. For more information, visit <http://support.automation.siemens.com>.

Warranty

Siemens warrants this product for a period of five (5) years from the date of purchase, conditional upon the return to factory for maintenance during the warranty term. This product contains no user-serviceable parts. Attempted service by unauthorized personnel shall render all warranties null and void. The warranties set forth in this article are exclusive and are in lieu of all other warranties, performance guarantees and conditions whether written or oral, statutory, express or implied (including all warranties and conditions of merchantability and fitness for a particular purpose, and all warranties and conditions arising from course of dealing or usage or trade). Correction of nonconformities in the manner and for the period of time provided above shall constitute the Seller's sole liability and the Customer's exclusive remedy for defective or nonconforming goods or services whether claims of the Customer are based in contract (including fundamental breach), in tort (including negligence and strict liability) or otherwise.

For warranty details, visit www.siemens.com/ruggedcom or contact a Siemens customer service representative.

Contacting Siemens

Address

Siemens Canada Ltd.
Industry Sector
300 Applewood Crescent
Concord, Ontario
Canada, L4K 5C7

Telephone

Toll-free: 1 888 264 0006
Tel: +1 905 856 5288
Fax: +1 905 856 1995

E-mail

ruggedcom.info.i-ia@siemens.com

Web

www.siemens.com/ruggedcom

Table of Contents

Preface	v
Alerts	v
Related Documents	v
Accessing Documentation	v
Training	vi
Customer Support	vi
 Chapter 1	
Introduction	1
1.1 Feature Highlights	1
1.2 Description	2
 Chapter 2	
Installing Device	5
2.1 Mounting the Device	5
2.1.1 Mounting the Device to a Rack	6
2.1.2 Mounting the Device on a DIN Rail	7
2.1.3 Mounting the Device to a Panel	7
2.2 Connecting Power	8
2.2.1 Connecting AC Power	9
2.2.2 Connecting DC Power	10
2.2.3 Wiring Examples	12
2.3 Connecting the Failsafe Alarm Relay	14
2.4 Grounding the Device	15
2.5 Connecting to the Device	15
2.6 Cabling Recommendations	16
2.6.1 Protection On Twisted-Pair Data Ports	17
2.6.2 Gigabit Ethernet 1000Base-TX Cabling Recommendations	17
 Chapter 3	
Communication Ports	19
3.1 Copper Ethernet Ports	20
3.2 Fiber Optic Ethernet Ports	22
3.3 SFP Optic Ethernet Ports	22
3.3.1 Installing an SFP Optical Port	23

3.3.2 Removing an SFP Optical Port	24
3.4 GBIC Optic Ethernet Ports	24
3.4.1 Installing a GBIC Optical Port	25
3.4.2 Removing a GBIC Optical Port	26
3.5 BNC Ports	26
Chapter 4	
Technical Specifications	29
4.1 Power Supply Specifications	29
4.2 Failsafe Relay Specifications	29
4.3 Supported Networking Standards	30
4.4 Copper Ethernet Port Specifications	30
4.4.1 Copper Fast (10/100 Mbps) Ethernet Port Specifications	30
4.4.2 Copper Gigabit Ethernet (1 Gbps) Port Specifications	31
4.5 Fiber Optic Ethernet Port Specifications	31
4.5.1 10FL Ethernet Optical Specifications	32
4.5.2 Fast Ethernet (10/100 Mbps) Optical Specifications	32
4.5.3 Gigabit Ethernet (1 Gbps) Optical Specifications	33
4.6 Operating Environment	34
4.7 Mechanical Specifications	34
Chapter 5	
Dimension Drawings	35
Chapter 6	
Certification	39
6.1 Standards Compliance	39
6.2 Agency Approvals	39
6.3 EMI and Environmental Type Tests	40

Preface

This guide describes the RUGGEDCOM RUGGEDCOM RSG2100. It describes the major features of the device, installation, commissioning and important technical specifications.

It is intended for use by network technical support personnel who are responsible for the installation, commissioning and maintenance of the device. It is also recommended for use by network and system planners, system programmers, and line technicians.

Alerts

The following types of alerts are used when necessary to highlight important information.



DANGER!

DANGER alerts describe imminently hazardous situations that, if not avoided, will result in death or serious injury.



WARNING!

WARNING alerts describe hazardous situations that, if not avoided, may result in serious injury and/or equipment damage.



CAUTION!

CAUTION alerts describe hazardous situations that, if not avoided, may result in equipment damage.



IMPORTANT!

IMPORTANT alerts provide important information that should be known before performing a procedure or step, or using a feature.



NOTE

NOTE alerts provide additional information, such as facts, tips and details.

Related Documents

Other documents that may be of interest include:

- ROS User Guide for the RUGGEDCOM RSG2100

Accessing Documentation

The latest Hardware Installation Guides and Software User Guides for most RUGGEDCOM products are available online at www.siemens.com/ruggedcom.

For any questions about the documentation or for assistance finding a specific document, contact a Siemens sales representative.

Training

Siemens offers a wide range of educational services ranging from in-house training of standard courses on networking, Ethernet switches and routers, to on-site customized courses tailored to the customer's needs, experience and application.

Siemens' Educational Services team thrives on providing our customers with the essential practical skills to make sure users have the right knowledge and expertise to understand the various technologies associated with critical communications network infrastructure technologies.

Siemens' unique mix of IT/Telecommunications expertise combined with domain knowledge in the utility, transportation and industrial markets, allows Siemens to provide training specific to the customer's application.

For more information about training services and course availability, visit www.siemens.com/ruggedcom or contact a Siemens sales representative.

Customer Support

Customer support is available 24 hours, 7 days a week for all Siemens customers. For technical support or general information, contact Siemens Customer Support through any of the following methods:



Online

Visit <http://www.siemens.com/automation/support-request> to submit a Support Request (SR) or check on the status of an existing SR.

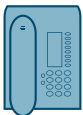

Telephone

Call a local hotline center to submit a Support Request (SR). To locate a local hotline center, visit <http://www.automation.siemens.com/mcms/aspa-db/en/automation-technology/Pages/default.aspx>.



Mobile App

Install the Industry Online Support app by Siemens AG on any Android, Apple iOS or Windows mobile device and be able to:

- Access Siemens' extensive library of support documentation, including FAQs and manuals
- Submit SRs or check on the status of an existing SR
- Contact a local Siemens representative from Sales, Technical Support, Training, etc.
- Ask questions or share knowledge with fellow Siemens customers and the support community

1 Introduction

The RUGGEDCOM RUGGEDCOM RSG2100 is a rugged, fully managed, modular Ethernet switch specifically designed to operate reliably in electrically harsh and climatically demanding utility substation, railway and industrial environments. The RUGGEDCOM RSG2100's superior rugged hardware design coupled with the embedded Rugged Operating System (ROS) provides improved system reliability and advanced cyber security and networking features, making it ideally suited for creating Ethernet networks for mission-critical, real-time, control applications.

The RUGGEDCOM RSG2100's modular flexibility offers 10BaseFL/100BaseFX/1000BaseX fiber and 10/100/1000BaseTX copper port combinations. Optional front or rear mount connectors make the RUGGEDCOM RSG2100 highly versatile for any application and can support multiple fiber connectors (ST, MTRJ, LC, SC) without loss of port density. The RUGGEDCOM RSG2100 is packaged in a rugged galvanized steel enclosure with industrial grade DIN, panel, or 48 cm (19 in) rack-mount mounting options.

The following sections provide more information about the RUGGEDCOM RSG2100:

- [Section 1.1, "Feature Highlights"](#)
- [Section 1.2, "Description"](#)

Section 1.1

Feature Highlights

Ethernet Ports

- Up to 3 x Gigabit Ethernet ports (copper and fiber)
- Up to 16 x 100Base-FX Fiber Fast Ethernet ports (copper and fiber)
- 2-port modules for tremendous flexibility
- Non-blocking, store and forward switching
- Supports many types of fiber (multimode, single mode, bidirectional single strand)
- Long haul optics allow Gigabit at distances up to 70 km
- Multiple connector types (ST, MTRJ, LC, SC)

Rated for Reliability in Harsh Environments

- Immunity to EMI and heavy electrical surges
- Zero-Packet-Loss™ technology
- -40 to 85 °C (-40 to 185 °F) operating temperature (no fans)
- Conformal coated printed circuit boards (optional)
- 18 AWG galvanized steel enclosure
- Hazardous Location Certification: Class 1 Division 2

Universal Power Supply Options

- Fully integrated, dual-redundant (optional) power supplies
- Universal high-voltage range: 88-300 VDC or 85-264 VAC

- Screw or pluggable terminal blocks for reliable, maintenance-free connections
- CSA/UL 60950-1 safety approved to 85 °C (185 °F)

Section 1.2

Description

The RUGGEDCOM RSG2100 features various ports, controls and indicator LEDs on the display panel for connecting, configuring and troubleshooting the device. The display panel can be located on the rear, front or top of the device, depending on the mounting configuration.

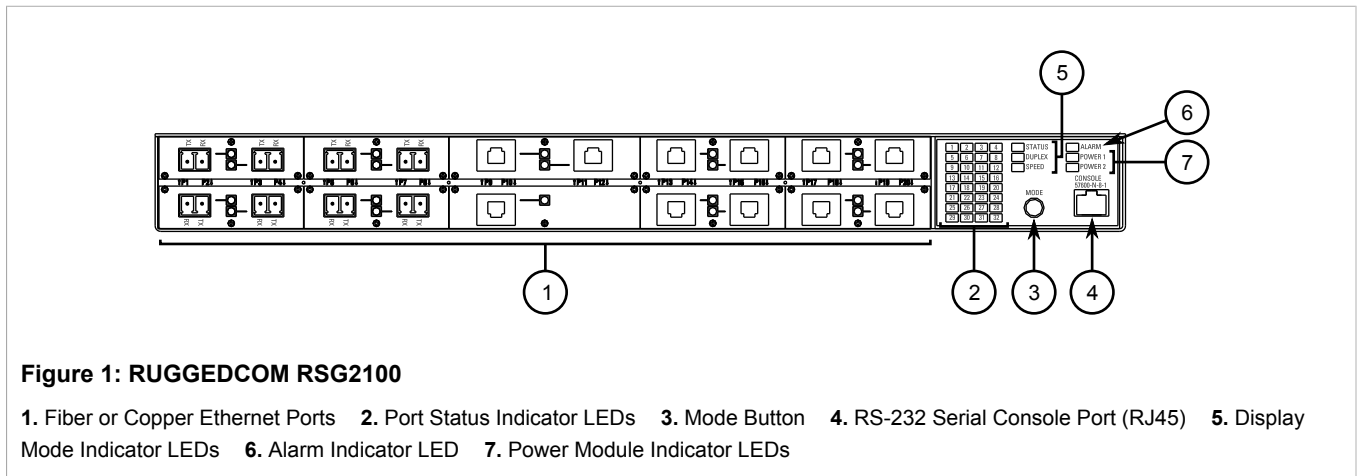

- **Communication Ports** – Ports for communicating with other devices or accessing the RUGGEDCOM ROS operating system are described in [Chapter 3, Communication Ports](#).
- **Port Status Indicator LEDs** – Port status indicator LEDs indicate the operational status of each port, dependent on the currently selected mode.

Mode	Color/State	Description
Status	Green (Solid)	Link detected
	Green (Blinking)	Link activity
	Off	No link detected
Duplex	Green	Full duplex mode
	Orange	Half duplex mode
	Off	No link detected
Speed	Green (Solid)	100 Mb/s
	Green (Blinking)	1000 Mb/s
	Orange (Solid)	10 Mb/s
	Off	No link detected

- **Display Mode Indicator LEDs** – The display mode indicator LEDs indicate the current display mode for the port status indicator LEDs (i.e. Status, Duplex or Speed).

- **Mode button** – The **Mode** button sets the display mode for the port status indicator LEDs (i.e. Status, Duplex or Speed). It can also be used to reset the device if held for 5 seconds.
- **Alarm Indicator LED** – The alarm indicator LED illuminates when an alarm condition exists.
- **Power Module Indicator LEDs** – The power module indicator LEDs indicate the status of the power modules.
 - **Green** – The power supply is supplying power
 - **Red** – Power supply failure
 - **Off** – No power supply is installed
- **RS-232 Console Port** – The serial console port is for interfacing directly with the device and accessing initial management functions. For information about connecting to the device via the serial console port, refer to [Section 2.5, “Connecting to the Device”](#).

2 Installing Device

The following sections describe how to install the device, including mounting the device, installing/removing modules, connecting power, and connecting the device to the network.



DANGER!

Electrocution hazard – risk of serious personal injury and/or damage to equipment. Before performing any maintenance tasks, make sure all power to the device has been disconnected and wait approximately two minutes for any remaining energy to dissipate.



WARNING!

Radiation hazard – risk of serious personal injury. This product contains a laser system and is classified as a CLASS 1 LASER PRODUCT. Use of controls or adjustments or performance of procedures other than those specified herein may result in hazardous radiation exposure.



IMPORTANT!

This product contains no user-serviceable parts. Attempted service by unauthorized personnel shall render all warranties null and void.

Changes or modifications not expressly approved by Siemens Canada Ltd. could invalidate specifications, test results, and agency approvals, and void the user's authority to operate the equipment.



IMPORTANT!

This product should be installed in a restricted access location where access can only be gained by authorized personnel who have been informed of the restrictions and any precautions that must be taken. Access must only be possible through the use of a tool, lock and key, or other means of security, and controlled by the authority responsible for the location.

- [Section 2.1, “Mounting the Device”](#)
- [Section 2.2, “Connecting Power”](#)
- [Section 2.3, “Connecting the Failsafe Alarm Relay”](#)
- [Section 2.4, “Grounding the Device”](#)
- [Section 2.5, “Connecting to the Device”](#)
- [Section 2.6, “Cabling Recommendations”](#)

Section 2.1

Mounting the Device

The RUGGEDCOM RSG2100 is designed for maximum mounting and display flexibility. It can be equipped with connectors that allow it to be installed in a 48 cm (19 in) rack, 35 mm (1.4 in) DIN rail, or directly on a panel.



NOTE

For detailed dimensions of the device with either rack, DIN rail or panel hardware installed, refer to Chapter 5, Dimension Drawings.

The following sections describe the various methods of mounting the device:

- Section 2.1.1, “Mounting the Device to a Rack”
- Section 2.1.2, “Mounting the Device on a DIN Rail”
- Section 2.1.3, “Mounting the Device to a Panel”

Section 2.1.1

Mounting the Device to a Rack

For rack mount installations, the RUGGEDCOM RSG2100 can be equipped with rack mount adapters pre-installed at the front or rear of the chassis. Additional adapters are provided to further secure the device in high-vibration or seismically active locations.

To secure the device to a standard 48 cm (19 in) rack, do the following:



NOTE

The device can be ordered with the communication ports located at the front or rear of the device. Placing the ports at the rear allows all data and power cabling to be installed and connected at the rear of the rack.

1. Make sure the rack mount adapters are installed on the correct side of the chassis.



NOTE

The chassis features multiple mounting holes, allowing the rack mount adapters to be installed up to 25 mm (1 in) from the face of the device.

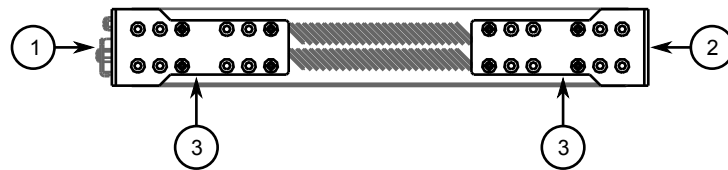

Figure 2: Rack Mount Adaptors

1. Rear 2. Front 3. Rack Mount Adaptor

2. If required, install adapters on the opposite side of the device to protect from vibrations.
3. Insert the device into the rack.



NOTE

Since heat within the device is channelled to the enclosure, it is recommended that 1 rack-unit of space, or 44 mm (1.75 in), be kept empty above the device. This allows a small amount of convectional airflow.

Forced airflow is not required. However, any increase in airflow will result in a reduction of ambient temperature and improve the long-term reliability of all equipment mounted in the rack space.

- Secure the adapters to the rack using the supplied hardware.

Section 2.1.2

Mounting the Device on a DIN Rail

For DIN rail installations, the RUGGEDCOM RSG2100 can be equipped with panel/DIN rail adapters pre-installed on each side of the chassis. The adapters allow the device to be slid onto a standard 35 mm (1.4 in) DIN rail.



IMPORTANT!

DIN rail mounting is not recommended for constant vibration environments.

To mount the device to a DIN rail, do the following:

- Align the adapters with the DIN rails and slide the device into place.

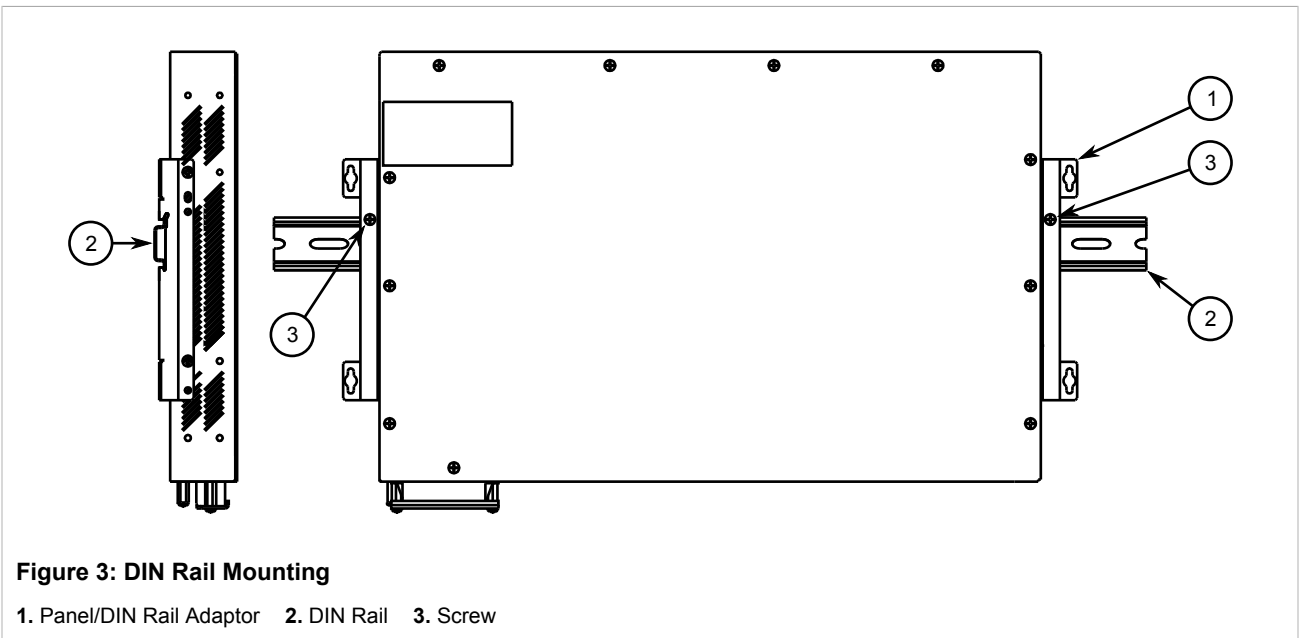

- Install one of the supplied screws on either side of the device to secure the adapters to the DIN rails.

Section 2.1.3

Mounting the Device to a Panel

For panel installations, the RUGGEDCOM RSG2100 can be equipped with panel/DIN rail adapters pre-installed on each side of the chassis. The adapters allow the device to be attached to a panel using screws.

To mount the device to a panel, do the following:

- Place the device against the panel and align the adapters with the mounting holes.

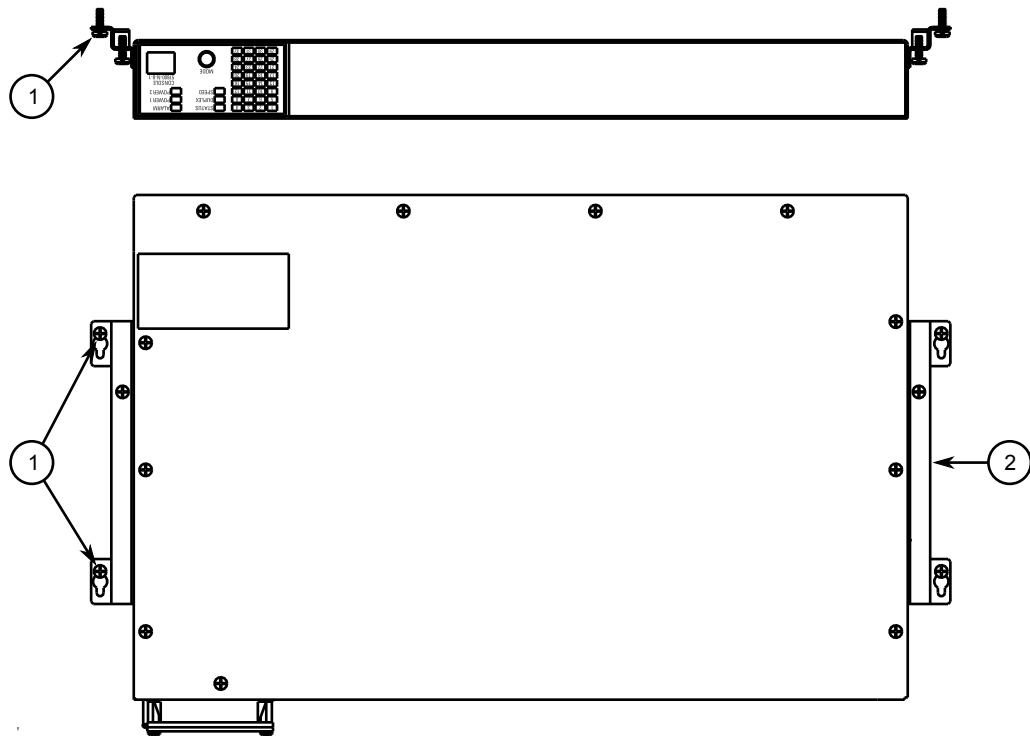

Figure 4: Panel Mounting

1. Screw 2. Panel/DIN Rail Adaptor

2. Install the supplied screws to secure the adapters to the panel.

Section 2.2

Connecting Power

The RUGGEDCOM RSG2100 supports single or dual redundant AC and/or DC power supplies. The use of two power modules is recommended to provide redundancy and load balancing.

The RUGGEDCOM RSG2100 can be equipped with either a screw-type or pluggable terminal block, which provides power to both power supplies. The screw-type terminal block is installed using Phillips screws and compression plates, allowing either bare wire connections or crimped terminal lugs. Use #6 size ring lugs for secure, reliable connections under severe shock or vibration.



NOTE

- For maximum redundancy in a dual power supply configuration, use two independent power sources.
- Use only #16 gage copper wiring when connecting terminal blocks.
- For 100-240 VAC rated equipment, an appropriately rated AC circuit breaker must be installed.
- A circuit breaker is not required for 12, 24 or 48 VDC rated power supplies.
- It is recommended to provide a separate circuit breaker for each power supply module.

- *Equipment must be installed according to applicable local wiring codes and standards.*

The following sections describe how to connect power to the device:

- [Section 2.2.1, “Connecting AC Power”](#)
- [Section 2.2.2, “Connecting DC Power”](#)
- [Section 2.2.3, “Wiring Examples”](#)

Section 2.2.1

Connecting AC Power

To connect a high AC power supply to the device, do the following:



CAUTION!

Electrical hazard – risk of damage to equipment. Do not connect AC power cables to terminals for DC power. Damage to the power supply may occur.



CAUTION!

Electrical hazard – risk of damage to equipment. Before testing the dielectric strength (HIPOT) in the field, remove the metal jumper. This metal jumper connects transient suppression circuitry to chassis ground and must be removed in order to avoid damage to transient suppression circuitry during testing.



NOTE

The terminal block is divided into separate terminals for each internal power supply. Make sure to connect the external power supply to the appropriate terminals.



NOTE

The screw-type terminal block is installed using Phillips screws and compression plates, allowing either bare wire connections or crimped terminal lugs. Use #6 size ring lugs for secure, reliable screws, which must be removed to make connections.

1. Remove the terminal block cover.
2. If a screw-type terminal block is installed, remove the screws from the appropriate terminals. Use these screws along with #6 ring lugs to secure the wires to the terminal block.
3. Connect the positive wire from the power source to the positive/live (+/L) terminal on the terminal block. For more information, refer to [Section 2.2.3, “Wiring Examples”](#).

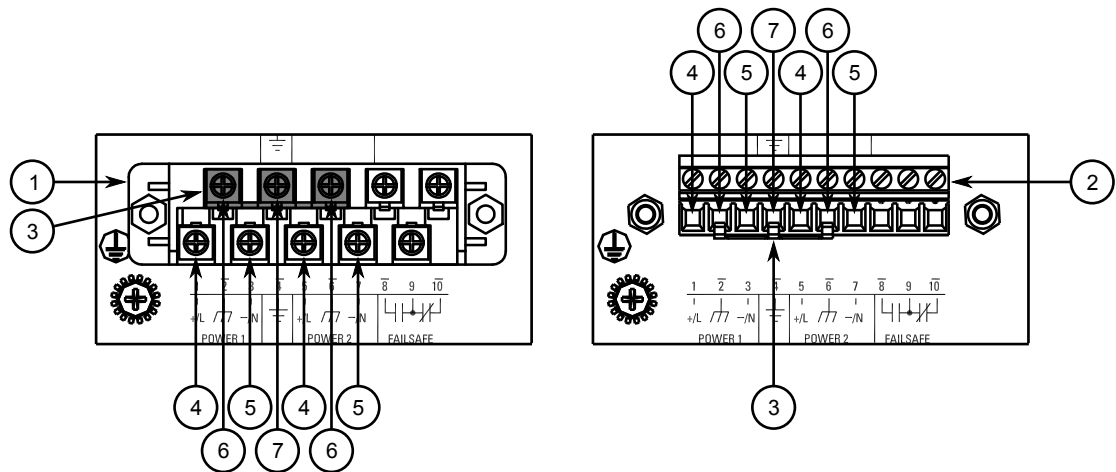

Figure 5: Terminal Block Wiring

1. Screw-Type Terminal Block 2. Pluggable Terminal Block 3. Jumper 4. Positive/Live (+/L) Terminal 5. Negative/Neutral (-/N) Terminal (-/N) 6. Surge Ground Terminal 7. Chassis Ground Terminal

4. Connect the negative wire from the power source to the negative/neutral (-/N) terminal on the terminal block. For more information, refer to [Section 2.2.3, “Wiring Examples”](#).
5. Install the supplied metal jumper between terminals 2, 4 and 6 to connect the surge ground terminals to the chassis ground terminal. The surge ground terminals are used as the ground conductor for all surge and transient suppression circuitry internal to the unit.
6. Connect the ground terminal on the power source to the chassis ground terminal on the device. For more information, refer to [Section 2.4, “Grounding the Device”](#)



DANGER!

Electrocution hazard – risk of death, serious personal injury and/or damage to the device. Make sure the supplied terminal block cover is always installed before the device is powered.

7. Install the terminal block cover.

Section 2.2.2

Connecting DC Power

To connect a high or low DC power supply to the device, do the following:



CAUTION!

Electrical hazard – risk of damage to equipment. Before testing the dielectric strength (HIPOT) in the field, remove the metal jumper. This metal jumper connects transient suppression circuitry to chassis ground and must be removed in order to avoid damage to transient suppression circuitry during testing.



NOTE

The terminal block is divided into separate terminals for each internal power supply. Make sure to connect the external power supply to the appropriate terminals.



NOTE

The screw-type terminal block is installed using Phillips screws and compression plates, allowing either bare wire connections or crimped terminal lugs. Use #6 size ring lugs for secure, reliable screws, which must be removed to make connections.

1. Remove the terminal block cover.
2. If a screw-type terminal block is installed, remove the screws from the appropriate terminals. Use these screws along with #6 ring lugs to secure the wires to the terminal block.
3. Connect the positive wire from the power source to the positive/live (+/L) terminal on the terminal block. For more information, refer to [Section 2.2.3, "Wiring Examples"](#).

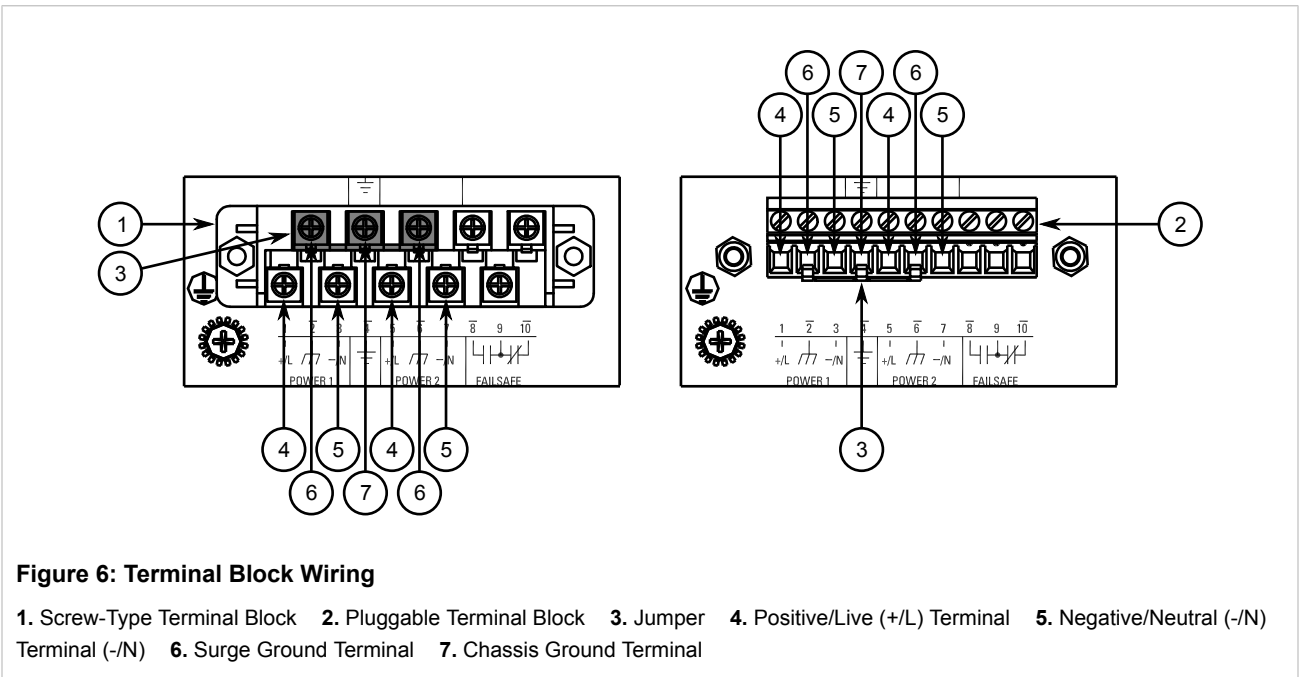

Figure 6: Terminal Block Wiring

1. Screw-Type Terminal Block 2. Pluggable Terminal Block 3. Jumper 4. Positive/Live (+/L) Terminal 5. Negative/Neutral (-/N) Terminal (-/N) 6. Surge Ground Terminal 7. Chassis Ground Terminal

4. Connect the negative wire from the power source to the negative/neutral (-/N) terminal on the terminal block. For more information, refer to [Section 2.2.3, "Wiring Examples"](#).
5. Install the supplied metal jumper between terminals 2, 4 and 6 to connect the surge ground terminals to the chassis ground terminal. The surge ground terminals are used as the ground conductor for all surge and transient suppression circuitry internal to the unit.
6. Connect the ground terminal on the power source to the chassis ground terminal on the device. For more information, refer to [Section 2.4, "Grounding the Device"](#)



DANGER!

Electrocution hazard – risk of death, serious personal injury and/or damage to the device. Make sure the supplied terminal block cover is always installed before the device is powered.

7. Install the terminal block cover.

Section 2.2.3

Wiring Examples

The following illustrate how to connect power to single and dual power supplies.

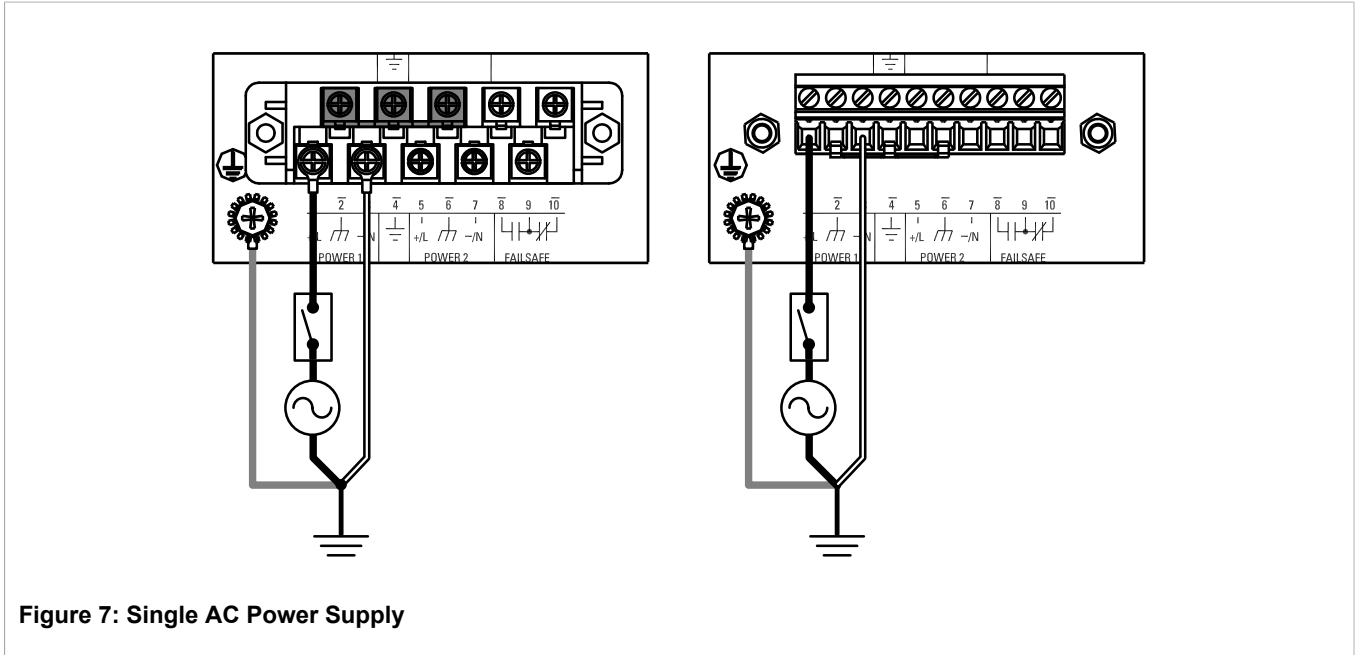

Figure 7: Single AC Power Supply

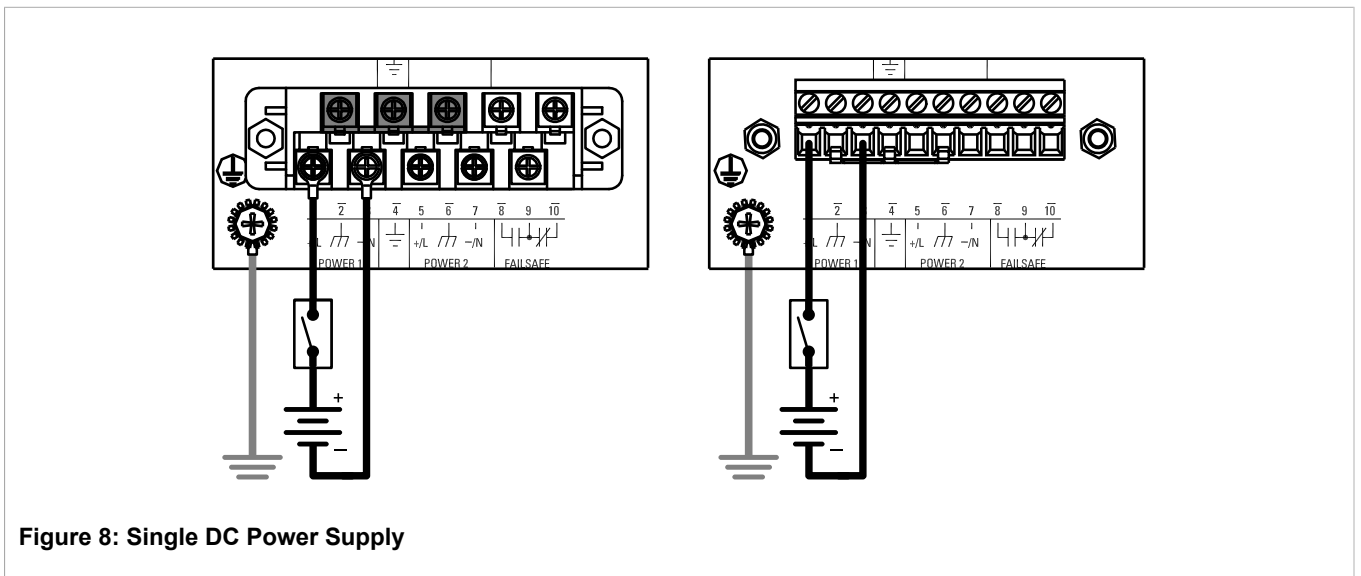

Figure 8: Single DC Power Supply

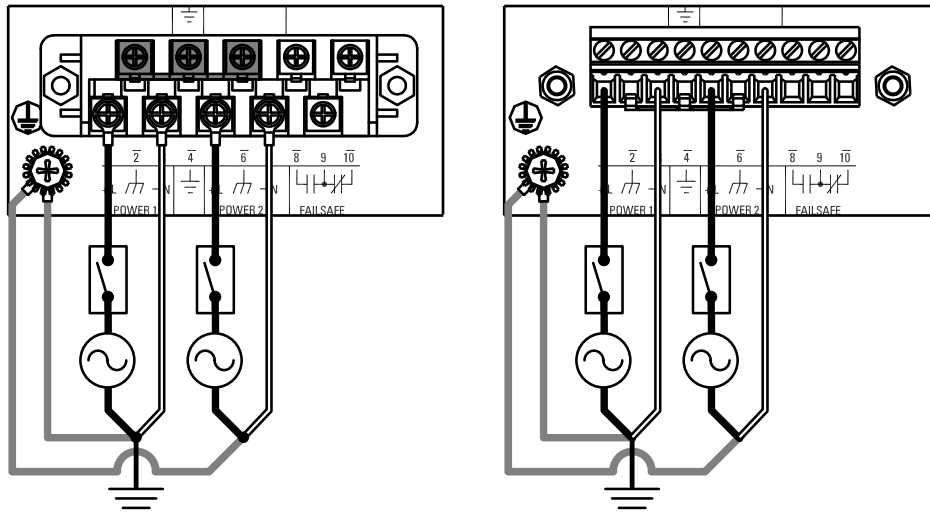

Figure 9: Dual AC Power Supply

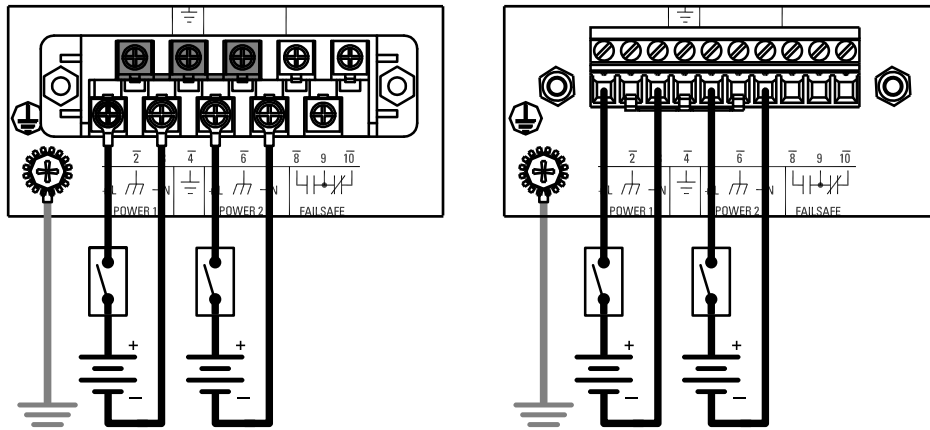
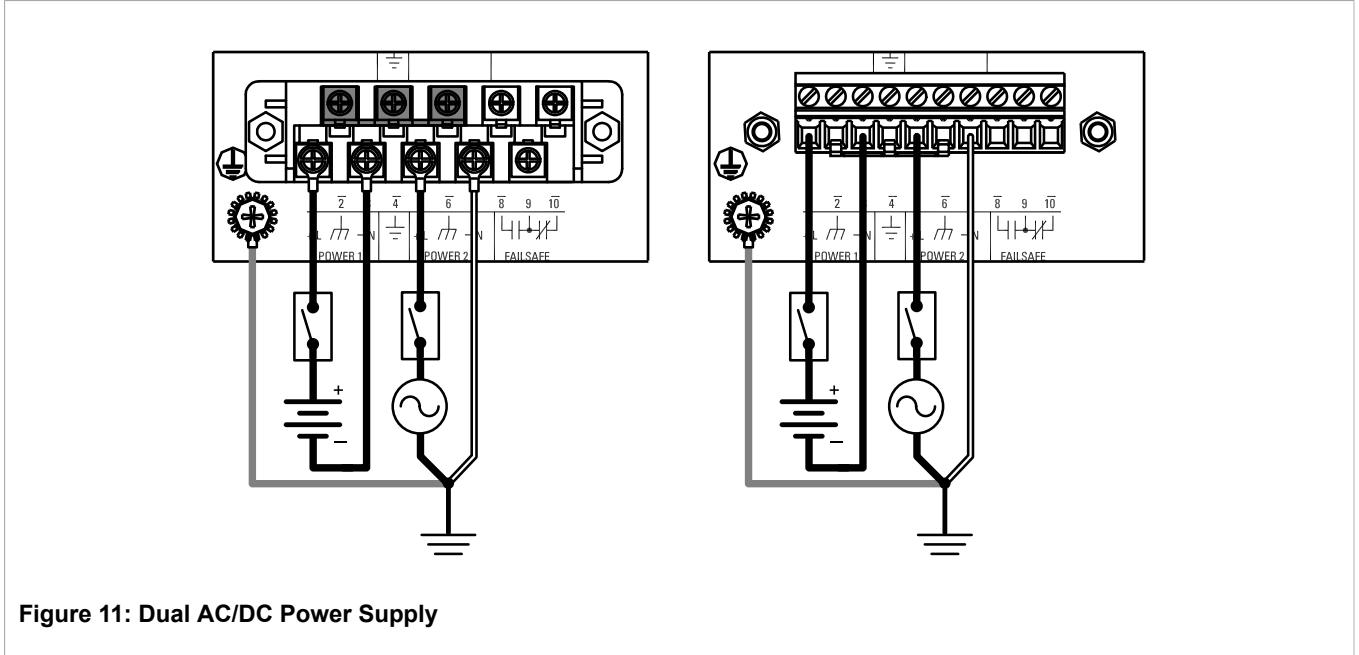

Figure 10: Dual DC Power Supply



Section 2.3

Connecting the Failsafe Alarm Relay

The failsafe relay can be configured to latch based on alarm conditions. The NO (Normally Open) contact is closed when the unit is powered and there are no active alarms. If the device is not powered or if an active alarm is configured, the relay opens the NO contact and closes the NC (Normally Closed) contact.



NOTE

Control of the failsafe relay output is configurable through ROS. One common application for this relay is to signal an alarm if a power failure occurs. For more information, refer to the ROS User Guide for the RUGGEDCOM RSG2100.

The following shows the proper relay connections.

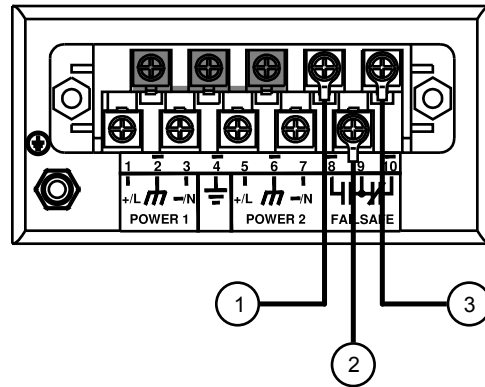

Figure 12: Failsafe Alarm Relay Wiring

1. Normally Open 2. Common 3. Normally Closed

Section 2.4

Grounding the Device

The RUGGEDCOM RSG2100 chassis ground terminal uses a #6-32 screw. It is recommended to terminate the ground connection with a #6 ring lug and torque it to 1.7 N·m (15 lbf·in).

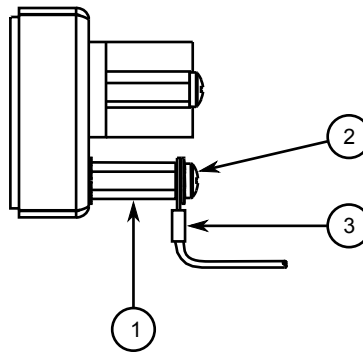

Figure 13: Chassis Ground Connection

1. Stainless Steel Stud 2. #6-32 Screw 3. #6 Ring Lug

Section 2.5

Connecting to the Device

The following describes the various methods for accessing the ROS console and Web interfaces on the device. For more detailed instructions, refer to the *ROS User Guide* for the RUGGEDCOM RSG2100.

RS232 Console Port

Connect a PC or terminal directly to the RS232 console port to access the boot-time control and ROS interfaces. The console port provides access to ROS's console and Web interfaces.



IMPORTANT!

The console port is intended to be used only as a temporary connection during initial configuration or troubleshooting.

Connection to the console port is made using an RJ45-to-DB9 console cable. The following is the pin-out for the console port:

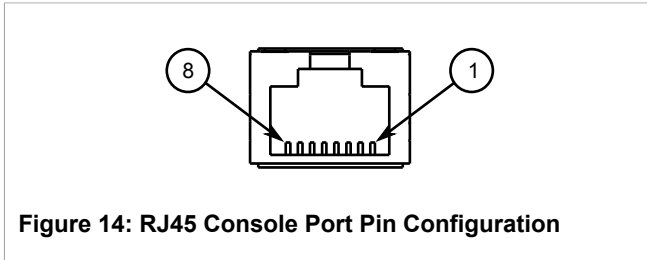

Pin		Name	Description	Comment
RJ45 Male	DB9 Female			
1	6	DSR ^a	Data Set Ready	
2	1	DCD ^a	Carrier Detect	Reserved (Do Not Connect)
3	4	DTR ^a	Data Terminal Ready	
4	5	GND	Signal Ground	
5	2	RxD	Receive Data (to DTE)	
6	3	TxD	Transmit Data (from DTE)	
7	8	CTS ^b	Clear to Send	
8	7	RTS ^b	Read to Send	
1	9	RI ^c	Ring Indicator	

^a The DSR, DCD and DTR pins are connected together internally.

^b The CTS and RTS pins are connected together internally.

^c RI is not connected.

Communication Ports

Connect any of the available Ethernet ports on the device to a management switch and access the ROS console and Web interfaces via the device's IP address. For more information about available ports, refer to [Chapter 3, Communication Ports](#).

Section 2.6

Cabling Recommendations

Before connecting the device, be aware of the recommendations and considerations outlined in the following sections:

- [Section 2.6.1, "Protection On Twisted-Pair Data Ports"](#)
- [Section 2.6.2, "Gigabit Ethernet 1000Base-TX Cabling Recommendations"](#)

Section 2.6.1

Protection On Twisted-Pair Data Ports

Siemens does not recommend the use of copper cabling of any length for critical, real-time substation automation applications. All copper Ethernet ports on RUGGEDCOM products include transient suppression circuitry to protect against damage from electrical transients and conform with IEC 61850-3 and IEEE 1613 Class 1 standards. This means that during a transient electrical event, communications errors or interruptions may occur, but recovery is automatic.

Siemens also does not recommend using copper Ethernet ports to interface with devices in the field across distances that could produce high levels of ground potential rise (i.e. greater than 2500 V), during line-to-ground fault conditions.

Section 2.6.2

Gigabit Ethernet 1000Base-TX Cabling Recommendations

The IEEE 802.3ab Gigabit Ethernet standard defines 1000 Mbit/s Ethernet communications over distances of up to 100 m (328 ft) using all 4 pairs in category 5 (or higher) balanced, unshielded twisted-pair cabling. For wiring guidelines, system designers and integrators should refer to the Telecommunications Industry Association (TIA) TIA/EIA-568-A wiring standard that characterizes minimum cabling performance specifications required for proper Gigabit Ethernet operation. For reliable, error-free data communication, new and pre-existing communication paths should be verified for TIA/EIA-568-A compliance.

The following table summarizes the relevant cabling standards:

Cabling Category	1000Base-TX Compliant	Required Action
< 5	No	New wiring infrastructure required.
5	Yes	Verify TIA/EIA-568-A compliance.
5e	Yes	No action required. New installations should be designed with Category 5e or higher.
6	Yes	No action required.
> 6	Yes	Connector and wiring standards to be determined.

Follow these recommendations for copper data cabling in high electrical noise environments:

- Data cable lengths should be as short as possible, preferably 3 m (10 ft) in length. Copper data cables should not be used for inter-building communications.
- Power and data cables should not be run in parallel for long distances, and should be installed in separate conduits. Power and data cables should intersect at 90° angles when necessary to reduce inductive coupling.
- Shielded/screened cabling can be used when required. Care should be taken to avoid the creation of ground loops with shielded cabling.

3 Communication Ports

The RUGGEDCOM RSG2100 can be equipped with various types of communication ports to enhance its abilities and performance.

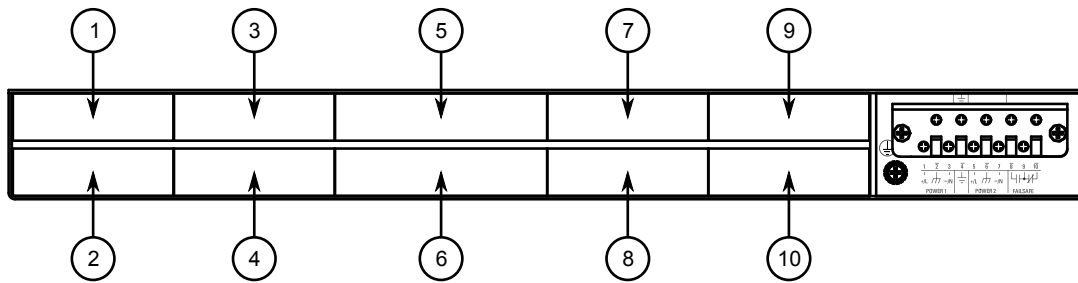

Figure 15: Port Assignment

Each type of module has a specific location in the RUGGEDCOM RSG2100 chassis:

- Slots 1 to 4 support any combination of fixed fiber or copper Ethernet connectors up to 100 Mbps
- Slot 5 supports a pair of fixed 1 Gbps ports
- Slot 6 supports a single expansion port of any type
- Slots 7 to 10 support any combination of two-port fiber or copper Ethernet modules

The exact configuration of the device can be determined by reading the factory data file through the ROS user interface. For more information about how to read the factory data file, refer to the *ROS User Guide* for the RUGGEDCOM RSG2100.

Each communication port is equipped with an LED that indicates the link/activity state of the port.

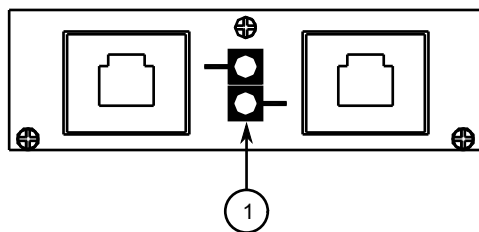

Figure 16: Port LEDs

1. Port LED

LED State	Description
Green (Solid)	Link established
Green (Blinking)	Link activity
Off	No link detected

The following sections describe the available communication ports:

- [Section 3.1, “Copper Ethernet Ports”](#)
- [Section 3.2, “Fiber Optic Ethernet Ports”](#)
- [Section 3.3, “SFP Optic Ethernet Ports”](#)

- Section 3.4, “GBIC Optic Ethernet Ports”

Section 3.1

Copper Ethernet Ports

The RUGGEDCOM RSG2100 supports several 10/100/1000Base-TX Ethernet ports that allow connection to standard Category 5 (CAT-5) unshielded twisted-pair (UTP) cables with either RJ45 or Micro-D male connectors. The RJ45 and Micro-D connectors are directly connected to the chassis ground on the device and can accept CAT-5 shielded twisted-pair (STP) cables.



WARNING!

Electric shock hazard – risk of serious personal injury and/or equipment interference. If shielded cables are used, make sure the shielded cables do not form a ground loop via the shield wire and the RJ45 receptacles at either end. Ground loops can cause excessive noise and interference, but more importantly, create a potential shock hazard that can result in serious injury.

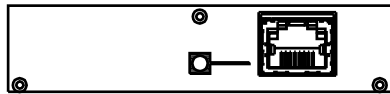

Figure 17: 1 x 10/100/1000Tx with RJ45 Ports (1CG01)

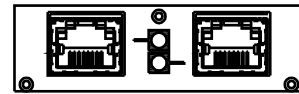

Figure 18: 2 x 10/100/1000Tx with RJ45 Ports (CG01)

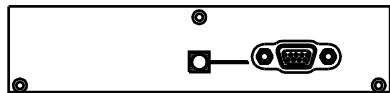

Figure 19: 1 x 10/100/1000Tx with Micro-D Ports (1CG02)

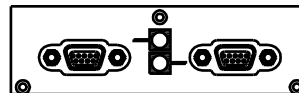

Figure 20: 2 x 10/100/1000Tx with Micro-D Ports (CG02)

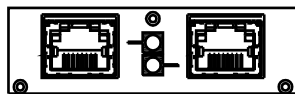

Figure 21: 2 x 10/100Tx with RJ45 Ports (TX01)

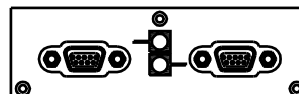

Figure 22: 2 x 10/100Tx with Micro-D Ports (TX02)

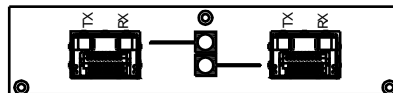
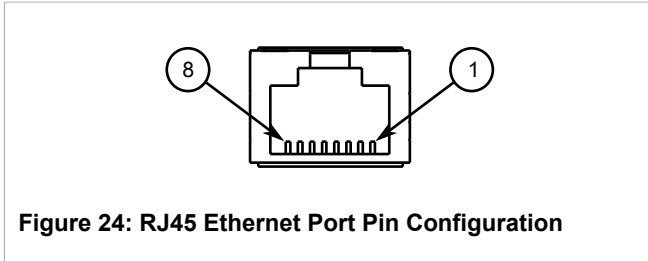

Figure 23: 2x 1000Tx SFP with RJ45 Ports (CG55)

Each port features an LED that indicates the state of the port.

State	Description
Yellow (Solid)	Link established
Yellow (Blinking)	Link activity
Off	No link detected

The following are the pin-out descriptions for the RJ45 and Micro-D connectors:



Pin	Name		Description
	10/100Base-TX	1000Base-TX	
1	RX+	BI_DB+	Receive Data+ or Bi-Directional
2	RX-	BI_DB-	Receive Data- or Bi-Directional
3	TX+	BI_DA+	Transmit Data+ or Bi-Directional
4	Reserved (Do Not Connect)		
5	Reserved (Do Not Connect)		
6	TX-	BI_DA-	Transmit Data- or Bi-Directional
7	Reserved (Do Not Connect)		
8	Reserved (Do Not Connect)		

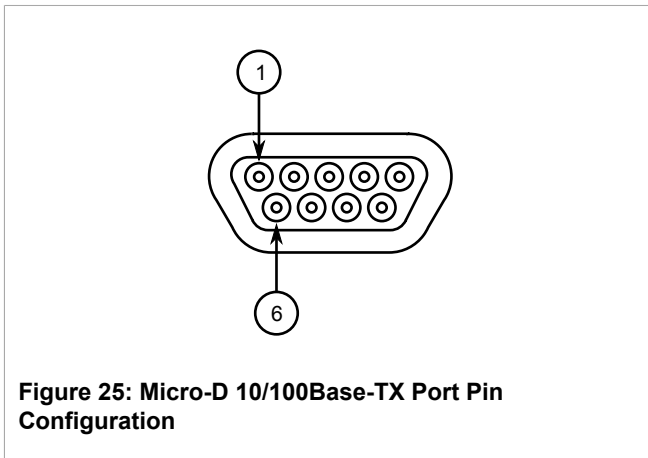

Pin	10/100Base-TX	1000Base-TX
1	RX+	A+
2	Reserved (Do Not Connect)	C+
3	Reserved (Do Not Connect)	
4	Reserved (Do Not Connect)	D+
5	TX+	B+
6	RX-	A-
7	Reserved (Do Not Connect)	C-
8	Reserved (Do Not Connect)	D-
9	TX-	B-

For specifications on the available copper Ethernet ports, refer to [Section 4.4, “Copper Ethernet Port Specifications”](#).

Section 3.2

Fiber Optic Ethernet Ports

Fiber optic Ethernet ports are available with either MTRJ (Mechanical Transfer Registered Jack), LC (Lucent Connector), SC (Standard or Subscriber Connector) or ST (Straight Tip) connectors. Make sure the Transmit (Tx) and Receive (Rx) connections of each port are properly connected and matched to establish a proper link.

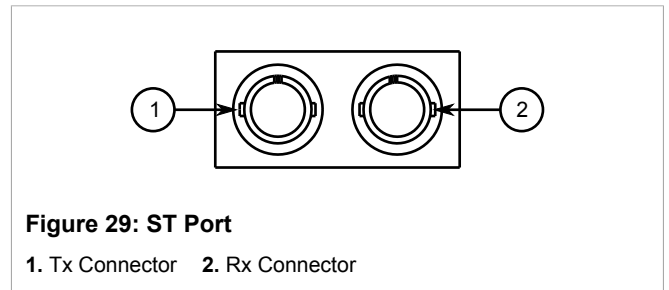
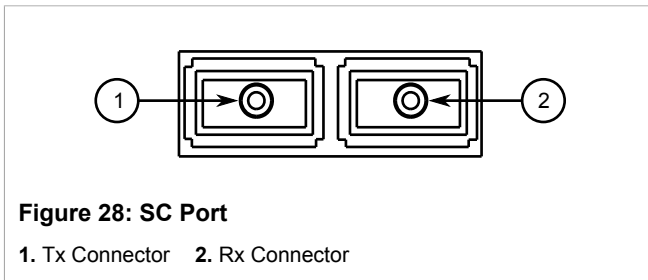
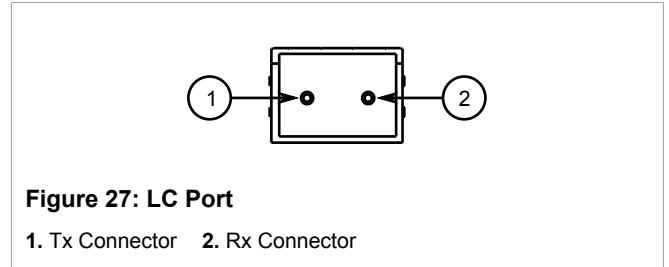
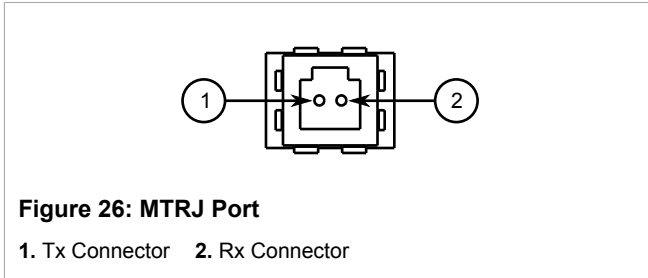

For specifications on the available fiber optic Ethernet ports, refer to [Section 4.5, “Fiber Optic Ethernet Port Specifications”](#).

Section 3.3

SFP Optic Ethernet Ports

SFP (Small Form-Factor Pluggable) optic Ethernet ports are available with LC (Lucent Connector) connectors. Make sure the Transmit (Tx) and Receive (Rx) connections of each port are properly connected and matched to establish a proper link.

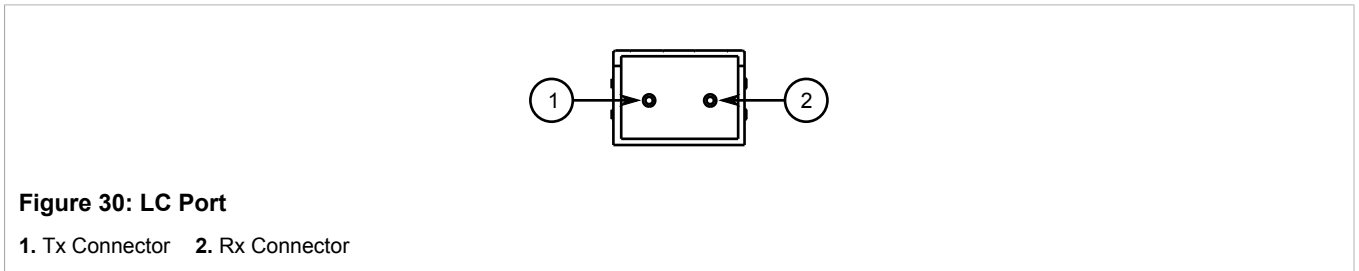

NOTE
SFP modules, as well as their optical ports, can be safely inserted and removed while the chassis is powered and operating.

The following sections describe how to install and remove SFP optical ports:

- [Section 3.3.1, “Installing an SFP Optical Port”](#)
- [Section 3.3.2, “Removing an SFP Optical Port”](#)

Section 3.3.1

Installing an SFP Optical Port

To install an SFP optical port, do the following:



CAUTION!

Electrical hazard – risk of damage to equipment. Use only components certified by Siemens with RUGGEDCOM products. Damage to the module and device may occur if compatibility and reliability have not been properly assessed.



CAUTION!

Electrical hazard – risk of damage to equipment. Make sure all electrostatic energy is dissipated before installing or removing components from the device. An electrostatic discharge (ESD) can cause serious damage to the component once it is outside the chassis.

1. Make sure all potential electrostatic build-up has been properly discharged to prevent electrostatic discharges (ESD). This can be accomplished by wearing an ESD wrist strap or by touching Earth or the chassis ground.
2. Remove the dust cover from the port opening in the module.



CAUTION!

Mechanical hazard – risk of component damage. SFP optical ports are designed to insert in only one orientation. Do not force the port into the module.

3. Remove the port from its packaging.
4. Insert the port into the module and swing the bail-latch up to lock it in place.

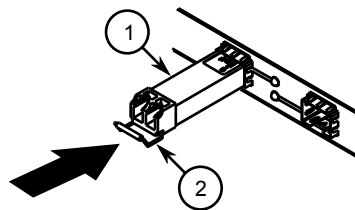

Figure 31: Installing an SFP Optical Port (Typical)

1. SFP Optical Port 2. Metal Bail-Latch

5. Remove the dust cover from the port.
6. Connect a cable to the port and test the connection.

Section 3.3.2

Removing an SFP Optical Port

To remove an SFP optical port, do the following:



CAUTION!

Electrical hazard – risk of damage to equipment. Make sure all electrostatic energy is dissipated before performing installing or removing components from the device. An electrostatic discharge (ESD) can cause serious damage to the component once it is outside the chassis.

1. Make sure all potential electrostatic build-up has been properly discharged to prevent electrostatic discharges (ESD). This can be accomplished by wearing an ESD wrist strap or by touching Earth or the chassis ground.
2. Disconnect the cable from the port.
3. Swing the metal bail-latch down and pull the port from the module.

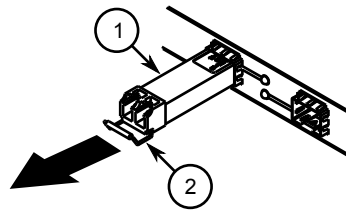

Figure 32: Removing an SFP Optical Port (Typical)

1. SFP Optical Port 2. Metal Bail-Latch

4. Store the port in an ESD-safe bag or other suitable ESD-safe environment, free from moisture and stored at the proper temperature (-40 to 85 °C or -40 to 185 °F).
5. Insert a plug in the empty port opening to prevent the ingress of dust and dirt.

Section 3.4

GBIC Optic Ethernet Ports

GBIC (Gigabit Interface Converter) optic Ethernet ports are available with SC (Standard or Subscriber Connector) connectors.

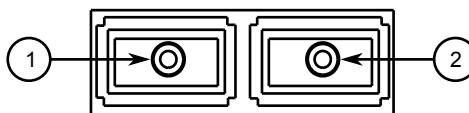

Figure 33: SC Port

1. Tx Connector 2. Rx Connector

The following sections describe how to install and remove GBIC optical ports:

- [Section 3.4.1, “Installing a GBIC Optical Port”](#)

- [Section 3.4.2, “Removing a GBIC Optical Port”](#)

Section 3.4.1

Installing a GBIC Optical Port

To install a GBIC optical port, do the following:



CAUTION!

Electrical hazard – risk of damage to equipment. Use only components certified by Siemens with RUGGEDCOM products. Damage to the module and device may occur if compatibility and reliability have not been properly assessed.



CAUTION!

Electrical hazard – risk of damage to equipment. Make sure all electrostatic energy is dissipated before installing or removing components from the device. An electrostatic discharge (ESD) can cause serious damage to the component once it is outside the chassis.

1. Make sure all potential electrostatic build-up has been properly discharged to prevent electrostatic discharges (ESD). This can be accomplished by wearing an ESD wrist strap or by touching Earth or the chassis ground.
2. Remove the dust cover from the port opening in the module.



CAUTION!

Mechanical hazard – risk of component damage. GBIC optical ports are designed to insert in only one orientation. Do not force the port into the module.

3. Remove the port from its packaging.
4. Squeeze the latches on either side of the port and insert the port into the module.

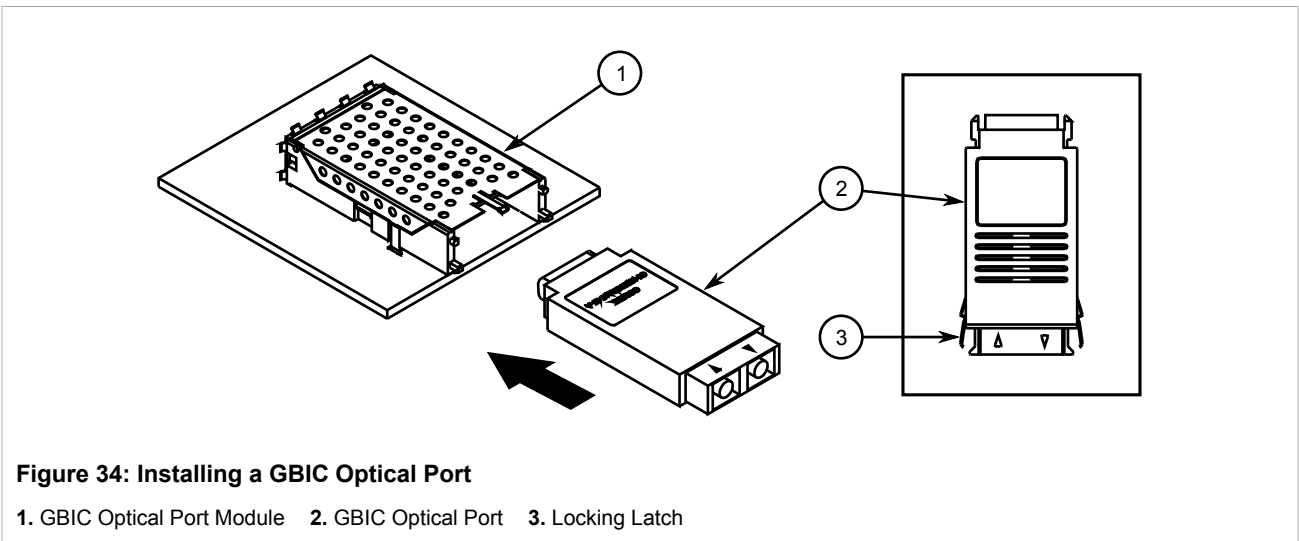

5. Release the latches and make sure the module is locked in place.
6. Remove the dust cover from the port.
7. Connect a cable to the port and test the connection.

Section 3.4.2

Removing a GBIC Optical Port

To remove an GBIC optical port, do the following:



CAUTION!

Electrical hazard – risk of damage to equipment. Make sure all electrostatic energy is dissipated before performing installing or removing components from the device. An electrostatic discharge (ESD) can cause serious damage to the component once it is outside the chassis.

1. Make sure all potential electrostatic build-up has been properly discharged to prevent electrostatic discharges (ESD). This can be accomplished by wearing an ESD wrist strap or by touching Earth or the chassis ground.
2. Disconnect the cable from the port.
3. Squeeze the latches on either side of the port and pull it from the module.

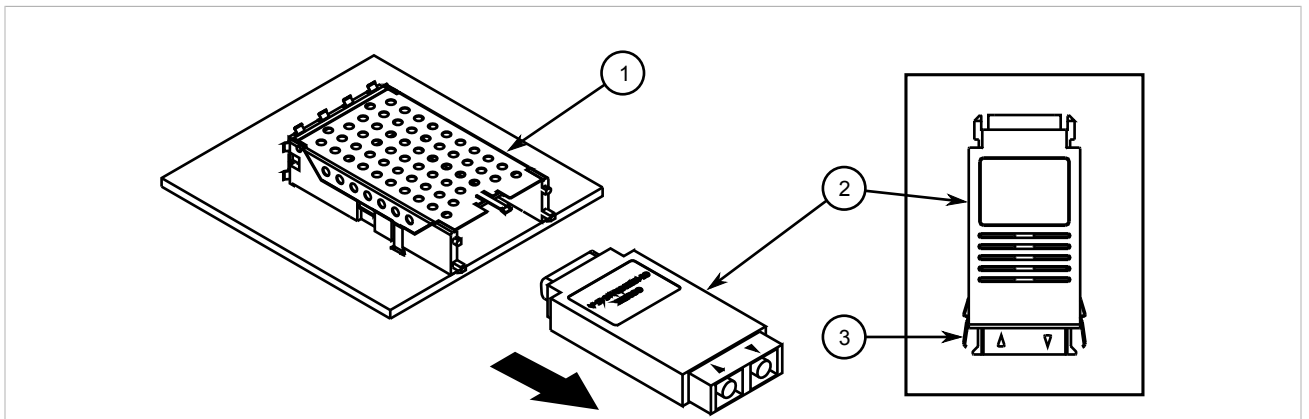

Figure 35: Removing a GBIC Optical Port

1. GBIC Optical Port Module 2. GBIC Optical Port 3. Locking Latch

4. Store the port in an ESD-safe bag or other suitable ESD-safe environment, free from moisture and stored at the proper temperature (-40 to 85 °C or -40 to 185 °F).
5. Insert a plug in the empty port opening to prevent the ingress of dust and dirt.

Section 3.5

BNC Ports

The following BNC ports are available on the PTP module:

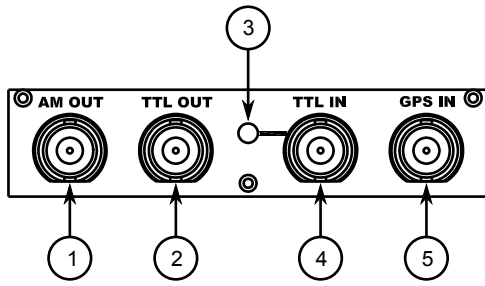

Figure 36: PTP Module

1. AM OUT Port 2. TTL OUT Port 3. Sync LED 4. TTL IN Port 5. GPS IN Port

Port	Function
AM IN	AM-level IRIG-B signal input, software enabled
TTL OUT	IRIG-B PWM or 1 PPS signal output, software selectable
TTL IN	TTL-level IRIG-B PWM signal input
GPS IN	GPS antenna input

Inputs are controlled by RUGGEDCOM ROS and only one can be active at any time. For information about activating an input, refer to the *RUGGEDCOM ROS User Guide* for the RUGGEDCOM RSG2100.

The color of the **Sync** LED on the front panel of the PTP module indicates the status of the incoming timing signal:

- **Green** – Signal locked
- **Amber/Yellow** – Holdover (GPS lock has been achieved, but the receiver no longer sees the minimum number of required satellites)
- **Red** – Error
- **Off** – No signal detected

4 Technical Specifications

The following sections provide important technical specifications related to the device and available modules:

- [Section 4.1, “Power Supply Specifications”](#)
- [Section 4.2, “Failsafe Relay Specifications”](#)
- [Section 4.3, “Supported Networking Standards”](#)
- [Section 4.4, “Copper Ethernet Port Specifications”](#)
- [Section 4.5, “Fiber Optic Ethernet Port Specifications”](#)
- [Section 4.6, “Operating Environment”](#)
- [Section 4.7, “Mechanical Specifications”](#)

Section 4.1

Power Supply Specifications

Power Supply Type	Input Range		Internal Fuse Rating ^{ab}	Maximum Power Consumption ^c
	Minimum	Maximum		
24 VDC	10 VDC	36 VDC	6.3 A(F)	28 W
48 VDC	36 VDC	72 VDC	3.15 A(T)	
HI (125/250 VDC) ^d	88 VDC	300 VDC	2 A(T)	
HI (110/230 VAC) ^d	85 VAC	264 VAC	2 A(T)	

^a (F) denotes fast-acting fuse

^b (T) denotes time-delay fuse.

^c Power consumption varies based on configuration. 10/100Base-TX ports consume roughly 1 W less than fiber optic ports.

^d The HI power supply is the same power supply for both AC and DC.

Section 4.2

Failsafe Relay Specifications

Parameter	Value (Resistive Load)
Max Switching Voltage	240 VAC, 125 VDC
Rated Switching Current	2 A @ 240 VAC, 0.15 A @ 125 VDC, 2 A @ 30 VDC
Maximum Switching Capacity	150 W, 500 VA

Section 4.3

Supported Networking Standards

Standard	10 Mbps Ports	100 Mbps Ports	1000 Mbps Ports	Notes
IEEE 802.3	✓			10BaseT/10BaseFL
IEEE 802.3u		✓		100BaseTX/100BaseFX
IEEE 802.3x	✓	✓	✓	Flow Control
IEEE 802.3z			✓	1000BaseLX
IEEE 802.3ab			✓	1000BaseTx
IEEE 802.3ad			✓	Link Aggregation
IEEE 802.1D	✓	✓	✓	MAC Bridges
IEEE 802.1D	✓	✓	✓	Spanning Tree Protocol (STP)
IEEE 802.1p	✓	✓	✓	Class of Service (CoS)
IEEE 802.1Q	✓	✓	✓	VLAN (Virtual LAN) Tagging
IEEE 802.1w	✓	✓	✓	Rapid Spanning Tree Protocol (RSTP)
IEEE 802.1x	✓	✓	✓	Port-Based Network Access Control
IEEE 802.1Q-2005 (formerly 802.1s)	✓	✓	✓	Multiple Spanning Tree Protocol (MSTP)

Section 4.4

Copper Ethernet Port Specifications

The following details the specifications for copper Ethernet ports that can be ordered with the RUGGEDCOM RSG2100.

Section 4.4.1

Copper Fast (10/100 Mbps) Ethernet Port Specifications

Connector	Duplex ^e	Cable Type ^f	Wiring Standard ^g	Maximum Distance ^h	Isolation ⁱ
RJ45	FDX/HDX	> CAT-5	TIA/EIA T568A/B	100 m (328 ft)	1.5 kV
micro-D	FDX/HDX	> CAT-5	TIA/EIA T568A/B	100 m (328 ft)	1.5 kV

^e Auto-Negotiating

^f Shielded or unshielded.

^g Auto-crossover and auto-polarity.

^h Typical distance. Dependent on the number of connectors and splices.

ⁱ RMS 1 minute.

Section 4.4.2

Copper Gigabit Ethernet (1 Gbps) Port Specifications



NOTE

- Maximum segment length is greatly dependent on factors such as fiber quality, and the number of patches and splices. Consult a Siemens sales associate when determining maximum segment distances.
- All optical power numbers are listed as dBm averages.
- F51 transceivers are rated for -40 to 85 °C (-40 to 185 °F).

Fixed Gigabit Transceivers

Connector	Duplex ^j	Cable Type ^k	Wiring Standard ^l	Maximum Distance ^m	Isolation ⁿ
RJ45	FDX/HDX	> CAT-5	TIA/EIA T568A/B	100 m (328 ft)	1.5 kV
micro-D	FDX/HDX	> CAT-5	TIA/EIA T568A/B	100 m (328 ft)	1.5 kV

^j Auto-Negotiating

^k Shielded or unshielded.

^l Auto-crossover and auto-polarity.

^m Typical distance. Dependent on the number of connectors and splices.

ⁿ RMS 1 minute.

SFP Gigabit Transceivers

Connector	Duplex ^o	Cable Type ^p	Wiring Standard ^q	Maximum Distance	Isolation ^r
RJ45	FDX/HDX	> CAT-5	TIA/EIA T568A/B	100 m (328 ft)	1.5 kV

^o Auto-Negotiating

^p Shielded or unshielded.

^q Auto-crossover and auto-polarity.

^r RMS 1 minute.

Section 4.5

Fiber Optic Ethernet Port Specifications

The following sections list specifications of the optical transceivers used in the modules available for the RUGGEDCOM RSG2100:

- [Section 4.5.1, “10FL Ethernet Optical Specifications”](#)
- [Section 4.5.2, “Fast Ethernet \(10/100 Mbps\) Optical Specifications”](#)
- [Section 4.5.3, “Gigabit Ethernet \(1 Gbps\) Optical Specifications”](#)

Section 4.5.1

10FL Ethernet Optical Specifications

Mode	Connector Type	Cable Type (µm)	Tx λ (nm) ^s	Tx min (dBm)	Tx max (dBm)	Rx Sensitivity (dBm)	Rx Saturation (dBm)	Distance (typ.) (km)	Power Budget (dB)
MM	ST	62.5/125	850	-16	-9	-34	-11.2	2	18
		50/125		-19.8	-12.8				14.2

^s Typical.

Section 4.5.2

Fast Ethernet (10/100 Mbps) Optical Specifications

Mode	Connector Type	Cable Type (µm)	Tx λ (nm) ^t	Tx min. (dBm)	Tx max. (dBm)	Rx Sensitivity (dBm)	Rx Saturation (dBm)	Maximum Distance (km) ^u	Power Budget (dB)
MM	ST	62.5/125	1300	-19	-14	-31	-14	2	12
		50/125		-22.5					8.5
MM	SC	62.5/125	1300	-19	-14	-31	-14	2	12
		50/125		-22.5					8.5
MM	MTRJ	62.5/125	1300	-19	-14	-31	-14	2	12
		50/125		-22.5					8.5
SM	ST	9/125	1310	-15	-8	-32	-3	20	17
SM	SC	9/125	1310	-15	-8	-31	-7	20	16
SM	LC	9/125	1310	-15	-8	-34	-7	20	19
SM	SC	9/125	1310	-5	0	-34	-3	50	29
SM	LC	9/125	1310	-5	0	-35	3	50	30
SM	SC	9/125	1310	0	5	-37	0	90	37
SM	LC	9/125	1310	0	5	-37	0	90	37
MM	LC	62.5/125	1300	-19	-14	-32	-14	2	13

^t Typical.

^u Typical distance. Dependent on the cable type, number of connectors and number of splices.

Section 4.5.3

Gigabit Ethernet (1 Gbps) Optical Specifications

Fixed Gigabit Transceivers



NOTE

These transceivers utilize a distributed feedback (DFB) type laser and are rated for -20 to 85 °C (-4 to 185 °F) operation only.

Mode	Connector Type	Cable Type (µm) ^v	Tx λ (nm) ^w	Tx Minimum (dBm) ^x	Tx Maximum (dBm) ^x	Rx Sensitivity (dBm) ^x	Rx Saturation (dBm) ^x	Maximum Distance (km) ^y	Power Budget (dB)
MM	LC	50/125	850	-9	-2.5	-20	0	0.5	11
		62.5/125							
SM	SC	9/125	1310	-10	-3	-20	-3	10	10
SM	LC	9/125	1310	-9.5	-3	-21	-3	10	11.5
SM	SC	9/125	1310	-5	0	-20	-3	25	15
SM	LC	9/125	1310	-7	-3	-24	-3	25	17

^v All cabling is duplex type unless specified otherwise.

^w Typical.

^x All optical power numbers are listed as dBm averages.

^y Typical distance. The maximum segment length is greatly dependent on factors such as fiber quality, and the number of patches and splices. Consult a Siemens sales associates when determining maximum segment distances.

SFP Gigabit Transceivers



NOTE

SFP transceivers have a temperature range of -40 to 85 °C (-40 to 185 °F), unless specified otherwise.

Mode	Connector Type	Cable Type (µm)	Tx λ (nm) ^z	Tx Minimum (dBm) ^{aa}	Tx Maximum (dBm) ^{aa}	Rx Sensitivity (dBm) ^{aa}	Rx Saturation (dBm) ^{aa}	Maximum Distance (km) ^{ab}	Power Budget (dB)
MM	LC	50/125	850	-9	-2.5	-20	0	0.5	11
		62.5/125						0.3	
SM	LC	9/125	1310	-9.5	-3	-19	-3	10	9.5
SM	LC	9/125	1310	-7	-3	-23	-3	25	16
SM ^{ac}	LC	9/125	1550	0	5	-23	-3	70	23

^z Typical.

^{aa}All optical power numbers are listed as dBm averages.

^{ab}Typical distance. The maximum segment length is greatly dependent on factors such as fiber quality, and the number of patches and splices. Consult a Siemens sales associates when determining maximum segment distances.

^{ac}Operating temperature range of -20 to 85 °C (-4 to 185 °F).

GBIC Gigabit Transceivers



NOTE

GBIC transceivers have a temperature range of -40 to 85 °C (-40 to 185 °F), unless specified otherwise.

Mode	Connector Type	Cable Type (µm)	Tx λ (nm) ^{ad}	Tx Minimum (dBm) ^{ae}	Tx Maximum (dBm) ^{ae}	Rx Sensitivity (dBm) ^{ae}	Rx Saturation (dBm) ^{ae}	Maximum Distance (km) ^{af}	Power Budget (dB)
SM	SC	9/125	1310	-9.5	-3	-21	-3	10	11.5
SM	SC	9/125	1310	-7	-3	-24	-3	25	17
SM ^{ag}	SC	9/125	1550	0	5	-23	-3	70	23

^{ad}Typical.

^{ae}All optical power numbers are listed as dBm averages.

^{af}Typical distance. The maximum segment length is greatly dependent on factors such as fiber quality, and the number of patches and splices. Consult a Siemens sales associates when determining maximum segment distances.

^{ag}Operating temperature range of -20 to 85 °C (-4 to 185 °F).

Section 4.6

Operating Environment

Parameter	Range	Comments
Ambient Operating Temperature	-40 to 85 °C (-40 to 185 °F)	Ambient Temperature as measured from a 30 cm radius surrounding the center of the enclosure.
Ambient Relative Humidity	5% to 95%	Non-condensing
Ambient Storage Temperature	-40 to 85 °C (-40 to 185 °F)	

Section 4.7

Mechanical Specifications

Parameter	Value
Dimensions	Refer to Chapter 5, Dimension Drawings
Weight	5.2 kg (11.5 lbs)
Ingress Protection	IP40 (1 mm or 0.04 in objects)
Enclosure	18 AWG Galvanized Steel

5 Dimension Drawings



NOTE
All dimensions are in millimeters, unless otherwise stated.



NOTE
Dimensional tolerances are in accordance with ISO 2768-mK, unless otherwise stated.

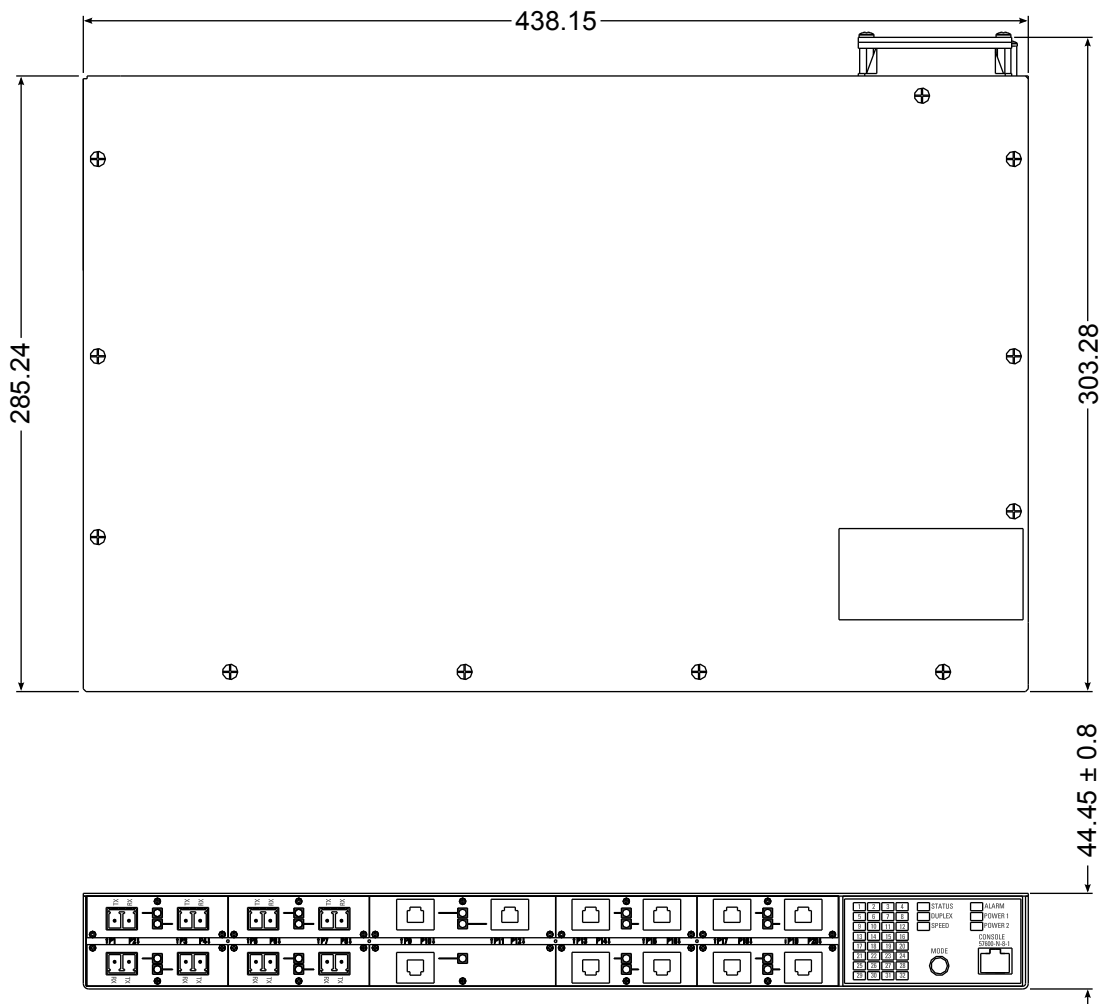

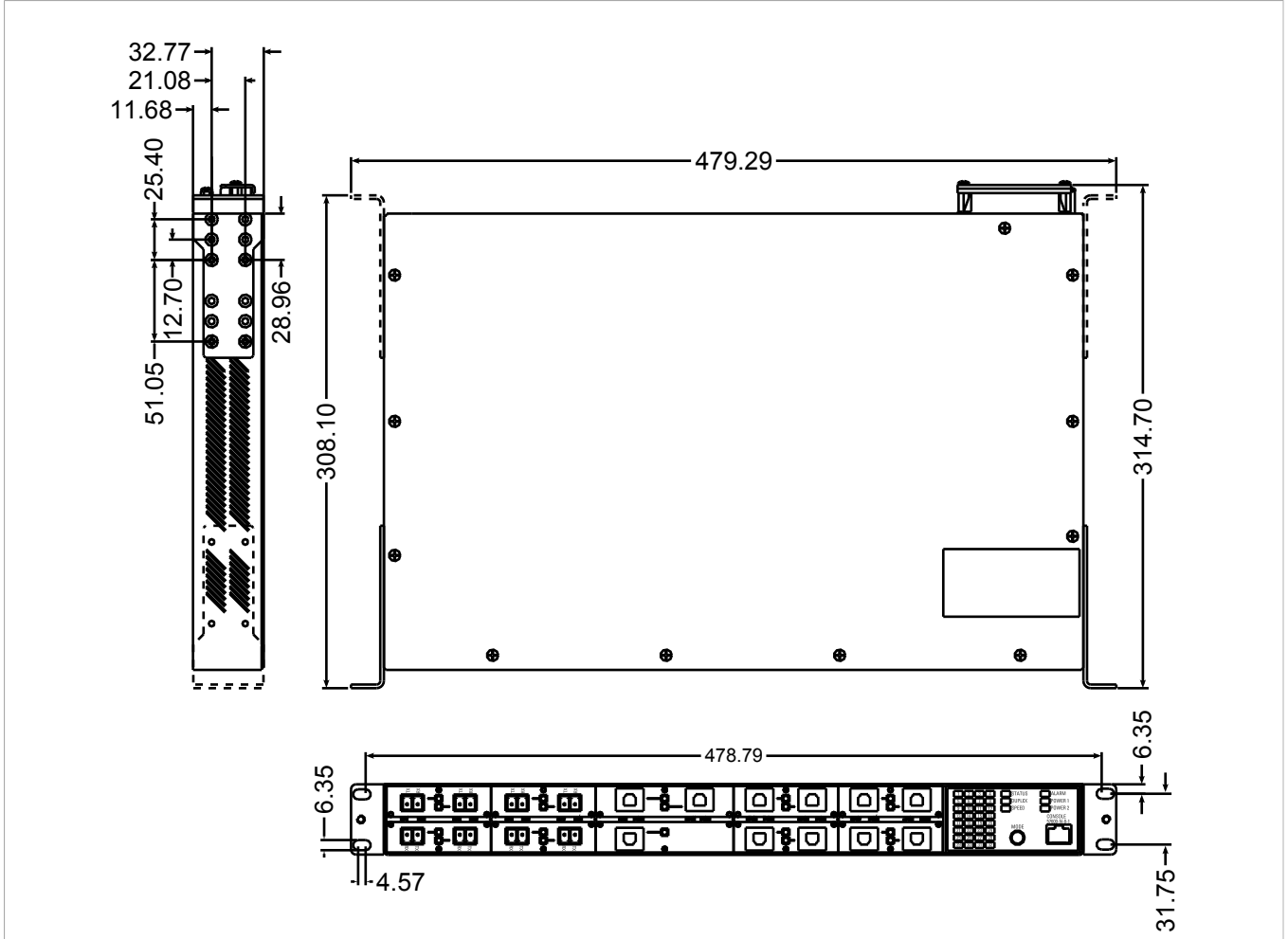

Figure 38: Rack Mount Dimensions

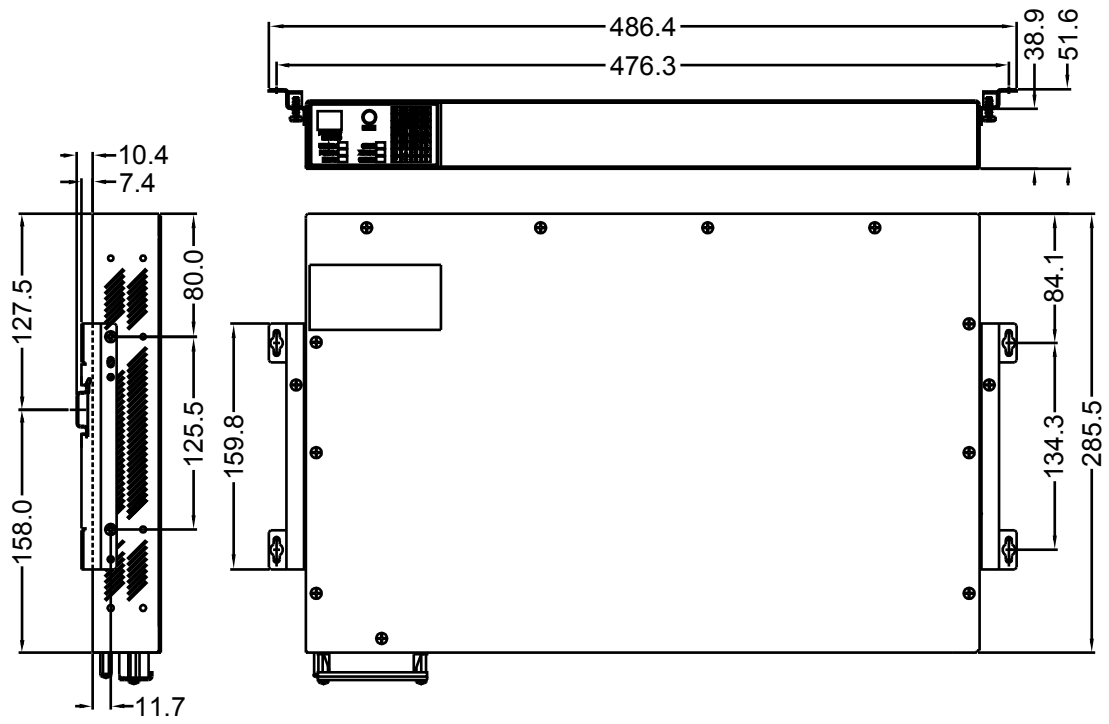

Figure 39: Panel and DIN Rail Mount Dimensions

6 Certification

The RUGGEDCOM RSG2100 device has been thoroughly tested to guarantee its conformance with recognized standards and has received approval from recognized regulatory agencies.

- [Section 6.1, “Standards Compliance”](#)
- [Section 6.2, “Agency Approvals”](#)
- [Section 6.3, “EMI and Environmental Type Tests”](#)

Section 6.1

Standards Compliance

The RUGGEDCOM RSG2100 complies with the following standards:

- **FCC Compliance**

This equipment has been tested and found to comply with the limits for a Class A digital device pursuant to Part 15 of the FCC Rules. These limits are designed to provide reasonable protection against harmful interference when the equipment is operated in a commercial environment.

This equipment generates, uses and can radiate radio frequency energy and, if not installed and used in accordance with the instruction manual, may cause harmful interference to radio communications. Operation of this equipment in a residential area is likely to cause harmful interference in which case the user will be required to correct the interference on his own expense.

- **Industry Canada Compliance**

CAN ICES-3 (A) / NMB-3 (A)

- **Other**

- IEC 61000-6-2 (Generic Industrial)
- NEMA TS-2 (Traffic Control Equipment)
- IEEE 1613 (Electric Utility Substations)
- IEC 61850-3 (Electric Utility Substations)
- EN 50121-4 (Railway Equipment)

Section 6.2

Agency Approvals

Agency	Standards	Comments
CSA	CSA C22.2 No. 60950-1, UL 60950-1	Approved
CE	EN 60950-1, EN 61000-6-2, EN 60825-1, EN 55022 Class A, EN 50581	Approved
FCC	FCC Part 15, Class A	Approved

Agency	Standards	Comments
FDA/CDRH	21 CFR Chapter I, Sub-chapter J	Approved
ISO	ISO9001:2008	Designed and manufactured using an ISO9001:2008 certified quality program

Section 6.3

EMI and Environmental Type Tests

The RUGGEDCOM RSG2100 has passed the following EMI and environmental tests.

IEC 61850-3 EMI Type Tests



NOTE

- In the case of an all fiber port configuration, this product meets all Class 2 requirements. Otherwise, all Class 1 requirements are met for copper ports.
- If the unit contains copper ports, the IEC 1613 conformance is Class 1, during which disturbance errors may occur but recovery is automatic.
- If the unit contains all fiber ports, the IEC 1613 conformance is Class 2, during which no disturbance errors will occur.

Test	Description		Test Levels	Severity Levels
IEC 61000-4-2	ESD	Enclosure Contact	+/- 8 kV	4
		Enclosure Air	+/- 15 kV	
IEC 61000-4-3	Radiated RFI	Enclosure Ports	20 V/m	Note ^a
IEC 61000-4-4	Burst (Fast Transient)	Signal Ports	+/- 4 kV @ 2.5 kHz	Note ^a
		DC Power Ports	+/- 4 kV	4
		AC Power Ports		
		Earth Ground Ports		
IEC 61000-4-5	Surge	Signal Ports	+/- 4 kV Line-to-Earth, +/- 2 kV Line-to-Line	4
		DC Power Ports	+/- 2 kV Line-to-Earth, +/- 1 kV Line-to-Line	3
		AC Power Ports	+/- 4 kV Line-to-Earth, +/- 2 kV Line-to-Line	4
IEC 61000-4-6	Induced (Conducted) RFI	Signal Ports	10 V	3
		DC Power Ports		
		AC Power Ports		
		Earth Ground Ports		
IEC 61000-4-8	Magnetic Field	Enclosure Ports	40 A/m, continuous, 1000 A/m for 1 s	Note ^a
			1000 A/m for 1 s	5

Test	Description		Test Levels	Severity Levels
IEC 61000-4-29	Voltage Dips and Interrupts (DC Power Ports)	DC Power Ports	30% for 0.1 s 60% for 0.1 s 100% for 0.05 s	
		AC Power Ports	30% for 1 period 60% for 50 periods	
IEC 61000-4-11	Voltage Dips and Interrupts (A. C. Power Ports)	AC Power Ports	100% for 5 periods 100% for 50 periods	
IEC 61000-4-12	Damped Oscillatory	Signal Ports	2.5 kV Common, 1 kV Differential Mode @1 MHz	3
		DC Power Ports		
		AC Power Ports		
IEC 61000-4-16	Mains Frequency Voltage	Signal Ports	30 V Continuous, 300 V for 1s	4
		DC Power Ports		
IEC 61000-4-17	Ripple on DC Power Supply	DC Power Ports	10%	3
IEC 60255-5	Dielectric Strength	Signal Ports	2 kVAC (Fail-Safe Relay Output)	
		DC Power Ports	2 kVAC	
		AC Power Ports	2 kVAC	
	HV Impulse	Signal Ports	5 kV (Fail-Safe Relay Output)	
		DC Power Ports	5 kV	
		AC Power Ports		

^a Siemens-specified severity levels

IEEE 1613 EMI Immunity Type Tests



NOTE

The RUGGEDCOM RSG2100 meets Class 2 requirements for an all-fiber configuration and Class 1 requirements for copper ports.

Description		Test Levels
ESD	Enclosure Contact	+/- 2 kV, +/-4 kV, +/-8 kV
	Enclosure Air	+/-4 kV, +/-8 kV, +/-15 kV
Radiated RFI	Enclosure Ports	35 V/m
Fast Transient	Signal Ports	+/- 4 kV @ 2.5 kHz
	DC Power Ports	+/- 4 kV
	AC Power Ports	+/- 4 kV
	Earth Ground Ports	+/- 4 kV
Oscillatory	Signal Ports	2.5 kV Common Mode @1MHz

Description		Test Levels
	DC Power Ports	2.5 kV common, 1 kV differential mode @ 1 MHz
	AC Power Ports	2.5 kV common, 1 kV differential mode @ 1 MHz
HV Impulse	Signal Ports	5 kV (Fail-Safe Relay Output)
	DC Power Ports	5 kV
	AC Power Ports	5 kV
Dielectric Strength	Signal Ports	2 kVAC
	DC Power Ports	2 kVDC
	AC Power Ports	2 kVAC
Damped Oscillatory Magnetic Field	Enclosure Ports	100 A/m Peak

Environmental Type Tests

Test	Description		Test Levels
IEC 60068-2-1	Cold Temperature	Test Ad	-40 °C (-40 °F), 16 Hours
IEC 60068-2-2	Dry Heat	Test Bd	85 °C (185 °F), 16 Hours
IEC 60068-2-30	Humidity (Damp Heat, Cyclic)	Test Db	95% (non-condensing), 55 °C (131 °F), 6 cycles
IEC 60068-21-1	Vibration		2g @ 10-50 Hz
IEC 60068-21-2	Shock		30 g @ 11 ms