

SIEMENS

SIMATIC

Windows Automation Center WinAC RTX 3.1 Overview

Manual

Preface, Contents	
Product Overview	1
Installing the Components of WinAC RTX	2
Getting Started with WinAC RTX	3
Using the Toolmanager	4
Appendices	
Distributed Component Object Model (DCOM)	A
OLE for Process Control (OPC)	B
Index	

Safety Guidelines

This manual contains notices which you should observe to ensure your own personal safety, as well as to protect the product and connected equipment. These notices are highlighted in the manual by a warning triangle and are marked as follows according to the level of danger:



Danger

indicates an imminently hazardous situation which, if not avoided, will result in death or serious injury.



Warning

indicates a potentially hazardous situation which, if not avoided, could result in death or serious injury.



Caution

used with the safety alert symbol indicates a potentially hazardous situation which, if not avoided, may result in minor or moderate injury.

Caution

used without the safety alert symbol indicates a potentially hazardous situation which, if not avoided, may result in property damage.

Notice

NOTICE used without the safety alert symbol indicates a potential situation which, if not avoided, may result in an undesirable result or state.

Qualified Personnel

Only **qualified personnel** should be allowed to install and work on this equipment. Qualified persons are defined as persons who are authorized to commission, to ground, and to tag circuits, equipment, and systems in accordance with established safety practices and standards.

Correct Usage

Note the following:



Warning

This device and its components may only be used for the applications described in the catalog or the technical descriptions, and only in connection with devices or components from other manufacturers which have been approved or recommended by Siemens.

This product can only function correctly and safely if it is transported, stored, set up, and installed correctly, and operated and maintained as recommended.

Trademarks

SIMATIC®, SIMATIC HMI® and SIMATIC NET® are registered trademarks of SIEMENS AG.

Some of other designations used in these documents are also registered trademarks; the owner's rights may be violated if they are used by third parties for their own purposes.

Copyright © Siemens AG 2001 All rights reserved

The reproduction, transmission or use of this document or its contents is not permitted without express written authority. Offenders will be liable for damages. All rights, including rights created by patent grant or registration of a utility model or design, are reserved.

Siemens AG
Bereich Automatisierungs- und Antriebstechnik
Geschäftsgebiet Industrie-Automatisierungssysteme
Postfach 4848, D- 90327 Nuernberg

Siemens Aktiengesellschaft

Disclaimer of Liability

We have checked the contents of this manual for agreement with the hardware and software described. Since deviations cannot be precluded entirely, we cannot guarantee full agreement. However, the data in this manual are reviewed regularly and any necessary corrections included in subsequent editions. Suggestions for improvement are welcomed.

© Siemens AG 2001
Technical data subject to change.

A5E00083521



Preface

The Windows Automation Center Real-time (WinAC RTX) runs on Windows NT 4.0 PC systems. WinAC RTX provides real-time control of your automation process. The WinAC RTX software consists of the following products:

- Windows Logic Controller (WinLC) RTX
- VenturCom Real-time extensions (RTX) for Windows NT
- Computing software
- ToolManager

Note

For WinAC, the term “control engine” applies to a processor or program that manages and manipulates data which is used to control a process or machine. The control engine can be either software or hardware.

WinAC RTX provides WinLC RTX as its control engine. The ActiveX controls provided by SIMATIC Computing communicate with this control engine, as well as other SIMATIC controllers.

Audience

This manual is intended for engineers, programmers, and maintenance personnel who have a general knowledge of programmable logic controllers.

Scope of the Manual

This manual describes the features and the operation of version 3.1 of the WinAC RTX software.

How to Use This Manual

This manual provides the following information:

- Overview of the components of the WinAC RTX package
- Installing and authorizing the WinAC RTX software
- Getting started with the WinAC RTX software
- Using the Toolmanager

This manual also provides the following reference material:

- WinAC and DCOM (Microsoft’s Distributed Component Object Model)
- OPC (OLE for Process Control) connections

Other Manuals

For additional information, refer to the following manuals:

Title	Content
Windows Logic Controller Real-time (WinLC RTX) User Manual	This manual provides basic information about the performance characteristics and operation of the WinLC controller.
SIMATIC Computing User Manual	This manual describes the ActiveX controls of the SIMATIC Computing software.
OPC Server Interface Manual	This manual describes the browse-able OPC server interface provided with the Computing software.

You can also find information about the components of the WinAC in the online help for the software.

Additional Assistance

For assistance in answering technical questions, for training on this product, or for ordering, contact your Siemens distributor or sales office.

To contact Customer Service for Siemens in North America:

- Telephone:
 - (609) 734-6500
 - (609) 734-3530
- E-mail:
 - ISBU.Hotline@sea.siemens.com
 - simatic.hotline@sea.siemens.com
- Internet:
 - <http://www.sea.siemens.com/software>
 - <http://www4.ad.siemens.de/csinfo/livlink.exe?func=cslib.csinfo2&siteid=cs&lang=en>
 - http://www1.ad.siemens.de/meta/support/html_76/support.htm

To contact Customer Service for Siemens in Europe:

- Telephone: ++49 (0) 911 895 7000
- Fax: ++49 (0) 911 895 7001
- E-mail: simatic.support@nbgm.siemens.de
- Internet: <http://www1.ad.siemens.de/meta/index00.htm>

Contents

Preface

Contents

1	Product Overview	1-1
1.1	WinLC RTX controls your process	1-2
1.2	SIMATIC Computing provides access to the process data	1-4
1.3	Use SIMATIC Computing over a DCOM network	1-5
1.4	Tag files allow you to use symbols for the process data	1-6
1.5	Tag files allow you to access multiple control engines	1-7
1.6	Use OPC to connect third-party applications to SIMATIC Computing ...	1-8
1.7	Toolmanager provides shortcuts to your programs	1-9
2	Installing the Components of WinAC Basis RTX	2-1
2.1	System Requirements	2-2
2.2	Installing the WinAC RTX Software	2-3
2.3	Uninstalling the WinAC RTX Software	2-5
2.4	Authorizing the WinAC RTX Software	2-6
2.5	Special Notes for Installing the WinLC RTX Controller	2-8
2.6	Special Notes for Installing the CP 5613 Card	2-10
3	Getting Started with WinAC RTX	3-1
3.1	Using WinAC RTX with a Sample Program	3-2
3.2	Starting the WinLC RTX Controller	3-4
3.3	Downloading a Sample Program to WinLC RTX	3-5
3.4	Using the SoftContainer to Create a Process Form	3-13
3.5	Configuring the Connections for the Process Form	3-16
3.6	Configuring the Button Controls on the Process Form	3-21
3.7	Running the Process Form with the Sample Program	3-26
4	Using the Toolmanager	4-1
4.1	Creating a Toolbar for Easy Access to Your Programs	4-2
4.2	Using the Toolmanager without a Mouse	4-5
4.3	Changing the Language Setting for WinAC RTX	4-6

A	Distributed Component Object Model (DCOM)	A-1
A.1	Using DCOM to Expand the Capabilities of WinAC RTX	A-2
A.2	Connecting to a Specific Control Engine over DCOM	A-4
B	OLE for Process Control (OPC)	B-1
B.1	Using SIMATIC OPC with Computing	B-2
	Index	Index-1

Product Overview

1

Chapter Overview

Windows Automation Center Real-time (WinAC RTX) consists of the following products:

- Windows Logic Controller Real-time (WinLC RTX) software allows you to use your Windows NT 4.0 PC system like a programmable logic controller (PLC) for running your process. For improved deterministic behavior and isolation from NT failures, WinLC RTX executes a user program in the real-time subsystem.

WinLC RTX is a PC-based logic controller in the family of S7 controllers. This controller is fully compatible with the automation tools provided by the SIMATIC family of products, such as the STEP 7 programming software and the Windows Control Center (WinCC).

- The SIMATIC Computing software provides ActiveX controls, which you can use to create a tailored view into your process. Computing lets you use any mix of S7 and third-party ActiveX controls not only to view, but also to modify process data.
- The TagFile Configurator creates tag files that allow you to use symbols for the memory locations being accessed in the control engine. Tag files also allow you to access data in several control engines at the same time.

In addition to these products, WinAC provides a configuration tool to quickly change language, support legacy applications, and set up OPC communications. It includes a Toolmanager to provide quick access to software applications that you want to use with WinAC.

Section	Description	Page
1.1	WinLC RTX controls your process	1-2
1.2	SIMATIC Computing provides access to the process data	1-4
1.3	Use SIMATIC Computing over a DCOM network	1-5
1.4	Tag files allow you to use symbols for the process data	1-6
1.5	Tag files allow you to access multiple control engines	1-7
1.6	Use OPC to connect third-party applications to SIMATIC Computing	1-8
1.7	Toolmanager provides shortcuts to your programs	1-9

1.1 WinLC RTX controls your process

WinLC RTX provides a real-time, computer-based solution for your automation projects. WinLC RTX connects a PC-based controller over a PROFIBUS-DP network to the distributed (remote) I/O that in turn connect to the process or automation project.

As shown in Figure 1-1, you can use the SIMATIC Computing software to provide access to the process data. You can also use the standard SIMATIC products with WinLC RTX, such as STEP 7 and WinCC.

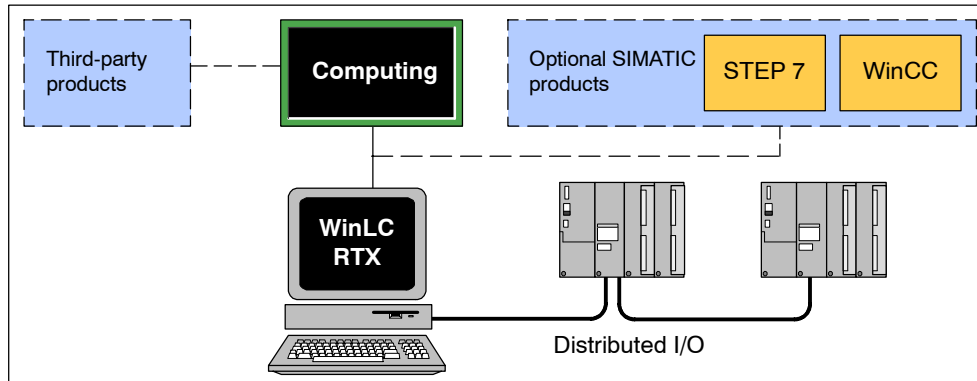

Figure 1-1 Components of WinAC RTX

The WinLC control panel (see Figure 1-2) provides the functions for changing the operating mode, for displaying the status of the controller, and for resetting the memory areas.

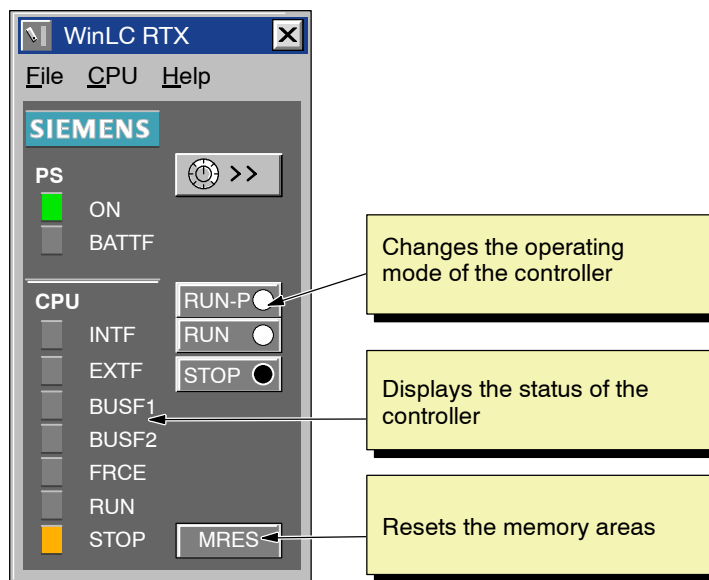

Figure 1-2 Control Panel of WinLC RTX

Understanding How WinLC RTX Operates if Windows NT Crashes

WinLC RTX supports OB84 (Host Operating System Failure), which allows you to initiate the shutdown of your process in case Windows NT detects an unrecoverable fault or STOP error while WinLC RTX is running. If WinLC RTX is still able to run after Windows NT has initiated the system shutdown procedure, one of the following events occur:

- If WinLC RTX is in RUN mode and the user program includes OB84, WinLC RTX starts OB84 and continues in RUN mode until the user program calls SFC46 (STP) to place the controller in STOP mode. After WinLC RTX transitions to STOP mode, Windows NT completes its system shutdown.
- If WinLC RTX is in RUN mode and the user program does not include OB84, WinLC RTX transitions to STOP mode and Windows NT completes its system shutdown.
- If WinLC RTX is in STOP mode or if the user program does not include OB84, Windows NT completes its system shutdown.
- If NT is configured to automatically reboot after a STOP error occurs, WinLC automatically restarts if it is configured to run as a service.

The following restrictions apply:

- The WinLC RTX control panel is unavailable.
- Communication with external systems (such as HMI devices or programming devices) may be unavailable.
- Some system functions may be disabled.
- Cycling the power to the computer initializes all of the program variables to their default values.

Note

When Windows NT crashes, the recommended procedure is to shut down the automation process and evaluate your system to determine what caused the operating system failure.

1.2 SIMATIC Computing provides access to the process data

As shown in Figure 1-3, the SIMATIC Computing software allows you to access WinLC RTX in order to monitor and modify the process data.

SIMATIC Computing provides several methods for accessing the process data:

- You can use included ActiveX controls (OCX) that access the process data.
- You can use DCOM (Microsoft's Distributed Component Object Model) to integrate distributed applications over a network. A distributed application consists of multiple processes or different computers that cooperate to accomplish a single task. (See Section 1.3.)
- You can use the OPC (OLE for Process Control) server, which allows any OPC client application to access data in the control device. (See Section 1.6.)

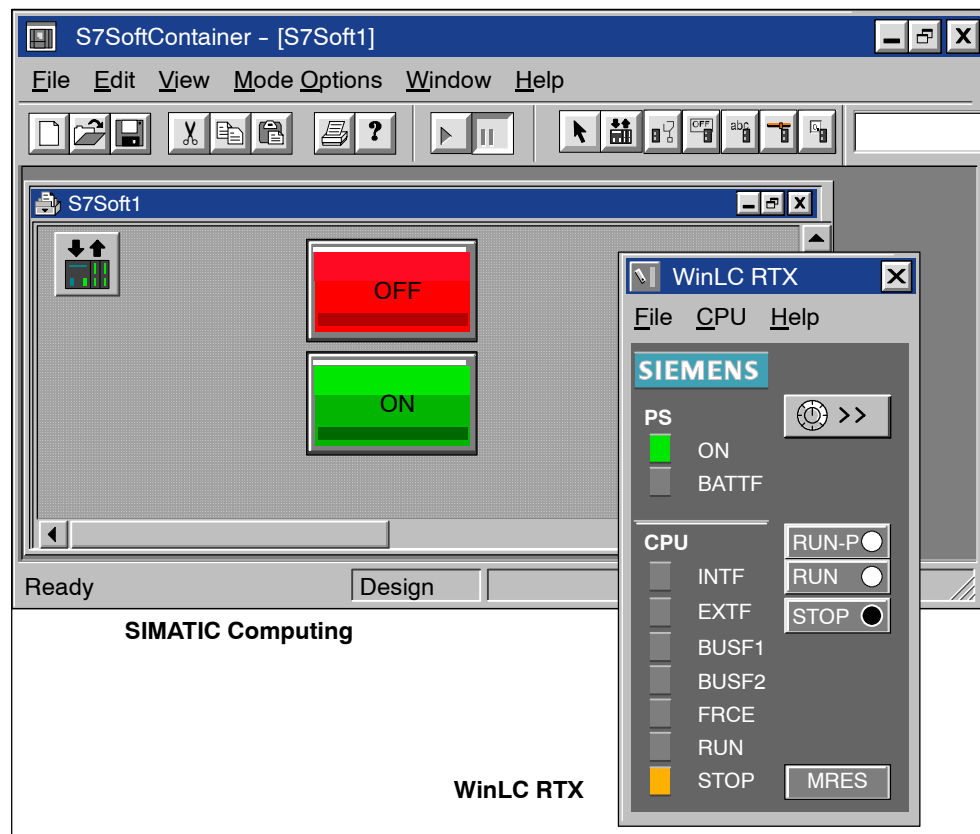

Figure 1-3 Accessing the Process Data with SIMATIC Computing

1.3 Use SIMATIC Computing over a DCOM network

Microsoft's Distributed Component Object Model (DCOM) is a set of program interfaces in which client program objects can request services from server program objects on other computers in a network.

You can use DCOM for integrating distributed applications over a network. See Figure 1-4. A distributed application consists of multiple processes or different computers that cooperate to accomplish a single task.

For more information about using WinAC RTX over a DCOM network, see Appendix A.

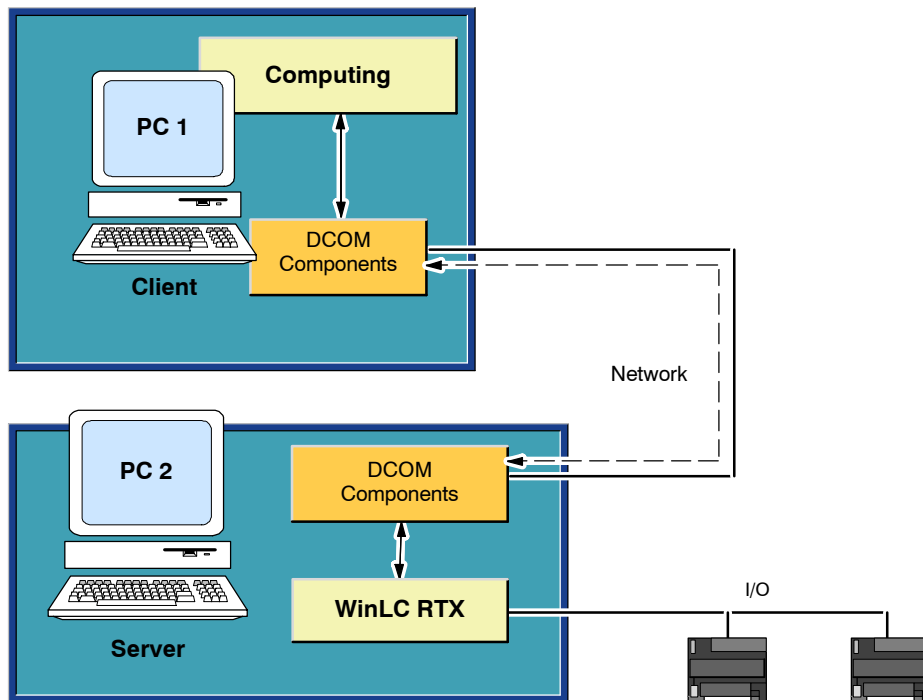

Figure 1-4 Connecting WinAC RTX on Several Computers across a DCOM Network

1.4 Tag files allow you to use symbols for the process data

A tag file provides a source of symbolic information for memory locations and control engines. Linking to a tag file allows you to use symbolic names instead of absolute addresses when assigning variables in SIMATIC Computing. See Figure 1-5.

The TagFile Configurator creates a tag file that provides a source of symbolic information for the memory locations and control engines. The tag file can then be used on a computer that does not have STEP 7 installed.

For more information about the TagFile Configurator, see the *Windows Logic Controller Real-time (WinLC RTX) User Manual* or the *SIMATIC Computing User Manual*.

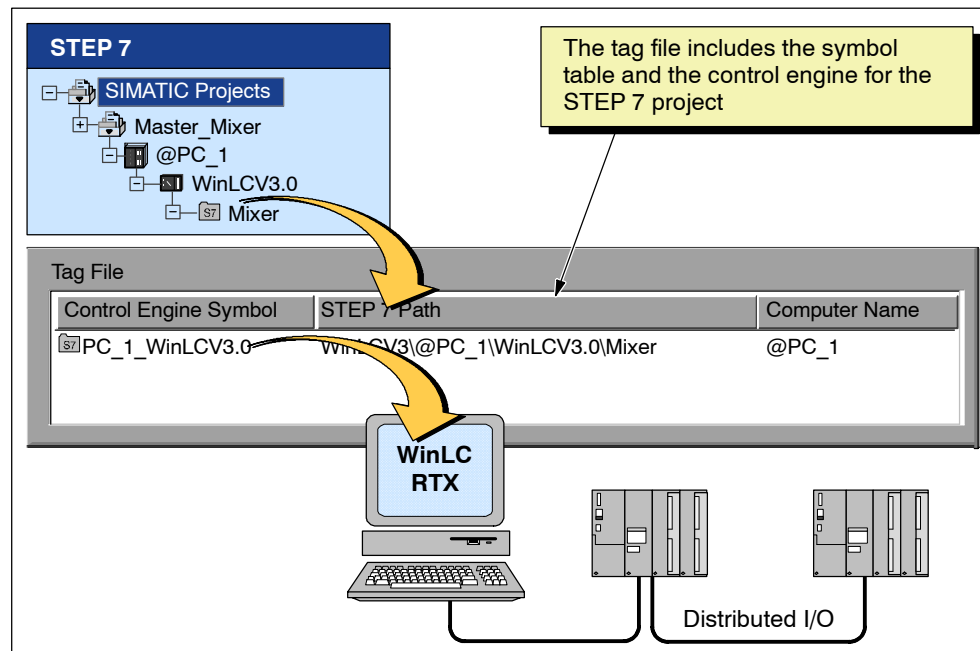

Figure 1-5 Using STEP 7 Symbols to Access Data in the Control Engine

1.5 Tag files allow you to access multiple control engines

Multiple STEP 7 programs can be mapped into a single tag file, with each program providing access to a different computer and control engine. This allows Computing to access data from different computers and control engines simultaneously.

As shown in Figure 1-6, you can connect your program to control engines residing on several different computers. You use the TagFile Configurator to insert more than one control engine into a tag file. For more information about the TagFile Configurator, see the *Windows Logic Controller Real-time (WinLC RTX) User Manual* or the *Computing User Manual*.

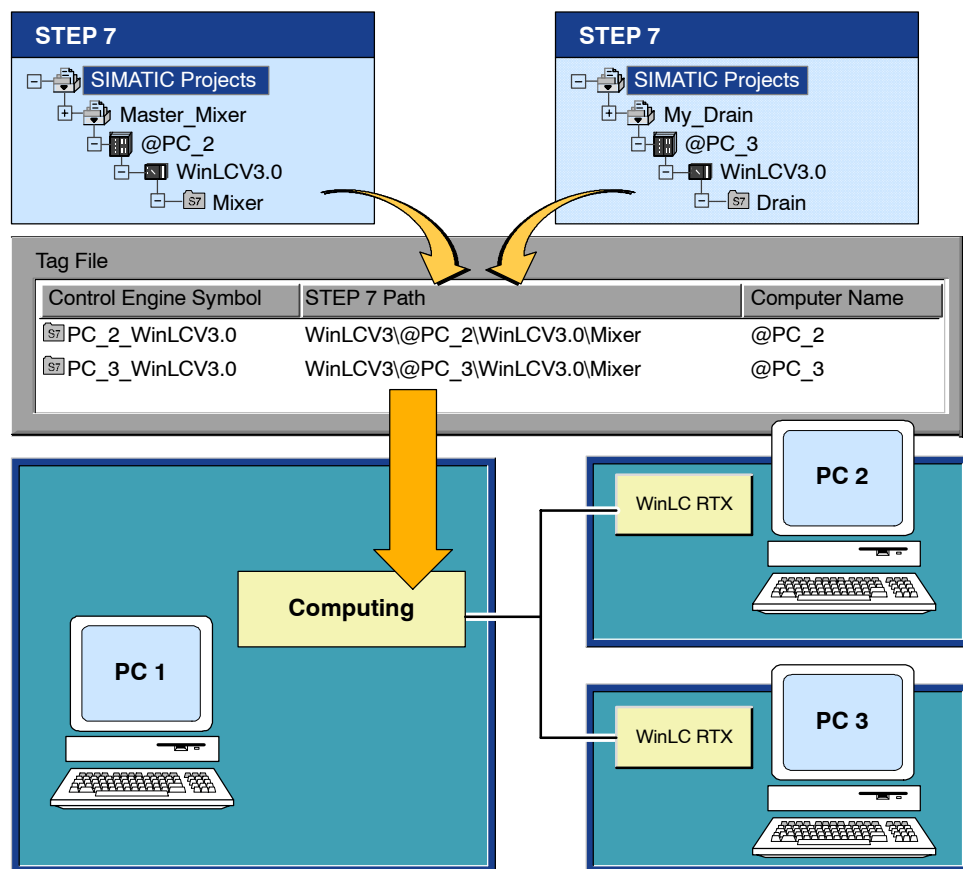

Figure 1-6 Using a Tag File to Access Data from Several Control Engines

1.6 Use OPC to connect third-party applications to SIMATIC Computing

OLE for Process Control (OPC) provides a standard mechanism for communicating to numerous data sources, whether they be the devices on your factory floor or a database in your control room. OPC is based on the OLE/COM technology from Microsoft. For more information about OPC, refer to the OPC specification *OLE for Process Control Data Access Standard, version 2.0* from the OPC Foundation.

As shown in Figure 1-7, you can use the OPC server provided with the Computing software to communicate with the control engine and provide access to the process data. Computing provides an OPC server that allows any OPC client application to access data in the control engine; Computing does not provide any OPC client application.

The name of the OPC server is: OPCServer.WinAC

SIMATIC Computing allows you to use OPC for connecting either to a single control engine or to several control engines. You can also connect to the control engine over a network, such as a local area network (LAN).

For more information about configuring the OPC server, see Appendix B.

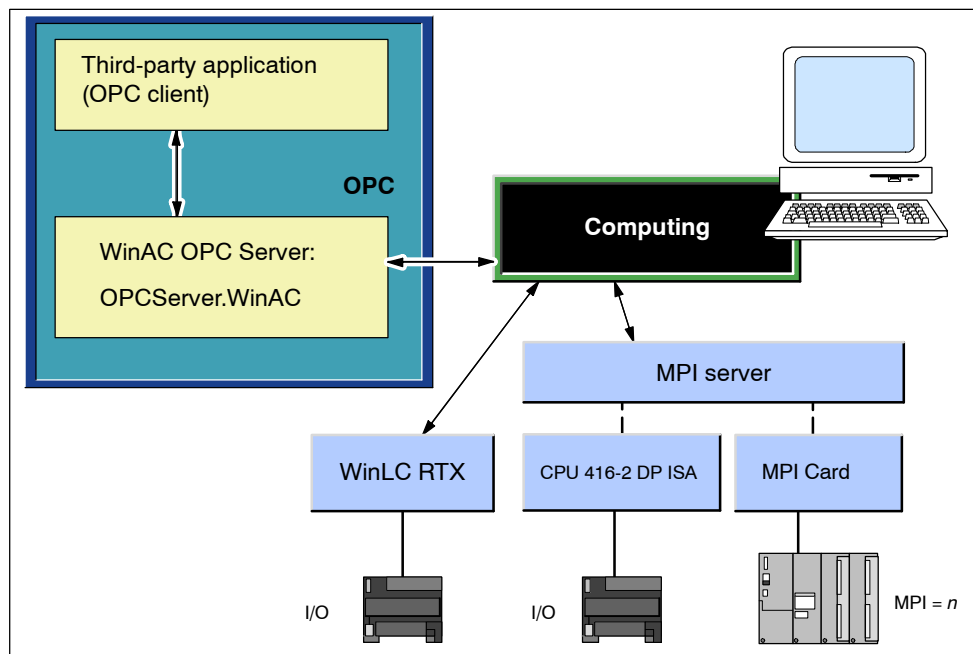

Figure 1-7 Using OPC to Connect Third-Party Applications to Computing

1.7 Toolmanager provides shortcuts to your programs

The Toolmanager is a toolbar that lets you consolidate all of the applications that you want to use while working with your process data. For instance, if you plan to use Visual Basic with WinAC RTX, or want to put process data into a Microsoft Excel spreadsheet, you can insert shortcuts to those items on the Toolmanager. The Toolmanager is especially convenient for users who do not have a mouse on their computer, since all of the functions of the Toolmanager can be accessed by keystrokes from one central location.

Figure 1-8 shows the Toolmanager and its shortcut icon. You can insert shortcut icons for any of your programs into the Toolmanager tray. You then use the Toolmanager to start these programs.

For more information about the Toolmanager, see Chapter 4.

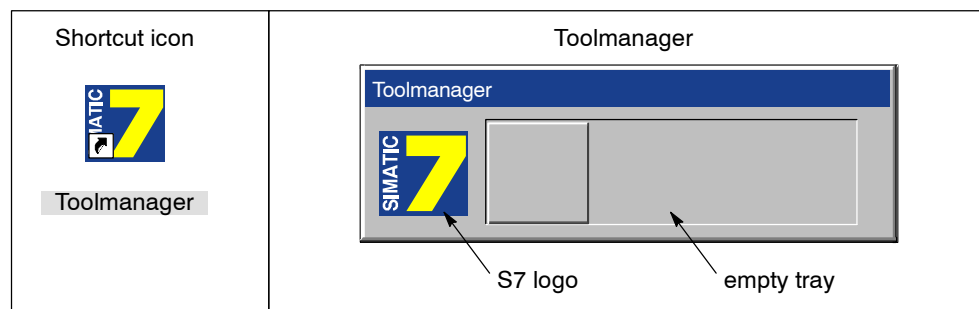

Figure 1-8 Toolmanager and Shortcut Icon

Installing the Components of WinAC Basis RTX

2

Chapter Overview

The WinAC RTX software provides a single setup program that installs the WinLC RTX, SIMATIC Computing, and Toolmanager software. There is a single authorization disk for these products. This chapter provides the following information:

- Section 2.1 lists the requirements for installing and running the WinAC RTX software.
- Section 2.2 provides procedural information about installing the WinAC RTX software.
- Section 2.3 provides procedural information about uninstalling the WinAC RTX software.
- Section 2.4 provides procedural information about installing the authorization for WinAC RTX.
- Sections 2.5 and 2.6 provide additional information about installing WinLC RTX and the CP 5613 card.

Section	Description	Page
2.1	System Requirements	2-2
2.2	Installing the WinAC RTX Software	2-3
2.3	Uninstalling the WinAC RTX Software	2-5
2.4	Authorizing the WinAC RTX Software	2-6
2.5	Special Notes for Installing the WinLC RTX Controller	2-8
2.6	Special Notes for Installing the CP 5613 Card	2-10

2.1 System Requirements

To run the components of WinAC RTX, it is recommended that your computer meet the following criteria:

- A personal computer (PC) with the following:
 - Intel Pentium class or AMD processor running at 400 MHz or faster (recommended)
 - 128 Mbytes RAM (recommended)
 - Microsoft Windows NT version 4.0 SP6
- A color monitor, keyboard, and mouse (or other pointing device) that are supported by Microsoft Windows NT
- A hard drive with 100 Mbytes of free space
- At least 1 Mbyte free memory capacity on drive C for the Setup program (Setup files are deleted when the installation is complete.)

2.2 Installing the WinAC RTX Software

The WinAC RTX software includes a Setup program which executes the installation automatically. The screen prompts guide you step by step through the installation procedure.

The Setup program automatically removes any WinLC RTX and CP 5613 drives that were previously installed on the computer.

During installation, the Setup program checks to see whether an authorization is installed on the hard disk. If no authorization is found, a message notifies you that the software can be used only with an authorization. If you wish, you can run the authorization program immediately or you can continue the installation and execute the authorization later. See Section 2.4.

Note

You must have Windows NT administrator ("ADMIN") privileges to install the WinAC RTX software.

Installing the Components of WinAC RTX

Figure 2-1 shows the dialog box that allows you to choose which components to install. Select the components that you want to install. Each component that you have selected is installed in the same directory.

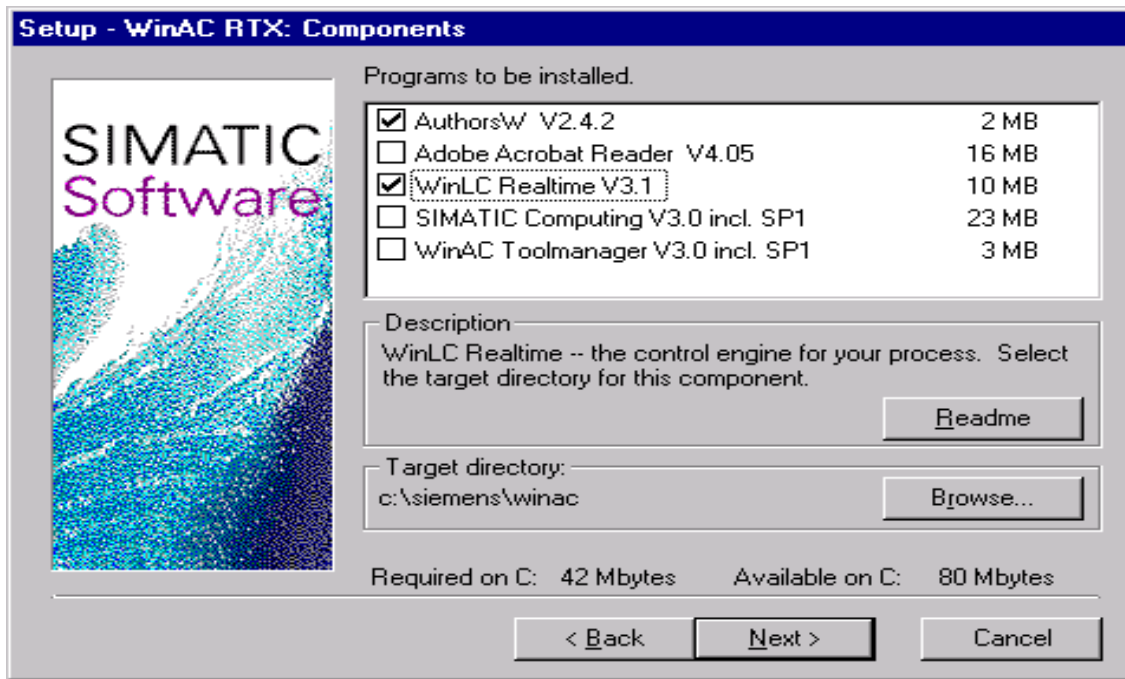

Figure 2-1 Installing the Components of WinAC RTX

Note

The installation of the WinLC RTX software requires that you install a CP 5613 communications processor card. To install the CP 5613 card, you must turn off your computer and install the board.

Refer to the *Windows Logic Controller Real-time (WinLC RTX) User Manual* for information about installing the components of the WinLC software.

Starting the Installation Program

The Setup program guides you step by step through the installation process. You can switch to the next step or to the previous step from any position. To start the installation program, proceed as follows:

1. Insert the CD-ROM in your computer.
2. Use the Windows NT Start menu (select the **Start > Run** menu command) to open the Run dialog box.
3. Click Browse and select the installation program (Setup.exe) on the CD-ROM.
4. Click Open to enter the Setup.exe program into the Run dialog box.
5. Click OK to start the installation program.
6. Follow the instructions displayed by the Setup program and select the elements of WinAC RTX to install:
 - The Setup program first installs the VenturCom Real-time extensions (RTX). After the RTX extensions are installed, the Setup program restarts your computer.
 - After the computer has been restarted, the Setup program installs elements of WinAC RTX that you selected.
7. When prompted by the software, insert the WinAC RTX authorization diskette in drive A. For more information about authorizing the WinAC RTX software, see Section 2.4.

Once the installation has been completed successfully, a message to that effect is displayed on the screen.

Note

The WinAC RTX authorization is installed on the server computer and the SIMATIC Computing authorization is installed on the client computer. If SIMATIC Computing is to be run on a computer other than the one running WinLC RTX, you must purchase the SIMATIC Computing stand-alone product. For more information about installing an authorization, see Section 2.4.

Troubleshooting Any Errors That Occur during Installation

The following errors may cause the installation to fail:

- Initialization error immediately after starting Setup: The SETUP.EXE program was probably not started under Windows NT.
- Not enough memory: You need at least 100 Mbytes of free space on your hard disk.
- Bad disk: Verify that the WinAC RTX CD is damaged, then call your local Siemens representative.
- Operator error: Restart the system and begin the installation again. Follow the instructions.

2.3 Uninstalling the WinAC RTX Software

Use the following procedure to remove the WinAC RTX software from your computer:

1. Double-click on the Add/Remove Programs icon in the Windows NT Control Panel.
2. Select the WinAC RTX entry in the displayed list of installed software. Click Add/Remove to uninstall the software.
3. If the Remove Enable File dialog boxes appear, click No if you are unsure how to respond.

2.4 Authorizing the WinAC RTX Software

The WinAC RTX software requires a product-specific authorization (or license for use). The software can be used only if the relevant authorization for the program or software package has been found on the hard disk of the computer.

Using the WinAC RTX Authorization Diskette

There are separate authorization diskettes for each of the SIMATIC automation software products. You must install the authorization for each product as part of the installation procedure for that software. For more information and rules on how to handle authorizations, see the documentation for the specific SIMATIC software product.

Caution

If improperly transferred or removed, the authorization for the WinAC RTX software may be irretrievably lost.

The Readme file on the authorization diskette contains guidelines for installing, transferring, and removing the authorization for the WinAC RTX software. If you do not follow these guidelines, the authorization for the WinAC RTX software may be irretrievably lost.

Read the information in the Readme file on the authorization diskette, and follow the guidelines in regard to transferring and removing the authorization.

Installing the Authorization for the First Time

When you install the software for the first time, a message prompts you to install the authorization. Use the following steps to install the authorization for the WinAC RTX software:

1. When prompted, insert the authorization diskette in a drive.
2. Acknowledge the prompt.

The authorization is transferred to a physical drive, and your computer registers the fact that the authorization has been installed.

Note

Always enter drive C as the destination drive for the authorization for WinAC RTX.

Adding an Authorization at a Later Date

If you attempt to start the WinAC RTX software and no authorization is found, a prompt appears on the screen. If you want to install the authorization, select **Start > Simatic > AuthorsW .> AuthorsW** . The AuthorsW program is menu-driven and allows you to display, install, and remove authorizations. If AuthorsW is not installed on your computer, reinstall WinLC RTX and select the AuthorsW checkbox.

Removing an Authorization

If you should need to repeat the authorization (for example, if you want to reformat the drive on which the authorization is located), you must first remove the authorization. You need the original authorization diskette to do this.

Use the following steps to transfer the authorization back to the authorization diskette:

1. Insert the original authorization diskette in your floppy disk drive.
2. Select **Start > Simatic > AuthorsW .> AuthorsW** .
3. From the list of all authorizations on drive C, select the authorization to be removed.
4. Select the menu command **Authorization > Transfer....**
5. In the dialog box, enter the target floppy drive to which the authorization will be transferred and confirm the dialog box.
6. The window with the list of authorizations remaining on the drive is then displayed. Close the AUTHORSW program if you do not want to remove any more authorizations.

You can then use the diskette again to install an authorization.

If Your Hard Drive is Defective...

If a fault occurs on your hard disk before you can back up the authorization, contact your local Siemens representative.

2.5 Special Notes for Installing the WinLC RTX Controller

The WinLC RTX is the control engine component of the WinAC RTX software suite. The following components are required to install the WinLC RTX control engine:

- PROFIBUS-DP Communications processor CP 5613 PCI card (purchased separately)
- VenturCom Real-time extensions (RTX) for Windows NT (included with WinAC RTX)
- WinLC RTX software (included as part of WinAC RTX software)

Note

If you purchased your RTX from Siemens, use the Siemens Customer ID 38403, and Siemens License Key 8864179646. If you purchased your RTX directly from VenturCom, use the customer ID and License Key from VenturCom.

These products are installed on the computer system that is designated as the automation controller. The WinLC RTX controls the PROFIBUS-DP I/O over the network by means of the CP 5613 card.

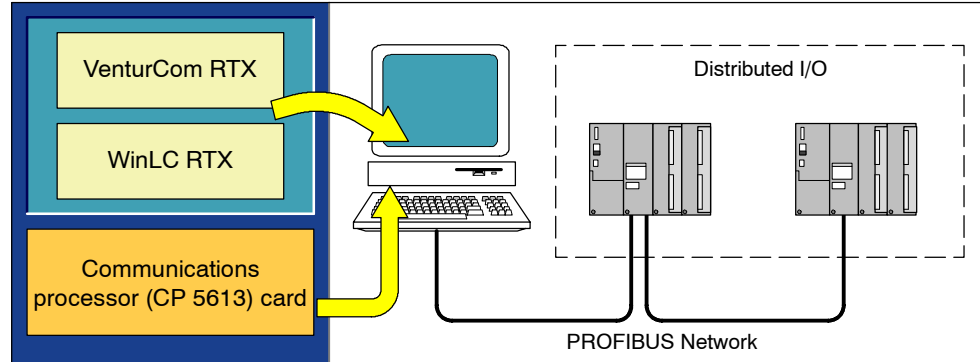

Figure 2-2 Installing WinLC RTX

Each component must be installed separately on your computer. Refer to the documentation for each component for the specific instructions for installing that component. If you are installing the STEP 7 software (or another SIMATIC software package), refer to the installation procedures for that product.

You must perform the following tasks to install the components of WinLC RTX:

- You must install the CP 5613 card in your computer. For information about this installation procedure, refer to the documentation for the specific CP.
- You must use the Setup program for WinAC RTX to install WinLC RTX. The DP drivers for the CP 5613 card are included during the installation. For more information about installing WinLC RTX, see Section 2.2 .
- You must authorize WinAC RTX for use on your computer. For information about installing the authorization, see Section 2.4.

After you have installed both WinLC RTX and the CP 5613 card, you must configure the CP 5613 card for WinLC RTX. You can then connect your computer to the distributed I/O network.

Running the WinLC Controller without the Authorization

If you remove (or accidentally delete) the authorization for the software, the WinLC RTX controller continues to operate; however, a notification message appears every six minutes to alert you that the authorization is missing.

If you install an authorization while the WinLC RTX controller is running, you must also change the operating mode of the controller before the authorization takes effect.

Running WinLC RTX as an NT Service

If you install WinLC RTX to run as a Windows NT service, WinLC RTX starts automatically each time the computer is started. The Setup program allows you to choose whether to install WinLC RTX as an NT service. After WinLC RTX is installed as an NT service, a user with administrative privileges can change the configuration of WinLC RTX to start manually instead of automatically.

You can use the WinLC control panel to register and unregister WinLC RTX as an NT service.

2.6 Special Notes for Installing the CP 5613 Card



Caution

Attempting to run WinLC RTX with both the WinLC RTX drivers and the SIMATIC NET drivers for the CP 5613 installed on your computer can cause unpredictable operation of the CP 5613 card, which might result in potential damage to equipment and possible injury to personnel.

Do not install the SIMATIC NET software for the CP 5613 card after you have installed WinLC RTX.

The WinLC RTX controller uses a real-time device driver to access the CP 5613 card. This device driver replaces the SIMATIC NET CP 5613 device driver delivered with the CP 5613 hardware.

The SIMATIC NET software for the CP 5613 includes the following products: DP 5613, S7 5613, FMS 5613, and CP 5613/ CP 5614 Software DP Base. Installing any of these products on your computer installs the SIMATIC NET device drivers for the CP 5613 card.

The Setup program for WinLC RTX removes any existing CP 5613 device drivers from your computer before installing the WinLC RTX device drivers for the CP 5613 card. Do not install the CP 5613 software from the SIMATIC NET CD, especially after you have installed the WinLC RTX software.

Advanced Tip: Accessing the CP 5613 in Polled or Interrupt Mode

WinLC RTX accesses the CP 5613 card in either “Polled” or “Interrupt” mode. Interrupt mode provides improved performance over Polled mode. In order for WinLC RTX to use the Interrupt mode for accessing the CP 5613, the interrupt request (IRQ) number for the CP card must be available.

To ensure that WinLC RTX accesses the CP 5613 in Interrupt mode, you must configure your computer so that the CP 5613 does not share an IRQ number with an NT device.

Use the following procedure to determine the IRQ number assigned to the CP 5613:

1. Browse to the Program Files\Vci\RTX\Samples directory (typically on the C drive) and locate the ScanBus.rtss utility.
2. Double-click on the ScanBus.rtss icon. The ScanBus utility lists all of the PCI devices which have been installed on your computer. Included in this list are the resources for each device.

3. Locate the PciData for the following device:
 - VendorID: 0x110a
 - DeviceID: 0x3142
4. The InterruptLine entry shows the IRQ number that has been assigned for the CP 5613 card. Record the IRQ number to use as a reference.

Use the following procedure to display the IRQ numbers assigned to the NT devices on your computer:

1. Select the **Start > Programs > Administrative Tools (Common) > Windows NT Diagnostics** menu command to display the Windows NT Diagnostics dialog box.
2. Select the Resources tab to display the IRQ numbers assigned to the devices installed in your computer:
 - If there is an entry for “cp5613” in the device list, you have installed a component of the SIMATIC NET CP 5613 software. You must remove this software before WinLC RTX can function correctly.
 - Compare the IRQ numbers listed for the NT devices with the IRQ number of the CP 5613 that you recorded in Step 4. If this number has been assigned to any device other than the Rtx_rtss device, the CP 5613 is used in Polled mode. Otherwise, the CP 5613 is used in Interrupt mode.

If the IRQ for the CP 5613 card is assigned to an NT device, use one of the following methods to change the system configuration for your computer and assign a different IRQ number to the CP 5613 card:

- Use the BIOS setup utility of your computer to assign a unique IRQ to the CP 5613 card.
- Install the CP 5613 card in a different slot on the PCI bus of your computer.

Note

This may be an iterative process, and you may find that there is no solution that assigns an IRQ number to the CP 5613 card (Rtx_rtss device). In this case, use the polled mode of operation.

Getting Started with WinAC RTX

Chapter Overview

WinAC RTX provides two basic components:

- WinLC RTX: a software-based S7 programmable logic controller (PLC), also referred to as a “control engine”
- SIMATIC Computing: a set of SIMATIC controls that utilize Microsoft’s ActiveX technology to access data in the control engine

You can use a sample program (provided with the STEP 7 programming software) to help understand how to use the components of WinAC RTX.

Section	Description	Page
3.1	Using WinAC RTX with a Sample Program	3-2
3.2	Starting the WinLC RTX Controller	3-4
3.3	Downloading a Sample Program to WinLC RTX	3-5
3.4	Using the SoftContainer to Create a Process Form	3-13
3.5	Configuring the Connections for the Process Form	3-16
3.6	Configuring the Button Controls on the Process Form	3-21
3.7	Running the Process Form with the Sample Program	3-26

3.1 Using WinAC RTX with a Sample Program

To help you start using the components of WinAC RTX, this chapter provides information about the following tasks:

- Start the WinLC RTX controller. You must have Windows NT administrator privileges (“ADMIN”) to run WinLC.
- Modify a sample program (provided by STEP 7) for use with WinLC RTX and then download the program to the WinLC RTX controller.
- Create a process form for the sample program, using the included SoftContainer software and two of the controls provided by SIMATIC Computing.

Figure 3-1 lists the order of the tasks required for using WinAC RTX with the sample program.

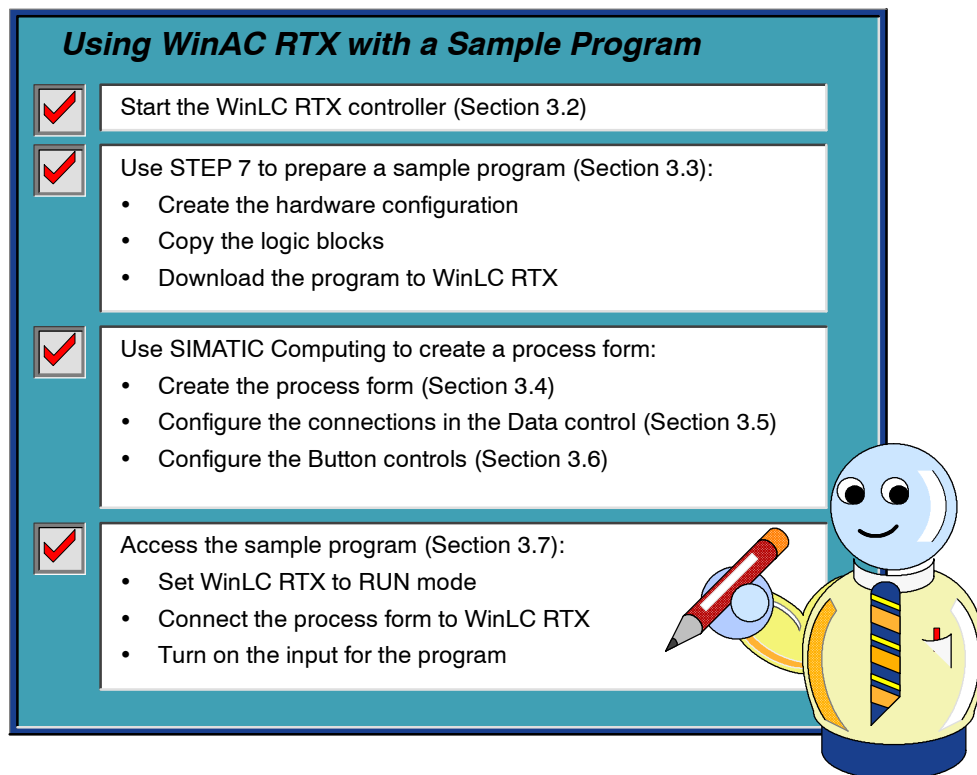

Figure 3-1 Tasks for Using WinAC RTX with a Sample Program

Note

This example uses a sample hardware configuration with no connections to I/O. It is possible to operate the WinLC RTX control engine without I/O. However, when WinLC RTX is to control a process, you must configure the network I/O using the Hardware Configuration utility included in STEP 7.

For more information, see the STEP 7 Online Help or the *STEP 7 User Manual*. The WinLC RTX controller runs the sample program. WinLC RTX is installed as part of the Setup program for WinAC RTX. (Refer to Chapter 2).

In order to perform the tasks described in this chapter, you must have installed the following software packages:

- WinLC RTX: provides the control engine that will run the sample program. WinLC RTX is installed as part of the Setup program for WinAC RTX. (Refer to Chapter 2.)
- SIMATIC Computing: provides the container and the ActiveX controls for creating the process form that will access the program running on WinLC. SIMATIC Computing is installed as part of the Setup program for WinAC RTX. (Refer to Chapter 2.)
- STEP 7: provides the sample program and the tools for creating the hardware configuration for WinLC RTX. Refer to the documentation for STEP 7 for information about installing STEP 7. The recommended version of STEP 7 is version 5.0 service pack 3 (SP3) or higher, but WinLC RTX can be used with earlier versions of STEP 7.

3.2 Starting the WinLC RTX Controller

To start WinLC RTX, select the **Start >SIMATIC > PC Based Control > WinLC RTX Controller** menu command from the Windows NT Start menu. As shown in Figure 3-2, the WinLC RTX control panel opens. You use this control panel to control the operations of WinLC RTX.

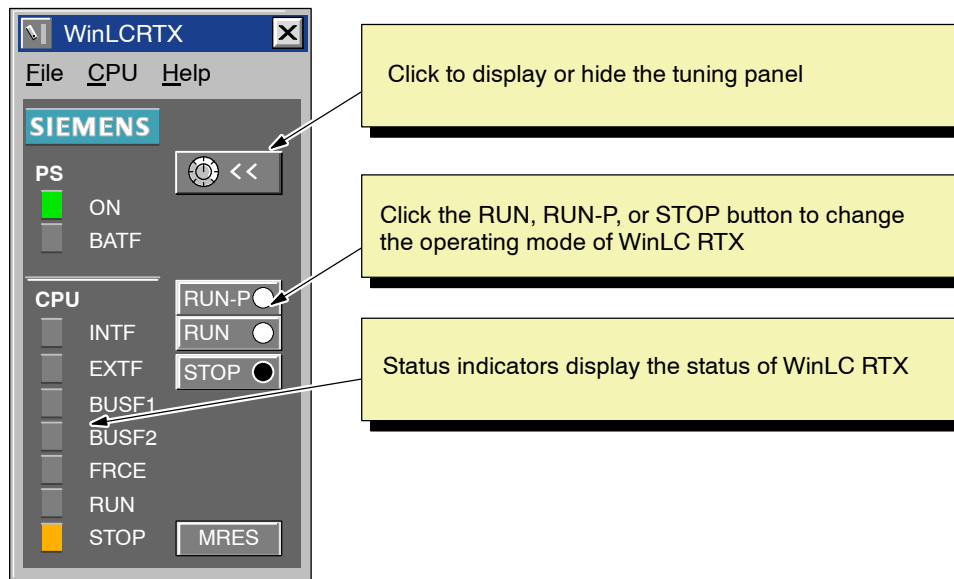

Figure 3-2 Starting the WinLC RTX Controller

3.3 Downloading a Sample Program to WinLC RTX

Note

In order to download a user program to the WinLC RTX controller, you must set the PG/PC interface to connect STEP 7 to WinLC RTX.

You can install STEP 7 and WinLC RTX on the same computer, or you can connect STEP 7 to WinLC RTX over a network. Refer to the *Windows Logic Controller Real-time (WinLC RTX) User Manual* for specific information about setting the PG/PC interface to determine how STEP 7 connects to WinLC RTX.

In order to download the sample program to the WinLC RTX controller, you must use the STEP 7 programming software to perform the following tasks:

- Open a sample project.
- Insert a station into the sample project:
 - For STEP 7 version 5.0 SP3: Insert a PC station.
 - For STEP 7 version 4: insert an S7-300 station (and configure WinLC RTX as version 2.0).
- Creat.xe the hardware configuration for WinLC RTX.
- Copy the program blocks for a sample program to the WinLC RTX station.
- Download the sample program and hardware configuration to WinLC RTX.

This section provides procedures for accomplishing these tasks. Refer to the *STEP 7 User Manual* and the online help for the STEP 7 software for additional information about using STEP 7.

Note

With STEP7 version 5.0 SP3 or higher, WinLC RTX is configured as a PC station. WinLC RTX has features that can only be used if configured in a PC station. In earlier versions of STEP 7 without the service pack, you must use an S7-300 station and configure WinLC RTX as version 2.0.

Opening a Sample Project

STEP 7 provides a sample project that you can use with WinAC RTX. Use the following procedure to open a sample project:

1. Open the SIMATIC Manager:
 - For STEP 7 version 5.0: Select the **Start > SIMATIC > SIMATIC Manager** menu command from the Windows NT Start menu.
 - For STEP 7 version 4.x: Select the **Start > SIMATIC > STEP 7 > SIMATIC Manager** menu command.
2. Select the **File > Open** menu command (or click on the Open icon) to display the Open dialog box.
3. In the Open dialog box, select the Sample Projects tab.

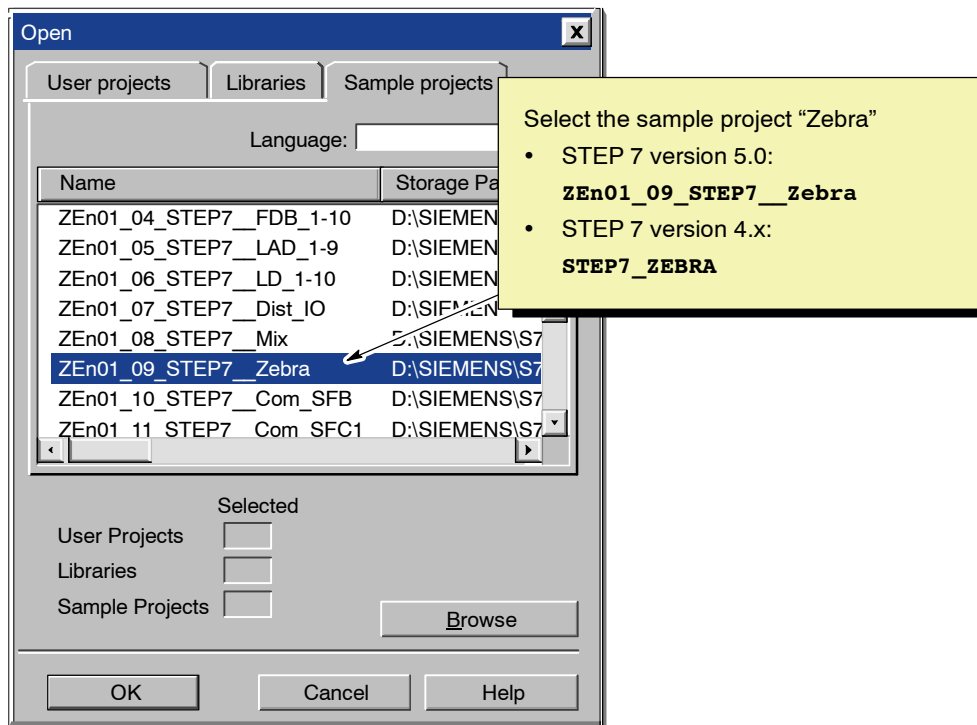

Figure 3-3 Opening the Sample Project (ZEn01_09_STEP7__Zebra)

4. As shown in Figure 3-3, scroll down the list of projects and select the “Zebra” project:

- For STEP 7 version 5.0, select: ZEn01_09_STEP7__Zebra
- For STEP 7 version 4.x, select: S7_ZEBRA

You may need to change the width of the Name column to view the full name.

5. Click OK to open the sample project.

STEP 7 opens the sample project. See Figure 3-4.

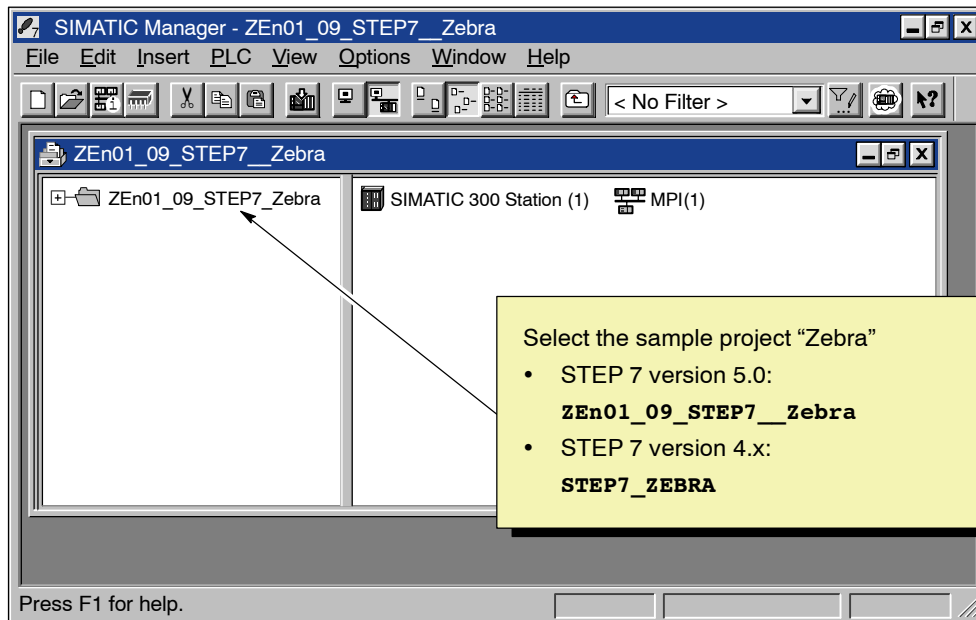

Figure 3-4 Sample STEP 7 Program (ZEn01_09_STEP7__Zebra)

Inserting a Station in the Sample Project

Before you can create the hardware configuration for WinLC RTX, you must insert a station in your project.

- For STEP 7 Version 5.0, SP 3, insert a PC station. STEP 7 V5.0 SP3 models WinLC RTX as a component in a PC station.
- For versions of STEP 7 prior to Version 5.0, SP 3, you must insert a SIMATIC 300 station.

Use the following procedure for inserting a station:

1. Select (click on) the project (ZEn01_09_STEP7__Zebra).
2. Select the **Insert > PC Station** menu command to insert a station under the project. (To insert a SIMATIC 300 station, select **Insert > SIMATIC 300 Station** menu command.)
3. Select (click on) the station to display the hardware icon for the station.

Note

Certain System Data Blocks (SDBs) have a different structure, depending on whether the WinLC RTX is configured in a 300 Station or a PC Station. You must manually select the correct station type for your application. Failure to configure the correct station type will cause upload/download errors.

1. From the WinLC control panel, select the **CPU > Options > Customize** menu command.
 2. Select the Station Type tab on the Customize dialog box.
 3. As shown in Figure 3-5, select the appropriate station type.
 4. Click OK to enter the configuration.
-

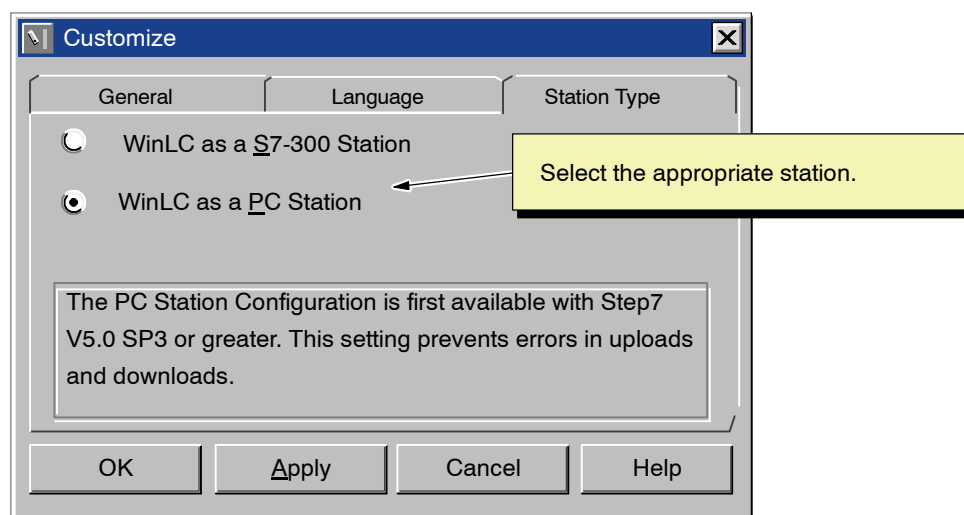

Figure 3-5 Setting the Station Type

Creating the Hardware Configuration for the WinLC RTX Controller

Use the following procedure to create the hardware configuration for WinLC RTX:

1. Select the PC station. If you have STEP 7 version 5.0 prior to service pack 3, select SIMATIC 300 station.
2. Double-click on the Hardware object to open the configuration tool of the STEP 7 software. See Figure 3-6.

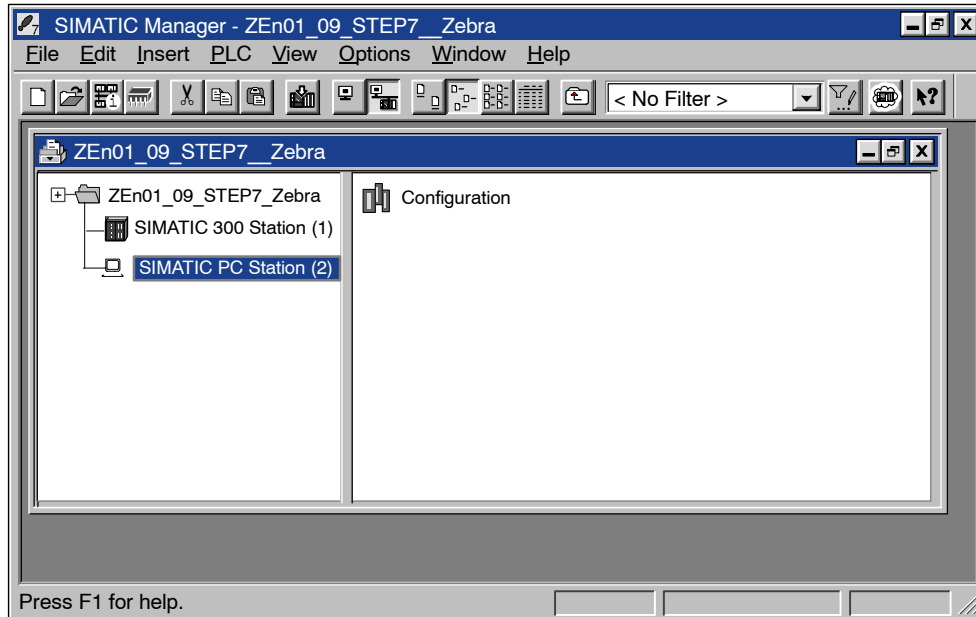

Figure 3-6 Configuring the PC Station in the Sample Project

3. For a PC station:
 - Double-click on the Configuration icon to open the hardware catalog.
 - Select the second slot in the PC display.
 - Select **SIMATIC PC Station > Controller** from the catalog. Click on the WinLC RTX icon.
 - Use the mouse to drag the “WinLC” object into slot 2 of the PC display

Note

With STEP7 V5.0 SP3 or higher, WinLC RTX is configured as a PC station. WinLC RTX has features that can only be used if configured in a PC station. In earlier versions of STEP 7 without the service pack, you must use an S7-300 station and configure WinLC as version 2.0. See step 4. below.

4. For a SIMATIC 300 station in a version of STEP 7 prior to V5.0 SP3:
 - Select the **Insert > Hardware Components** menu command to open the hardware catalog.
 - Select and open the “SIMATIC PC Based Control 300/400” object.
 - Double-click the “WinLC” object. If you do not have STEP 7 V5.0 SP3, be sure to select WinLC V2.0.
5. In the “Properties - PROFIBUS Node DP Master” dialog box, click New to open the “Properties - New Subnet PROFIBUS” dialog box and enter a PROFIBUS subnet or click OK to accept the default of PROFIBUS(1).

(Although you will not be using the subnet or configuring distributed I/O for this sample program, STEP 7 requires that you configure a subnet for WinLC.)
6. Click OK to enter the default parameters for a PROFIBUS subnet.
7. Select the PROFIBUS(1) subnet.
8. Click OK to enter the default subnet and address and to close the “Properties - PROFIBUS Node DP Master” dialog box. WinLC V.2.0 appears as the module in slot 2 of the rack.
9. Select the **Station > Save and Compile** menu command to create the sample hardware configuration for WinLC RTX.

Copying the Sample Program to the Station

The original station in the Zebra project contains the logic blocks (OB1 and FC1) of the sample user program. You will copy these blocks to the WinLC station that you just created and configured. Use the following procedure to copy the sample program:

1. Open the hierarchy for the SIMATIC 300 station program:
 - Double-click on: **SIMATIC 300-Station(1)**
 - Double-click on: **CPU314(1)**
 - Double-click on: **S7-Program(1)**
 - Double-click on: **Blocks**
2. Select the logic blocks of the 300 station program (OB1 and FC1).
3. Select the **Edit > Copy** menu command to copy these logic blocks.

4. Open the hierarchy for the PC station program:
 - Double-click on: **SIMATIC PC Station(1)**
 - Double-click on: **WinLCRTX**
 - Double-click on: **S7-Program(2)**
 - Double-click on: **Blocks**
5. Select the **Edit > Paste** menu command to paste the logic blocks (OB1 and FC1) into the PC station program.

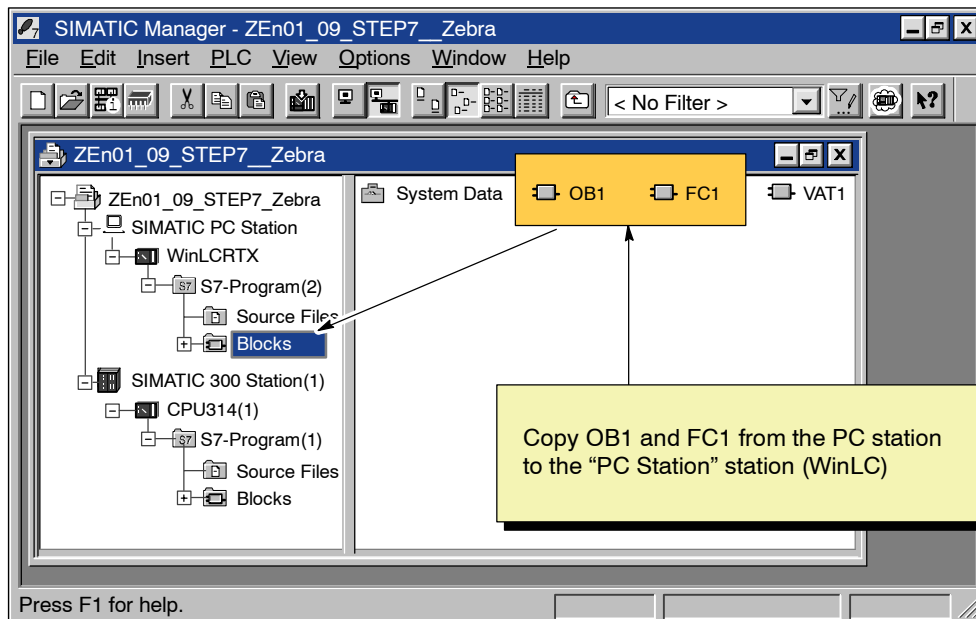

Figure 3-7 Pasting the Sample Logic Blocks into the WinLC Program (PC Station)

Downloading the Sample Program

After you copy the logic blocks to the PC station, you can download the program to WinLC RTX. Use the following procedure to download the sample program:

1. Select the “Blocks” folder in the SIMATIC PC station.
2. Select the menu command **PLC > Download** or click on the Download button.
3. When prompted to download the hardware configuration, click OK.

STEP 7 downloads the sample program and the sample hardware configuration.

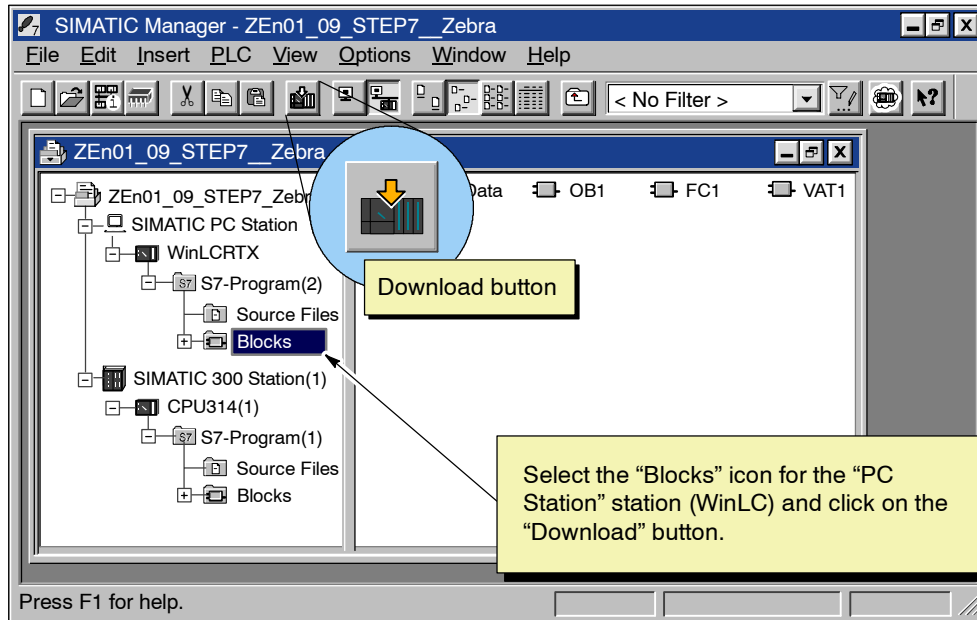

Figure 3-8 Downloading the Sample Program

3.4 Using the SoftContainer to Create a Process Form

SIMATIC Computing provides the SoftContainer software. This is an OLE container for the included ActiveX controls. Using the SoftContainer, you can create process forms for accessing various control engines including WinLC RTX.

The toolbar of the SoftContainer contains icons for the SIMATIC controls provided by the Computing software. These icons allow you to insert these controls easily onto the process form. You can also add other ActiveX controls to the process form (and to the toolbar of the SoftContainer).

Opening a Process Form

To open the SoftContainer and the default process form, select the **Start > Simatic > PC Based Control > Computing Softcontainer** menu command from the Windows NT Start menu.

Figure 3-9 shows the SoftContainer with the default process form (S7Soft1).

Select the **File > Save As...** menu command to display the Save As dialog box. Rename the process form to **Traffic_Lamp** and save the process form.

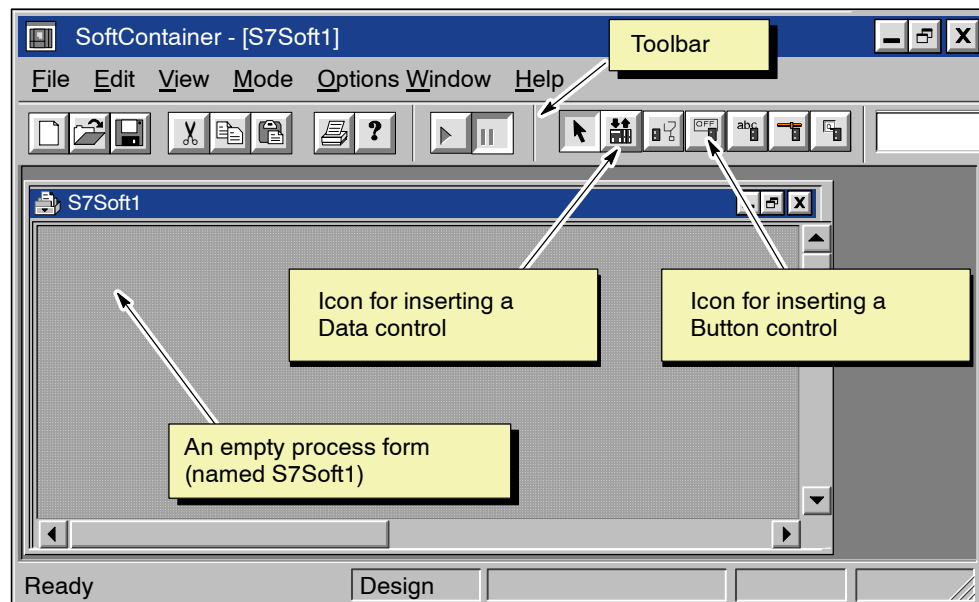

Figure 3-9 SoftContainer with the Default Process Form

Inserting SIMATIC Controls onto the Process Form

For this example, you insert four SIMATIC controls: a Data control and three Button controls. The Data control connects the Button controls to WinLC RTX, and the Button controls access memory locations (or “variables”) in WinLC RTX.

Use the following procedure to insert the controls onto the process form:

1. As shown in Figure 3-10, insert a Data control:
 - Click on the icon for the Data control.
 - Move the cursor to the process form.
 - Click the left mouse button to insert the Data control onto the process form.

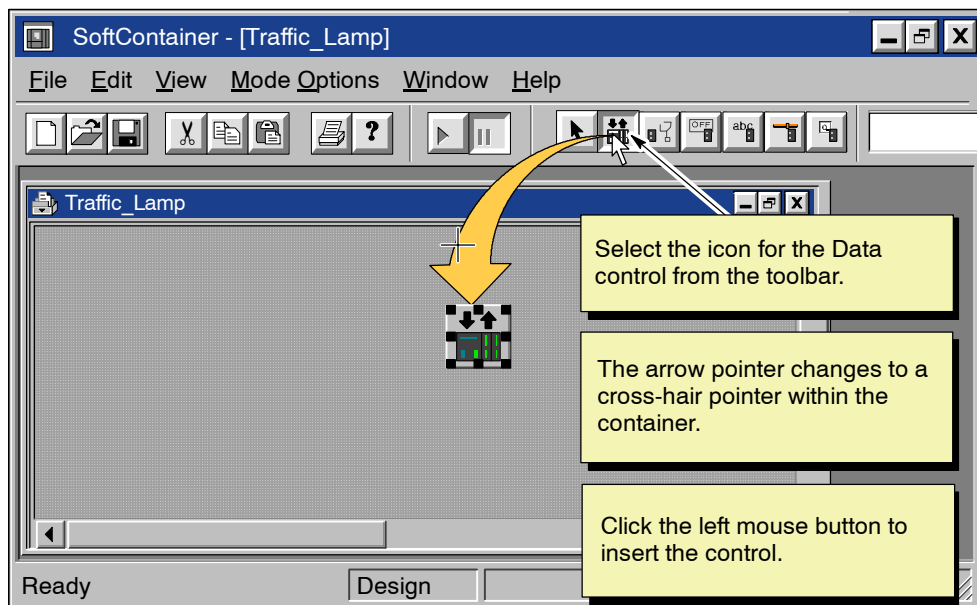

Figure 3-10 Inserting a SIMATIC Data Control from the Toolbar

2. As shown in Figure 3-11, insert three Button controls onto the process form:
 - Click on the Button icon on the toolbar.
 - Move the cursor to the process form.
 - Click the left mouse button to insert a Button control (Button1) onto the process form.Repeat to insert the other two Button controls (Button2 and Button3).

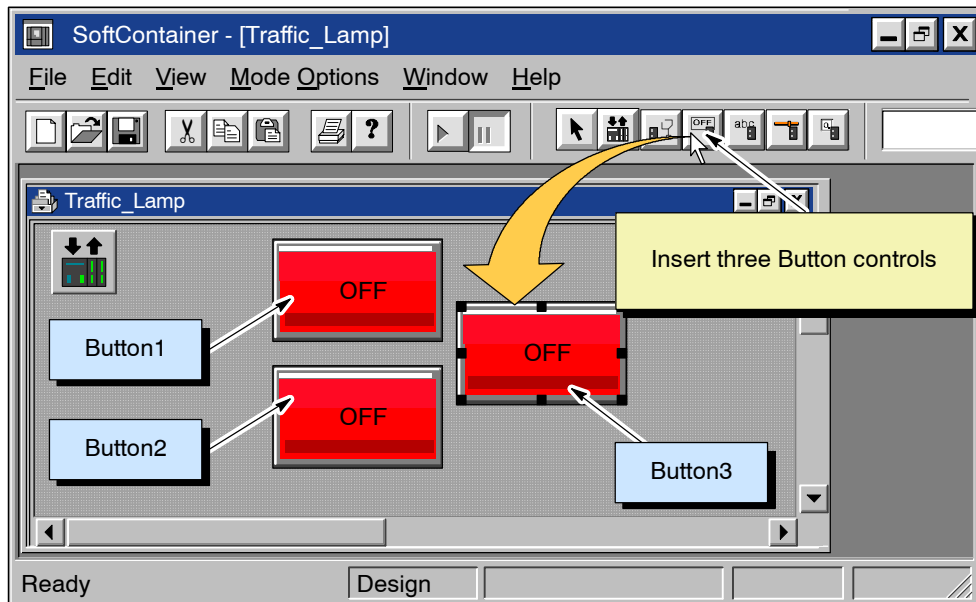

Figure 3-11 Inserting SIMATIC Button Controls

3.5 Configuring the Connections for the Process Form

The SIMATIC controls provide dialog boxes for configuring the properties for the control. In this example, you will use the Properties dialog box of the Data control to perform the following tasks:

- Selecting the WinLC RTX control engine (in this example, WinLC RTX)
- Assigning the variables (memory addresses) in the control engine to properties of the ActiveX controls (in this example, the Button controls) in the process form

Accessing the Properties Dialog Box for the Data Control

Use the following procedure to open the Properties dialog box for the Data control:

1. If the Data control is not already selected, select (click on) the Data control (S7Data1).
2. As shown in Figure 3-12, double-click on the Data control (or click the right mouse button to display a pop-up menu and select the **S7Data1 Properties** menu command) to display the Properties dialog box for the Data control.

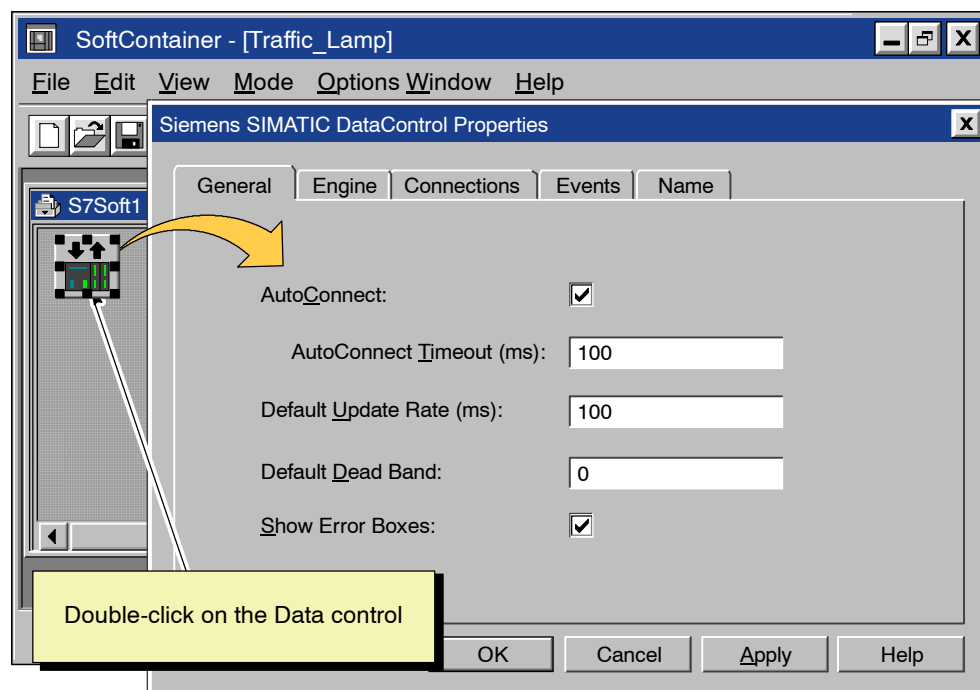

Figure 3-12 Accessing the Properties Dialog Box for the Data Control

Configuring the Data Control to Connect to WinLC RTX

Use the following procedure to select WinLC RTX as the control engine:

1. In the Properties dialog box for the Data control, select (click on) the Engine tab to display the options for selecting the control engine. See Figure 3-13.
2. Select the “Direct Connect” option.
3. In the “Control Engine” field, enter the following string:
wcS7=2
4. Click Apply to configure the Data control to connect to WinLC RTX.

Note

Clicking Apply enters the changes you have made in the dialog box, but keeps the dialog box open. Clicking OK enters the changes and closes the dialog box. For this example, keep the dialog box open for the following procedures.

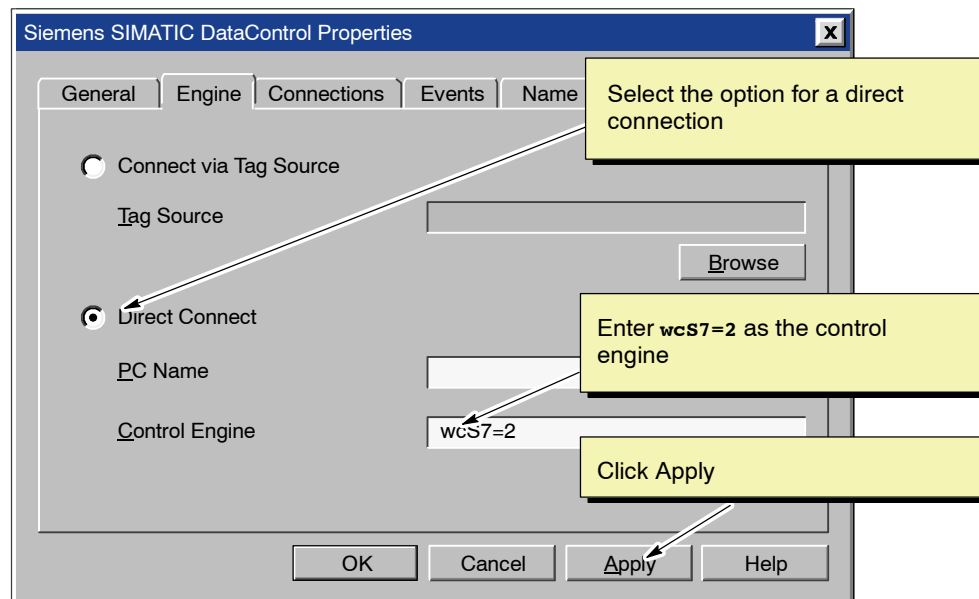

Figure 3-13 Connecting the Data Control to WinLC RTX

Assigning the Variables in the Control Engine to the Button Controls

You use the Properties dialog box for the Data control to connect the other controls to memory locations in the control engine (WinLC RTX). You do this by assigning a variable (memory location) to a property of the control. Use the following procedure to assign variables in WinLC RTX to the Button controls:

1. In the Properties dialog box for the Data control, select (click on) the Connections tab.
2. If the controls and properties are not already displayed, expand the hierarchy for S7Data1. See Figure 3-14.

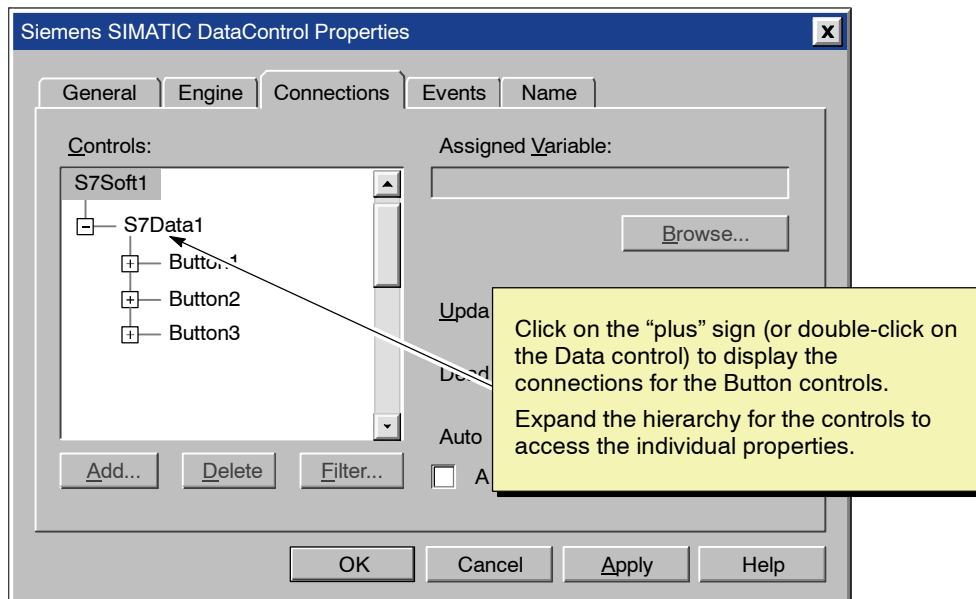

Figure 3-14 Accessing the Connections for the SIMATIC Controls

3. If the properties for Button1 are not already displayed, expand the hierarchy for Button1 and select the Value property.

You can filter the properties to display only the Value property:

- Click Filter to display the Property Filter dialog box and click Add to display the Add dialog box.
 - Enter the following text in the “Add a new property” field: **Value**
 - Click OK to add the Value property to the filter and to close the Add dialog box.
 - Click OK to add the Value property to the filter and to close the Property Filter dialog box.
 - Select (click on) the “Apply filter to properties” option to display only those properties in the filter.
4. With the Value property for Button1 selected, enter **Q0.0** in the “Assigned Variable” field. See Figure 3-15.

- Click Apply to enter the assigned variable.

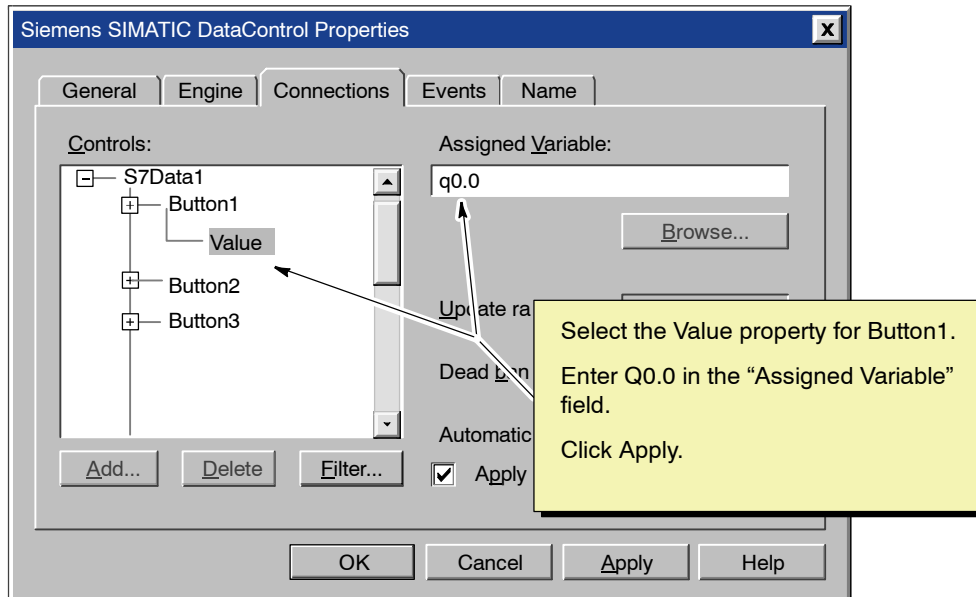

Figure 3-15 Assigning the Variable for Button1

- If the properties for Button2 are not already displayed, expand the hierarchy for Button2 and select the Value property.
- With the Value property for Button2 selected, enter **q0.1** in the "Assigned Variable" field. See Figure 3-16.
- Click Apply to enter the assigned variable.

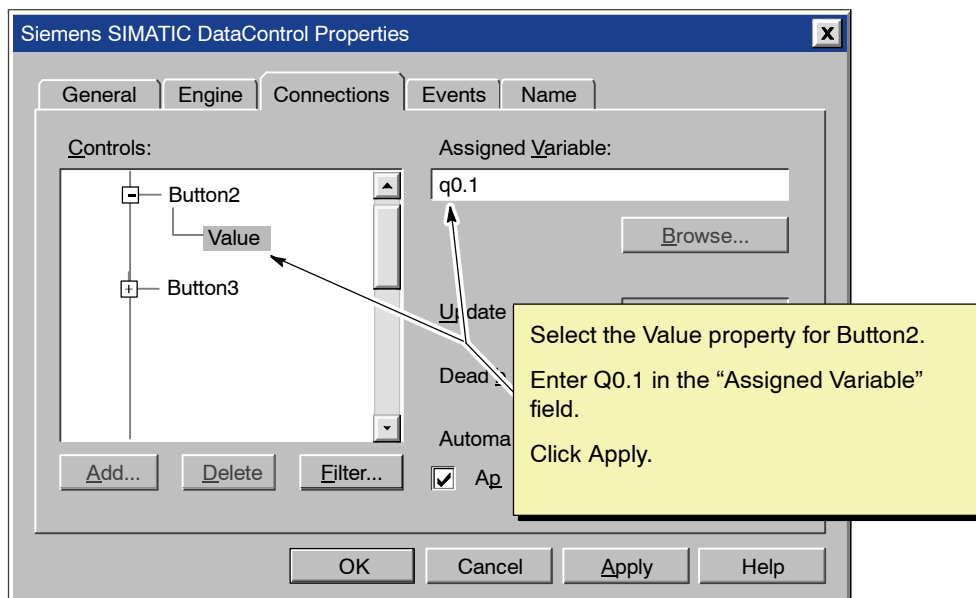

Figure 3-16 Assigning the Variable for Button2

9. If the properties for Button3 are not already displayed, expand the hierarchy for Button3 and select the Value property.
10. With the Value property for Button3 selected, enter **i0.0** in the “Assigned Variable” field. See Figure 3-17.
11. Click Apply to enter the assigned variable.

You have finished configuring the properties of the Data control. Click OK to close the Properties dialog box.

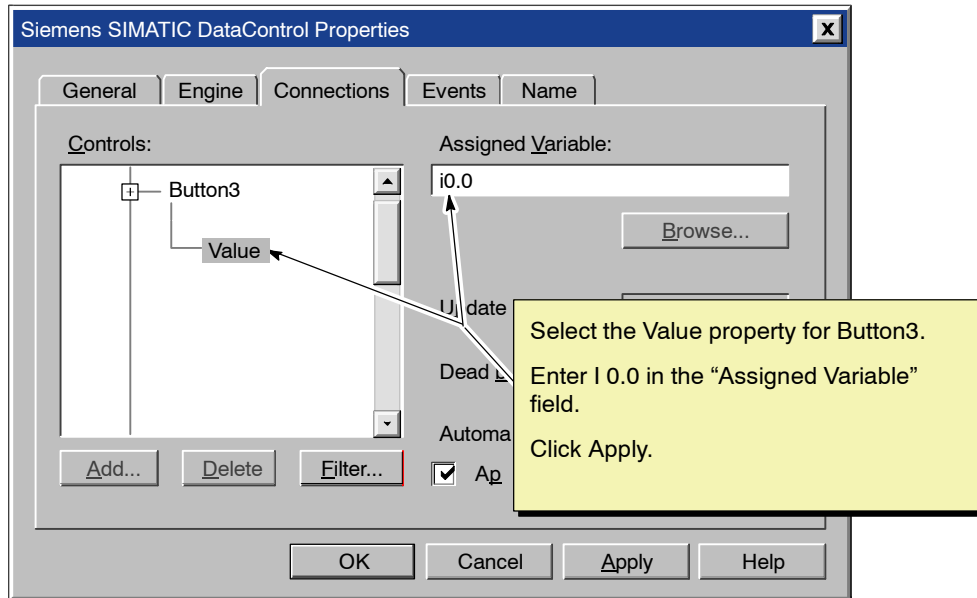

Figure 3-17 Assigning the Variable for Button3

3.6 Configuring the Button Controls on the Process Form

You use the Properties dialog box for the Button control to define the appearance of the control. For this example, you will configure the properties for two of the Button controls:

- Button control 1 (Button1):
 - When Q0.0 is off (false), the control is gray and has no caption.
 - When Q0.0 is on (true), the control is red and the caption displays: STOP!
 - If you click on this control, the value of the variable does not change.
- Button control 2 (Button2):
 - When Q0.1 is off (false), the control is gray and has no caption.
 - When Q0.1 is on (true), the control is green and the caption displays: GO!
 - If you click on this control, the value of the variable does not change.

Button control 3 (Button3) remains enabled: when you click on this control, the value of I 0.0 changes in WinLC.

Configuring the First Button Control (Button1)

The Properties dialog box for the control allows you to change the label and the color of the control for the different states of the assigned variable: True = 1 (on) and False = 0 (off). You also use this dialog box to disable the control from writing new values to the control engine.

Use the following procedure to configure the properties of the first Button control (Button1):

1. Select (click on) the Button control 1 (Button1).
2. Double-click on Button1 (or click the right mouse button to display a pop-up menu and select the **Button1 Properties** menu command) to display the Properties dialog box for the Button control.
3. Click on the General tab of the Properties dialog box to display the labels (captions) for the control.
4. As shown in Figure 3-18, modify the labels (captions) for the control:
 - In the “TrueCaption” field, replace the text with the new caption: **STOP!**
 - In the “FalseCaption” field, delete the text and leave this field blank.
5. Click on the check box for the Enabled property and deselect this property. See Figure 3-18.

(When the control is enabled, clicking on the control changes the value of the assigned variable and writes the changed value to the control engine. When you disable the control, clicking on the control does not change the value.)

6. Click Apply to enter these changes to Button1.

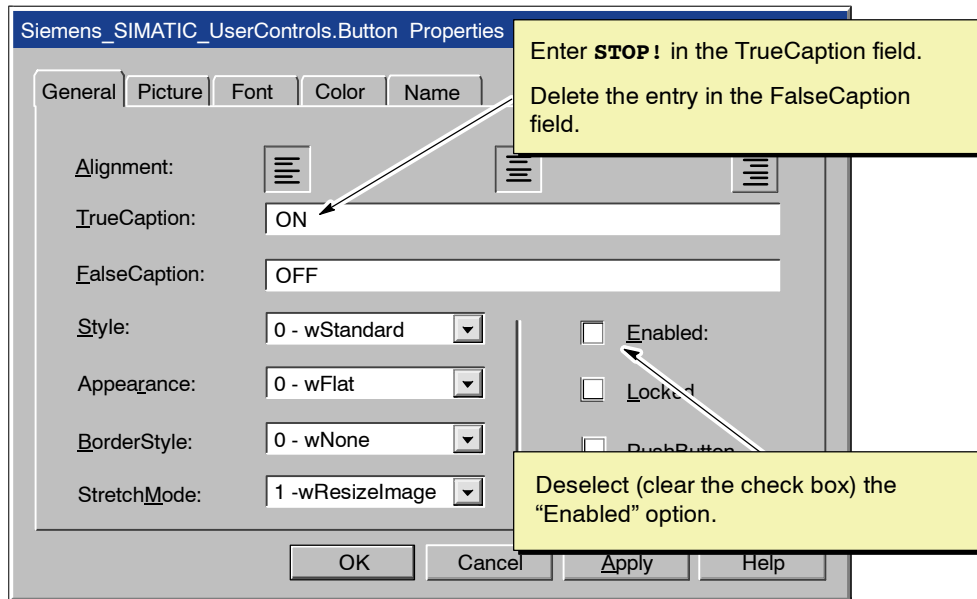

Figure 3-18 Configuring the Caption for Button1 (Button Control 1)

7. Click on the Color tab of the Properties dialog box to display the color assignments for the two states of the control (True or False).
8. Select (click on) FalseColor in the Properties box and click on the color Gray in the "Color Palette" box. See Figure 3-19.

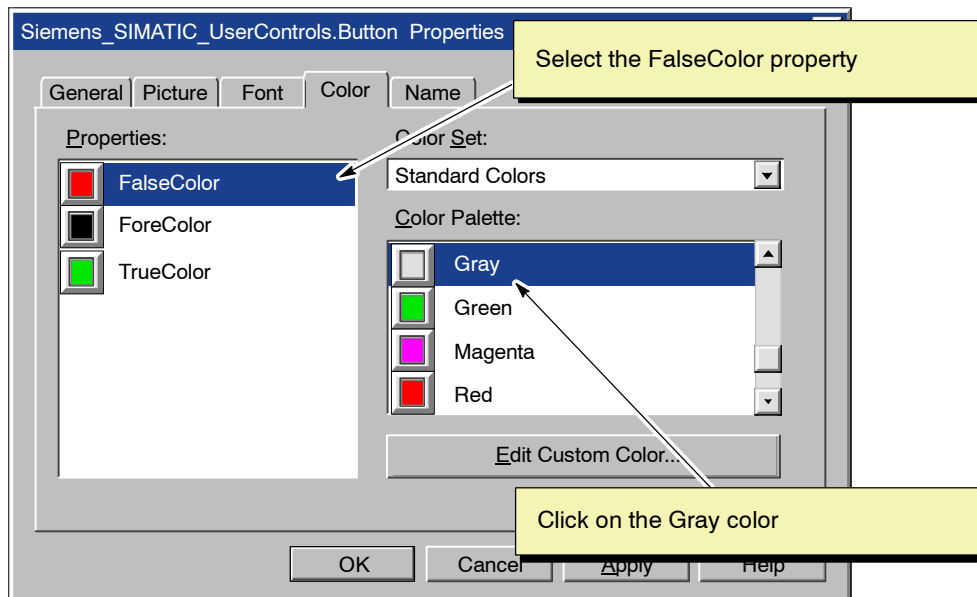

Figure 3-19 Configuring the False Color for Button1 (Button control 1)

9. Select (click on) TrueColor in the Properties box and click on the color Red in the “Color Palette” box. See Figure 3-20.
10. Click Apply to enter the changes, and click OK to close the Properties dialog box.

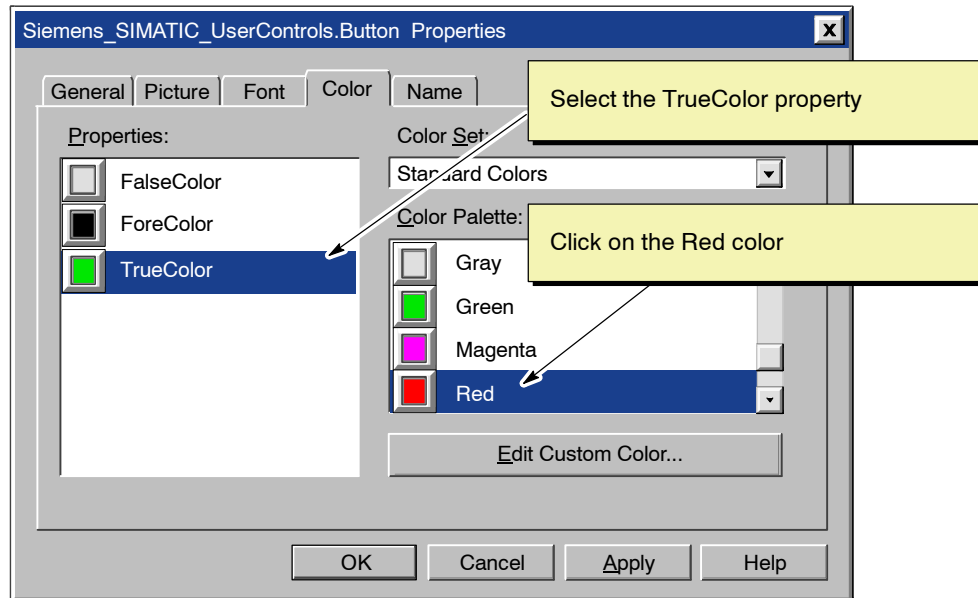

Figure 3-20 Configuring the True Color for Button1 (Button control 1)

Configuring the Second Button Control (Button2)

The second Button control is connected to Q0.1, which is the “Walk” light for the PC Station program. Use the following procedure to configure the properties of the second Button control (Button2):

1. Select (click on) the Button control 2 (Button2).
2. Double-click on Button1 (or click the right mouse button to display a pop-up menu and select the **Button2 Properties** menu command) to display the Properties dialog box for the Button control.
3. Click on the General tab of the Properties dialog box to display the labels (captions) for the control.
4. As shown in Figure 3-21, modify the labels (captions) for the control:
 - In the “TrueCaption” field, replace the text with the new caption: **WALK**
 - In the “FalseCaption” field, delete the text and leave this field blank.
5. Click on the check box for the Enabled property and deselect this property. See Figure 3-21.

- Click Apply to enter these changes to Button2.

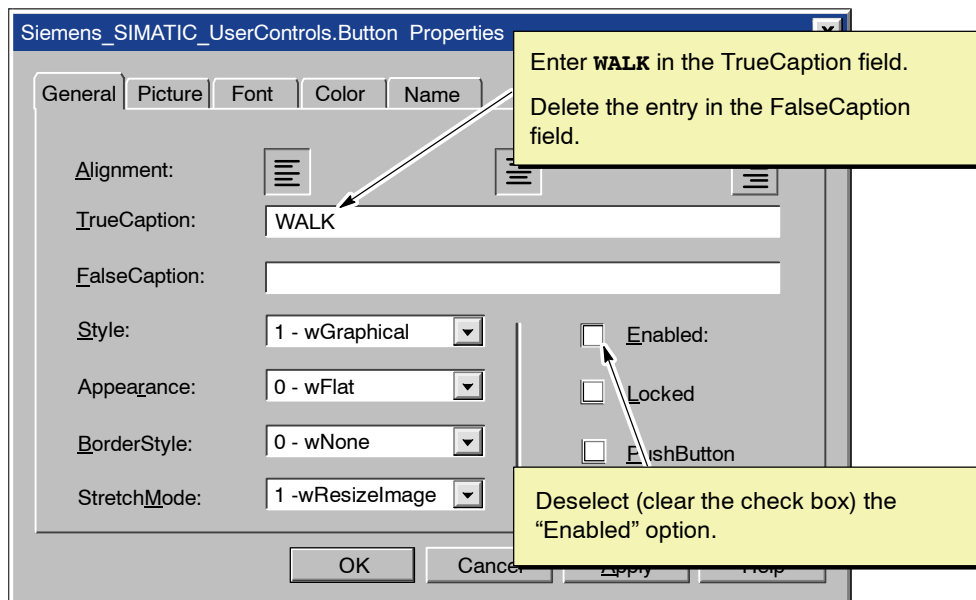

Figure 3-21 Configuring the Caption for Button2 (Button Control 2)

- Click on the Color tab of the Properties dialog box to display the color assignments for the two states of the control (True or False).
- Select (click on) FalseColor in the Properties box and click on the color Gray in the "Color Palette" box. See Figure 3-22.

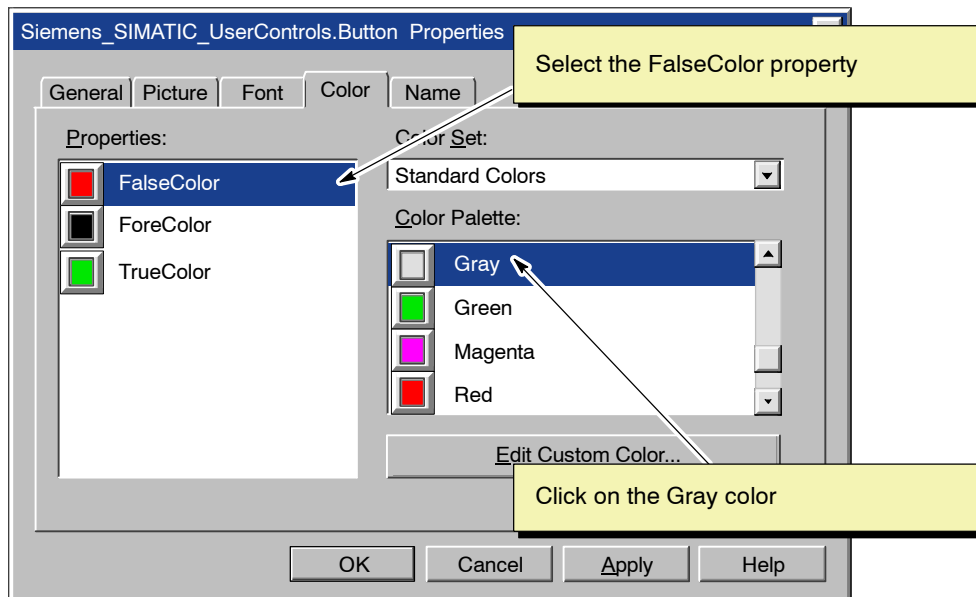

Figure 3-22 Configuring the False Color for Button2 (Button control 2)

9. Select (click on) TrueColor in the Properties box and click on the color Green in the "Color Palette" box. See Figure 3-23.
10. Click Apply to enter the changes, and click OK to close the Properties dialog box.

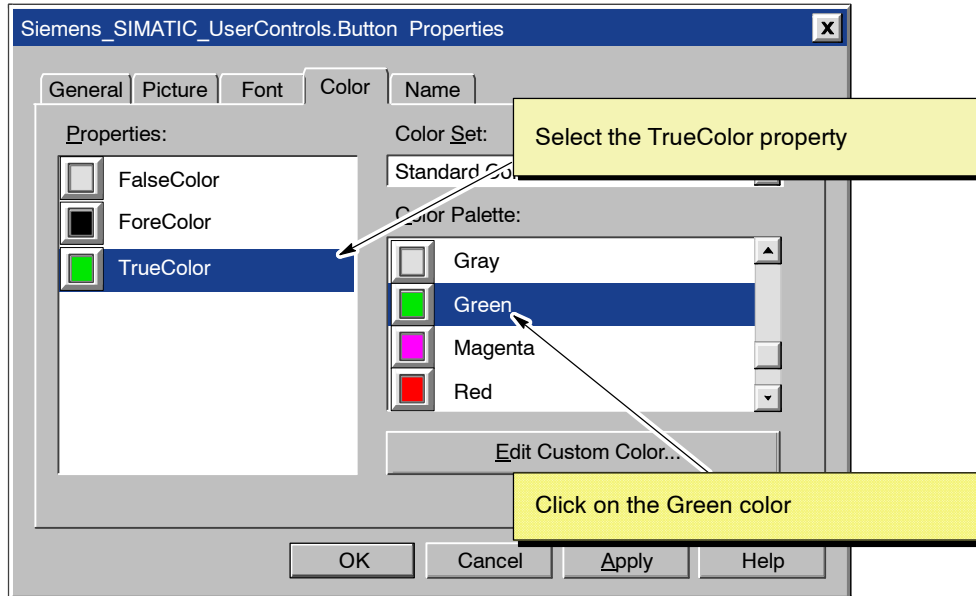

Figure 3-23 Configuring the True Color for Button2 (Button control 2)

3.7 Running the Process Form with the Sample Program

For this example, you have performed the following tasks:

- Started WinLC RTX
- Modified the sample program and downloaded the program to WinLC RTX
- Created the process form

You are now ready to run the sample program and access the data with the process form.

Setting WinLC RTX to RUN mode

To start the execution of the sample program, you set WinLC RTX to RUN mode:

1. Display the WinLC RTX control panel.
2. As shown in Figure 3-24, click RUN or RUN-P to set WinLC RTX to RUN mode. (You can also use the **CPU > RUN** or **CPU > RUN-P** menu command to change the operating mode of WinLC RTX.)

Note

In RUN mode, the controller executes the user program. You cannot download any new user program or logic blocks when the controller is in RUN mode. You can use the STEP 7 programming software to monitor (but not to modify) the variables. In RUN-P mode, the controller executes the user program. You can download new programs or logic blocks, and you can use the STEP 7 programming software to modify the variables for testing and debugging.

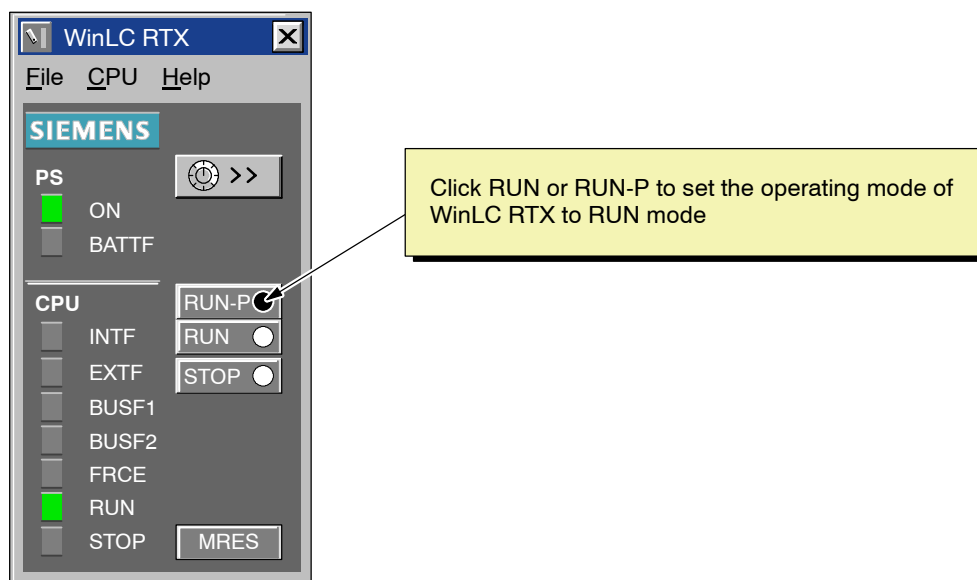

Figure 3-24 Setting WinLC RTX in RUN mode

Connecting the Process Form to the Sample Program

When you switch the container from “Design” mode to “Run” mode, you connect the process form to WinLC RTX.

Use the following procedure to connect the process form with the sample program being executed by WinLC RTX:

1. As shown in Figure 3-25, select the Run icon or use the **Mode > Run** menu command to place the SoftContainer in Run mode and connect the process form to WinLC RTX.
2. As shown in Figure 3-25, click on the button labelled “OFF” (which is Button control 3, or Button3) to start the cycles for the PC Station program.
Button control 1 (Button1) and Button control 2 (Button2) change color to reflect the status of the outputs.
3. To disconnect the process form from WinLC RTX, select the Design icon or use the **Mode > Design** menu command to return the SoftContainer to Design mode.

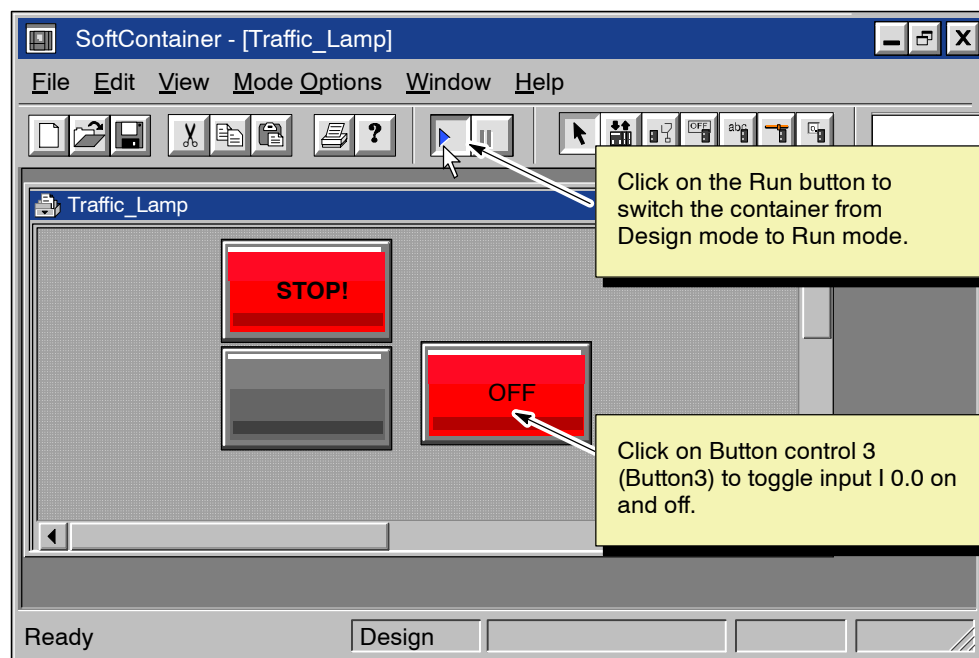

Figure 3-25 Placing the SoftContainer into Run Mode

Using the Toolmanager

4

Chapter Overview

The Toolmanager provides quick access to the programs on your computer. The Toolmanager is configurable: you can insert a shortcut icon for any of your programs into the tray. You can then access that program from the Toolmanager.

Section	Description	Page
4.1	Creating a Toolbar for Easy Access to Your Programs	4-2
4.2	Using the Toolmanager without a Mouse	4-5
4.3	Changing the Language Setting for WinAC	4-6

4.1 Creating a Toolbar for Easy Access to Your Programs

Figure 4-1 shows the Toolmanager and its shortcut icon. You can change the size of the Toolmanager. You can also choose to display the Toolmanager either horizontally or vertically.

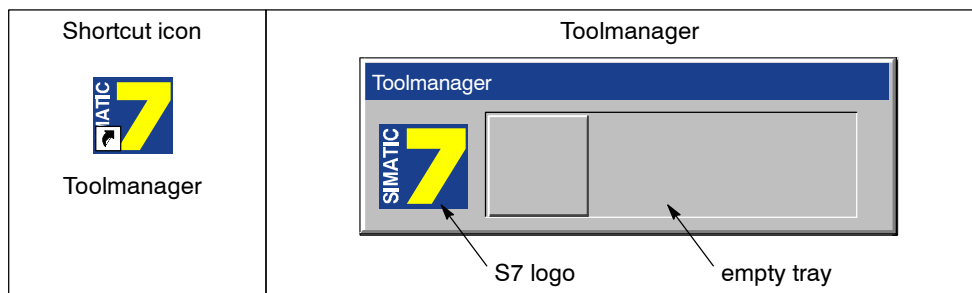

Figure 4-1 Toolmanager

Inserting Icons into the Toolmanager

There are two methods for inserting shortcut icons into the Toolmanager:

- Using the Windows Explorer to “drag and drop” the program or shortcut into the Toolmanager
- Using the **Insert** menu command of the Toolmanager (see Figure 4-2)

Note

Some shortcuts, such as the Panel application of the WinLC RTX, pass command line (cmdline) parameters. To insert a shortcut for these programs, you **must** use Windows Explorer to drag and drop the shortcut to the Toolmanager. Using the **Insert** menu command results in the command line parameter being lost.

Use the following procedure to drag and drop icons into the Toolmanager:

1. Open the Windows Explorer by selecting the **Start > Programs > Windows NT Explorer** menu command.
2. Open the Toolmanager by selecting the **Start > SIMATIC > PC Based Control > Toolmanager** menu command (or by double-clicking on the shortcut icon for the Toolmanager).
3. In the Windows Explorer, select the program or shortcut whose icon is to be inserted into the Toolmanager.

4. Holding down the left mouse button, drag the program or shortcut to the tray of the Toolmanager.
5. Release the left mouse button to drop the icon into the Toolmanager.

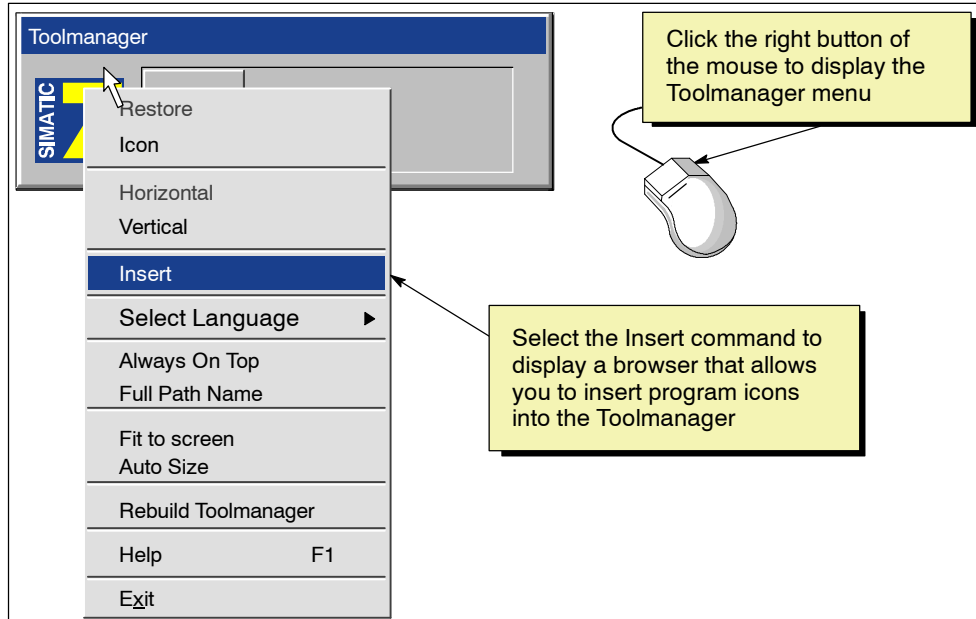

Figure 4-2 Inserting Icons into the Toolmanager

Use the following procedure to insert icons into the Toolmanager:

1. Open the Toolmanager by selecting the **Start > SIMATIC > PC Based Control > Toolmanager** menu command.
2. Click the right button of the mouse to display the menu options for the Toolmanager. See Figure 4-2.
3. Select the **Insert** menu command to display a browser for selecting program icons.
4. Select the icons from the browser and confirm.

Customizing the Display Options for the Toolmanager

You can use the mouse to resize the Toolmanager. You can also use the options menu (shown in Figure 4-2) to further customize the Toolmanager:

- Select either the **Horizontal** or **Vertical** menu command to choose the orientation for the Toolmanager.
- Select the **Always On Top** menu command to always display the Toolmanager on top of the application, instead of being hidden behind an open application.
- Select the **Auto Size** menu command to automatically size the Toolmanager to the width (or height) of the screen.
- Select the **Full Path Name** menu command to display the path name for the shortcut icons.
- Select the **Rebuild Toolmanager** menu command to update (refresh) the icons for existing program or to remove the icons for programs that have been removed or deleted.

Pressing the F1 key or selecting the **Help** menu command displays the online help for the Toolmanager.

4.2 Using the Toolmanager without a Mouse

Table 4-1 lists the specific keyboard operations for various key combinations. You can use the keyboard to access all of the functions of the Toolmanager:

- Pressing the F1 key displays the online help for the Toolmanager.
- Pressing the Tab key changes the focus between the S7 logo and the shortcut icons. If the Toolmanager is running, pressing the ALT + Tab keys displays the Toolmanager.
- Pressing the Return key when a shortcut icon has the focus starts the associated program.

Table 4-1 Keyboard Operations for the Toolmanager

Key Combination	Description
Tab	Displays the Windows Taskbar: tab to the S7 logotype to give Toolmanager the focus
Alt + Tab	Alternates the focus between the S7 logotype and the selected shortcut icon
When focus is on the S7 logotype...	
Page Up or Page Down	Displays the Toolmanager in a horizontal or vertical orientation
Left arrow or Right arrow	Displays the application menu when the Toolmanager is oriented vertically
Shift + (Left or Right arrow)	Move the Toolmanager left or right
Cntl + (Left or Right arrow)	Moves the Toolmanager to the left or right edge of the screen
Alt + (Left or Right arrow)	Stretches or shrinks the Toolmanager when the Toolmanager is oriented horizontally (Not available in Auto Size mode)
Up arrow or Down arrow	Displays the application menu when the Toolmanager is oriented horizontally
Shift + (Up or Down arrow)	Moves the Toolmanager up or down
Cntl + (Up or Down arrow)	Moves the Toolmanager to the top or bottom edge of the screen
Alt + (Up or Down arrow)	Stretches or shrinks the Toolmanager when the Toolmanager is oriented horizontally (Not available in Auto Size mode)
Enter	Minimizes or restores the Toolmanager
When focus is on a shortcut icon...	
Home or End	Sets focus to the first or last shortcut icon
Enter	Runs the application of the shortcut icon that has focus
Delete	Deletes the shortcut icon that has focus
Left arrow or Right arrow	Toolmanager is horizontal: Moves the cursor left or right Toolmanager is vertical: Displays the icon menu
Up arrow or Down arrow	Toolmanager is horizontal: Displays the icon menu Toolmanager is vertical: Moves the cursor left or right

4.3 Changing the Language Setting for WinAC RTX

The Toolmanager provides a menu command for changing the language setting for all of the WinAC RTX software products. You can select between English, French and German for the menus and dialog boxes of the WinAC RTX software (if all languages were installed when you installed WinAC RTX).

Use the following procedure to change the language setting:

1. Open the Toolmanager by selecting the **Start > SIMATIC > PC Based Control > WinAC RTX Toolmanager** menu command (or by double-clicking on the shortcut icon for the Toolmanager).
2. Click the right button of the mouse to display the menu options for the Toolmanager. See Figure 4-3.
3. Select the **Select Language** menu command to display the menu for selecting the language for WinAC RTX. See Figure 4-3.
4. Select the language for WinAC RTX.
5. Restart your applications to change the language for the menus and dialog boxes for the WinAC RTX software.

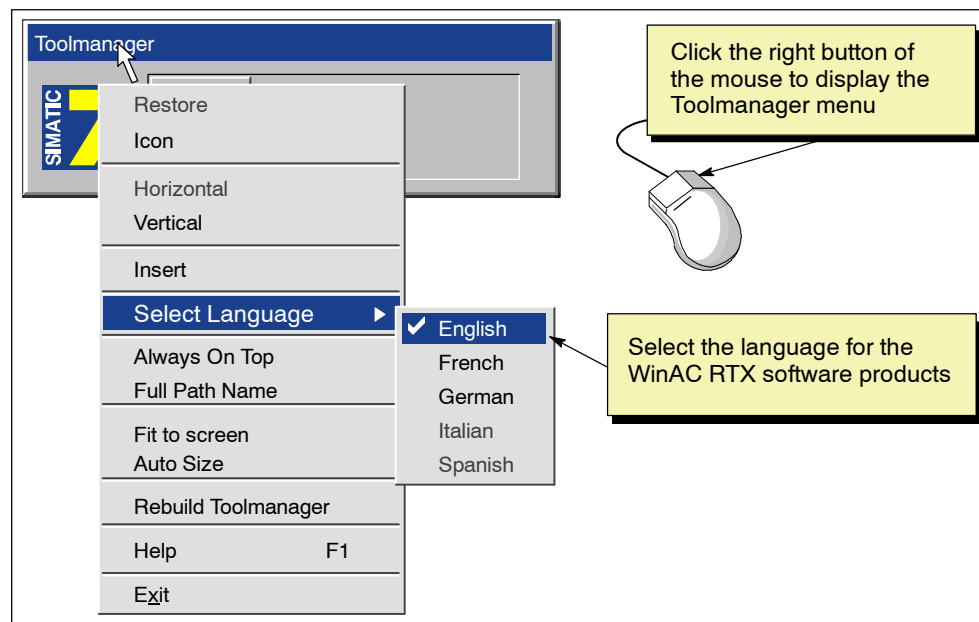

Figure 4-3 Changing the Language for WinAC RTX

Distributed Component Object Model (DCOM)

A

Chapter Overview

WinAC RTX allows you to communicate across networks using Microsoft's Distributed Component Object Model (DCOM). You can use DCOM to integrate distributed applications by way of a network. A distributed application consists of multiple processes or different computers that cooperate to accomplish a single task.

DCOM is a set of Microsoft concepts and program interfaces in which client program objects can request services from server program objects on other computers in a network. The Component Object Model (COM) provides a set of interfaces that allow clients and servers to communicate within the same computer (running Windows 95 or Windows NT).

Section	Description	Page
A.1	Using DCOM to Expand the Capabilities of WinAC RTX	A-2
A.2	Connecting to a Specific Control Engine over DCOM	A-4

A.1 Using DCOM to Expand the Capabilities of WinAC RTX

You can run the components of WinAC RTX on a stand-alone computer, as shown in Figure A-1. In this model, this computer provides the complete control system.

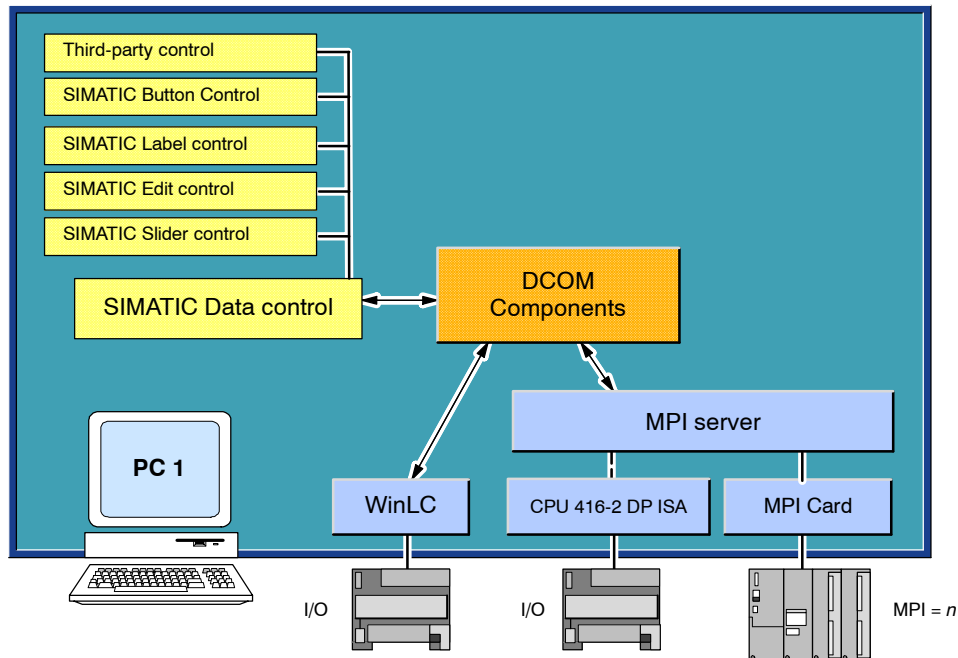

Figure A-1 Using WinAC Components with DCOM on a Single Computer

You can also utilize Microsoft's DCOM technology to create a network of computers that cooperate to provide the control system for a machine or process. Figure A-2 shows how one computer running an application that uses ActiveX controls (from Computing) can use DCOM to communicate with a different computer that uses WinLC (or other PLCs) to control a process.

The NT operating system provides a configuration tool (dcomcnfg) for setting up your DCOM security. Use this tool to configure the server and client computers.

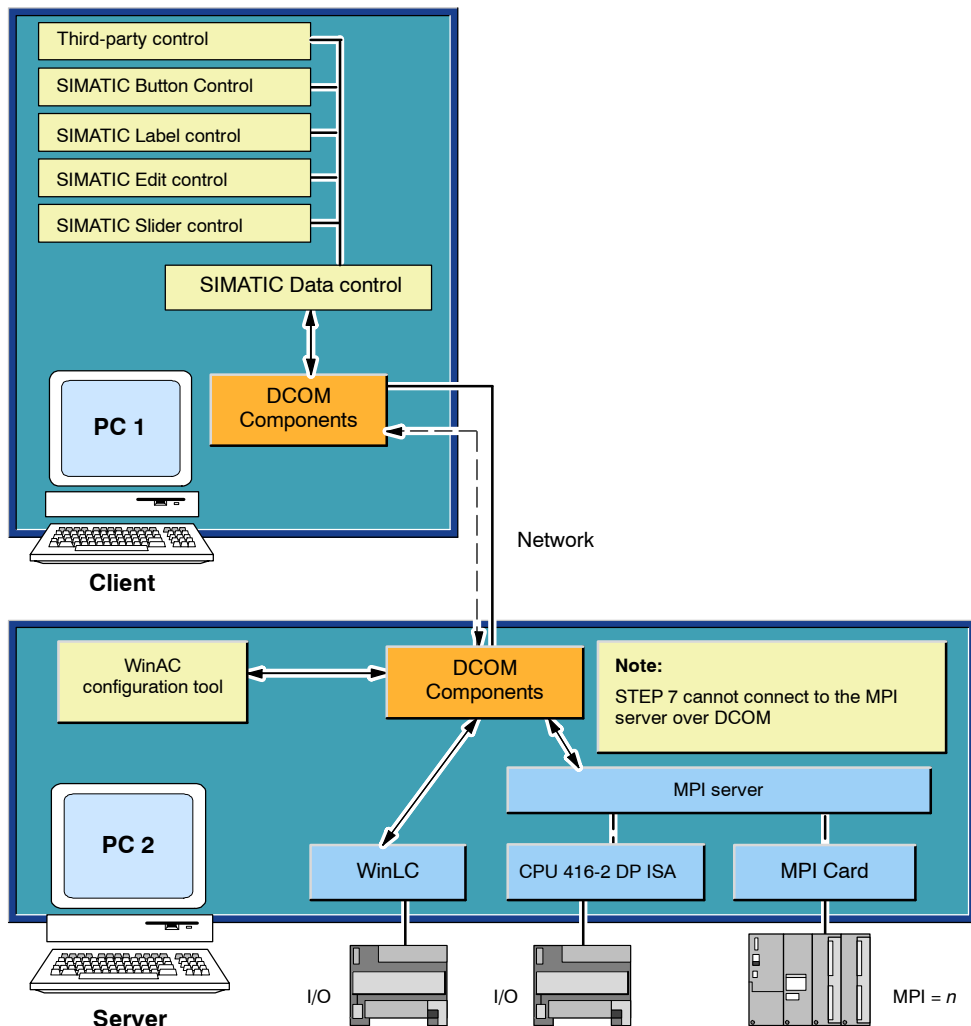

Figure A-2 Using WinAC RTX with Several Computers over DCOM

Note

You install the WinAC RTX authorization on the server computer; you install the SIMATIC Computing authorization on the client computer. If you want to run SIMATIC Computing on a PC other than the PC running WinLC, then you must purchase SIMATIC Computing standalone. For more information about installing an authorization, see Section 2.4.

A.2 Connecting to a Specific Control Engine over DCOM

As shown in Figure A-3, you can use the SIMATIC Data control to connect your program to a control engine residing on a different computer.

Note

When you configure the SIMATIC Data control to connect directly to a single control engine, you cannot connect a tag file. This means that you cannot use symbol names for the variables in the control engine.

To use symbol names, select the option for connecting via a tag source and browse to a tag file that contains symbols for only one control engine. Use the TagFile Configurator for creating tag files and connecting to control engines over DCOM. See the *Computing User Manual* for information about using STEP 7 and the TagFile Configurator.

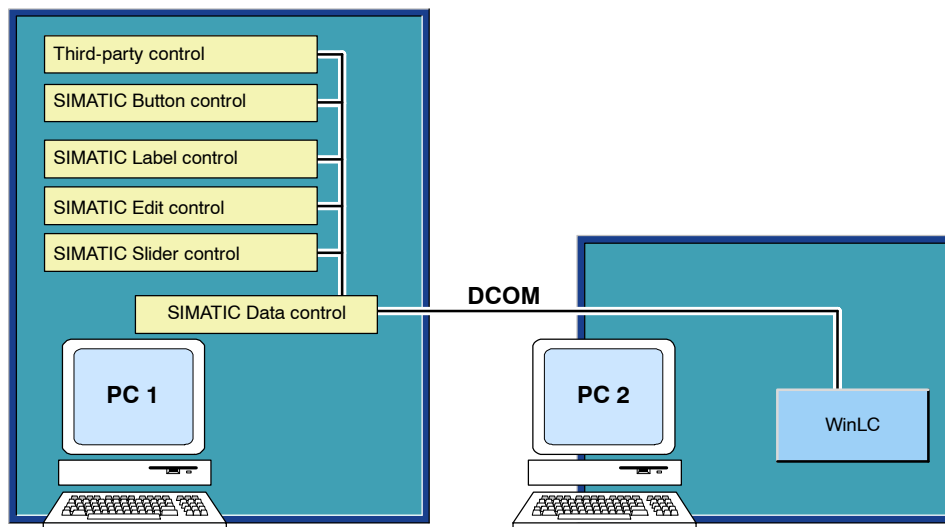

Figure A-3 Connecting to a Specific Control Engine over DCOM

B

OLE for Process Control (OPC)

Chapter Overview

OLE for Process Control (OPC) provides a standard mechanism for communicating to numerous data sources, whether they be the devices on your factory floor or a database in your control room. You can use the OPC server provided with the SIMATIC Computing software to communicate with the control engine (for example, WinLC RTX or CPU 416-2 DP ISA) and provide access to the process data. SIMATIC Computing provides an OPC server that allows any OPC client application to access data in the control engine; SIMATIC Computing does not provide any OPC client application.

SIMATIC Computing implements the mandatory interfaces, as defined in the version 2.0 specification from the OPC Foundation, and also implements the IOPC BrowseServerAddressSpace interface.

OPC is based on the OLE/COM technology from Microsoft. For more information about OPC, refer to the OPC specification *OLE for Process Control Data Access Standard, version 2.0* from the OPC Foundation.

Section	Description	Page
B.1	Using OPC with SIMATIC Computing	B-2

B.1 Using SIMATIC OPC with Computing

OPC allows you to access data from the plant floor and integrate the data into your existing business systems. You can use off-the-shelf tools (such as SCADA packages, databases, spreadsheets) to assemble a system that meets your needs. As shown in Figure B-1, OPC provides an open and effective communication architecture which concentrates on data access and not the types of data.

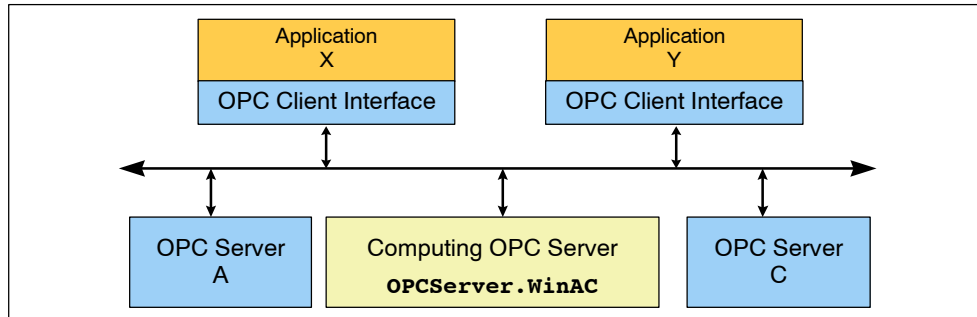

Figure B-1 Applications Working with Many OPC Servers

Your OPC client connects to the OPC server object provided by SIMATIC Computing. This connection allows you to create and manipulate OPC group objects, which organize the data to be accessed. You can activate or deactivate a group as a unit, or you can “subscribe” to the list in a group of items so that you can be notified when the data change. (A group is a collection of items.) Figure B-2 shows the connection from the OPC client application through WinAC RTX to the process data.

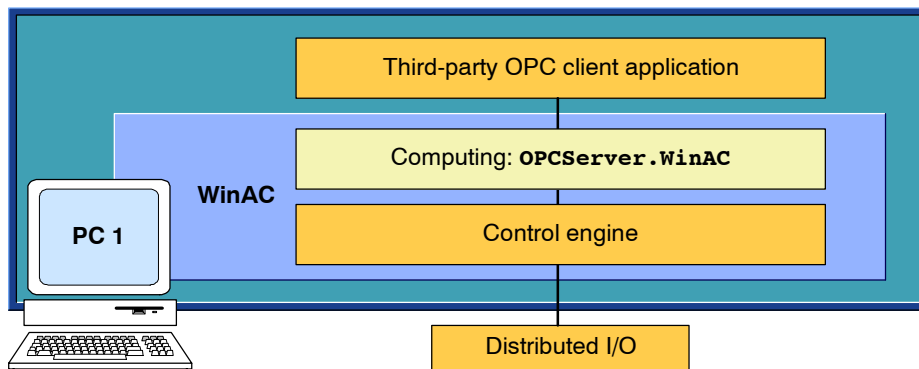

Figure B-2 Using the OPC Server to Access Your Process Data

To access the OPC server provided by the SIMATIC Computing software, browse to: **OPCServer.WinAC**

Index

A

Accessing process data (OPC), B-2
Authorization, 2-6–2-7
Authorizing the WinLC software, transferring the authorization, 2-7

B

Blue screen (unrecoverable fault in Windows NT), 1-3

C

Client application (OPC), B-2
Communicating (DCOM), A-1–A-4
Communications Processor (CP), 2-8
Component Object Model (COM), A-1–A-4
Components of WinAC, communications processor (CP), 2-8
Computer requirements, 2-2
Configuring WinLC, 3-9–3-10
Control panel (WinLC), 3-4
CP 5613 card, installation notes, 2-10–2-11
Crash operations (OB84), 1-3

D

Databases (OPC), B-2
Display options for Toolmanager, 4-4
Distributed applications (DCOM). *See* Distributed Component Object Model (DCOM)
Distributed Component Object Model (DCOM), A-1–A-4
Downloading a program, 3-12–3-13
Drivers for CP 5613, 2-10–2-11

G

Guidelines
CP 5613 card, 2-10–2-11
installing WinLC, 2-9
removing WinAC Basis, 2-5
transfer authorization, 2-5

H

Hardware configuration (WinLC), 3-9

I

Inserting a STEP 7 station, 3-8–3-9
Inserting icons into Tool Manager, menu command, 4-3
Inserting icons into Toolmanager, 4-2
Installation
authorization, 2-6–2-7
CP 5613 notes, 2-10–2-11
installing WinLC, 2-9
removing WinAC Basis, 2-5
Setup program, 2-3–2-5
system requirements, 2-2
Integrating distributed applications (DCOM), A-1–A-4
Interrupt mode (CP 5613), 2-10–2-11
Interrupt Request number (IRQ), 2-10–2-11

K

Keyboard (Toolmanager), 4-5–4-6

L

Language setting, Toolmanager, 4-6

M

Menu (Toolmanager), 4-3

N

Network communications (DCOM), A-1–A-4

NT service (WinLC), 2-9

O

OB84, Operations when Windows NT crashes, 1-3

OLE (OPC specification), B-1

OLE for Process Control (OPC), B-1

OPC server name, B-2

Opening a STEP 7 project, 3-6–3-7

P

Polled mode (CP 5613), 2-10–2-11

Program

 downloading, 3-12–3-13

 hardware configuration (WinLC), 3-9–3-10

 inserting a station, 3-8–3-9

 opening a STEP 7 project, 3-6–3-7

R

Removing WinAC Basis, 2-5

Requirements for installation

 authorization, 2-6–2-7

 computer, 2-2

Running WinLC as an NT service, 2-9

S

Server object (OPC), B-2

Setup program, 2-3–2-5

SIMATIC 300 station, WinLC I/O configuration, 3-8

SIMATIC NET, drivers for CP 5613, 2-10–2-11

Specification (OPC), B-1

Starting WinLC, 3-4

STEP 7

 configuring WinLC, 3-9–3-10

 downloading a sample program, 3-12–3-13

 inserting a station, 3-8–3-9

 opening a sample project, 3-6–3-7

System requirements, 2-2

T

Tool Manager, inserting icons, 4-2

 menu command, 4-3

Toolmanager

 display options, 4-4

 keyboard operations, 4-5–4-6

 language options, 4-6

 menu, 4-3

U

Uninstalling WinAC Basis, 2-5

Unrecoverable fault in Windows NT, 1-3

W

WinAC

 handling crashes, 1-3

 installing WinLC, 2-9–2-10

 OB84, 1-3

WinAC Basis

 configuring WinLC, 3-9–3-10

 downloading a program, 3-12–3-13

 inserting a STEP 7 station, 3-8–3-9

 opening a STEP 7 project, 3-6–3-7

 removing the software, 2-5

 Setup program, 2-3

Windows Logic Controller. *See* WinLC

Windows NT Crash, 1-3

WinLC

 components, 2-8–2-9

 drivers for CP 5613, 2-10

 handling crashes, 1-3

 Installation, CP 5613, 2-10–2-11

 installation, 2-8–2-9

 NT service, 2-9

 OB84, 1-3

 special notes, 2-9

To

SIEMENS ENERGY & AUTOMATION INC
ATTN: TECHNICAL COMMUNICATIONS M/S 519
3000 BILL GARLAND ROAD
PO BOX 1255
JOHNSON CITY TN USA 37605-1255

From

Name: -----
Job Title: -----
Company Name: -----
Street: -----
City and State: -----
Country: -----
Telephone: -----

Please check any industry that applies to you:

- | | |
|---|---|
| <input type="checkbox"/> Automotive | <input type="checkbox"/> Pharmaceutical |
| <input type="checkbox"/> Chemical | <input type="checkbox"/> Plastic |
| <input type="checkbox"/> Electrical Machinery | <input type="checkbox"/> Pulp and Paper |
| <input type="checkbox"/> Food | <input type="checkbox"/> Textiles |
| <input type="checkbox"/> Instrument and Control | <input type="checkbox"/> Transportation |
| <input type="checkbox"/> Non-electrical Machinery | <input type="checkbox"/> Other _____ |
| <input type="checkbox"/> Petrochemical | |



