

GAMMA instabus

Switching/dimming actuator 2x DALI Broadcast

N 525D11

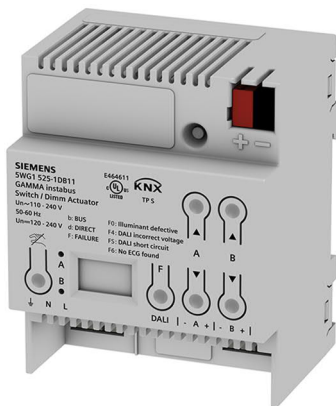

Switching/dimming actuator N 525D11, 2x DALI Broadcast is used for switching and dimming two independent DALI lines (channels). This device can also control the brightness and color temperature of lamps at the same time.

- Broadcast control of electronic control gear (ECG) with 2 independent DALI lines (channels)
- Up to 20 devices can be connected to each channel.
- Direct mode (switching and dimming) for a simple check of the installation
- Display element for error messages of the DALI installation

Functions with configuration with ETS:

- Extensive control, override and diagnostic functions for each channel
- Configurable dimming curve and various fade times for optimal dimming
- Independent color temperature control that is also integrated into scenes and overrides
- Control value input for analog values can be configured as an alternative to the switching input
- Integrated 8-bit scene control and assignment of each output to up to 8 scenes
- Switching cycle counting with threshold monitoring for switching cycles
- Counting of operating hours with threshold monitoring of operating hours

Characteristics

Switching/dimming actuator N 525D11, 2x DALI Broadcast is a KNX device with two DALI outputs (channels). Up to 20 devices can be connected per channel. Switching/dimming actuator N 525D11, 2x DALI Broadcast is a rail-mounted device for installation in distributions. For DALI, the electronics of the DALI devices are fed via the DALI bus line. Hence, the device has an integrated power supply for AC 230 V for supplying the device electronics and generating the DALI bus voltage for each channel.

The device is used to connect and control a group of dimmable lamps in parallel, e.g. if individual communication with each individual DALI device is not necessary.

In addition, the device can record and transfer status and error messages of DALI lines but not individual DALI devices.

The device can control the brightness of the lamps as well as the color temperature in parallel ("tunable white"). The device can therefore be used in human-centric lighting applications.

Functions

Building site function

The building site function provided ex-factory enables switching the building site lighting on and off via bus wall switches and actuators, even if these devices have not yet been commissioned with the Engineering Tool Software (ETS).

Direct mode

After installation, the individual channels of the device can be tested directly on the device. Prior configuration via the software is not necessary for this.

In the delivery state, direct mode is activated without a time limit.

After configuration, direct mode is limited to the configured time limit.

Display and error messages

The device's display shows the error codes of the error messages from DALI lines and information on normal mode and direct mode. The display also shows error messages (even with the factory settings).

The following error messages are displayed:

- F0: Lamps defective
- F4: External voltage on DALI line
- F5: Short circuit of DALI line
- F6: No ECG found
- "." (Dot in the bottom right corner): The application cannot be started

Communication objects are created for the individual error messages.

Resetting the device to factory settings

A very long push of the programming button of more than 20 seconds resets the device to its factory settings. This is indicated by a uniform flashing of the programming LED for 8 seconds.

All configuration settings are deleted. The building site function of the delivery state is re-activated.

Operating modes

Each output (channel) of the switching/dimming actuator may be set to one of the following operating modes:

- Normal mode
- Timer mode
- Timer mode 2-fold
- Flashing

Dimming curve

The dimming curve acts like a correction factor. Lamps can therefore be dimmed brighter or darker in the medium dimming range, for example, to optimally adjust fluorescent lamps to the dimming behavior of incandescent lamps.

The following settings are possible:

- **Smooth 2:** Curve (1)
- **Smooth 1:** Curve (2)
- **Linear:** Curve (3)
- **Progressive 1:** Curve (4)
- **Progressive 2:** Curve (5)
- **Progressive 3:** Curve (6)
- **User-defined:**

With this setting the parameter card “dimming curve user-defined” is displayed. Here, the dimming curve can be defined manually by entering up to 16 values for the x-axis (dimming value) and y-axis (brightness).

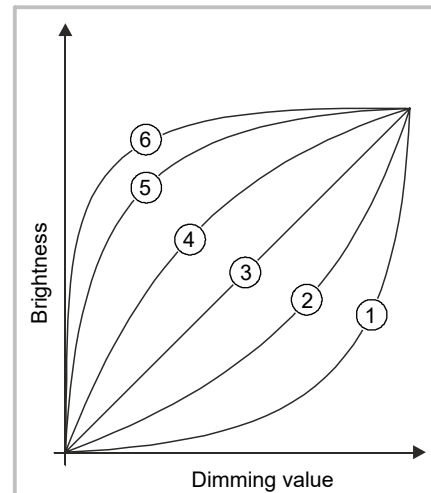

Color temperature control

The color temperature control is defined in standard DALI IEC 62386, in chapter 209 “Color Control.” The ECG is defined as device type 8. Device type 8 refers to color controllable lights. The color temperature is measured in Kelvin (K).

Switching/dimming actuator N 525D11, 2x DALI Broadcast can control the color temperature and brightness of ECG of device type 8.

The device can be used in human-centric lighting application because it can control the color temperature of a DALI LED from warm white to cold white (“tunable white”).

Human-centric lighting (HCL) expands the concept of biologically effective lighting with holistic planning and covers the visual, emotional and biological effects of light. HCL supports human health, well-being and performance in the long-term.

Control value input

As an alternative to the switching input, there is also a control value input for each channel. The control value input can be used to implement analog values in switching on/off commands. A threshold value can also be set.

The following datapoint types are possible:

- 5.001 percent (0 ... 100 %)
- 5.010 counting impulses (0 ... 255)
- 9.001 temperature °C
- 9.004 illuminance lx
- 9.021 current mA
- 9.024 output kW
- 14.056 output W

Timer functions

When configuring the device with ETS, two different timers and night mode can be programmed. It is possible to set e.g. delayed switching on/off as well as a warning before switching off occurs.

Dimming

Two different dimming values are available for each channel.

In addition, a minimum and maximum dimming value can be set via a communication object. In particular with LED and energy saving lamps, these parameters can be used to optimize dimming behavior in the lower dimming range.

The communication object “global dimming” can be used to temporarily or permanently limit the maximum dimming value, e.g. to save energy.

Central switching

The “central switching” function contains an object for each channel. With this object, switch telegrams are received which are then sent to the associated output using a different time function than the one for the communication object “switching.”

Error messages

Display and error messages [→ 2]

8-bit scene control

Using 8-bit scene control, current brightness values or switching states can be assigned to a scene and activated again later through the scene.

Overrides

Up to seven different override function blocks can be activated via ETS to override the automation functions:

- Manual override (ON)
- Permanent OFF
- Lock
- Central override
- User-defined override function
- Forced control

Logic operations

This parameter can be used, if necessary, to add an additional switching object “logic operation 1” to the switching of the output via a logic operation of the switching object. The logic operation object is not subject to any time delay, i.e. the logic operation is always in effect immediately. The following logic operations are possible:

- AND
- OR
- XOR
- FILTER
- TRIGGER

Switch cycle and operating hours count

To monitor use, the right configuration makes it possible to count and display the switch cycles and operating hours of the device.

Behavior on mains voltage failure/recovery

In case of a mains voltage failure, the current status and other values for each output are permanently saved so that they can be restored on mains voltage recovery.

On mains voltage recovery, the configured actions are executed and, if applicable, new statuses are reported.

Behavior on unloading the application program

After “unloading” the application program with the ETS, the unloaded device has no functions.

If the programming button is pushed for more than 20 seconds, the device is reset to its factory settings.

Schematic design of a dimming channel

The following schema illustrates the listed functions in a logical overview.

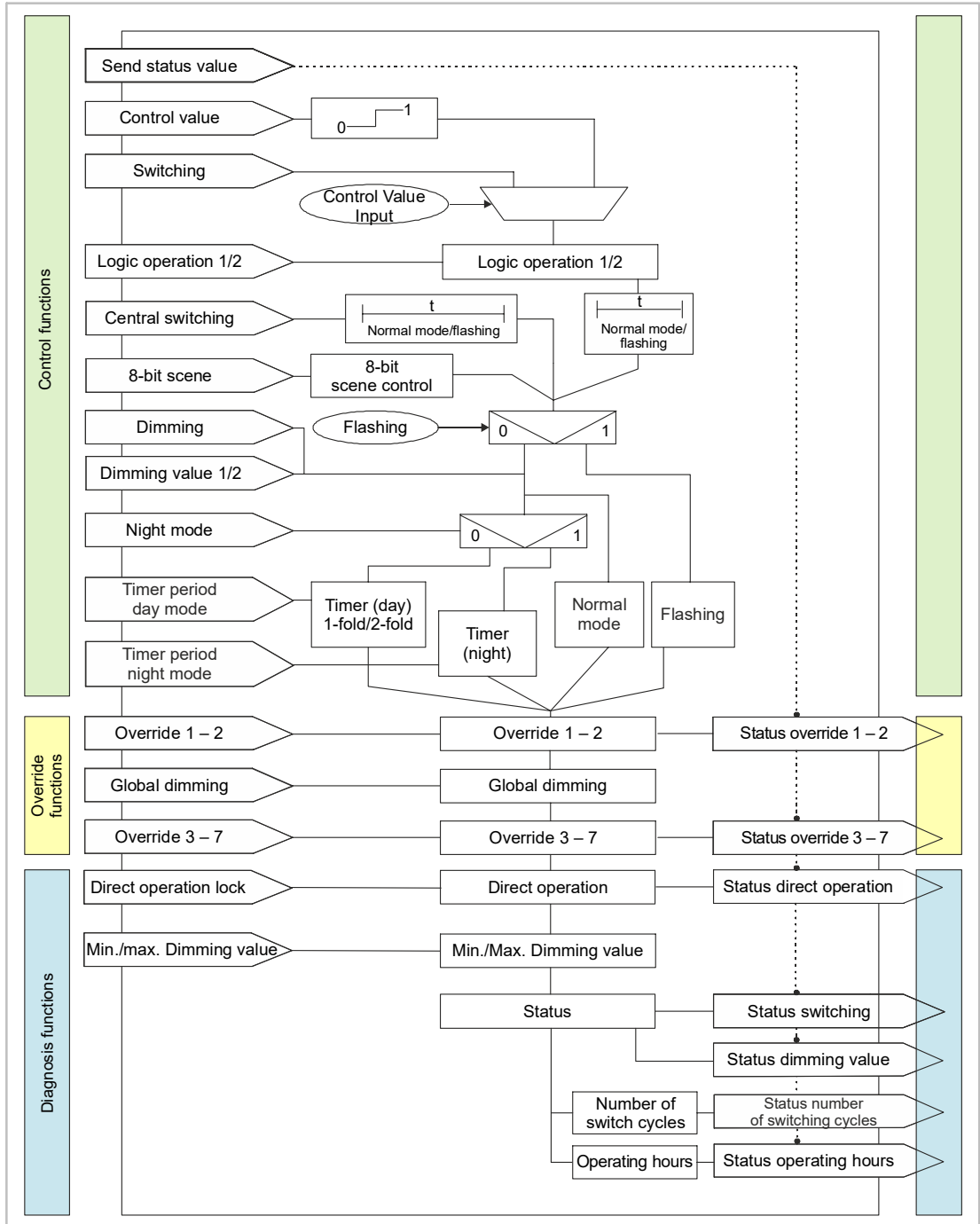

Schematic design of a dimming channel

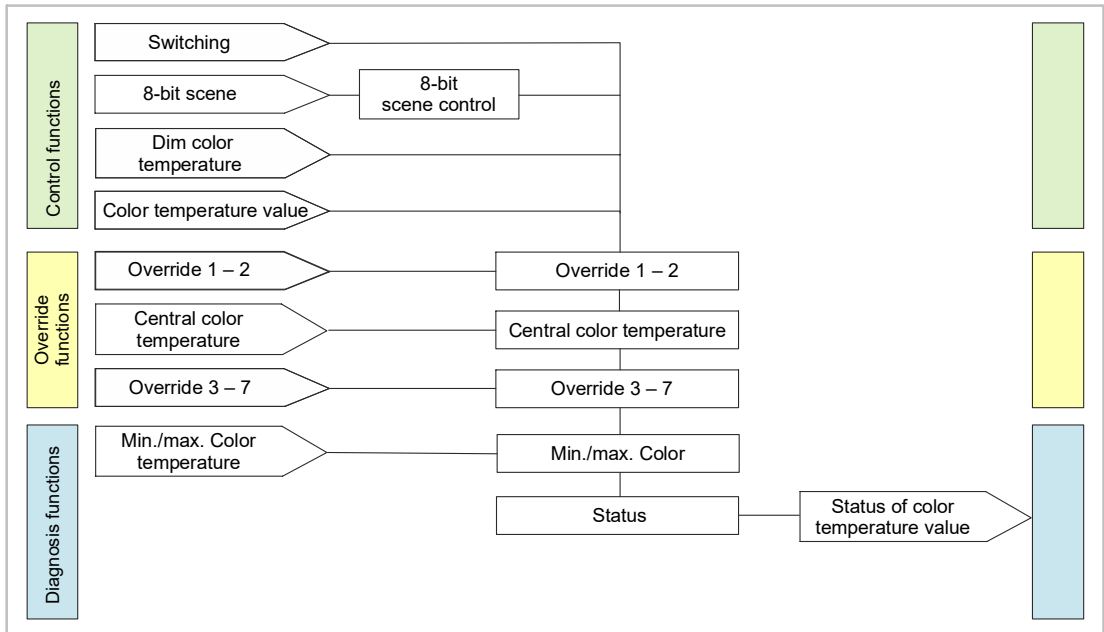

Flow chart for color temperature control

Technology

Position and function of the operating and display elements

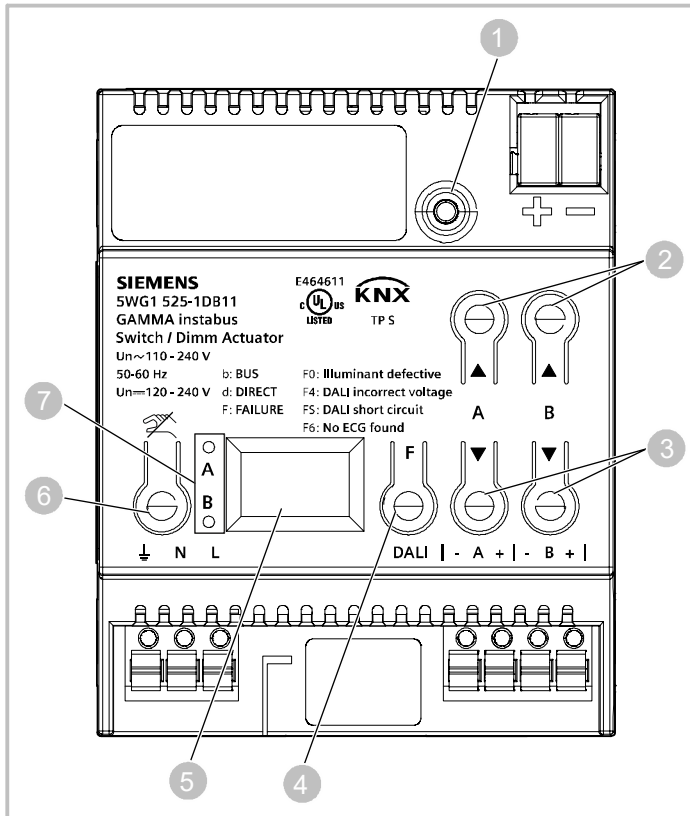

User interface with operating and display elements

| Pos. | Operating or display elements | Function |
|------|--|---|
| 1 | Programming LED (red), Programming button | Short push of button (< 2 s): <ul style="list-style-type: none"> • Activate programming mode, display status (LED on = active). Very long push of button (> 20 s): <ul style="list-style-type: none"> • Reset to factory settings (after 20 s, the LED starts flashing for about 8 s). |
| 2 | Button: Switch on, dim brighter, channel A or B in direct mode | Short push of button (< 1 s): <ul style="list-style-type: none"> • Switch on channel A or B and • activate direct mode for channel A or B. Long push of button (> 1 s): <ul style="list-style-type: none"> • Dim channel A or B brighter and • activate direct mode for channel A or B. If direct mode is activated, a "d" is shown on the display. |
| 3 | Button: Switch off, dim darker, channel A or B in direct mode | Short push of button (< 1 s): <ul style="list-style-type: none"> • Switch off channel A or B and • activate direct mode for channel A or B. Long push of button (> 1 s): <ul style="list-style-type: none"> • Dim channel A or B darker and • activate direct mode for channel A or B. |
| 4 | Button: Show error codes | If an error occurs on a channel, the first character shown on the display is an "F" (failure). In addition, the LED of the respective channel flashes in short intervals. Short push of button (< 1 s): <ul style="list-style-type: none"> • Show error code. • In case of several errors, push the button several times until "Fb" (failure in bus operation) or "Fd" (failure in direct operation) is displayed again. |
| 5 | Display | Shows information on the device and errors. |
| 6 | Button: Deactivate direct mode | Short push of button (< 1 s): <ul style="list-style-type: none"> • Deactivate direct mode for all channels. Keep pushing the button and briefly push the button 'Switch on, dim brighter' or 'Switch off, dim darker' channel A or channel B: <ul style="list-style-type: none"> • deactivate direct mode for channel A or B. |
| 7 | LED (red), once each for channel A and channel B | Display switching state (On/Off) of the respective channel. <ul style="list-style-type: none"> • LED lit: Channel switched on (dimming value > 0). • LED off: Channel switched off (dimming value = 0). • LED lights up with brief interruptions: Channel switched on in direct mode. • LED flashing: Channel switched off in direct mode. |

Type overview

| Type | Description | Article number | KNX PL-Link |
|----------|---|----------------|-------------|
| N 525D11 | Switching/dimming actuator, 2x DALI Broadcast | 5WG1525-1DB11 | Yes |

Version of the Engineering Tool Software

| Application | Version |
|---------------------------------|----------------|
| Engineering Tool Software (ETS) | ETS 5 or above |

Disposal



Defective devices can be returned to the appropriate sales office with a return delivery note. To do this, contact support: Product documentation and support [→ 8]

Product documentation

Documents belonging to the product, such as operating and assembly instructions, application description, product database, additional software and CE declarations can be downloaded from the following website:

<http://www.siemens.com/gamma-td>



Frequently asked questions

For frequently asked questions regarding the product and their solutions, see:

<https://support.industry.siemens.com/cs/ww/en/ps/faq>



Support

Contact details for additional questions relating to the product:

Tel.: +49 911 895-7222

Fax: +49 911 895-7223

Email: support.automation@siemens.com

<http://www.siemens.com/supportrequest>



Security

| | |
|---|--|
|  | <p>⚠ CAUTION</p> |
| | <p>National safety regulations Failure to comply with national safety regulations may result in personal injury and property damage.</p> <ul style="list-style-type: none"> • Observe national provisions and comply with the appropriate safety regulations. |

| | |
|---|---|
|  | <p>⚠ WARNING</p> |
| | <ul style="list-style-type: none"> • The device should only be installed and put into operation by a certified electrician. • Ensure that the device can be activated. • Do not open the casing of the device. • Secure the phase with a B6 or C6 line protection switch. |

Installation

Switching/dimming actuator N 525D11, 2x DALI Broadcast can be used for fixed installations in interior spaces, for installations in dry locations, within distribution boards or small casings on DIN rails EN 60715-TH35.

Commissioning

Connecting the power supply

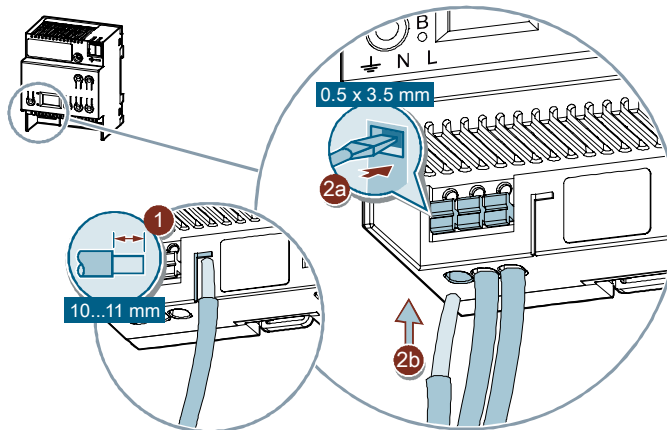

Connecting the power supply

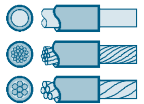
| | |
|---|---|
| Cu |  |
|  | 0.5 ... 2.5 mm ² AWG 20 (0.75 mm ²) ... AWG 12 (3.3 mm ²) ... |

Connecting DALI

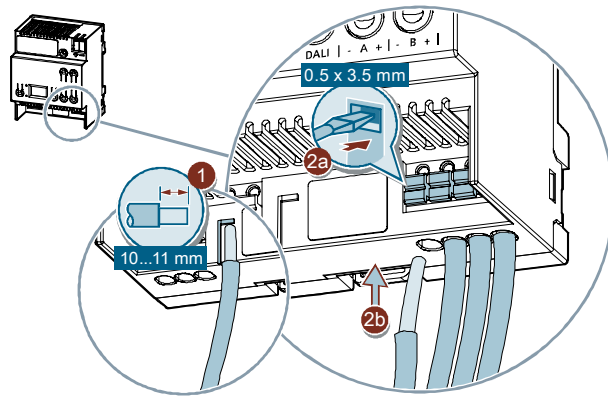

Connecting DALI

| | |
|----|--|
| Cu | |
| | 0.5 ... 2.5 mm ² |
| | AWG 20 (0.75 mm ²) ... AWG 12 (3.3 mm ²) ... |

Connecting KNX

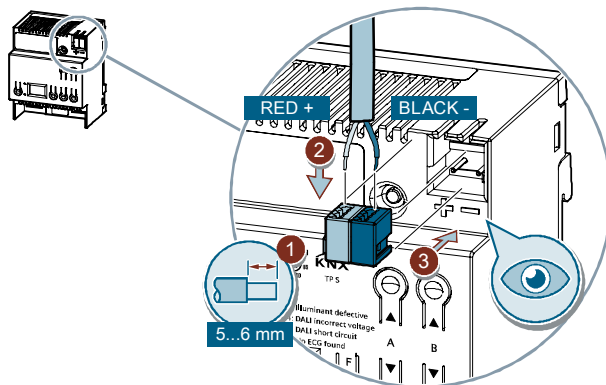

Connecting KNX

| | |
|----|--|
| Cu | |
| | 0.6 ... 0.8 mm |
| | AWG 20 (0.75 mm ²) ... AWG 18 (1.0 mm ²) ... |

KNX test

This test can be used to check whether the bus connection cable is connected with the correct polarity and whether device is supplied with bus voltage.

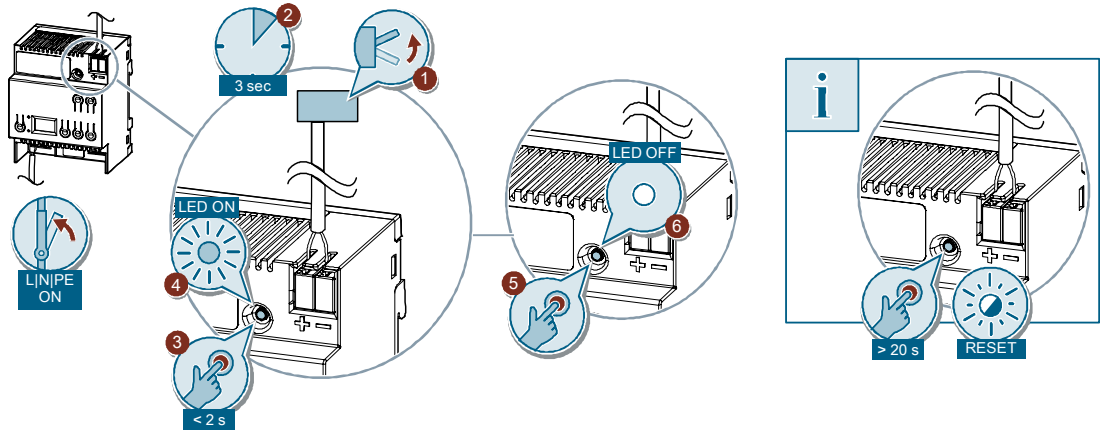

KNX test

If the programming button is pushed for more than 20 seconds, the device is reset to its factory settings.

Operation in direct mode

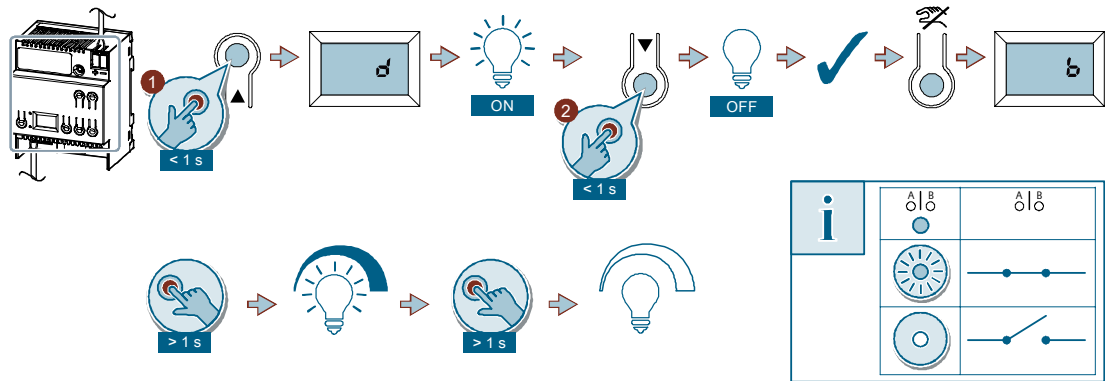

Operation in direct mode

Error display

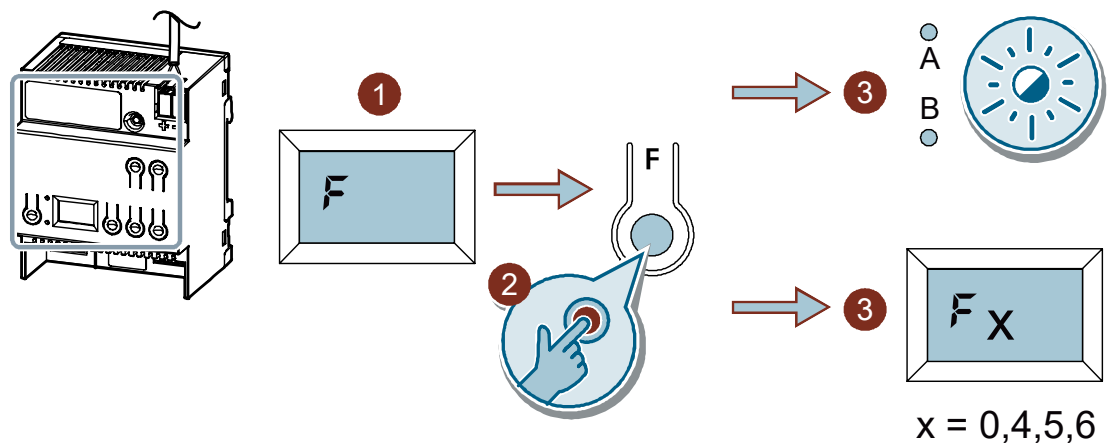

Error display

| F0 | F4 | F5 | F6 |
|----------------|-------------------|--------------------|--------------|
| Lamp defective | Incorrect voltage | DALI short circuit | No ECG found |

Technical data

| Power supply | |
|-----------------------------------|------------------------|
| KNX bus voltage | DC 24 V (DC 21...30 V) |
| KNX power consumption | 5 mA |
| Power loss (internal consumption) | 1.6 W |
| Operating voltage | |
| Nominal value | 230 V |
| Rated value AC | 110 V...240 V |
| Rated value DC | 120 V...240 V |

| Inputs/outputs | |
|--------------------------------------|--|
| Power connection | 3-pole (earth, N, L) |
| DALI outputs as per IEC 62386 | 2 channels with max. 20 DALI ECG per channel (max. 2 mA each) with > 8 kOhm input impedance |
| DALI power supply per channel | approx. DC 19 V, potential-free, short circuit-proof max. power: $I_{max} = 250$ mA max. guaranteed power: $I_{max} = 40$ mA |
| DALI line length for copper at 25 °C | 2.5 mm ² (AWG 14) max. 300 m (328 yd) 1.5 mm ² (AWG 16) max. 300 m (328 yd) 1.0 mm ² (AWG 18) max. 224 m (225 yd) The power loop resistance for each connected ECG must not be more than 10 Ohm. |

| Connections | |
|--|---|
| Plug terminals for mains voltage and DALI interface, bare wire length 10...11 mm* (0.39...0.43 in) | Permissible conductor cross-section 0.5...2.5 mm ² solid 0.5...2.5 mm ² stranded 0.5...2.5 mm ² fine-stranded, untreated AWG 20 (0.75 mm ²) – AWG 12 (3.3 mm ²) solid, stranded |
| KNX bus | Bus terminal block |

* The mains supply line to the device must be protected by a circuit breaker of characteristic B or C for a max. rated current of 6 A.

| Physical specifications | |
|-------------------------|----------------------------------|
| Housing material | Plastic |
| Dimensions | 4 TE (= 18 mm) Dimensions [→ 13] |
| Weight (device) | approx. 180 g (0.3968 lb) |
| Fire load | 4 MJ |

| Environmental conditions | |
|------------------------------------|-----------------------------------|
| Ambient temperature in operation | -5 °C...+45 °C (23 °F...113 °F) |
| Storage temperature | -20 °C...+70 °C (-4 °F...158 °F) |
| Transport temperature | -25 °C...+70 °C (-13 °F...158 °F) |
| Relative humidity (non-condensing) | 5 %...90 % |
| Climatic resistance | EN 50491-2 |
| Environmental rating | EN 60721-3-3 class 3k5 |

| Protection settings | |
|---|---------------------------------------|
| Degree of pollution (according to IEC 60664-1) | 2 |
| Overtoltage category (according to IEC 60664-1) | III |
| Protection type IP | IP20 |
| Electrical safety, bus | Safety extra low voltage SELV DC 24 V |
| Electrical safety, device fulfills | EN 50428 |
| EMC requirements, device complies with | EN 50428 |

| Reliability | |
|------------------------|---------|
| Failure rate (at 40°C) | 419 fit |

Dimensions

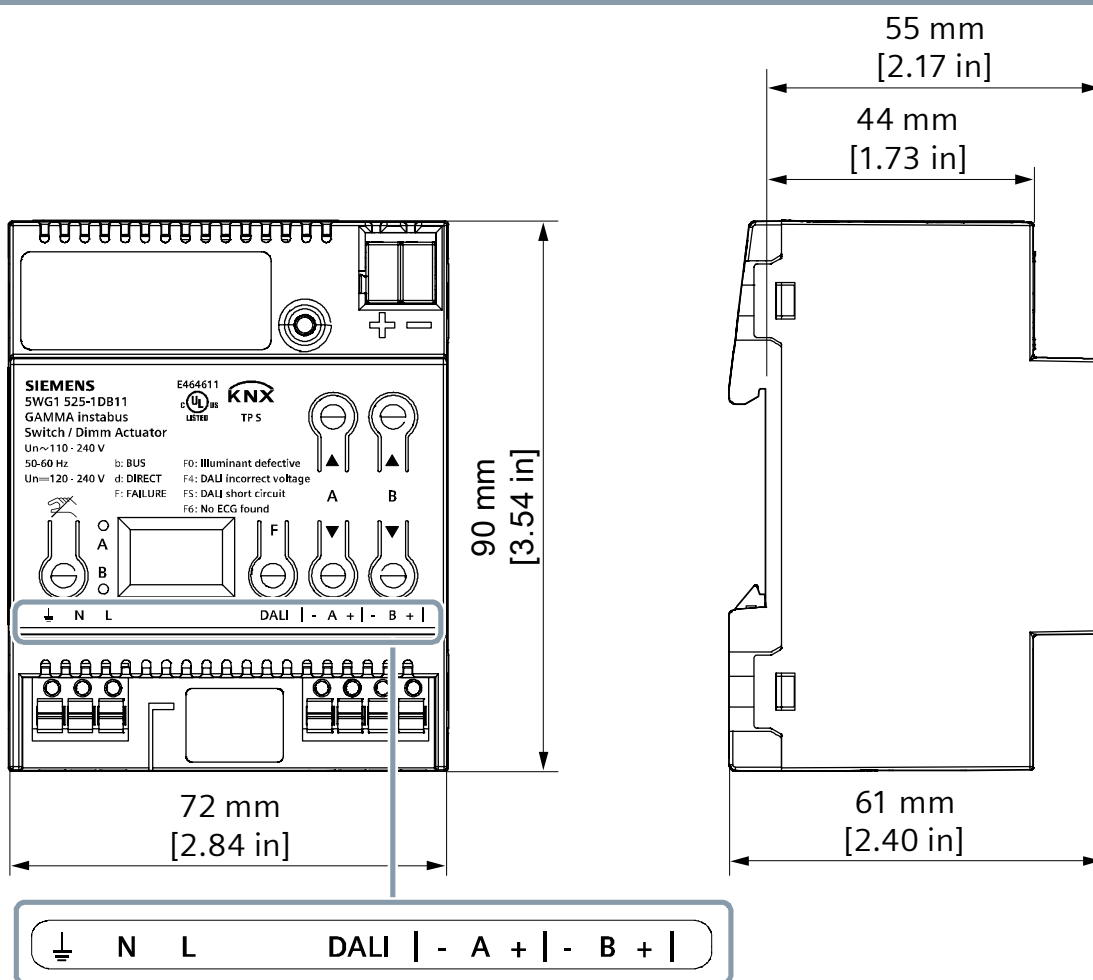

Dimensions

