

SIEMENS

SIMATIC

FIELD ENGINEERING
PACKAGE

System Overview

Foreword, Contents

Part 1: Field Engineering Package

Introduction **1**

Components of the field engineering
package **2**

Description of the optional components **3**

Catalog data **4**

**Part 2: Configuring and
startup**

Installation guidelines **5**

Hardware configuring (example) **6**

Software configuring (example) **7**

Appendices

References **A**

Index **B**

Glossary **C**

Safety instructions

This manual contains instructions to be observed for your personal safety and to avoid damage. The instructions are emphasized with a warning triangle and take the following form, according to the degree of danger:

Danger

This means that failure to observe the appropriate precautions will result in death, serious injury or considerable damage.

Warning

This means that failure to observe the appropriate precautions can result in death, serious injury or considerable damage.

Caution

This means that failure to observe the appropriate precautions can result in slight injury or damage.

Note

This is important information relating to the product, handling of the product or the part of the documentation to which particular attention must be paid.

Qualified personnel

Startup and operation of equipment may only be carried out by qualified personnel. In the context of the safety instructions of the manual, qualified personnel are persons authorized to place the equipment, systems and circuits in operation according to the safety standards, to ground them and mark them.

Normal use

Observe the following:

Warning

These products may only be used for the applications intended in the catalog and in the technical description, and only in association with non-Siemens devices and components recommended or approved by Siemens. Perfect and reliable operation of the product requires proper transportation and storage, setting up and installation as well as careful operation and maintenance.

Trademarks

SIMATIC® ,SITRANS®, PDM® and SINEC® are registered trademarks of SIEMENS AG.

Other designations in this publication may be trademarks whose utilization by third parties for their own purposes may infringe the holders' rights.

Contents

Part 1 The field engineering package

1	INTRODUCTION	1—1
1.1	Positioning of the field engineering package in the SIMATIC systems	1—2
1.2	PROFIBUS as the universal field bus	1—7
1.2.1	PROFIBUS-DP	1—7
1.2.2	PROFIBUS-PA	1—8
1.3	PROFIBUS components	1—9
1.3.1	Transition from PROFIBUS-DP to PROFIBUS-PA	1—9
1.3.2	PROFIBUS-PA configuration with SIMATIC S5	1—11
1.3.3	PROFIBUS-PA configuration with SIMATIC S7	1—11
1.4	HART functions	1—12
2	OVERVIEW OF THE COMPONENTS OF THE FIELD ENGINEERING PACKAGE	2—1
2.1	Introduction	2—2
2.2	Hardware components	2—2
2.2.1	PROFIBUS-PA	2—2
2.2.2	HART	2—3
2.3	Configuring the field engineering	2—5
3	COMPONENTS OF THE FIELD ENGINEERING PACKAGE IN DETAIL	3—1
3.1	Hardware	3—2
3.1.1	DP/PA coupler	3—2
3.1.2	DP/PA link	3—3
3.1.3	HART modules	3—4
3.1.3.1	Two-channel analog input module	3—4
3.2	Software/configuration	3—6
3.2.1	Configuration/project scope	3—6
3.2.2	Addressing of PROFIBUS-PA field devices	3—7
3.2.3	Parameter assignment / device profiles	3—9
3.2.4	Device database (GSD) and device descriptions (DD)	3—12
3.2.5	Driver function blocks for the field engineering package	3—13
4	CATALOG DATA	4—2
4.1	Ordering data for the field engineering package	4—3
4.2	Cross-references to detailed catalogs	4—3
4.3	Positioning in the information environment	4—4

Part 2 Configuring and startup

5 INSTALLATION GUIDELINES	5-1
5.1 Introduction	5-2
5.2 Mechanical and electrical installation	5-6
5.2.1 Installing the cables	5-6
5.2.2 Cable routes within and outside buildings	5-6
5.2.3 Cable specifications and cable recommendation for PROFIBUS-DP	5-8
5.2.4 Cable specifications and cable recommendation for PROFIBUS-PA	5-9
5.2.5 Shielding concept	5-11
5.2.6 Grounding and equipotential bonding	5-13
5.2.7 Lightning protection	5-13
5.2.8 Connectors	5-14
5.2.9 Installation materials and tools	5-15
5.3 Guidelines of the PNO (PROFIBUS Users' Organization)	5-16
6 HARDWARE CONFIGURING (PROJECT EXAMPLE)	6-1
6.1 Configuring a station	6-3
6.1.1 Creating a station and starting the hardware configuration	6-4
6.1.2 Configuring the station	6-5
6.1.3 Loading the hardware configuration into a CPU	6-7
6.2 PROFIBUS-DP distributed I/O	6-8
6.2.1 Inserting a DP slave in a station	6-8
6.2.1.1 Device database (GSD files)	6-8
6.2.1.2 Using a SITRANS P via a DP/PA coupler	6-9
6.2.1.3 Using an ET 200M with a HART module	6-10
6.3 Station diagnostics	6-11
6.4 SITRANS P parameter assignment with SIMATIC PDM	6-12
7 SOFTWARE CONFIGURING (PROJECT EXAMPLE)	7-2
7.1 Project example: Control loop (CFC)	7-3
7.2 Project example: Sequential control system with two-step control (SFC)	7-6

Introduction

1

This chapter contains:

1.1 Positioning of the field engineering package in the SIMATIC systems	1-2
1.2 PROFIBUS as the universal field bus	1-7
1.2.1 PROFIBUS-DP	1-7
1.2.2 PROFIBUS-PA	1-8
1.3 PROFIBUS components	1-9
1.3.1 Transition from PROFIBUS-DP to PROFIBUS-PA	1-9
1.3.2 PROFIBUS-PA configuration with SIMATIC S5	1-11
1.3.3 PROFIBUS-PA configuration with SIMATIC S7	1-11
1.4 HART functions	1-12

1.1 Positioning of the field engineering package in the SIMATIC systems

General

The new field engineering is designed for use in the SIMATIC S5, SIMATIC S7 and SIMATIC PCS 7 systems. The PCS 7 system is given priority in this overview because the entire performance range of the field bus components can be used conveniently in PCS 7. SIMATIC PCS 7 is the new Siemens process control system for the automation of industrial and production processes. Shown in Table 1-2 are the possible applications of the individual components.

Components

The SIMATIC family comprises the following SIMATIC main components:

- SIMATIC S5, S7 and PCS 7 automation systems
- SIMATIC HMI - the human-machine interface systems: (such as operator stations and operator terminals based on WinCC)
- SIMATIC NET - the communications basis consisting of PROFIBUS and Industrial Ethernet
- SIMATIC NET DP - the PROFIBUS-DP field bus system for distributed I/O and PROFIBUS-DP compatible field devices
- SIMATIC PA - the PROFIBUS-PA field bus system as an extension of the PROFIBUS-DP field bus system to include the optimized transmission system for applications in the intrinsically safe and non-intrinsically safe areas
- SIMATIC Industrial Software (e.g. engineering system with STEP 7 and SIMATIC Manager for SIMATIC S7 and PCS 7)

Hardware and software requirements

At least the following releases must be available in order to use the field engineering package:

Unit/software package	Software release
SIMATIC Step 7	from V 4.02
SIMATIC WinCC	from V 4.02
COM PROFIBUS	from V 3.1
SIMATIC PC S7	from V 4.02

Table 1-1: Basic requirements for the field engineering package

Conformity

Activities serving the interaction of components in the overall SIMATIC system are presented in various conformity classes. They offer different degrees of convenience and functionality in configuring and operation. The control system functionality of the PCS 7 system with its special control-related activities and tools for selected components offers a maximum of system performance and convenience for the user. This is shown in Table 1-2:

SIMATIC Base	SIMATIC S 5	SIMATIC S 7	SIMATIC PCS 7	
Components of option package				I/O area
COM PROFIBUS	X	-	-	
Drivers	-	(X)	X	Part 1 Manual
HW-Config	-	X	X	
SIMATIC PDM	-	X	X	
HART	-	(X)	X	
DP/PA LINK	-	X	X	
DP/PA COUPLER	X	X	X	Part 2 Manual
Continuous processes	-	X	X	
Discontinuous processes	-	X	X	

(X) Restricted performance level (no standard software components)

Table 1-2: Possible applications of the individual field bus components

Positioning in the system

The field engineering package is positioned at the lowest level of the automation systems.

- PROFIBUS-PA forms the communications channel between control level, automation system and field device over great distances with minimum overhead.
- HART modules provide the information channel for the HART protocol between control level and field devices with HART protocol.
- SIMATIC PDM is a convenient configuring and parameter assignment system for field devices with PROFIBUS-PA connection or the HART protocol.

Shown in Figs 1-1 to 1-4 is the positioning in an automation system as an example.

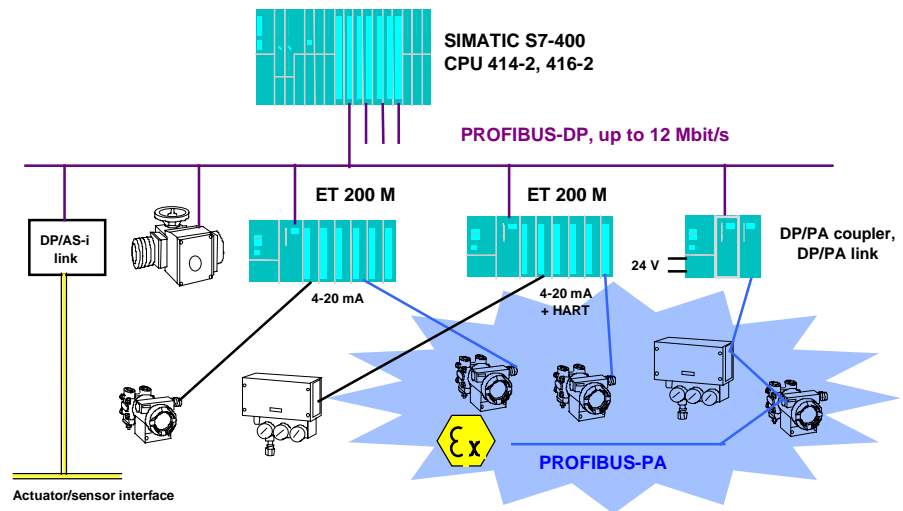

Fig. 1-1 Positioning of the new field device systems in the I/Os of the SIMATIC automation system

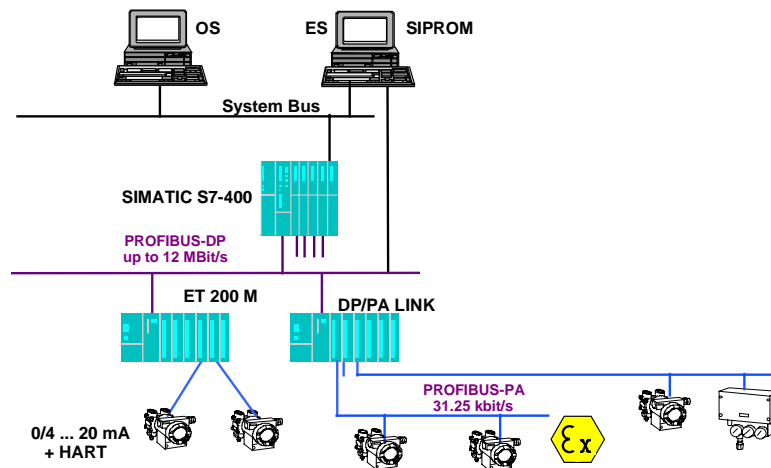

Fig. 1-2 Positioning of the PROFIBUS-PA field bus system and HART I/O modules in the SIMATIC S7/PCS 7 automation system

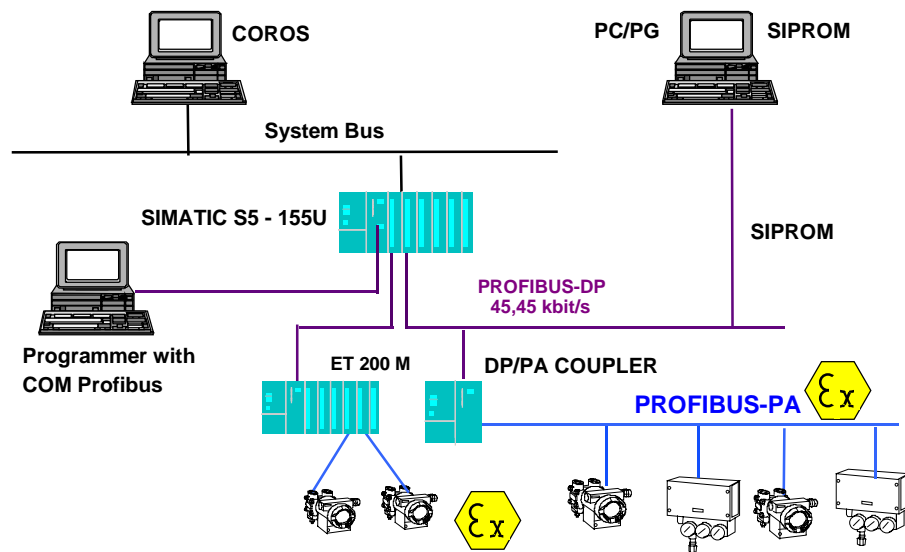

Fig. 1-3 Positioning of the PROFIBUS-PA field bus system in the SIMATIC S5 system

PROFIBUS

PROFIBUS is a multi-master bus system. PROFIBUS is the system bus intended for SIMATIC PCS 7 in medium-sized to large installations with high performance requirements.

Up to 126 stations can be connected to a PROFIBUS. It can operate at transmission rates of 9.6 kbit/s to 12 Mbit/s and can have a network size of up to 21,730 m at 1.5 Mbit/s.

PROFIBUS-DP

The exchange of data between automation system and distributed I/O as well as intelligent field devices is nowadays carried out via field bus systems with low installation overhead. The standardized PROFIBUS-DP is used for SIMATIC S5, S7, PCS 7. PROFIBUS-DP is a MASTER/SLAVE bus system. The master function is performed by an automation system (master class 1) or by one or more personal computers (master class 2). The automation system (master class 1) has full access via cyclic messages to all stations assigned to it. By means of the personal computer (master class 2), data can be exchanged as required with all connected stations via acyclic messages. For example the ET 200 M distributed I/O and individual field devices are connected via PROFIBUS-DP. Depending on the standard, up to 126 stations can also be connected to a PROFIBUS-DP. PROFIBUS can operate at transmission rates of 9.6 kbit/s to 12 Mbit/s and can have a network size of up to 21,730 m (at 1.5 Mbit/s).

PROFIBUS-PA

PROFIBUS-PA is the extension of PROFIBUS-DP to include the optimized transmission system for field devices whilst retaining the communications function of PROFIBUS-DP. With the selected transmission system, field devices, even in hazardous areas, can be connected to the automation system over great distances and powered via PROFIBUS-PA. PROFIBUS-PA is the communications-compatible extension of PROFIBUS-DP.

PROFIBUS-PA

=

PROFIBUS-DP communications

+

**optimized transmission system for field devices
(IEC 1188-2)**

**The HART
input module**

HART (highway addressable remote transducer) is a serial transmission method with which additional data such as measuring range, attenuation, etc. can be transmitted to connected sensors or actuators via a 4 to 20 mA current loop. In the course of time, HART has developed into a vendor-independent (quasi-) standard.

Utilization of the HART protocol becomes possible with the two HART analog modules available from SIEMENS. This extends considerably beyond the facility for incorporating a handheld terminal in the current loop.

1.2 PROFIBUS as the universal field bus

General

PROFIBUS (Process Field Bus) is a bus system standardized according to European standard EN 50170, Volume 2; it has been used successfully for several years in manufacturing and process automation (chemicals and process engineering). The following subtopics describe, apart from the technical characteristics of PROFIBUS-PA, the integrating function of PROFIBUS-PA in the automation of chemical processes and process engineering. PROFIBUS-PA is a communications-compatible extension of PROFIBUS-DP into the field. With the chosen transmission system ("bus physics"), transducers and actuators, even in the hazardous area, can communicate over great distances with the central programmable controller / system and can be powered by it. References /505/ to /518/ can be consulted for further information.

1.2.1 PROFIBUS-DP

Introduction

PROFIBUS-DP is the most widespread field bus system in Europe. The technical characteristics of PROFIBUS-DP allow operation in almost all areas of industrial automation. Notable features are, in addition to the simple installation (two-wire line), the extremely high transmission rate (up to 12 Mbit/s), the versatile network configurations (linear, star, ring) and optional redundancy with a fiber-optic double ring. PROFIBUS-DP is a master/slave bus system with which the master function is assumed by a programmable controller/system (master class 1) or a personal computer (master class 2). Master class 1, in which the automation functions (closed-loop and open-loop control) also take place, has full access to the field devices via cyclic and acyclic messages. Master class 2 can, if required, exchange data via acyclic messages with master class 1 (upload/download, master diagnostic read) and exchange data with the field devices (measured value read, slave diagnostic read, parameter write).

Technical specifications:

- Transmission system: RS 485
- Topology: linear, star, ring
- Medium: two-wire twisted pair cable, fiber-optics option
- Number of stations: 126 max. (32 max. per segment)
- Number of segments: 10 max.
- Network size: 2,000 m max. (optical: 21,730 m max.) at 1.5 Mbit/s
- Transmission rate: 12 Mbit/s max.
- Redundancy: with optical link modules (OLMs) and fiber-optic double ring

Modern field devices such as transducers, actuators and drives have, in addition to the measured value or manipulated variable, many parameters

which must be changed during startup and, to some extent also during operation in order to utilize the "intelligence" of these field devices such as preventive maintenance or optimization of the interface to the sensor. On account of the different time-related demands for data access of the master, PROFIBUS-DP offers cyclic and acyclic services.

All output values (control commands) are written to the field devices and all input values (measured values) are read out of the field devices in one cycle. Subsequently, an acyclic data interchange can take place with a particular field device. Settings of the field devices can be read or parameters can be modified. With the facility for supplementing each transmission cycle with precisely one single acyclic message, short, deterministic cycle times are ensured as the basis for software control in the programmable controller/system.

1.2.2 PROFIBUS-PA

Introduction

PROFIBUS-PA is the extension of PROFIBUS-DP to include the optimized transmission system for field devices (for example, for powering the field devices via the data cable and utilization in a hazardous environment) whilst retaining the communications functions of PROFIBUS-DP. This means that with PROFIBUS-PA a variant of PROFIBUS-DP has been defined which allows the operation of PROFIBUS in the intrinsically safe area also, whilst system integration with PROFIBUS-DP is ensured. This has been achieved by adopting the PROFIBUS-DP protocol for PROFIBUS-PA.

The choice of the internationally standardized transmission system to IEC 1158-2 (International Electrotechnical Commission) ensures the future-oriented field installation with PROFIBUS-PA.

The advantages of the field bus system can now also be used in process engineering with the PROFIBUS-PA bus system. PROFIBUS-PA is more than a two-wire line connecting the field devices (transducers and actuators). Highlighted in the following subtopics, apart from the technical characteristics of PROFIBUS-PA, is the integrating function of PROFIBUS-PA in the automation of chemical processes and process engineering.

PROFIBUS-PA meets the requirements of the process-engineering industry:

- Networking of transducers, valves, actuators via a serial bus system (two-wire line),
- for use in process engineering,
- with field device powering via the data cable, as well as
- for applications in the hazardous area ("intrinsically safe" type of protection EEx[i])

Signal conversion

Conversion of the PROFIBUS-DP transmission system from RS 485 (bit coding with asynchronous NRZ code) to IEC 1158-2 (bit coding with synchronous Manchester code) for PROFIBUS-PA takes place via the "DP/PA coupler" or "DP/PA link" described in Chapter 3 ff..

Area of application

PROFIBUS-PA is designed for operation in the intrinsically safe and non-intrinsically safe areas.

1.3 PROFIBUS components

1.3.1 Transition from PROFIBUS-DP to PROFIBUS-PA

Two network components, DP/PA coupler and DP/PA link, are available for the transition of the transmission system from PROFIBUS-DP (RS 485) to PROFIBUS-PA (IEC 1158-2). Their use is governed by the automation requirements.

DP/PA coupler

The DP/PA coupler has the following tasks:

- Conversion of the data format from asynchronous (11 bits/character) to synchronous (8 bits/character) and, associated with this, conversion of the transmission rate from 45.45 kbit/s to 31.25 kbit/s. The DP/PA coupler "acts as a wire"; it is not configured and cannot be detected by the stations.
- Powering of the field devices
- Limiting of the supply current by barriers (for flameproof applications)

Two variants of the DP/PA coupler are available: A non-flameproof variant with supply for up to 31 field devices, and a certified flameproof variant with supply for up to 10 field devices for operation in zones 1 and 2.

Note:

The maximum usable number of field devices is governed by the current consumption of the individual field devices.

DP/PA link

The DP/PA link comprises up to 5 DP/PA couplers (flameproof variant) or 5 DP/PA couplers (non-flameproof variant) connected via a headend module as a station to PROFIBUS-DP. The headend module is a slave on the higher-level PROFIBUS-DP (12 Mbit/s max.) and a master for the subordinate PA lines. Together, these PA lines form a logical bus. The total of all field devices on a DP/PA link is limited to 31 on account of the message length. This restriction applies irrespective of the DP/PA coupler variant in use. The DP/PA link is employed in the case of high demands for cycle time and large project scopes.

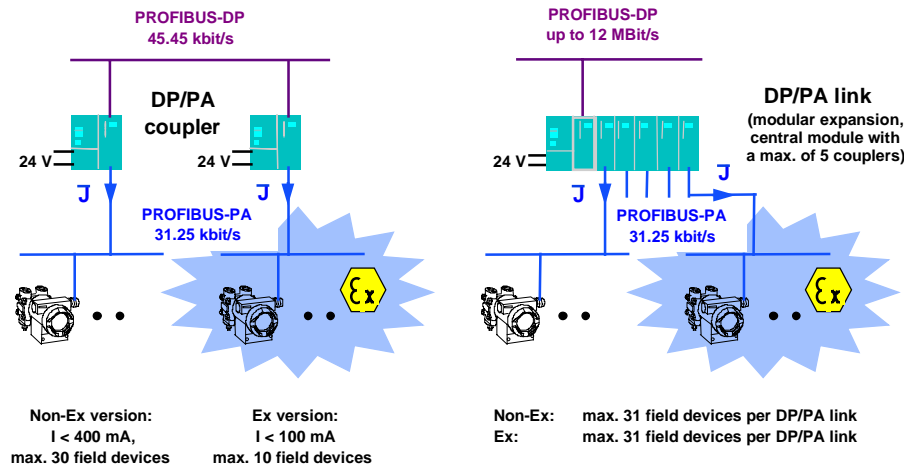

Fig. 1-4 Network components: DP/PA coupler and link module for PROFIBUS-DP/PA

Potential savings

The comparison between conventional, that is, parallel cabling of the field devices and the PROFIBUS-PA field bus system highlights the enormous potential savings in configuring, hardware overhead, installation and plant documentation.

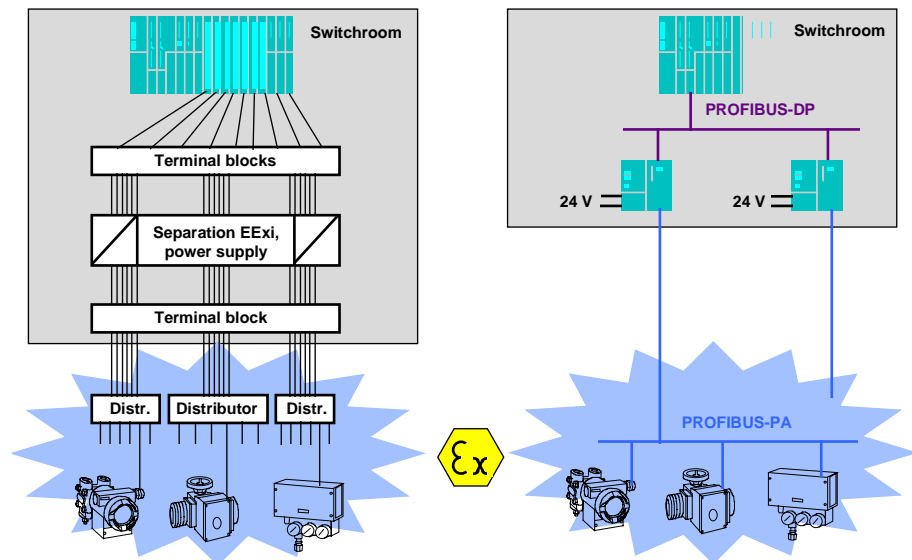

Fig. 1-5 Block diagram: Comparison between parallel cabling and serial cabling (field bus)

The cost savings when using PROFIBUS-PA result primarily from the discarding of jumpering panels, supply isolators and field distributors as well as reduced space requirement in the switchroom. Consequently, the costs of documentation and testing of field cabling with PROFIBUS-PA are reduced to a minimum ("a few two-wire lines").

Clearly, field bus structures with PROFIBUS-PA have considerably lower fault potential than conventional cabling. If, however, a fault occurs, it can be very quickly located and corrected on account of the simple structure.

1.3.2 PROFIBUS-PA configuration with SIMATIC S5

Components

In the SIMATIC S5 control system, the DP/PA coupler is exclusively used in conjunction with the IM 308 - C DP master card (from release 7). Owing to the relatively low data rate on PROFIBUS-DP (45.45 kbit/s) the project scope is governed either by the maximum number of addressable slaves (field devices) or the maximum cycle time.

The following should be observed for operation in SIMATIC S5 (for example, SIMATIC S5-155U PLC with CPU 948):

- The exchange of data with each field device lasts approximately 10 ms (outgoing and return message).
- Thus the cycle time on a DP line with 10 field devices is about $10 \times 10 \text{ ms} = 100 \text{ ms}$, i.e. the measured values can be read into the CPU or the manipulated variables can be read out 10 times per second.
- The cycle time with 30 field devices per DP line is about 300 ms.
- Up to 7 DP lines for field bus applications can be plugged into one SIMATIC S5-155U PLC.

1.3.3 PROFIBUS-PA configuration with SIMATIC S7

In conjunction with SIMATIC S7 and the SIMATIC PCS 7 control system, the DP/PA coupler is used for smaller project scopes or low time-related demands, and the DP/PA link for large project scopes and high time-related demands. The DP/PA link allows a configuration with a subordinate PA lines with short cycle times (approximately 100 ms for 10 field devices). These data are transferred to the SIMATIC PCS 7 control system via PROFIBUS-DP at up to 12 Mbit/s without significant loss of time (approximately 1 ms).

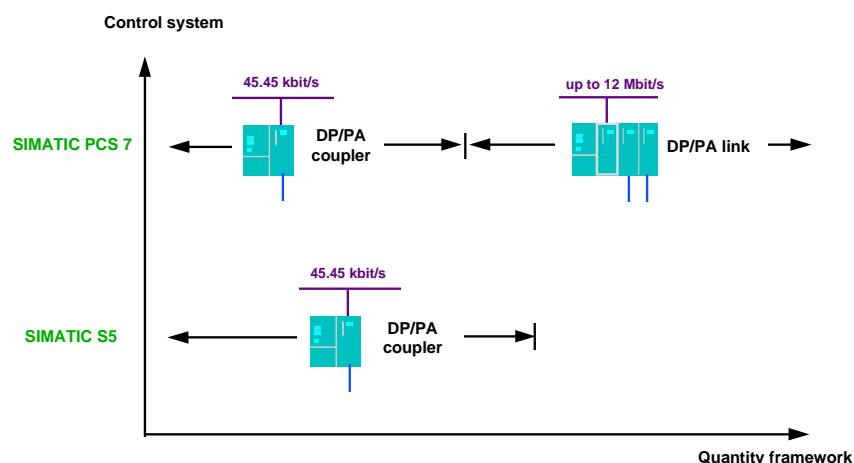

Fig. 1-6 Applications of the DP/PA coupler and link module for PROFIBUS-DP/PA

1.4 HART functions

Introduction	HART (highway addressable remote transducer) is a serial transmission method with which additional data can be transferred via a 4 to 20 mA current loop. The HART protocol describes the physical form of the transmission, transaction procedures, message structure, data formats and many commands. Furthermore, HART users can define their own commands.
HART signal	<p>The HART signal is a digital communication modulated onto the normal analog signal. Sine waves of 1200 Hz and 2200 Hz represent the HART signal and are modulated onto the analog signal (4-20 mA). Since the signal has a mean value of 0, the analog signal is not affected. The HART signal can be easily filtered out with a filter, and the original analog signal is then available again. The HART signal can be additionally evaluated:</p> <ul style="list-style-type: none">• HART signal with a frequency of 2200 Hz signifies a logic "0".• HART signal with a frequency of 1200 Hz signifies a logic "1".• The signal sequences are transferred alternately as the command (C) and response (R).
Application criteria/ characteristics	<p>HART modules are characterized by the following application criteria and characteristics:</p> <ul style="list-style-type: none">• HART has developed into a quasi-standard since the 1980s.• Several million HART devices are in operation worldwide.• They are pin-compatible with conventional analog modules.• Additional communication facilities via the current loop.• The low power requirement with HART favors its application in the hazardous area. <p>The utilization of HART in the ET200 M distributed I/O system is possible with HART analog modules.</p>

Overview of the components of the field engineering package

2

This chapter contains:

2.1 Introduction	2-2
2.2 Hardware components	2-2
2.2.1 PROFIBUS-PA	2-2
2.2.2 HART	2-3
2.3 Configuring the field engineering	2-5

2.1 Introduction

This chapter provides you with an overview of the components of the field engineering package. Detailed descriptions of the individual components can be found in the corresponding manuals which are referred to at the appropriate points. These are as follows:

Hardware:

- PROFIBUS-DP/PA coupler
- PROFIBUS-DP/PA link
- Analog input module SM 331; AI 2 x HART

Software:

- Step 7 (HW-Config)
- PCS 7 driver/CFC
- SIMATIC PDM field device parameter assignment tool
- COM PROFIBUS

2.2 Hardware components

2.2.1 PROFIBUS-PA

Applications DP/PA bus communication can be used in SIMATIC S5 , S7 and PCS 7. You can connect all field devices certified for PROFIBUS-PA.

DP/PA coupler DP/PA coupler is available in the following variants:

- DP/PA coupler EEx [i]: 6ES7 157-0AD00-0XA0
- DP/PA coupler: 6ES7 157-0AC00-0XA0

The DP/PA coupler has the following features:

- Type of protection [EEx ia] II C (only 6ES7 157-0AD00-0XA0)
- Intrinsic safety (only 6ES7 157-0AD00-0XA0)
- Isolation between PROFIBUS-DP and PROFIBUS-PA
- Diagnostics via LEDs
- Baud rate on PROFIBUS-DP 45.45 kbit/s
- Baud rate on PROFIBUS-PA 31.25 kbit/s

Detailed information can be found in /502/.

DP/PA link

The DP/PA link is available in the following variants:

- DP/PA link interface module IM 157 (6ES7 157-0AA00-0XA0) with:
 - DP/PA coupler EEx [i]: 6ES7 157-0AD00-0XA0
 - DP/PA coupler: 6ES7 157-0AC00-0XA0

The DP/PA link is formed from the IM 157 interface module and one or more DP/PA couplers (flameproof or non-flameproof variants). All components of the DP/PA link are interconnected via S7-300 standard bus connectors.

The DP/PA link has the following features:

- Type of protection [EEx ia] II C (only with 6ES7 157-0AD00-0XA0)
- Intrinsic safety (only with 6ES7 157-0AD00-0XA0)
- Isolation between PROFIBUS-DP and PROFIBUS-PA
- Baud rate on PROFIBUS-DP 12 Mbit/s max.
- Baud rate on PROFIBUS-PA 31.25 kbit/s
- Diagnostics via LEDs
- Max. number of DP/PA couplers per DP/PA link: 5

Detailed information can be found in /502/.

2.2.2 HART

Application

The HART analog modules are primarily intended for use in SIMATIC S7 and PCS 7. You can connect all field devices certified for digital communications with the HART protocol. However, you can also connect field devices with "conventional" 0/4-20 mA systems without the HART protocol. The modules are designed for the S7-300 modular packaging system. With PCS 7, the HART modules operate within the ET 200M distributed I/Os. Detailed information on the ET 200M distributed I/O device can be found in /140/.

Analog input module

Analog input module SM 331;AI 2 x HART(6ES7 331-7TB00-0AB0) has the following characteristics:

- Inputs in 2 channel groups
- Adjustable measured value resolution per channel (depending on the set integration time)
- Deactivation facility for measurement mode selection of the channels
 - Two-wire connection for transducers
 - Four-wire connection for transducers

- Channels can be deactivated
- Current signal selectable per channel
 - 0 to 20 mA (without HART function)
 - 4 to 20 mA (with/without HART function)
- Parameterizable diagnostics
- Parameterizable diagnostic alarm
- Two channels with limit monitoring
- Parameterizable limit alarm
- Channels isolated from each other
- Open-circuit monitoring
- Channels isolated from CPU and L+ load voltage

Detailed information can be found in /503/.

2.3 Configuring the field engineering

Introduction

Extensive and convenient software tools are available for incorporating the components of the field engineering package into the automation system. Incorporation takes place according to standard rules, irrespectively of whether it is a standard I/O module or an analog module +HART or a DP slave or PA slave. The principle of incorporation is uniform. The capabilities of the new components are described in more detail in the following sections.

COM PROFIBUS

The COM PROFIBUS program package is testing, diagnostic and parameter-assignment software for PROFIBUS-DP (for example, the IM 308-C master interface). With COM PROFIBUS, the ET200 system can be very easily configured, documented and put into operation. You need COM PROFIBUS in the SIMATIC S5 system for configuring the bus arrangement. Further details and instructions can be found in /501/.

Field device blocks

Field device blocks are needed to transfer process data between the I/Os for process data processing. These field device blocks provide the interface to the hardware, including verification functionality. Detailed information on parameter assignment for blocks can be found in /258/, Chapter 5. A detailed description of all field device blocks can be found in /260/. The field device blocks currently available for process linking of the field engineering package in the PCS 7 automation system can be found in Section 3.2.5, Table 3-1.

Hardware configuring

Hardware configuring within the STEP 7 program package of the S7/PCS 7 automation system is a convenient configuring tool for creating the hardware structures within your projects. You can use it for configuring and assigning parameters to modules of a centralized arrangement as well as of DP/PA devices in a distributed arrangement.

"Configuring" is understood to mean:

- The arrangement of racks, modules, interface modules and devices.

During configuring, the addresses in the I/O area of the S7-400 are automatically assigned to the individual modules.

"Parameterization" is understood to mean:

- The setting of parameters for parameterizable modules for the centralized arrangement and for a network.
- The setting of bus parameters, DP master and DP/PA slave parameters for a PROFIBUS-DP or DP/PA network.

Detailed information can be found in /231/

SIMATIC PDM

A universally applicable configuring tool for service and parameter assignment of field devices for the PROFIBUS-PA and HART analog module packages. A prerequisite is a device description (DD) which can be read and

interpreted by SIMATIC PDM (process device manager). SIMATIC PDM can be operated in a centralized (for example via the ES station) or decentralized arrangement (laptop at the IM 153-2 for HART modules or on PROFIBUS-DP).

Direct operation via PROFIBUS-DP is available in the first stage of supply (see Fig. 2-1).

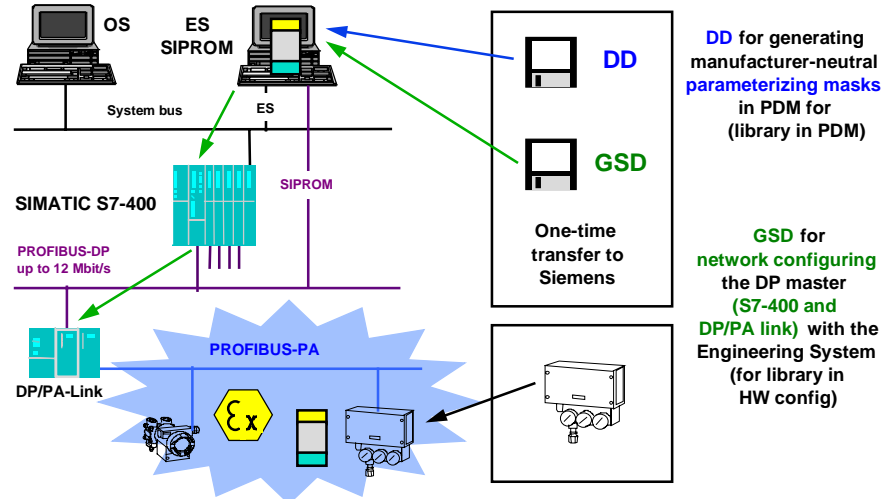

Fig. 2-1 Integration of any field devices in PROFIBUS-PA

Components of the field engineering package **3** in detail

This chapter contains:

3.1	Hardware	3-2
3.1.1	DP/PA coupler	3-2
3.1.2	DP/PA link	3-3
3.1.3	HART modules	3-4
3.1.3.1	Two-channel analog input module	3-4
3.2	Software/configuration	3-6
3.2.1	Configuration/project scope	3-6
3.2.2	Addressing of PROFIBUS-PA field devices	3-7
3.2.3	Parameter assignment / device profiles	3-9
3.2.4	Device database (GSD) and device descriptions (DD)	3-12
3.2.5	Driver function blocks for the field engineering package	3-13

3.1 Hardware

3.1.1 DP/PA coupler

Variants	Two variants of the DP/PA coupler are available: A non-flameproof variant with up to 400 mA output current for the PA cable, and a flameproof variant with up to 100 mA output current. The PA cable of the flameproof variant can be used in the hazardous area. The DP/PA coupler itself must be installed outside the hazardous area.
Mechanical design	<p>The mechanical design is characterized by the following points:</p> <ul style="list-style-type: none">• Modular design in the S7-300 packaging system on a shallow S7 300 rail with swivel-mounting and screw fixing.• Arrangement of all indicators and connectors at the front of the module.• Recessed arrangement of all plug-in connectors, covered by means of the front doors.• Housing in degree of protection IP 20.• Cooling by convection.• Horizontal installation.• For shielding purposes, the S7 300 rail serves as the functional ground reference point. Each module has an upper and lower shield contact spring at the rear to provide the electrical connection to the S7 300 rail when the module has been secured. Furthermore, the modules are equipped with additional shielding plates.• Adequate EMC is ensured through the use of plastic housings and light guide elements for the status indications.• The maximum overall mounting depth is 130 mm, height 125 mm. The width of the DP/PA coupler is 80 mm.• The S7 300 rail is supplied in various widths for cabinet installation, and in 2m lengths (standard S7-300 S7 300 rail).• Installation clearance of 40 mm above and below the module is necessary for module handling, on account of the swivel-mounting system and securing by means of a screwdriver. Cable ducts must be fitted outside these clearances.
Connection system	<p>The connection system is characterized by the following points:</p> <ul style="list-style-type: none">• The 24 V DC supply voltage is connected with 4-pole screw terminals.• The PROFIBUS-DP interface is connected with a 9-pin sub D connector. Strain relief and shielding are provided by this sub D male connector.

- With the non-intrinsically safe variant, the PROFIBUS-PA interface is connected via four screw terminals. The user can terminate the PA cable or loop it through, as required. The terminating resistor is selectable and integrated in the housing.
- With the intrinsically safe variant, the PROFIBUS-PA interface is connected via two screw terminals. The intrinsically safe DP/PA coupler is always situated at the end of the PA cable. The terminating resistor integrated in the housing is always active. With the intrinsically safe variant, this means that the PROFIBUS-PA must not be looped through.
- In both versions, the shield contact of the PA cable also serves for strain relief.

A more detailed description of the module can be found in the DP/PA coupler Manual /502/.

3.1.2 DP/PA link

Variants

The DP/PA link is formed from the IM 157 interface module and one or more DP/PA couplers (flameproof or non-flameproof variants). All components of the DP/PA link are interconnected via S7-300 standard bus connectors.

By combining the IM 157 with flameproof or non-flameproof variants of the DP/PA coupler, flameproof or non-flameproof variants of the DP/PA link are also possible. This modular system can be expanded to up to 5 PA lines.

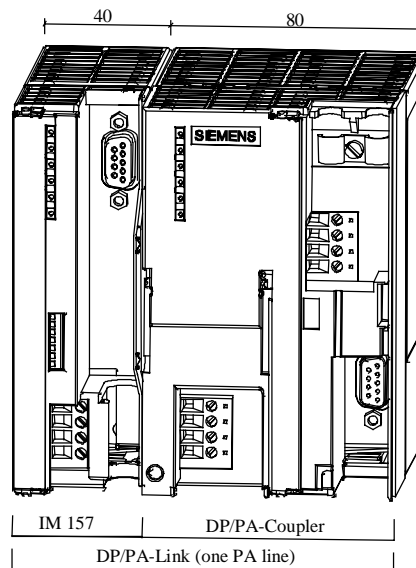

Fig. 3-1 The DP/PA link with IM 157 interface module and a DP/PA coupler

Mechanical design

The mechanical design is characterized by the following points:

- Modular design in the S7-300 design system on a shallow S7 300 rail with swivel-mounting and screw fixing.

- The maximum overall mounting depth is 130 mm, and height 125 mm. The width of the IM 157 is 40 mm. The overall width of the DP/PA link depends on the number of DP/PA couplers used.
- The remaining mechanical design data are same as for the DP/PA coupler.

Connection system

The connection system is characterized by the following points:

- The 24 V DC supply voltage is connected with 4-pole screw terminals.
- The PROFIBUS-DP interface is connected only at the IM 157 with a 9-pin sub D connector. The PROFIBUS-DP interfaces of the DP/PA couplers used in the DP/PA link have no function. Strain relief and shield contact are provided by the sub D male connector.
- With the non-intrinsically safe variant, the PROFIBUS-PA interface is connected via four screw terminals. The user can terminate the PA cable or loop it through, as required. The terminating resistor is selectable and integrated in the housing.
- With the intrinsically safe variant, the PROFIBUS-PA interface is connected via two screw terminals. The intrinsically safe DP/PA coupler is always situated at the end of the PA cable. The terminating resistor integrated in the housing is always active.
- In both versions, the shield contact of the PA cable also serves for strain relief.

A more detailed description of the module can be found in the DP/PA coupler Manual /502/.

3.1.3 HART modules

3.1.3.1 Two-channel analog input module

Mechanical design

The mechanical design is characterized by the following points:

- Modular design in the ET 200M design system on a shallow S7 300 rail with swivel-mounting and screw fixing.
- For operation in a distributed arrangement in the ET 200M with the IM 153-2 interface module. Detailed information on the ET 200M distributed I/O unit and interface module can be found in /140/.
- Arrangement of all indicators and connectors at the front of the module.
- Recessed arrangement of all connectors, covered by the front doors.
- Housing in degree of protection IP 20.
- Cooling by convection.
- Horizontal mounting.

- For shielding purposes, the S7 300 rail serves as the functional ground reference point. Each module has an upper and lower shield contact spring at the rear to provide the electrical connection to the S7 300 rail when the module has been secured. Furthermore, the modules are equipped with additional shielding plates.
- Adequate EMC is ensured by using plastic housings and light guide elements for the status indications.
- The maximum overall mounting depth is 130 mm and height 125 mm. The width of the module is 40 mm.
- The S7 300 rail is supplied in various widths for cabinet installation, and in 2m lengths (standard S7-300 S7 300 rail).
- Installation clearance of 40 mm above and below the module is necessary for module handling, on account of the swivel-mounting system and securing by means of a screwdriver. Cable ducts must be fitted outside these clearances.

Connection system

The connection system is characterized by the following points:

- The 24 V DC supply voltage is connected at the 20-pin front connector by means of screw terminals.
- The 0/4 to 20 mA process signals are connected at the 20-pin front connector by means of screw terminals.
- Strain relief at the front connector.
- Shielding depends on the conductor cross-section, by means of shield contact elements to be ordered separately.
- The module can be pulled out and inserted online with an active backplane bus.

A more detailed description of the module can be found in the manual /503/.

3.2 Software/configuration

3.2.1 Configuration/project scope

DP/PA coupler

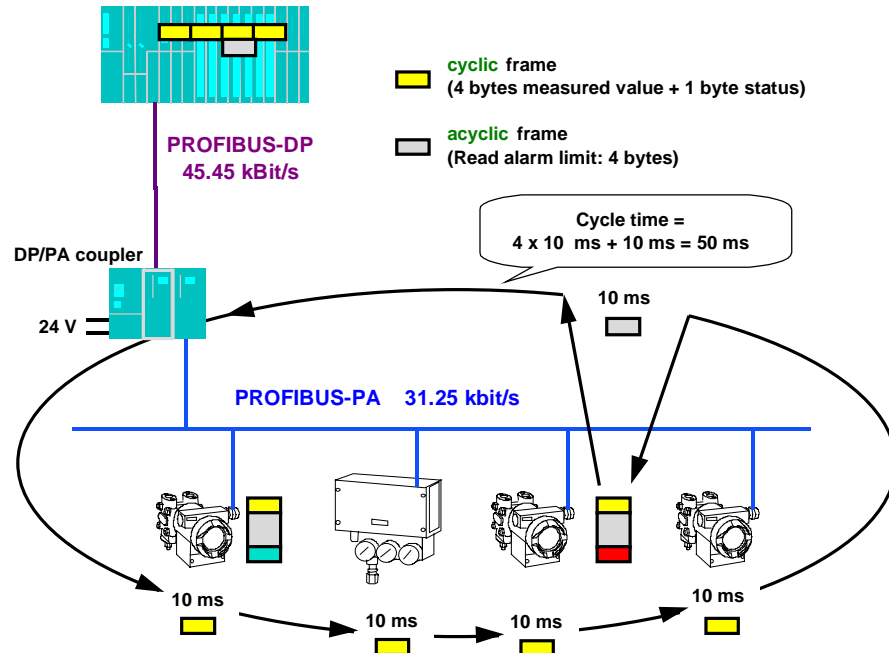

Fig. 3-2 Block diagram for the determining of cycle times on the PROFIBUS-PA using a transceiver module

Within the bus cycle time, each field device exchanges the most important input and output data with the master. Additionally, the master accesses a particular field device, for example, to write parameter assignment data or to read diagnostic parameters. The number of field devices on the PROFIBUS-PA segment governs the bus cycle time, i.e. the timebase in which the process values are exchanged with the field devices. The bus cycle time is obtained by adding the cyclic messages to all field devices, and the acyclic message to a particular field device. In the example:
 $4 \times 10 \text{ ms} + 10 \text{ ms} = 50 \text{ ms}$.

Note:

The value of 10 ms within the bus cycle time applies to field devices which exchange a measured value or manipulated value with its corresponding status, i.e. 5 bytes of useful data per cycle, with the programmable controller/system. Examples of these field devices are pressure, temperature, level transducers, valves and actuators. Complex field devices, for example those providing several measured variables simultaneously (such as flow transducers), require additional transfer time. With average field instrumentation, the number of these complex field devices is relatively low and their influence on the overall bus cycle time is negligible.

DP/PA link

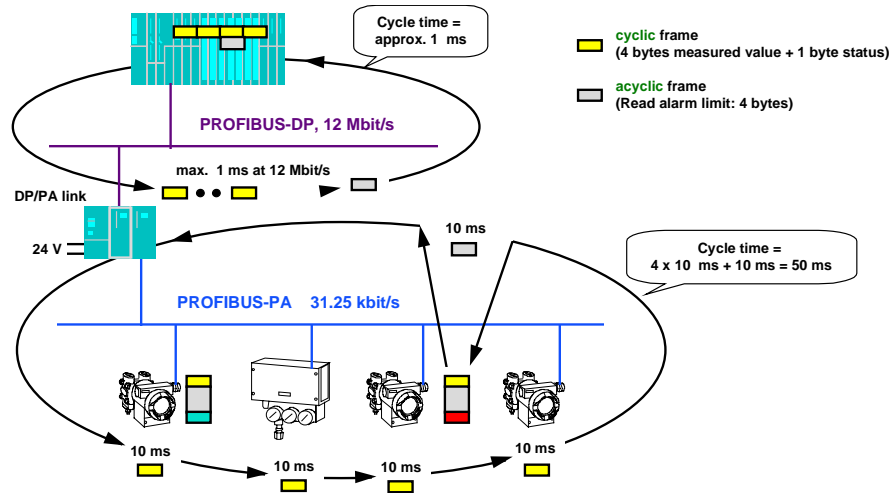

Fig. 3-3 Block diagram for the determining of cycle times on the PROFIBUS-PA using a DP/PA link module

With the DP/PA link in operation, all cyclic messages and one acyclic message are relayed via PROFIBUS-DP to the programmable controller / system within the cycle of the PROFIBUS-PA line, in one message each. On account of the high data transmission rate of up to 12 Mbit/s, the delay in data transmission is insignificant (only about 1 ms even with 31 field devices per DP/PA link). The DP/PA link (for SIMATIC PCS 7) has the same time response as the DP/PA coupler, up to the maximum number of connectable field devices (31 field devices per DP/PA link). Decisive advantages are obtained with structures in which the field devices are distributed over several DP/PA links. At a transmission rate of 12 Mbit/s on the higher-level PROFIBUS-DP, the delays are only in the region of about 1 ms; the cycle time thus remains almost independent of the number of field devices. With ten field devices per DP/PA link, the cycle time is about 100 ms, and with 30 field devices per DP/PA link about 300 ms.

3.2.2 Addressing of PROFIBUS-PA field devices

DP/PA coupler

With the DP/PA coupler in operation, the field devices are addressed directly from the programmable controller/system; the DP/PA coupler is transparent. DP/PA coupler (see Fig. 3-4, left half): The DP/PA couplers are not apparent to the programmable controller / system (station no. 1) so that the field devices (stations 2, 3 and 4) - as seen from addressing - are connected to the same PROFIBUS segment. In this case the field devices are treated as single slaves.

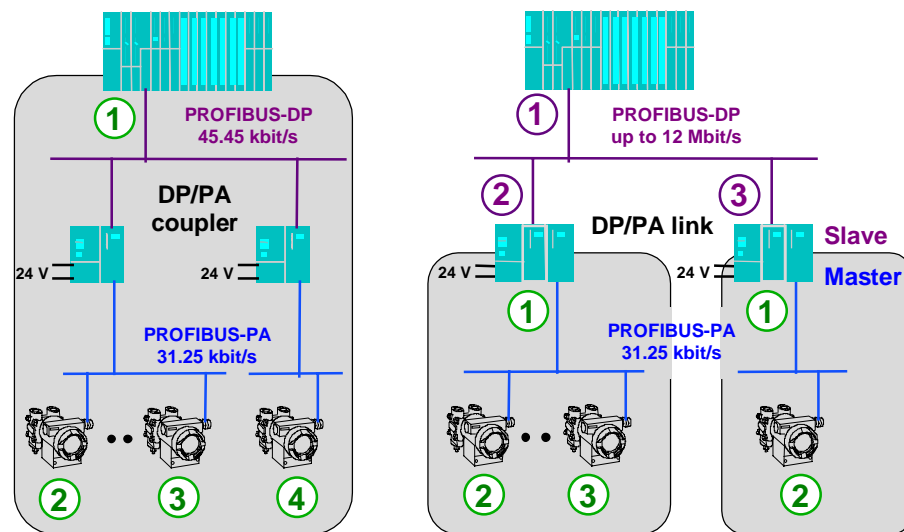

Fig. 3-4 Addressing of field devices within an automation system on PROFIBUS-PA

DP/PA link

The DP/PA link is a slave on PROFIBUS-DP and a master on PROFIBUS-PA. The programmable controller/system addresses the field devices via the DP/PA link, that is, indirectly.

DP/PA link (see Fig. 3-4, right half): Each DP/PA link (stations 2 and 3 on PROFIBUS-DP) is a station (slave) on the higher-level PROFIBUS-DP and therefore appears to the programmable controller/system with only one station address each. Furthermore, each DP/PA link (station no. 1 on PROFIBUS-PA) is the master for the field devices connected to it (stations 2 and 3 or 2 on PROFIBUS-PA).

Thus the DP/PA link acts as a "decoupler" for the transmission rate, allowing the SIMATIC PCS 7 control system an extremely large addressing volume (theoretically 5 x 96 DP/PA links of 31 field devices, i.e. theoretically 14,880 field devices per SIMATIC S7-400). In practice, this is limited by the maximum number of measured values to be processed in the user program of the S7-400 CPU.

Summary

Shown in Fig. 3-5 is the relationship between project scope and time response using a DP/PA coupler and link modules with different configurations. It can be seen that where two or more link modules are used with the same number of field devices, the loading on the DP line corresponds approximately to the loading of only one link module.

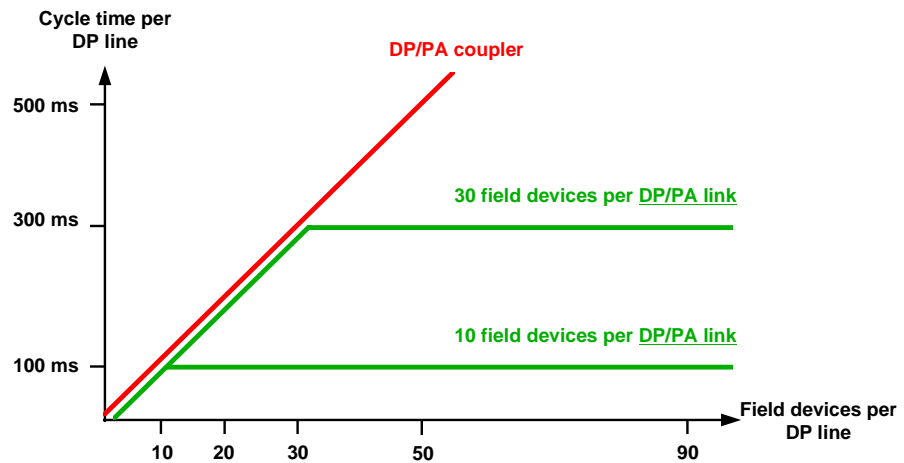

Fig. 3-5 Overview of project scope: PROFIBUS-PA

HART

HART analog modules are used within the ET 200 M distributed I/O system. Support of communication with HART devices via HART analog module, inserted centrally in an S7-300, is not provided. Addressing takes place accordingly. Further information can be found in /140/.

3.2.3 Parameter assignment / device profiles

Introduction

In order to allow uniform device responses, device profile definitions exist /518/. The basic arrangement is explained in more detail in the following.

PROFIBUS-PA

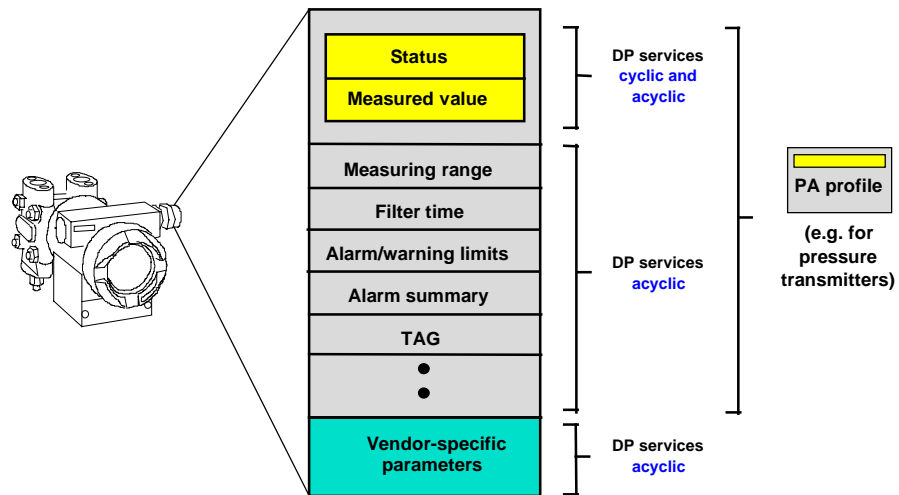

Fig. 3-6 Schematic representation of a device profile for the PA profile on PROFIBUS-PA

Parameter groups

The parameters in a field device can be classified in three groups:

1. Process parameters: Measured or manipulated value and corresponding status

2. Operational parameters: Measuring range, filter time, alarm parameters (message, alarm and warning limits), standard parameters (measuring point identifiers, TAG)
3. Manufacturer-specific parameters such as special diagnostic information

1st group

The parameters of the first group are read or written cyclically or acyclically by the programmable controller/system. The measured value and status parameters are present in all measuring field devices, and the manipulated variable and status parameters are in all actuating field devices and are coded uniformly (for example, measured/manipulated value in 4 bytes, IEEE format).

2nd group

The parameters of the second group can be read and written acyclically by the programmable controller as required. Some of these parameters are exchanged with the field devices via the function blocks in the programmable controller/system, to allow access of the HMI system (for example, visualization of alarm violation).

The parameters, that is the associated field device functions of the first and second groups, are defined in the PA profile of the PNO guidelines (PROFIBUS user organization) for PROFIBUS-PA. Some of these field device functions are mandatory and some optional. Where optional functions are implemented in the field device, they must comply with the description according to the PA profile.

3rd group

The parameters of the third group are manufacturer-specific. Acyclic access usually takes place with a personal computer for diagnostic and maintenance purposes. In exceptional cases, certain parameters are also read or written from this group by the programmable controller/system.

Interoperability

Programmable controllers/systems and PCs of different manufacturers can read/write the parameters defined in the PA profile from all field devices via PROFIBUS-PA, thus affecting the field device functions defined in the PA profile.

The term "interoperability" is understood to mean the interaction between components (control systems and field devices in this case) of different manufacturers on an open bus system, on the basis of a vendor-independent definition of the device and communications functions.

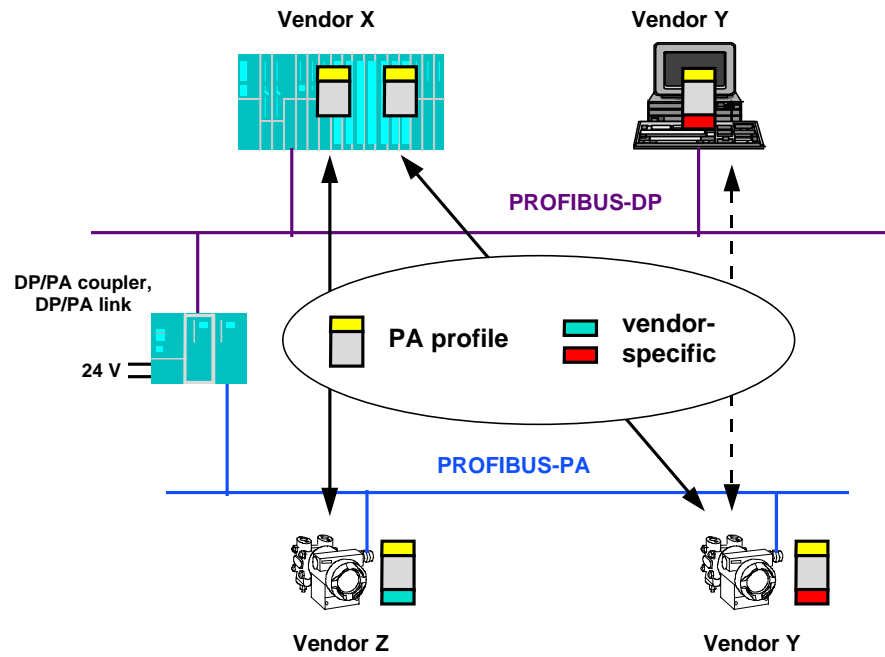

Fig. 3-7 Block diagram showing interchangeability of field devices on the basis of the device profile on PROFIBUS-PA

On the basis of the parameters defined in profile PA, the programmable controller of manufacturer X and the PC of manufacturer Y can access both field devices of manufacturer Z and Y. The devices of manufacturers X, Y and Z are interoperable.

Furthermore, data interchange of the manufacturer-specific parameters is possible between PC and field device of manufacturer Y (homogeneous communications network). Manufacturer-specific parameters are not used as a rule in the programmable controller/system, but can be read, for example, to create the plant image by the PC/PG.

The field devices are interchangeable whilst retaining functionality, provided the functions of profile PA are used.

More detailed information on the individual, special device profile definitions can be found in /518/.

HART module

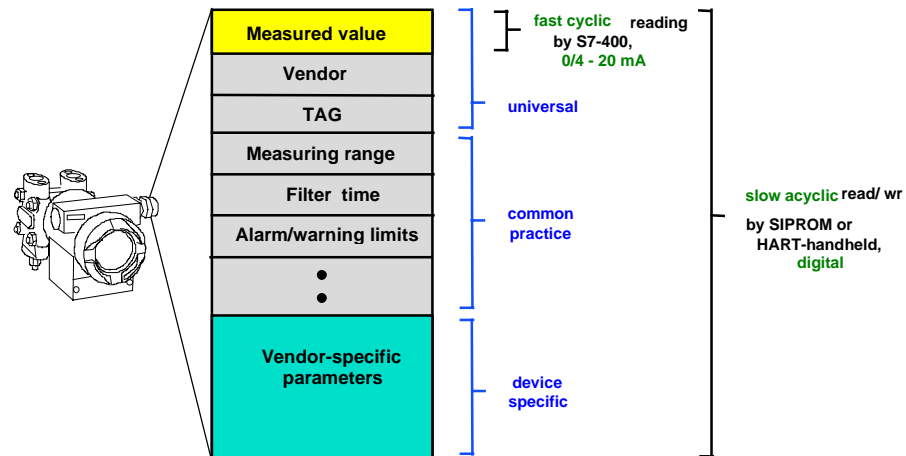

Fig. 3-8 Schematic representation of a device profile for HART communications

Parameter groups

The parameters in a HART field device can be classified in three groups:

1. Universal: Measured value or manipulated value, manufacturer name and measuring point identifier (TAG)
2. Common practice: Measuring range, filter time, alarm parameters (message, alarm and warning limits)
3. Device specific: For example, special diagnostic information

All three parameter groups are acquired via slow, acyclic reading by SIMATIC PDM or a HART handheld terminal.

The measured value is represented by a 4 to 20 mA signal. The A/D or D/A conversion takes place on the HART analog module, and this process value is handled via fast cyclic reading/writing by the automation station. In exceptional cases, certain parameter groups are also read and written acyclically by the programmable controller system.

3.2.4 Device database (GSD) and device descriptions (DD)

Device database

The device database is a file containing the device's master data enabling the configuration of PROFIBUS-PA capable field devices in the SIMATIC S5/S7/PCS 7 automation system. Each manufacturer of PROFIBUS-PA capable field devices supplies a device database (GSD) with their devices. These must be read into the engineering station and updated in the COM PROFIBUS or STEP 7 program package in the HW-Config program section. Further information on this topic can be found in /231/.

Device description

The device description (DD) is a universal, standardized device and parameter description for PROFIBUS-PA and HART-capable field devices. SIMATIC PDM is supplied with device data by the contents in the device description.

These describe:

- The user interface of SIMATIC PDM (text representation);
- the interdependences of device parameters;
- the online functions;
- the methods (special routines or functions) and
- the communications interfaces of the field devices.

3.2.5 Driver function blocks for the field engineering package

Introduction

In order to transfer process data between the I/Os and the user program, field device blocks are needed. These field device blocks provide the interface to the hardware, including functionality verification.

Detailed information on assigning parameters to blocks can be found in /258/, Chapter 5.

The block types you use in PCS 7 can be purchased in the form of block libraries or you can create them yourself. The following reference books are available for the purpose:

- Basic blocks library /258/
- Technological blocks library /259/
- Field device blocks library /260/

The existing set of block types can be extended if necessary. We recommend the use of the basic blocks and reference manual /258/ in which the block concept is described in detail (Chapter 2).

Field device blocks

Shown in table 3-1 below is a listing of the blocks used in the field engineering package in the SIMATIC PCS 7 automation system. These field device blocks can be found in the field device blocks library /260/.

Block name	Block type	Library	Application
IN_AI	Analog input driver	Basic blocks	HART- AI module
PA_AI	Analog input driver	Field device blocks	PROFIBUS-PA
PA_DI	Binary input driver	Field device blocks	PROFIBUS-PA
PA_DO	Binary output driver	Field device blocks	PROFIBUS-PA
PA_AKT	Actuator	Field device blocks	PROFIBUS-PA
PA_TOT	Analog input driver	Field device blocks	PROFIBUS-PA

Table 3-1: Field device blocks for the field engineering package

Catalog data

4

This chapter contains:

4.1 Ordering data for the field engineering package	4-3
4.2 Cross-references to detailed catalogs	4-3
4.3 Positioning in the information environment	4-4

4.1 Ordering data for the field engineering package

Ordering data	Order No.
System overview, field engineering package	
Drivers (basic blocks library)	6ES7 863 - 2DA00 - 0XX0
PA drivers (field device blocks library)	6ES7 863 - 5DA00 - 0XX0
Engineering toolset (STEP 7, SCL, CFC)	6ES7 818 - 8AC00 - 0YE0
SIMATIC PDM	7MP 9900 - 0AA00
DP/PA coupler, intrinsically safe version	6ES7 157 - 0AD00 - 0XA0
DP/PA coupler, non-intrinsically safe version	6ES7 157 - 0AC00 - 0XA0
DP/PA link (IM 157)	6ES7 157 - 0AA00 - 0XA0
Analog input module SM 331 AI 2 x HART	6ES7 331 - 7TB00 - 0AB0

4.2 Cross-references to detailed catalogs

Catalog	Catalog contents	Order No.
ST 50	SIMATIC S5 Programmable controllers	E86060-K4650-A101-A7
ST 70	SIMATIC Automation systems SIMATIC S7/M7/C7	E86060-K4670-A101-A2
ST 80	SIMATIC HMI Human-machine interface products / systems	E86060-K4680-A101-A2
IK 10	SIMATIC NET Industrial communication networks	E86060-K6710-A101-A6
ST PI	PROFIBUS & AS-Interface Components on the field bus	E86060-K4660-A101-A1
PM 10.1	Printers and monitors for automation Technical Catalog	E86060-K3310-A101-A1
KT 10	Combination system SITOP power supplies SITOP connection, system cabling	E86060-K2410-A101-A1
ST PCS 7	SIMATIC Process control system SIMATIC PCS 7	E86060-K4678-A111-A1
CA 01	Components for automation	E86060-D4001-A100-A4

4.3 Positioning in the information environment

To support your configuration, there is extensive user documentation intended for selective utilization. The following explanations are designed to facilitate utilization of the user documentation.

Title	Contents
System description: Process control system PCS 7	This description provides an overview of components and functionality of the SIMATIC process control system 7, and contains the system topics of interest for operating a control system.
STEP 7 user manual	The STEP 7 user manual explains the basic utilization and functions of the STEP 7 programming software. Whether you are a first user of STEP 7 or have experience with STEP 5, the manual provides an overview of the procedure for configuring, programming and startup of an S7-300/400. When working with the software, you can use the online help for specific support in detailed questions of software utilization.
Reference manual System and standard functions	The S7-CPU's contain the system and standard functions integrated in the operating system which you can use in programming. The manual provides an overview of the functions and organization blocks available as a basis with S7, as well as detailed interface descriptions in the form of reference information, for utilization in your user program.
ES manual	The engineering system (ES) manual for the technological hierarchy (TH) and import-export assistant (IEA) of the PCS 7 engineering package contains the principles and description of the procedure for structuring plants technologically and independently of phases.
CFC manual	The manual for the CFC configuring tool (in the PCS 7 engineering package) provides an overview and instructions for the procedure in creating an overall software structure from prepared blocks. When working with the software, you can use the online help which answers your detailed questions on utilizing the CFC editor.
SFC manual	The manual of the SFC I&C package provides the information needed for configuring sequence controllers. When working with the software, you can use the online help which answers your detailed questions on utilizing SFC.
Reference manual of the block libraries	The "Basic blocks", "Field device blocks" and "Technological blocks" manuals contain detailed information on the blocks of the libraries.
WinCC manuals	The manuals provide the information need for configuring and working with the HMI system and includes descriptions of the hardware, software and process control.
DP/PA bus communication manual	This manual describes the hardware of the PROFIBUS communication DP/PA in detail. It allows you to put bus communications into operation.

Reference manual Automation systems S7-300, M7-300, ET 200M Flameproof I/O modules Chapter 4 HART analog modules	This chapter of the reference manual describes the HART analog module. It enables you to put the modules into operation.
ET 200M distributed I/O unit manual	This manual describes the design of the ET 200M distributed I/O unit and includes a description of the IM 153-2 module needed for operation of the HART modules.

Installation guidelines

5

This chapter contains:

5.1 Introduction	5-2
5.2 Mechanical and electrical installation	5-6
5.2.1 Installing the cables	5-6
5.2.2 Cable routes within and outside buildings	5-6
5.2.3 Cable specifications and cable recommendation for PROFIBUS-DP	5-8
5.2.4 Cable specifications and cable recommendation for PROFIBUS-PA	5-9
5.2.5 Shielding concept	5-11
5.2.6 Grounding and equipotential bonding	5-13
5.2.7 Lightning protection	5-13
5.2.8 Connectors	5-14
5.2.9 Installation materials and tools	5-15
5.3 Guidelines of the PNO (PROFIBUS Users' Organization)	5-16

5.1 Introduction

General

A bus system is characterized in that many stations can communicate with each other using a low amount of cabling. Another important criterion is the capability of the expansion of existing system sections without having to modify the existing structures. This criterion is met with PROFIBUS-PA. The versatile system configuration of PROFIBUS-PA allows optimum adaptation of field cabling to the local circumstances of the industrial plant.

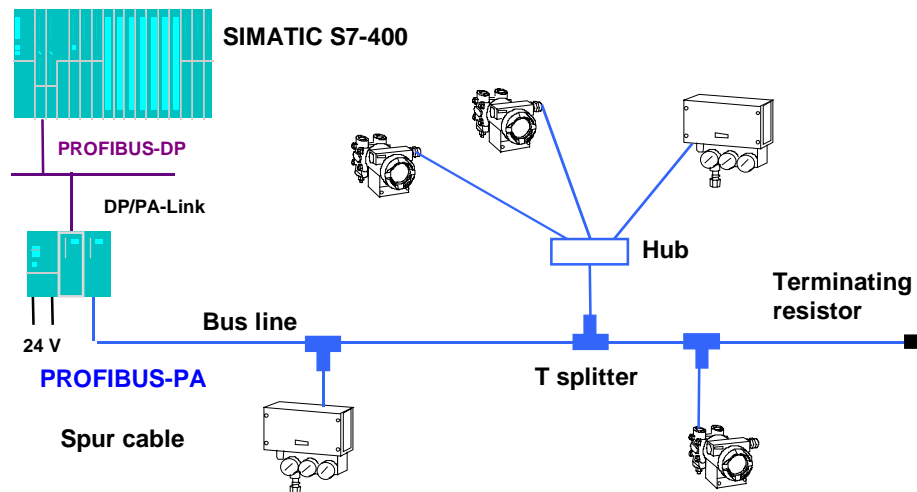

Fig. 5-1 Topology of PROFIBUS-PA

Connection system

The field devices are connected to the bus line by means of T splitters and hubs (connection box).

A distinction is made between the following arrangements:

- Bus line from the DP/PA coupler or DP/PA link to the field devices and star-configuration cabling on site.
- Field devices connected with T splitters and hubs along the bus line.

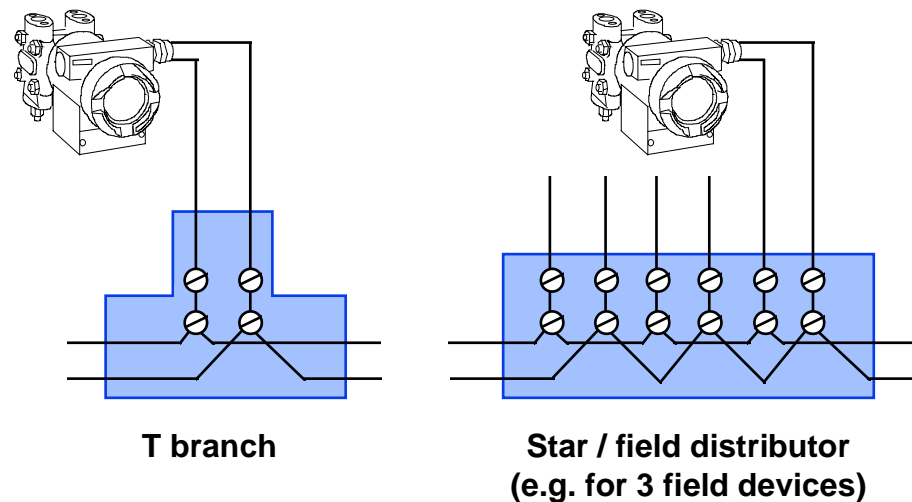

Fig. 5-2 Connection diagram for field devices on PROFIBUS-PA

Number of field devices

By means of the DP/PA coupler or DP/PA link, up to ten field devices can be powered on a PROFIBUS-PA segment (shielded two-wire cable) in the hazardous area, and up to 31 field devices in the non-hazardous area.

Cable lengths

The following cable lengths can be achieved independently of distribution and number of PROFIBUS-PA devices:

- Flameproof version 730m
- Non-flameproof version 560m

Depending on the distribution and number of PROFIBUS-PA devices, greater lengths can be achieved:

- Non-flameproof and flameproof [ib] version 1900m max.
- Flameproof [ia] version 1000m max.

Power consumption

Each field device on PROFIBUS-PA draws a static quiescent current of at least 10 mA from the DP/PA coupler or DP/PA link via the data cable. Field devices with lower power consumption, such as pressure, temperature or level transducers, utilize this quiescent current for their own supply of power. The total quiescent current of all stations is limited to 100 mA in the hazardous area and 400 mA in the non-hazardous area. In the ideal case, each field device draws precisely 10 mA quiescent current; in practice, however, it is between 10 and 30 mA according to field device.

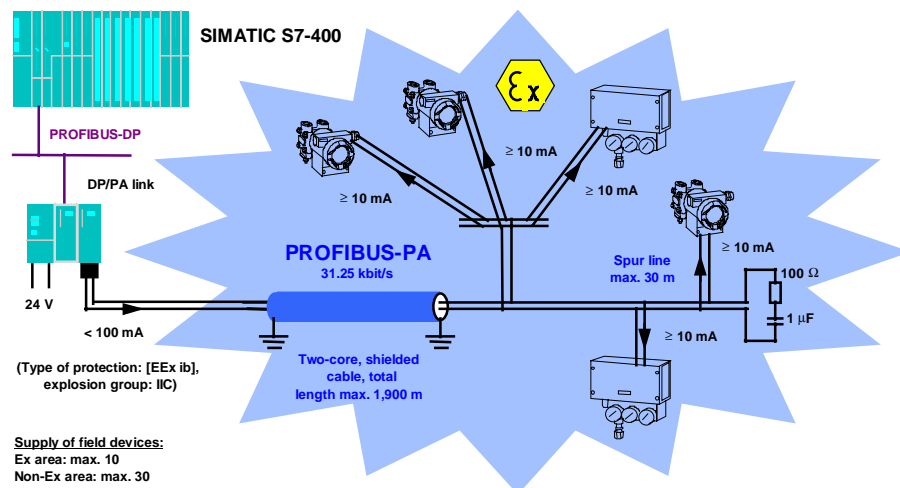

Fig. 5-3 PROFIBUS-PA powering of field devices

Type of data transmission

Data transmission is achieved by modulating the quiescent current with current signals of $\pm 9 \text{ mA}$. The design of the flameproof variant of the DP/PA coupler or DP/PA link according to [EEx ia] IIC allows the field devices to be operated in zone 0 (5% of all applications in the hazardous area) and zones 1 and 2 (both accounting for 95% of all applications in the hazardous area).

Installation site

The DP/PA coupler and DP/PA link are so-called "associated apparatus" with an intrinsically safe circuit (PROFIBUS-PA) which is installed outside the hazardous area.

Installation

Simple and rugged installation:

- Two-wire line with shield
- Connection by means of terminals, no soldering
- Field devices can be replaced during operation.

Redundancy concepts

Redundancy can be created easily and without problems. Various redundancy concepts are shown in Fig. 5-4.

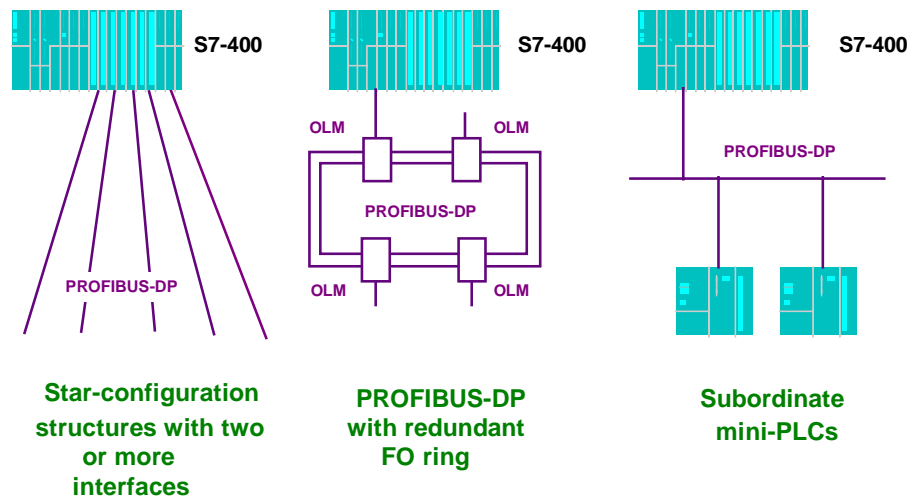

Fig. 5-4 Redundancy concepts for PROFIBUS-DP

5.2 Mechanical and electrical installation

5.2.1 Installing the cables

Installation	When installing the cables, ensure that they are not twisted, kinked, stretched or crushed.
Connecting the shields	<p>Shielded cables (braided shield) are recommended for the bus cable. This recommendation also applies to any supply cables from external power supplies to PROFIBUS devices (such as repeaters).</p> <p>Doubled-shielded cables are particularly suitable for environments subject to electromagnetic interference. To ensure optimum protection, the outer shield (braided shield) and the inner shield (foil shield) at both cable ends must make large-area contact to ground with a grounding clamp.</p> <p>Where bus cables are inserted into electronics cabinets, the outer shield is additionally given large-area contact to a shield bus to improve the diverting of radio-frequency interference. The cable insulation should be stripped over the width of the clamp by means of a cable knife, without damaging the braided shield. The shield bus must have a good electrical connection with the cabinet ground (screw-fitting with a toothed lockwasher).</p> <p>For industrial areas subject to extreme electromagnetic interference (converters), laying of the cable within a steel pipe or sheet-steel duct is mandatory. The pipe or duct must have multiple grounding at various points. Alternatively, a fiber-optic bus may be used.</p>
Securing the cables	Bus cables must be mechanically secured at a distance of ≤ 1 meter from the terminal of the connected device (by means of a cable tie or clamp, for example). The device terminals generally serve only to divert the interference currents (shield contact) and cannot counteract vertical or horizontal tensile forces.
Equipotential bonding	Where circulating currents via the shield are expected to be higher than permitted by the cable manufacturer, an additional equipotential bonding conductor ($\geq 10 \text{ mm}^2$ copper) should be laid to the bus cable, parallel if possible.

Note:

Particular attention must be paid to VDE 0165 Section 5.3.3. for operation in hazardous zones. It specifies that in hazardous zones and with more than one ground point, equipotential bonding is mandatory.

5.2.2 Cable routes within and outside buildings

Installing the cables	Shielded bus cables must be laid at a distance of at least 200 mm from supply and high-voltage cables of more than 60 volts. With severe interference sources (welding transformer, switched motors, etc.) the distance must be increased to at least 500 mm.
------------------------------	---

Installation next to telecommunications cables should be avoided because mutual interference cannot be ruled out. Installation next to signal cables for measurement and control with signal voltages of ≤ 60 volts is possible without problems.

Laying on cable racks and channels is permissible. Adequate grounding should be ensured. Even short spur cable racks or steel conduits should be grounded.

Protection against damage

Where there is risk of mechanical damage (friction, walkways) special protection must be provided (closed sheet metal duct or conduit).

If no cable racks, channels or ducts are available, the cable must be installed in a conduit. This must be marked accordingly to prevent other cables from being drawn in later. At expansion joints of the building, the conduit may be interrupted for a maximum of 500 mm provided the cables cannot be damaged by falling parts. At specially protected locations (electronics rooms) the cables may be installed without conduit. The subsequent pulling-in of bus cables into an occupied conduit is not permissible on account of the risk of mechanical damage.

Storage and transportation

During storage, transportation and laying, ensure that both ends of the bus cable are sealed with caps or insulating tape. This prevents the ingress of moisture and dirt.

Laying of cables in the ground

In the ground, a cable must be laid in conduits or duct blocks. With direct laying, the cable must be covered with an additional protective layer of sand to prevent damage to the cable. The manufacturer's specifications relating to suitability of the particular cable to burying in ground must be observed. Some manufacturers assign a particular color to the cable to facilitate identification (for example, gray cable within buildings and black cable outside buildings and in the ground).

For protection against the effects of lightning strikes, a 70 mm^2 copper cable or $40 \times 5 \text{ mm}$ steel strip must be laid about 0.5 m above a cable buried in the ground (covered with sand or in a PVC conduit).

Permissible bending radius

Particularly with fiber-optic cables, the bending radius must not be lower than the minimum value specified by the manufacturer. For example, the bending radius applying to the SIMATIC NET PROFIBUS plastic fiber cable is $\geq 35 \text{ mm}$, and $\geq 150 \text{ mm}$ for the corresponding glass fiber cable. The corresponding tensile strengths must not be exceeded (10 N and 500 N respectively for the above cables).

The following guide value applies to copper cable with a plastic sheath:

Laying radius = 12 x cable diameter

The maximum tensile stress (guide value) is 100 N.

5.2.3 Cable specifications and cable recommendation for PROFIBUS-DP

Cable specification

Cable type	Twisted pairs 1 * 2 or 2 * 2 or 1 * 4 (star quad), shielded
Impedance	120 Ω nom., 100 Ω min., 130 Ω max., f > 100 kHz
Cable capacitance	< 60 pF/m typ.
Core cross-section	0.22 mm ² min., approx. AWG 24
Signal attenuation	9 dB ¹ max. over entire length of cable section corresponding to 1200 m 100 kbit/s [RS 422A] or approx. 0.75 dB/100m f = 100 kHz
Shielding	Apart from good RF characteristics, ensure that the shield can be connected correctly. Wrapped shield foil is not suitable. If possible, use aluminum foil and copper braid or at least copper braid.

Table 5-1: Cable specification

Cable recommendation

The search for suitable cables with the above specifications was unexpectedly difficult. Signal standard RS 485 was originally created for transmission on telephone cables with 120 Ω impedance. These are frequently used without shielding. Where they are shielded, it is usually static which explains the types with aluminum foil and contact wire. However, the advent of ISDN networks resulted in a general need for telephone cables with shielding at RF. Two-wire data transmission at up to the highest frequency regions has developed greatly in recent years as local area networks (LANs). In newer buildings, LAN-capable universal cables are pre-installed in the infrastructure. Unfortunately, the excellent cables developed for the purpose can hardly be used for PROFIBUS because the impedance of this network cable is a standard 100 Ω . Although this value is precisely at the limit of the PROFIBUS specification, the negative tolerance range of -10 % to -15 % can cause unacceptable reflections with a terminating resistance of 120 Ω . Only cables with an impedance complying with the specifications are shown in the following table.

¹The PROFIBUS standard specifies 6 dB here, adopted from the quoted standards including CCITT V.11. The max. cable length of 1000 m mentioned therein is assumed to have a max. signal attenuation of 6 dB between transmitter and receiver. The specified test set-up with a twisted telephone cable of 0.51 mm diameter copper and 100 Ω terminating resistance already results in a resistive attenuation of 8.6 dB.

Cable list

The data in this list have been taken from the manufacturers' data sheets. Suitability of the listed cables for PROFIBUS applications has not been verified in practice. The selection criterion was the meeting of the above specifications. The list is not complete.

Manufacturer / sales	Cable type	Impedance	No. of cores	Core cross-section	Capacitance in operation	Attenuation	Shielding	Remarks
Siemens AG	SIMATIC NET 6XV1 830-0AH10	150Ω ± 15Ω 3 ... 20 MHz	1 x 2	0.32 mm ² Cu stranded	<30 nF/km	<0.5 dB/100m 38.4 KHz	Al.-clad foil + Cu braid	Bus cable Standard with PVC sheath
Siemens AG	SIMATIC NET 6XV1 830-3AH10	150Ω ± 15Ω 3 ... 20 MHz	1 x 2	0.32 mm ² Cu stranded	<30 nF/km	<0.5 dB/100m 38.4 KHz	Al.-clad foil + Cu braid	Bus cable Buried cable
Siemens AG	SIMATIC NET 6XV1 830-0BH10	150Ω ± 15Ω 3 ... 20 MHz	1 x 2	0.32 mm ² Cu stranded	<30 nF/km	<0.5 dB/100m 38.4 KHz	Al.-clad foil + Cu braid	Bus cable with PE sheath (semi-luxury foods and tobacco)
Siemens AG	SIMATIC NET 6XV1 830-3BH10	150Ω ± 15Ω 3 ... 20 MHz	1 x 2	0.25 mm ² Cu stranded	<30 nF/km	<0.5 dB/100m 38.4 KHz	Al.-clad foil + Cu braid	Bus cable for use as trailing cable
Siemens AG	SIMATIC NET 6XV1 830-3CH10	150Ω ± 15Ω 3 ... 20 MHz	1 x 2	0.25 mm ² Cu stranded	<30 nF/km	<0.5 dB/100m 38.4 KHz	Al.-clad foil + Cu braid	Bus cable for festoons

Table 5-2: List of copper cables

Manufacturer / sales	Cable type	Wavelength used	Core diameter	Sheath diameter	Material attenuation	No. of fibers / weight per 100 m	Operating temperature	Remarks
Siemens AG	SIMATIC NET 6XV1 820-1AH10	820 nm	62.5 μm	125 μm	Glass 0.35 dB/100 m	2/9.4 kg	-25 to +60 °C	Outdoor cable Type 1
Siemens AG	SIMATIC NET 6XV1 820-2AH10	820 nm	62.5 μm	125 μm	Glass 0.35 dB/100 m	2/9 kg	-5 to +60 °C	Outdoor cable Type 2
Siemens AG	SIMATIC NET 6XV1 820-1BH10	820 nm	62.5 μm	125 μm	Glass 0.35 dB/100 m	2/22 kg	-20 to +50 °C	Indoor cable
Siemens AG	SIMATIC NET 6XV1 830-4AN	660 nm	980 μm	1000 μm	Plastic 19 dB/100 m	2/0.92 kg	0 to +70 °C	Indoor cable

Table 5-3: List of fiber-optic cables

5.2.4 Cable specifications and cable recommendation for PROFIBUS-PA**Cable specification**

A two-core cable is specified as the transmission medium for the field bus to DIN EN 61158-2. The electrical data are not specified although they govern the achievable characteristics of the field bus (possible distances, number of stations, electromagnetic compatibility). In the standard (Annex C, not for

standardization, for information only) a distinction is made between four cable types with the data presented in Table 5-4 (at 25° C).

Installations according to the FISCO model are not subject to safety restrictions if the limits given in Table 5-5 are met. Operation beyond these limits is not generally ruled out but must be considered in each case.

	Type A (reference)	Type B	Type C	Type D
Cable type	Twisted pair, shielded	One or more twisted pairs, overall shield	Two or more twisted pairs, not shielded	Two or more pairs, not twisted, not shielded
Core cross-section (nominal)	0.8 mm ² (AWG 18)	0.32 mm ² (AWG 22)	0.13 mm ² (AWG 26)	1.25 mm ² (AWG 16)
Loop resistance (DC)	44 Ω/km	112 Ω/km	264 Ω/km	40 Ω/km
Impedance at 31.25 kHz	100 Ω ± 20 %	100 Ω ± 30 %	**	**
Wave attenuation at 39 kHz	3 dB/km	5 dB/km	8 dB/km	8 dB/km
Capacitive asymmetry	2 nF/km	2nF/km	**	**
Group delay distortion (7.9 to 39 kHz)	1.7 μs/km	**	**	**
Shield coverage	90 %	**	-	-
Recommended network size (inc. spur cables)	1900 m	1200 m	400 m	200 m

(** Not specified)

Table 5-4: Cable types to DIN EN 61158-2, Section 11.7.2 and Annex C

	EEx ia	EEx ib IIC / IIB
Loop resistance (DC)	15...150 Ω/km	15...150 Ω/km
Inductance per unit length	0.4 ... 1 mH/km	0.4 ... 1 mH/km
Capacitance per unit length	80...200 nF/km ¹⁾	80...200 nF/km ¹⁾
Spur cable length	≤ 30 m ²⁾	≤ 30 m ²⁾
Cable length	≤ 1 km	≤ 5 km

¹⁾ Definition cf. PNO guide PROFIBUS-PA /505/

²⁾ Tentative values according to the FISCO model

Table 5-5: Safety limits for the bus cable

The cores of all field bus cables must be clearly selectable (for example, with color coding or ring marking). Cables with intrinsically safe circuits must be marked according to DIN 57 165/VDE 0165, Section 6.1.3.14 (for example, with a light-blue sheath).

Where multi-pair cables are used in the hazardous area, the special installation conditions of DIN 57 165 / VDE 0165 (Chapter 6) /8/ must be observed.

Cable recommendation The reference cable (Type A) must be used for conformance tests. For the new installations of plants, the cables used must meet the minimum requirements of Types A or B. With multi-pair cables (Type B), two or more field buses (31.25 kbit/s) may be operated in one cable. Other circuits in the same cable should be avoided.

Cables of Types C and D should only be used in retrofit applications (the utilization of already installed cables) with a greatly reduced network size. In these cases, allowance should be made for the fact that the interference immunity of transmission often does not meet the requirements described in the standard.

The overall cable length is defined as the total length of the main cable and of all spur cables.

No. of spur cables	Length of one spur cable, intrinsically safe	Length of one spur cable, not intrinsically safe
25-32	-	-
19-24	30 m	30 m
15-18	30 m *)	60 m
13-14	30 m *)	90 m
1-12	30 m *)	120 m

*) Tentative values according to the FISCO model (spur cable ≤ 1 m may be considered as a splice)

Table 5-6: Recommended lengths of spur cables

Overall cable length	Total length of splices
> 400 m	8 m
< 400 m	2 %

Table 5-7: Maximum lengths of splices

Cable list

The data in this list have been taken from the manufacturers' data sheets. Suitability of the listed cables for PROFIBUS applications has not been verified in practice. The selection criterion was the meeting of the above specifications. The list is not complete.

Manufacturer/sales	Cable type	Impedance	No. of cores	Core cross-section	Capacitance in operation	Attenuation	Shielding	Remarks
Siemens AG	SIMATIC NET 6XV1 830-5AH10	$100\Omega \pm 20\Omega$	1 x 2	0.75 mm ² Cu stranded	<90 nF/km	<3 dB/km 39 KHz	Cu braid	Bus cable PVC sheath, blue
Siemens AG	SIMATIC NET 6XV1 830-35H10	$100\Omega \pm 20\Omega$	1 x 2	0.75 mm ² Cu stranded	<90 nF/km	<3 dB/km 39 KHz	Cu braid	Bus cable PVC sheath, black

Table 5-8: Cable list for copper cables

5.2.5 Shielding concept

To shield or not to shield

EN 50170 Vol. 2 allows the user to decide whether to employ shielded cable. Unshielded cable is permissible in an interference-free environment. On the other hand, there is the following argument for always using shielded cable:

- An "interference-free" area exists, if at all, only in the interior of shielding cabinets. However, as soon as relays and switching contactors are installed in them, the protection is lost.

Shielding rules

For the optimum electromagnetic compatibility of systems, it is very important that the system components and, in particular, the cables are shielded and that these shields form a sheath which is as electrically seamless as possible.

To quote the "Grounding, shielding" Section of the DIN standard: "When a shielded bus cable is used, it is recommended that the shield be connected to protective grounds with low inductance at both ends, to achieve the best possible EMC. Separate potentials (for example in a refinery) are an exception; as a rule, only single-ended grounding is permitted in these cases.

Note:

In systems without equipotential bonding, circulating currents at line frequency can damage the bus cable in unfavorable cases (by exceeding the permissible shield current). In these systems, therefore, the cable shield should be directly connected to the building ground at one end only.

The connection between shield and protective ground (for example, unit housing) should preferably be made via the metal housing and the screw-type connection of the sub D connectors. Where this type of shielding is not possible, grounding can be achieved via pin 1 of the connector."

It should be noted, however, that the connection via pin 1 does not meet the "low-inductance" condition. With a view to EMC, it is better to expose the cable shield at a suitable point and ground it to the (metal) structure of the cabinet with the shortest possible cable connection (for example, with a shield clamp in front of the connector).

Shield connection

By far the most important location of the shield ground connection is at the entry of the bus cable into the cabinet. Long external cables are often routed via terminals here. For the shield connection to meet the "low-inductance" requirement, the following must be observed:

Note:

The cable shield must make contact over its circumference and have a large-area connection to the grounded structure (for example, ground bus, terminal rail).

Here are the most common mistakes resulting in non low-inductance grounding:

- Connection via a sheath wire or contact wire.
- Connection via a short length of stranded conductor (a few cm), soldered on or crimped on ("pigtail method").
- Opening up or unsplinging the cable shield and clamping it directly in a ground clamp. If the resultant ground wire is not longer than about 2 cm, this method is conditionally permissible.
- Routing of shield grounds via lengths of stranded copper conductor, even with large cross-sections (1.5 mm² Cu).

With proper clamping of the cable shield by means of a cable clamp or other clamping device, adequate contact pressure must be ensured. The clamping pressure is often exerted against the cable's insulation which creeps in the course of time. Such arrangements require very great spring excursion. The shield connection terminal of the KLBÜ series from Weidmüller is a constructive response to the problem.

5.2.6 Grounding and equipotential bonding

Protective grounding	The protection concept of the station supply governs the need for protective grounding of a bus station. Consult the manufacturer's data and local specifications.
Equipotential bonding	The RS 485 bus segment with 2 to 32 transceivers (transmitter/receiver modules) is electrically through-connected. Light equipotential bonding is therefore always provided by the bus cable. The question is whether additional, low-resistance equipotential bonding is necessary, as specified in the RS 485 standard.
Two-wire line	With a two-wire line, there is only light equipotential bonding. Isolation of the transceiver from the station with its other potential connections is unavoidable for fault-free data transmission.
Four-wire line	With a four-wire line, equipotential bonding is provided by the DGND conductor. This arrangement does not depend on isolation of the transceiver. If the DGND is grounded with two or more stations, excessive circulating currents can flow on the bus cable. For this case, RS 485 specifies a series resistance of about 100 ohms per station. Although this resistance provides protection from excessive circulating currents, it reduces the equipotential effect. Isolation of the transceiver is advantageous, even with equipotential bonding.
Conclusion	Equipotential bonding according to RS 485 is only necessary when there is no isolation of transceivers from other potential connections (such as grounded supply, great capacitive coupling of an ungrounded supply).
Hazardous area	This is an area in which the risk of explosion or a hazardous explosive atmosphere can develop as a result of local operational conditions. According to the classification of this area, there are special requirements for the use of electrical apparatus. Further explanations and instructions can be found in VDE 0165 and /519/.

5.2.7 Lightning protection

	Lightning protection is subdivided into external and internal protection. Where bus cables are routed only within a building, only the internal lightning protection need be taken into account.
External lightning protection	External lightning protection always relates to the (bus) cables routed to the plant sections located outside the building. Where cables are laid in PVC or PE tubes, a grounding cable must be laid about 0.5 m above the cables (at least 70 mm ² copper cable or 40 x 5 mm steel strip). The copper cable or steel strip must be grounded at each entrance to the building. Bus cables laid above ground must be routed in a closed steel conduit or sheet steel duct. Both the conduit and the duct must be grounded at least at the beginning, at the end and at each entrance to the building.
Internal lightning protection	All electrical and metal parts (cables, pipes, etc.) leading into a building must be incorporated in the equipotential bonding for lightning protection.

This means that all pipes (gas pipes, water pipes, cable conduits, etc.) must be directly connected to the equipotential bonding rail at the entrance to the building. The cores of power cables are connected to the equipotential bonding rail via lightning arresters. This relates to EDP and bus cables as well as low-voltage cables.

5.2.8 Connectors

PROFIBUS-DP

9-pin sub D connectors are used as the connection medium for the bus cable (and for connecting PROFIBUS-PA to the DP/PA coupler). The connection between core and socket or pin should be a screw terminal or soldered joint. The cases of the sub D connectors should preferably be metal or metalized to ensure EMC, also at the connector. Connectors should be secured to the interface or station by an electrically conductive screwed connection. DIN 41652, Part 1, applies to mechanical and electrical properties of 9-pin sub D connectors.

PROFIBUS-PA

PA terminals are used as the connection medium for the bus cable between the individual field devices. The connection between core and socket or pin should be a screw terminal or soldered joint. The cases of the PA terminals should preferably be metal or metalized to ensure EMC, also at the PA terminal.

Note:

It is not recommended that PROFIBUS-PA be looped-through via the individual field devices. Subsequent replacement of only one field device can result in a breakdown of bus communications.

Sub D connectors with solder terminals

Soldering work must be done cleanly and carefully. Additionally, a local 220/230 V outlet is needed for the soldering iron. Sub D connectors with solder terminals are very common and are available from various manufacturers.

Sub D connectors with crimp terminals

The crimping operation is relatively critical and can only be carried out with a special tool. If improperly created, crimp contacts can slip out of their seat and impair the reliability of a connection. However, the work can be carried out by one person. For production in a workshop, an automatic crimping machine can considerably facilitate and accelerate the work (stripping and crimping in one operation).

Sub D connectors with screw terminals

Apart from the screwdriver and stripping tool, no other aids are needed. As with modular terminals, screw connections are less subject to faults and considerably easier to make than a soldered joint. No power is needed for a soldering iron, nor is there any need for assistance by a second person. At present, however, there are few providers of this simple connection system (such as Phoenix Contact, Siemens, etc.).

Connectors for higher degrees of protection (IP65)

9-pin sub D connectors are not suitable for use in a harsh environment and in environments with higher degrees of protection. For these applications, there are round connectors made of metal which meet the higher

requirements. Another possibility is to provide the plug-in connection in a suitable housing and ensure the degree of protection at the cable bushings by means of suitable heavy-gauge threaded joints. (Interfaces or stations in IP65 housings)

5.2.9 Installation materials and tools

Tool for copper cable

In general, no special tools are required for fitting the copper bus cables.

Tools for fiber-optics

No particular tools are required for fitting the fiber-optic cables. However, the following points must be noted:

- Prefabricated cables are usually available from individual companies for connecting the FO components. These cables require no further treatment.
- Where connectors must be fitted to the glass FO cables on site, there are special splicing methods (mechanical or thermal) with which the connectors can be properly clamped on. Splicing is normally undertaken by trained specialists because maximum accuracy and cleanliness are essential. Connectors can be fitted to FO cables or direct connections can be made between FO cables.
- Some companies offer special installation cases containing the necessary tools and materials. Sometimes a microscope is needed in addition to the installation case.
- For simple connections, there are so-called finger splices. FO cables can be easily interconnected (without special tools) by means of mechanical self-alignment in the splice.
- Plastic FO cables can be preassembled without problems at the plant.

Installation materials

Ground cables are normally connected directly to the supporting metal structure with bolts (M6/M8/M10). To ensure a good contact, toothed lockwashers are inserted between the painted metal and the nut or cable lug. Bolts, nuts and lockwashers are therefore required as well as cable lugs.

The flexible cores of the signal cables are inserted into the terminals of the PROFIBUS components with ferrules.

The shields are connected to the metal structure by means of large-area cable clamps. Suitable cable clamps are therefore needed for the cables. It should be noted that the shield creeps under the cable clamps. This means that a tightened cable clamp becomes slack after a certain time and may no longer provide large-area contact with the shield. Either the clamps must all be retightened after about six months, or spring-loaded clamps are used to compensate for cable creep.

The sizes of the bolts, nuts, toothed lockwashers, cable lugs, ferrules and cable clamps to be procured are governed by the cross-sections of the cables and lines used.

5.3 Guidelines of the PNO (PROFIBUS Users' Organization)

Introduction

PROFIBUS is an open field bus system which is suitable for various application areas. The PROFIBUS standard is organized in four parts.

- Part 1 describes the physics and transmission mechanisms.
- Part 2 describes the FMS (field message specification) protocol which is particularly suitable for communications at cell level.
- Part 3 defines the DP (distributed I/O) protocol which is suitable for simple I/O communications and time-critical requirements.
- Part 4 describes the special definitions required for the intrinsically safe area.

References

Shown in Table 5-4 is an overview of the most important documentation on the PROFIBUS-PA topic from the PROFIBUS Users' Organization.

Title	Language
PROFIBUS Standard	
DIN 19 245 Parts 1 + 2 (PROFIBUS-FMS)	English
DIN E 19 245 Part 3 (PROFIBUS-DP)	English
DIN E 19 245 Part 4 (Part of PROFIBUS-PA)	English
PROFIBUS guidelines	
Implementation notes DIN 19 245 Part 1	German
Implementation notes DIN 19 245 Part 2	German
Implementation notes DIN E 19 245 Part 3	German
Test specification PROFIBUS-DP slaves	English
Test specification PROFIBUS-DP master devices	German
Optical transmission (fiber-optics)	English
PROFIBUS-DP function extensions	English
PROFIBUS-PA startup guide	German
PROFIBUS profiles	
Profile for communications between controllers	English
PROFIBUS-PA profile for field devices	English
Brochures	
PROFIBUS technical brochure	German / English
PROFIBUS for process automation	
Technical literature and training materials	
PROFIBUS Public 5	German / English
PROFIBUS FMS, -DP, -PA set of transparencies	German / English
M. Popp, Rapid entry PROFIBUS-DP	German / English
Software	
PROFIBUS products and services	German / English
Device database (GSD) editor	English

Table 5-9: References of the PROFIBUS Users' Organization
This literature can be obtained from:

UK: The PROFIBUS Group
1, West Street
GB-P014-4DH Titchfield, Hants

USA: PROFIBUS Trade Organization
5010 East Shea Blvd., Suite C-226
USA Scottsdale, AZ 85254-4683

Hardware configuring (project example)

6

This chapter contains:

6.1 Configuring a station	6-3
6.1.1 Creating a station and starting the hardware configuration	6-4
6.1.2 Configuring the station	6-5
6.1.3 Loading the hardware configuration into a CPU	6-7
6.2 PROFIBUS-DP distributed I/O	6-8
6.2.1 Inserting a DP slave in a station	6-8
6.2.1.1 Device database (GSD files)	6-8
6.2.1.2 Using a SITRANS P via a DP/PA coupler	6-9
6.2.1.3 Using an ET 200M with a HART module	6-10
6.3 Station diagnostics	6-11
6.4 SITRANS P parameter assignment with SIMATIC PDM	6-12

Introduction

- Where the new field engineering is not directly affected, this chapter does not cover the configuration and installation of AS and OS. Further details are described in the references from /100/.
- A knowledge of the systems and devices used is a prerequisite for understanding the following explanations.
- The communications paths within SIMATIC S7/PCS 7 are represented schematically in Fig. 6-1 to facilitate understanding.

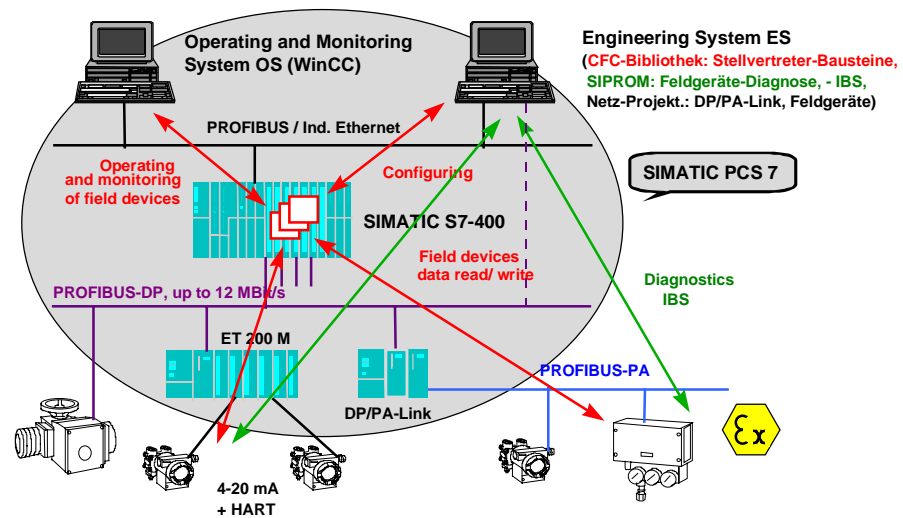

Fig. 6-1 Communications paths for the intelligent field devices within an automation system

The task

The procedure is explained in more detail on the basis of a specific task to show how PROFIBUS-PA field devices and HART modules are utilized in a project. The following points are to be implemented in the project:

- Simple level control is to be created.
- The process signal will be acquired by a field device with PROFIBUS-PA connection.
- The disturbance variable will be acquired via an analog input module with HART function, incorporated in the ET 200M I/O system.
- The actuating signal will be emitted via an analog output module without HART function via the ET 200M I/O system.
- Two separate PROFIBUS systems will be used:
 - PROFIBUS-PA (DP line 1)
 - ET 200M (DP line 2)

The level range is 0 to 20 cm. Setpoint inputs, over the range 0 to 20 cm, are to be made by the plant operator. The controller is only operated in the automatic mode. If the level of 17 cm is exceeded, an alarm message is to be sent to the OS.

Based on the task, the information flow is shown in Fig. 6-2. A block from the "Technological blocks" library is used for information processing (closed-loop control, operator action, message). Blocks from the "Field device blocks" and "Basic blocks" libraries are used for process value acquisition. Output of the manipulated variable is made by a function block from the "Basic blocks" library. You find its structure in the block diagram of a technological block. This consists of a group of basic blocks whose interconnection and parameter assignments result in a particular technological function.

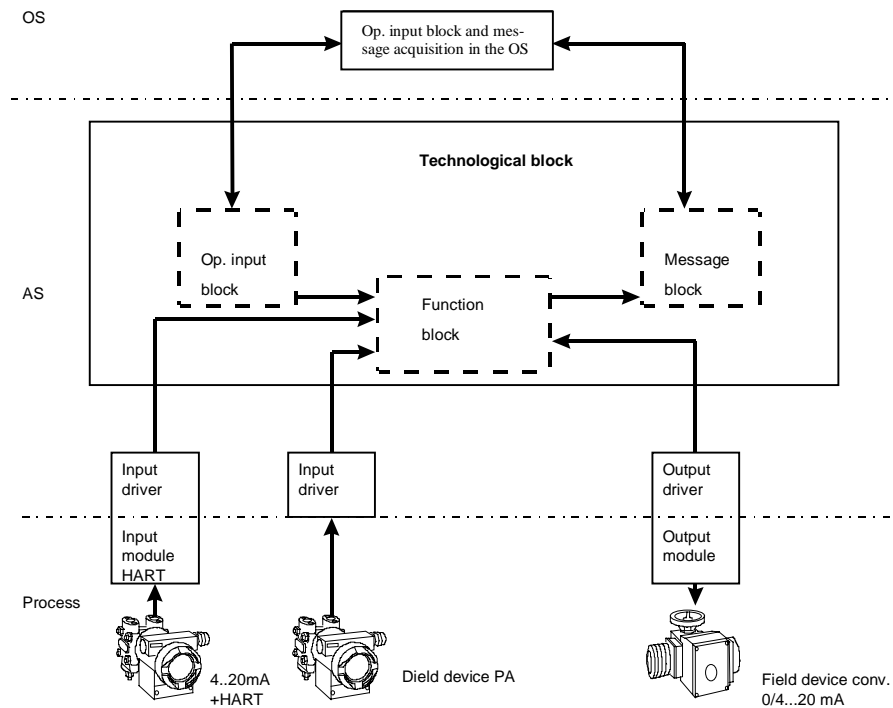

Fig. 6-2 Principle of the solution with blocks, information path

6.1 Configuring a station

Note

In this description of the configuring a station, only those aspects directly relating to the field engineering package are covered. PCS 7 is used as an example. More detailed information can be found in the extensive references in the appendix.

Fig. 6-3 below is an overview of a possible system configuration. Before you start the configuration, draw up a concept for assigning the addresses. The networks (MPI network, PROFIBUS network, etc.) are independent of each other; they each have their own number tape for the addresses.

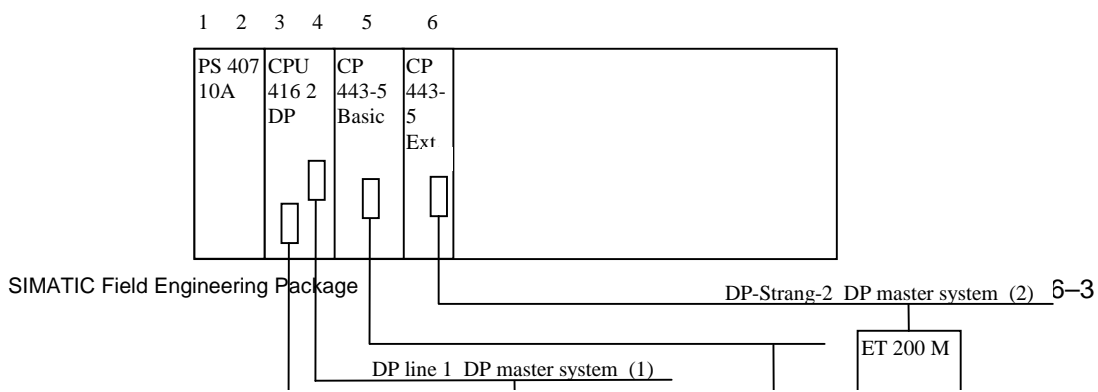

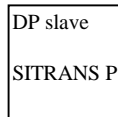

Fig. 6-3 Example of hardware configuration

Note:

Further information on configuring the hardware can be found in the manual /100/.

6.1.1 Creating a station and starting the hardware configuration

To enter into configuring and parameter assignment, you need a station in your project which you can only insert directly under a project:

- Open the SIMATIC manager.
- Open a new project with a new name (e.g. Controller).
- Mark the project in the left part of the project window.
- Using menu command **Insert > Station > SIMATIC 400 station**, insert a new object. The station will be inserted with a preset designation (e.g. SIMATIC 400 station(1), SIMATIC 400 station(2), etc.). You can replace the station designations with system-related names (such as AS1).
- When you double click on the SIMATIC station (right window) the "Hardware" icon will appear on the right window.
- Double click on the "Hardware" icon to open the configuring dialog.
- Either the hardware catalog is displayed automatically or you open the catalog with **View > Catalog**.

6.1.2 Configuring the station

Once you have created the station, assemble the hardware components as described in the task description:

- Open catalog "SIMATIC 400" in the hardware catalog

Rack

Open catalog "Rack 400" and insert basic board UR2 by double clicking (single clicking on the components will show the order number). The first slot of the rack will be automatically preselected as the current location.

Power supply

Open catalog "PS-400" and select power supply "PS 407-10A" by double clicking. HW-Config automatically places the module at the current slot in the rack and marks the next free location as the current location.

CPU

Open "CPU 400" and select CPU 416-2DP. A PROFIBUS-DP connection is integrated in this CPU, so you must configure the DP network as the next step.

Note:

Ensure that a check symbol is entered in front of "Station is connected to selected network". Only then will you have a connection to the DP network with your station.

DP line 1 (CPU)

The following steps must be taken for parameter assignment of the DP interface integrated in the CPU for DP line 1:

- Enter the address (address 2) with which the integrated DP interface can be addressed on the bus (see also Fig. 6-X).
- Enter a new subnetwork for the DP line (NEW button) and change the name to "DP line 1".
- Enter the parameters for "Network settings" according to your system (e.g. for "DP line 1" the highest PROFIBUS number: 126; baud rate: 45.45 kbit/s using a DP/PA coupler; profile: DP) and complete the menus for the DP network with "OK". "DP master system (1)" will be displayed.
- If entries are made under menu item "Lines", the bus parameters will be computed automatically.

Note:

When configuring the input/output drivers, you must convert subnetwork number "n" of the master system to hexadecimal and enter it at the parameter "Subn1_ID" or "Subn2_ID" in the CFC chart.

In our example, this is a 1 corresponding to the DP master system (1).

**DP line 2
(CP 443-5 Extended)**

You can insert another DP line in addition to the integrated DP with communications processor 443-5 Extended.

- Select the next free slot (slot 5) in your rack as the current slot by clicking once (shown in blue).
- Open Catalog "CP-400" in the hardware catalog and insert a CP 443-5 Extended in the rack. You are then automatically in the menu for configuring the DP network.

Note:

Ensure that a check symbol is entered in front of "Station is connected to selected network". Only then will you be connected to the PROFIBUS network with your CP 443-5 Extended.

- Enter the address (address 2) with which the CP 443-5 Extended can be addressed on the PROFIBUS-DP.
- Enter a new subnetwork for the DP line (NEW) button and change the name to "DP line 2".
- Double click the CP 443-5 Extended and open the "Mode" menu.
- Set the "DP master" and "Delay (ms)" to 0.
- Assign parameters to the "Network settings" menu according to your system (e.g. for "DP line 2" highest PROFIBUS number: 31; baud rate: 1.5 Mbit/s for PROFIBUS-DP/PA (according to network requirements); profile: DP) and close the menus for network configuring with "OK". A new "DP master system (2)" will be displayed.

Note:

In configuring the input/output drivers, you must convert subnetwork number "n" of the master system to hexadecimal and enter it at parameter "Subn1_ID" or "Subn2_ID".

In our example, this is a 2 corresponding to the DP master system (2).

**Small system
network (MPI)**

If you wish to create only a small network and connect it via the MPI, you must now assign parameters to the MPI of the CPU. Double click the "CPU 416-2DP" in your rack (slot 3). Enter the parameter here for the MPI integrated in the CPU.

Click on "MPI" and link the "MPI(1)" network created by the hardware configuration to the MPI by clicking (MPI(1) appears in blue). Then complete the MPI menu with "OK" twice.

The OS is incorporated into the MPI network in the same way.

**System network
(PROFIBUS)**

You need the 443-5 basic communications processor for communication between AS, ES or OS systems via PROFIBUS.

- Select the next free slot in your rack (slot 6) as the current slot by clicking once (shown in blue).
- Open "CP-400" in the hardware catalog and insert a CP 443-5 Basic into the rack. You are automatically in the menu for configuring the PROFIBUS network.

Note:

Ensure that a check symbol is entered in front of "Station is connected to the selected network". Only then will you later be connected to the PROFIBUS network with your CP 443-5.

- Enter the address with which the CP 443-5 can be addressed on the bus (e.g. address 4).
- Enter a new subnetwork for the PROFIBUS line (NEW button) and change the name to "WinCC network".
- Assign parameters to the "Network settings" menu according to your system (e.g. for the "WinCC network" highest PROFIBUS number: 126; baud rate: 1.5 Mbit/s; profile: standard) and close the menus for network configuring with "OK".

6.1.3 Loading the hardware configuration into a CPU

Configuring of the SIMATIC station is terminated and you can pass on the information to the CPU with "**Target system > Load into module**". To load the module data, the CPU must be in the "STOP" state. A menu is displayed in which you can select the target module for loading the hardware configuration. In the example, there is a choice of the "CPU 416-2 DP(1)" and "CP 443-5 Basic(1)". If you leave both modules selected, you must load both modules. The "CP 443-5 Extended" is not offered for loading because this module is loaded as the DP master via the CPU.

Note:

The first load operation of a CPU can only take place via the MPI of the CPU. The CP 443-5 for the PROFIBUS is supplied with the communications parameters. Each subsequent load operation can then take place via PROFIBUS. Ensure that the correct module is assigned in the PG/PC interface.

During loading of the "CP 443-5 Basic", two additional queries appear. You first specify that the configuration parameters are to be loaded into the RAM of the module (the parameters will be retained in the event of a power failure); additionally, you can decide whether or not the module is to be immediately restarted after loading.

6.2 PROFIBUS-DP distributed I/O

Note

The following distinctions are made in the configuring of DP slaves:

- Compact DP slaves are directly connected, individual devices (for example, SITRANS P via a DP/PA coupler).
- Modular DP slaves (for example, link modules with up to five PROFIBUS-PA lines).
- Intelligent slaves (I slaves) (DR 21 compact controllers).

Only aspects relating to PROFIBUS-DP/PA are covered. When a DP/PA coupler is used in the DP network, the connected PROFIBUS-PA field devices act as compact DP slaves. If the DP/PA couplers are grouped in a link module, the link module acts as a modular slave.

6.2.1 Inserting a DP slave in a station

6.2.1.1 Device database (GSD files)

To incorporate various PROFIBUS-PA capable field devices, the device database files supplied for the field devices must be inserted in the hardware configuration.

Copy the device database files into STEP 7 catalog "GSD" with the Explorer (standard path: SIEMENS\STEP7\S7Data\GSD).

So that the device database files will be known to the hardware configuration, the files must be updated. You carry out this operation in Step7/hardware configuration:

Tools > update device database files.

After updating, the slaves are available in hardware catalog.

Note:

If a device database file is not correctly entered during updating (error message "Device database file not found" during positioning of the DP slave) the name of the device database file must be changed so that there is an "X" as the last character of the name (e.g. old name "abc01023.GSD" new name "abc01023X.GSD").

6.2.1.2 Using a SITRANS P via a DP/PA coupler

The steps for inserting a slave in a DP/PA line are shown using the example of a SITRANS P. In this case, the PROFIBUS-PA is linked via a DP/PA coupler to the PROFIBUS-DP.

Note:

Please ensure that the hardware requirements for the PROFIBUS-PA are met and that the baud rate is set to 45.45 kbit/s.

- Open catalog "PROFIBUS-D" from the hardware catalog.
- Open catalog "SITRANS" and use the left mouse key to drag the "SITRANS P" to DP line "DP master system(1)".
- You will see a menu for entering "Select specified configuration" by preselecting the address identifiers (e.g. PV). For the SITRANS P, select the setting "4 bytes/1 byte". You will then have a 4 byte-wide measured value and a 1 byte-wide diagnostic byte in the corresponding driver (CFC chart). The selection affects the addressing of inputs and outputs and, therefore, the configuration. Information on the different specified configurations can be found in the documentation of the relevant devices. Exit the menu after setting the PROFIBUS address with "OK".
- You will see a menu for making entries for "PROFIBUS station SITRANS". Please enter the slave address, name and DP line name. However, changes to the bus characteristics affect all the slaves situated on the line and also change the bus characteristics already set for the master.
- Store the current configuration and load it into your CPU as described in /234/.

6.2.1.3 Using an ET 200M with a HART module

ET200M

The steps for inserting a modular slave into a DP line are shown using the example of an ET 200M with an HART module. DP line 2 was configured as described in Section 6.1.2.:

- Open catalog "PROFIBUS-DP" from the hardware catalog.
- Open "ET 200M" and use the left mouse key to drag "IM153-2" to DP line "DP master system(2)".

Note:

Remember that you can use a passive backplane bus or an active backplane bus (removal and insertion of I/O modules during operation).

- Enter the address of the ET 200M. A menu will appear for entering the "PROFIBUS station characteristics". The subnetwork will be automatically set by allocating the IM 153-2 to a line. Additionally, you can change the characteristics of the DP line (highest number of stations, baud rate, profile). However, changes will affect all the slaves situated on the line and will change the bus characteristics already set at the master. Exit the menu with "OK" after setting the bus number.
- Select the first slot in the ET 200M (slot 4) as the current slot (blue surrounding) and open the hardware catalog of the IM 153-2, which you have dragged to the line.
- Open a module type "AI-300" (analog inputs) and select module SM 331 AI2xHART by double clicking. This module will automatically be assigned to the current slot in the ET 200M, and the next free slot will become the current slot.
- Then open module type "AO-300" (analog outputs) and select module SM 332 AO 4x0/4..20mA by double clicking. This module will automatically be assigned to the current slot in the ET 200M, and the next free slot will become the current slot.

Note:

Please ensure that you do not use 8 analog modules with 8 channels each in an ET 200M. Eight analog modules with 8 channels each (2 bytes per channel = 16 bytes) occupy 128 bytes in an ET 200M. However, the IM 153 only allows 124 bytes of useful data; the remaining 4 bytes are diagnostic data. /140/

- After assigning the modules to the slots, you can double click a module in the ET 200M to set the characteristics of the module (current or voltage, live or dead zero, etc.). For assigning parameters to the individual modules, please consult the module descriptions.

Note:

When you select an ET 200M, a detailed view of the configured modules in the selected ET 200M will appear, displayed line by line in a table.

HART module

The HART module is represented on three lines in the detailed view of the ET 200M:

1. HART module itself
 2. HART channel 1
 3. HART channel 2
- By double clicking the first line of the displayed HART module, you can set the characteristics of the module (current signal, live or dead zero, diagnostic alarm, etc.). For the assignment of parameters, please consult the module description /503/.

Note:

For operation without HART functions, you can use the current range 0/4 to 20 mA; for operation with HART function the current range of 4 to 20 mA defined in the HART device will apply.

- Store the current configuration and load it into your CPU.

SIMATIC PDM

By double clicking the first or second channel of the displayed HART modules, you start the SIMATIC PDM parameter assignment software tool. A device selection window will open first. All the HART protocol-capable field devices available in SIMATIC PDM will appear in the device selection window.

The remaining procedure is the same as that described in Section 6.4 as an example for a PROFIBUS-PA device.

6.3 Station diagnostics

You have the facility for reading out the current status of modules for a configured station. A prerequisite is that there is a connection between automation system and PC/PG.

- In the SIMATIC Manager, select the menu command "**View > Online**". You will see an online view of you station.
- Open the AS from which you wish to read the diagnostic data (click on the "+" in front of the AS).
- Open the CPU.
- Select the program in the CPU with a click.
- Execute menu command "**Target system > Module state**".

- Select "Diagnostic buffer" in the menu.

In the "Events" window, you will see messages of events in brief form. If you click onto an event in this window, a detailed description of the event will appear in the lower window. By clicking on "Event help" you can obtain further instructions as to the assessment of events or clearing of an existing fault.

6.4 SITRANS P parameter assignment with SIMATIC PDM

Note	Section 6.1.1.2 describes how you incorporate a field device with PA profile in the hardware configuration. This section shows how you can assign parameters to this field device with parameter assignment tool SIMATIC PDM. However, only a few aspects are mentioned here. The online help is expressly referred to. The parameter assignment interface represented by SIMATIC PDM largely results from the DD description supplied with the field devices. A description of individual parameters and parameter assignment operations can be found in the device manuals. The online help is available for further support.
Start	You start SIMATIC PDM by double clicking on the field device symbol in the hardware configuration.
Device selection	<p>In the device selection window, you will find all the field devices available in SIMATIC PDM which may pertain to a device database (GSD).</p> <ul style="list-style-type: none"> • Double click onto the SITRANS P symbol on the DP line to obtain the "Device selection" menu. • Open catalog "PROFIBUS-PA". • Open catalog "Siemens". • Select the device type (SITRANS P). • Select the type of measurement (absolute pressure). • Select the measuring range (250 mBar).
Access authorization	<p>The access authorization (password) for the parameter groups in SIMATIC PDM is defined in the "user" window. A distinction is made between two access authorizations:</p> <ul style="list-style-type: none"> • The specialist has access to all writable parameters. • The maintenance operator has only restricted read/write access to the parameters.
Start menu	<p>The display which opens consists of three parts:</p> <ul style="list-style-type: none"> • Menu bar for data management / data transfer

- Parameter tree for fast access to individual parameter groups
- Parameter list

The contents of the parameter tree and parameter list are governed by the DD description.

Parameter lists

You can change all parameter fields with a white background in parameter lists. Changed parameters and the corresponding parameter tree branch are marked. The marking is only removed:

- Upon archiving in the database;
- upon transfer of the parameters to the field device.

Data management

The data record of each field device can be

- edited offline;
- archived in a database;
- read out of the field device;
- transferred to the field device
- or printed.

Online functions

The following online functions can be used with SIMATIC PDM:

- Measured value indication with status
- Alarm status
- Device status
- Address change

Software configuring (project example)

7

This chapter contains:

7.1 Project example: Control loop (CFC)	7-3
7.2 Project example: Sequential control system with two-step control (SFC)	7-6

•

The task

On the basis of the task described in Chapter 6, the first example in this chapter describes the implementation of the control loop as a continuous control loop using the CFC configuring tool. In the second example, the control loop is described as a two-step control loop using the SFC configuring tool.

7.1 Project example: Control loop (CFC)

CFC

The continuous function chart (CFC) is a graphics editor. It serves to create an overall software structure for a CPU from prepared blocks (blocks written by the user or adopted from libraries). The blocks are positioned on function charts, assigned parameters and interconnected. This results in an automation structure which is loaded into the AS after generation of the executable machine code.

Note:

A detailed description of the CFC can be found in the manual /254/.

Basic mode of operation

You work with graphics in the CFC editor: You select prepared blocks from the available set of blocks, position them with drag&drop on the chart, a kind of "drawing sheet", and interconnect them with mouse clicks. You need not be concerned with such details as algorithms or the allocation of machine resources, but can concentrate on the technological aspects of configuring.

The run characteristics of the blocks are defaults but can be adapted separately for each block. A considerable aid to working is that you can copy individual blocks or entire groups of blocks from chart to chart or shift them. The block interconnections are retained.

When you have created all the functions, you generate the executable machine code by clicking the mouse, load it into the target system and test it with the CFC test functions provided for the purpose.

Selecting the blocks

Implementation of the solution principle shown in Fig. 6-2 is executed in steps. The AS hardware was configured with STEP 7 resources in Chapter 6, i.e. it is already known which analog input/output modules will be used, in which rack and at which slot they are installed and to which module channel the relevant level sensor (PROFIBUS-PA), flow sensor (HART) or actuator (control valve) is connected. The software can be structured under CFC with this assumption. For use of the blocks under simple STEP 7 methods (STL) however, you must program the interconnections, parameter assignments, allocation of various flags and block calls in the corresponding OBs. In neither case do you need to program and test the various functions used. In this example, we use the extensive block libraries made available to you in PCS 7.

Drivers

- Block IN_A1 is selected from the "Driver blocks" section of the "Basic blocks" library for reading in the temperature (analog input module SM 331 AI2xHART is supported by it).
- The PA_AI block is selected from the "Driver blocks" section of the "Field device blocks" library for reading in the level (the SITRANS P pressure transducer is supported by it).
- The OUT_A1 block is selected from the "Driver blocks" section of the "Basic blocks" library to output the manipulated variable of the controller (the accepted analog output module is supported by it).
- Make a note of the subnetwork, rack and slot numbers of the modules used (you defined these with STEP 7 during hardware configuring), the channel numbers and measuring ranges of the connected process signals for modules with the ET 200M. You must use these specifications when structuring the individual driver blocks.
- Make a note of the subnetwork and slave numbers of the connected PROFIBUS-PA devices (you defined these with STEP 7 during hardware configuring). You must use these specifications when structuring the individual driver blocks.

Function blocks

The tasks of operating, controlling and signaling can be handled with a single block, the CTRL_PID block. It has all the necessary characteristics for the task presented:

- PID controller
- Operable with limits
- Signaling capability

This block can be found in the "Technological blocks" library.

Note:

Compared to the solution from the "Basic blocks" library, this solution for the subtasks (control, limit monitoring, operating and monitoring as well as signaling) with a CTRL_PID block results in a shorter runtime, smaller memory requirement and lower structuring overhead.

Structuring the blocks

Described in the following is the procedure using the CFC for the task (as the standard tool for configuring process-engineering plants). For details of the CFC handling or project management, please consult the CFC manual.

- Place a chart with a designation corresponding to the task (e.g. LICA_123) in the chart container of your project.

- Open the chart.
- Position one entity of each of the previously selected block types (in the example, one IN_A1, PA_AI, OUT_A1, CTRL_PID in each case) on your chart by transferring it from the block library.
- Name the blocks according to your wishes.
- For editing (CFC keyword "Run characteristics") register all entities in a common time-interrupt OB (e.g. OB32). In the sequence for block calls from the OB, the general rule "Read in→Edit→Output" must be followed. To specify the sequence, you must establish where each block obtains its parameters. As a rule, it must be reported to all other blocks from which it obtains interconnected values. In this example:
IN_A1, PA_AI, CTRL_PID, OUT_A1.
- Interconnect the outputs of the blocks supplying values to the corresponding inputs of the blocks which process these values.
- With each entity, assign parameters to the inputs whose default values must be adapted to specific process specifications. In this example, those are at least the following parameters:
 - – IN_A1: SUBNET1_ID, RACK1_NO, SLOT1_NO, CHANNEL, VHRANGE, CUR_VOL.
 - – CTRL_PID:
 - – Adapt GAIN, TN, TV and TM_LAG to the plant behavior.
 - – SP_HLM, SP_LLM for setpoint limiting.
 - – PVH_ALM and message text (if desired) for OS.
 - – OUT_A1: SUBNET1_ID, RACK_NO, SLOT_NO, CHANNEL, UHRANGE, CUR_VOL
- Interconnect the outputs to the inputs according to the diagram in Fig. 6-2.
- Generate the AS code and load it into the AS. Test the structure with the online testing aids.
- Configure the OS image block of the CTRL_PID (see its description, section entitled "Operator control and process monitoring via OS" /254/).

Note:

This simple example contains no reaction to error indications of the individual blocks. The example can be extended by inserting MUX2_R blocks at various points in the structure. These can be interconnected to the error outputs of the blocks (ENO or QERR) to provide a safety/substitute value for further processing in the event of an error.

7.2 Project example: Sequential control system with two-step control (SFC)

SFC

A sequential function chart (SFC) is a sequential control system. The SFC editor is a tool for creating sequential control.

In the following text, SFC is understood to mean either the sequential control system or chart or the editor, according to the context.

An SFC is uniquely allocated to a CPU where it is fully processed. However, it may also relate to automation functions of other CPUs.

Basic method of operation

In the SFC editor, you create the chart with graphics. The structural elements of the chart are positioned according to specific rules. You need not be concerned with details such as algorithms or the allocation of machine resources, but can concentrate on the technological aspects of configuring.

When the chart topology has been created, you change to the detailed representation (zoom configuring) and assign parameters to the individual elements; this means you configure the actions and conditions.

After configuring, you let the SFC generate the executable machine code; you then load it into the target system and test it with the SFC test functions.

After transfer of the charts, WinCC offers you a convenient graphic visualization of your charts without additional configuring overhead (SFC visualization).

- Insert an SFC in your chart container. You can change the chart name under **Characteristics**.
- Open the chart with a double click and create your sequential control system.
- For editing (**Characteristics >Run**) register the chart in a time-interrupt OB (e.g. OB34).
- In all representations (SIMATIC manager, dialog fields for selecting the charts, reference data, documentation, etc.) the chart name is extended to include the technological hierarchy if it is assigned to a hierarchy container.

Additional run characteristics

By clicking "Characteristics", you open a second dialog field for checking and for entering additional run characteristics.

- Leave the default "1" for reduction unchanged. This means that the SFC will be processed with each run.
- A phase shift to achieve a different load distribution within the CPU is not required in this project. Therefore, leave the default "0" unchanged.
- Click the Autostart field so that the sequential control system will be started immediately after loading into the AS.
- The default mode "Step control with transition (SSMT)" also remains unchanged because the SFC is to run automatically without other operator actions.
- For run options, click the field for cyclic operation and for command output; leave the time monitoring switched off.
- Close both dialog fields successively with "OK". You can now turn to configuring the chart topology.

Chart topology

You now create the structure of the sequential control system. You have decided which actions and conditions are necessary for the two-step control, and insert the basic and structural elements accordingly.

- Insert the transitions, steps and loops into the chart.

Detailed configuring

For the next configuring step, go over to the detailed representation of the steps and transitions. The assigning of parameters to these elements is therefore also known as "Zoom configuring".

The steps and transitions are linked to the "Block world" with zoom configuring.

- Open the "Object characteristics" dialog field for the first step and edit it. Then work step by step, followed by all transitions in succession.

Compiling

You must then compile the graphically created chart in the machine code of the target system.

- Click on "Compile..." in the "Chart" menu.
- The "Compile" dialog field is displayed. It contains the name of the target system (CPU414-2 DP1) and the chart container name whose contents will be compiled. The scope of compilation can be selected with the option buttons "All" or "Delta".

Loading the AS

After compilation, the dialog field appears with the result protocol. There are no errors and no warnings; you can now close the dialog field. The compilation is completed and the blocks have been generated. The next stage is to load the generated program into the target system.

Target system > Load

Note:

A detailed description of SFC charts can be obtained from the manual \255\.

Visualization in WinCC

You transfer your created SFC charts to the WinCC data store. Without additional configuring overhead, you can then display the current status of the sequential controllers in the WinCC runtime, and operate the control system according to the preset authorization stage.

- In key set 2 (Runtime), click on the button for SFC visualization.



- From the displayed overview, select your desired chart; you will see the selected chart in the overview.
- Double-click the overview and you will see a detailed view of your chart.
- In the detailed view, you can control the chart (switch on, switch off, step control with transitions, step control with condition, etc.) and use a double click to display the transitions or steps with the current statuses and remarks from the engineering system.

Furthermore, you have a facility for incorporating an SFC standard display in a process display. The chart will then be allocated to a process display and the operator need not filter out the required chart from a large number of them.

Displaying the SFC image

Insert the "SFC control" image block in your display.

Connecting the SFC display

- In the dynamic wizard, select "SFC" from the upper window.

Note:

When you display an SFC image in a process image for the first time, the script for the "SFC display" is not yet available. In this case, click onto the "Read in..." button in the displayed dialog field and insert the script "Script.wnf" (path: WinCC\wscripts\wscripts.deu).

- Select your desired chart and specify the window with which the SFC is to be displayed after clicking the corresponding button in the SFC display (overview or extract). Exit the wizard.
- Store your process display and exit the graphics designer.

References

A

- /100/* Installationshandbuch: Automatisierungssysteme S7-400, M7-400, Aufbauen
- /101/* Referenzhandbuch: Automatisierungssysteme S7-400, M7-400, Baugruppendaten
- /102/* Operationsliste: Automatisierungssystem S7-400, CPU 414/416
- /140/* Dezentrales Peripheriegerät ET 200M Handbuch
- /141/* Dezentrales Peripheriegerät ET 200L Handbuch
- /231/* Benutzerhandbuch: Basissoftware für S7 und M7, STEP 7
- /232/* Handbuch: AWL für S7-300/400, Bausteine programmieren
- /233/* Handbuch: KOP für S7-300/400, Bausteine programmieren
- /234/* Programmierhandbuch: Systemsoftware für S7-300/400, Programmwurf
- /235/* Referenzhandbuch: Systemsoftware für S7-300/400 System-und Standardfunktionen
- /236/* Handbuch: FUP für S7-300/400 Bausteine programmieren
- /237/* Gesamtindex, STEP 7
- /250/* Handbuch: SCL für S7-300/400, Bausteine programmieren
- /251/* Handbuch: GRAPH für S7-300/400, Ablaufsteuerungen programmieren
- /252/* Handbuch: HiGraph für S7-300/400, Zustandsgraphen programmieren
- /253/* Handbuch: C für S7-300/400, C-Programme erstellen
- /254/* Handbuch: CFC, Basis-Teil und Systemspezifischer Teil: S7 / M7 Technologische Funktionen grafisch verschalten
- /255/* Handbuch: Process Control System PCS 7, SFC Technologische Ablaufsteuerungen projektieren
- /256/* Handbuch: Process Control System PCS 7, ES Anlagen technologisch und phasenübergreifend strukturieren

- /257/** Handbuch: Process Control System PCS 7,
BATCH flexible-System Chargenprozesse automatisieren
- /258/** Referenzhandbuch: Process Control System PCS 7,
Bibliothek Basisbausteine
- /259/** Referenzhandbuch: Process Control System PCS 7,
Bibliothek Technologische Bausteine
- /260/** Referenzhandbuch: Process Control System PCS 7,
Bibliothek Feldgerätebausteine
- /261/** Systembeschreibung: Process Control System PCS 7
- /280/** Programmierhandbuch: Systemsoftware für M7-300/400,
Programmentwurf
- /281/** Referenzhandbuch: Systemsoftware für M7-300/400,
System- und Standardfunktionen
- 282/** Benutzerhandbuch: Systemsoftware für M7-300/400,
Installieren und Bedienen
- /290/** Benutzerhandbuch: ProC/C++ für M7-300/400,
C-Programme erstellen
- /291/** Benutzerhandbuch: ProC/C++ für M7-300/400,
Debugger für C-Programme
- /300/** Broschüre: SIMATIC WinCC,
Windows Control Center
- /301/** Handbuch: SIMATIC WinCC,
Control Center + Global Script + User Administrator
- /302/** Handbuch: SIMATIC WinCC,
Graphics Designer
- /303/** Handbuch: SIMATIC WinCC,
Tag Logging + Alarm Logging + Report Designer
- /304/** Handbuch: SIMATIC WinCC Options,
Basic Process Control + Advanced Process Control + ChipCard +
Video
- /500/** Handbuch: SIMATIC Communications,
NCM S7-H1 (Ethernet)
- /501/** Handbuch: SIMATIC Communications,
NCM S7-L2 (PROFIBUS)
- /502/** Handbuch: SIMATIC,
Buskopplung DP/PA
- /503/** Automatisierungssystem: SIMATIC ,
S7-300,M7-300,ET200M
Ex-Pheripheribaugruppen
Referenzhandbuch
- /504/** Getting up: SIMATIC PCS 7,
Leitfaden

- /505/** PROFIBUS-PA ,
PNO - Leitfaden
- /506/** PROFIBUS Standard,
DIN 19 245 Teil 1 + 2 (PROFIBUS-FMS)
- /507/** PROFIBUS Standard,
, DIN E 19 245 Teil 3 (PROFIBUS-DP)
- /508/** PROFIBUS Standard
,PNO - Leitfaden DIN E 19 245 Teil 4 (Teil von PROFIBUS-PA)
- /509/** PROFIBUS Richtlinie ,
Implementierungshinweise DIN 19 245 Teil 1
- /510/** PROFIBUS Richtlinie ,
Implementierungshinweise DIN 19 245 Teil 2
- /511/** PROFIBUS Richtlinie ,
Implementierungshinweise DIN E 19 245 Teil 3
- /512/** PROFIBUS Richtlinie ,
Prüfvorschrift PROFIBUS-DP Slaves
- /513/** PROFIBUS Richtlinie ,
Prüfvorschrift PROFIBUS-DP Master Geräte
- /514/** PROFIBUS Richtlinie ,
Optische Übertragungstechnik (LWL)
- /515/** PROFIBUS Richtlinie ,
PROFIBUS-DP Funktionserweiterungen
- /516/** PROFIBUS Richtlinie ,
PROFIBUS-PA Inbetriebnahmeleitfaden
- /517/** PROFIBUS Profile ,
Profil für die Kommunikation zwischen Controllern englisch
- /518/** PROFIBUS Profile,
PROFIBUS-PA Profil für Feldgeräte

- /519/** Automatisierungssystem: SIMATIC ,
S7-300,M7-300,ET200M
Ex-Pheripheribaugruppen
Grundlagen Explosionschutz

Index

B

A

Addressing 3–7

B

Bending radius 5–7

Block libraries 3–13

Bus cycle time 3–6

Bus system 5–2

C

Cable capacitance 5–8

Cable laying 5–6

Cable specification 5–8, 5–9

Cable type 5–8

Cables 5–6

CFC 7–2

COM PROFIBUS 2–5

Communications paths 6–2

Configuring 2–5, 6–3

Conformity 1–2

Connection system 5–2

Connectors 5–14

D

Data transmission 5–4

DD 3–12

Device database 6–8

Device database file 3–12

Device description 3–12

Device profiles 3–9

Driver function blocks 3–13

E

Equipotential bonding 5–6, 5–13

F

Field device blocks 2–5, 3–13

G

Grounding 5–13

GSD 3–12

H

Hardware 3–2

Hardware components 2-2
Hardware configuring 2-5
HART 1-6, 1-12, 2-3, 3-9
HART modules 3-4

I

Impedance 5-8
Installation 5-4
Installation guidelines 5-1
Installation site 5-4
Installing 5-6
Interface module IM 157 3-3
Interoperability 3-10

L

Lightning protection 5-13
Link 1-9, 2-3, 3-7, 3-8

M

Machine code 7-2

P

PA profile 3-9, 3-11
Parameter assignment 2-5
Potential savings 1-10
Power consumption 5-3
PROFIBUS 1-5
PROFIBUS DP 1-5, 1-7
PROFIBUS PA 1-5, 1-8
Project scope 3-6

R

Redundancies 5-4

RS 485 5-9

Run characteristics 7-6

S

Sequential control system 7-5
SFC 7-5
Shield 5-6
Shielding 5-8
Shielding concept 5-11
Signal attenuation 5-8
PDM 2-5, 6-12
Small system network 6-6
Station diagnostics 6-12
System network 6-7

T

Tools 5-15

Transceiver 1-9, 2-2, 3-6, 3-7

Glossary

C

A

- Address** An address is the identification for a particular operand or operand range.
Examples: input I 12.1, flag word FW 25, data block DB 3.
- Analog module** Analog modules convert analog process values, such as temperature, to digital values which can be further processed by the CPU, or convert digital values to analog manipulated variables.
- Arrangement, centralized** There is a centralized arrangement when the process I/Os and CPU are accommodated in the same rack or in expansion units in the same or adjacent cabinet.
- Arrangement, distributed** There is a distributed arrangement when the process I/Os are not arranged with the CPU in the same rack or in the same or adjacent cabinet, but are separated and interconnected by a communications bus (e.g. field bus).
- Automation system** An automation system is a → programmable controller with control system functionality, comprising at least one → CPU, various input and output modules as well as HMI devices.

B

- Backplane bus** The backplane bus is a serial data bus via which the modules communicate with each other and via which they are supplied with the required power. The connection between the modules is provided by bus connectors.
- Baud rate** The baud rate is the speed of data transmission; it indicates the number of bits transmitted per second (baud rate → bit rate).
Baud rates of 9.6 kbaud to 12 Mbaud are possible with the ET 200.
- Blocks** Blocks are parts of a user program, demarcated by their function, structure or purpose.
- Bus segment** → Segment

C

- Central section** The central section of an AS comprises the following components: CPU, rack, power supply, main memory and load memory. The basis is the SIMATIC S7-400 automation system.
- CFC** A continuous function chart makes function charts in which blocks can be interconnected and assigned parameters.
- Chart** A chart is the highest hierarchical level of a hierarchical block entity system. It has an implicit type but no interface and therefore cannot be connected. Charts cannot contain charts.
- Cold restart** During the startup of the AS CPU (e.g. when the mode switch is changed from

	STOP to RUN or upon POWER ON), either organization block OB 101 (warm restart only with the S7-400) or organization block OB 100 (cold restart) is first processed before the cyclic program processing (OB 1). With a cold restart, the process image of the inputs is read in and the S7 user program is processed, starting with the first command in OB 1.
Configuration	The assignment of modules to racks/slots and addresses. A distinction is made between the actual configuration (modules plugged in) and the specified configuration. You preset the latter with STEP 7, COM PROFIBUS (or COM ET 200 Windows). The operating system can thus detect modules inserted incorrectly during the → start.
CPU	Central processing unit of the S7 automation system with its control and arithmetic unit, memory, operating system and interface for programming device.
D	
Device description (DD)	This is a universal, standardized device and parameter description for PROFIBUS-PA and HART protocol-capable field devices.
Distributed I/O	The distributed I/O are devices situated at a distance from the central section and serve for input/output (e.g. field devices or analog and digital modules).
DP address	Each station must be given a DP address for unique identification on the PROFIBUS-DP. The PC/PG or ET 200 handheld have the DP address "0". The DP master and DP slaves have a DP address in the range 1 to 125.
DP master	A → master which behaves according to standard EN 50170, Volume 2, PROFIBUS, is known as a DP master.
DP slave	A → slave which is operated on PROFIBUS with the PROFIBUS-DP protocol and which behaves according to standard EN 50170, Volume 2, PROFIBUS, is known as a DP slave.
DP standard	DP standard is the bus protocol according to standard EN 50170, Volume 2, PROFIBUS.
E	
Engineering system	A PC-based configuring system with which the process control system can be configured or adapted to the required tasks, in a convenient and visual manner.
ES	→ Engineering system
ET 200	The ET 200 distributed I/O system with the PROFIBUS-DP protocol is a bus for connecting distributed I/Os to a CPU or adequate DP master. ET 200 is characterized by fast reaction times because only a few data (bytes) are transferred. ET 200 is based on standard EN 50170, Volume 2, PROFIBUS. ET 200 operates according to the master-slave principle. DP masters can be, for example, the IM 308-C master interface or the CPU 315-2 DP. DP slaves

can be the distributed I/Os ET 200B, ET 200C, ET 200M, ET 200U or DP slaves from SIEMENS or other manufacturers.

F

Field devices

Intelligent field devices can be connected via their field bus interface over PROFIBUS-DP or PROFIBUS-PA, and thus linked to the control system. Substitute blocks are available for the SIEMENS field devices.

FO

The abbreviation for fiber optic (cable) the transmission medium for PROFIBUS.

Function block

According to IEC 1131-3, a function block (FB) is code block with static data which has a "memory". A function block offers the facility for transferring parameters in the user program. Function blocks are thus suitable for programming frequently recurring complex functions such as closed-loop controls and mode selection.

G

H

I

I/O bus

Part of the S7 300 → backplane bus in the automation system, optimized for the fast exchange of signals between the IM 153 and the signal modules. Useful data (e.g. digital input signals of a signal module) and system data (e.g. _default parameter data records of a signal module) are transferred via the I/O bus.

IP 20

Degree of protection to DIN 40050: Protection against touching with the fingers and against the ingress of solid foreign bodies with a diameter of more than 12 mm.

J

K

L

M

Master

When a master is in possession of the token, it can send data to other stations and request data from other stations: → DP masters are, for example, the CPU 416-2 DP or IM 308-C.

Master-slave procedure

A bus access process with which only one station is the → DP master and all other stations are the → DP slaves.

Message class	The message class governs the nature of the message. With SIMATIC PCS 7 the message classes are alarm, warning, tolerance, AS and OS control system message, process message, operator input request and operator input message.
Message type	There is a further subdivision for each message type (e.g. alarm, warning, tolerance). Together with the message class, this governs the type of message. Examples of messages types are alarm_high, alarm_low, warning_high, warning_low.
Messages, configuring of	The creating of messages with their texts and attributes. Messages are configured from the CFC/SFC.
Module parameters	Module parameters are values with which the behavior of the module can be set. A distinction is made between static and dynamic module parameters.
MPI	The multipoint interface is the programming device interface of SIMATIC S7. It forms the entry level of a system bus with SIMATIC PCS 7.
N	
Network	A network comprises one or more linked subnetworks with any number of stations. Two or more networks may exist side by side.
O	
ODBC	The abbreviation for open database connectivity. This is a Microsoft technology enabling database access.
OLE	The abbreviation for object linking and embedding. This is a Microsoft technology enabling the linking of and data interchange between programs.
OLM	The abbreviation for optical link module. This is an element for connecting the redundant FO cable of PROFIBUS to the components of PCS 7.
OM	The abbreviation for object manager. OMs manage objects persistently stored there. Applications operate with these objects and execute operations on them exclusively by invoking object methods.
Organization block	Organization blocks (OB) form the interface between the operating system of the AS CPU and the user program. The sequence for processing the user program is specified in the organization blocks.
OS	Operator control and process monitoring system.
P	
Parameter	A parameter is: 1. a variable of an S7 code block (current parameter, formal parameter); 2. a variable for setting the behavior of a module. Each parameterizable module has, when supplied, a meaningful basic setting which can be changed by STEP 7.
PCS	Process control system.

PLC	Programmable (logic) controller
PMC	Process monitoring and control. Communications mechanisms with SIMATIC S5 and S7.
Process variable	The process variable is a resource-neutral (project-global) object. It serves for linking the AS configuring world (STEP 7, CFC...) to the OS configuring world (WinCC). It possesses information about the location at which the process variable exists at runtime (e.g. network address in the AS) and information on specific OS-relevant characteristics.
PROFIBUS	PROcess Field BUS, the European process and field bus standard defined in the PROFIBUS standard (EN 50170). It specifies the functional, electrical and mechanical characteristics for a bit-serial field bus. PROFIBUS is a bus system for networking PROFIBUS-compatible automation systems and field devices at the cell and field levels. PROFIBUS is available with the protocols DP (→ distributed I/O), FMS (→ fieldbus message specification) or TF (→ technological functions).
PROFIBUS-DP	The PROFIBUS bus system with the DP protocol. DP stands for distributed I/O (periphery). The ET 200 distributed I/O system is based on standard EN 50 170, Volume 2, PROFIBUS.
Programmable (logic)	A controller whose function is stored in the control unit in the form of a program. Thus the configuration and wiring of the unit do not depend on the function of the controller. The PLC has the structure of a computer; it consists of a CPU with memory, input/output modules and internal bus system. The I/Os and programming language are oriented to the requirements of the control system.
Project	A project is a container for all objects of an automation solution, irrespective of the number of stations, modules and their networking.
Q	
R	
Release	All products with an order number have a release; it indicates the version of the product. The release is incremented with upward-compatible function extensions, for production-related modifications (the use of new parts / components) and for error corrections.
S	
Segment	The bus cable between two terminating resistors forms a segment. A segment contains 0 to 32 → stations. Segments can be linked via RS 485 repeaters.
SFB	Standard function block, a preprogrammed function block with a defined application-specific function.
SFC	A sequential function chart serves for creating sequence controllers for

	SIMATIC S7. These can be visualized with the SFC visualization package on the OS.
SIMATIC PCS 7	This is the name of the new control system based on SIMATIC S7.
Slave	A slave may only exchange data with the master upon request by the master. Examples of slaves are all DP slaves such as the ET 200B, ET 200C, ET 200M, etc..
SPC/SQC	The abbreviation for statistical process control/statistical quality control. Methods for quality control by acquiring and evaluating statistical values.
Standard function blocks	These are blocks for the CFC which are provided by the SIMATIC PCS 7 libraries.
Start events	Start events are defined events such as faults or alarms and initiate the operating system to start a corresponding organization block.
Startup	This is run through during the transition from the STOP state to the RUN operating state. It can be initiated by a POWER ON or by the ES.
Station	A unit which can send, receive or amplify data via the bus, e.g. DP master, DP slave, RS 485 repeater, active star coupler.
STEP 7	A programming language for creating user programs for SIMATIC S7 controllers.
Symbol	A symbol is a name defined by the user, taking syntax specifications into account. This name can be used for programming and for operator control and process monitoring according to the definition for which it stands (e.g. variable, data type, jump label, block). Example: Operand: I 5.0, data type: BOOL, symbol: emergency-off button
Symbol table	A table for assigning symbols (→ name) to addresses for global data and blocks. Example: Emergency-off (symbol), I 1.7 (address), controller (symbol), SFB 24 (block).
System bus	This is the bus to which all components such as the AS, OS and ES are connected and with which they exchange data with one other.
T	
Terminating resistor	A terminating resistor is a resistor for matching the line at the bus cable; terminating resistors are required at the cable and segment ends. With ET 200, the terminating resistors are switched on/off in the → bus connector.
Type	A type represents a pattern for any number of entities and describes how these entities are structured internally. All entities of a type follow the same basic definition with respect to behavior and information structure (data structure), but contain individual data.

U**User function block**

A block type created by the user for utilization by the CFC. Block types are created, for example, by SCL → Type.

User program

The user program contains the structure for the automation programs, as well as the data for the signal processing with which a plant or process can be controlled.

V**W****X****Y****Z**

