

SIEMENS

SIPROTEC 5 Engineering Guide DIGSI 5

V8.83 and higher

Manual

Preface

Table of Contents

Overview DIGSI 5

1

Essential Steps during Engineering

2

Loading the Configuration into the
SIPROTEC 5 Device

3

Upgrading Device Functionality

4

Index

**NOTE**

For your own safety, observe the warnings and safety instructions contained in this document, if available.

Disclaimer of Liability

Subject to changes and errors. The information given in this document only contains general descriptions and/or performance features which may not always specifically reflect those described, or which may undergo modification in the course of further development of the products. The requested performance features are binding only when they are expressly agreed upon in the concluded contract.

Document version: C53000-G5040-C004-4.01

Edition: 11.2021

Version of the product described: V8.83 and higher

Copyright

Copyright © Siemens 2021. All rights reserved.

The disclosure, duplication, distribution and editing of this document, or utilization and communication of the content are not permitted, unless authorized in writing. All rights, including rights created by patent grant or registration of a utility model or a design, are reserved.

Trademarks

SIPROTEC, DIGSI, SIGRA, SIGUARD, SIMEAS, SAFIR, SICAM, and MindSphere are trademarks of Siemens. Any unauthorized use is prohibited.

Preface

Purpose of the Manual

This manual is intended to help you get started with DIGSI 5 engineering. To this end, this manual provides comprehensive information about DIGSI 5 and describes the essential steps when engineering with DIGSI 5.

Target Audience

System engineers, protection system engineers, commissioning engineers, persons entrusted with the setting, testing and maintenance of automation, selective protection and control equipment, and operational crew in electrical installations and power plants.

Scope

This manual applies to the SIPROTEC 5 device family.

Further Documentation

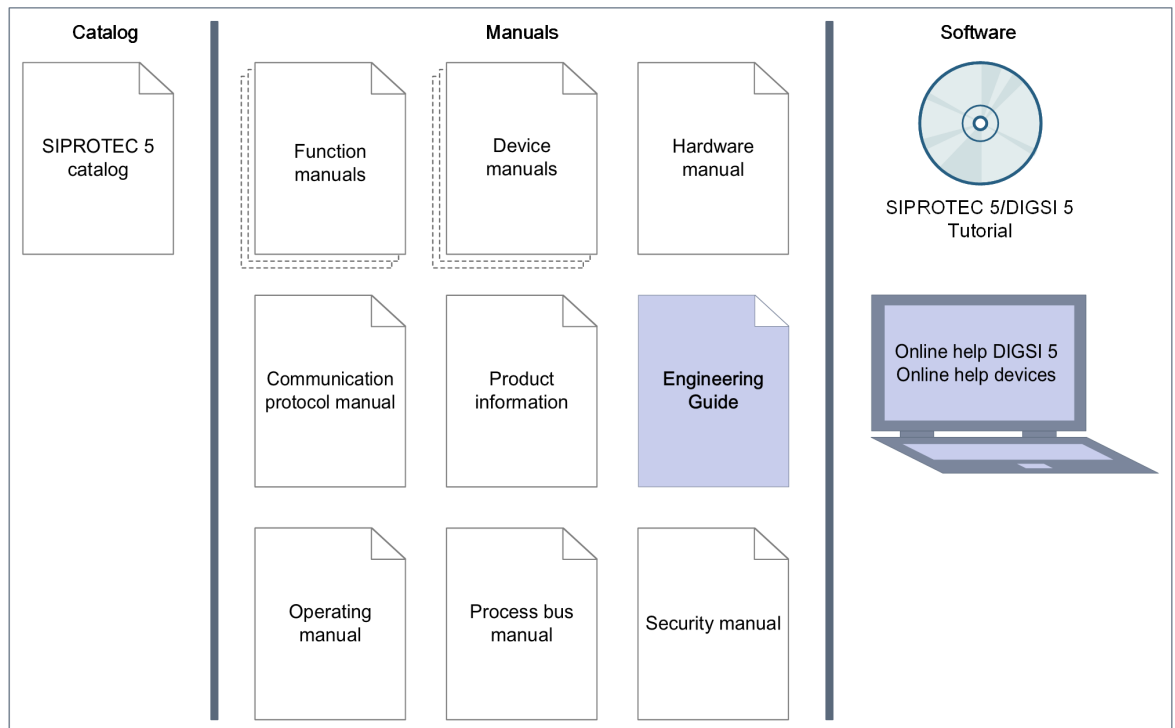

[dw_product-overview_SIP5_engineering-guide, 5, en_US]

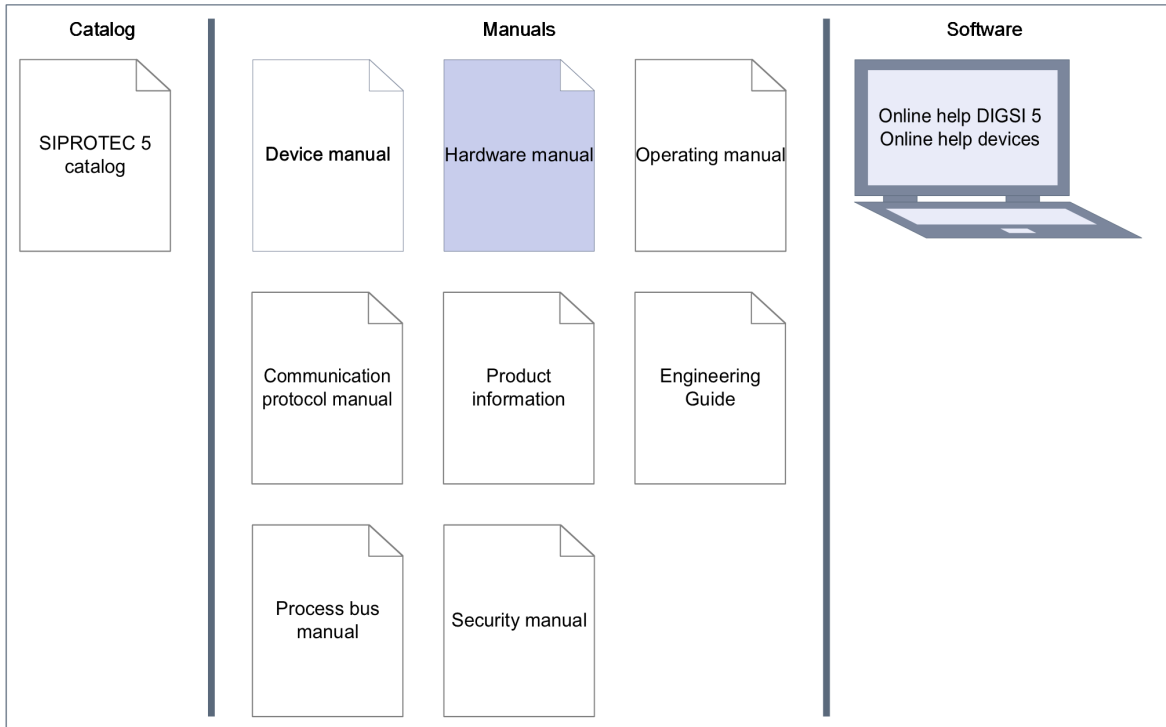

[dw_product-overview_SIP5_compact-hardware, 1, en_US]

- **Device manuals**
Each Device manual describes the functions and applications of a specific SIPROTEC 5 device. The printed manual and the online help for the device have the same informational structure.
- **Hardware manual**
The Hardware manual describes the hardware building blocks and device combinations of the SIPROTEC 5 device family.
- **Operating manual**
The Operating manual describes the basic principles and procedures for operating and assembling the devices of the SIPROTEC 5 range.
- **Communication protocol manual**
The Communication protocol manual contains a description of the protocols for communication within the SIPROTEC 5 device family and to higher-level network control centers.
- **Security manual**
The Security manual describes the security features of the SIPROTEC 5 devices and DIGSI 5.
- **Process bus manual**
The process bus manual describes the functions and applications specific for process bus in SIPROTEC 5.
- **Product information**
The Product information includes general information about device installation, technical data, limiting values for input and output modules, and conditions when preparing for operation. This document is provided with each SIPROTEC 5 device.
- **Engineering Guide**
The Engineering Guide describes the essential steps when engineering with DIGSI 5. In addition, the Engineering Guide shows you how to load a planned configuration to a SIPROTEC 5 device and update the functionality of the SIPROTEC 5 device.

- DIGSI 5 online help
The DIGSI 5 online help contains a help package for DIGSI 5 and CFC.
The help package for DIGSI 5 includes a description of the basic operation of software, the DIGSI principles and editors. The help package for CFC includes an introduction to CFC programming, basic examples of working with CFC, and a reference chapter with all the CFC blocks available for the SIPROTEC 5 range.
- SIPROTEC 5/DIGSI 5 Tutorial
The tutorial on the DVD contains brief information about important product features, more detailed information about the individual technical areas, as well as operating sequences with tasks based on practical operation and a brief explanation.
- SIPROTEC 5 catalog
The SIPROTEC 5 catalog describes the system features and the devices of SIPROTEC 5.

Indication of Conformity



This product complies with the directive of the Council of the European Communities on harmonization of the laws of the Member States concerning electromagnetic compatibility (EMC Directive 2014/30/EU), restriction on usage of hazardous substances in electrical and electronic equipment (RoHS Directive 2011/65/EU), and electrical equipment for use within specified voltage limits (Low Voltage Directive 2014/35/EU).

This conformity has been proved by tests performed according to the Council Directive in accordance with the generic standards EN 61000-6-2 and EN 61000-6-4 (for EMC directive), the standard EN 50581 (for RoHS directive), and with the product standard EN 60255-27 (for Low Voltage Directive) by Siemens.

The device is designed and manufactured for application in an industrial environment.

The product conforms with the international standards of IEC 60255 and the German standard VDE 0435.

Standards

IEEE Std C 37.90

The technical data of the product is approved in accordance with UL.

For more information about the UL database, see ul.com

You can find the product with the **UL File Number E194016**.



IND. CONT. EQ.
69CA

Additional Support

For questions about the system, contact your Siemens sales partner.

Customer Support Center

Our Customer Support Center provides a 24-hour service.

Siemens AG

Smart Infrastructure – Digital Grid

Customer Support Center

Phone: +49 911 2155 4466

E-mail: energy.automation@siemens.com

Training Courses

Inquiries regarding individual training courses should be addressed to our Training Center:

Siemens AG

Siemens Power Academy TD

Phone: +49 911 9582 7100

Humboldtstrasse 59
90459 Nuremberg
Germany

E-mail: poweracademy@siemens.com
Internet: www.siemens.com/poweracademy

Notes on Safety

This document is not a complete index of all safety measures required for operation of the equipment (module or device). However, it comprises important information that must be followed for personal safety, as well as to avoid material damage. Information is highlighted and illustrated as follows according to the degree of danger:



DANGER

DANGER means that death or severe injury **will** result if the measures specified are not taken.

- ✧ Comply with all instructions, in order to avoid death or severe injuries.
-



WARNING

WARNING means that death or severe injury **may** result if the measures specified are not taken.

- ✧ Comply with all instructions, in order to avoid death or severe injuries.
-



CAUTION

CAUTION means that medium-severe or slight injuries **can** occur if the specified measures are not taken.

- ✧ Comply with all instructions, in order to avoid moderate or minor injuries.
-

NOTICE

NOTICE means that property damage **can** result if the measures specified are not taken.

- ✧ Comply with all instructions, in order to avoid property damage.
-



NOTE

Important information about the product, product handling or a certain section of the documentation which must be given attention.

Qualified Electrical Engineering Personnel

Only qualified electrical engineering personnel may commission and operate the equipment (module, device) described in this document. Qualified electrical engineering personnel in the sense of this document are people who can demonstrate technical qualifications as electrical technicians. These persons may commission, isolate, ground and label devices, systems and circuits according to the standards of safety engineering.

Proper Use

The equipment (device, module) may be used only for such applications as set out in the catalogs and the technical description, and only in combination with third-party equipment recommended and approved by Siemens.











Problem-free and safe operation of the product depends on the following:

- Proper transport
- Proper storage, setup and installation
- Proper operation and maintenance

When electrical equipment is operated, hazardous voltages are inevitably present in certain parts. If proper action is not taken, death, severe injury or property damage can result:

- The equipment must be grounded at the grounding terminal before any connections are made.
- All circuit components connected to the power supply may be subject to dangerous voltage.
- Hazardous voltages may be present in equipment even after the supply voltage has been disconnected (capacitors can still be charged).
- Operation of equipment with exposed current-transformer circuits is prohibited. Before disconnecting the equipment, ensure that the current-transformer circuits are short-circuited.
- The limiting values stated in the document must not be exceeded. This must also be considered during testing and commissioning.

Selection of Used Symbols on the Device

Nr.	Symbol	Description
1		Direct current, IEC 60417, 5031
2		Alternating current, IEC 60417, 5032
3		Direct and alternating current, IEC 60417, 5033
4		Earth (ground) terminal, IEC 60417, 5017
5		Protective conductor terminal, IEC 60417, 5019
6		Caution, risk of electric shock
7		Caution, risk of danger, ISO 7000, 0434
8		Protective Insulation, IEC 60417, 5172, Safety Class II devices
9		Guideline 2002/96/EC for electrical and electronic devices
10		Guideline for the Eurasian Market
11		Mandatory Conformity Mark for Electronics and Electrotechnical Products in Morocco

OpenSSL

This product includes software developed by the OpenSSL Project for use in OpenSSL Toolkit (<http://www.openssl.org/>).

This product includes software written by Tim Hudson (tjh@cryptsoft.com).

This product includes cryptographic software written by Eric Young (ey@cryptsoft.com).

Table of Contents

	Preface.....	3
1	Overview DIGSI 5.....	11
	1.1 What is DIGSI 5?.....	12
	1.2 Engineering Philosophy and Terms.....	13
	1.2.1 Offline and Online.....	13
	1.2.2 Project	13
	1.2.3 SIPROTEC 5 Device.....	15
	1.2.4 MLFB.....	17
	1.2.5 Product Code.....	17
	1.2.6 Application.....	18
	1.2.7 Function Points.....	20
	1.3 User Interface.....	21
	1.3.1 Functional Sections of the User Interface	21
	1.3.2 Overview of Editors.....	26
2	Essential Steps during Engineering.....	29
	2.1 Overview of Engineering Steps.....	30
	2.2 Starting DIGSI 5 and Creating a Project	31
	2.3 Creating a Single-Line Configuration.....	34
	2.3.1 Overview.....	34
	2.3.2 Displaying Icons According to ANSI or IEC.....	36
	2.3.3 Creating a New Single-Line Configuration.....	37
	2.3.4 Using Templates.....	41
	2.4 Adding a SIPROTEC 5 Device.....	45
	2.4.1 Overview.....	45
	2.4.2 Inserting a SIPROTEC 5 Device with Product Code/MLFB Number.....	46
	2.4.3 Inserting a SIPROTEC 5 Device with Basic Configuration.....	50
	2.4.4 Completing the Hardware for the SIPROTEC 5 Device.....	53
	2.4.5 SIPROTEC 5 Device in the Single-Line Configuration.....	57
	2.4.6 Connecting the Device Application with Equipment.....	59
	2.4.7 Changing the Connection Type of the Measuring Point.....	62
	2.5 Adjusting the Functional Scope.....	66
	2.5.1 Overview.....	66
	2.5.2 Adding Application Elements.....	66
	2.5.3 Checking the Function-Point Status.....	71
	2.6 Routing Information.....	73
	2.6.1 Overview.....	73
	2.6.2 Opening the Information-Routing Matrix and Adapting the View.....	74

2.6.3	Basic Procedure for Routing.....	79
2.6.4	Routing Information to Sources and Destinations.....	80
2.7	Creating a CFC.....	85
2.7.1	Overview.....	85
2.7.2	Adding a New Continuous Function Chart.....	87
2.7.3	Adding and Interconnecting the Function Block.....	88
2.8	Creating a Display Page.....	93
2.8.1	Overview.....	93
2.8.2	Creating a New Display Page.....	95
2.8.3	Adding Signals to the Display Page.....	100
2.8.4	Creating the Display Page for a Bay.....	103
2.9	Parameterizing Protection Functions.....	104
2.9.1	Overview.....	104
2.9.2	Selecting the Appropriate Mode.....	106
2.9.3	Selecting a Function and Setting Parameters.....	107
2.9.4	Using the Graphics Function.....	110
2.10	Configuring Communication.....	112
2.10.1	Overview.....	112
2.10.2	Selecting and Configuring Protocols.....	115
2.10.3	Adapting Communication Mapping for the DNP3 Protocol.....	118
2.10.4	Creating an Ethernet Connection	121
3	Loading the Configuration into the SIPROTEC 5 Device.....	125
3.1	Overview.....	126
3.2	Initializing the SIPROTEC 5 Device.....	128
3.3	Establishing a Permanent Connection to the SIPROTEC 5 Device.....	129
3.4	Transmitting the Offline Configuration to the SIPROTEC 5 Device.....	130
3.5	Disconnecting the Connection to the SIPROTEC 5 Device.....	131
4	Upgrading Device Functionality.....	133
4.1	Overview.....	134
4.2	Determining the Serial Number of the SIPROTEC 5 Device.....	135
4.3	Determining the Required Function-Point Class.....	136
4.4	Selecting the Device Functionality.....	138
4.5	Loading Device Functionality to the SIPROTEC 5 Device.....	142
	Index.....	143

1 Overview DIGSI 5

1.1	What is DIGSI 5?	12
1.2	Engineering Philosophy and Terms	13
1.3	User Interface	21

1.1 What is DIGSI 5?

DIGSI 5 is the all-in-one engineering tool for configuring and operating all SIPROTEC 5 devices. The functional scope of DIGSI 5 covers all tasks – from device configuration and device setting to commissioning and evaluation of fault data.

You perform all configuration tasks offline from your PC without the need for a SIPROTEC 5 device. You transfer all data to the SIPROTEC 5 device online later – for example, via a direct USB connection or a communication network. For communication, DIGSI 5 and SIPROTEC 5 are based on current standards such as IEC 61850 and proven technologies such as Ethernet.

There are 3 different variants of DIGSI 5:

- Select **DIGSI 5 Compact** for simple applications:
 - With individual SIPROTEC 5 devices
 - With up to 8 SIPROTEC 5 Compact devices (7SX800)
 - With non-modular SIPROTEC 5 devices (7SX82)

With this variant, you deal with most standard tasks such as setting parameters or reading out process data.

- The **DIGSI 5 Standard** variant has an enhanced functional scope. This variant includes, among others, the CFC Editor and the Display Editor. With the Display Editor, you can now also create your own symbols. With DIGSI 5 Standard, you simulate the topology of a system as a 1-phase representation and you configure hardware and networks on a graphical basis. DIGSI 5 Standard offers full IEC 61850 support, including system configuration.
- **DIGSI 5 Premium** is the high-end variant of DIGSI 5. This variant contains the DIGSI 5 test suite for testing SIPROTEC 5 devices and functions. With DIGSI 5 Premium, you analyze fault records with SIGRA and you exploit the advantages of flexible engineering for IEC 61850.

You can find a detailed overview of the features of the 3 variants in the DIGSI 5 Help section **The Features of the Various DIGSI 5 Variants**.

You can handle all tasks in this Manual with the variants **DIGSI 5 Standard** or **DIGSI 5 Premium**.

1.2 Engineering Philosophy and Terms

1.2.1 Offline and Online

There are 2 ways to work in DIGSI 5: offline and online.

In the **Offline mode**, all of the data to be edited for a SIPROTEC 5 device is contained in files. There is no connection to a physically existing SIPROTEC 5 device. You work in the offline mode, for example, to prepare setting values or to evaluate stored process data. In this case, you use the offline configuration of a SIPROTEC 5 device that contains all of the device data.

In the **Online mode**, there is a physical connection between DIGSI 5 and a SIPROTEC 5 device. You work in this mode to transfer setting values from DIGSI 5 to the SIPROTEC 5 device or to read process data out of it, for example.

In DIGSI 5, you can work with both modes in parallel. You can edit project data offline and at the same time you can monitor SIPROTEC 5 devices that can be accessed online.

The following list provides an overview of the tasks you can deal with, among others, in the **Offline mode**:

- Creating switchgear as a single-line configuration
- Adding the SIPROTEC 5 device to the single-line configuration
- Configuring hardware of a SIPROTEC 5 device
- Defining the functional scope of a SIPROTEC 5 device
- Setting functions
- Routing information
- Processing display pages
- Project engineering function charts (CFC)
- Configuring the communication network and setting communication settings
- Displaying saved measured values and indications
- Displaying saved fault records and evaluating them with SIGRA
- Exporting data and printing
- Creating test sequences

The following list provides an overview of the tasks you can deal with, among others, in the **Online mode**:

- Transferring parameter values from DIGSI 5 to the SIPROTEC 5 device
- Transferring parameter values from the SIPROTEC 5 device to DIGSI 5 and saving them in files
- Transferring indications, measured values, and fault records from the SIPROTEC 5 device to DIGSI 5 and saving them in files
- Testing SIPROTEC 5 devices, functions and more with the aid of the test suite
- Control equipment
- Initiating SIPROTEC 5 device starting or restarting
- Setting date and time of the SIPROTEC 5 device

1.2.2 Project

DIGSI 5 manages the components of a system and all the data associated with it in relation to the project. The following information is collected under a project name:

- Topology information
- Offline configuration of all SIPROTEC 5 devices

- Data contained in the offline configuration, for example:
 - Parameter values
 - Communication settings
 - Process data

In other words, you only have to open 1 project to have access to all data. Conversely, all changes are saved simply by saving the project.

Project Tree

When you open a project in DIGSI 5, the project is displayed in a hierarchical structure in the project tree.

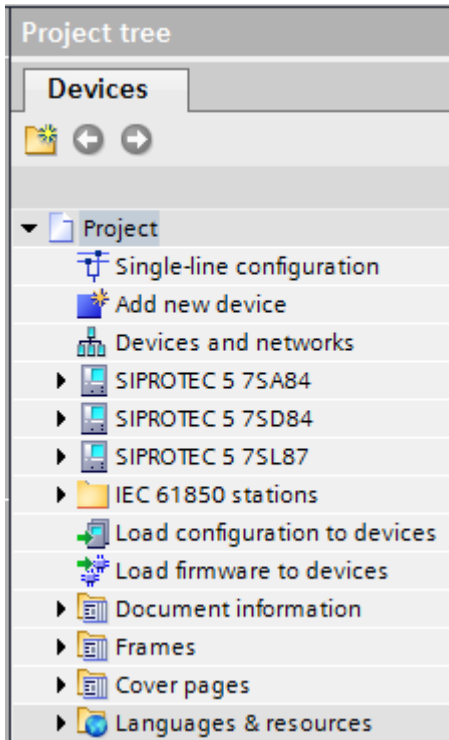

[sc_pnproj_1_en_US]

Figure 1-1 Project Tree with Open Project

The icons and text boxes in the project tree provide you access to all of the project data as well as the associated actions. Examples of such actions include adding a SIPROTEC 5 device or transferring data to the SIPROTEC 5 device.

You can learn more about the project tree in the chapter [1.3.1 Functional Sections of the User Interface](#) .

Project Content

A DIGSI 5 project contains the following data:

- **Single-line configuration**
 The single-line configuration describes the primary topology of a switchgear in the form of a 1-pole representation. The single-line configuration applies throughout the project to all SIPROTEC 5 devices in the project. You can therefore create one and no more than 1 single-line configuration within a project.
- **Offline configurations**
 The project contains the configuration for all SIPROTEC 5 devices added to the project. Since the project data are edited in the offline mode, these configurations are called offline configurations.

- **Document Data**
With the documentation function in DIGSI 5, you can create and manage system documentation in printed form. You can prepare project data as a standardized circuit manual and design it in a uniform layout. All document data are saved together with the project.
- **Project Texts and Languages**
Project texts include, for example, the names of CFC function blocks or functional groups. In DIGSI 5, Siemens provides project texts in various languages. You can also translate all project texts into any language as well as create and save individual project texts in different languages.

1.2.3 SIPROTEC 5 Device

Keep in mind that there are 3 different ways to view a SIPROTEC 5 device:

- Physical SIPROTEC 5 device
- Logical functional scope and field of application
- Image in DIGSI 5

Physical SIPROTEC 5 Device

SIPROTEC 5 offers a modular, freely configurable device design. This is made possible by the SIPROTEC 5 modular system. It contains coordinated hardware components, which you can combine yourself to configure your individual SIPROTEC 5 device:

- Base modules and expansion modules with different input/output modules
- Various on-site operation panels, for example with large display
- Different plug-in modules for communication and measured-value conversion

You can learn more about configuring the hardware in [2.4.3 Inserting a SIPROTEC 5 Device with Basic Configuration](#) and [2.4.4 Completing the Hardware for the SIPROTEC 5 Device](#).

A base module together with an on-site operation panel is already a standalone SIPROTEC 5 device in itself. This module functions correctly even without an expansion module. You can extend a base module with up to 4 expansion modules to gain additional functionality and more process connections.

With SIPROTEC 5, the term **device** always refers to the totality of all base, expansion, and plug-in modules and to the suitable on-site operation panels. In this case, a SIPROTEC 5 device must always contain exactly 1 base module.

Every SIPROTEC 5 device has a product code. It specifies the device hardware unambiguously.

You can learn more about this in [1.2.5 Product Code](#).

Logical Functional Scope and Field of Application

Every SIPROTEC 5 device can hold the functional scope needed for its individual field of application. SIPROTEC 5 provides all the necessary protection functions to address reliability and security of power transmission systems. SIPROTEC 5 supports system configurations in both multiple busbar and 1 1/2 circuit-breaker layouts. However, the devices are not simply protection or electronic control units, but can also monitor, measure, log failures and much more.

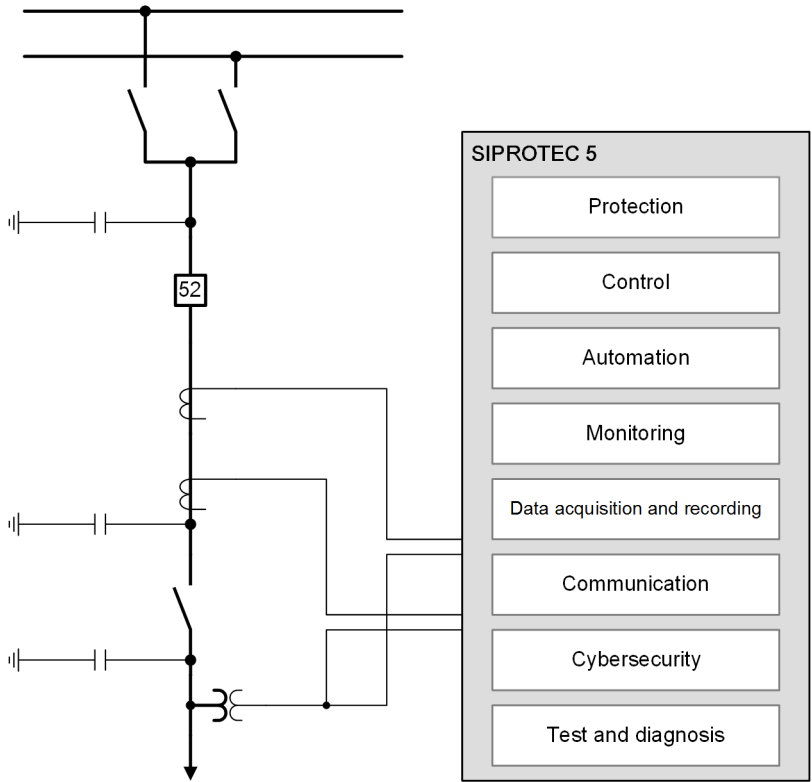

[ldw_funktionale-integration, 4, en_US]

Figure 1-2 Example of the Functional Capability of a SIPROTEC 5 Device

The application of the SIPROTEC 5 device defines the functional scope of the device as well as the connections between functions and hardware.

You can learn more about this in the chapter [1.2.6 Application](#).

Image in DIGSI 5

To edit a SIPROTEC 5 device with DIGSI 5, you need an image of the physical device in the project. This image corresponds to the offline configuration of the SIPROTEC 5 device. The offline configuration contains all of the data in the physical SIPROTEC 5 device.

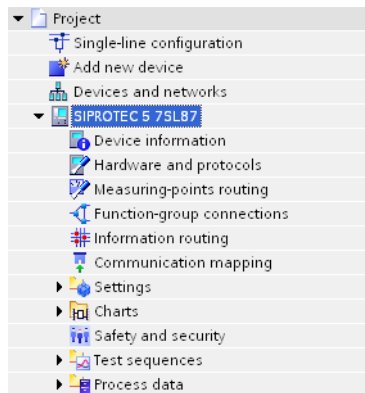

[sc_offkon, 1, en_US]

Figure 1-3 Entries in the Project Tree of an Opened Offline Configuration

You can learn more about the contents of an offline configuration in DIGSI 5 Help in the **Devices > Managing devices in projects > Offline configuration** section.

1.2.4 MLFB

SIPROTEC 5 Compact devices have a machine-readable product designation, MLFB number for short.

Obtaining an MLFB Number

There are 2 ways to obtain a valid MLFB number:

- **MLFB number overview in the device manual/catalog**
You can find an overview of the different device characteristics in the 7SX800 device manual and in the catalog. A 16-digit MLFB number is generated by selecting the device characteristics.
The produced MLFB number allows you to create a SIPROTEC 5 Compact device directly in DIGSI 5. All device characteristics are clearly determined by the MLFB number. Thus, you start engineering work in DIGSI 5 at a consistent level without having to re-enter the device characteristics.
- **Configuration with DIGSI 5**
DIGSI 5 allows you to configure a SIPROTEC 5 Compact device manually. Once the device has been fully configured, you can read the valid MLFB number in the device information. This MLFB number also allows you to order the configured SIPROTEC 5 Compact device.

1.2.5 Product Code

In contrast with SIPROTEC 5 Compact devices, SIPROTEC 5 devices have a product code, in both a long and a short form.

Long and Short Product Code

The long product code corresponds to the order number of a SIPROTEC 5 device. You can find this long product code in your order documents. You also receive a long product code if you configure a SIPROTEC 5 device with the SIPROTEC 5 Configurator. You can copy this product code and paste it into DIGSI 5. DIGSI 5 can directly interpret the long product code, as every character of the code can uniquely be assigned to a property of the SIPROTEC 5 device.

A short product code is provided to make things easier. The short product code refers uniquely to a long product code. The SIPROTEC 5 Configurator automatically creates a short product code for each new long product code. You can find this short product code on the name plate of the SIPROTEC 5 device.

Obtaining the Product Code

There are 2 ways to obtain a valid product code:

- **Configuring with the order configurator**
The order configurator assists you in the selection of SIPROTEC 5 products. The SIPROTEC 5 Configurator is a Web application that you can open in any browser.
Using the SIPROTEC 5 Configurator, you can configure the SIPROTEC 5 device completely. The product code is available at the end of the configuration process. It describes the SIPROTEC 5 device unambiguously and also serves as the ordering number.
With the aid of the product code obtained from the SIPROTEC 5 configurator, you can create a SIPROTEC 5 device directly in DIGSI 5. All device characteristics are determined unambiguously by the product code. You thus start engineering work in DIGSI 5 at a consistent level without having to re-enter the device characteristics.
- **Configuring with DIGSI 5**
DIGSI 5 allows you to configure a SIPROTEC 5 device manually. Once the device is configured completely, you can read the applicable product code in the device information. This product code is equivalent to the product code that you obtain from the SIPROTEC 5 Configurator. You can thus also use this product code to order the configured SIPROTEC 5 device.

1.2.6 Application

The application determines the functional scope and the functionality of a SIPROTEC 5 device.

Details on Applications

In one application, individual functions are grouped together to form logical function groups. The function groups (FG) represent the primary components, for example, the protection **Line** or the **Circuit breaker**. Function groups thus facilitate direct reference to actual switchgear. If, for example, a switchgear has 2 circuit breakers, the application contains 2 function groups of the type **Circuit breaker**.

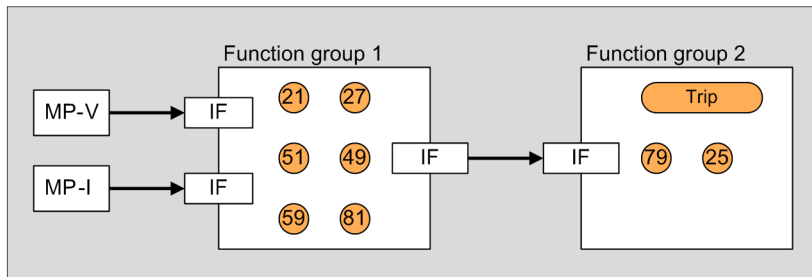

[dw_prinzip_sip5-application, 1, en_US]

Figure 1-4 Primary Representation of a SIPROTEC 5 Application

A function group does not necessarily have to contain protection functions. Function groups also exist for fault recording or installation data.

Every function group has interfaces for raising and cleared information. With these interfaces, the function groups, and thus the functions, can exchange information among each other.

But an application not only defines the scope of the functions and their connections among each other. An application is really complete only when it has logical measuring points (IF). These measuring points serve as interfaces to the process and conduct the current and voltage values supplied by the transformers MU-I and MU-V) to the function groups. You can freely configure the connections between measuring points and function groups. Thus the measured values of each function are available within a function group. There is no more permanent wiring between input and function.

Application Template

With the new application-oriented functional concept, you have to select an application template at the start of the project engineering, for example for the 1 1/2 circuit-breaker layout.

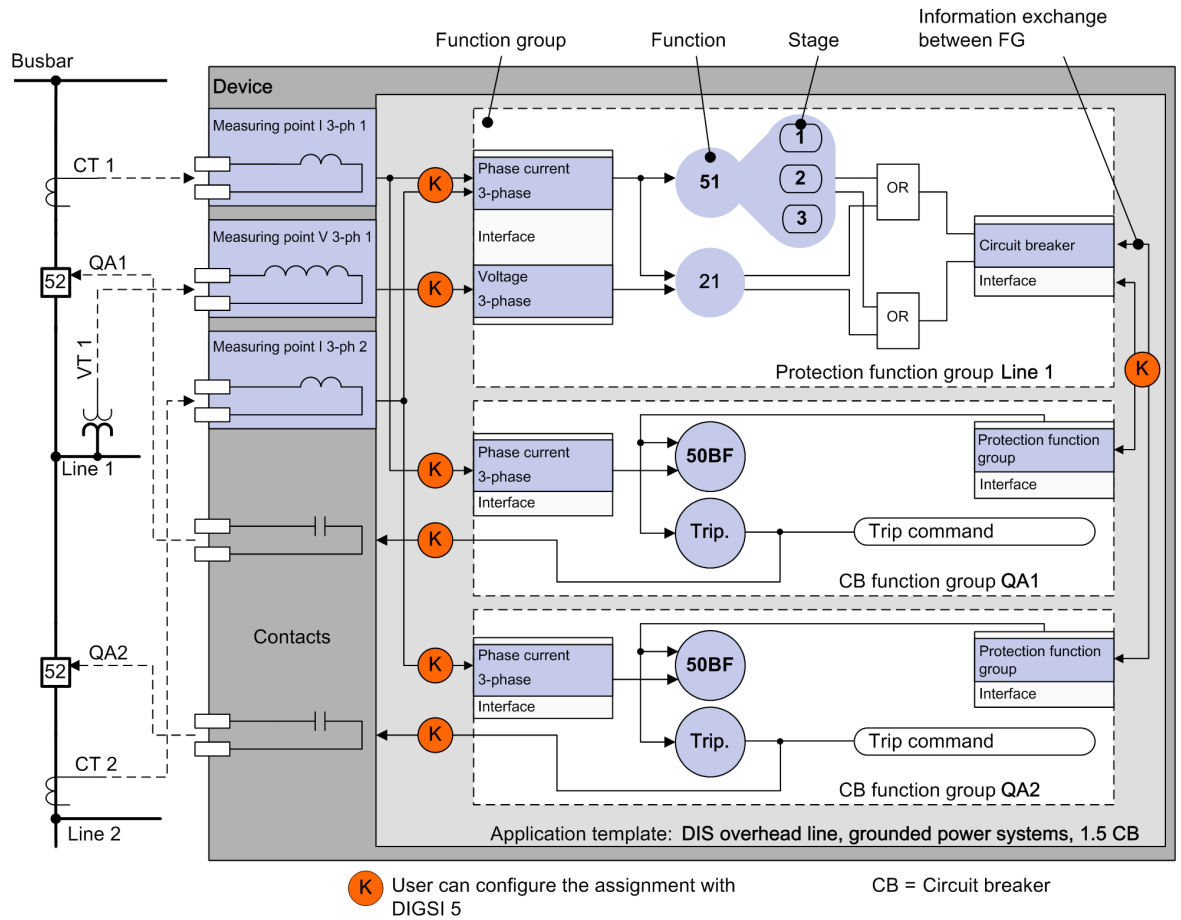

[dw_eifkfg_1_en_US]

Figure 1-5 Application Template for the 1 1/2 Circuit-Breaker Layout

Application templates make further project engineering simpler for a SIPROTEC 5 device. Each template contains the most important functions required for a specific application. The line protection is an example of such applications. Selecting a certain application template consequently determines the basic functional scope of a SIPROTEC 5 device. You can optimize this during project engineering.

In addition to the functions, an application template also contains the following device data:

- Basic parameterization
- Routing
- Continuous Function Charts (CFC)
- Display pages

Optimizing an Application

In many cases, you can use the selected application without any changes. But in addition, you have the possibility to optimize the functional scope of the application, and thus of the SIPROTEC 5 device, exactly to fit your specific needs.

If your application requires it, add new function groups. In doing so, you can rely on predefined function groups such as **Line** or **Circuit breaker**, for example. You can also set up the same function group several times within one application. In this way, you now protect several pieces of equipment, which you previously had to protect with one device each, with only a single SIPROTEC 5 device.

However, a function group itself is not a rigid structure as such. You can copy or shift functions from one function group to another. In addition, you can add more functions or delete unneeded functions.

SIPROTEC 5 offers very many functions. From this supply of functions, you select the functions that you need to add to your application. For many functions, you can also determine the number of stages. Thus you adapt the functions exactly to individual protection concepts.

1.2.7 Function Points

Every SIPROTEC 5 device has a basic functionality that depends on the device type. The SIPROTEC 5 can already operate and function correctly with this basic functionality. However, you can expand the basic functionality of a SIPROTEC 5 device by adding additional functions.

What is important to know is that with SIPROTEC 5, additional functions are incorporated using the function-point credit. Because with SIPROTEC 5, functions have a certain value, which is expressed in function points. The value of a function, or whether the function can be used without calculation of function points, is detailed in the Device manual in the **Applications** chapter. Moreover, one and the same function can have different function-point values for different device types.

Before ordering a SIPROTEC 5 device, you configure it on the Siemens Internet page using the SIPROTEC 5 Configurator. During this process you also select a function-point class that covers the function points required for your application. Siemens delivers the SIPROTEC 5 device along with the acquired function-point credit. Further information can be found in the SIPROTEC 5 system overview.

Basis+200 is an example of such a function-point class. Basis means that certain basic functionality is provided by the device type. 200 is the number of function points that you accrue. This function-point value represents your function-point credit. This function-point credit makes additional functions available to you for enhancing the SIPROTEC 5 device.

One benefit of this approach is that the additional functionality needs not be specified in detail when selecting the product. You can add every additional function needed during the subsequent engineering phase. You simply add the needed functions from the Global DIGSI 5 library to the offline configuration of the SIPROTEC 5 device in DIGSI 5. Then, you load the offline configuration into the SIPROTEC 5 device.

If the required number of points for the configured functional scope is larger than the function-point credit, you cannot load this offline configuration into the SIPROTEC 5 device. You must either remove functions or upgrade the function-point credit of the SIPROTEC 5 device.

With DIGSI 5, you can configure the functional scope regardless of the actual function-points credit. You can review the current usage of function points at any time and order additional missing function points.

1.3 User Interface

1.3.1 Functional Sections of the User Interface

The new program structure of DIGSI 5 is designed to optimally support the working steps required during a project. The application-oriented engineering approach guarantees that you are always aware of the workflow. DIGSI 5 makes you more productive – from design to engineering and even with installation, commissioning and operation.

Everything you need to configure and operate SIPROTEC 5 devices is seamlessly integrated in the user interface of DIGSI 5. The user interface is divided into 5 functional sections:

- Project tree
- Working area
- Task card
- Inspector window
- Menu bar, toolbar and object bar

Project Tree

The project tree is positioned on the left side of the user interface and is the central element when working with DIGSI 5. The individual icons and entries give you access to all data and tools. One double-click each is sufficient to display setting values of protection functions, start actions such as loading firmware into SIPROTEC 5 devices or open one of the editors.

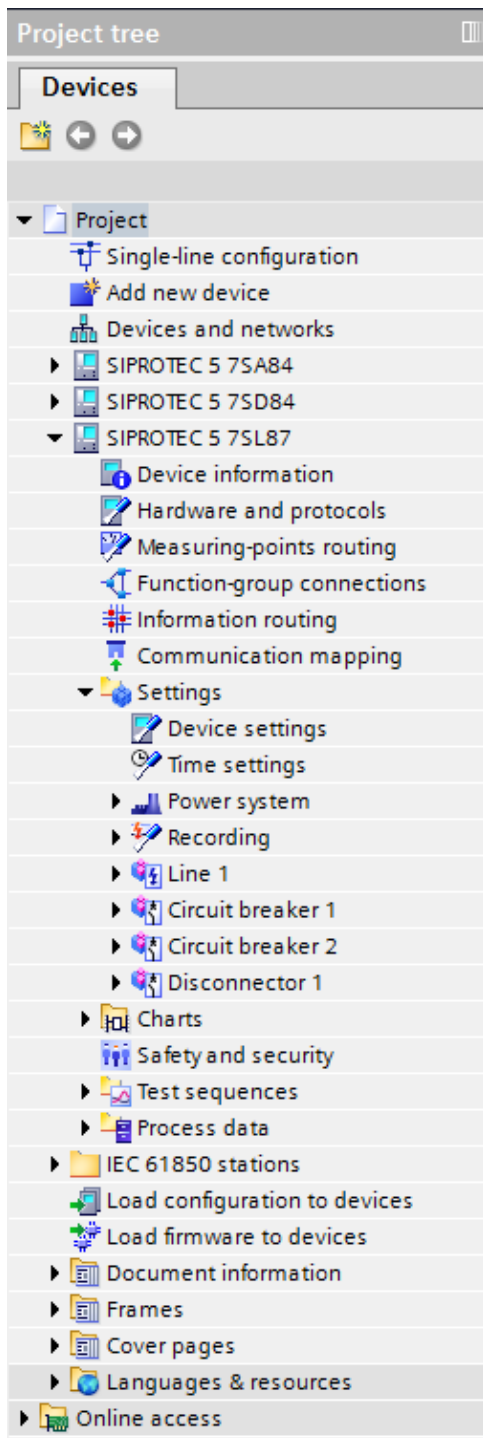

[sc_pneint, 1, en_US]

Figure 1-6 Entries in the Project Tree

Some examples show these mechanisms:

- The **Single-line configuration** entry is an access point to an editor. Double-clicking this entry opens the Single-Line Editor.
- The **Add new device** entry is an action. You can open a dialog enabling you to add a new SIPROTEC 5 device.
- The entries in the **Settings** area are access points to function settings. Double-clicking one of these entries opens the entry area associated with the function.

You find all objects and actions relevant to the project in the **Project** folder.

The **Online access** folder contains one subdirectory for each interface of the PC. You can search for SIPROTEC 5 devices connected to an Ethernet interface or a USB interface. A separate folder is generated for each SIPROTEC 5 device found. This folder contains objects and actions with which you can read the process data out of a SIPROTEC 5 device, for example.

Menu Bar, Toolbar, and Object Bar

The menu bar along the upper edge of the user interface contains commands that you need frequently for your work.



[sc_digmen, 1, en_US]

Figure 1-7 DIGSI 5 Menu Bar and Toolbar

The toolbar below the menu bar provides fast access to actions and settings via individual buttons.

The object bar at the lower edge of the user interface contains a button for every editing tool open in the working area. In certain cases, the object bar groups several buttons into one single button, for example when you have opened several display pages. A list box opens when you click such a button. Out of this list box, you can then select the required content and display it in the working area.



[sc_digobj, 1, en_US]

Figure 1-8 Object Bar

Working Area

DIGSI 5 displays all editing tools in the working area. The following editing tools are available to edit elements:

- Editors
- Matrices and tables
- Input, display, and selection areas
- Overview window

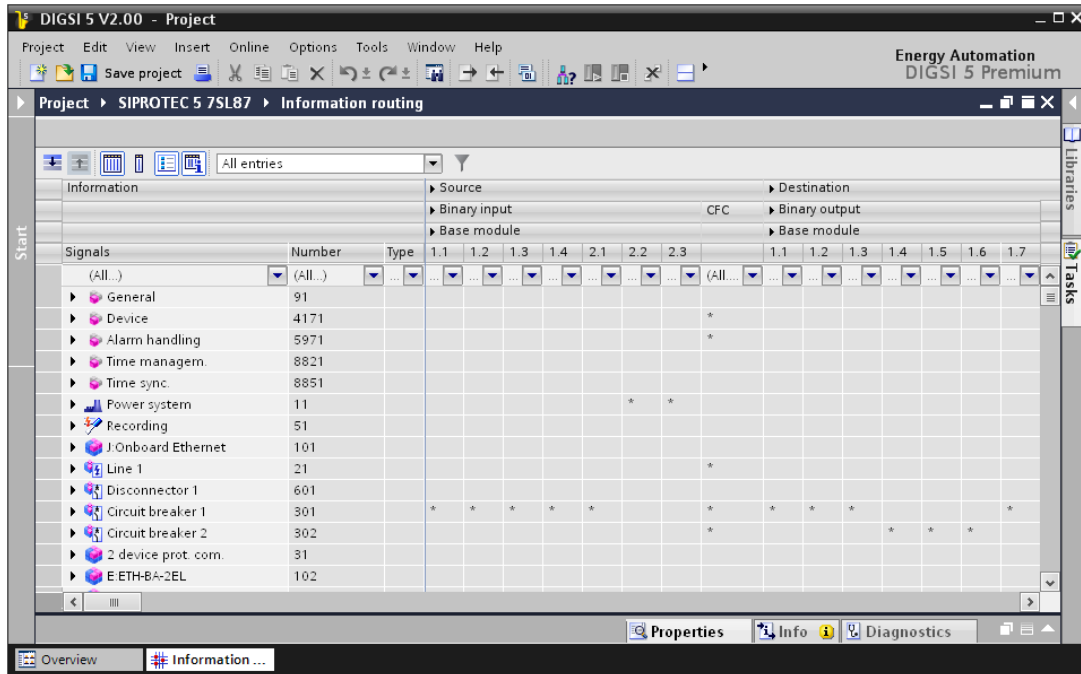

[sc_digarb, 1, en_US]

Figure 1-9 Maximized Working Area with Information-Routing Matrix

You can open several tools simultaneously in the working area. The object bar then contains one button for each opened editing tool. You can use these buttons to switch between the individual editing tools.

The [1.3.2 Overview of Editors](#) provides an overview of the editors that you need for the tasks in this manual. A complete overview of all editing tools can be found in the DIGSI 5 Help in the **User Interface** chapter.

Task Card

You see the task card on the right-hand side of the user interface. This is where you find context-related tasks or functions.

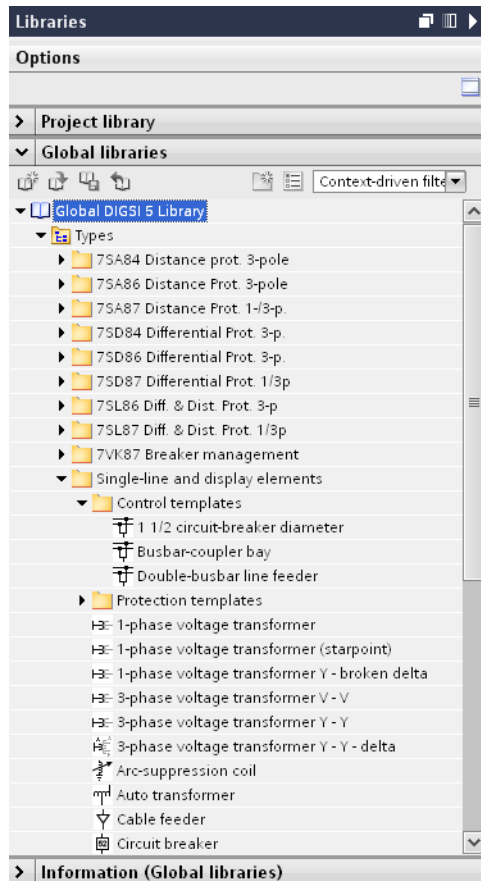

[sc_digauf_1_en_US]

Figure 1-10 Task Card with Opened Global DIGSI 5 Library

Depending on the object edited or selected, various tabs are available in the task card for execution of further actions.

- Selecting elements from a library or from the Hardware catalog
- Finding elements in the project
- Selecting signals and assigning them to an element

You find the flags of the tabs in a bar on the right edge of the screen. You can open and close the tabs. More complex tabs are subdivided into pallets, which you can also fold and unfold.

The **Libraries** task card has a special significance. This task card contains, among other things, the Global DIGSI 5 library. This library is installed on the PC together with DIGSI 5. You can use this library for all projects. However, you cannot modify it.

The Global DIGSI 5 library allows you to work efficiently in DIGSI 5. It contains elements that you drag and drop to a specific destination in your project. For example, this destination can be a function chart (CFC), the single-line configuration, or a display page.

Inspector Window

If you like additional information about a certain element or executed action, the Inspector window can help further.

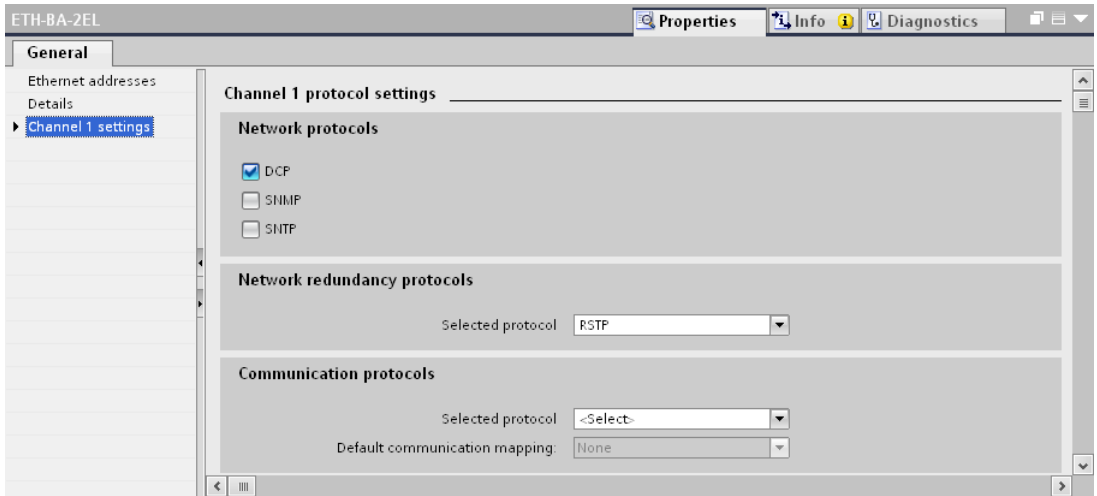

[sc_digins, 1, en_US]

Figure 1-11 Inspector Window with Properties Tab Selected

The **Properties** tab in the Inspector window displays the properties of a selected element. On this tab, you can change editable properties of an element without having to open the additional dialogs. The **Info** tab in the Inspector window displays additional information about the selected element and indications about executed actions. Diagnosis information can be read out from the SIPROTEC 5 device on the **Diagnostics** tab. Diagnosis information is available for CPU, for IP configuration, or for system time.

1.3.2 Overview of Editors

This chapter provides an overview of the editors that you need for the tasks in this manual. This overview also gives you a quick idea of the DIGSI 5 increments of functionality. An exact description of the editors can be found in the associated descriptions of procedures in this manual. A complete overview of all editing tools can be found in the DIGSI 5 Help in the **User Interface > Editors** chapter.

- **Single-Line Editor**
This editor is used for editing the single-line configuration of the station and for displaying the station topology.
- **Device and Network Editor**
This editor is used for editing the hardware configuration of a SIPROTEC 5 device and integrating the SIPROTEC 5 device into the network structure.
- **Settings Editor**
This editor is used for editing the settings of parameters, for example of protection functions or the time synchronization. Certain functions, for example, for distance protection or tripping, can be visualized graphically.
- **Continuous Function Chart Editor (CFC)**
This editor is used for configuring additional functions for the SIPROTEC 5 device. Use predefined function blocks for this.
- **Display Editor**
This editor is used for generating the display pages that appear on a SIPROTEC 5 device.
- **Information-routing matrix**
This matrix is used for routing information, for example, indications, to sources and destinations, for example binary inputs or LEDs.
- **Communication-mapping matrix**
This matrix is used for establishing which signals will be transmitted by serial protocols over the communication interfaces of a SIPROTEC 5 device. You can also set mapping settings for each signal routed.

- **Measuring-point routing matrix**

This matrix is used for routing the inputs of current and voltage measuring points to the physical inputs of a SIPROTEC 5 device.

2 Essential Steps during Engineering

2.1	Overview of Engineering Steps	30
2.2	Starting DIGSI 5 and Creating a Project	31
2.3	Creating a Single-Line Configuration	34
2.4	Adding a SIPROTEC 5 Device	45
2.5	Adjusting the Functional Scope	66
2.6	Routing Information	73
2.7	Creating a CFC	85
2.8	Creating a Display Page	93
2.9	Parameterizing Protection Functions	104
2.10	Configuring Communication	112

2.1 Overview of Engineering Steps

In DIGSI 5, there is no prescribed order in which to perform the individual engineering steps. The first step is to always create a new project. The procedure of the subsequent steps, however, is not mandated.

Siemens recommends the following order which can also be found in this manual:

- **Starting DIGSI 5 and creating a project**
DIGSI 5 manages the switchgear components and all associated data in a project. Whenever you begin engineering, you must first create a new project.
- **Creating a single-line configuration**
The single-line configuration is a 1-pole representation of a switchgear. You can create this configuration with a graphical approach as in a drawing program or you can use preset configurations. This engineering step is optional. You can also add SIPROTEC 5 devices to a project and edit them without single-line configuration.
- **Adding a SIPROTEC 5 device**
Each physical SIPROTEC 5 device in the switchgear must also be represented in the associated DIGSI 5 project. If you have determined the product code for a SIPROTEC 5 device with the SIPROTEC 5 Configurator, you can use this code to directly add the device into DIGSI 5. Alternatively, you can configure a SIPROTEC 5 device in DIGSI 5 manually.
- **Adjusting the functional scope**
When adding a SIPROTEC 5 device to a project, you already have decided on an application template. By doing so, the device is already configured with an application-oriented basic functional scope. You can change these by adding or deleting function groups, functions, and function blocks.
- **Routing information**
Routing is defined as assigning information, for example an indication, to a source or destination, for example binary input or an LED. When routing, you identify the path of information within the SIPROTEC 5 device. This engineering step is optional. If you select an application template when adding a SIPROTEC 5 device to a project, the device receives initial routing that functions correctly. This, however, can be changed.
- **Creating a CFC**
You can enhance your SIPROTEC 5 device by self-configured functions, for example for interlocking or measured value tasks. Self-configured functions are created with predefined function blocks within a CFC. This engineering step is optional. Your SIPROTEC 5 device also works correctly without self-configured additional functions.
- **Creating display pages**
In the standard setting, the display of a SIPROTEC 5 device shows the menu structure of the device. You can create additional display pages for each SIPROTEC 5 device. Depending on the display type, you can use different information when configuring the display page. This engineering step is optional. Your SIPROTEC 5 device also works correctly without self-created display pages.
- **Setting protection function parameters**
To optimally adapt the device application to suit your requirements, you can set all protection function parameters for the SIPROTEC 5 device. This engineering step is optional. If you select an application template when adding a SIPROTEC 5 device to a project, the device receives base parameters that function correctly. This, however, can be changed.
- **Configuring communication**
If you want your SIPROTEC 5 device to communicate with other SIPROTEC devices, you must satisfy the necessary communication prerequisites. These include selecting suitable protocols and configuring the communication network. If you do not need your SIPROTEC 5 device to communicate with other devices, this engineering step is optional.

2.2 Starting DIGSI 5 and Creating a Project

When you first start DIGSI 5 after it is installed, the language selected as the installation language will also be used as the DIGSI 5 user interface language. The user interface language can be changed.

Starting DIGSI 5

- ◇ In the Start menu under **Siemens Energy**, select the program entry for the current DIGSI 5 version.

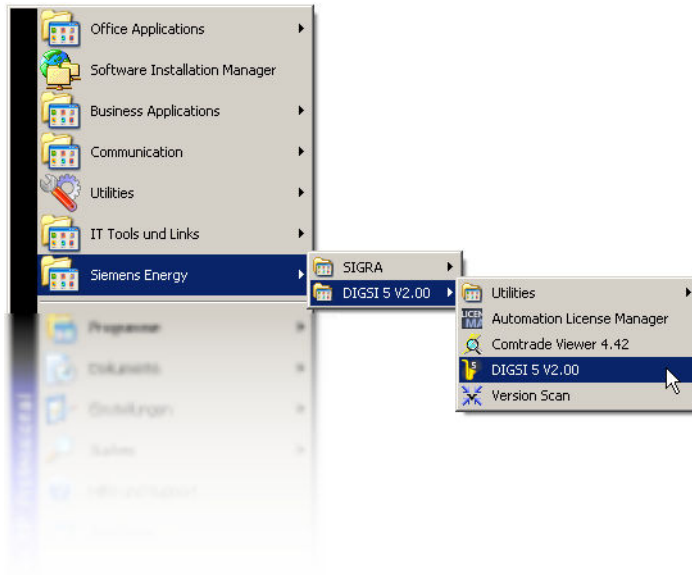

[sc_digsta, 1, en_US]

Figure 2-1 DIGSI 5 in the Windows Start Menu

Changing the User Interface Language

- ◇ In the **Extras** menu, click **Settings**.

The **Settings** view is displayed in the working area.

- ◇ Select the **General** group.

- ◇ In the **General settings** section, select the desired language from the **User interface language** list box.

The selected language immediately becomes the user interface language.

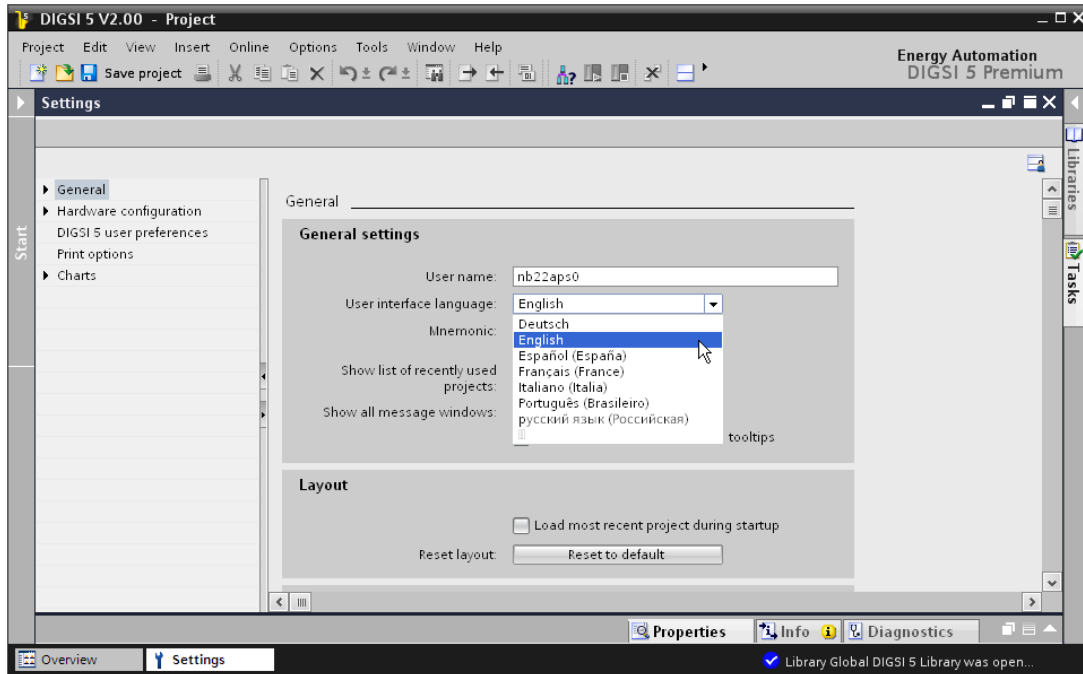

[sc_digein, 1, en_US]
Figure 2-2 Settings View in the Working Area

Creating a New Project

- ✦ In the DIGSI 5 toolbar, click the  button.

The **Create new project** dialog opens.

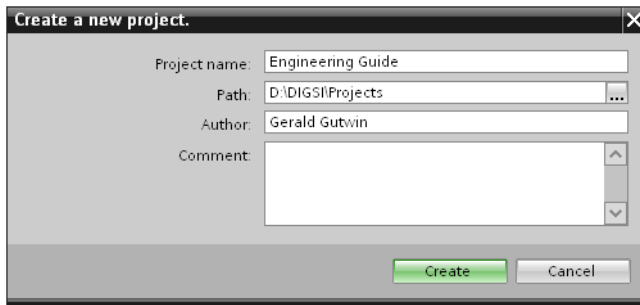

[sc_digneu, 1, en_US]
Figure 2-3 Creating a New Project Dialog

- ✦ Enter the desired project name and path or accept the data suggested.
- ✦ Click **Create**.

A new project is created and saved in the standard directory for projects. The project is then displayed in the project tree.

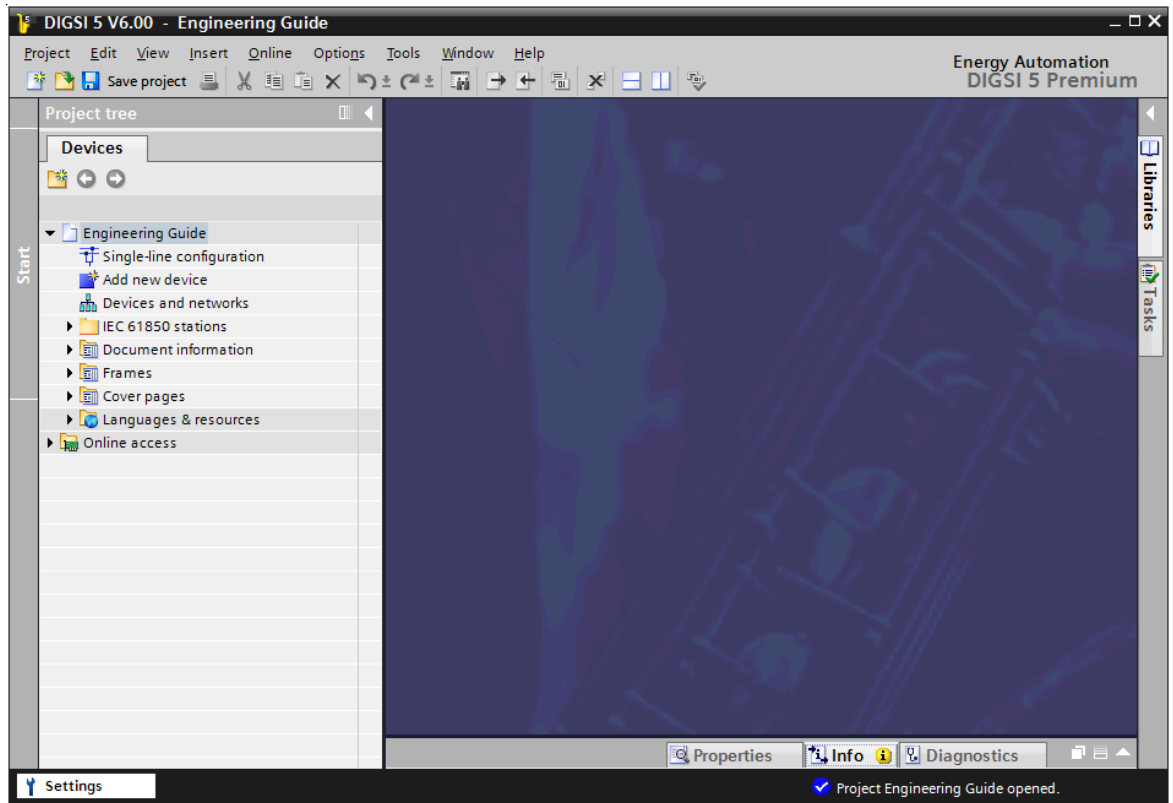

[sc_neupro, 1, en_US]

Figure 2-4 DIGSI 5 with a New Project

2.3 Creating a Single-Line Configuration

2.3.1 Overview

The single-line configuration is a 1-pole representation of a switchgear and describes the primary topology of the switchgear. You use the Single-Line Editor to create the single-line configuration with a graphical approach as in a drawing program.

The single-line configuration applies throughout the project. You can therefore create only one 1 single-line configuration within a project.

Options

The single-line configuration for a new project does not yet contain any elements. An empty space is shown in the working area instead. In this area, you use drag and drop to insert busbars, disconnectors, circuit breakers, and other equipment from the Global DIGSI 5 library. The elements are interconnected automatically by lines.

Alternatively, you can use prepared templates that you can also find in the Global DIGSI 5 library for various standard configurations. These templates can then be adapted to your requirements.

All elements for the single-line configuration can be displayed according to the 2 standards **ANSI** or **IEC**. If you insert an element from the library, the element symbol will be shown in the currently set standard **ANSI** or **IEC**. You can switch between these 2 standards at any time.

Once you have inserted a SIPROTEC 5 device into the project, you can connect the application graphically with the primary elements of the single-line configuration (voltage and current transformers as well as circuit breakers). This is how you establish a topological reference.

This step is described in the chapter [2.4.6 Connecting the Device Application with Equipment](#).

Single-Line Editor

The Single-Line Editor is used to edit the single-line configuration and to display the topology of the switchgear.

The Single-Line Editor has 2 tabs: **Single Line** and **Topology**:

- **Single Line tab**

In these tabs, you create the single-line configuration of the switchgear.

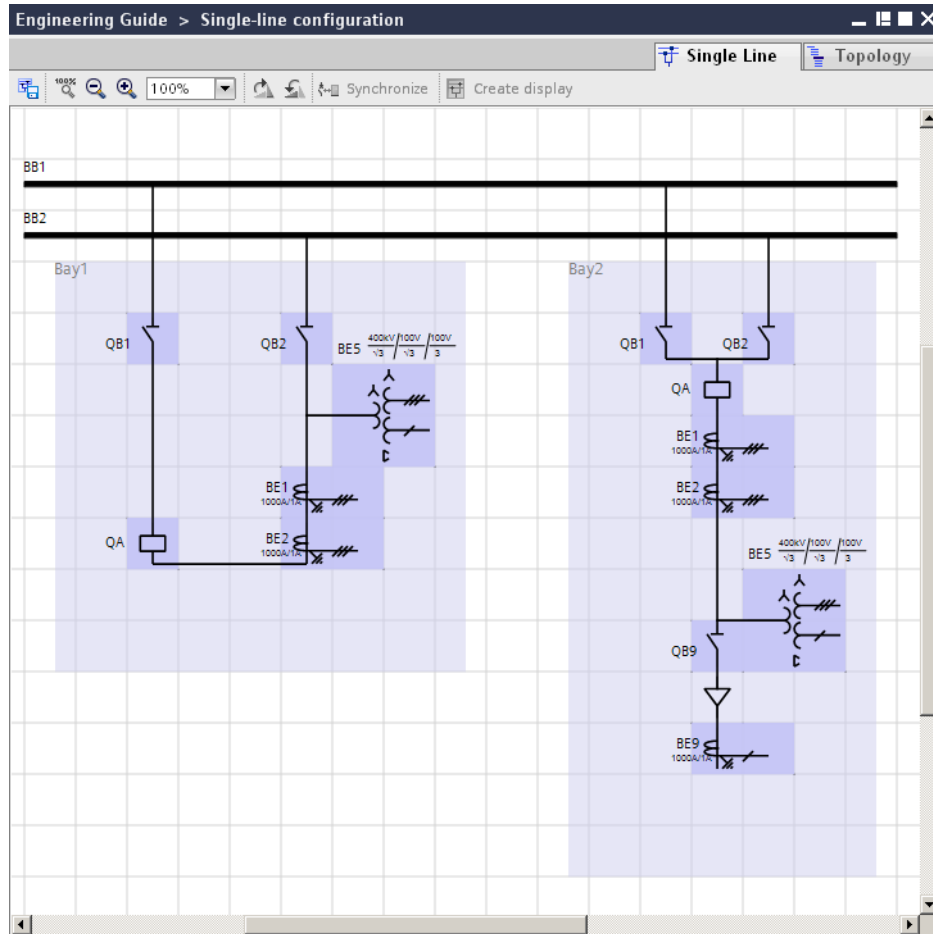

[sc_regsl1, 1, en_US]

Figure 2-5 Single Line Tab

- **Topology Tab**

This tab displays the topology of the switchgear. The topology presents another view of a single-line configuration and provides an overview of the hierarchical structure of the switchgear. The topology is updated as soon as you modify the single-line configuration.

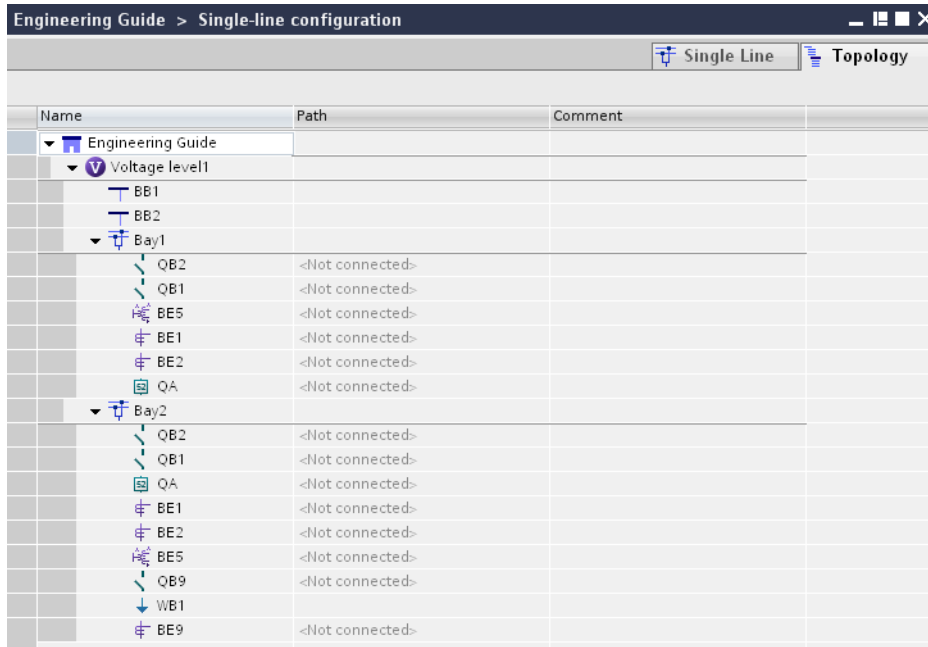

[sc_regtop, 1, en_US]

Figure 2-6 Topology Tab

2.3.2 Displaying Icons According to ANSI or IEC

All icons, for example for the single-line configuration or the display pages, can be displayed in compliance with either the ANSI or IEC standard.

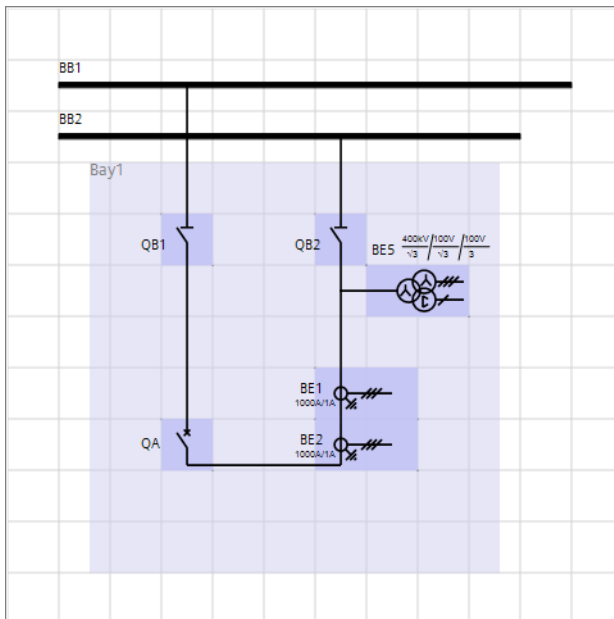

[sc_slliec, 1, en_US]

Figure 2-7 IEC Representation

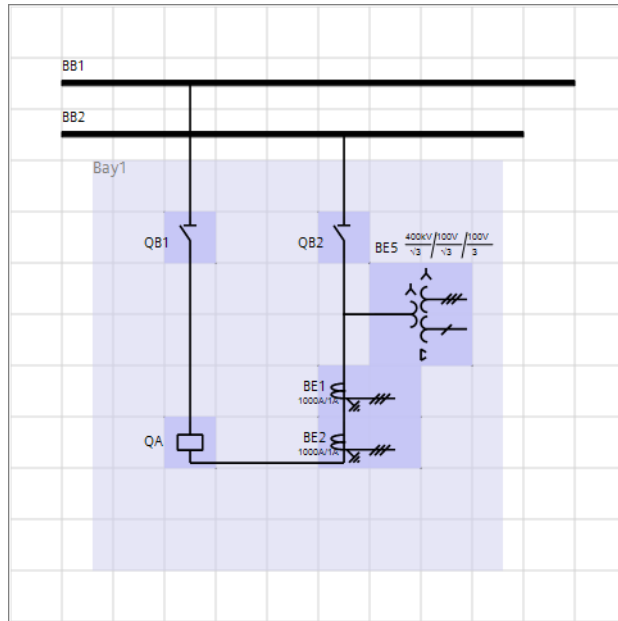

[sc_slansi, 1, en_US]

Figure 2-8 ANSI Representation

You can select which of the 2 representations is to be active at any time. However, both of them can never be active at the same time. You make a cross-project selection. It affects representation of the icons in the libraries, but also those inserted into the single-line configuration, which are displayed in accordance with the standard selected.

Changing Over the Display

- ✧ In the **Extras** menu, click **Settings**.

The **Settings** view is displayed in the working area.

- ✧ Select the **DIGSI 5 user preferences** group.
- ✧ From the list box **Standard for symbols**, select the other standard.

All icons are displayed in compliance with the newly selected standard.

2.3.3 Creating a New Single-Line Configuration

The single-line configuration for a new project does not yet contain any elements. An empty space is shown in the working area instead. This chapter describes how you create a single-line configuration using individual elements selected from the Global DIGSI 5 library.

Goal

The goal of this chapter is to create the single-line configuration shown in the following figure.

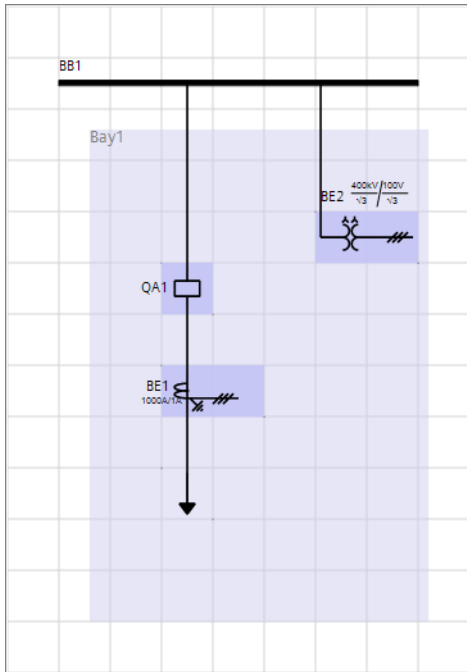

[sc_sikonf_04_1_en_US]

Figure 2-9 Single-Line Configuration with Busbar and Bay

The single-line configuration contains the following elements:

- Busbar **BB1**
- Circuit breaker **QA1**
- Current transformer **BE1**
- Voltage transformer **BE2**
- Feeder

The circuit breaker, current transformer, and voltage transformer are combined in a bay. A colored area identifies this bay. All elements within the colored area belong to the same bay. Busbars cannot be part of a bay.

Overview of the Procedure

Perform the following actions:

- Open the Single-Line Editor and then the Global DIGSI 5 library.
- Insert a busbar into the single-line configuration.
- Insert the circuit breaker into the single-line configuration.
- Insert additional equipment into the single-line configuration.

Opening the Single-Line Editor and Global DIGSI 5 Library

To create the single-line configuration, you need the Single-Line Editor and the Global DIGSI 5 library.

- ✧ In the project tree, double-click **Single-line configuration**.

The Single-Line Editor opens in the working area. Since a new project does not yet contain a single-line configuration, you see an empty surface in the working area with a hint.

- ✧ Right-click the empty working area.
- ✧ Click **Insert elements from library** in the context menu.

On the **Libraries** tab in the task card, the **Single Line and Display Elements** directory opens.

Inserting the Busbar

The Global DIGSI 5 library contains one element each for a vertical and a horizontal busbar.

- ✧ Select the element **Horizontal busbar** in the Global DIGSI 5 library.
- ✧ Drag the element to the desired insert position in the still empty working area.
- ✧ Release the mouse button.

The busbar is placed at the selected position.
You have now reached the following point:



[sc_sikonf_1, en_US]

Figure 2-10 In-Between Result: Busbar Inserted

Adding a Circuit Breaker

You insert the circuit breaker from the global DIGSI 5 library into the single-line configuration via drag and drop in exactly the same way as the busbar. A bay is created automatically in this way.

- ✧ Select the element **Circuit breaker** in the Global DIGSI 5 library.
- ✧ While holding the right mouse button down, drag the element into the working area and position it just below the busbar.
- ✧ Release the mouse button.

A new bay area is created. It contains the circuit breaker. The auto-connect function connects the circuit breaker with the busbar automatically.

- ✧ Click the bay and, while holding the right mouse button down, drag it down 2 quadrants.
- ✧ Release the mouse button.

This repositions the bay. The auto-connect function extends the connection between the circuit breaker and busbar automatically.

You have now reached the following point:

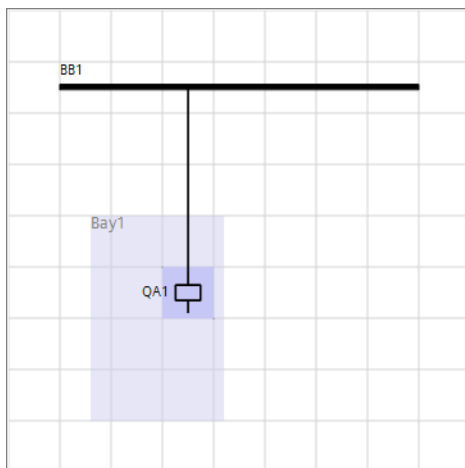

[sc_sikonf_02, 1, en_US]

Figure 2-11 In-Between Result: Circuit Breaker Inserted

Inserting a Current Transformer and Feeder

You insert the current transformer and feeder into the existing bay. The size of the bay increases automatically. If you place an element outside the bay, a bay is created. The auto-connect function helps you to connect the elements.

- ✧ Select the element **3-phase current transformer** in the Global DIGSI 5 library.
- ✧ While holding the right mouse button down, drag the element into the existing bay and position it in the 2nd quadrant below the circuit breaker.
- ✧ Release the mouse button.

This inserts the element **3-phase current transformer** and connects it with the circuit breaker.

- ✧ Proceed in the same way with the element **Feeder**, positioning it in the 2nd quadrant below the current transformer.

This inserts the element **Feeder** and connects it with the current transformer.

You have now reached the following point:

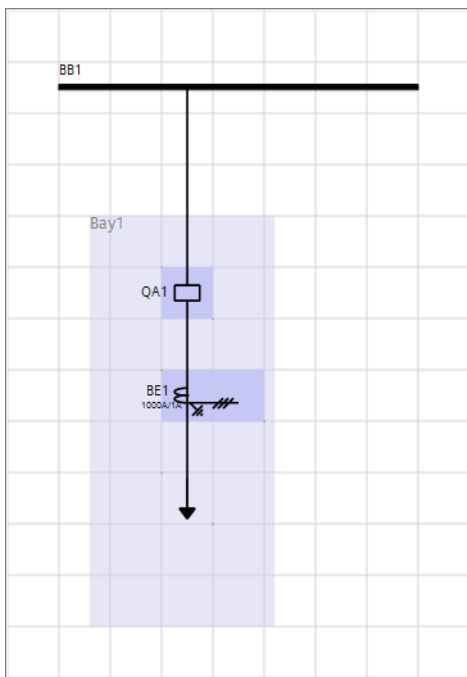

[sc_sikonf_03_1_en_US]

Figure 2-12 In-Between Result: Current Transformer and Feeder Inserted

Inserting a Voltage Transformer

You also insert the voltage transformer into the existing bay. The size of the bay increases automatically. You connect the voltage transformer to the busbar manually.

- ✧ Select the element **Y-Y voltage transformer** in the Global DIGSI 5 library.
- ✧ While holding the right mouse button down, drag the element into the existing bay and position it in the 2nd quadrant to the right of the circuit breaker.
- ✧ Release the mouse button.

This inserts the element **Y-Y voltage transformer**.

- ✧ Click the element and, while holding the right mouse button down, drag it up 1 quadrant and 1 quadrant to the right.
- ✧ Release the mouse button.

This repositions the element.

- ✧ Position the mouse pointer on the upper connection point of the element. This connection point marks the start of the line.

The mouse pointer is in the correct position when it changes to a hand.

- ✧ Press the mouse button and drag directly upward to the busbar. This connection point marks the end of the line.

A colored frame highlights the busbar as soon as you come close to it.

- ✧ Release the mouse button.

A vertical line connects the element **Y-Y voltage transformer** with the busbar.

You have thus achieved the goal.

2.3.4 Using Templates

Several templates for complete bays are available to you to speed up your work. You can insert these into a single-line configuration and adapt them to your requirements. You find all the templates in the Global DIGSI 5 library.

Goal

The goal of this chapter is to create the single-line configuration shown in the following figure.

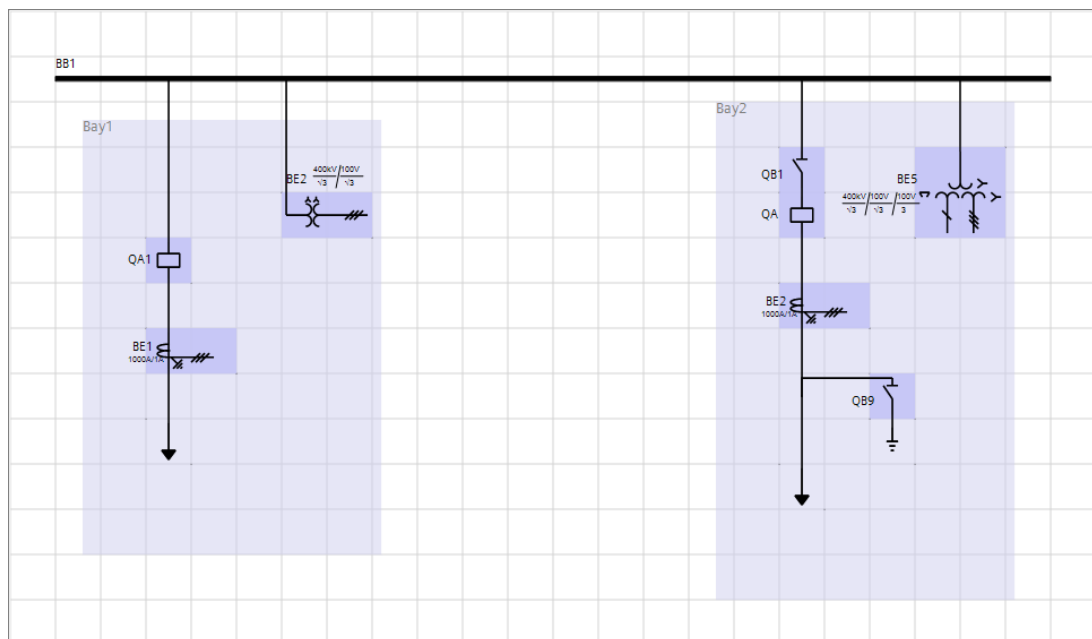

[sc_silkonf_08, 1, en, US]

Figure 2-13 Single-Line Configuration with Busbar and 2 Bays

The single-line configuration is expanded by addition of a 2nd bay. This 2nd bay is based on the protection-field template **Single-busbar line feeder**.

Overview of the Procedure

Perform the following actions:

- Insert the protection-field template **Single-busbar line feeder** into the single-line configuration from the Global DIGSI 5 library.
- Connect the template field with the busbar **BB1**.
- Configure the template field by deleting and adding elements.

Inserting a Template

You find all the templates in the Global DIGSI 5 library. The templates are distributed between the 2 folders **Templates for protection fields** and **Templates for control fields**. You need a protection-field template for the task described.

- ✧ Open the **Templates for protection fields** folder in the Global DIGSI 5 library.
- ✧ In the opened folder select the **Single-busbar line feeder** template.
- ✧ While holding the right mouse button down, drag the template to the unoccupied area to the right of the existing bay.

Once you have reached the correct position, a red frame highlights the busbar.

- ✧ Release the mouse button.

The template is now inserted in the single-line configuration.

You have now reached the following point:

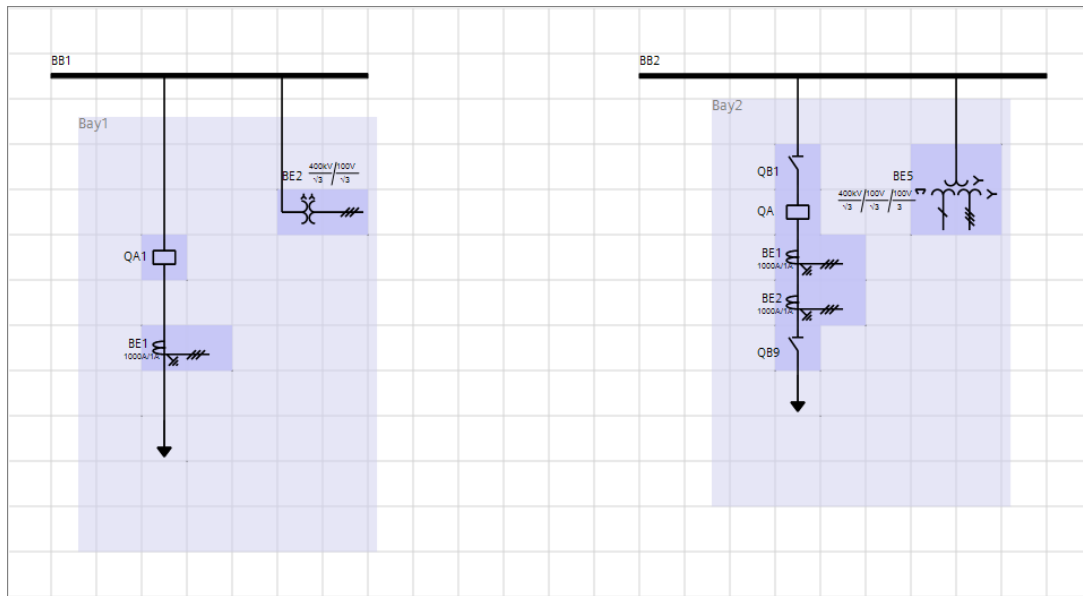

[sc_siknf_05_1_en_US]

Figure 2-14 In-Between Result: Template Field Inserted

Connecting Bays via a Common Busbar

Connect the 2 bays via the common busbar **BB1**.

- ✧ Right-click the busbar **BB2**.
- ✧ Click **Delete** in the context menu.

The busbar **BB2** is deleted.

- ✧ Click the end point of the busbar **BB1** and hold the mouse button down.
- ✧ While holding the mouse button down, move the mouse pointer to the right past the right edge of the template field.
- ✧ Release the mouse button.

The busbar **BB1** is extended.

- ✧ Connect the elements **QB1** and **BE5** with the busbar.
Proceed in the same way described in the chapter [2.3.3 Creating a New Single-Line Configuration](#), section **Inserting a Voltage Transformer**.

The template field is now connected with the busbar **BB1**.

You have now reached the following point:

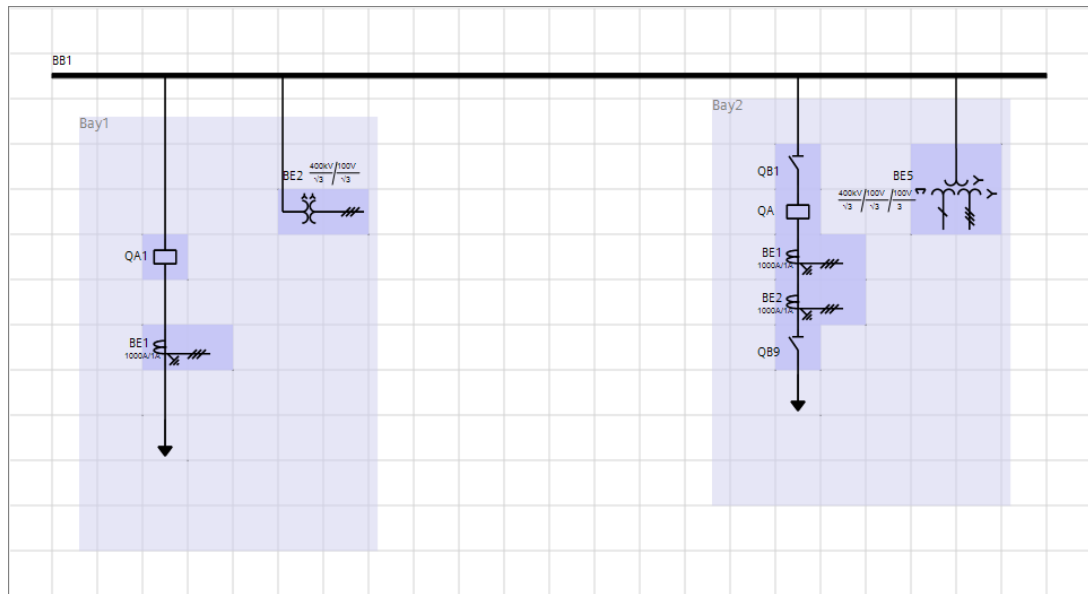

[sc_silkonf_06_1_en_US]

Figure 2-15 In-Between Result: Bays Connected via a Common Busbar

Modifying the Template

Modify the 2nd bay by deleting the elements and adding new elements.

- ✧ Right-click the current transformer **BE1**.
- ✧ Click **Delete** in the context menu.

The current transformer **BE1** is deleted.

- ✧ Click the feeder element and, while holding the right mouse button down, drag it down 2 quadrants.
- ✧ Release the mouse button.

This repositions the element.

- ✧ Use the same procedure to move the disconnector **QB9** down 1 quadrant.
- ✧ Mark and delete the tie line between the current transformer **BE2** and the disconnector **QB9**.
- ✧ Mark and delete the tie line between the disconnector **QB9** and the feeder element.

You have now reached the following point:

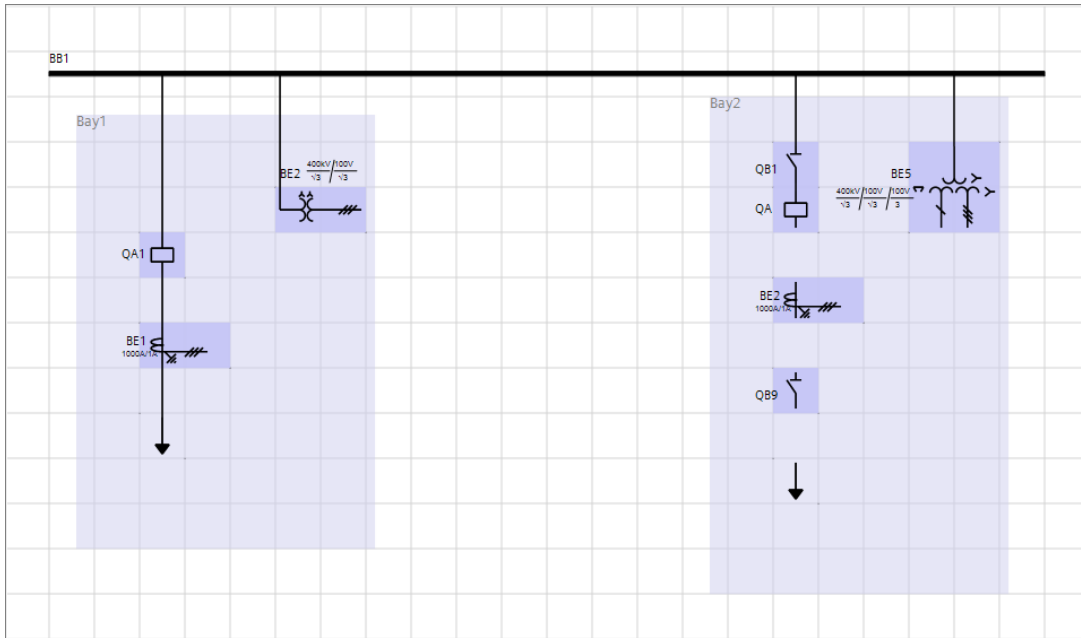

[isc_sikonf_07_1_en_US]

Figure 2-16 In-Between Result: Elements Deleted and Added

- ✧ Move the disconnector **QB9** 2 quadrants to the right.
- ✧ Position the mouse pointer on the lower connection point of the circuit breaker **QA**.

The mouse pointer is in the correct position when it changes to a hand.

- ✧ Press the mouse button and draw a direct line to the upper connection point on the current transformer **BE2**.

As soon as you come close to the connection point, the line snaps to the element automatically.

- ✧ Release the mouse button.

The two elements are connected by a vertical line.

- ✧ Use the same procedure to connect the current transformer **BE2** with the feeder element.
- ✧ Connect the upper connection point on the disconnector **QB9** horizontally with the connecting line between the current transformer **BE2** and the feeder element.
- ✧ Insert the element **Ground** from the Global DIGSI 5 library into the template field and position the element directly below the disconnector **QB9**.

The element **Ground** is connected automatically with the disconnector **QB9**.

- ✧ Save the project.

You have thus achieved the goal.

2.4 Adding a SIPROTEC 5 Device

2.4.1 Overview

Several options are available for inserting a SIPROTEC 5 device into a project:

- You can insert a SIPROTEC 5 device with the help of a valid product code and MLFB number (for SIPROTEC 5 Compact). Everything specified by this product code/MLFB number is created afterwards in DIGSI 5. In this variant, you start inserting the SIPROTEC 5 device directly in the project tree.
- You can configure a SIPROTEC 5 device manually. With this option, you first insert the basic configuration of a SIPROTEC 5 device into the project. You must then add the hardware for this basic configuration. You use the Device and Network Editor to insert and configure the SIPROTEC 5 device.
- You can import into the project data exported from SIPROTEC 5 devices. In this way, you can paste preconfigured SIPROTEC 5 devices in the project. You can learn more about exporting and importing data in the DIGSI 5 Help in the **Exporting and Importing** chapter.

Device and Network Editor

Using the Device and Network Editor, you insert basic configurations for new SIPROTEC 5 devices into the project and you edit the hardware configuration of SIPROTEC 5 devices.

The Device and Network Editor has 2 tabs: **Network view** and **Device view**.

- **Network view tab**

This tab shows the front views of all SIPROTEC 5 devices available in the project. In the Network view, you can insert basic configurations for new SIPROTEC 5 devices from the Hardware catalog. The Network view is also used to configure and link the interfaces.

You can learn more about this topic in the chapter [2.10.4 Creating an Ethernet Connection](#) .

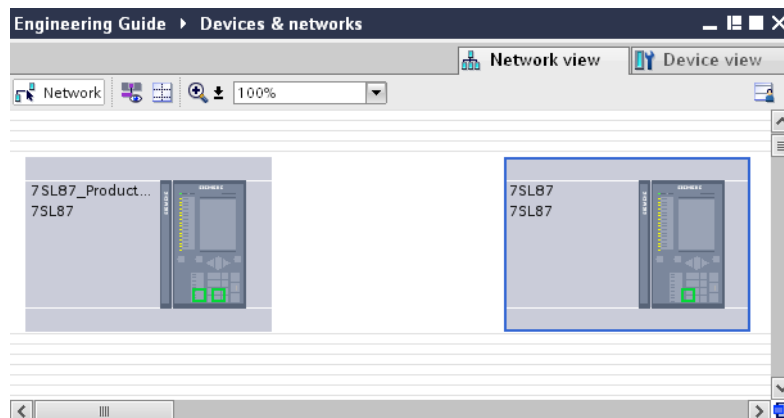

[sc_netzsi_02_1_en_US]

Figure 2-17 Network View Tab

- **Device view tab**

This tab shows the front view and rear view of the SIPROTEC 5 device selected. You can delete existing components from the visible hardware configuration and add new components from the Hardware catalog.

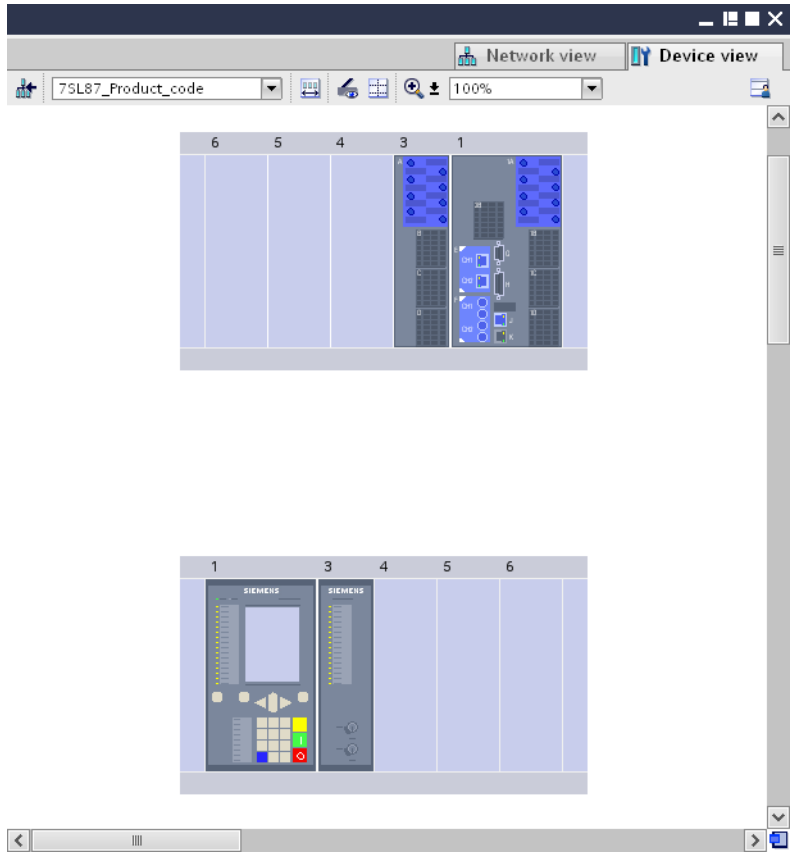

Figure 2-18 Device View Tab

Representations of the SIPROTEC 5 Device in the Project

When you insert a SIPROTEC 5 device into the project, you find the device at various locations in the project.

- **Project tree**
The folder in the project tree represents the offline configuration of the SIPROTEC 5 device.
- **Network view**
The device icon in the Network view represents the interfaces and the communication connections to the SIPROTEC 5 device.
- **Device view**
The device icon in the Device view represents the hardware for the SIPROTEC 5 device.
- **Single-line configuration**
The device icon in the Single-line configuration represents the application of the SIPROTEC 5 device.

2.4.2 Inserting a SIPROTEC 5 Device with Product Code/MLFB Number

If you know the product code/MLFB number for a physical SIPROTEC 5 device, you can use this to create a SIPROTEC 5 device in DIGSI 5.

Goal

The goal of this chapter is to create the project structure shown in the following figure.

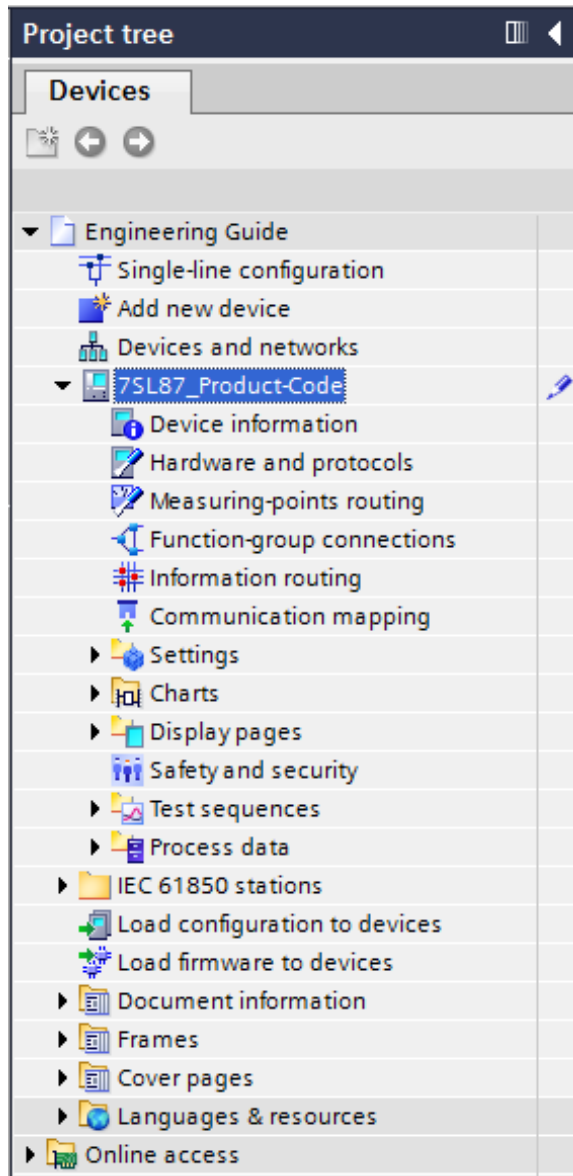

[sc_prostr, 1, en_US]

Figure 2-19 Project Tree with Offline Configuration 7SL87_Product Code

The project structure contains the offline configuration for the inserted SIPROTEC 5 device with a product code/MLFB number.

Overview of the Procedure

Perform the following actions:

- Start the insertion process for the SIPROTEC 5 device with the project tree.
- Enter the product code/MLFB number and select an application template.

Starting the Insertion Process

- ◇ Double-click **Add new device** in the project tree.

The **Add new device** dialog opens.

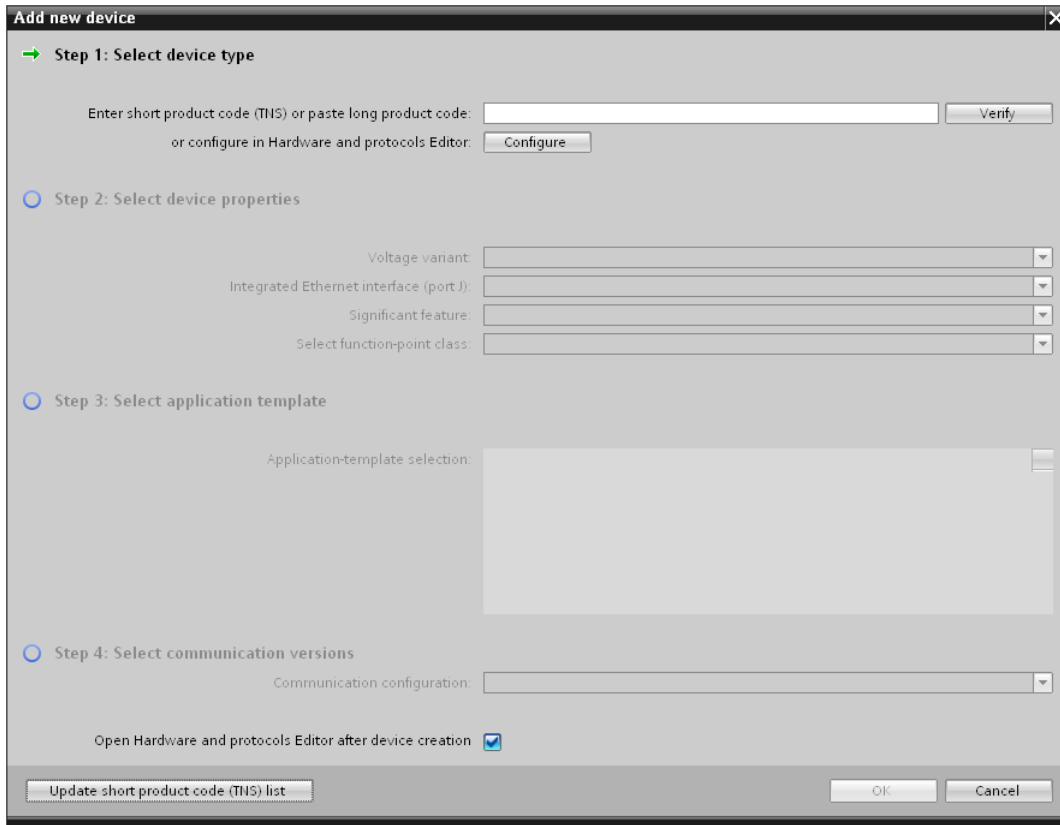

[sc_dlgger_1, en_US]

Figure 2-20 Insert a New Device After Opening the Dialog

Entering the Product Code and Selecting an Application Template

- ✦ Enter the following product code in the text box in **Step 1**:
 7SL87-DAAA-AA0-0AAAA0-AZ2212-23111B-AAE000-000AA0-CB1BA2-CB1.
- ✦ Click **Verify**.

The product code entered is verified. If the product code is valid, the **Application-template selection** list box is activated. At the same time, the list boxes in **Step 2** are deactivated, but contain valid settings. These settings are defined by the product code entered. You cannot change these settings.

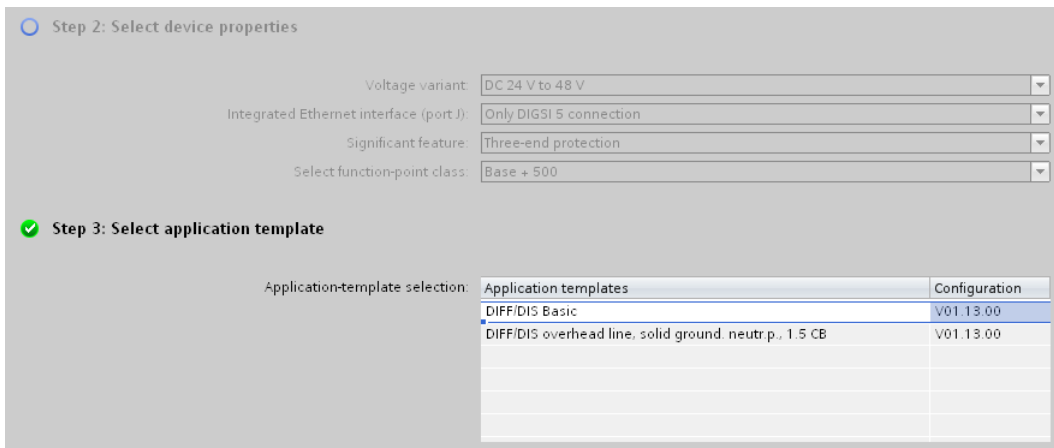

[sc_dlgger_02, 1, en_US]

Figure 2-21 Predefined Device Characteristics and Selectable Application Templates

- ✧ In the **Application-template selection** list box, highlight the application template **DIFF/DIS Basic**.
- ✧ Click **OK**.

The **Add new device** dialog is closed. The required device data is loaded and the specified SIPROTEC 5 device is added to the project. You now find a folder for the offline configuration of the SIPROTEC 5 device in the project tree. An icon for the SIPROTEC 5 device is also placed in both the Network view and the Device view.

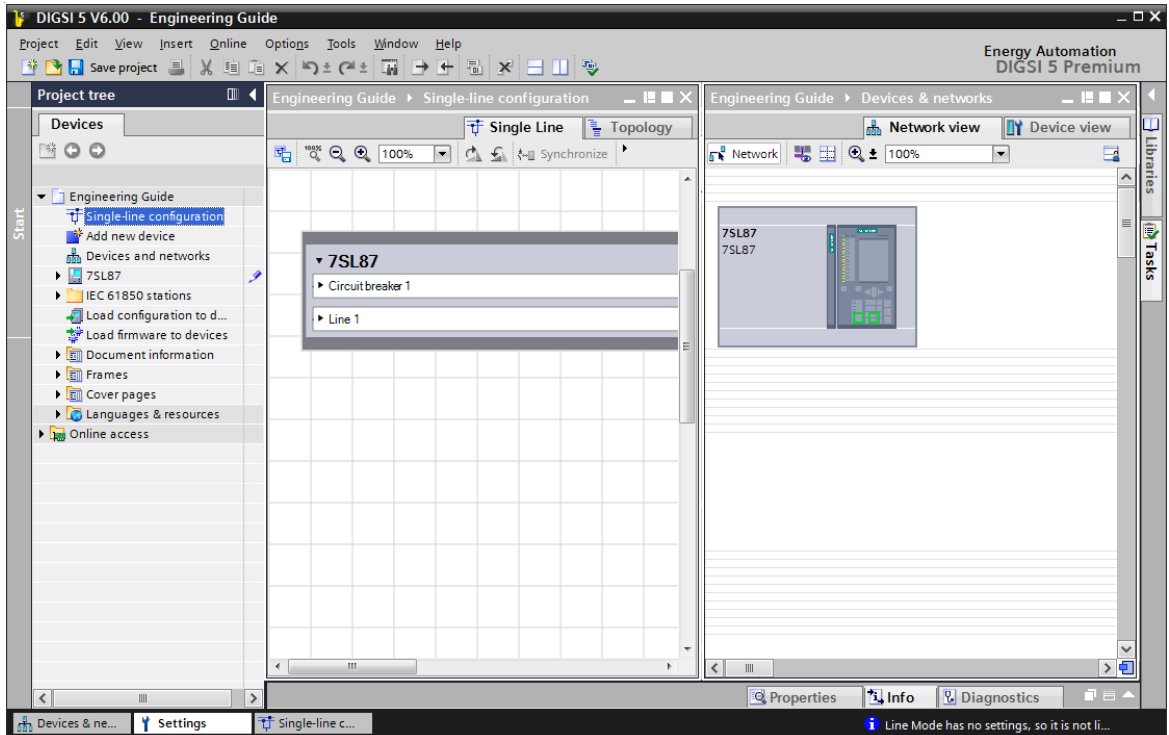

[sc_proger, 1, en_US]

Figure 2-22 SIPROTEC 5 Device in the Project Tree, in the Single-Line Configuration and in the Network View

Renaming a SIPROTEC 5 Device

A SIPROTEC 5 device is given a name when it is added to the project. For the first instance of an inserted SIPROTEC 5 device of a specific device type, the name consists of the designation of the device type, for example, 7SL87. The names of all subsequent SIPROTEC 5 devices of the same type have a consecutive number as a suffix, for example, 7SL87_1. You can change the name of a SIPROTEC 5 device at various locations in the project, for example, in the project tree. You can learn more about additional options in the DIGSI 5 Help in the **Devices > Managing devices in projects > Renaming a SIPROTEC 5 device** chapter.

- ✧ Right-click the name of the inserted SIPROTEC 5 device in the project tree.
- ✧ Click **Rename** in the context menu.

The name is displayed in a text box and is highlighted in color.

- ✧ Since the SIPROTEC 5 device is specified by the product code, enter **7SL87_Product Code** as the new name
- ✧ Click outside of the text box.

The name entered is accepted.

You have thus achieved the goal.

2.4.3 Inserting a SIPROTEC 5 Device with Basic Configuration

As an alternative to inserting a SIPROTEC 5 device with a valid product code, you can also configure a SIPROTEC 5 device/MLFB number manually in DIGSI 5. With this option, you first insert the basic configuration of a SIPROTEC 5 device into the project. Then you add the hardware for this basic configuration, for example, communication modules and current connections.

Device Characteristics

When configuring a SIPROTEC 5 Compact device manually, you must set the following 2 device characteristics:

- **Integrated Ethernet Interface (Port F)**
This feature determines whether the integrated Ethernet interface (Port F) is an optical or electrical variant.
- **Function-point class**
This feature specifies the number of available function points. You can select from among various function-point classes. Basis+200 is an example of such a function-point class. **Basic** means that certain basic functionality is provided by the device type. **200** is the number of function points that you accrue. This function-point value represents your function-point credit. This function-point credit makes additional functions available to you for enhancing the SIPROTEC 5 device.

When configuring the SIPROTEC 5 device manually, you must set the following device characteristics:

- **Voltage variant**
This feature specifies the voltage variant of the SIPROTEC 5 device. The voltage variant specifies the permissible voltage range of the supply voltage. You can select from among the settings **60 V to 250 V DC**, **115 V to 230 V AC** and **24 V to 48 V DC**.
- **Integrated Ethernet interface**
This feature determines the functionality of the integrated Ethernet interface. If you wish to use the integrated Ethernet Interface as the only user interface for DIGSI 5, select the setting **Only DIGSI 5 connection**. If you wish to use the IEC 61850 report functionality as well, select the setting **DIGSI 5 connection and IEC 61850 reports**.
- **Significant feature**
This feature specifies the number of ends for multi-end protection, for example, for SIPROTEC 5 devices of the type **7SL87**. You can select from among the settings **Two-end protection**, **Three-end protection**, and **Multi-end protection**.
- **Function-point class**
This feature specifies the number of available function points. You can select from among various function-point classes. Basis+200 is an example of such a function-point class. **Basic** means that certain basic functionality is provided by the device type. **200** is the number of function points that you accrue. This function-point value represents your function-point credit. This function-point credit makes additional functions available to you for enhancing the SIPROTEC 5 device.

Except for the feature **Voltage variant**, you can change the settings for all features later in the device settings.

Goal

The goal of this chapter is to create the project structure shown in the following figure.

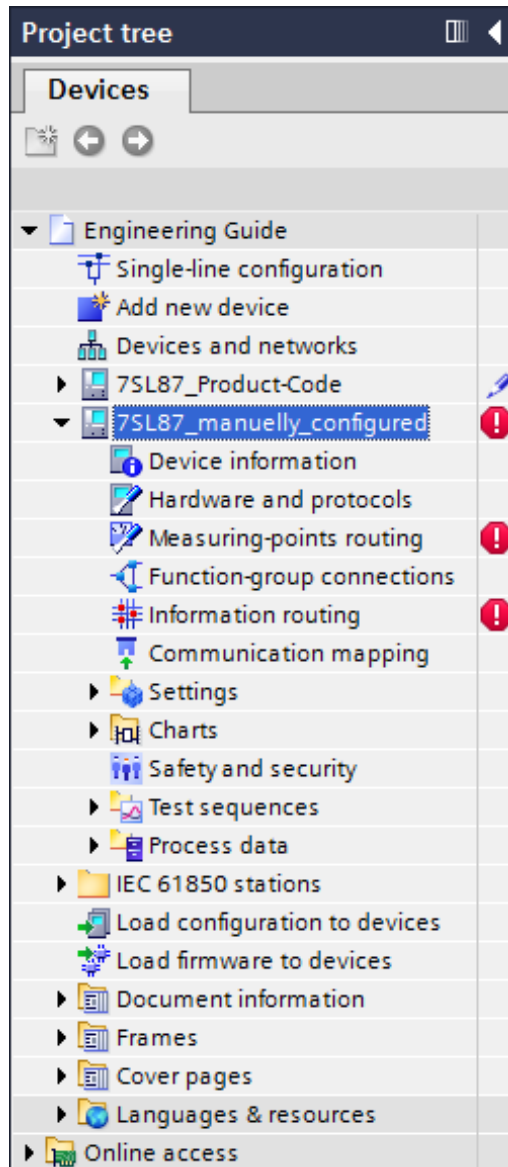

[scprostr_02_1_en_US]

Figure 2-23 Project Tree with Additional 7SL87_Manually_configured Offline Configuration

The project structure contains an additional offline configuration for the inserted SIPROTEC 5 device with a basic configuration.

Overview of the Procedure

Perform the following actions:

- Open the Network view and the Hardware catalog.
- Select a basic configuration.
- Specify the device characteristics and select an application template.

Opening the Network View and the Hardware Catalog

◇ Double-click **Devices & networks** in the project tree.

The Device and Network Editor opens in the working area and the Network view is displayed.

◇ At the right edge of the task card, select the **Hardware catalog** tab.

The **Hardware catalog** tab is displayed in the task card.

- ✦ Hide the project tree by clicking the arrow icon.

The working area increases in size.

You have now reached the following point:

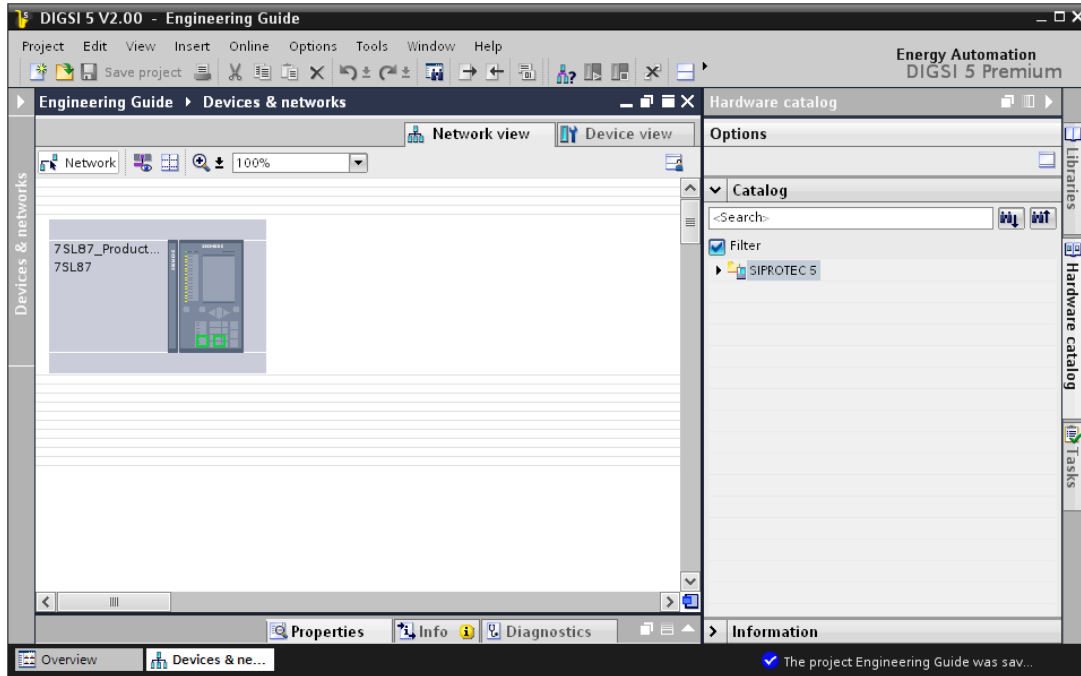

[sc_nethwk, 1, en_US]

Figure 2-24 Intermediate Result: Network View and Hardware Catalog

Selecting the Basic Configuration

- ✦ In the Hardware catalog, open the **SIPROTEC 5** and **7SL87 Diff.- & Dist., 1-/3-p.** folders in succession.

The names of the basic configurations possible for this device type are displayed.

- ✦ Highlight the basic configuration **2: 1/3, 11BI, 9BO, 4CT, 4VT**.

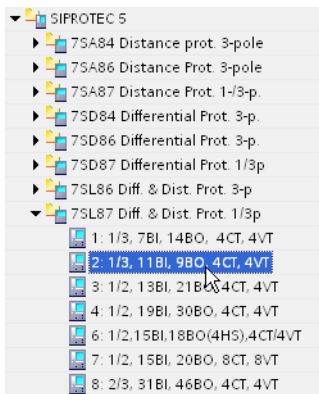

[sc_mrkgr, 1, en_US]

Figure 2-25 Basic Configuration Highlighted in the Hardware Catalog

An image as well as a descriptive text for the basic configuration selected appear in the **Information** area for your support.

- ✦ Hold down the mouse button and drag the highlighted basic configuration to the Network view.
- ✦ Release the mouse button.

The **Add new device** dialog opens.

Specifying Device Characteristics and Selecting the Application Template

- ✧ Specify the device characteristics using the list boxes in **Select device characteristics**. Select the following settings:

Voltage variant: **DC 60 V to 250 V, AC 115 V to 230 V**

Integrated Ethernet Interface: **Only DIGSI 5 connection**

Significant feature: **Two-end protection**

Function-point class: **Basic + 100**

Voltage variant:	DC 60 V to 250 V, AC 115 V to 230 V
Integrated Ethernet interface (port I):	Only DIGSI 5 connection
Significant feature:	Two-end protection
Select function-point class:	Base + 100

[sc_gereig_1_en_US]

Figure 2-26 List Boxes for Device Characteristics

The **Application-template selection** list box is activated.

- ✧ In the **Application-template selection** list box, highlight the application template **DIFF/DIS Basic**.
- ✧ Click **OK**.

The **Add new device** dialog is closed. The required device data is loaded and the SIPROTEC 5 device is added to the project. An additional offline configuration is added to the project tree. An icon for the SIPROTEC 5 device is also placed in the single-line configuration, the Network view, and the Device view.

- ✧ Rename the new SIPROTEC 5 device **7SL87_Manually_configured**.
Proceed in the same way described in the chapter [2.4.2 Inserting a SIPROTEC 5 Device with Product Code/MLFB Number](#), section **Renaming a SIPROTEC 5 device**.
- ✧ Save the project.

You have thus achieved the goal.

In the project tree, the icons  show you that the offline configuration of the newly added SIPROTEC 5 device is inconsistent. You can remove this inconsistency by fully configuring the hardware for the SIPROTEC 5 device and synchronizing the hardware.

You can learn how to do this in the chapters [2.4.4 Completing the Hardware for the SIPROTEC 5 Device](#) and [2.4.7 Changing the Connection Type of the Measuring Point](#).

2.4.4 Completing the Hardware for the SIPROTEC 5 Device

The hardware for the SIPROTEC 5 device **7SL87_Manually_configured** is not yet complete. You must still add additional components to the hardware.

Goal

The goal of this chapter is to create the hardware configuration shown in the following figure.

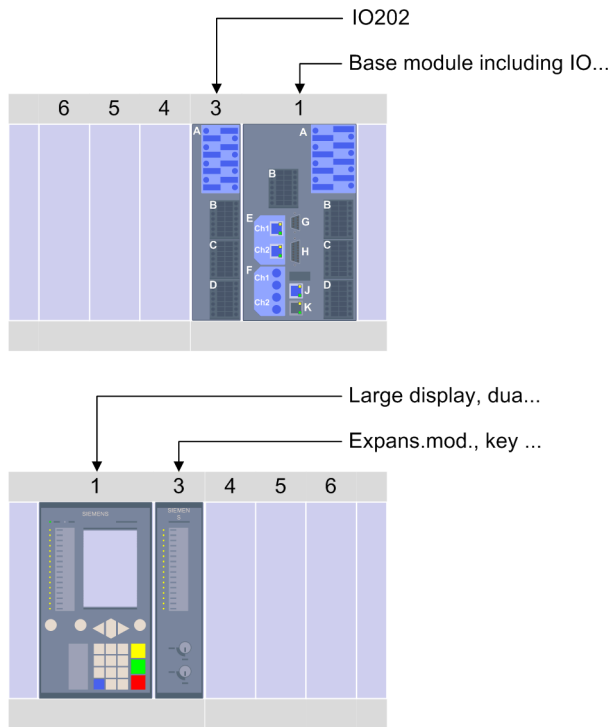

[dw_hwkonf_05_1_en_US]

Figure 2-27 Hardware Configuration of the SIPROTEC 5 Device 7SL87_Manually_Configured

The hardware configuration contains the same components as the SIPROTEC 5 device **7SL87_Product Code**:

- 1 base module
- 1 expansion module **IO 202**
- 2 terminals **Current 4 x Protection**
- 1 communication module **ETH-BA-2EL**
- 1 communication module **USART-AE-2FO**
- 1 operation panel **Large display, 2-color LEDs** for the base module
- 1 operation panel **Expans.mod., key./red LEDs** for the expansion module

The base module is already specified by the basic configuration. You must add all other components.

Overview of the Procedure

Perform the following actions:

- Open the Device view and the Hardware catalog.
- Add the expansion module.
- Add the terminals.
- Add the communication modules.
- Add the operation panels.

Displaying the Device View and the Hardware Catalog

- ✧ In the Network view, double-click the SIPROTEC 5 device **7SL87_Manually_configured**.

The Device view is displayed in the working area.

- ✧ At the right edge of the task card, select the **Hardware catalog** tab.

The **Hardware catalog** tab is displayed in the task card.

✧ Hide the project tree by clicking the arrow icon.

The working area increases in size.

The Device view shows the following hardware configuration:

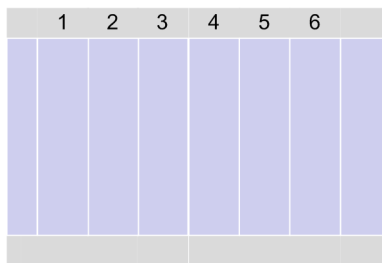
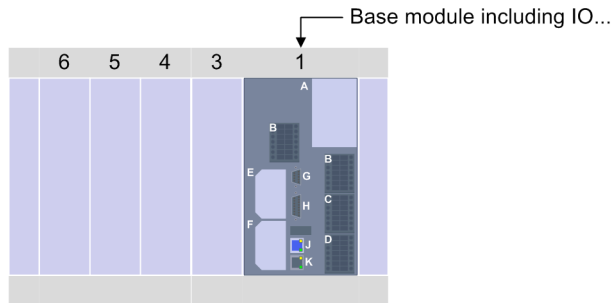

[dw_hwkonf_01, 1, en_US]

Figure 2-28 Intermediate Result: Hardware Configuration after Insertion of the Basic Configuration

Adding the Expansion Module

✧ In the Hardware Catalog, open the **SIPROTEC 5** and **I/O modules** folders in succession.

The names of the selectable expansion modules are displayed.

✧ Highlight the expansion module **IO 202**.

In the Device View, colored frames identify all possible mounting positions for the highlighted expansion module.

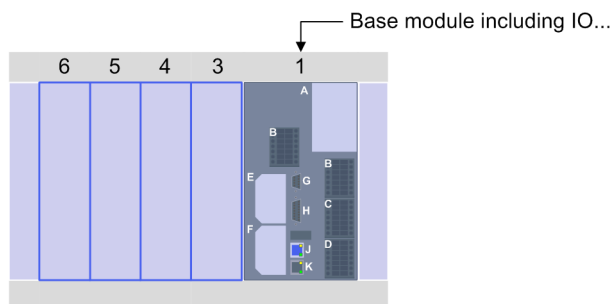

[dw_iomark_01, 1, en_US]

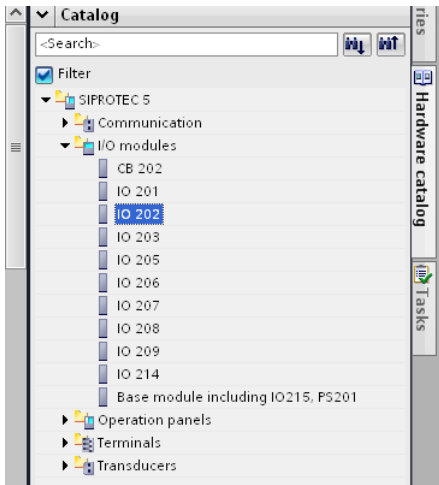

[sc_1omark_1_en_US]

Figure 2-29 I/O Module Highlighted in the Hardware Catalog and Possible Mounting Positions

- ✧ Hold down the mouse button and drag the highlighted expansion module to mounting position 3.
- ✧ Release the mouse button.

The expansion module is placed at the selected mounting position.

You have now reached the following point:

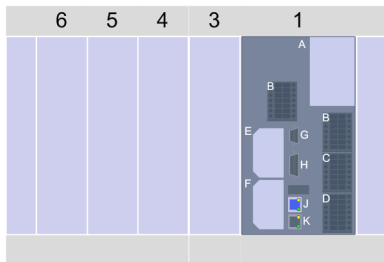

[dw_hwkonf_02_1_--]

Adding the Terminals

- ✧ In the Hardware catalog, open the **Terminals** folder.

The names of the selectable terminals are displayed.

- ✧ Highlight the terminal **Current 4 x Protection**.

In the Device view, colored frames identify all possible mounting positions for the highlighted terminal.

- ✧ Hold down the mouse button and drag the highlighted terminal to one of the 2 mounting positions.
- ✧ Release the mouse button.

The terminal is placed at the selected mounting position.

- ✧ Repeat the procedure and place one additional **Current 4 x Protection** terminal at the remaining mounting position.

You have now reached the following point:

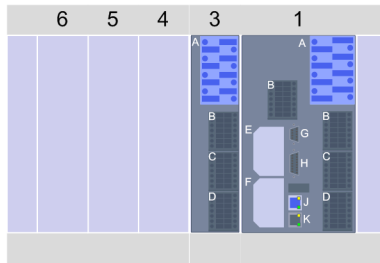

[dw_hwkonf_03, 1, ---]

Figure 2-30 Intermediate Result: Hardware Configuration after Mounting the Terminals

Adding the Communication Modules

- ✧ In the Hardware catalog, open the **Communication** folder.

The names of the selectable communication modules are displayed.

- ✧ Place 1 each of the communication modules **ETH-BA-2EL** and **USART-AE-2FO** at the mounting positions provided. Follow the same procedure used for the terminals.

You have now reached the following point:

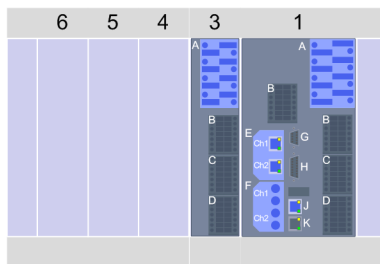

[dw_hwkonf_04, 1, ---]

Figure 2-31 Intermediate Result: Hardware Configuration after Mounting the Communication Modules

Adding the Operation Panel

- ✧ In the Hardware catalog, open the **Operation panels** folder.

The names of the selectable operation panels are displayed.

- ✧ Double-click **Large display, 2-color LEDs**.

The operation panel is placed at the correct mounting position.

- ✧ Double-click **Expans.mod., key,/red LEDs**.

The operation panel is also placed at the correct mounting position.

- ✧ Save the project.

You have thus achieved the goal.

2.4.5 SIPROTEC 5 Device in the Single-Line Configuration

A device symbol is shown in the single-line configuration for each SIPROTEC 5 device in the project. This device icon represents the application of the SIPROTEC 5 device. The following figure shows the informational content of a device icon.

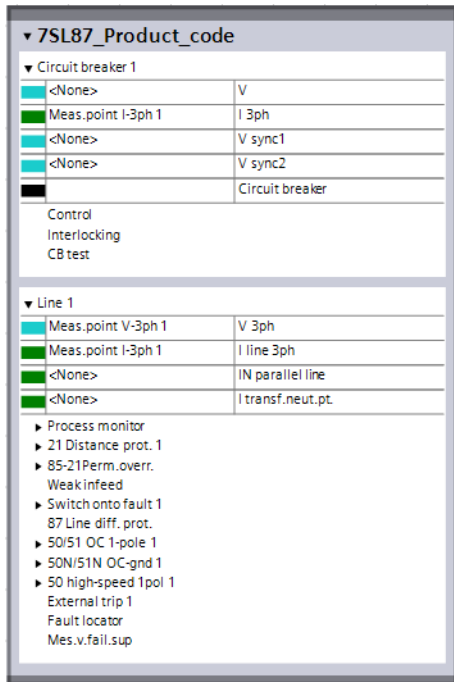

[isc_gersym, 1, en_US]

Figure 2-32 Example of a Device Icon in the Single-Line Configuration

To keep the configuration clear, you connect a transformer directly to the interface of a function group in the single-line configuration. In fact, the transformers are connected to the analog inputs of the SIPROTEC 5 device and the analog inputs are connected to the logical measuring points. These measuring points are then assigned to the interfaces of the function groups. Thus, in addition to each interface, you find a list box in the device icon that you can use to assign a measuring point to the interface.

Elements of a Device Icon

A device icon contains the following elements:

- **Function groups**
 The device symbol contains the function groups that represent a part of the primary equipment, for example, a line or a circuit breaker. There are also further function groups, for example, for fault recording, but these are not shown in the device symbol. Each function group is represented by a rectangle and the name of the function group. Clicking the arrow icon reduces an opened function group to its name. A further click on the arrow icon opens the rectangle of the function group again, showing the name of all the functions included.
- **Functions**
 Each rectangle that represents a function group contains the names of all functions that are part of this function group. Clicking the arrow icon next to the function name shows the names of the associated function blocks. A further click on the arrow icon reduces the function to its name.
- **Function blocks**
 A function can consist of multiple function blocks. For example, a function block can be a stage, but also a zone.

- **Interfaces**

Different functions require measured values as input signals or provide commands as output signals. To permit connection of these input and output signals with the corresponding equipment, function groups have one or several interfaces, depending on the type:

- Current inputs
- Voltage inputs
- TRIP outputs
- CONTROL outputs

Options

Using the interfaces listed in the enumeration, you can create connections between equipment such as transformers or circuit breakers and the application. In this way, you create a direct reference between the switch-gear and the application. The benefit is that with a mouse click you can transfer the transformer data from the single-line configuration to the function settings in the offline configuration of the associated SIPROTEC 5 device.

You can learn more about this topic in the chapter [2.4.6 Connecting the Device Application with Equipment](#).

You can also use the device icon to modify the functional scope of the SIPROTEC 5 device. You can add or delete function groups, functions, and function blocks directly in the single-line configuration with the aid of the device icon.

You can learn more about this topic in the chapter [2.5.2 Adding Application Elements](#).

2.4.6 Connecting the Device Application with Equipment

Using the interfaces for the function groups, you can create connections between equipment such as transformers or circuit breakers and the application.

Goal

The goal of this chapter is to create the single-line configuration shown in the following figure.

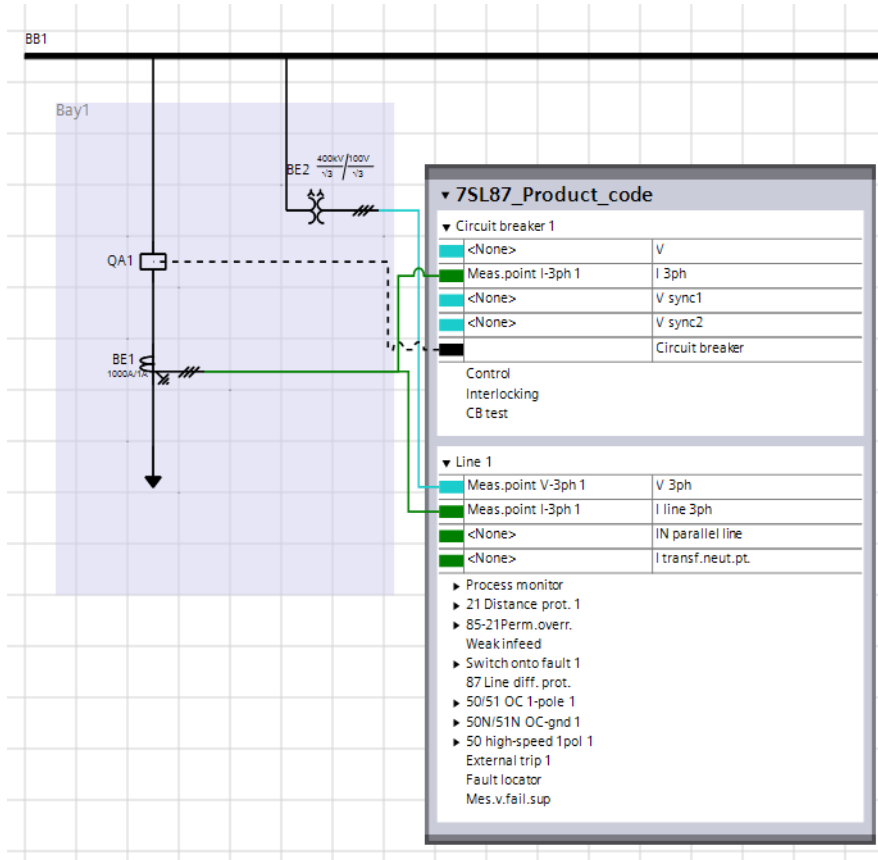

[sc_sikonf_11_1_en_US]

Figure 2-33 Connecting the Application of the SIPROTEC 5 Device 7SL87_Product Code with Transformers and Circuit Breakers

The 2 transformers and the circuit breaker are to be connected with the appropriate interfaces in the function groups **Line 1** and **Circuit breaker 1**.

Overview of the Procedure

Perform the following actions:

- Open the single-line configuration.
Follow the same procedure described in the chapter [2.3.3 Creating a New Single-Line Configuration](#).
- Move the device icon **7SL87_Product Code** and open the 2 function groups.
- Connect the transformer with the application.
- Connect the circuit breaker with the application.

Moving the Device Icon and Opening the Function Groups

- ✦ Click the device icon **7SL87_Product Code** and, while holding down the mouse button, drag it between the 2 bays **Bay 1** and **Bay 2**.
- ✦ Release the mouse button.

This repositions the device icon.

- ✦ Click the arrow icon in the **Circuit breaker 1** function group.

The function group opens.

- ✦ Repeat this procedure for the **Line 1** function group.

You have now reached the following point:

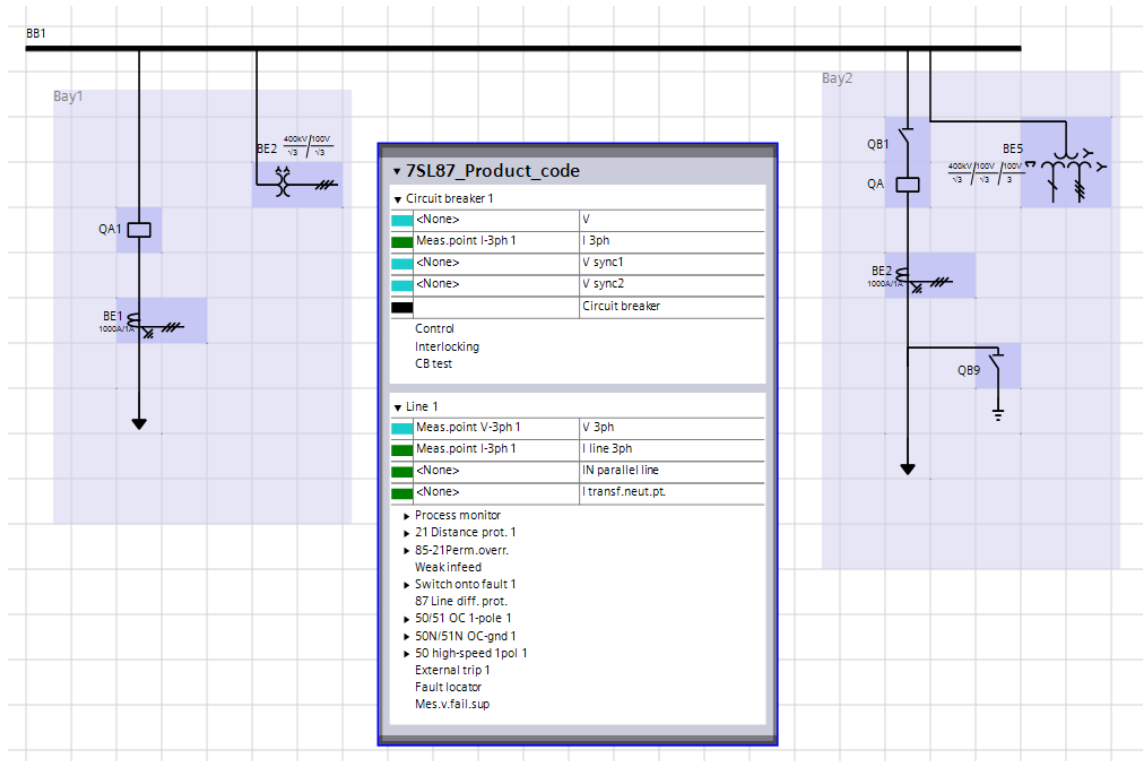

[sc_silkonf_09_1_en_US]

Figure 2-34 In-Between Result: Device Icon 7SL87_Product Code Centered

Connecting the Transformer with the Application

Connect the current transformer and the voltage transformer with the appropriate interfaces in the **Line 1** function group.

- ✦ Position the mouse pointer on the right connection point of the current transformer **BE1**.

The mouse pointer is in the correct position when it changes to a hand.

- ✦ Hold down the left mouse button and draw a direct line to the interface identified with a green rectangle **I-line 3ph** in the **Line 1** function group.

The line connects automatically with the connection point. The connection point is also highlighted in color.

- ✦ Release the mouse button.

A tie line is drawn between the 2 connection points. Since the **Circuit breaker 1** function group also needs the value of the current measured at the transformer, the **I 3ph** interface is connected automatically with this function group.

- ✦ Repeat the procedure with the voltage transformer **BE2**. This time, connect this transformer with the **U 3ph** interface.

A tie line is drawn between the 2 connection points.

You have now reached the following point:

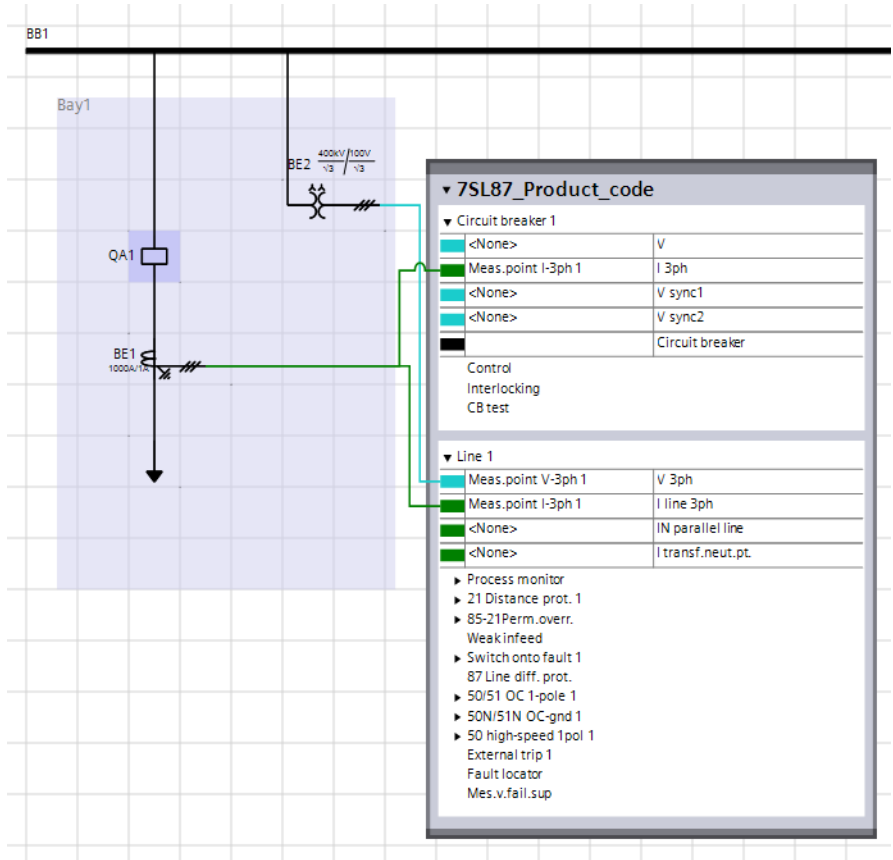

[sc_sikonf_10_1_en_US]

Figure 2-35 In-Between Result: Application of the SIPROTEC 5 Device 7SL87_Product Code Connected with Transformers

Connecting the Circuit Breaker with the Application

Connect the circuit breaker with the appropriate interface in the **Circuit breaker 1** function group.

- ✧ Position the mouse pointer at the center of the circuit breaker **QA1**.

The mouse pointer is in the correct position when it changes to a hand.

- ✧ Hold down the left mouse button and draw a direct line to the interface identified with a black rectangle **Circuit break.** in the **Circuit breaker 1** function group.

The line snaps to the connection point. The connection point is also highlighted in color.

- ✧ Release the mouse button.

A tie line is drawn between the 2 connection points.

You have thus achieved the goal.

2.4.7 Changing the Connection Type of the Measuring Point

Measuring points as part of the application are the binding link between the physical inputs of a SIPROTEC 5 device and the function groups of an application. Measuring points conduct the current and voltage values delivered by transformers further to the functions in the function groups.

The chapter [2.4.6 Connecting the Device Application with Equipment](#) has shown you how to connect transformers in the single-line configuration with measuring points for the application.

This chapter describes how you can change the connection type of a measuring point.

Connection Type

By selecting a connection type, you adapt a measuring point to a three-wire or four-wire system as well as to a star or delta connection. The connection type also determines the number of the measuring-point inputs. A 1-phase measuring point always has only one single input. A 3-phase measuring point has 3 or 4 inputs, depending on the connection type.

Measuring-Point Routing Matrix

The number of measuring points, the connection type, and the assignment to physical inputs of the SIPROTEC 5 device are defined in measuring-point routing. The measuring-point routing is device-oriented. For this reason, the measuring-point routing in the project structure is always saved in the offline configuration of a SIPROTEC 5 device. You edit the measuring-point routing with the **Measuring-point routing** matrix.

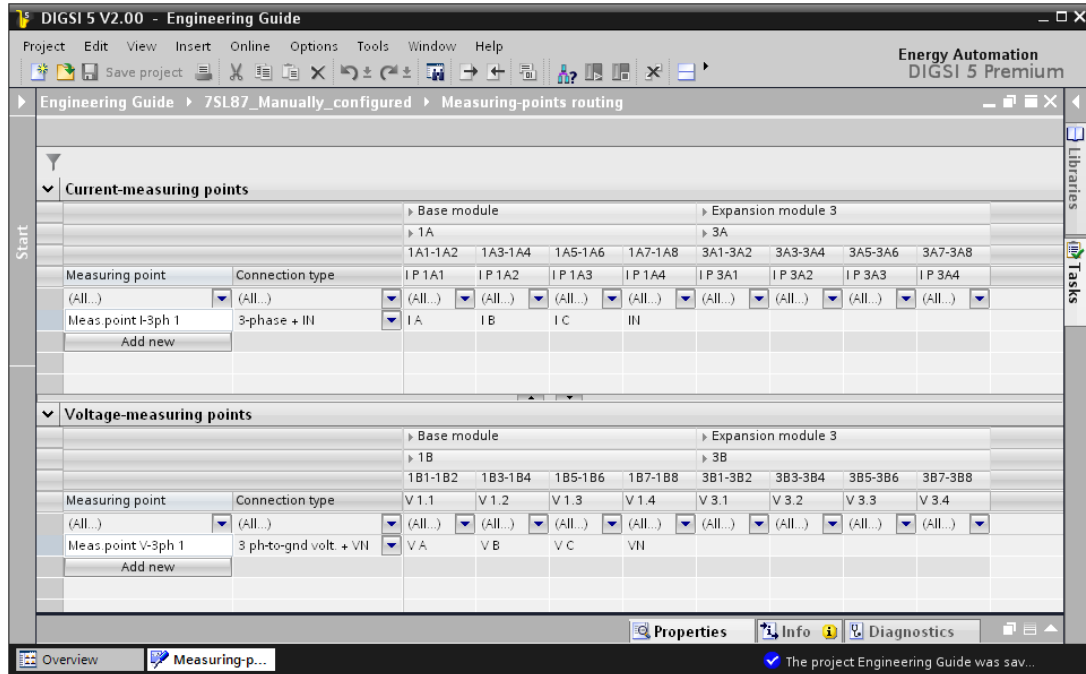

[sc_mesran, 1, en_US]

Figure 2-36 Measuring-Point Routing Matrix

Goal

The goal of this chapter is to create the voltage measuring-point routing shown in the following figure with the connection type **3 ph-to-ph voltages**.

Voltage-measuring points		Base module			
		1B			
		1B1-1B2	1B3-1B4	1B5-1B6	1B7-1B8
Measuring point	Connection type	V 1.1	V 1.2	V 1.3	V 1.4
(All...)	(All...)	(All...)	(All...)	(All...)	(All...)
Meas.point V-3ph 1	3 ph-to-ph voltages	V AB	V BC	V CA	

[sc_mesneu, 1, en_US]

Figure 2-37 Measuring Point with Changed Connection Type and New Routing

Overview of the Procedure

Perform the following actions:

- Open the measuring-point routing.
- Synchronize the hardware.

- Change the connection type for the voltage measuring point.
- Route the voltage measuring point.

Opening the Voltage Measuring Point

- ✧ In the project tree, open the folder for the **7SL87_Manually_configured** offline configuration.
- ✧ In this folder, double-click **Measuring-point routing**.

The **Measuring-point routing** matrix opens in the working area. The 2 windows **Current measuring points** and **Voltage measuring points** are highlighted in orange in the upper region.

Synchronizing the Hardware

When you configure a SIPROTEC 5 device manually, inconsistencies can arise between the scope of the hardware and the routing defined by the selected application. DIGSI 5 detects these inconsistencies and can correct them automatically with the **Synchronize the hardware** function.

- ✧ Click **Synchronize the hardware** in one of the 2 areas marked in orange.

The dialog **Synchronize the hardware** opens.

- ✧ In this dialog, click on **Yes**.

The dialog closes and hardware synchronization starts.

Once the hardware has been synchronized, the regions highlighted in orange disappear. The  icons in the project tree also disappear. The offline configuration of the SIPROTEC 5 device is now consistent.

Changing the Connection Type

- ✧ In the **Voltage measuring points** region in the **Connection type** column, open the list box for the measuring point **U-3ph 1**.
- ✧ Select the connection type **3 ph-to-ph voltages**.

The previous routing is deleted. The line is highlighted in a color.

You have now reached the following point:

Voltage-measuring points					
▶ Base module					
▶ 1B					
		1B1-1B2	1B3-1B4	1B5-1B6	1B7-1B8
Measuring point	Connection type	V 1.1	V 1.2	V 1.3	V 1.4
(All...)	(All...)	(All...)	(All...)	(All...)	(All...)
Meas. point V-3ph 1	3 ph-to-ph voltages				
Add new					

[sc_mesneu_02, 1, en_US]

Figure 2-38 In-Between Result: Measuring-Point Routing after Changing the Connection Type

Routing Measuring Points

When you change the connection type for a measuring point, the routing to the terminals is removed. You must thus reroute the measuring point to the pair of input terminals.

- ✧ Right-click in the common cell of the measuring point and the pair of input terminals **V1.1**.

The context menu shows the available routing options.

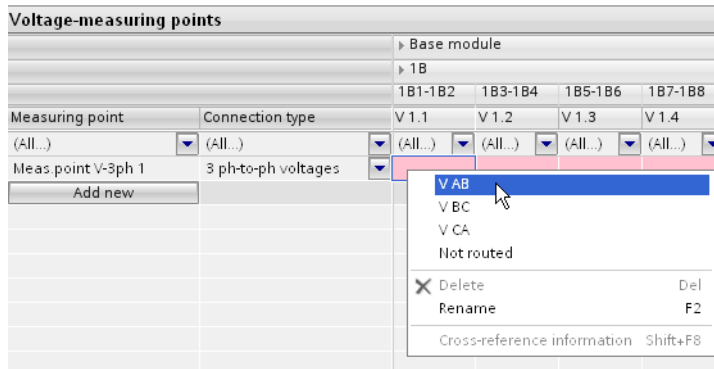

[sc_mesneu_03_1_en_US]

Figure 2-39 Context Menu with Routing Options

- ✧ Select the routing **VAB**.

The selected routing is entered in the cell.

- ✧ Repeat this procedure for the pair of input terminals **V1.2** and the routing **VBC** as well as for the pair of input terminals **V1.2** and the routing **VCA**.
- ✧ Save the project.

You have thus achieved the goal.

2.5 Adjusting the Functional Scope

2.5.1 Overview

With the new application-oriented functional concept, you have to select an application template at the start of engineering, for example for line protection. With this, you have defined the entire functional scope of the SIPROTEC 5 device. In many cases, you can use the selected application template without any changes. But in addition, you have the means to optimize the functional scope of the application, and thus of the SIPROTEC 5 device, exactly to fit your specific needs. For many functions, you can also determine the number of stages. Thus you adapt the functions exactly to individual protection concepts.

Options

You change the functional scope of an application by adding or deleting application elements such as function groups, functions, and function blocks. Depending on the type of the application element, you can do this at different points in the project:

- In the single-line configuration
- In the project tree
- In communication mapping
- In information mapping
- In the function

Function-Point Status

If you delete or add functions, points are credited to or deducted from your function-point credit. However, function groups and function blocks do not change the function-point status.

2.5.2 Adding Application Elements

This chapter describes how to add a function group, a function, or a function block to the application in the single-line configuration. All necessary application elements can be found in the Global DIGSI 5 library. You can learn more about additional options in the DIGSI 5 Help in the **Applications and Functions > Configuring Applications > Adapting the Functional Scope** chapter.

Goal

The goal of this chapter is to create the application shown in the following figure.

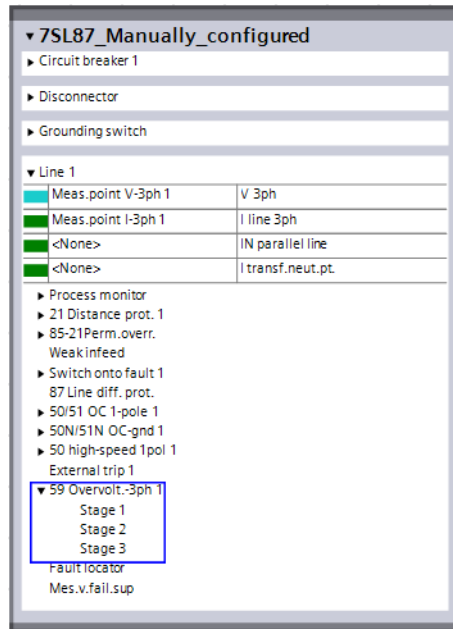

[sc_appenw, 1, en_US]

Figure 2-40 Expanded Application for Function Groups, Function, and Stage

The **7SL87_Manually_configured** application of the SIPROTEC 5 device expanded by both the **Disconnector** and **Grounding switch** function groups (one **Disconnector** each). The application is also expanded by the **Overvolt-3ph** function. This function shall have 3 stages.

Overview of the Procedure

Perform the following actions:

- From the Global DIGSI 5 library, add 2 function groups of the **Disconnector** type to the **7SL87_Manually_configured** application of the SIPROTEC 5 device.
- From the Global DIGSI 5 library, add the **Overvolt-3ph** function to the **7SL87_Manually_configured** application of the SIPROTEC 5 device.
- Expand this function by a 3rd stage.

Opening the Single-Line Configuration and the Global DIGSI 5 Library

If the single-line configuration and the Global DIGSI 5 library are not opened, perform the following actions.

- ✧ In the project tree, double-click **Single-line configuration**.

The single-line configuration appears in the working area.

- ✧ Right-click the working area.
- ✧ Click **Insert elements from library** in the context menu.

The **Libraries** tab is displayed in the task card.

- ✧ In order to zoom in on the working area, hide the project tree clicking the arrow icon.

You have now reached the following point:

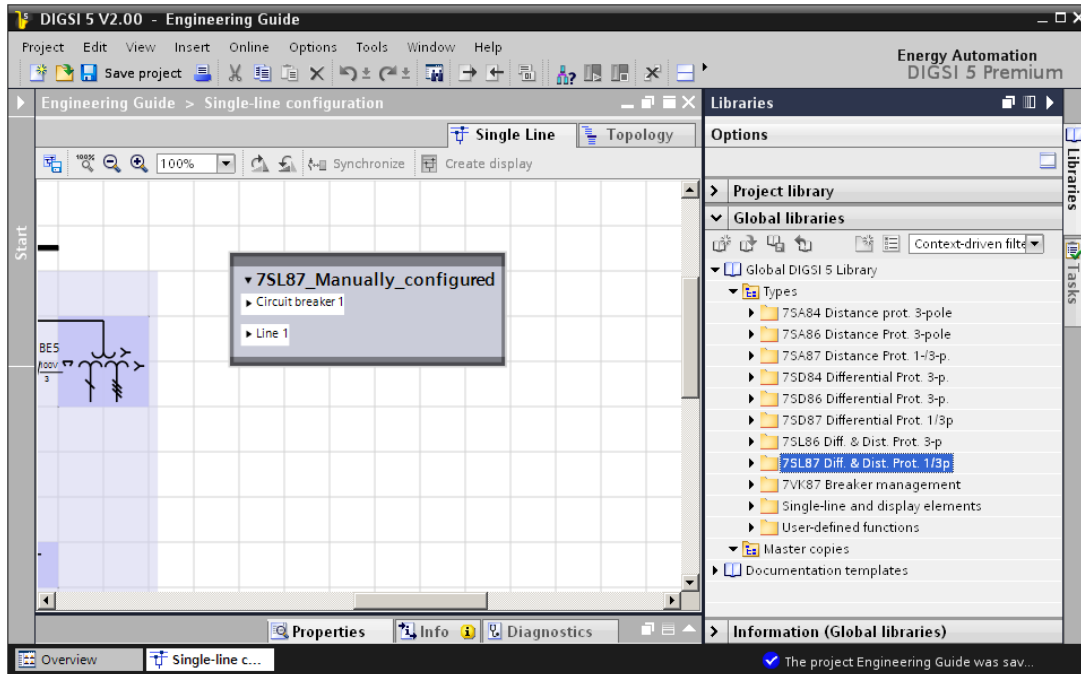

[scalbibl, 1, en_US]
 Figure 2-41 In-Between Result: Single-Line Configuration and Global DIGSI 5 Library

Adding Function Groups

The disconnector QB1 in bay 2 is to be assigned to the application of the SIPROTEC 5 device **7SL87_Manually_configured**. This requires that you add a function group of the type **Disconnector** to the application.

- ✦ In the Global DIGSI 5 library, open the **Types**, **7SL87 Diff.- & Dist., 1-/3-p.**, and **Switching Devices** folders in succession.
- ✦ In the **Switching devices** folder, highlight the **Disconnector** function group.

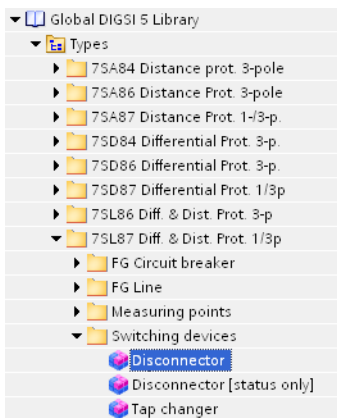

[sc_trmark, 1, en_US]
 Figure 2-42 Function Group Highlighted in the Global DIGSI 5 Library

- ✦ Hold down the mouse button and drag the function group onto the **7SL87_Manually_configured** icon of the SIPROTEC 5 device in the single-line configuration.

Once the proper position is reached, a plus symbol appears next to the mouse pointer.

- ✦ Release the mouse button.

The function group is now added to the device icon, and thus the application.

- ✧ Repeat the procedure for the 2nd **Disconnecter** function group.

You have now reached the following point:

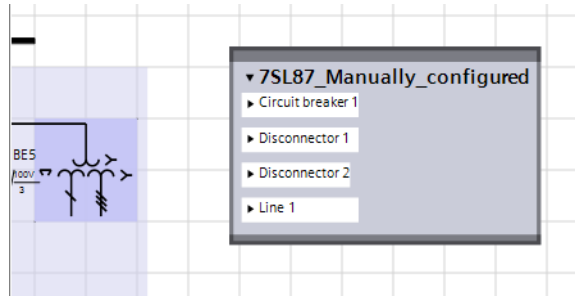

[sc_treing_1_en_US]

Figure 2-43 In-Between Result: Application with Added Disconnecter Function Groups

Renaming Function Groups

The function group is given a name when added to the application. In the initially added function group of a certain type, this name consists of the type identifier, for example **Disconnecter**. The names of all subsequent function groups of the same type have a consecutive number as a suffix, for example **Disconnecter 1**. You can change the name of a function group in the project tree.

- ✧ Open the project tree.
- ✧ In the project tree, open the folder for the **7SL87_Manually_configured** offline configuration.
- ✧ Open the **Settings** folder in this folder.
- ✧ In this folder, right-click the **Disconnecter** function group.
- ✧ Click **Rename** in the context menu.

The name is displayed in a text box and is highlighted in color.

- ✧ Enter **Disconnecter** as the new name.
- ✧ Click outside of the text box.

The name entered is accepted.

- ✧ Repeat the procedure with the **Disconnecter 1** function group. Rename this to **Grounding Switch**.

You have now reached the following point:

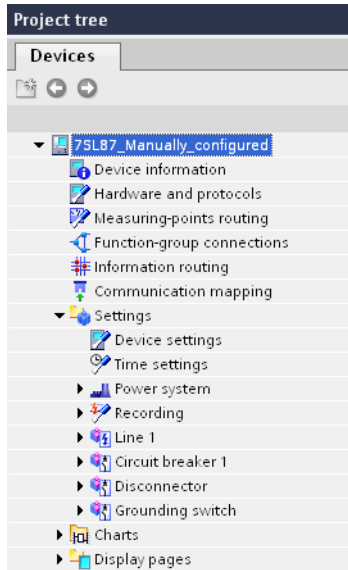

[sc_projsg, 1, en_US]

Figure 2-44 In-Between Result: Project Tree with Renamed Function Groups

Adding a Function

The **Overvolt-3ph** function is to be assigned to the **Line 1** function group of the **7SL87_Manually_configured** application of the SIPROTEC 5 device.

- ✧ In the **7SL87 Diff.- & Dist., 1-/3-p.** folder in the Global DIGSI 5 library, open the **FG Line** folder.
- ✧ In the **FG Line** folder, open the **Voltage Protection** and **Overvolt-3ph** folders in succession.
- ✧ In the **Overvolt-3ph** folder, highlight the **Overvolt-3ph** function.

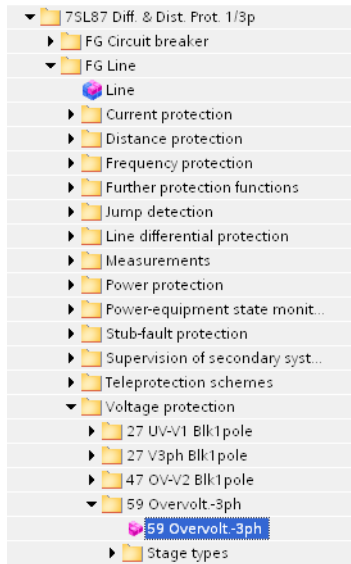

[sc_spgmar, 1, en_US]

Figure 2-45 Function Highlighted in the Global DIGSI 5 Library

- ✧ Hold down the mouse button and drag the function to the **Line 1** function group in the **7SL87_Manually_configured** device icon in the single-line configuration.

Once the proper position is reached, a plus symbol appears next to the mouse pointer.

- ✧ Release the mouse button.

The function is now added to the function group, and thus the application. The function group automatically opens.

You have now reached the following point:

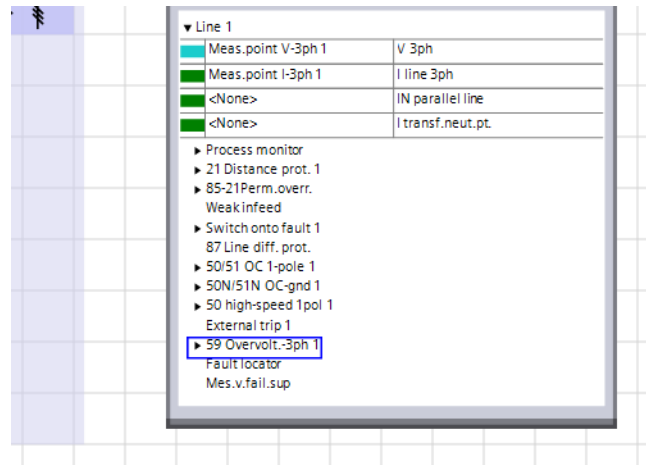

[sc_fueing, 1, en_US]

Figure 2-46 In-Between Result: Application with Added Function

Adding a Function Block

The newly added **Overvolt-3ph** function now has 2 stages. A 3rd stage is to be assigned to the function.

- ✦ In the **7SL87_Manually_configured** device icon, click the arrow to the left of the **Overvolt-3ph** function name.

The function opens. Here you can see the names of both available stages.

- ✦ In the **Overvolt-3ph** folder, open the **Stage type** folder.
- ✦ In the **Stage types** folder, select the **Stage** function stage.
- ✦ Hold down the mouse button and drag the function stage to the **Overvolt-3ph** function in the **7SL87_Manually_configured** device icon in the single-line configuration.

Once the proper position is reached, a plus symbol appears next to the mouse pointer.

- ✦ Release the mouse button.

The function is expanded by the stage.

- ✦ Save the project.

You have thus achieved the goal.

2.5.3 Checking the Function-Point Status

In order to determine if enough function points are available, you can check the current function-point status. If not enough function points are available, you can purchase new function points or delete functions.

Checking the Function-Point Status

- ✦ In the project tree, open the offline configuration **7SL87_Manually_configured**.
- ✦ Double-click **Device information**.

In the working area, multiple tabs with information and setting possibilities are displayed.

- ✦ Select the **Resource consumption** tab.

The selected tab shows you the function-point status of the SIPROTEC 5 device.

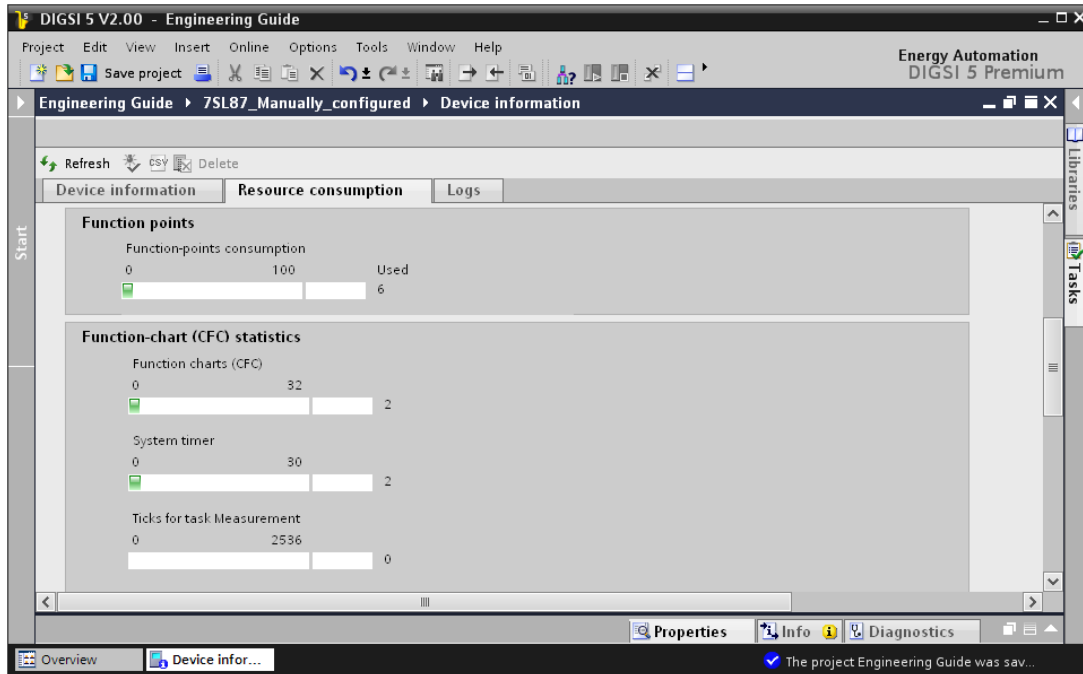

[sc_fpverb, 1, en_US]

Figure 2-47 Resource Consumption Tab

2 scales display the function-point status. The left scale begins with the value 0. On the right edge of the scale, you see the value for the maximum available function points. A green bar within the scale displays the currently used number. Additionally, the currently used number is displayed numerically next to the right-hand, smaller scale. A red bar in the right-hand scale informs you that the maximum available number has been exceeded.

2.6 Routing Information

2.6.1 Overview

Routing means to assign a piece of information to a source and/or a destination. Various types of information, sources, and destinations are available to you for this purpose.

Information, Sources, and Destinations

The following types of **information** are available:

- Measured values
- Metered values
- Indications
- Commands
- Menu items in the Device menu

The following **sources** are available:

- Binary inputs
- Function keys

The following **destinations** are available:

- Binary outputs
- Light-emitting diodes
- Fault records
- Event-log buffer
- Device menu

Principle

If you route a piece of information to a source, it means that a specific event triggers this information. If, for example, you route an indication to a binary input, the routed indication becomes active as soon as the binary input assumes a certain state.

If you route a piece of information to a destination, it means that the piece of information is transmitted or causes a reaction. If, for example, you route the indication to an LED, the LED lights up as soon the indication becomes active.

When routing, you do not only determine the assignment, but also the type of assignment. For example, you can route an indication as **Active with voltage** or as **Active without voltage** to a binary input. With the 1st type of routing, the indication becomes active as soon as a voltage is present at the binary input. With the 2nd type of routing, the indication becomes active if no voltage is present at the binary input.

Information-Routing Matrix

To route information, use the **Information-routing** matrix. With the information-routing matrix, you can assign information to the listed sources and targets.

The **Information-routing** matrix has a table-like structure. Every piece of information is assigned to one line in this matrix. For the sources and targets, the matrix contains columns that are combined into column blocks. The **Information-routing** matrix is a device-oriented tool. A separate **Information-routing** matrix is available for each offline configuration present in a project.

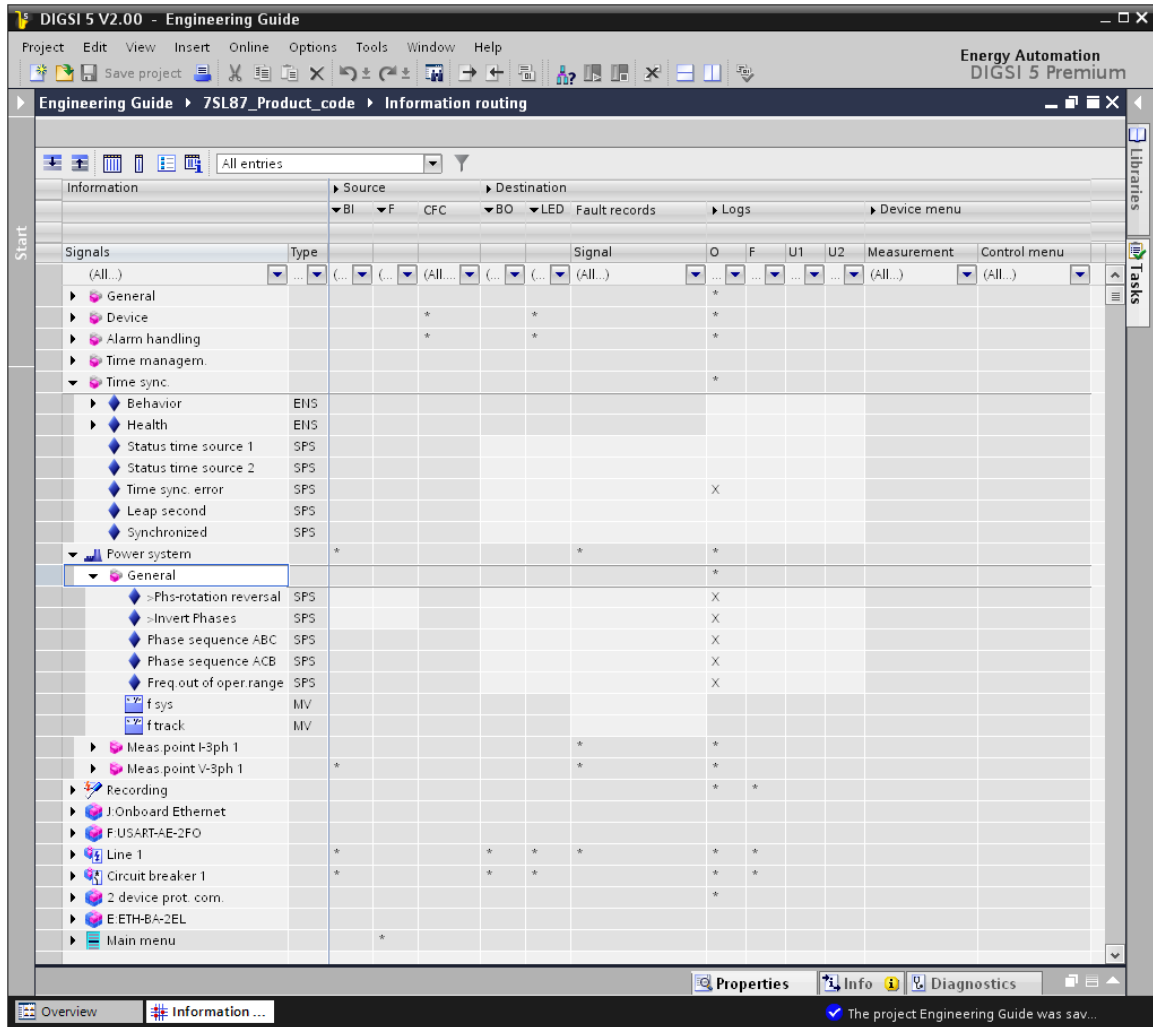

[sc_informat, 1, en_US]

Figure 2-48 Information-Routing Matrix

Signals transferred via DNP3, IEC 60870-5-103, or a protection interface are routed in DIGSI 5 via the **Communication-mapping** matrix.

You can learn more about this topic in the chapter [2.10.2 Selecting and Configuring Protocols](#).

You can find additional information in the DIGSI 5 Help in the **Communication > Configuring communication mapping for serial protocols** section.

2.6.2 Opening the Information-Routing Matrix and Adapting the View

The **Information-routing** matrix contains a variety of information. Siemens thus recommends the following for working with the matrix:

- Work with 2 monitors.
- If you can only work with 1 monitor, maximize the working area.

In addition to these 2 recommendations, you have several options for adapting the **Information-routing** matrix view to your current activity. This chapter explains the following options:

- Hiding and showing rows
- Expanding and collapsing columns

- Filter information routing with predefined display profiles
- Switching between expanded and collapsed column view

You can learn more about additional options in the DIGSI 5 Help in the **Information Routing > Adapting the Information Routing View** section.

Displaying Information Routing

- ✧ In the project tree, open the folder for the offline configuration **7SL87_Product Code**.
- ✧ Double-click **Information routing** in this folder.

The **Information-routing** matrix is displayed in the working area. This matrix displays the information and routings of the offline configuration.

Working with 2 Monitors

- ✧ Delete the **Information-routing** matrix from the working area.

In the title bar of the **Information-routing** matrix, click the  button.

The **Information-routing** matrix is displayed in its own window.

- ✧ Move this window to the 2nd monitor.
- ✧ Scale the window to the needed size.

Maximizing the Working Area

- ✧ In the title bar of the **Information-routing** matrix, click the  button.

The task card, the project tree, and the inspector windows are closed. The working area is maximized:

Showing and Hiding Rows

You can hide and show rows that have been combined into groups. The rows are no longer visible once they are hidden. The rows are displayed as originally when shown again.

(All...)	(All...)	(All...)
▶ General	91	
▶ Device	4171	
▶ Alarm handling	5971	
▶ Time managem.	8821	
▶ Time sync.	8851	
▶ Power system	11	
▶ Recording	51	
▶ J:Onboard Ethernet	101	
▶ F:USART-AE-2FO	102	
▶ Line 1	21	
▶ Circuit breaker 1	301	
▶ 2 device prot. com.	31	
▶ E:ETH-BA-2EL	103	
▶ Main menu		

[sc_zelaus, 1, en_US]

Figure 2-49 Example of Hidden Rows

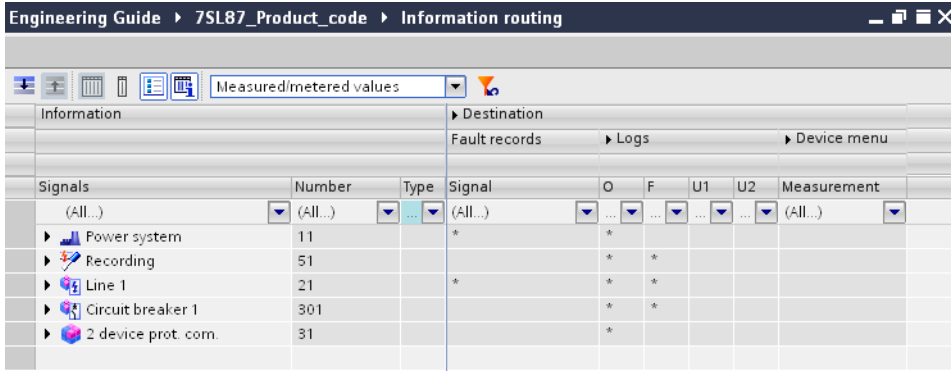

[sc_matmzw, 1, en_US]

Figure 2-53 View Filtered with the Measured and Metered Values Display Profile

- ✧ Open the list box for display profiles in the **Information-routing** matrix toolbar.
- ✧ Select the display profile that suits your working situation.

The view of the **Information-routing** matrix is adjusted according to the display profile selected.

- ✧ If you wish to return to the default setting, select **All entries** from the list box.

All information, sources, and destinations are displayed without any restrictions.

Switching between Expanded and Collapsed Column View

In the expanded column view, you have access to all columns. In the collapsed column view, the **Information-routing** matrix shows one collective column each for the listed column blocks. Switching from the expanded to the collapsed column view thus reduces the number of columns displayed.

The choice between expanded and collapsed column view has an effect on the display of the following column blocks:

- Binary inputs
- Function keys
- Binary outputs
- LEDs

In the expanded column view, you have access to all columns of the listed column blocks. In the collapsed column view, the **Information-routing** matrix shows one collective column each for the listed column blocks. Within the individual cells of a collective column, abbreviations provide information about the type of routing of a specific information. The abbreviation **L5** in a cell of the collective column **BI** means, for example, that the associated information with the option **Active without voltage** is routed to binary input 5. In the collapsed column view, you have the benefit of being able to route information quickly via a text input.

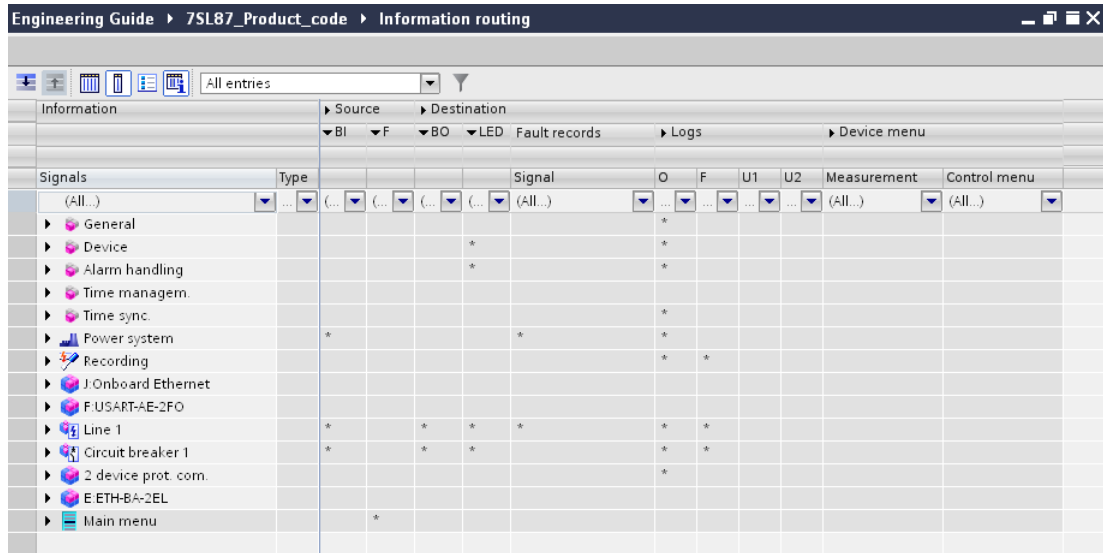

[sc_matred, 1, en_US]

Figure 2-54 Collapsed Column View

✧ In the toolbar of the **Information-routing** matrix, click the  button.

Information routing is displayed in the collapsed column view.

✧ If you wish to return to the expanded column view, click the  button.

All information, sources, and destinations are displayed without any restrictions.

2.6.3 Basic Procedure for Routing

To route information, place the mouse pointer on the cell that forms the intersection between the information cell and the source or destination column in the **Information-routing** matrix. Crosshair lines assist you in finding this shared cell. Then select one of the available routing types from the context menu of the selected cell. The routing type depends on the piece of information, source, and destination.

Determine if Routing Is Possible

If the shared cell is light gray, then the information can be routed. If the shared cell is dark gray, then the information cannot be routed. When clicking a light grey cell, the cell turns white. Dark grey cells do not turn white when you click them.

Routing Types in the Context Menu

The context menu lists entries for several routing types. The specific available routing types depend on the type of information and on the type of source or destination.

- ✧ Position the mouse pointer on the affected cell.
- ✧ Right-click in the cell.
- ✧ In the context menu, click one of these entries.

The routing abbreviation describing the type of selected routing is entered into the cell.

Removing Individual Routings from a Cell

Each context menu offers the **Not routed** entry. You can use this entry to remove individual routings.

- ✧ Position the mouse pointer on the affected cell.

- ✧ Right-click in the cell.
- ✧ Click **Not routed** in the context menu.

The routing is removed from the selected cell.

Removing Routings by Columns

You can remove all deletable routings in a column simultaneously.

- ✧ Highlight the column.
- ✧ Right-click the marked column.
- ✧ Click **Delete routing** in the context menu.

All deletable routings in this column are removed, even the currently hidden routings.

Entering Routing via the Keypad

You can also enter the routing via the keypad.

- ✧ Double-click the affected cell.
- ✧ Enter the abbreviation for the routing into the cell via the keypad.
- ✧ Click outside the cell.

A plausibility check returns an error message if routing is not permitted. In all other cases, the routing abbreviation is accepted.

2.6.4 Routing Information to Sources and Destinations

The existing routings for the phase C trip command and the close command for circuit breaker 1 are to be changed. In addition, the indication **Pickup** is to be routed to user-defined log 1. If function key 4 of the SIPROTEC 5 device **7SL87_Product_code** is pressed, the contents of user-defined log 1 should appear in the display of the device. This chapter describes the steps required to achieve this.

Goal

The goals of this chapter are the routings shown in the following 2 figures:

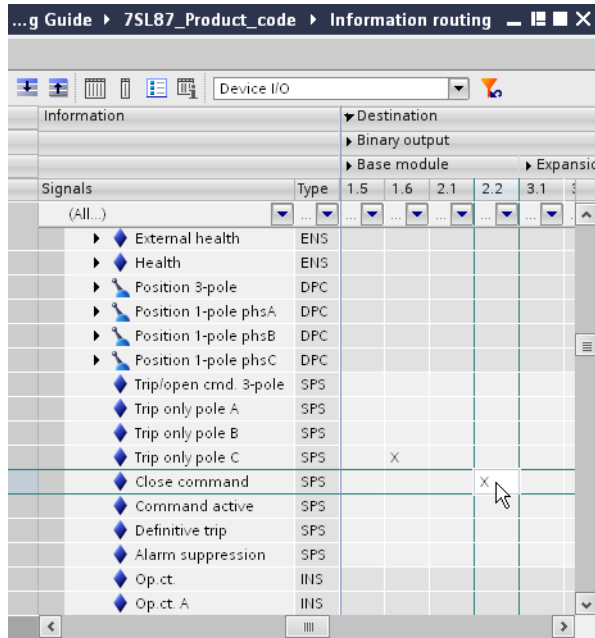

[sc_matran_04, 1, en_US]

Figure 2-55 Routing for the Phase C Trip Command and the Close Command for Circuit Breaker 1

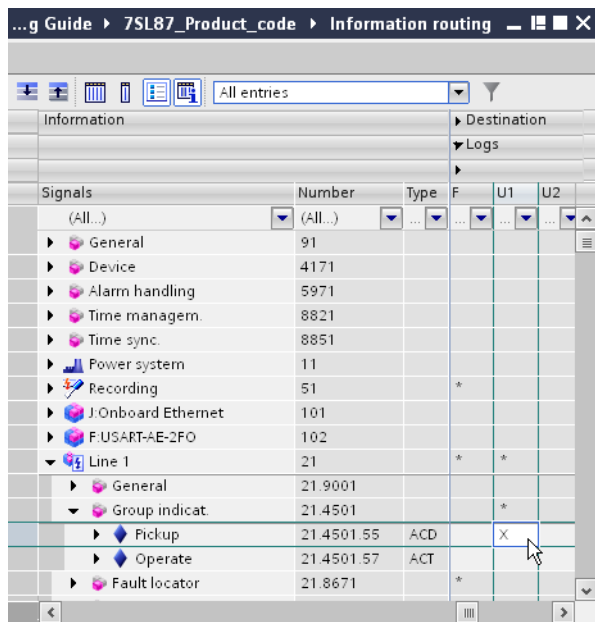

[sc_matran_06, 1, en_US]

Figure 2-56 Routing for Pickup

Overview of the Procedure

Perform the following actions:

- Open the **Information-routing** matrix for the offline configuration **7SL87_Product_code**. Follow the procedure described in the chapter [2.6.2 Opening the Information-Routing Matrix and Adapting the View](#).
- Maximize the working area. Follow the procedure described in the chapter [2.6.2 Opening the Information-Routing Matrix and Adapting the View](#).

- Reroute the **Phase C** trip command and the close command.
- Route the function key and the indication to the user-defined log.

Rerouting the Phase C Trip Command and Close Command

In DIGSI 5, you can route the trip commands and the close command for the circuit breaker to any binary outputs independently of one another. Follow the procedure described in the following steps to change the routings.

- ✧ In the **Signals** column, open the groups **Circuit breaker 1** and **Circuit break.** one after the other.
- ✧ In the list box for display profiles, select the **Device I/O** profile.

Columns that do not belong to this display profile are hidden.

- ✧ Hide the **Source** column block.

You have now reached the following point:

		Binary output									
		Base module						Expansion			
Signals	Type	1.1	1.2	1.3	1.4	1.5	1.6	2.1	2.2	3.1	3.2
(All...)											
▼ Circuit break.		*	*	*	*						
▶ Ready	SPS										
▶ Acquisition blocking	SPS										
▶ Reset switch statist.	SPS										
▶ External health	ENS										
▶ Health	ENS										
▶ Position 3-pole	DPC										
▶ Position 1-pole phsA	DPC										
▶ Position 1-pole phsB	DPC										
▶ Position 1-pole phsC	DPC										
▶ Trip/open cmd. 3-pole	SPS		U	U	U						
▶ Trip only pole A	SPS	X									
▶ Trip only pole B	SPS		X								
▶ Trip only pole C	SPS			X							
▶ Close command	SPS					X					
▶ Command active	SPS										
▶ Definitive trip	SPS										

[sc_matran_1, en_US]

Figure 2-57 In-Between Result: Adapted View

- ✧ Remove the **Phase C** trip command and close command routings. To do so, highlight the cells shown in the following figure.

▶ Trip only pole B	SPS			X							
▶ Trip only pole C	SPS				X						
▶ Close command	SPS					X					
▶ Command active	SPS						X				

[sc_matran_02, 1, en_US]

Figure 2-58 Highlighted Lines

- ✧ Right-click the highlighted region.
- ✧ Click **Delete** in the context menu.

The routings are removed from the highlighted region.

- ✧ Right-click the shared cell for the **Phase C** trip command and binary output **1.6**.
- ✧ Click **x (Routed)** in the context menu.

Signals	Type	Binary output														
		Base module						Expansion module 3								
(All...)		1.1	1.2	1.3	1.4	1.5	1.6	2.1	2.2	3.1	3.2	3.3	3.4	3.5		
▼ Circuit break.		*	*	*												
▶ >Ready	SPS															
▶ >Acquisition blocking	SPS															
▶ >Reset switch statist.	SPS															
▶ External health	ENS															
▶ Health	ENS															
▶ Position 3-pole	DPC															
▶ Position 1-pole phsA	DPC															
▶ Position 1-pole phsB	DPC															
▶ Position 1-pole phsC	DPC															
▶ Trip/open cmd. 3-pole	SPS	U	U	U												
▶ Trip only pole A	SPS	X														
▶ Trip only pole B	SPS		X													
▶ Trip only pole C	SPS															
▶ Close command	SPS															
▶ Command active	SPS															
▶ Definitive trip	SPS															
▶ Alarm suppression	SPS															
▶ Op.ct.	INS															
▶ Op.ct. A	INS															
▶ Op.ct. B	INS															
▶ Op.ct. C	INS															
▶ ΣI Brk.	BCR															
▶ ΣIA Brk.	BCR															
▶ ΣIB Brk.	BCR															
▶ ΣIC Brk.	BCR															
▶ Break-current phs A	MV															

[sc: matran_03_1_en_US]

Figure 2-59 Routing Information

An x is entered into the cell.

- ✦ Repeat this procedure for the shared cell for the close command and binary output 2.2.
- ✦ Repeat this procedure also for the shared cell for the the phase C trip command and binary output 1.6. Click **U (unlatched)** in the context menu.

You have thus achieved the goal.

Routing the Function Key and Indication to User-Defined Log 1

- ✦ In the list box for display profiles, select the **Configuration of menu levels** profile. Columns that do not belong to this display profile are hidden.
- ✦ In the **Signals** column, open the groups **Main menu** and **Indications** one after the other.
- ✦ Right-click in the shared cell for user-defined log 1 and function key 4.
- ✦ Click **x (Routed)** in the context menu.

An x is entered into the cell. You have now reached the following point:

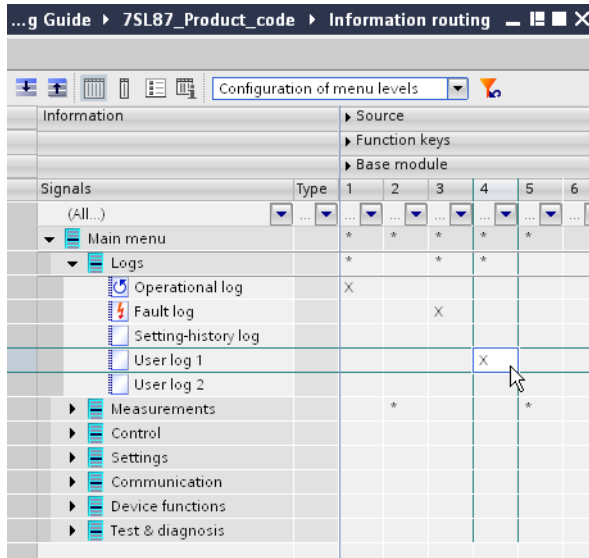

[sc_matran_05, 1, en_US]

Figure 2-60 In-Between Result: Routed Information

- ✧ In the list box for display profiles, select the **All Entries** profile.
- All information, sources, and destinations are shown.
- ✧ Hide the **Source**, **Binary Output**, and **LEDs** column blocks.
- ✧ In the **Signals** column, open the groups **Line 1** and **Group indication** one after the other.
- ✧ Right-click the shared cell for the **Pickup** indication and user-defined log 1.
- ✧ Click **x (Routed)** in the context menu.

An **x** is entered into the cell.

You have thus achieved the goal.

2.7 Creating a CFC

2.7.1 Overview

CFC stands for **Continuous Function Chart**. With a CFC, you can configure additional functions for the SIPROTEC 5 device.

These functions take care of, for example, the following tasks:

- Interlockings
- Formation of group indications
- Failure indications
- Derivation of new dimensions from measured and metered values

Function-Block Diagram

You can always create CFC functions within a Continuous Function Chart. Such a CFC can consist of a number of sheets. The sheet size is also variable. You can also distribute CFC functions as subfunctions over multiple CFCs and interconnect them with logical connections.

A Continuous Function Chart (CFC) always belongs to one particular SIPROTEC 5 device. Therefore, the Continuous Function Charts of a SIPROTEC 5 device are always saved within the project structure in the offline configuration of the SIPROTEC 5 device. Here, you can find the **Continuous Function Chart** folder. All function charts are saved in this folder.

Function Blocks

For the configuration of a Continuous Function Chart, you use predefined function blocks. These comply with IEC 61131-3. For this, you can access various block types that are grouped in the Global DIGSI 5 library. You can add the necessary building blocks from the block library into the function chart via drag and drop. Then interconnect the block connectors to a complete function (also using drag and drop). This eliminates the need for programming and reduces the frequency of errors.

Connectors or Sheet Bars

In order to create the connection to the process or also to other CFC functions, you can use either so-called connectors or sheet bars. Through these 2 elements, you can interconnect building blocks with signals from the signal catalog. On the one hand, signals serve as incoming information for the CFC function. On the other hand, signals act as output information that is created as the result of a CFC function.

All Information is Available

All information that is listed in the **Information-routing** matrix is automatically at your disposal in the CFC Editor. Preliminary routing to the CFC (as in DIGSI 4) is not required. Routings in the CFC column in the **Information-routing** matrix indicate if information from the CFC is used. This is indicated as soon as you connect information with a function block.

Automatic Data Conversion

The function blocks process different data types depending on the block type. If you wish to connect 2 block connectors with different data types, there is an automatic test to see if a type conversion is possible. If that is the case, you can directly connect both connectors with each other. You do not have to add a conversion block. The data types are automatically converted during the translation of the CFC.

When connecting, green markings show that a conversion is possible. If a data type cannot be converted into a different type, you also cannot connect the corresponding connectors.

Continuous Function Chart (CFC) Editor

You edit the Continuous Function Charts with the CFC Editor. The CFC Editor contains the 2 tabs **Data Flow** and **Control Flow**:

- **Data Flow** tab

This tab is used to configure the CFC function as a graphic function chart. To do so, add the building blocks from the Global DIGSI 5 library in the CFC. Then, set parameters for the building blocks and then interconnect them. Use the signals from the signal catalog to establish the connection to the process or to internal functions.

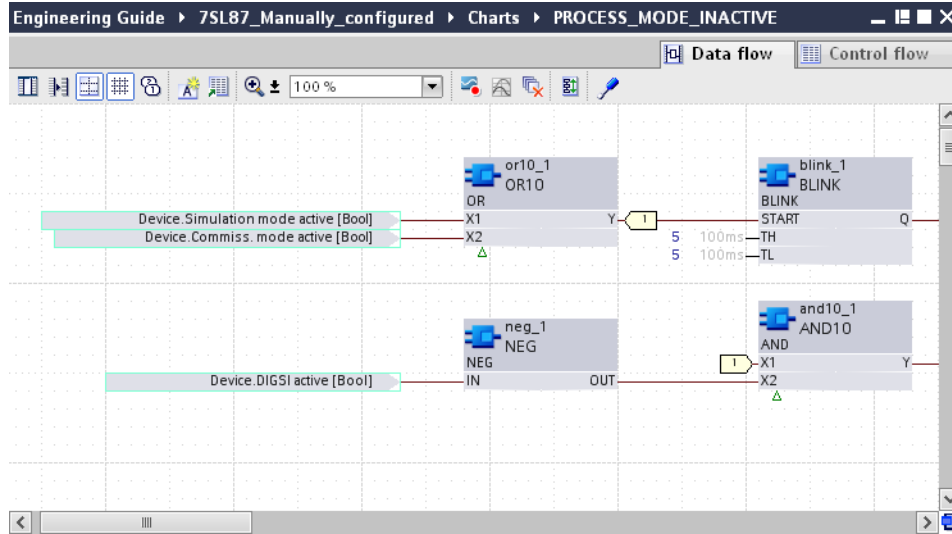

[sc_cfc_dat, 1, en_US]
 Figure 2-61 Data Flow Tab

- **Control Flow** tab

This tab is used to configure the CFC function as text. In the control flow, operands with a fixed syntax designate the interconnections between the building blocks.

The screenshot shows the 'Control flow' tab of the CFC Editor. It displays a table with the following data:

Run seq...	Object/parameter	Operand
1	OR10	or10_1
2	X1	:= Device.Simulation mode active [Bool]
3	X2	:= Device.Commiss. mode active [Bool]
4	Y	⇒ 0
5	NEG	neg_1
6	IN	:= Device.DIGSI active [Bool]
7	OUT	⇒ 0
8	BLINK	blink_1
9	START	:= or10_1.Y
10	TH	:= 5
11	TL	:= 5
12	Q	⇒ 0
13		→ Device.Process mode inactive [Bool]
14	AND10	and10_1
15	X1	:= or10_1.Y
16	X2	:= neg_1.OUT
17	Y	⇒ 0

[sc_cfc_kon, 1, en_US]
 Figure 2-62 Control Flow Tab

2.7.2 Adding a New Continuous Function Chart

The Continuous Function Chart is the container for CFC functions. A CFC is always needed, even if the function consists of only one function block.

If you add a new CFC to the offline configuration of a SIPROTEC 5 device, you must establish the process level for this CFC. A CFC, and the CFC functions contained therein, run in the SIPROTEC 5 device on exactly one of the 4 process levels. The individual process levels differ in how they treat the tasks transferred to them. On the one hand, the SIPROTEC 5 device processes tasks with different priorities depending on the process level selected. On the other hand, the cause of the processing can be cyclic or event-controlled. You can learn more about process levels in the DIGSI 5 Help in the **Continuous Function Charts > Process model** section.

Goal

The goal of this chapter is to create a new, empty CFC in the **7SL87_Manually_configured** offline configuration.

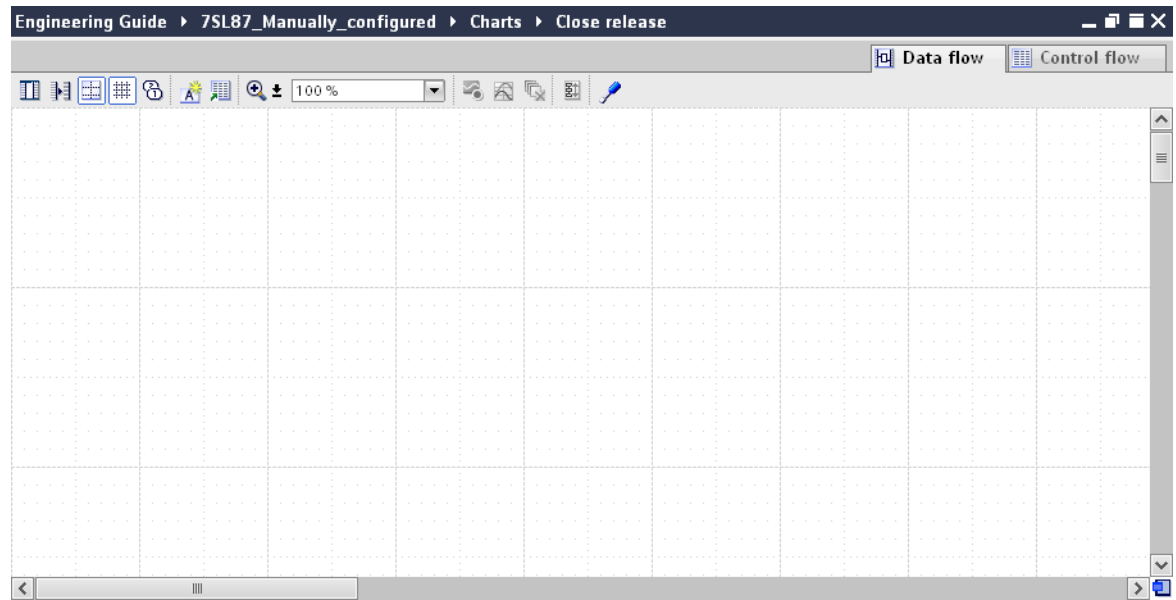

Figure 2-63 Newly Added, Empty Chart

Overview of the Procedure

Perform the following actions:

- Add a new CFC in the **7SL87_Manually_configured** offline configuration.
- While doing so, specify a name and process level for the CFC.

Adding a New Function Chart

- ✧ In the project tree, open the offline configuration **7SL87_Manually_configured**.
- ✧ Open the **CFCs** folder.
- ✧ In this folder, double-click **Add new chart**.

The **Add new chart** dialog opens.

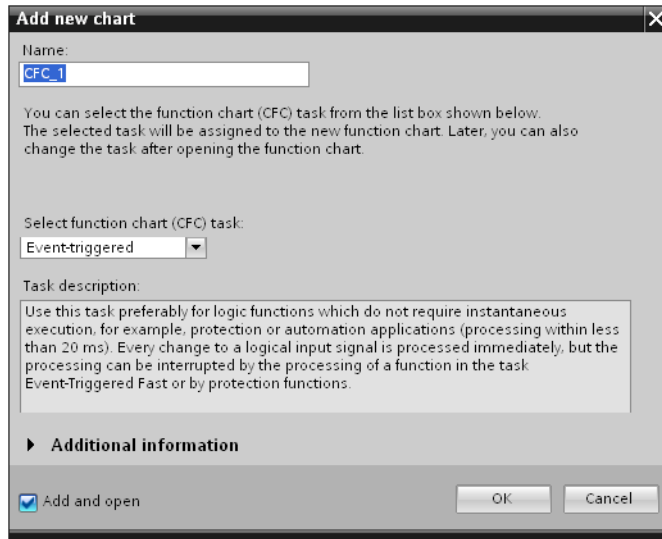

[sc_cfc_dlg_1_en_US]

Figure 2-64 Inserting a New CFC Chart

- ✧ The **Name** text box contains a continually numbered standard name for the Continuous Function Chart. Enter the **Switching release** name.
- ✧ In the **Select function chart (CFC) task** list box, select the **Event-triggered** process level.
- ✧ Ensure that the **Add and open** check box is marked.
- ✧ Click **OK**.

The new CFC is created. The CFC name is added within the **CFCs** folder. The CFC Editor opens in the working area and the new, empty CFC is displayed.

- ✧ In the toolbar of the **Data Flow** tab, click the  button.

The grid appears.

You have thus achieved the goal.

2.7.3 Adding and Interconnecting the Function Block

The new CFC does not yet contain any function blocks. An empty space is shown in the working area instead. This chapter describes how to add a function block from the Global DIGSI 5 library into the new CFC and how to interconnect with signals from the signal catalog.

Goal

The goal of this chapter is to create a function that does not allow the circuit breaker to close until the disconnector is closed and the grounding switch is opened.

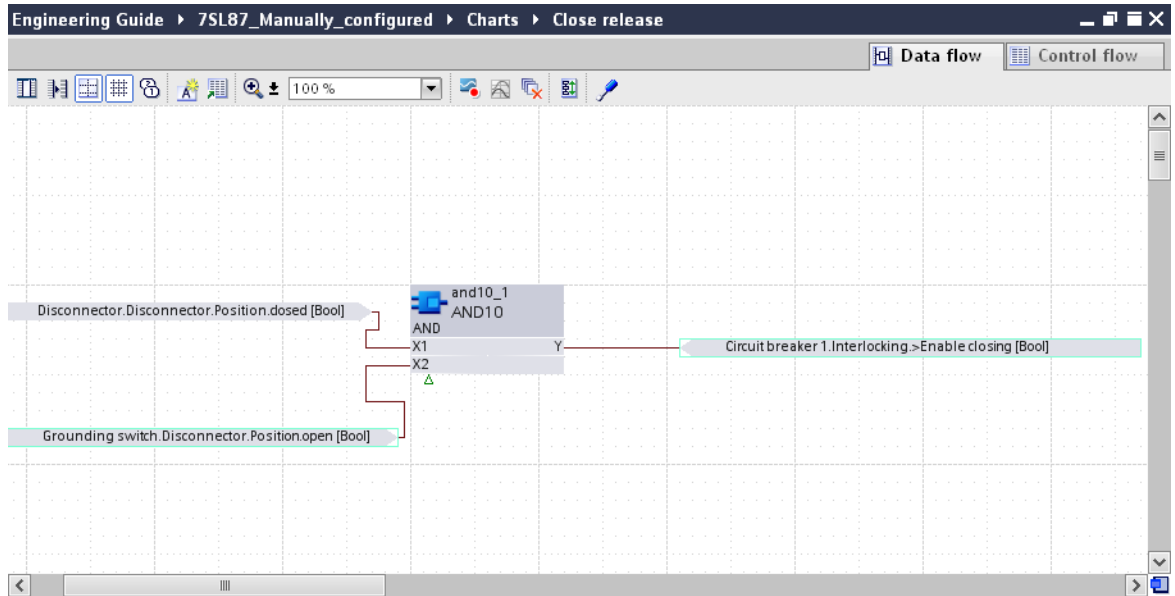

[sc_plafer_02_1_en_US]

Figure 2-65 Completely Configured Chart

The function consists of a single function block of the type **AND**. The inputs of the function block are interconnected with signals containing the position information of the disconnector and the grounding switch. The output of the function block is interconnected with the **>Enable Closing** signal.

Overview of the Procedure

Perform the following actions:

- Add the required function block from the Global DIGSI 5 library into the CFC.
- Interconnect the function block with the necessary signals from the signal catalog.

Adding a Function Block to the Chart

- ◇ In the task card, select the **Libraries** tab.
- ◇ In the Global DIGSI 5 library, open the **Types** and **Continuous Function Chart (CFC) Blocks** folders one after the other.

The folders of all block categories are displayed.

- ◇ Open the **Logic** folder.
- ◇ Highlight the **AND** building block in this folder.

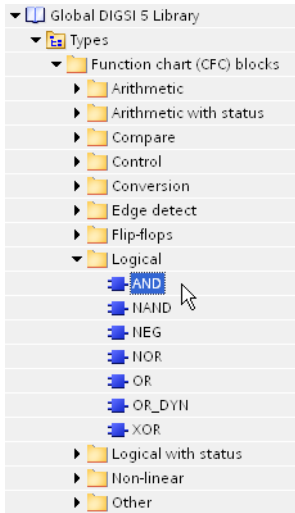

[sc_bstmar_1_en_US]
Figure 2-66 AND Building Block Highlighted in the Global DIGSI 5 Library

- ✧ Hold down the mouse button and drag the building block to the desired insertion position in the **Data Flow** tab.
- ✧ Release the mouse button.

The building block is placed at the selected position.
You have now reached the following point:

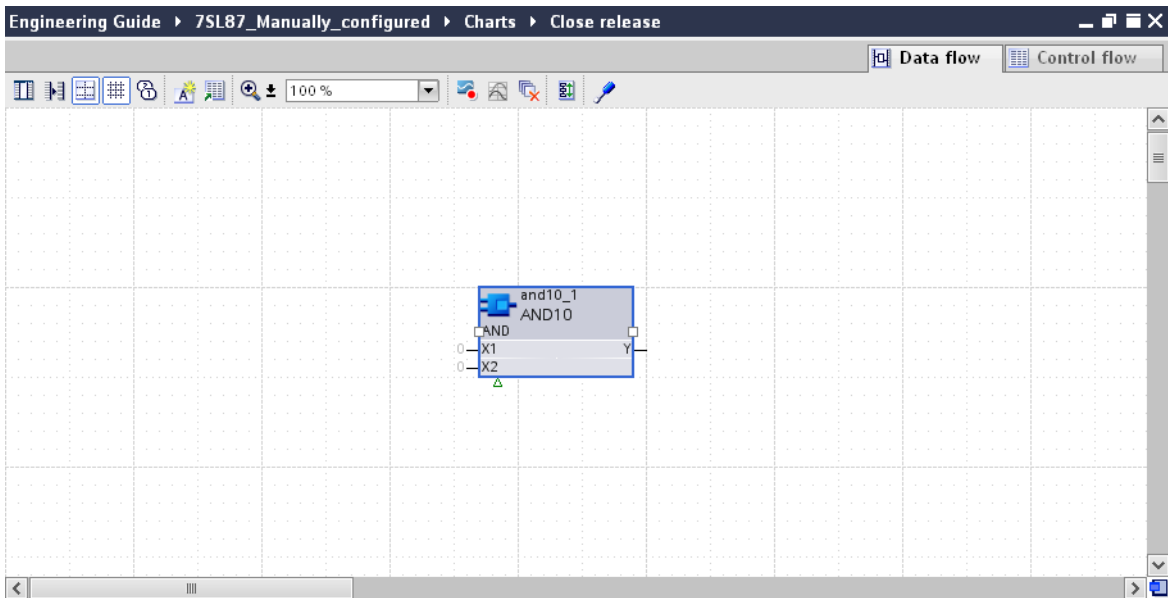

[sc_plaand_02_1_en_US]
Figure 2-67 In-Between Result: Continuous Function Chart with AND Building Block

Interconnecting Function Block with Signals

The connection to the necessary signals is established via the sheet bars or the connectors. In DIGSI 5, preset standard connectors are used. If you would prefer to use sheet bars (as in DIGSI 4), these can be displayed.

To do so, use the  button in the toolbar of the **Data Flow** tab.

- ✧ In the task card, select the **Signals** tab.

The signal catalog is displayed.

- ✧ In the the **Select Device** list box, select the **7SL87_Manually_configured** offline configuration.

The signals from the selected offline configuration are displayed in the signal catalog. The signals are structured hierarchically in different groups. You can open and close individual groups. To do so, simply click the arrows to the left of the group names as in the Global DIGSI 5 library.

- ✧ In the signal catalog, open the **Disconnecter** and **Disconnecter** groups one after the other.

The signals in the **Disconnecter** group are displayed. The **Position** signal, relevant to the switching release, consists of several individual signals.

- ✧ Click the arrow to the left of the **Position** signal name.

The individual signals are displayed.

- ✧ Highlight the **closed** signal.

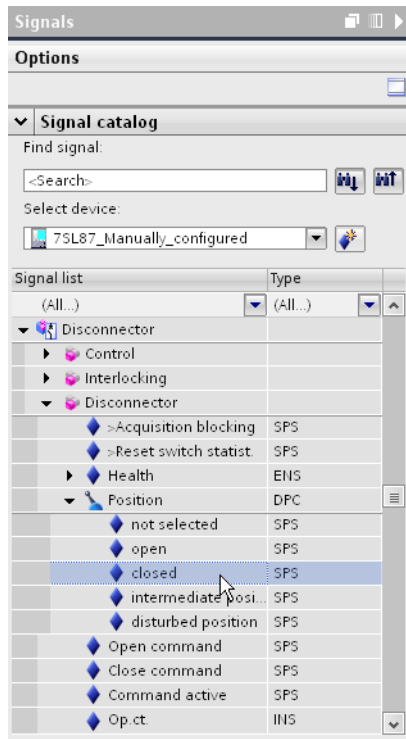

[sc_sigkat, 1, en_US]

Figure 2-68 Closed Signal Highlighted in the Signal Catalog

- ✧ Hold down the mouse button and drag the signal into the CFC, placing it on the **X1** input of the **AND** function block.

Once the proper position is reached, a colored square marks the input.

- ✧ Release the mouse button.

The signal is interconnected with the input. A connector with the signal name displays the interconnection. You have now reached the following point:

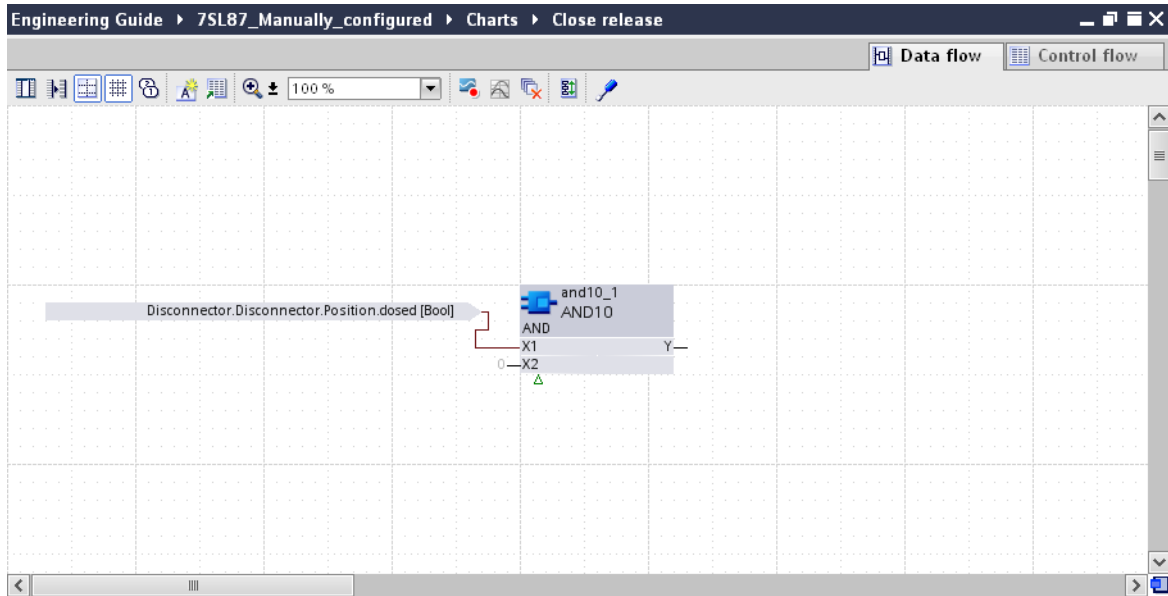

[sc_plasig_02_1_en_US]

Figure 2-69 In-Between Result: CFC with Interconnected Signal

- ✧ Using the same procedure, connect the **open** position signal of the grounding switch with the **X2** input of the **AND** function block.
- ✧ Now connect the output of the **AND** function block with the **>Enable closing** signal. To do so, open the **Circuit breaker 1** and **Interlocking** groups one after the other in the signal structure.

The signals in the **Interlocking** group are displayed.

- ✧ Highlight the **>Enable Closing** signal.

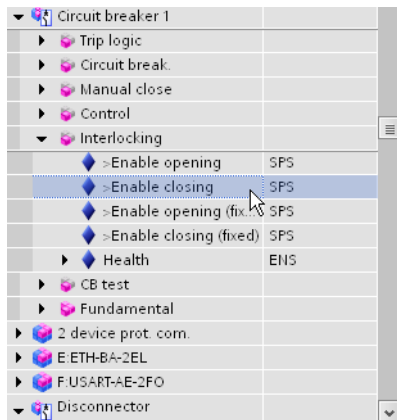

[sc_sigkat_02_1_en_US]

Figure 2-70 >Enable Closing Signal Highlighted in the Signal Catalog

- ✧ Hold down the mouse button and drag the signal into the CFC, placing it on the **Y** output of the **AND** function block.

Once the proper position is reached, a colored square marks the output.

- ✧ Release the mouse button.

The signal is interconnected with the output. A connector with the signal name displays the interconnection.

- ✧ Save the project.

You have thus achieved the goal.

2.8 Creating a Display Page

2.8.1 Overview

The SIPROTEC 5 module is flexible regarding selection of the on-site operation panel. You can order any device type with a large, graphic display or with a smaller standard display. For applications without device operation, an on-site operation panel without display is also available. The on-site operation panel with small display has 7 lines for signals such as measured values or text. The on-site operation panel with large display provides additional space for static and dynamic graphics.

Display Pages

The set of all information displayed at a moment is called a display page. Using the Display Editor, you can configure up to 10 different display pages for each SIPROTEC 5 device and load them into the SIPROTEC 5 device. In the SIPROTEC 5 device, you can switch between the available display pages using forward and back keys. You can define 1 of the display pages as the default page. This default page is shown in the display when the SIPROTEC 5 device is first switched on or restarted.

Display pages are always device-specific. The display pages for a SIPROTEC 5 device are thus part of the offline configuration of this device.

Options

When you add a new display page to the offline configuration, this page does not yet contain any elements. Instead, an empty space is shown in the working area of the Display Editor. In this area, you use drag and drop to insert busbars, disconnectors, circuit breakers, and other equipment from the Global DIGSI 5 library. You then connect the elements with lines.

Alternatively, you can create a display page for a bay selected in the single-line configuration.

You can add text to the graphical representation and connect dynamic graphic elements with process information. In this way, you can visualize the states of equipment items, for example, the position of a circuit breaker, on the display page. In addition, you can insert placeholders for signal values on the display page. During operation, these placeholders display the values and are updated regularly.

Icons for Various Standards

All icons for display pages can be displayed according to the 2 standards **ANSI** or **IEC**. If you insert an element from the library, the element symbol is shown in the currently set standard **ANSI** or **IEC**. You can switch between these 2 standards at any time.

You can learn how to switch between these standards in the chapter [2.3.2 Displaying Icons According to ANSI or IEC](#).

The following 2 figures illustrate the different representation of the icons.

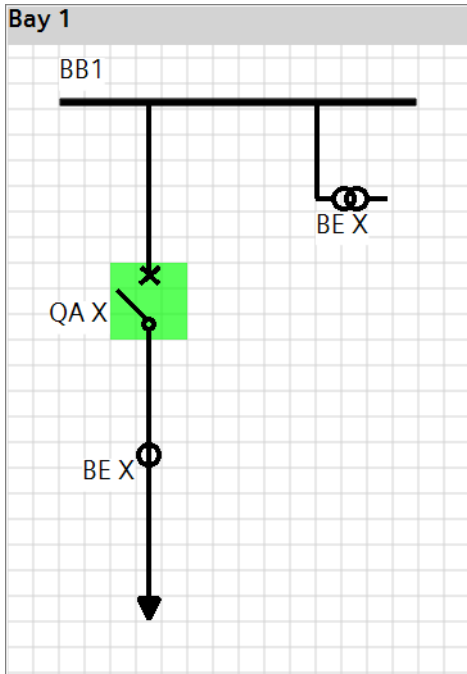

[sc_disiec, 1, en_US]
Figure 2-71 IEC Representation

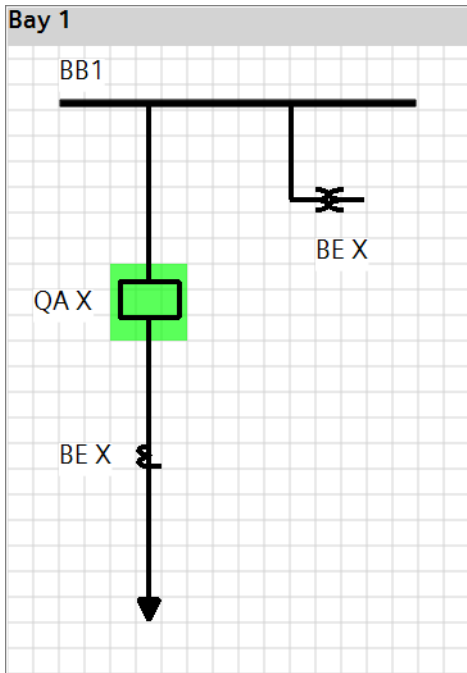

[sc_disans, 1, en_US]
Figure 2-72 ANSI Representation

If you select the other standard, the icons on the display pages do not change. This enables you to create display pages for 2 different standards.

Display Editor

The Display Editor is used to generate the display pages for a SIPROTEC 5 device. The Display Editor consists of a working area and a toolbar for specific actions. To create a display page, you also need the Global DIGSI 5 library and the signal catalog.

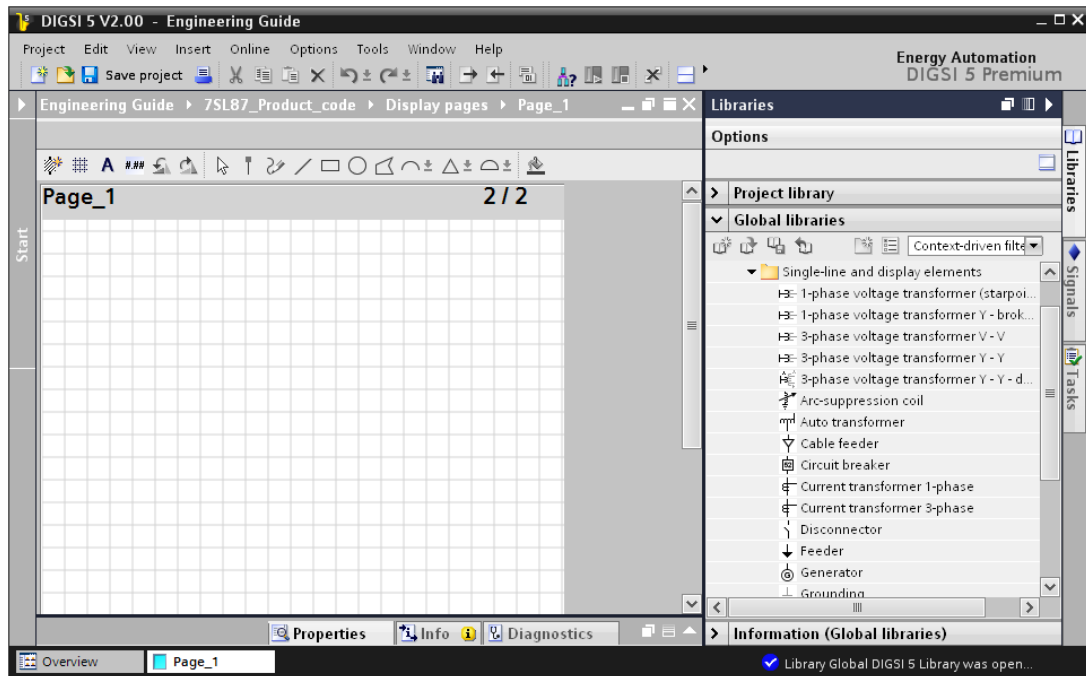

[sc_dised], 1, en_US]

Figure 2-73 Display Editor and Global DIGSI 5 Library

2.8.2 Creating a New Display Page

A new display page does not yet contain any elements. An empty space is shown in the working area instead. This chapter describes how you create a feeder on the display page using individual elements selected from the Global DIGSI 5 library.

Goal

The goal of this chapter is to create the display page shown in the following figure.

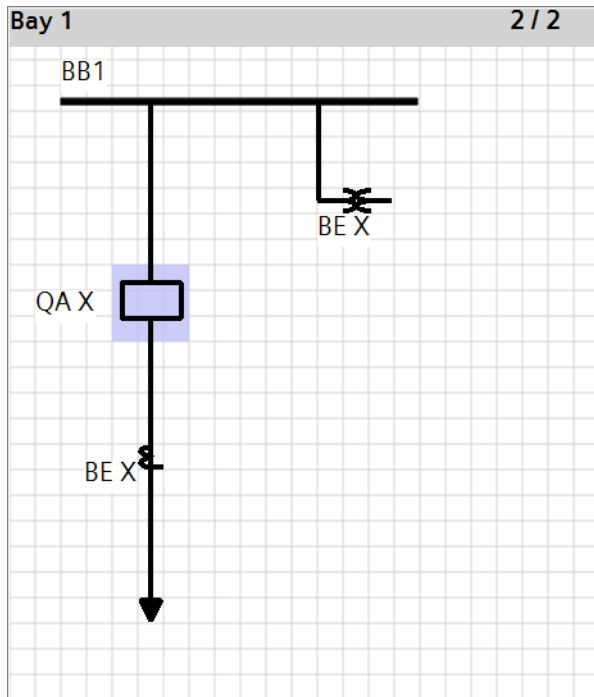

[sc_disse_04, 1, en_US]

Figure 2-74 Completed Display Page

The display page contains one each of the following elements:

- Busbar
- Circuit breaker
- Current transformer
- Voltage transformer
- Feeder

In addition, the display page contains the static text **BB1**.

Overview of the Procedure

Perform the following actions:

- Add a new display page and rename it.
- Insert a busbar into the display page.
- Insert additional equipment into the display page.
- Connect the individual elements with one another.
- Insert the static text into the display page.

Adding a New Display Page and Renaming It

You can create up to 10 display pages in DIGSI 5 for each SIPROTEC 5 device. A consecutively numbered default name that you can change is assigned to each display page that is added.

- ✧ In the project tree, open the offline configuration **7SL87_Product Code**.
- ✧ In the **Display Pages** folder of this offline configuration, double-click **Add New Display Page**.

A new, empty display page is added and shown in the working area.

- ✧ Select the current name in the header of the display page.
- ✧ Assign **Bay 1** as the new name.

- ✧ Click another area of the display page.
- The new name for the display page is applied.
- ✧ Right-click the empty working area.
 - ✧ Click **Insert elements from library** in the context menu.

On the **Libraries** tab in the task card, the **Single Line and Display Elements** directory opens.

Inserting the Busbar

The Global DIGSI 5 library contains one element each for a vertical and a horizontal busbar. After insertion, you can modify the length of the busbar.

- ✧ Highlight the element **Horizontal busbar** in the Global DIGSI 5 library.
- ✧ Drag the element to the desired insertion position in the still empty working area.
- ✧ Release the mouse button.

The busbar is placed at the selected position.

- ✧ Click the end point of the busbar and hold the mouse button down.
- ✧ Hold the mouse button down and move the mouse pointer a few quadrants to the right.
- ✧ Release the mouse button.

The busbar is extended.

You have now reached the following point:

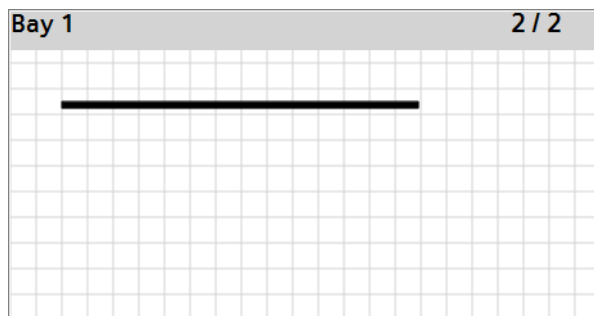

[sc_disse1, 1, en_US]

Figure 2-75 In-Between Result: Display Page with Added Busbar

Adding Additional Equipment

You insert additional equipment from the Global DIGSI 5 library into the display page via drag and drop in the same way as the busbar.

- ✧ Highlight the element **Circuit breaker** in the Global DIGSI 5 library.
- ✧ Hold down the right mouse button and drag the element into the working area, positioning it below the busbar.
- ✧ Release the mouse button.

The circuit breaker is now placed at the insertion position.

- ✧ Repeat this procedure for the elements **3-phase current transformer, feeder, and Y-Y voltage transformer**. Position the elements as shown in the figure in the **Goal** section.

You have now reached the following point:

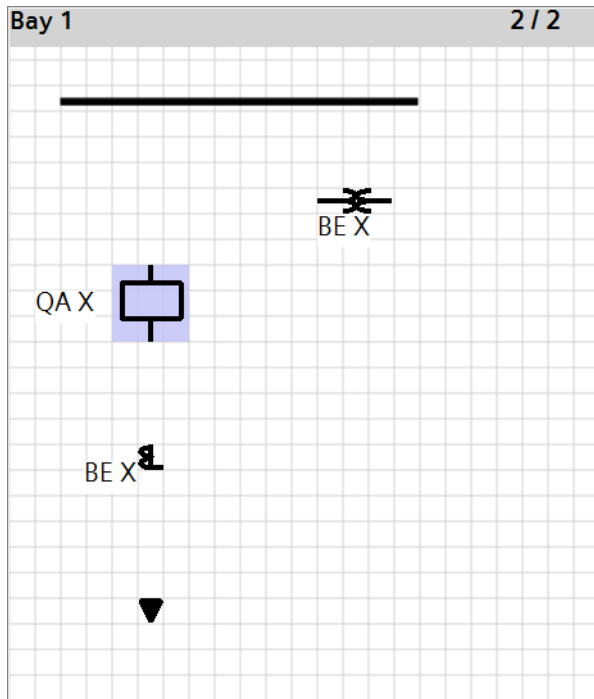

[sc_dissej_02_1_en_US]

Figure 2-76 In-Between Result: Display Page with Additional Equipment

Connecting Elements

You must connect the individual elements by lines manually.

- ✧ Position the mouse pointer on the upper connection point of the element **circuit breaker**. This connection point marks the start of the line.

The mouse pointer is in the correct position when it changes to a hand.

- ✧ Press the mouse button and drag directly upward to the busbar. This connection point marks the end of the line.

A colored frame highlights the busbar as soon as you come close to it.

- ✧ Release the mouse button.

A vertical line connects the element **circuit breaker** with the busbar.

- ✧ Repeat this procedure for all additional elements.

You have now reached the following point:

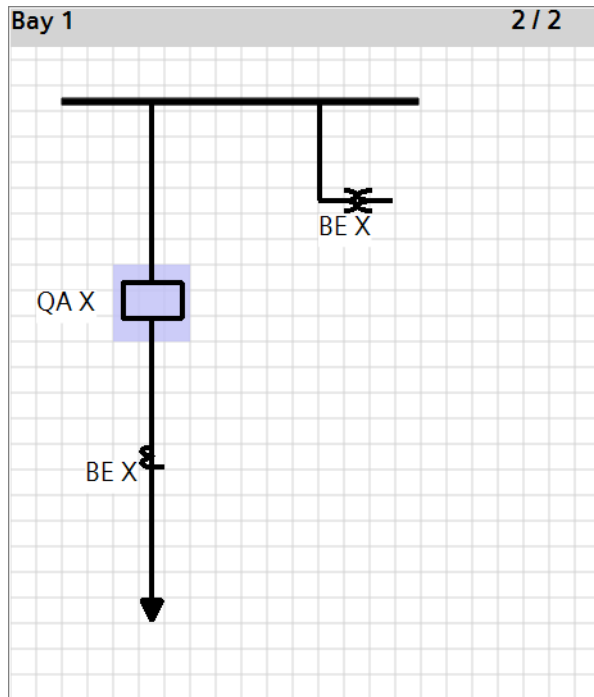

[sc_disse1_03_1_en_US]

Figure 2-77 In-Between Result: Display Page with Connected Elements

Inserting Static Text into the Display Page

A display page can contain static text. Static text is information that you can add to the display page. This type of information is independent of influences. It is added by creating a text box and entering the text information in this box.

- ✦ Right-click an unoccupied spot on the display page.
- ✦ Click **Add Text** in the context menu.

The mouse pointer changes to a text input icon.

- ✦ Click in the area above the busbar on the display page.

A text box is inserted into the display page.

- ✦ Double-click in this text box and enter the text **BB1**.
- ✦ Click outside of the text box.

The text entered is applied on the display page.

You have thus achieved the goal.

2.8.3 Adding Signals to the Display Page

You can add signals to the display page and in this way create a dynamic value display and a dynamic position display.

- **Dynamic value display**

SIPROTEC 5 devices can dynamically show signals such as measured values, metered values, binary values on the display. The SIPROTEC 5 device therefore cyclically updates these values. In DIGSI 5, you must insert the signals whose values you want to be displayed into the display page.

With the dynamic value display, you can implement direct visual assignment of equipment and process information on the display page. For example, you can place a current value next to the symbol of the associated current transformer on the display page. You can also display the number of decimal places and the unit for the values of analog signals. For binary signals, values preset by the system are displayed in accordance with the state of the signal, for example, **On** or **Off**.

- **Dynamic position display**

You can connect a graphical element having 2 or 4 states to a signal from the signal catalog. In this way, you can control the states of the graphical element on the display of the SIPROTEC 5 device in accordance with the state of the signal.

For example, you can connect the graphical element for a circuit breaker to the **Position** signal of the corresponding circuit breaker. If the circuit breaker is closed, the display on the unit shows the closed circuit-breaker symbol. If the circuit breaker is open, the display on the unit shows the open circuit-breaker symbol. This also applies to the intermediate and disturbed position of the circuit breaker.

Goal

The goal of this chapter is to create the display page shown in the following figure.

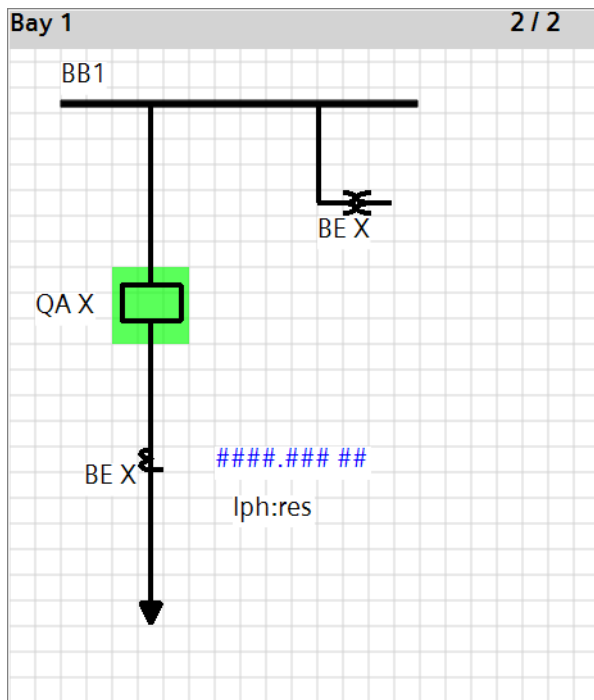

[sc_dissei_06_1_en_US]

Figure 2-78 Display Page with Added and Connected Signals

The display page contains the following connected signals:

- The measured value **Iph: Sum** is added to the display page together with the text **I-Phase Sum**.
- The element **circuit breaker** is connected to the signal **Command with feedback**.

Overview of the Procedure

Perform the following actions:

- Open the signal catalog and select **7SL87_Product Code** in the offline configuration.
- Insert the measured value **Iph: Sum** in the display page and add the text.
- Connect the element **circuit breaker** to the signal **Command with feedback**.

Opening the Signal Catalog and Selecting the Offline Configuration

✧ In the task card, select the **Signals** tab.

The signal catalog is displayed.

✧ In the **Select Device** list box, select the offline configuration **7SL87_Product Code**.

The signals from the selected offline configuration are displayed in the signal catalog. The signals are structured hierarchically in different groups. You can open and close individual groups. To do so, simply click the arrows on the left of the group names as in the Global DIGSI 5 library.

Adding a Signal for Dynamic Value Display

✧ In the signal catalog, open the groups **Line 1** and **Operational measured values** in succession.

The signals in the **Operational measured values** group are displayed.

✧ Click the arrow on the left of the signal name **Iph**.

The individual signals contained therein are displayed.

✧ Highlight the signal **Iph: Sum**.

Line 1	
General	
Fault locator	
Mes.v.fail.sup	
Process monitor	
Operational values	
Behavior	ENS
Health	ENS
f	MV
Vph	WYE
Vpp	DEL
VH	MV
Iph	WYE
Iph.A	CMV
Iph.B	CMV
Iph.C	CMV
Iph.res	CMV
IIN	MV
P tot	MV
Q tot	MV

[sc_sigiph, 1, en_US]

Figure 2-79 Iph:Sum Signal Highlighted in the Signal Catalog

- ✧ Hold down the mouse button and drag the signal to the display page, positioning it to the right of the current transformer.
- ✧ Release the mouse button.

The signal is connected with the display page and appears as blue rhombuses.

You have now reached the following point:

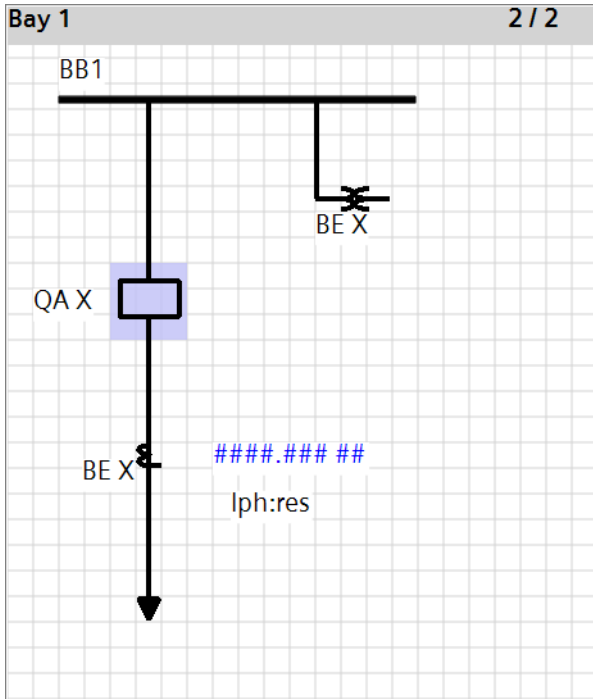

[sc_disse_05_1, en_US]

Figure 2-80 In-Between Result: Display Page with Added lph:Sum Signal

Connecting the Signal for Dynamic Position Display to an Element

- ✦ In the signal catalog, open the groups **Circuit breaker 1** and **Control** one after the other.
- The signals in the **Control** group are displayed.
- ✦ Highlight the signal **Command with feedback**.

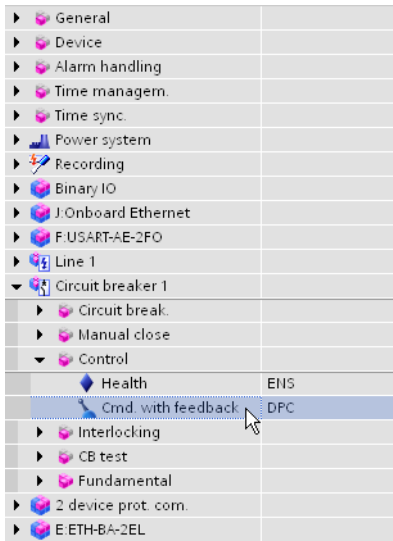

[sc_sigbmr_1, en_US]

Figure 2-81 Command with Feedback Signal Highlighted in the Signal Catalog

- ✦ Drag the signal into the display page, holding the mouse button down.
- All graphical elements that have not yet been connected appear green.
- ✦ Drag the signal to the element **circuit breaker**.
 - ✦ Release the mouse button.

The signal is connected to the element.
You have thus achieved the goal.

2.8.4 Creating the Display Page for a Bay

If you have already created a single-line configuration, you can create a display page for a bay immediately. To do this, the bay must be connected to a SIPROTEC 5 device in the single-line configuration. If at least 1 element of the bay is connected to a busbar, the busbar is also included on the display page.

Goal

The goal of this chapter is to create the display page shown in the following figure.

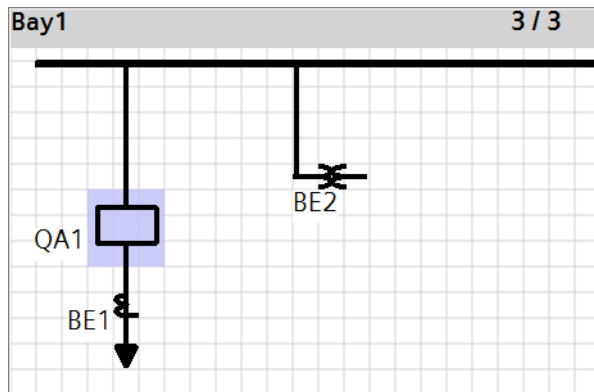

[sc_vomfel, 1, en_US]

Figure 2-82 Display Page Created for a Bay

The display page contains all elements from Bay 1:

- Busbar
- Circuit breaker
- Current transformer
- Voltage transformer
- Feeder

Creating a Display Page for a Bay

- ◇ Show the single-line configuration in the working area.
- ◇ Right-click the colored area for Bay 1 in the single-line configuration.
- ◇ In the context menu, click **Create Display Page for a Bay**.

A new display page is added in the **Display Pages** folder of the offline configuration **7SL87_Product Code** and displayed in the working area. The display page contains the elements and connections of Bay 1 as well as the busbar.

- ◇ Save the project.

You have thus achieved the goal.

2.9 Parameterizing Protection Functions

2.9.1 Overview

The parameters for all protection functions are preset to default values. You can adapt these values to the real circumstances and requirements.

Scope

All protection functions whose parameters and values are part of the offline configuration of a SIPROTEC 5 device and are contained in the **Settings** folder. The protection functions are sorted by function groups. You can find all function groups that appear as the associated device icon in the single-line configuration in the **Settings** folder.

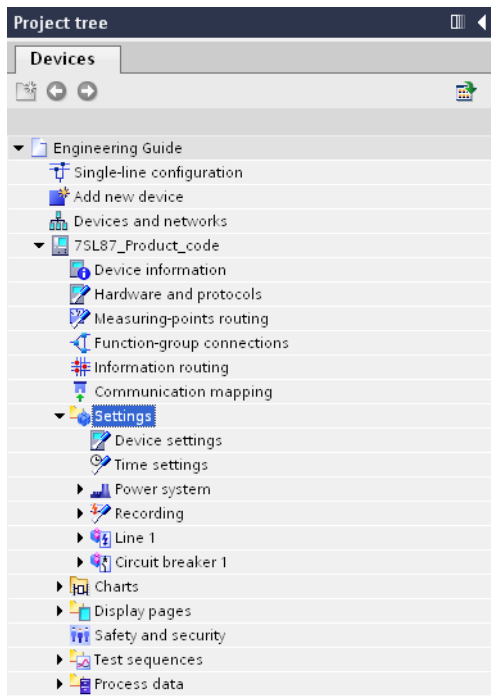

[sc_pnpara, 1, en_US]
Figure 2-83 Project Tree with Open Settings Folder

In addition to the protection functions, the **Settings** folder contains other functions and parameters, for example, for time synchronization or fault recording.

Settings Groups

Different operating cases can require different function settings. To save and use the protection-function settings for different operating cases, you use settings groups. In a settings group, you can set the parameters specifically for an operating case. Transmit the various settings groups into the SIPROTEC 5 device. All SIPROTEC 5 devices support up to 8 independent settings groups. You can determine how many of these are actually used.

During operation, you can switch between settings groups. This is possible in different ways and in different situations:

- The result of a **CFC function** can cause switching between 2 settings groups, for example, the comparison of different criteria.

- A **protection function** can switch dynamically between 2 settings groups, for example, when a motor is starting.
- You can switch between 2 settings groups **manually**, for example, when changing the infeed conditions.

You can learn more about settings groups in the DIGSI 5 Help in the **Applications and Functions > Creating Functions > Using Settings Groups** section.

Editing Options

Parameters, including their values, can be displayed with the aid of either the Settings Editor or in the Inspector window.

- **Settings Editor**

If you select a function in the project tree, the parameters and values associated with the function can be displayed in the working area with the aid of the Settings Editor. You can then switch to the preceding or to the next function in the same function group using the navigation arrows. Functions so far not selected are opened automatically and shown with the Settings Editor.

If the parameters are shown in the Settings Editor, all edit functions for parameters are available for you to use them.

- Selecting a settings group for editing
- Selecting a settings group for comparison of values
- Copying parameters
- Printing parameters
- Exporting and importing parameters
- Displaying parameters of special functions graphically
- Showing and hiding parameter numbers

Editing with the Settings Editor is the preferred variant in this chapter.

- **Inspector window**

If, for example, the single-line configuration or information routing is displayed in the working area, you can use it to select a function. Parameters and values of the function are then displayed as properties in the Inspector window.

If the parameters are displayed as properties, only limited edit functions are available to you. Only the values of the active settings group are displayed, reference values are not shown. You also cannot use copy functions.

Settings Editor

With the Settings Editor, you process the settings of parameters, for example, of protection functions or of the time synchronization. All parameter settings are represented in the same way. Certain functions, for example, for distance protection or tripping, can be visualized graphically. You can display the individual diagrams and characteristics in a graphics window.

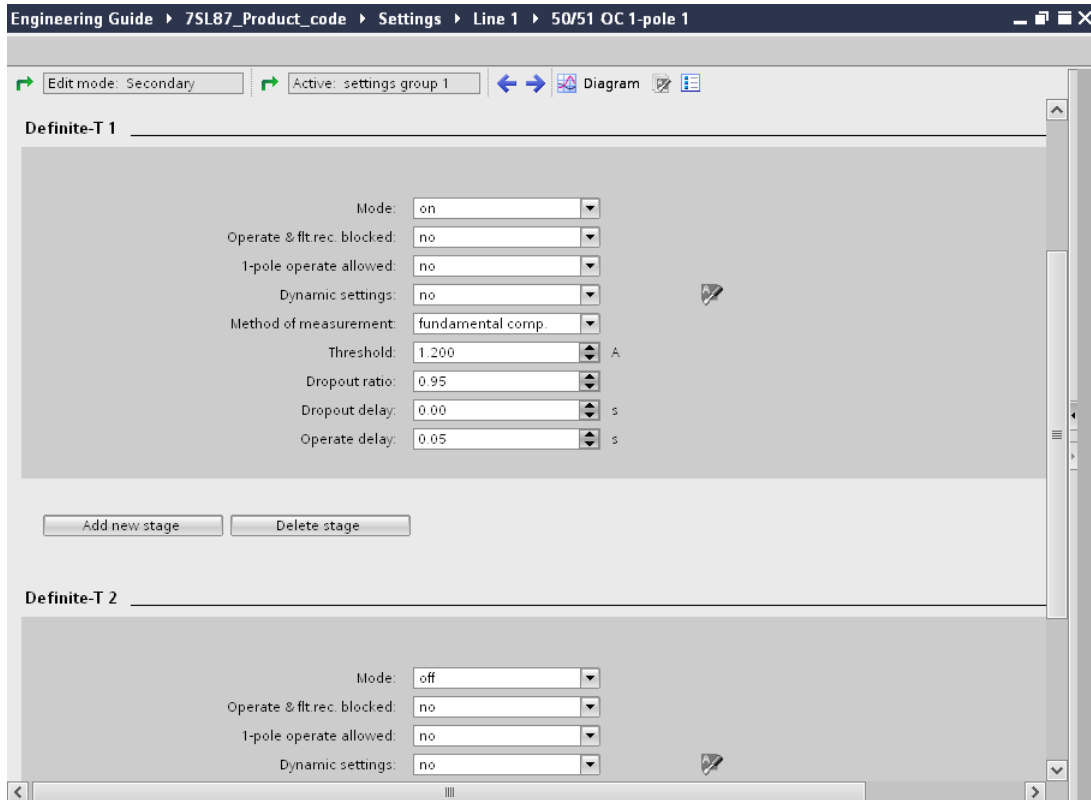

[sc_paredi, 1, en_US]
Figure 2-84 Settings Editor

2.9.2 Selecting the Appropriate Mode

You can enter and display parameter values as primary values, secondary values, or as percentage values. The decision concerning the mode depends on the working environment.

- **Primary values**
For work in a system environment, Siemens recommends using primary values as an input. This eliminates the need for conversion with the transformation ratios. This avoids setting errors.
- **Secondary values**
For tests in the laboratory, Siemens recommends using secondary values as an input. This usually corresponds to the working area for test equipment. This mode is preset after a SIPROTEC 5 device has been added.
- **Percent values**
For input of trigger values, Siemens recommends using percentage values. In this mode, you must standardize the setting values to the rated values.

In DIGSI 5, you must state whether the values entered should be interpreted and displayed as primary, secondary, or percentage values. Select the appropriate mode in the device settings.

Goal

The goal of this chapter is to set the **Secondary values** mode for the offline configuration **7SL87_Product Code**.

Checking the Mode

- ✧ In the project tree, open the offline configuration **7SL87_Product Code**.

- ✧ Open the **Settings** folder in this offline configuration.
- ✧ Double-click **Device settings** in this folder.

In the working area, the Settings Editor is opened and the device settings are displayed.

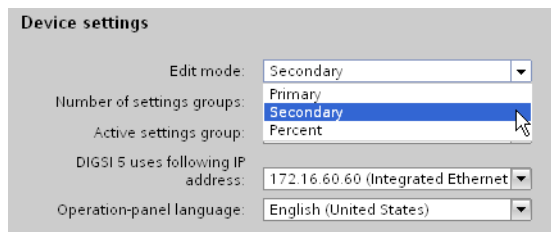

[sc_modusp, 1, en_US]

Figure 2-85 List Box for the Mode

- ✧ Ensure that the mode **Secondary** is selected in the **Edit mode** list box.
- You have thus achieved the goal.

2.9.3 Selecting a Function and Setting Parameters

Parameters can be divided into 2 different categories:

- **Text parameter**
Text parameters can take on only defined values, for example, **on** or **off**.
- **Decimal parameter**
Decimal parameters are defined by a numerical value. For decimal parameters, the value **inactive** is also permissible. Enter this value as the character string **oo** (2 lower-case o).

Goal

The goal of this chapter is to set the following parameters for the **Overcurrent 1pol 1** function in the offline configuration **7SL87_Product Code**:

- Tripping stage **Definite-T1**: Threshold value **1.2 A**
- Tripping stage **Definite-T1**: Tripping delay **50 ms**
- Tripping stage **Definite-T2**: Mode **off**

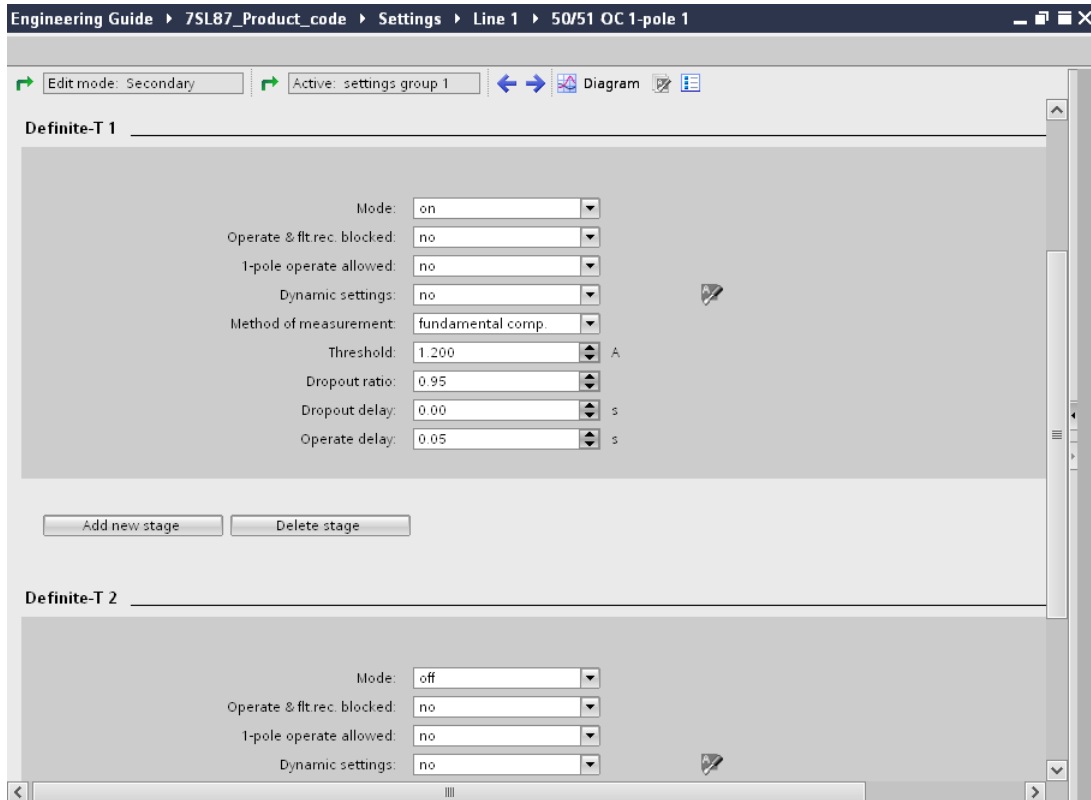

[sc_paredi, 1, en_US]

Figure 2-86 Settings Editor with Changed Function Settings

Overview of the Procedure

Perform the following actions:

- Open the function in the Settings Editor.
- Change the values of the parameters **Threshold Value**, **Tripping Delay**, and **Mode**.

Opening a Function in the Settings Editor

- ✧ In the project tree, open the folder for the offline configuration **7SL87_Product Code**.
- ✧ Open the **Settings** folder in this folder.

The names of all available function groups are listed.

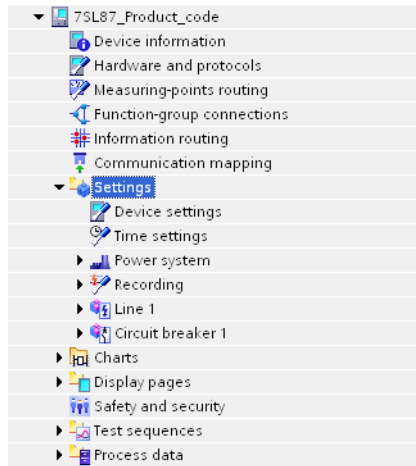

[sc_ordpar, 1, en_US]

Figure 2-87 Project Tree with Open Settings Folder

- ✧ Open the **Line 1** function group.

The names of all functions contained in this function group are displayed.

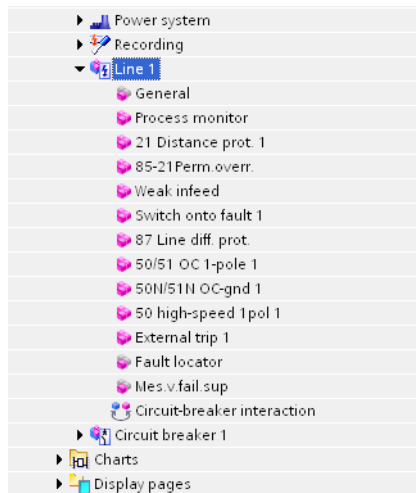

[sc_ordlei, 1, en_US]

Figure 2-88 Project Tree with Opened Line 1 Function Group

- ✧ Double-click the name of the **Overcurrent 1pol 1** function.

The Settings Editor opens in the working area. This shows the parameters and the values of the selected function.

You have now reached the following point:

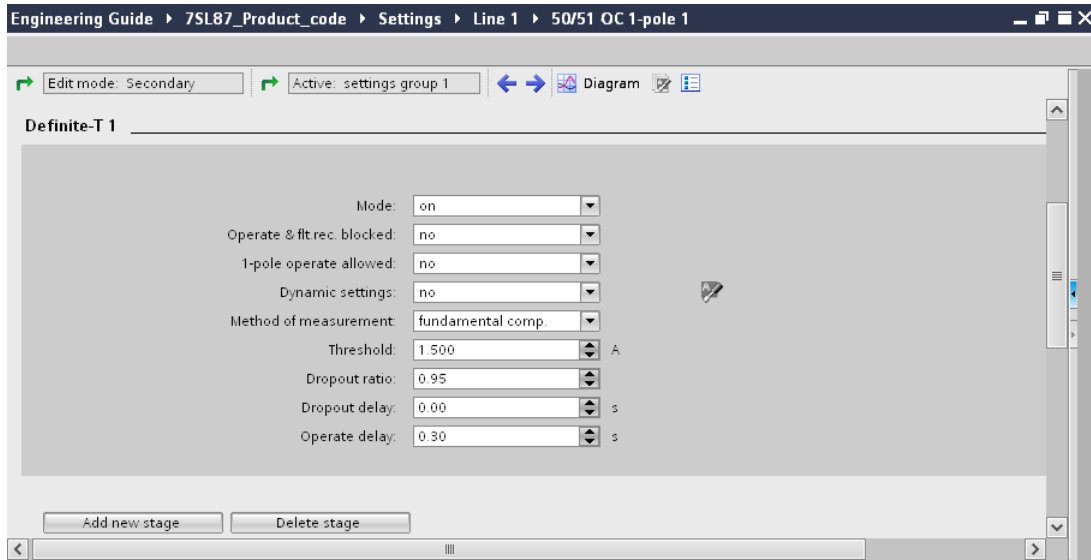

Figure 2-89 In-Between Result: Current Settings of the Overcurrent 1pol 1 Function

Changing Parameter Values

The **Overcurrent 1pol 1** function has the 2 tripping stages **Definite-T1** and **Definite-T2**. Each stage has associated parameters that are grouped visually in a gray-colored area.

- ✧ Reduce the value of the **Threshold** parameter to 1.2 A for the **Definite-T1** stage. To do so, click the arrow keys in the list box until the value is reached. Alternatively, you can enter the value in the text box of the list box.
- ✧ Reduce the value of the **Operate Delay** parameter to 50 ms for the **Definite-T1** stage. Follow the same procedure used for the **Threshold** parameter.
- ✧ Deactivate the Definite-T2 stage. To do so, select the value **off** in the **Mode** list box for the **Definite-T2** stage.

You have thus achieved the goal.

2.9.4 Using the Graphics Function

For setting special protection characteristics, the graphical representation of the characteristics is advantageous. For this reason, certain functions, for example, for distance protection or tripping, can be visualized graphically using the Settings Editor. The graphics include:

- Zone diagrams
- Operate curves

The graphics are displayed in the graphics page of the Settings Editor. The graphics window is anchored on the right-hand side of the Settings Editor. You can hide or show the graphics window. All characteristic variants of the function are represented in the graphics window. Through this, you can graphically check the effects of changes in the settings immediately.

Goal

The goal of this chapter is to open the graphics window for the **Overcurrent-3ph 1** function. Changing parameter values is intended to show the dynamic connection between parameters and the graphical representation.

Showing the Graphics Window and Changing Parameter Values

- ✦ Click the  button in the toolbar of the Settings Editor.

The graphics window is displayed. You have now reached the following point:

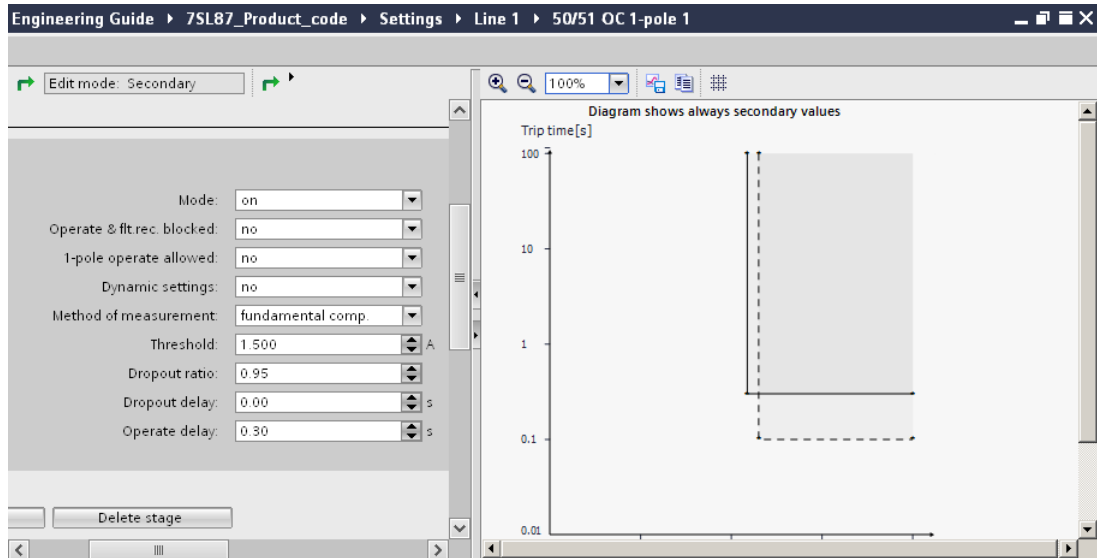

[sc_grafen, 1, en_US]

Figure 2-90 Opened Graphics Window

- ✦ Change, for example, the value of the **Operate Delay** parameter.

The change appears in the graphic immediately.

- ✦ Save the project.

You have thus achieved the goal.

2.10 Configuring Communication

2.10.1 Overview

Plug-in modules for SIPROTEC 5 and fixed communication modules for SIPROTEC 5 Compact provide serial or Ethernet-based system communication. These communication modules are not bound to a definite protocol or communication application. Instead, with DIGSI 5 you can select, configure, and integrate a protocol into the network structure of the substation that satisfies your requirements. Use the Devices & Networks Editor for this.

Serial and Ethernet-Based Communication Modules (SIPROTEC 5)

There are 2 different communication-module types for SIPROTEC 5 devices:

- **Serial communication modules**
You can configure up to 2 communication applications in parallel and independently of one another on a serial communication module. For example, you can transfer data with the IEC 60870-5-103 protocol and use the module simultaneously as an autonomous protection interface.
A protection interface enables data exchange between SIPROTEC 5 devices using synchronous, serial point-to-point connections. You can use such connections for differential protection or transmission of other data, for example. An effective topology consists of 2 to 6 SIPROTEC 5 devices. These exchange indications, measured values, and other protection data including the necessary time synchronization using the protection interface.
- **Ethernet-based communication modules**
Ethernet-based communication modules allow you to integrate a SIPROTEC 5 device as a server in an IEC 61850 system. The SIPROTEC 5 device can transfer its data to up to 6 clients and communicate with other devices using GOOSE.
Even substation automation protocols such as DNP3 or IEC 60870-5-103 can use Ethernet as the transmission path with SIPROTEC 5 devices.

Protocols

The protocols available with SIPROTEC 5 can be divided into 2 categories:

- **Network protocols**
Network protocols perform certain tasks within an Ethernet network. The network protocol SNTP is typically responsible for the time synchronization. The network protocol RSTP is used to reorganize the network structure in the event of a failure. You can activate one or more network protocols separately for each Ethernet interface.
- **Communication protocols**
Communication protocols ensure a standardized data exchange between devices in the switchgear. These communication protocols are specially designed for transmitting data securely from the protection and control system. SIPROTEC 5 supports serial communication protocols such as IEC 60870-5-103 and Ethernet-based communication protocols such as IEC 61850-8-1.

SIPROTEC 5 Compact Communication Interfaces

- **Integrated redundant Ethernet interface**
This fix, redundant Ethernet interface allows IEC 61850 Ethernet communication or communication with another protocol via Ethernet, for example, for connecting an external RTD unit. This communication module is also used to load the device with DIGSI 5 via Ethernet.

Devices & Networks Editor

The Devices & Networks Editor is used for selecting and configuring the communication modules of a SIPROTEC 5 device and integrating the device into the network structure of the substation.

The Devices & Networks Editor has 2 tabs: **Network view** and **Device view**.

- **Network view tab**

The working area of this tab shows the front views of all SIPROTEC 5 devices available in the project. Colored squares mark the Ethernet interfaces of a SIPROTEC 5 device. These interfaces can be connected to one another by drag and drop. In this way, you can establish Ethernet-based communication connections between the SIPROTEC 5 devices. With the Inspector window, you can edit the properties of the Ethernet interface and subnetworks directly.

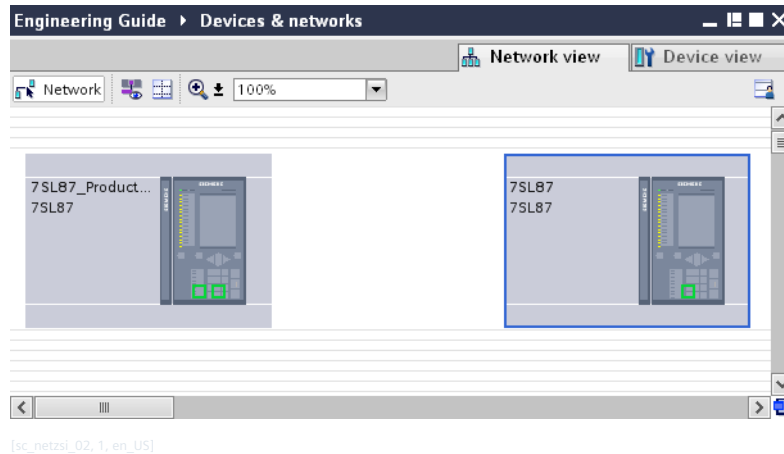
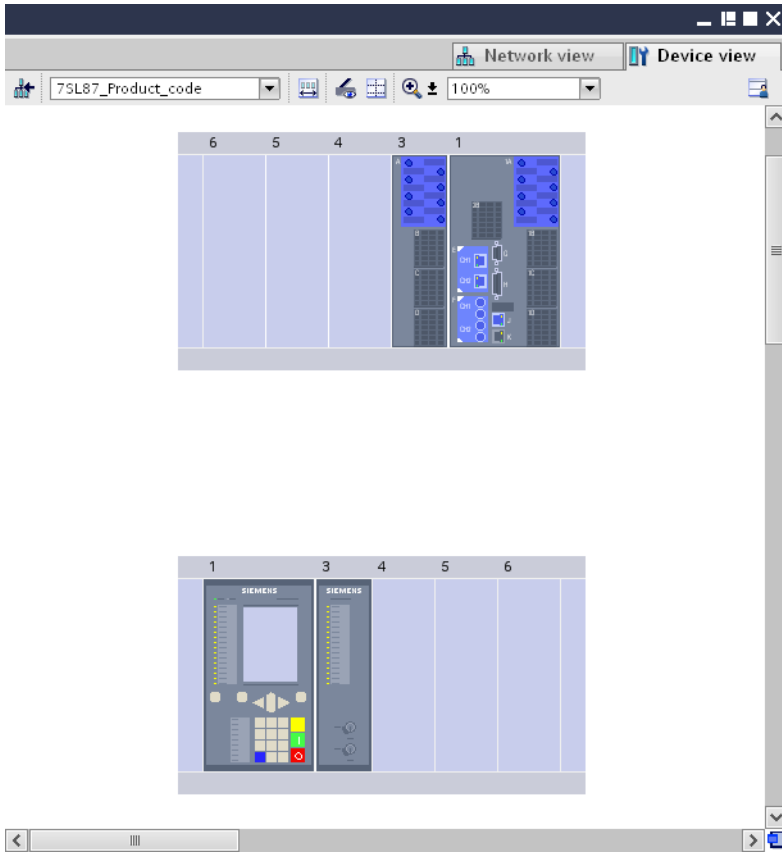

Figure 2-91 Network View Tab

- **Device view tab**

The working area of this tab shows the front view and rear view of the selected SIPROTEC 5 device. You can add or replace communication modules in the hardware configuration displayed. With the Inspector window, you can edit the properties of the Ethernet interface and serial interfaces directly.



[sc_gerasi_1, en_US]

Figure 2-92 Device View Tab, Example of SIPROTEC 5

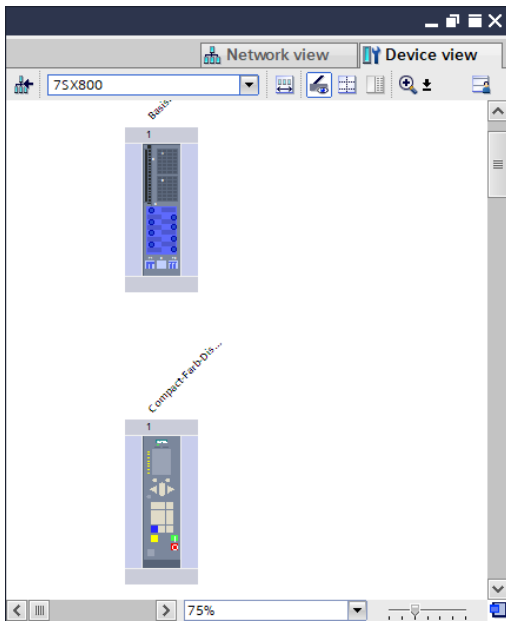

[sc_gerasi_CC_1, en_US]

Figure 2-93 Device View Tab, Example of SIPROTEC 5 Compact

2.10.2 Selecting and Configuring Protocols

With SIPROTEC 5, a communication module is not bound to a particular communication protocol. Instead, you can select among a number of protocols. Other parameters are displayed as soon as you selected a protocol. These parameters can be used to configure the communication protocol to suit your requirements.

Goal

The goal of this chapter is to select and configure the following protocols:

- Communication module **USART-AE-2FO** in the SIPROTEC 5 device **7SL87_Product Code**: Protocol **Protection interface**
- Communication module **ETH-BA-2EL** in the SIPROTEC 5 device **7SL87_Product Code**: Protocol **DNP3 Ethernet**
- Communication module **ETH-BA-2EL** in the SIPROTEC 5 device **7SL87_Manually_configured**: Protocol **DNP3 Ethernet**

Overview of the Procedure

Perform the following actions:

- Open the Device view.
- Configure communication channel 1 as a protection interface.
- Configure the 2 Ethernet interfaces for DNP3.

Opening the Device View and Inspector Window

✧ Double-click **Devices & networks** in the project tree.

The Device and Network Editor opens in the working area and the Network view is displayed.

✧ Select the **Device view** tab.

The empty Device view is displayed in the working area.

✧ In the **Device selection** list box, select the SIPROTEC 5 device **7SL87_Product Code**.

The hardware configuration of the selected SIPROTEC 5 device is displayed in the Device view.

✧ Open the Inspector window.

✧ Select the **Properties** tab.

Since no object is highlighted in the Device view, the **Properties** tab contains no values.

You have now reached the following point:

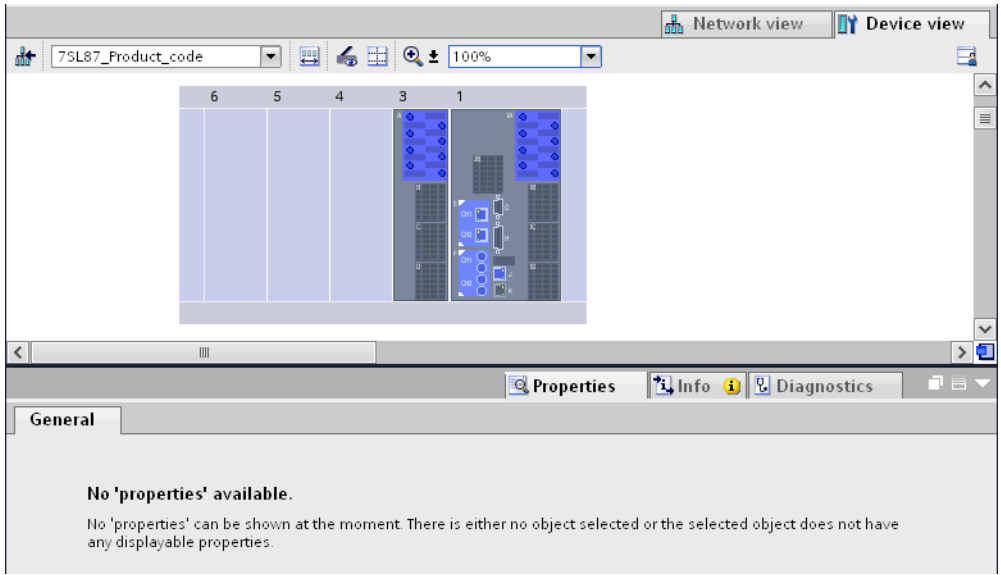

[sc_komeig_1, en_US]
 Figure 2-94 In-Between Result: Device View and Properties after Opening

Configuring Communication Channel 1 as a Protection Interface

You can configure up to 2 communication channels of a SIPROTEC 5 device as protection interface. You must then select a constellation for each communication channel selected to be a protection interface. With this selection, you establish how many devices are taking part in the protection communication.

- ✧ In the Device view, highlight the **USART-AE-2FO** communication module.

The communication settings currently available for the highlighted module are displayed in the **Properties** tab.

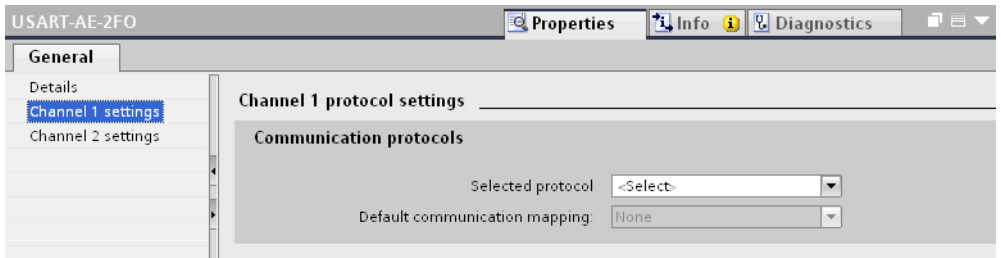

[sc_komeig_02, 1, en_US]
 Figure 2-95 Properties after Selecting the USART-AE-2FO Communication Module

- ✧ Select the **Channel 1 settings** group.
- ✧ In the **Selected protocol** list box, select the setting **Protection interface**.

The **Select Constellation** list box is displayed.

- ✧ In the **Select Constellation** list box, select the setting **2 Devices Prot. Data Com..**

Other parameters are highlighted with which you can configure the protection communication. These parameters are combined into different groups: You can learn more about these parameters in the DIGSI 5 Help in the **Properties > Communication and Network Protocols** section.

You have now reached the following point:

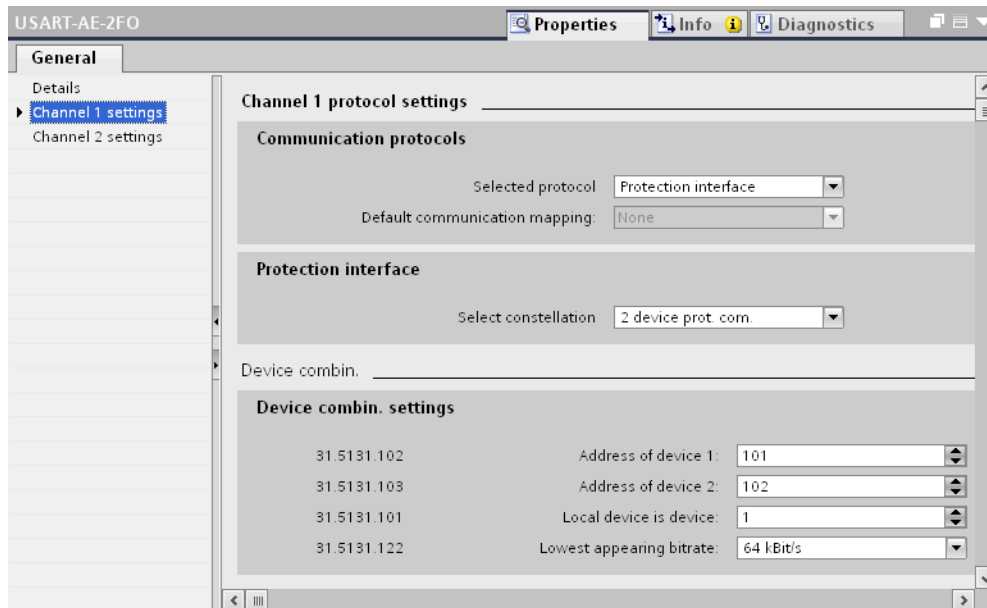

[sc_komeig_03_1_en_US]

Figure 2-96 In-Between Result: Properties after Selecting the Protocol and Constellation

Configuring Ethernet Interfaces for DNP3

For serial protocols such as DNP3 or IEC 60870-5-103, you must specify which signals are to be transmitted via the communication interfaces of a SIPROTEC 5 device. This is called **Communication mapping**. Depending on the signal type, you can route signals in the send or receive direction for each individual communication channel during communication mapping. You can also set mapping settings for each signal routed. To simplify project engineering, you can select a standard communication mapping for each communication channel. Routings for signals and settings for mapping parameters are predefined in a standard communication mapping. Depending on the communication protocol selected, DIGSI 5 provides you with various standard communication mappings.

✧ In the Device view, highlight the **ETH-BA-2EL** communication module.

The communication settings currently available for the highlighted module are displayed in the **Properties** tab.

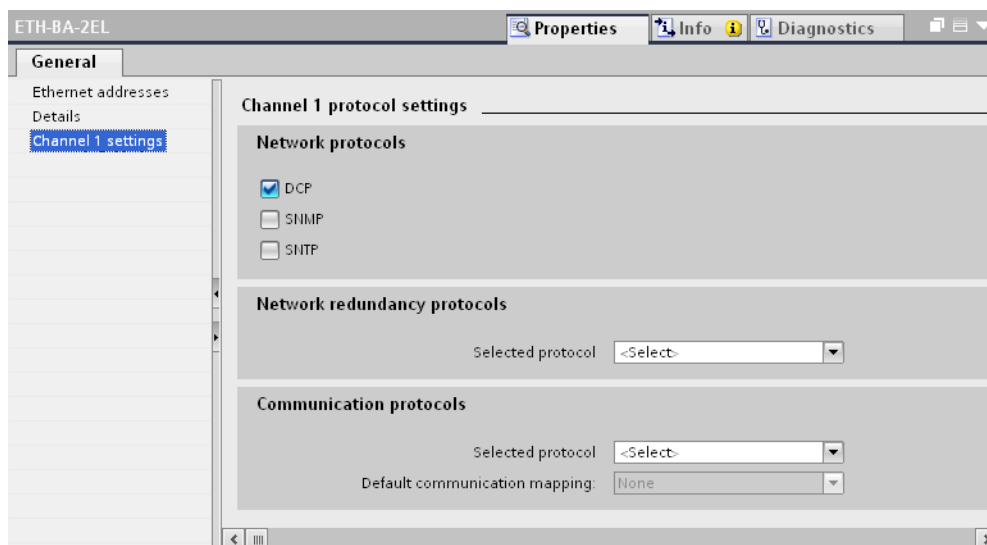

[sc_komeig_04_1_en_US]

Figure 2-97 Properties after Selecting the ETH-BA-2EL Communication Module

- ✧ Select the **Channel 1 settings** group.
- ✧ In the **Communication protocols** area, select the **DNP3 Ethernet** protocol from the **Selected protocol** list box.

The **Default communication mapping** list box is activated. Additional parameters that can be used to configure the DNP3 protocol are also shown. You can learn more about these parameters in the DIGSI 5 Help in the **Properties > DNP3 Ethernet Settings** section.

- ✧ In the **Default communication mapping** list box, select **DIFF/DIS Basis** as the communication mapping.

The predefined routings and settings are accepted in the communication mapping of the **7SL87_Product Code** offline configuration.

You have now reached the following point:

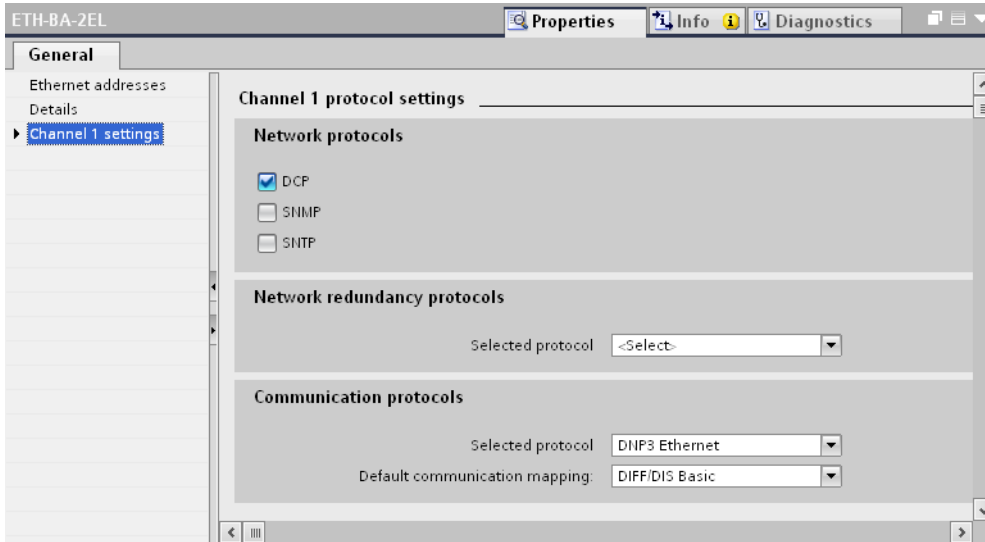

[sc_komeig_1_en_US]

Figure 2-98 In-Between Result: Properties after Selecting the Protocol and Default Communication Mapping

- ✧ In the **Device selection** list box, select the SIPROTEC 5 device **7SL87_Manually_configured**.
- ✧ Repeat the previously described procedure for the SIPROTEC 5 device **7SL87_Manually_configured**.

You have thus achieved the goal.

2.10.3 Adapting Communication Mapping for the DNP3 Protocol

To simplify project engineering, you have selected a default communication mapping for the DNP3 protocol. As a consequence, routings for signals and settings are defined automatically for mapping parameters. You can adapt these routings and settings to your specific requirements. Communication mappings are oriented to the device. For this reason, the communication mapping in the project structure is always saved in the offline configuration of a SIPROTEC 5 device.

You edit the communication mapping of a SIPROTEC 5 device using the **Communication-mapping** matrix.

Signals	Number	Type	IEC 61850 Signal	R	T
(All...)	(All...)	(All...)	(All...)	(All...)	(All...)
General	91			*	*
Device	4171				*
Alarm handling	5971				*
Time managem.	8821				
Time sync.	8851				
Power system	11		*		*
Recording	51				
Binary IO	61				
J-Onboard Ethernet	101				
F-USART-AE-2FO	102				
Line 1	21		*		*
Circuit breaker 1	301			*	*
2 device prot. com.	31				*
E-ETH-BA-2EL	103				

[sc_kommat_1, en_US]

Figure 2-99 Communication-Mapping Matrix

Like the **Information-routing** matrix, the **Communication-mapping** matrix has a table-like structure. The procedure for working with both matrices is similar.

Accordingly, to adapt the **Communication-mapping** matrix, follow the procedure described in the chapter [2.6.2 Opening the Information-Routing Matrix and Adapting the View](#).

Goal

The goal of this chapter is create the settings and routings in the following figure:

Signals	Number	Type	T	Object gro	Index	Class	Threshold	Scaling fac
(All...)	(All...)	(All...)	(All...)	(All...)	(All...)	(All...)	(All...)	(All...)
PF	21.761.1021...	MV	X	30	3	2	10	10

[sc_kommzu_02_1, en_US]

Figure 2-100 New Routing and Mapping Parameter Settings

The power factor is routed to the **Transmit** column and the following mapping parameters are set:

- Object group **30**
- Index **3**
- Class **2**
- Threshold value **10**
- Scaling **10**

Overview of the Procedure

Perform the following actions:

- Displaying communication mapping.
- Routing the power factor to the **Transmit** column.
- Setting the mapping parameters for transmission.

Displaying Communication Mapping

- ✧ In the project tree, open the folder for the offline configuration **7SL87_Product Code**.
- ✧ In this folder, double-click **Communication mapping**.

The **Communication-mapping** matrix opens in the working area. It displays the communication mapping of the SIPROTEC 5 device.

- ✦ From the list box in the toolbar of the **Communication-mapping** matrix, select the **Measured and Metered Values** display profile.

All lines that do not belong to this profile are hidden.

Routing the Signal

- ✦ In the **Signals** column, open the groups **Line 1** and **Operational measured value** one after the other.
- ✦ Right-click in the shared cell for the power factor and the **Transmit** column.
- ✦ Click **X (Routed)** in the context menu.

An **X** is entered into the cell. The power factor is routed to **Transmit**. The lines in the **Mapping settings** column block associated with the power factor are highlighted in color.

You have now reached the following point:

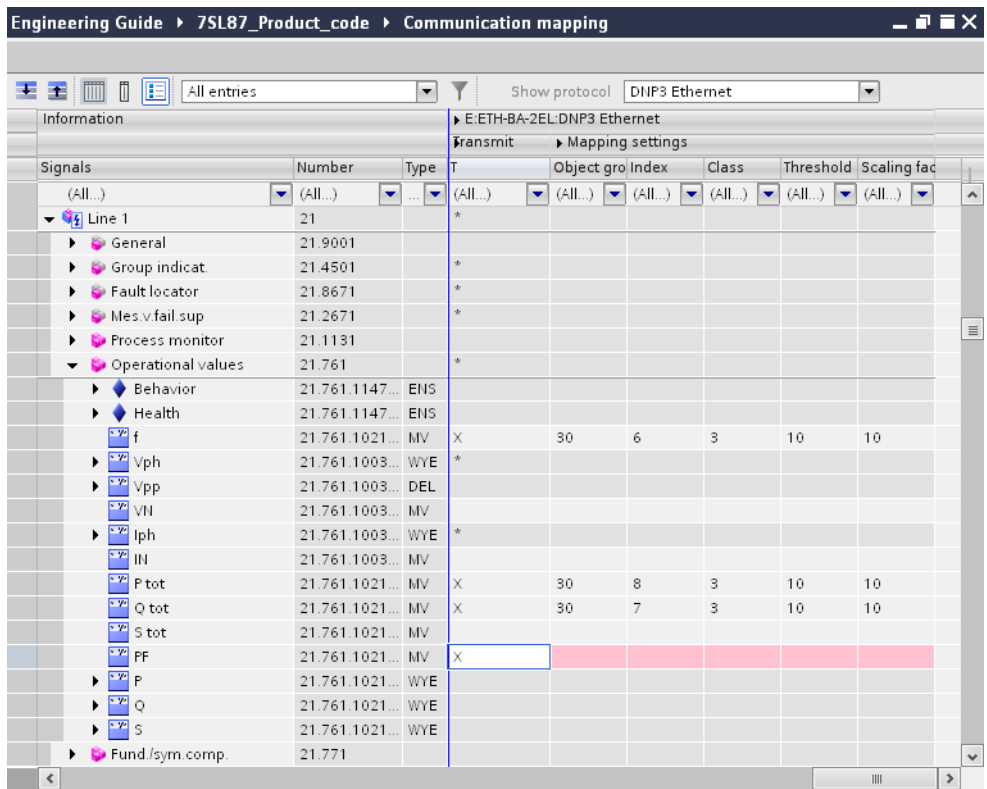

Figure 2-101 In-Between Result: Power Factor Routed to the Transmit Column

Setting Mapping Parameters

If you route a signal for transmission, you have to set the mapping settings associated with this signal.

- ✦ Double-click in the cell for the **Object group** mapping setting.

A list box opens.

- ✦ In the list box, select the value **30**.
- ✦ Click outside the cell.

The value is accepted. The cells are no longer highlighted in color.

- ✦ Double-click in the cell for the **Index** mapping setting.

A text box is activated.

- ✧ Enter the value **3** in this text box.
- ✧ Click outside the cell.

The value is accepted. The cells are no longer highlighted in color.

- ✧ Repeat the procedure for the remaining mapping settings. Use the values provided in the **Goal** section.
- ✧ Save the project.

You have thus achieved the goal.

2.10.4 Creating an Ethernet Connection

You can connect the 2 Ethernet interfaces of the SIPROTEC 5 devices **7SL87_Product Code** and **7SL87_Manually_configured** in the Network view. A new subnetwork is automatically created here. This new subnetwork connects the interfaces to one another.

Goal

The goal of this chapter is to create the following network structure:

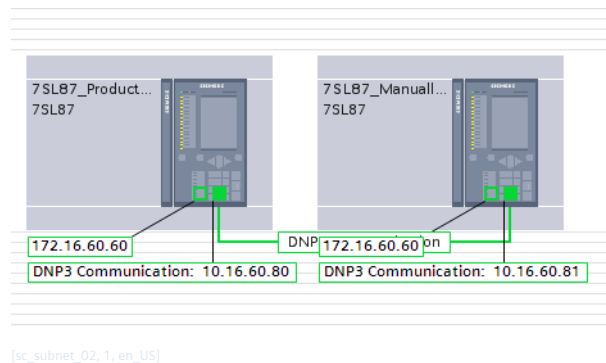

Figure 2-102 Ethernet Connection and IP Addresses

The 2 SIPROTEC 5 devices **7SL87_Product Code** and **7SL87_Manually_configured** are connected to one another via the **DNP3 Communication** subnetwork. The SIPROTEC 5 devices have the IP addresses 10.16.60.80 and 10.16.60.81.

Overview of the Procedure

Perform the following actions:

- In the Network view, connect the Ethernet interfaces of the 2 SIPROTEC 5 devices.
- Show the IP addresses and change them.

Connecting the Ethernet Interfaces in the Network View

You connect the Ethernet interfaces of the SIPROTEC 5 devices **7SL87_Product Code** and **7SL87_Manually_configured** in the Network view via drag and drop.

- ✧ Select the **Network view** tab.

The Network view is displayed in the working area. The Network view shows the front views of the 2 SIPROTEC 5 devices. Colored squares identify the Ethernet interfaces of the devices. On each device, the interface square on the left represents the integrated Ethernet interface. The interface square on the right on each device represents the Ethernet communication module.

- ✧ In the Network view, position the mouse pointer on the right interface square of the SIPROTEC 5 device **7SL87_Product Code**.

The mouse pointer is positioned correctly when a frame highlights the interface square.

- ✧ Click with the left mouse button and hold the button down.

- ✧ Move the mouse pointer and release the mouse button.

The mouse pointer now shows the locked symbol, which only disappears over a valid target position.

- ✧ Drag the mouse pointer to the right interface square of the SIPROTEC 5 device **7SL87_Manually_configured**.

As soon as you position the mouse pointer over the interface square, it shows the internetworking symbol.

- ✧ Click the interface square with the left mouse button.

A new subnetwork with the name **PN/IE_1** is created. This subnetwork connects the 2 interfaces to one another.

- ✧ Highlight the subnetwork in the Network view.

The subnetwork parameters are displayed in the **Properties** tab.

- ✧ In the **Name** text box, enter the new name **DNP3 Communication**.
- ✧ Click outside of the text box.

The name entered is adopted in the Network view.

You have now reached the following point:

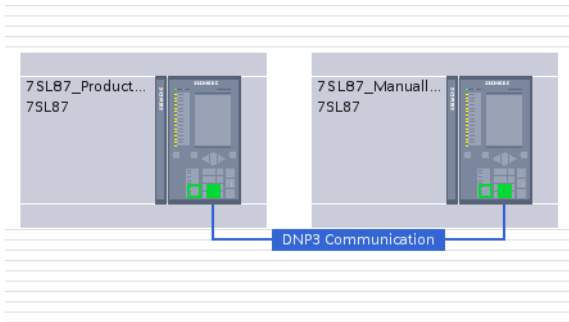

[sc_subnet_1_en_US]

Figure 2-103 In-Between Result: Subnetwork between the 2 SIPROTEC 5 Devices

Displaying and Changing IP Addresses

When you connect the interfaces of the SIPROTEC 5 devices **7SL87_Product Code** and **7SL87_Manually_configured** to one another, the address parameters of the interface are set to be consistent automatically. You can change the IP addresses.

- ✧ Click the  button in the symbol bar of the Network view.

All IP addresses are shown in the Network view.

- ✧ In the Network view, highlight the right interface square of the SIPROTEC 5 device **7SL87_Product Code**.

The interface parameters are displayed in the **Properties** tab.

- ✧ Select the **Ethernet addresses** group.
- ✧ In the **IP address** text box, change the IP address to 10.16.60.80.

You have now reached the following point:

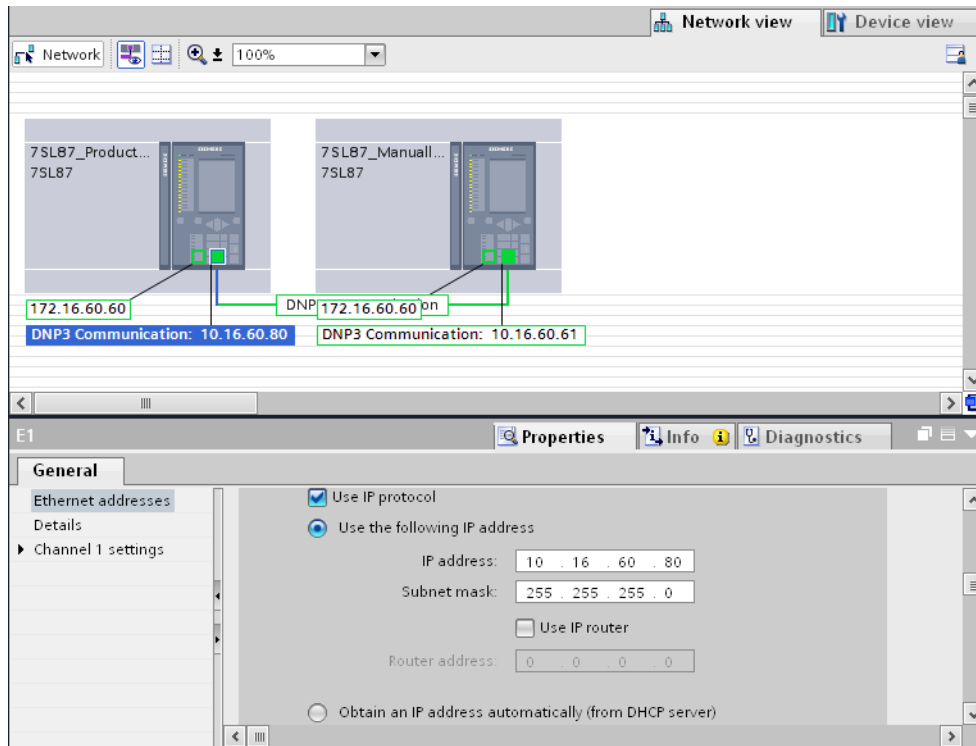

[sc_ipadre, 1, en_US]

Figure 2-104 In-Between Result: Changed IP Address

- ✧ In the Network view, highlight the right interface square of the SIPROTEC 5 device **7SL87_Manually configured**.
- ✧ In the **IP address** text box, change the IP address to 10.16.60.81.
- ✧ Save the project.

You have thus achieved the goal.

3 Loading the Configuration into the SIPROTEC 5 Device

3.1	Overview	126
3.2	Initializing the SIPROTEC 5 Device	128
3.3	Establishing a Permanent Connection to the SIPROTEC 5 Device	129
3.4	Transmitting the Offline Configuration to the SIPROTEC 5 Device	130
3.5	Disconnecting the Connection to the SIPROTEC 5 Device	131

3.1 Overview

If the offline configuration of a SIPROTEC 5 device has been completely edited, you can transmit this to the physical SIPROTEC 5 device. To do this, the DIGSI 5 PC and the SIPROTEC 5 device must be physically connected via a communication line. A logical communication connection must also be established between the 2 communication subscribers.

Connection Facilities

There are 3 ways to connect the DIGSI 5 PC to a SIPROTEC 5 device:

- Via USB
- Via an integrated Ethernet interface
- Via one or more Ethernet communication modules

Devices and Configurations

The project tree contains the project and the list of online accesses. All communication interfaces of the DIGSI 5 PC, via which a connection to SIPROTEC 5 devices can be established, are identified as online accesses. The list contains a folder for each online access.

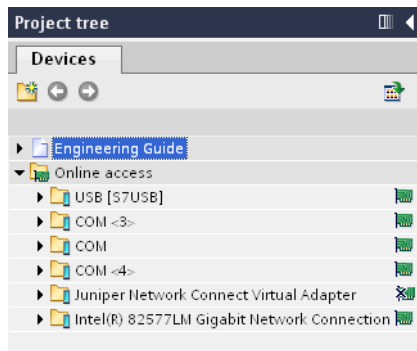

[sc_pnonzu, 1, en_US]

Figure 3-1 Online Accesses of the DIGSI 5 PC

As soon as you establish a communication connection to a SIPROTEC 5 device, this online device is displayed in the list of online accesses. The online device is found in the online-access folder through which the connection is established, that is, the Ethernet interface of the DIGSI 5 PC. You can use an online device to assign the represented SIPROTEC 5 device to a suitable offline configuration in the project. Assigning a SIPROTEC 5 device to a certain offline configuration is a requirement for certain processes and opens up additional editing possibilities.

Different Configurations

With DIGSI 5, you work in the **offline** and **online** modes. As a result, different configurations are found in the project, in the SIPROTEC 5 device, and in the DIGSI 5 PC memory. You must distinguish between 3 configurations:

- **Offline configuration**
The offline configuration is the configuration saved in a project for a physical SIPROTEC 5 device. You have now completed all identified engineering tasks in the offline configuration.
- **Device configuration**
The device configuration is the configuration saved in a physical SIPROTEC 5 device. As soon as you transmit an offline configuration from a project into the physical SIPROTEC 5 device, it is added to the device configuration.

- **Online configuration**

Additional entries are displayed if you open the online device in the list of online accesses. These entries represent the online configuration. The online configuration is the device configuration temporarily saved in DIGSI 5 for a physical SIPROTEC 5 device that is connected online with the DIGSI 5 PC. If you transmit the configuration from a SIPROTEC 5 device to the DIGSI 5 PC, initially the settings in the online configuration are identical to the settings in the device configuration. However, since you can edit the online configuration, the online configuration can differ from the device configuration.

Confirmation IDs and Connection Password

Confirmation IDs are used for protection against unintentional operation. If a confirmation ID is activated, you must enter it before the relevant action is enabled by the SIPROTEC 5 device. For this purpose, the confirmation ID is transmitted in an encrypted way to the SIPROTEC 5 device, where it is checked.

A similar method is used for a communication connection between DIGSI 5 and a SIPROTEC 5 device. To protect access to the SIPROTEC 5 device, there is a password for establishing the connection.

Confirmation IDs and the connection password can only be modified with DIGSI 5, but not with the SIPROTEC 5 device.

Requirements

The following requirements must be met for the steps described in further chapters:

- **Product code/MLFB number**

You can only transmit an offline configuration to your SIPROTEC 5 device which uses the same product code/MLFB number of your SIPROTEC 5 device. You cannot transmit the offline configuration used in the example steps to your SIPROTEC 5 device.

- **Consistency**

Consistent offline configuration is required for this. If there is no icon or the  icon is displayed near the name of the offline configuration in the project tree, the offline configuration is consistent.

If the  icon is displayed, the offline configuration is inconsistent. These inconsistencies must be resolved. You can transmit the offline configuration to the SIPROTEC 5 device only then.

- **Confirmation IDs and connection password**

The description of the step requires that the **Set/Operation** confirmation ID has the **222222** standard setting. The connection password is deactivated for commissioning.

- **Physical connection**

The DIGSI 5 PC must be connected to the SIPROTEC 5 device via a USB. If you are using a USB connection between the DIGSI 5 PC and a SIPROTEC 5 device, only 1 device may be connected to the PC. If you are connecting other SIPROTEC 5 devices to additional free PC USB connections, then no communication connection can be established to any of these devices. Connect the DIGSI 5 PC and SIPROTEC 5 device directly to each other. If you are using a USB hub, then no communication connection can be established between the DIGSI 5 PC and the SIPROTEC 5 device. For connecting to the SIPROTEC 5 device, use the top USB connection in the on-site operation panel of the base module

3.2 Initializing the SIPROTEC 5 Device

Before commissioning a SIPROTEC 5 device, you must initialize it once using the offline configuration created for this device. During initialization, this offline configuration is transmitted from the DIGSI 5 PC to the SIPROTEC 5 device. The SIPROTEC 5 device is then ready for operation.

In DIGSI 5, initialization associates the offline configuration with the SIPROTEC 5 device. For this, the SIPROTEC 5 device transmits its serial number, which is then entered in the corresponding offline configuration.

Goal

The goal of this chapter is to create a SIPROTEC 5 device that is initialized with the offline configuration and is ready for operation.

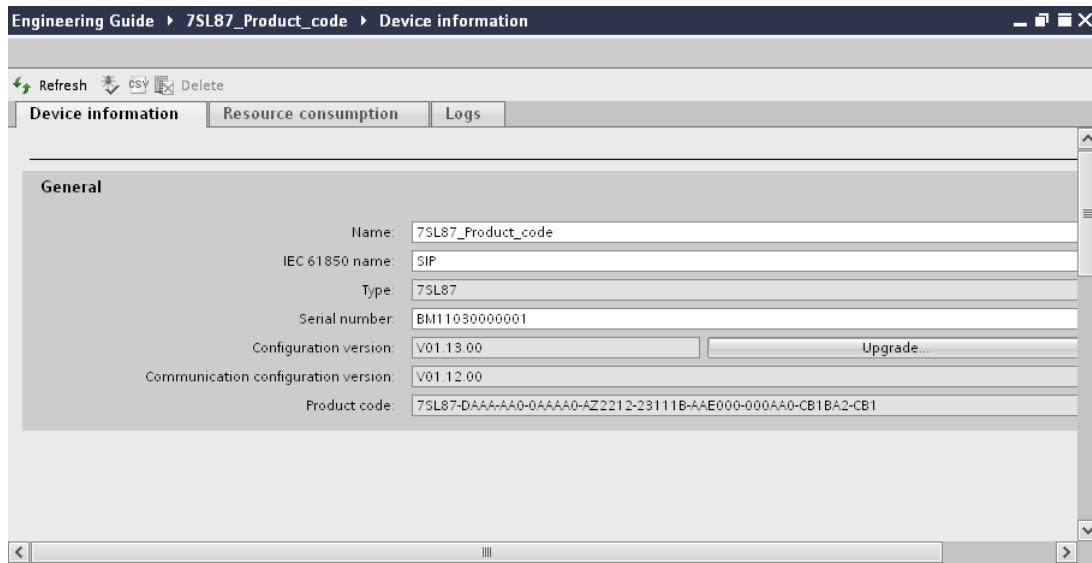

[sc_serum_1_en_US]

Figure 3-2 Device Information of a SIPROTEC 5 Device with Serial Number Entered

Starting Initialization

- ✧ In the project tree, right-click the folder of the offline configuration in question.
- ✧ Click **Load Configuration in Device** in the context menu. This menu item is only active if the SIPROTEC 5 device is connected through a USB connection to the DIGSI 5 PC.

The **Enter Confirmation ID** dialog opens.

- ✧ In the **Enter Confirmation ID** text box, enter the **222222** confirmation ID.
- ✧ Click **OK**.

The **Enter Confirmation ID** dialog is closed. A confirmation box is displayed if DIGSI 5 detects a SIPROTEC 5 device connected via USB.

- ✧ Click **Yes** to confirm.

Initialization starts. Several indications inform you about each status. Upon completion of initialization or in case of failed initialization, a status dialog opens.

- ✧ Click **OK**.

The status dialog closes. After initializing, the SIPROTEC 5 device is restarted.

3.3 Establishing a Permanent Connection to the SIPROTEC 5 Device

For DIGSI 5 and a SIPROTEC 5 device to exchange data, you must establish a permanent communication connected between the 2 communication participants. For this, there are several options that are extensively described in the DIGSI 5 Help. This chapter explains how to connect to a SIPROTEC 5 device via its offline configuration.

After establishing a connection, an online device is displayed in the list of online accesses that contains the complete online configuration. You then have immediate access to all data concerning the SIPROTEC 5 device that is connected online.

Goal

The goal of this chapter is to create a SIPROTEC 5 device that is permanently connected to the DIGSI 5 PC.

Connecting via Offline Configuration

- ✧ In the project tree, right-click the folder of the offline configuration in question.
- ✧ Click **Connect with Device** in the context menu. This menu item is only active if the SIPROTEC 5 device is not yet connected to the DIGSI 5 PC.

A confirmation box is displayed if DIGSI 5 detects a SIPROTEC 5 device connected via USB.

- ✧ Click **Yes** to confirm.

The communication connection is established via USB.

If the connection is established, then the folder for the online access used is opened in the list of online accesses. The folder of this online access displays the connected SIPROTEC 5 device as an online device. The online device contains the complete online configuration.

3.4 Transmitting the Offline Configuration to the SIPROTEC 5 Device

As soon as you have completed the offline configuration, you can load it into the applicable SIPROTEC 5 device. Here, you can directly select an individual offline configuration and load it into the respective device. However, you can also use the configuration selection to select several offline configurations for different SIPROTEC 5 devices and start loading at the same time. The individual offline configurations are then loaded automatically one after the other into the applicable SIPROTEC 5 device. You can learn more about this subject in the DIGSI 5 Help in the **Commissioning and Operating > Editing and Transmitting Configurations** section.

Loading the Individual Offline Configuration into the SIPROTEC 5 Device

- ✧ In the project tree, right-click the folder of the offline configuration to be transmitted.
- ✧ Click **Load Configuration in Device** in the context menu.

The **Enter Confirmation ID** dialog opens.

- ✧ In the **Enter Confirmation ID** text box, enter the **222222** confirmation ID.
- ✧ Click **OK**.

The **Enter Confirmation ID** dialog is closed. The current and all other loading actions are now released by entering the confirmation ID. When you close the project or disconnect the communication connection to the SIPROTEC 5 device, the release is cancelled.

A confirmation box is displayed if DIGSI 5 detects a SIPROTEC 5 device connected via USB.

- ✧ Click **Yes** to confirm.

The offline configuration is transmitted via the USB connection to the connected SIPROTEC 5 device.

Several indications inform you about the status of the transmission. Upon completion of the transmission or if the transmission fails, a status dialog opens.

- ✧ Click **OK**.

The status dialog closes.

After loading the offline configuration into the SIPROTEC 5 device, the device is restarted.

3.5 Disconnecting the Connection to the SIPROTEC 5 Device

To disconnect the communication connection between a SIPROTEC 5 device and a DIGSI 5 PC, use the context menu to enter the instruction command to disconnect the communication connection. The communication connection is automatically disconnected if you close DIGSI 5.

Disconnecting the Connection

- ✧ In the project tree, right-click the folder of the offline configuration associated with the SIPROTEC 5 device that is connected online.
- ✧ Click **Disconnect device** in the context menu.

If you changed the online configuration, you can transmit the changes to the SIPROTEC 5 device. A confirmation box is displayed for this purpose.

- ✧ In order to transmit the settings, changed in the online configuration, to the SIPROTEC 5 device, click **Yes**, otherwise click **No**.

If you click **Yes**, the data are transmitted to the SIPROTEC 5 device. Several indications inform you about the current status. If you click **No** the data are not transmitted.

If the SIPROTEC 5 device is assigned to an offline configuration in the project, then you can update this offline configuration with the changed online configuration. A confirmation box is displayed for this purpose.

- ✧ In order to copy the settings changed in the online configuration to the offline configuration, click **Yes**, otherwise click **No**.

If you click **Yes**, the data are copied to the offline configuration. Several indications inform you about the current status. If you click **No** the data are not copied.

The online device is removed from the list of online accesses. The communication connection is disconnected.

4 Upgrading Device Functionality

4.1	Overview	134
4.2	Determining the Serial Number of the SIPROTEC 5 Device	135
4.3	Determining the Required Function-Point Class	136
4.4	Selecting the Device Functionality	138
4.5	Loading Device Functionality to the SIPROTEC 5 Device	142

4.1 Overview

When you order a SIPROTEC 5 device, you select not only the hardware for this device but also certain functional characteristics. These functional characteristics include, for example, the function-point class, that is, the number of function points available for the device application. If you own a SIPROTEC 5 device, you can, if necessary, select, order, and finally load additional functionality into the device.

Functional Characteristics that Can Be Updated

You can update the following functional characteristics in SIPROTEC 5:

- **Features of the integrated Ethernet interface (SIPROTEC 5 only)**
If you have been using the integrated Ethernet interface so far purely as a user interface for DIGSI 5, you can extend the interface with the **IEC 61850 Reporting** functionality. This update feature is available for all device types.
- **Function-point class**
If the current number of function points is inadequate for the device application, you can purchase additional function points for the SIPROTEC 5 device. You select a higher function-point class for this purpose. This update feature is available for all device types.
- **Significant feature (SIPROTEC 5 only)**
For certain device types, for example, for the **7SL87 type**, you can decide at the time of placing the order whether the SIPROTEC 5 device should be usable as a two-ended protection, a three-ended protection, or as a multi-ended protection. You can update this device functionality. You can expand a two-ended protection to a three-ended protection or a multi-ended protection, and a three-ended protection to a multi-ended protection.

Device Functionality Linked to the Serial Number

You select and order additional device functionality always for a certain SIPROTEC 5 device. Hence, when selecting the device functionality, you must specify the serial number of the SIPROTEC 5 device. This means that you must already have a SIPROTEC 5 device in order to update its functionality. The additional device functionality supplied by Siemens is linked to the SIPROTEC 5 device, whose serial number you have specified when selecting the functionality. You cannot transfer the device functionality supplied to another SIPROTEC 5 device.

Basic Procedure

You can select, order, and pay for the additional device functionality via Internet. Use the SIPROTEC 5 Configurator to select the device functionality and the Siemens SAP system to order and pay for the same. You will then receive a signed license file from Siemens, which describes the extended device functionality. Load this license file with DIGSI 5 into the SIPROTEC 5 device.

Proceed as follows in order to update the functionality of a SIPROTEC 5 device:

- Determine the serial number of the SIPROTEC 5 device.
- Determine the required function-point class.
- Select the additional device functionality.
- Order, pay, and receive the device functionality.
- Load the device functionality into the SIPROTEC 5 device.
- Update the existing offline configuration.

4.2 Determining the Serial Number of the SIPROTEC 5 Device

You can order additional device functionality only for a specific SIPROTEC 5 device. The serial number of the device is used as the criterion for assignment to a specific device. You have the following options to determine the serial number of a SIPROTEC 5 device:

- If you can access the SIPROTEC 5 device physically, you can also read the serial number from the name plate on the SIPROTEC 5 device.
- If you cannot access the SIPROTEC 5 device physically, you can also read the serial number via a communication connection from the device. To do this, DIGSI 5 online must be connected with the SIPROTEC 5 device. The SIPROTEC 5 device is also visible as an online device in the list of online-access links.

Reading the Serial Number from the SIPROTEC 5 Device

- ✧ Open the **Online access** folder in the project tree.
- ✧ Open the Online access folder with the help of which the SIPROTEC 5 device is connected online to DIGSI 5.
- ✧ Open the online device.
- ✧ Double-click **Device information**.

The device information is displayed in the working area. In the **General** area, the serial number of the SIPROTEC 5 device is displayed in the **Serial number** field.

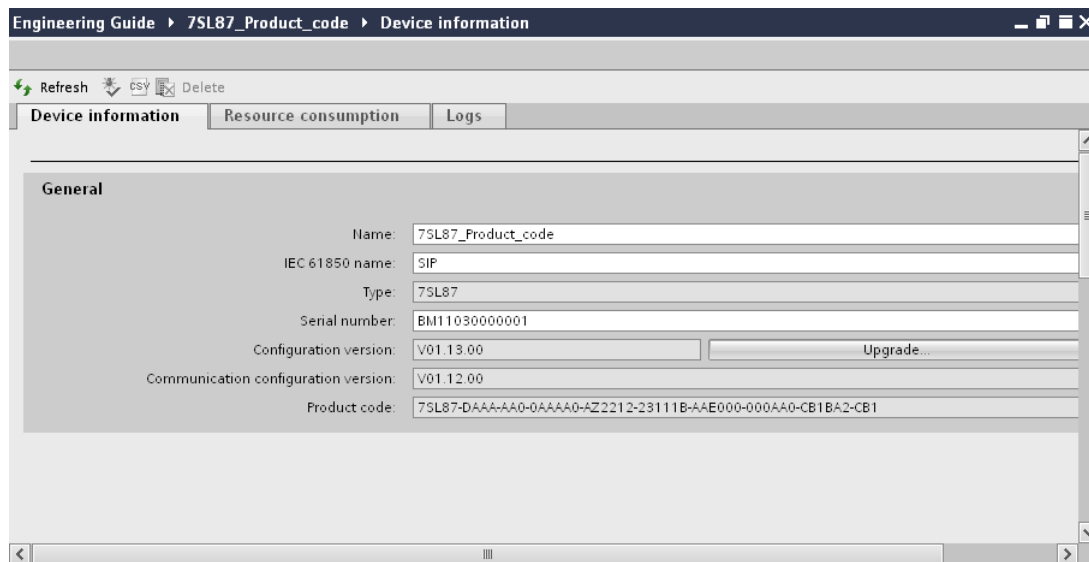

[sc_serum, 1, en_US]

Figure 4-1 Serial Number in the Device Information

4.3 Determining the Required Function-Point Class

The functional scope of an application and the CFC functions used determine the number of function points required for an offline configuration. Using DIGSI 5, you can also create an offline configuration that needs more function points than those that are actually available in the SIPROTEC 5 device. If, however, you want to load the offline configuration in the SIPROTEC 5 device, it must have at least the number of function points required. If the number of function points currently available is not adequate, you must obtain the next higher function-point class that covers the requirement of function points.

Proceed as follows to determine the function-point class required:

- **Checking current usage of function points**
Check the current usage of function points. No other steps are necessary if this lies within the current function-point class. Otherwise, carry out the next step.
- **Selecting new function-point classes**
If, for example, you need at least 234 points for the application planned now, but you have, so far, only the function-point class **Basic + 200**, select the function-point class **Basic + 250**. You can also select a higher function-point class and thus, create spare capacity for additional function extensions.

Checking the Current Usage of Function Points

- ✧ Open the offline configuration of the SIPROTEC 5 device involved in the project tree.
- ✧ Double-click **Device information** in this folder.

The device information is displayed in the working area.

- ✧ Select the **Resource consumption** tab.

The current usage of function points is displayed in the **Function points** area. Leave the tab open and carry out the instructions given in the next section.

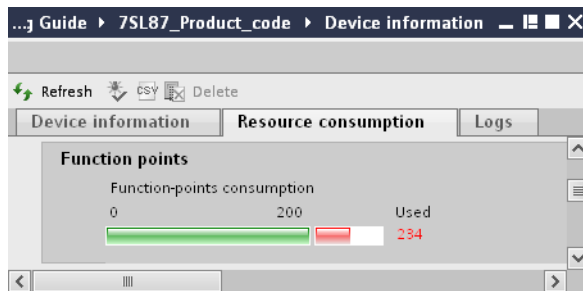

[sc_funpun_1_en_US]

Figure 4-2 Current Function-Point Consumption

Select New Function-Point Class

- ✧ Open the **Settings** folder in the same offline configuration.
- ✧ Double-click **Device settings** in this folder.

The device settings appear in the working area.

- ✧ In the DIGSI 5 toolbar, click the  button.

The device settings and device information are displayed in the working area below one another.

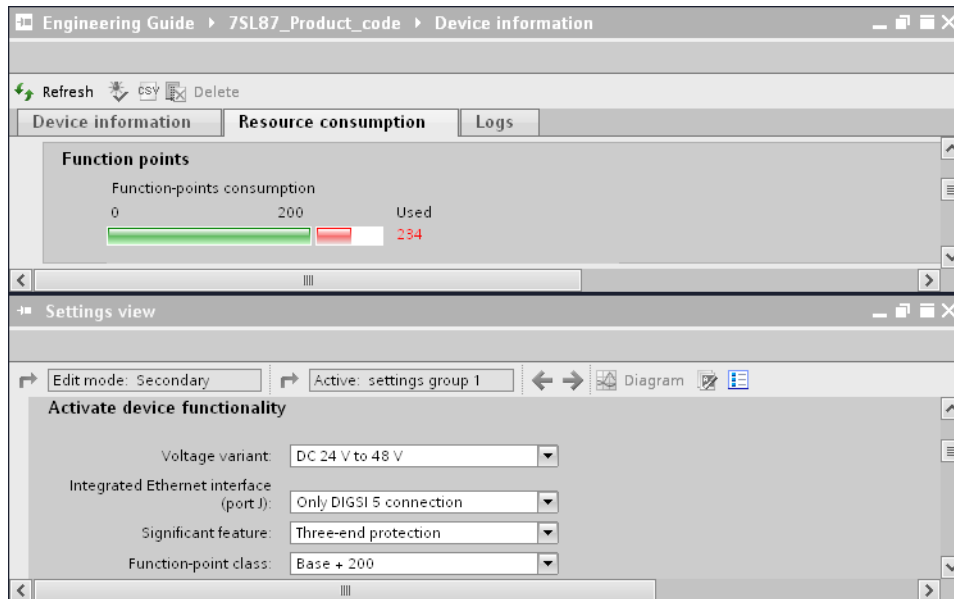

[sc_funpun_02_1, en_US]

Figure 4-3 Device Settings and Device Information

- ✧ Select a function-point class that covers the present usage of function points in the device settings, for example, **Basis + 300**. To do this, use the **Function-point class** list box.

The display of the function points used is updated in the device information. If no red bar is displayed, the function-point class is suitable for the current requirement of function points.

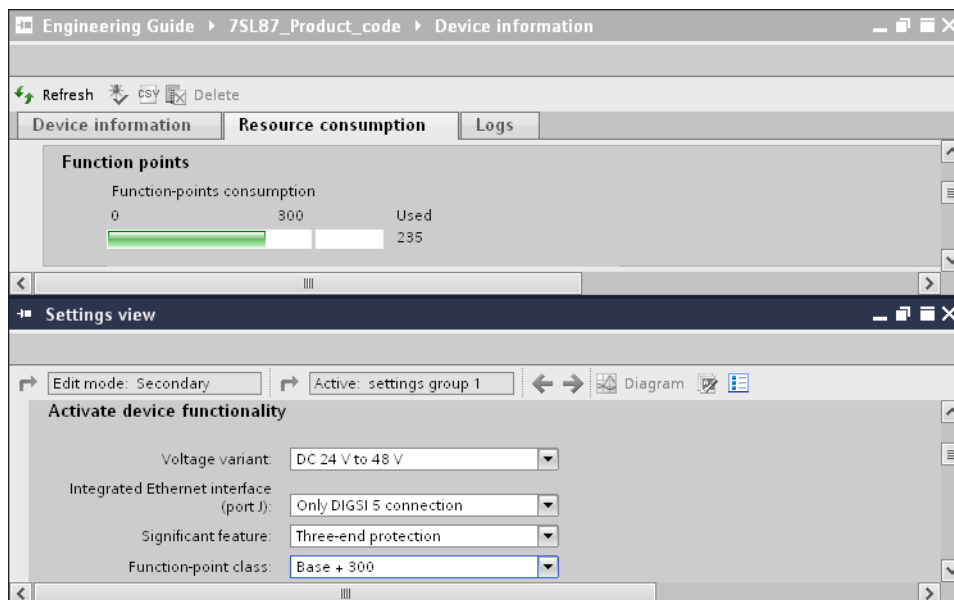

[sc_funpun_04_1, en_US]

Figure 4-4 Function-Point Class Suitable for the Function-Point Requirement

4.4 Selecting the Device Functionality

Use the SIPROTEC 5 Configurator to select additional device functionality. The SIPROTEC 5 Configurator is a Web application you can execute with the browser on your PC.

You select the additional device functionality for exactly one SIPROTEC 5 device. To do this, enter the serial number of the device during the selection process. Make sure that you enter the serial number correctly. If you enter the wrong serial number, you cannot load the additional device functionality into the SIPROTEC 5 device.

How to determine the serial number is described in the chapter [4.2 Determining the Serial Number of the SIPROTEC 5 Device](#).

Starting the SIPROTEC 5 Configurator

- ✦ Open your browser.
- ✦ Enter the following address in the address bar of the browser:
<http://www.energy.siemens.com/hq/de/automatisierung/stromuebertragung-verteilung/schutz/siprotec5/bestellkonfigurator.htm>.

The browser switches to the SIPROTEC 5 Configurator page.

- ✦ Click **Configuration/Add to my products**.

The start page of the SIPROTEC 5 Configurator appears.

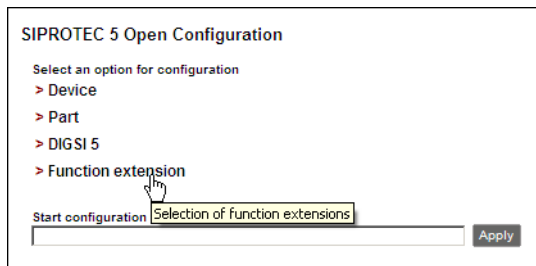

[sc_sipkon_1_en_US]

Figure 4-5 Start Page of the SIPROTEC 5 Configurator

Selecting the Device Type and Entering the Serial Number

- ✦ Click **Function extension** in the start area of the SIPROTEC 5 Configurator.

The **Function extension** area is displayed in the browser.

- ✦ Select the device type of the SIPROTEC 5 device to be updated from the **Device type** list box, for example, **7SL87 Diff. & Dist 1-/3-p**.

Depending on the device type selected, an additional list box is displayed for the significant feature.

- ✦ Enter the serial number of the SIPROTEC 5 device to be updated in the **Serial number of device** text box.

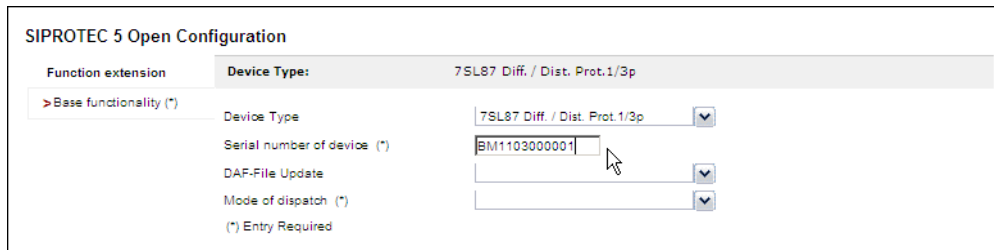

[sc_sipkon_02_1_en_US]

Figure 4-6 Device Type Selected and Serial Number Entered

Selecting the Device Functionality Required

- ✧ If you want to change the relevant feature of the SIPROTEC 5 device to be updated, select the significant feature from the **Significant feature** list box. You can select the features **Three-ended protection** and **Multi-ended protection**. The **Significant feature** list box is visible if the device type selected has the features mentioned.
- ✧ If you need a higher function-point class for the SIPROTEC 5 device to be updated, select it from the **Function-point class** list box. You do not select additional points individually, but instead, a function-point class that covers the number of function points required. However, you must pay only for the difference between the new and the current function-point class.
- ✧ If you would like to use the integrated Ethernet interface for IEC 61850 reporting as well, select the setting **DIGSI 5 and IEC 61850/limited** from the **Integrated Ethernet Port** list box.

The screenshot shows the 'SIPROTEC 5 Open Configuration' window. At the top, it displays 'Function extension' and 'Device Type: 7SL87 Diff. / Dist. Prot.1/3p'. Below this, there is a section for 'Base functionality (*)' with several configuration options:

Field	Value
Device Type	7SL87 Diff. / Dist. Prot.1/3p
Serial number of device	BM1103000001
Significant properties	multi-end protection
DAF-File Update	no modification
Function points class	Base + 300 function points
Integrated Ethernet port	DIGSI 5 and IEC 61850/limited
Mode of dispatch (*)	

At the bottom, there is a note: '(*) Entry Required'.

[sc_sipkon_03, 1, en_US]

Figure 4-7 Device Functionality Selected

Selecting the Mode of Dispatch and Displaying the Result

- ✧ Use the **Mode of dispatch** list box to select how you would like to receive the signed license file with the information for expanded device functionality. You can select between the modes of dispatch **Download** and **E-mail**.

When you select the **Download** mode of dispatch, you receive a link after the order placement and payment procedure. With this link, you can load the license file on your PC.

- ✧ If you select the **E-mail** mode of dispatch, the **E-mail address** text box is displayed. Enter a valid e-mail address in the **E-mail address** text box, to which the license file should be sent after completing the order placement and payment procedure.

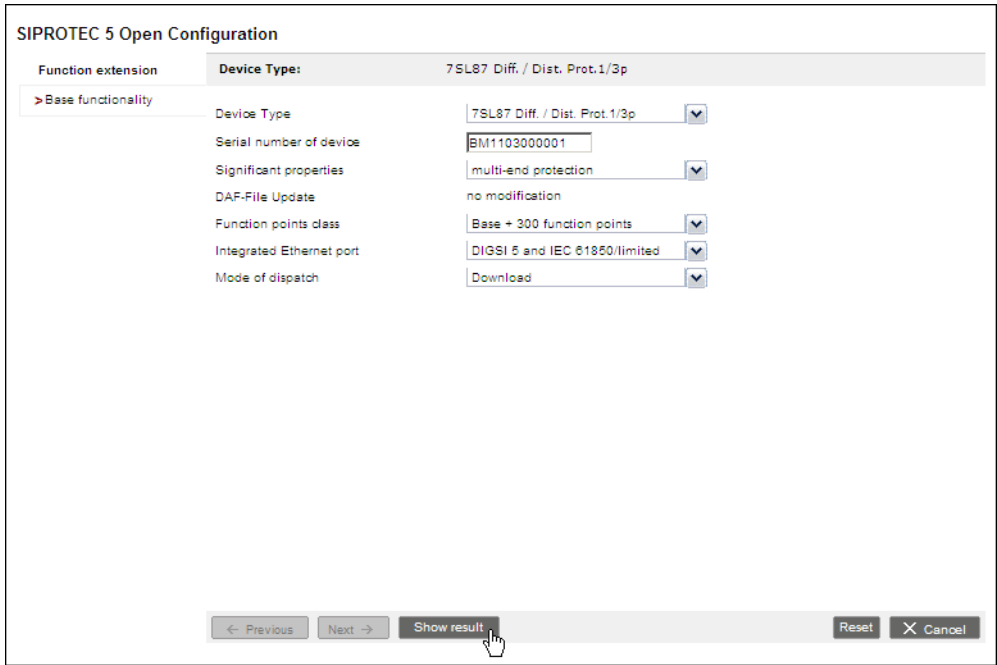

[sc_sipkon_04, 1, en_US]

Figure 4-8 Mode of Dispatch Selected

✦ Now, click **Show result**.

The result of your selection is displayed in the browser.

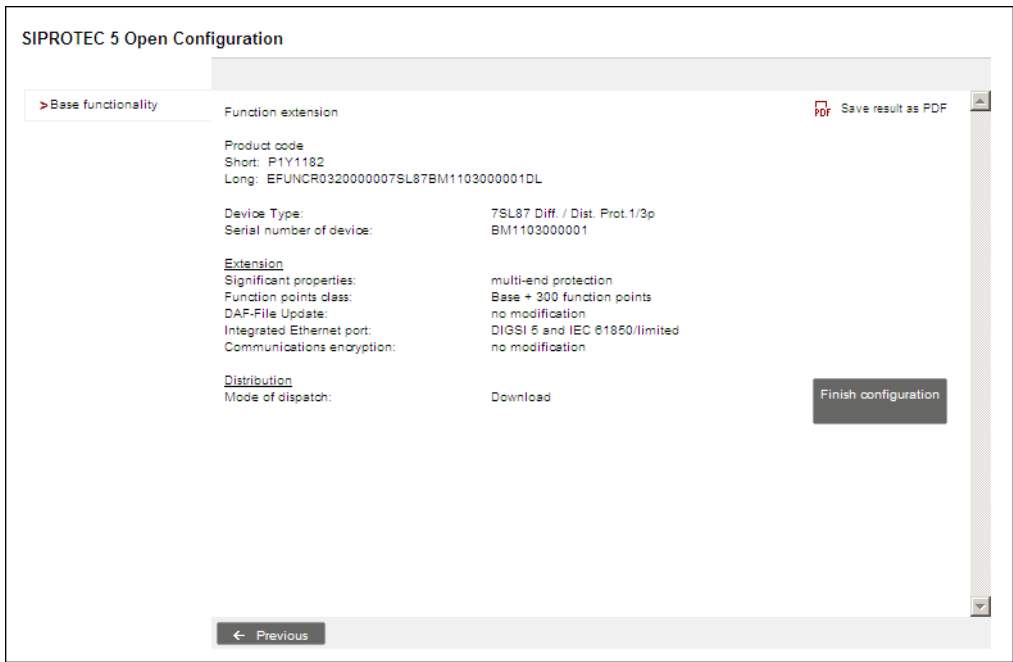

[sc_sipkon_05, 1, en_US]

Figure 4-9 Configuration Result

✦ If you want to save the result as a PDF file, click **Save result as PDF**.

A PDF file is generated and displayed in a separate browser window. Then, you can save the PDF file displayed on your PC.

✦ Click **Finish Configuration**.

A table-like summary with the order number is displayed in the browser.

SIPROTEC 5 Open Configuration

[> New configuration](#)
[> Print](#)
[> Add to My Products](#)

[> Request](#)

Product Number: P1Y1182

Configured on November 8, 2012	Process no.: 1643028 / 0
--------------------------------	--------------------------

Product specification

Device Type	7SL87 Diff. / Dist. Prot.1/3p
Serial number of device	BM1103000001
Significant properties	multi-end protection
Function points class	Base + 300 function points
DAF-File Update	no modification
Integrated Ethernet port	DIGSI 5 and IEC 61850/limited
Communications encryption	no modification
Mode of dispatch	Download

Destination Export Control

The goods marked with "**AL unequal N**" have to get a European and/or German permission for their exportation when being exported into countries which do not belong to the EU. The goods marked with "**ECCN unequal N**" have to get a US permission when being reexported. Even without being marked or just marked with the codes "**AL:N**" or "**ECCN:N**" a permission could have to be obtained because of, among other, destination and purpose of use of goods.

[sc_sipkon_06, 1, en_US]

Figure 4-10 Table-Like Summary with Order Number

✧ Click **Add to My Products**.

The configured function extension is placed in your basket as an order. You can use the basket to order the function extension just like any other product.

4.5 Loading Device Functionality to the SIPROTEC 5 Device

You must load the signed license file into the SIPROTEC 5 device in order to be able to use the expanded device functionality in the device. To do this, DIGSI 5 online must be connected with the SIPROTEC 5 device. The SIPROTEC 5 device must, therefore, be visible as an online device in the list of online-access links.

Selecting the License File and Loading

- ✧ Open the **Online access** folder in the project tree.
- ✧ Open the Online access folder through which the SIPROTEC 5 device is connected to DIGSI 5.
- ✧ Right-click the name of the online device in this folder.
- ✧ Click **Upgrade the device functionality** in the context menu.

The **Select upgrade device functionality** dialog is opened.

- ✧ Select the license file using this dialog. This file has the file extension **DAF**.
- ✧ Click **Open**.

The dialog closes and the file selected is prepared for the loading operation. In the process, DIGSI 5 checks whether the serial number given in the license file matches that of the SIPROTEC 5 device. If the 2 serial numbers do not match, the device functionality cannot be transmitted to the SIPROTEC 5 device. You receive a message to this effect.

- ✧ Click **OK**.

The procedure is cancelled. The new device functionality is not transmitted to the SIPROTEC 5 device.

If the serial numbers match, DIGSI 5 checks whether the device functionality to be loaded is more up-to-date than that one present in the SIPROTEC 5 device. You get a confirmation box if the device functionality to be loaded is older than or as old as the one that is present.

- ✧ If you want to load the device functionality into the SIPROTEC 5 device, click **Yes**, otherwise click **No**.

The operation is cancelled if you click **No**. The new device functionality is not transmitted to the SIPROTEC 5 device.

If you click **Yes**, the loading operation starts and the new device functionality is transmitted to the SIPROTEC 5 device.

Several indications inform you about the status of the transmission. Upon completion of the transmission or if the transmission fails, a status dialog opens.

- ✧ Click **OK**.

The status dialog closes.

Index

A

ANSI 34, 36, 93
Application 18, 59, 62, 66
Application template 18, 50, 66

B

Base module 53
Basic configuration 50
Bay 37, 41, 103
Binary input 73
Binary output 73
Busbar 37, 95

C

Cell 74, 79
CFC 85, 87, 88
Circuit breaker 37, 59
Collapsed 74
Column 74, 79
Column view 74
Command 73
Communication 112, 118, 126, 128, 130, 131
Communication channel 115
Communication connection 126
Communication mapping 118
Communication module 112, 115
Communication protocol 112
Compact 12
Configuration 53, 126
Configuring 45, 115
Confirmation ID 126
Connect 59
Connecting 129
Connection 100, 121, 126, 131
Connection password 126
Connection type 62
Connector 85
Consistency 126
Continuous Function Chart 85, 87
Continuous Function Chart (CFC) Editor 85
Control flow 85

Cyclical 87

D

Data conversion 85
Data flow 85
Decimal parameter 107
Derivation 85
Destination 73, 79, 80
Device and Network Editor 45, 112
Device application 59
Device characteristics 50
Device configuration 126
Device functionality 134, 138, 142
Device I/O 74
Device information 71
Device menu 73, 73, 74
Device type 138
Device view 112, 115
Display 93
Display Editor 93
Display page 95, 100, 103
Display profiles 74
Document data 13
Dynamic 100

E

Editor 26
Element 66
Equipment 37, 59, 95
Ethernet 126
Ethernet connection 121
Ethernet interface 50, 115
Ethernet-based 112
Event-log buffer 73
Event-triggered 87
Expanded 74
Expansion module 53

F

Failure indication 85

Fault record 73
Filter 74
Function 57, 66, 85, 104, 107, 110
Function block 57, 66, 85, 88
Function group 57, 59, 66
Function key 73
Function points 0, 20
Function-point class 50, 134, 136
Function-point status 71
Functional scope 15, 66

G

Graphic 93
Graphics function 110
Graphics window 110
Group indication 85

H

Hardware 53
Hardware catalog 53

I

Icon 34, 36, 93
IEC 34, 36, 93
Image 15
Importing 45
Indication 73
Information 73, 80, 85
Information routing 73, 74
Information type 79
Initializing 128
Inspector window 25, 104
Integrated Ethernet interface 50, 134
Interconnecting 88
Interface 57, 121
Interlocking 85
IP address 121
Isolating 131

K

Keypad 79

L

LED 73

License file 134, 142
Loading 142
Long product code 17

M

Mapping parameters 118
Matrix 74
Measured values 73, 74
Measuring point 62
Menu bar 21
Menu item 73
Metered value 73, 74
MLFB 17
Module 112
Modus 106
Monitor 74

N

Name plate 135
Network protocol 112
Network structure 112, 121
Network view 112, 121

O

Object bar 21
Offline 13
Offline configuration 126, 128, 129, 130, 136
On-site operation panel 93
Online 13
Online configuration 126
Operate curve 110
Order configurator 17, 17

P

Page 93
Parameter Editor 104
Parameters 104, 106, 107, 110
Percentage value 106
Physical 15
Position display 100
Premium 12
Primary topology 34
Primary value 106
Process level 87
Product code 45, 45, 126
Project 13, 31
Project content 13

Project language 13
Project text 13
Project tree 13, 21
Protection function 104, 107, 110
Protection interface 115
Protocol 112, 115, 118

R

Representation 46
Resource consumption 71
Routing 73, 74, 79, 80, 118
Routing type 79

S

Secondary value 106
Serial 112
Serial number 134, 135, 138
Settings group 104
Shipping method 138
Short product code 17
Sidebar 85
Siemens SAP system 134
Signal 88, 100, 118
Signal Catalog 100
Significant feature 50, 134
Single-line configuration 34, 37, 41, 57, 66, 103
SIPROTEC 5 Configurator 134
SIPROTEC 5 Configurator 138
SIPROTEC 5 device 134
SIPROTEC 5 device 15, 45, 46, 50, 53, 57, 59, 128, 129, 130, 131, 135, 142
Source 73, 79, 80
Standard 12, 34, 36, 93
Starting 31
Static text 95
System communication 112

T

Task card 24
Template 41
Terminal 53
Test Suite 12
Text 95
Text parameter 107
Toolbar 21
Transferring 126
Transformer 37, 59
Transmitting 130, 142
Tripping 74
Tripping stage 66

U

Update 134
Updating 134
USB 126
User interface 21
User interface language 31
User preferences 36

V

Value display 100
Variant 12
View 74, 74
Voltage variant 50

W

Working area 23, 74

Z

Zone diagrams 110

