

SIEMENS



SIMATIC

S7-1500 / ET 200MP

Automation system

In a nutshell

Edition

11/2015

Answers for industry.

1 Comparison of SIMATIC automation systems

The table below compares the main technical specifications of the SIMATIC systems.

	SIMATIC S7-1200	SIMATIC ET 200SP CPU	SIMATIC S7-1500
Data work memory, max.	150 kB	1 MB	20 MB
Code work memory, max.		200 kB	6 Mbyte
Load memory/mass storage max.	4 Mbyte	2 Gbyte (via memory card)	2 Gbyte (via memory card)
I/O address area, max.	1024 / 1024 bytes	1024 / 1024 bytes	32 / 32 Kbyte
Integrated interfaces, max.	1 x PROFINET IO (2-port switch)	1 x PROFINET IO (2-port switch) 2 x PROFINET	1 x PROFINET IO (2-port switch) 2 x PROFINET 1 x PROFIBUS
Controller with integrated inputs and outputs	X	---	C-CPU
Configuration control	---	X	X
Web server	X	X	X
Isochronous mode	---	X	X
Integrated display	---	---	X
Technology integrated	Up to 8 axes Speed specification Positioning Integrated controllers	Up to 6 axes Speed specification Positioning Synchronous operation Integrated controllers	Up to 128 axes Speed specification Positioning Synchronous operation Integrated controllers
Security integrated	X	X	X
Integrated system diagnostics	X	X	X
Integrated safety functionality	X	X	X

2 Component selection

2.1 Quickly find the right component

To configure a SIMATIC S7-1500 automation system, select the appropriate components according to performance, configuration limits, communication interfaces and the size of the application. Below you can find an initial overview for component selection:

1. Mounting rail



Select:

- Length of the mounting rail

You can find all relevant information in [Section 6](#).

2. Controller



Select:

- CPU/F-CPU
- Mounting size
- Number of PROFIBUS/PROFINET interfaces
- Suitable work memory

You can find all relevant information in [Section 7](#).

3. Input/output modules



Select:

- Number of inputs/outputs
- Direct voltage/alternating voltage
- Measuring function
- Output function
- Type of temperature measurement

You can find all relevant information in [Section 9](#).

4. Communication modules



Select:

- Bus system
- Communication interfaces
- Protocols for data exchange

You can find all relevant information in [Section 10](#).

5. Technology functions



Select:

- Motion Control
- Counting
- Positioning
- Time-based IO

You can find all relevant information in [Section 11](#).

6. Power supply



Select:

- Load power supply
- System power supply

The system power supply provides the system voltage and can also provide power to the CPU and interface modules. For larger plants, a load power supply is required in addition.

You can find all relevant information in [Section 12](#).

7. Connection elements



Select:

- Front connector for flexible wiring
- Shield terminals and shield brackets for connecting cable shields

You can find all relevant information in [Section 13](#).

8. HMI devices for the visualization



Select:

- HMI devices for the visualization of process and process control

You can find an overview of the available HMI devices in the [Industry Mall](#).

9. Software

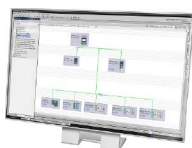

Select:

- TIA Portal with SIMATIC STEP 7, SIMATIC WinCC and SINAMICS Startdrive
- Option packages, for example STEP 7 Safety Advanced.

You can find all relevant information in [Section 14](#).

2.2 TIA Selection Tool

The [TIA Selection Tool](#) supports you in the selection of the components, the configuration of your system, and ordering.

3 The SIMATIC automation systems

You need optimum solutions for every application in order to automate your machines and plants economically and flexibly.

The SIMATIC family includes a variety of systems:

- If plant complexity and system performance are priorities, the SIMATIC S7-1500 automation system is the right choice for you. The SIMATIC S7-1500 controller builds on the more simple functionality of the SIMATIC S7-1200 Basic controller.
- With the SIMATIC ET 200SP distributed controller, you can also use the functionality of an S7-1500 with the ET 200SP design, for example, to extend your system or operate a standalone system.

The SIMATIC controllers are integrated into the Totally Integrated Automation Portal and offer consistent data management and a uniform operating concept. With its integrated functions, engineering in the TIA Portal ensures consistent functionality.

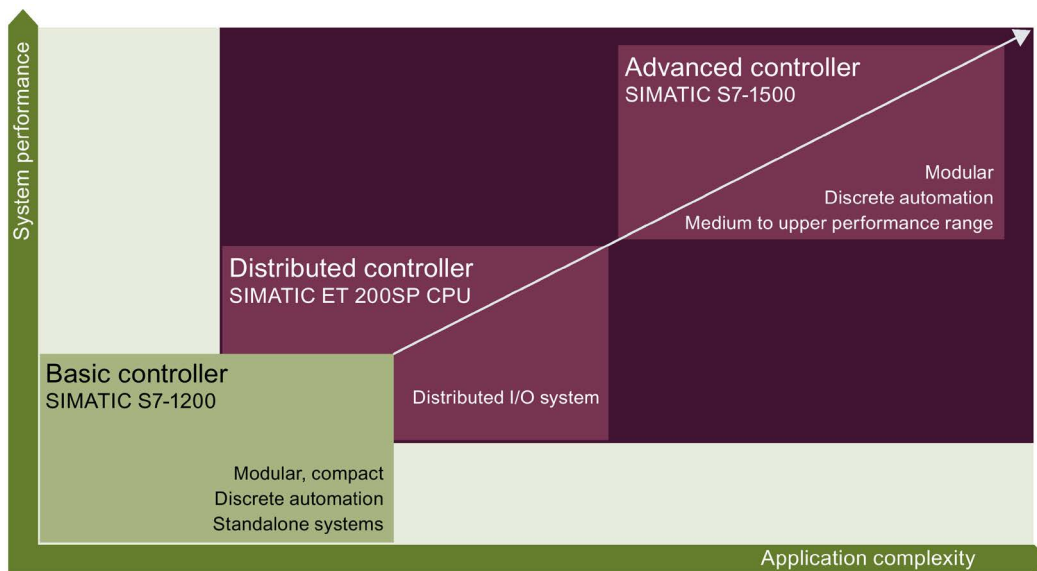

Overview of SIMATIC automation systems

The SIMATIC S7-1500 automation system supports all conventional communication standards. Motion control is possible via the integrated technological functions of SIMATIC S7-1500.

The SIMATIC S7-1500 controllers are also available as fail-safe controllers. Diagnostic functions across all components simplify troubleshooting. Changes to the parameter assignment can be implemented quickly and easily with the integrated display.

Integrated security functions offer additional security mechanisms for the configuration of secured networks.

4 Overview of SIMATIC S7-1500 system

4.1 Plant components and automation levels

The SIMATIC S7-1500 automation system complies with the high requirements on performance, integration and fail-safety. The combination of the individual SIMATIC components offers powerful and flexible automation solutions that cover all ranges of control applications:

- The process signals are connected to the central controller via fieldbus
- All modules are located directly in the automation system or in the distributed I/O system
- F-CPU's with integrated safety functionality ensure fail-safe processes
- SIMATIC S7-1500 is intended for installation in the control cabinet and achieves the degree of protection IP20

The SIMATIC S7-1500 is integrated across all communication standards consistently in the various automation levels.

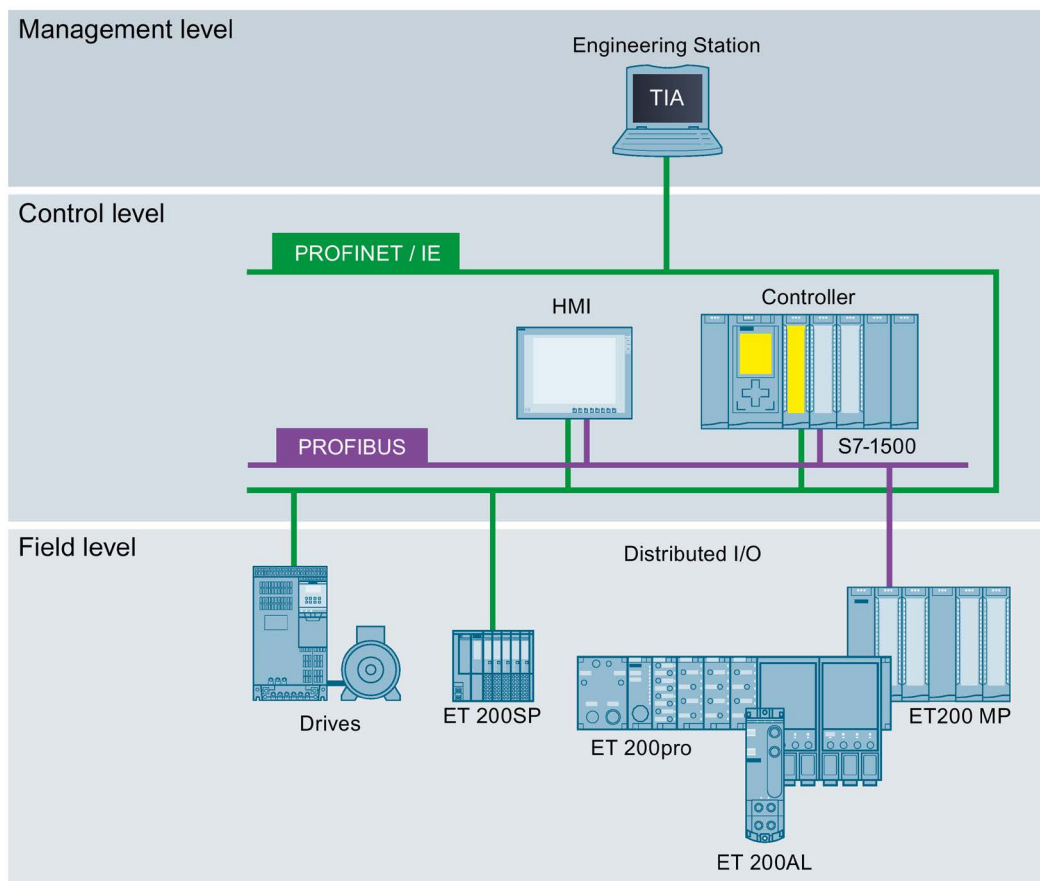

Basic structure: SIMATIC S7-1500 at management, control and field level

You can also find an overview of the SIMATIC S7-1500 automation system on the [Internet](#).

4.2 Scalability

The SIMATIC S7-1500 automation system provides a scalable solution to meet your plant design requirements. Safety Integrated, Motion Control, and other technology functions can be used for all plant sizes.

SIMATIC S7-1500 standalone system

SIMATIC S7-1500 with compact CPU 1511C is cost-optimized and efficient. Digital and analog channels as well as fast counter functions are already integrated in the CPU. The compact controller saves a great deal of space and can be used in small to medium-sized applications.

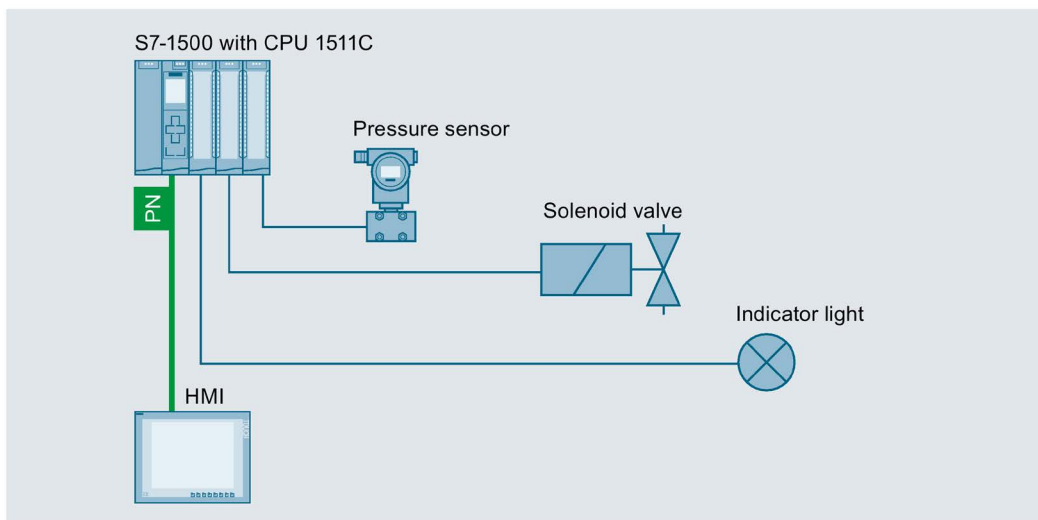

Example: Plant configuration with SIMATIC S7-1500 with integrated I/O

SIMATIC S7-1500 compact system

SIMATIC S7-1500 with CPU 1511-1 is the standard for small to medium-sized applications. A SIMATIC ET 200SP distributed I/O system is connected in the configuration example.

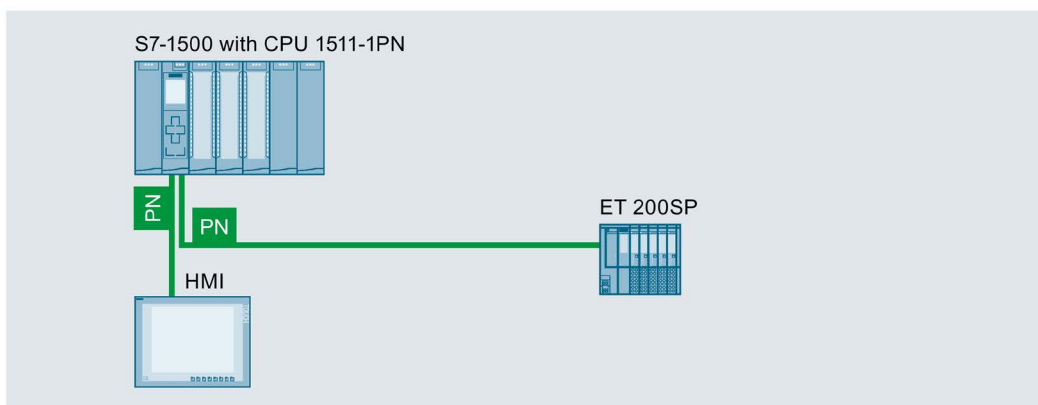

Example: Plant configuration with SIMATIC S7-1500, ET 200SP and HMI device

SIMATIC S7-1500 standard system

SIMATIC S7-1500 with CPU 1516-3 PN/DP is used for demanding applications and communication tasks.

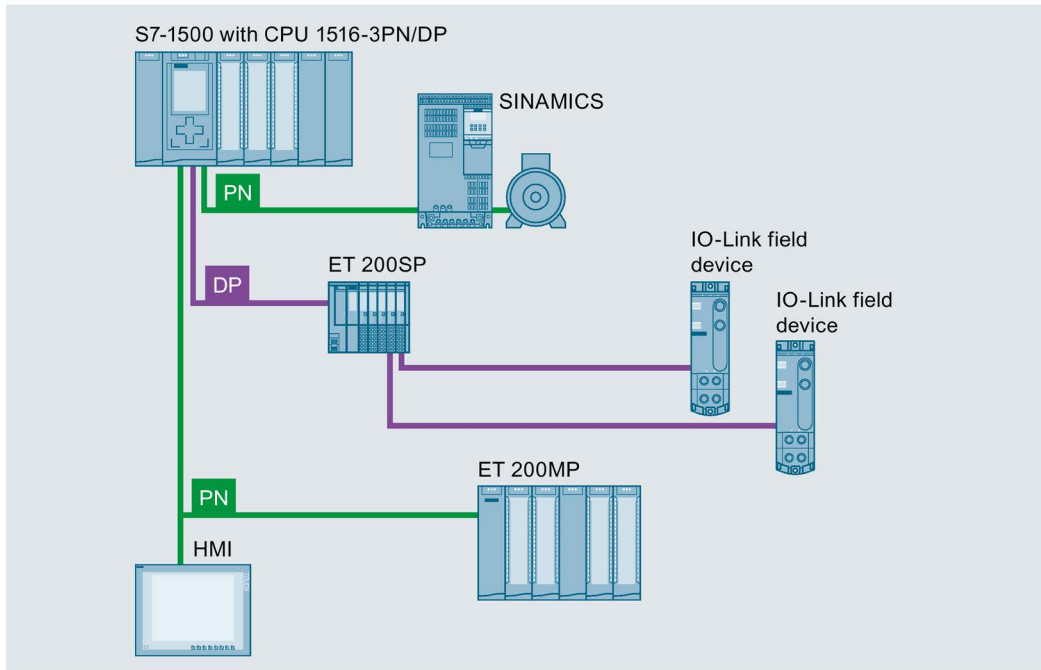

Example: Plant configuration with SIMATIC S7-1500, motion control and distributed I/O

Large plant with safety and WLAN-integration

With safety-related applications via PROFINET communication and WLAN functionality, you can plan large plants with high requirements on communication and fail-safety.

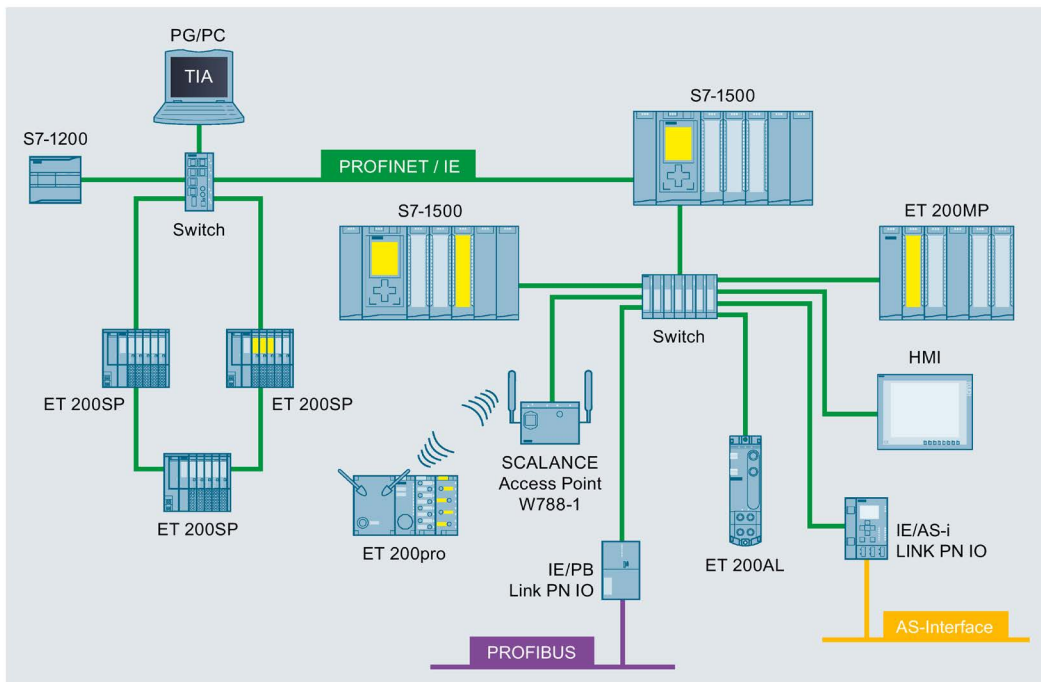

Example: Plant configuration with SIMATIC S7-1500 and Safety on PROFINET

5 Installation conditions

5.1 Structure

The modular SIMATIC S7-1500 controllers are optimized in their structure for control tasks and specially designed for ruggedness and long-term availability. The configuration consists of CPU and I/O modules. Depending on the size of the plant, additional system power supply modules supplement the configuration. The SIMATIC S7-1500 automation system can also be powered via additional load power supply modules.

Sample configuration of SIMATIC S7-1500 system

The SIMATIC S7-1500 automation system consists of a single-row configuration in which all modules are installed on one mounting rail. The modules are connected by means of U connectors, and thus form a self-assembling backplane bus.

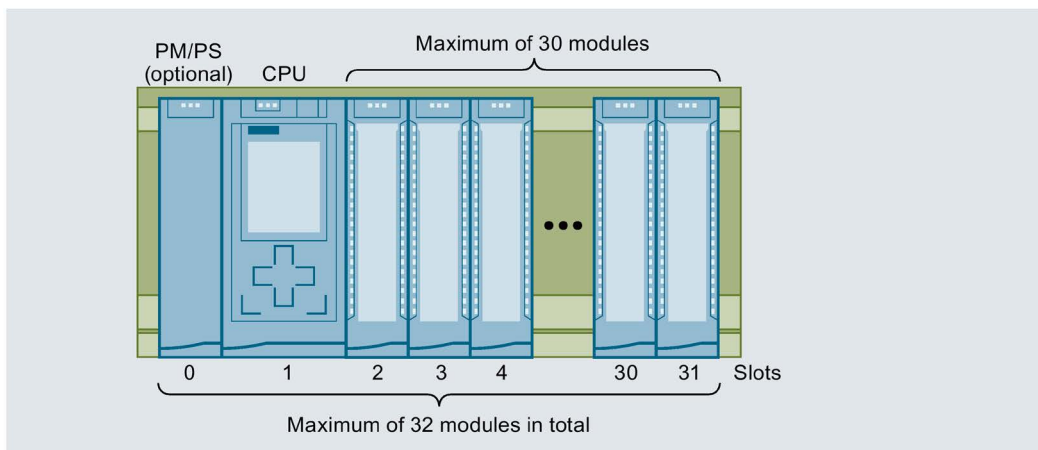

Maximum configuration of SIMATIC S7-1500 automation system

SIMATIC S7-1500 slots

The table below shows the available module types as well as the slot rules for each module type and the maximum number of plug-in modules.

Module type	Slots	Max. number of modules
Load power supply (PM) (No connection to the backplane bus)	0	Unlimited / only 1 PM can be configured in STEP 7
System power supply (PS)	0; 2 - 31	3
CPU	1	1
Analog and digital I/O modules	2 - 31	30
Communication modules		
Point-to-point	2 - 31	30
PROFINET / PROFIBUS		
CPU 1511-1 PN	2 - 31	4
CPU 1513-1 PN	2 - 31	6
CPU 1515-2 PN	2 - 31	8
CPU 1516-3 PN/DP	2 - 31	8
CPU 1517-3 PN/DP	2 - 31	8
CPU 1518-4 PN/DP	2 - 31	8
Technology modules	2 - 31	30

Sample configuration of ET 200MP distributed I/O system

A SIMATIC S7-1500 automation system consists of a maximum of 32 modules, which occupy slots 0 to 31. You can use interface modules to add additional I/O modules to the ET 200MP distributed I/O system.

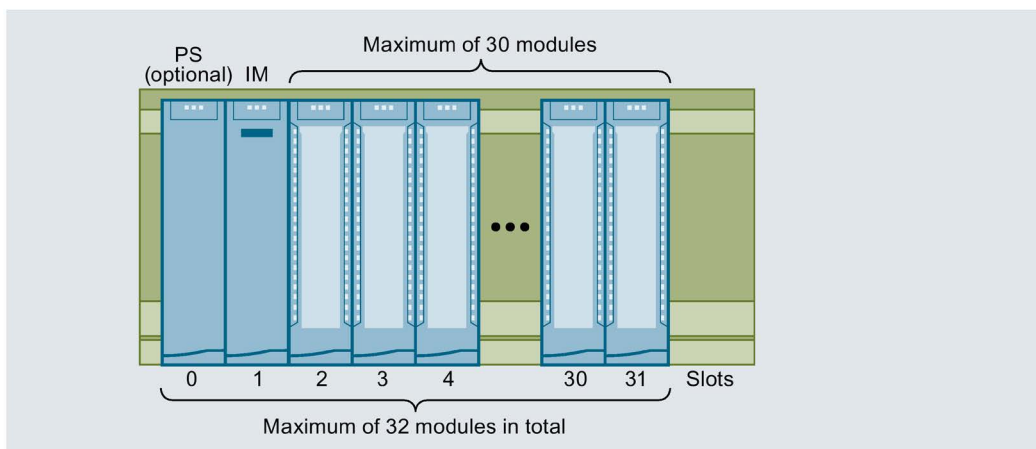

Maximum configuration of SIMATIC ET 200MP distributed I/O system

SIMATIC ET 200MP slots

The table below shows the available module types depending on the interface used as well as the slot rules per module type and the maximum number of plug-in modules.

Module type	PN/DP	Slots	Max. number of modules
System power supply (PS)	PN	0; 2 - 31	3
	DP	-	-
Interface module (IM)	PN	1	1
	DP	1	1
Analog and digital I/O modules	PN	2 - 31	30
	DP	3 - 14	12
Point-to-point communication module	PN	2 - 31	30
	DP	3 - 14	12
Technology modules	PN	2 - 31	30
	DP	3 - 14	12

5.2 Mounting position and ambient conditions

The SIMATIC S7-1500 automation system and the ET 200MP distributed I/O system support horizontal and vertical mounting positions.

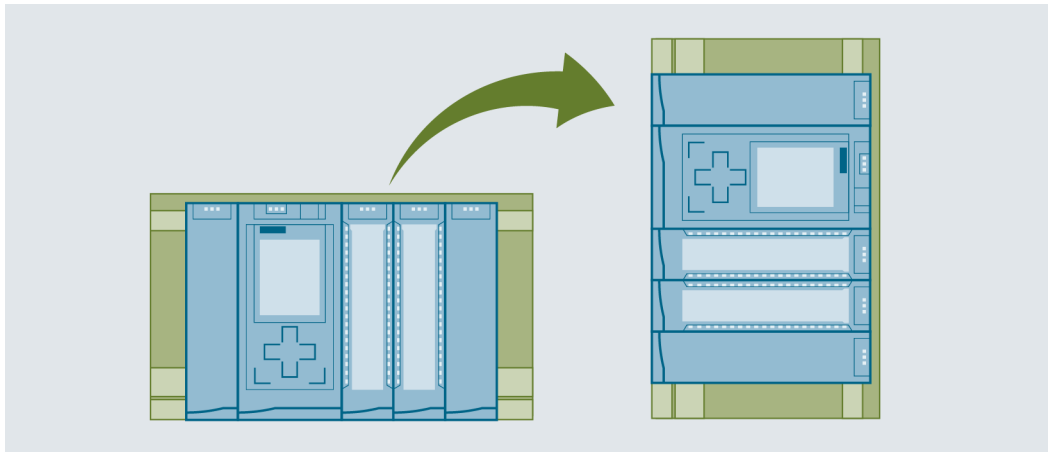

Horizontal/vertical mounting position using SIMATIC S7-1500 as an example

Ambient conditions SIMATIC S7-1500 and ET 200MP

The table below shows the permissible ambient conditions depending on the mounting position.

	Horizontal mounting position	Vertical mounting position
Permissible temperature range	0 °C to 60 °C	0 °C to 45 °C
Temperature change	10 K/h	10 K/h
Relative humidity	10 % to 95 %	10 % to 95 %

5.3 Minimum clearances

With the SIMATIC S7-1500 automation system, all modules can be mounted up to the outer edge of the mounting rail. Note the following minimum clearances:

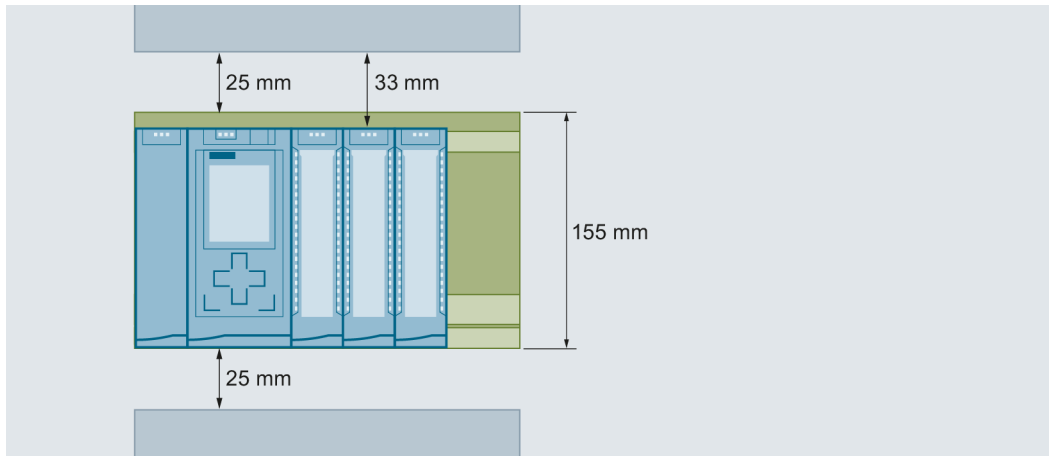

Minimum clearances in the control cabinet

6 Mounting rail

The figure below shows the SIMATIC S7-1500 mounting rail.

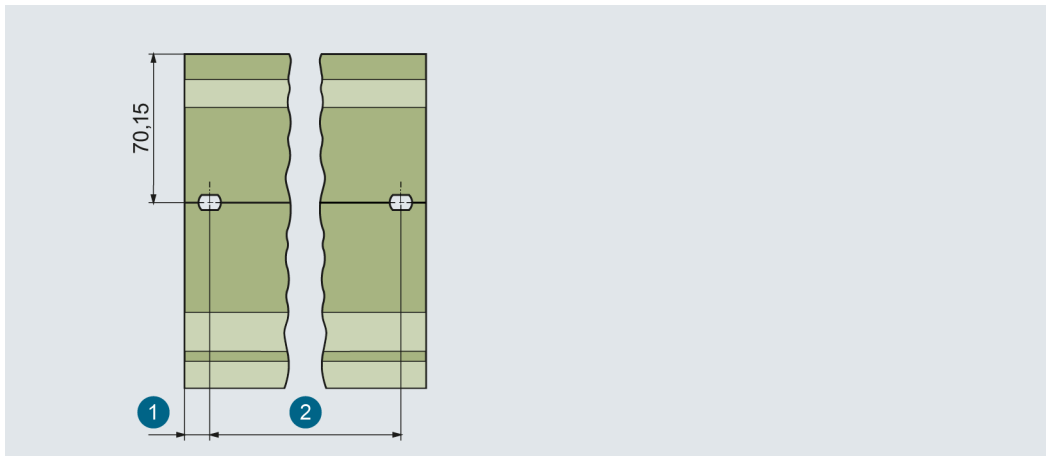

Hole spacing and distance from edge for SIMATIC S7-1500 mounting rail

- ① Distance from edge
- ② Hole spacing

Dimensions of SIMATIC S7-1500 mounting rails

The table below shows the dimensions of the available mounting rails and their article numbers.

Length of the mounting rail	Distance from edge ①	Hole spacing ②	Article number
160 mm	10 mm	140 mm	6ES7590-1AB60-0AA0
245 mm	10 mm	225 mm	6ES7590-1AC40-0AA0
482.6 mm	8.3 mm	466 mm	6ES7590-1AE80-0AA0
530 mm	15 mm	500 mm	6ES7590-1AF30-0AA0
830 mm	15 mm	800 mm	6ES7590-1AJ30-0AA0
2000 mm (without drill holes)	15 mm	500 mm	6ES7590-1BC00-0AA0

7 Controller



The controller (CPU) executes the user program. The integrated system power supply of the controller provides power to the modules used through the backplane bus.

A fail-safe version is available for each SIMATIC S7-1500 controller. To use the safety functions in the TIA Portal, you need the "STEP 7 Safety Advanced" option package.

During commissioning of the plant, you can change the IP address of the CPU directly via the display, thus saving time and costs. In the event of a service call, the plant downtimes are minimized by quick access to diagnostics alarms.

For effective commissioning and fast optimization of drives and controls, the SIMATIC S7-1500 supports extensive trace functions for all CPU tags.

A SIMATIC S7-1500 controller also offers additional functions:

- Communication via Ethernet/PROFINET
- Communication via PROFIBUS
- HMI communication
- Web server, technology functions, system diagnostics, protection functions integrated
- When using an F-CPU: Safety mode

7.1 What can you do with the CPU?

SIMATIC S7-1500 provides you with a variety of CPUs that can be integrated. You can expand each CPU with I/O, communications and technology modules. If the memory and performance of a CPU 1511-1 PN, for example, are sufficient for you, simply expand this with communication modules for PROFIBUS and PROFINET. For technology functions, technology modules are available in addition to compact CPUs.



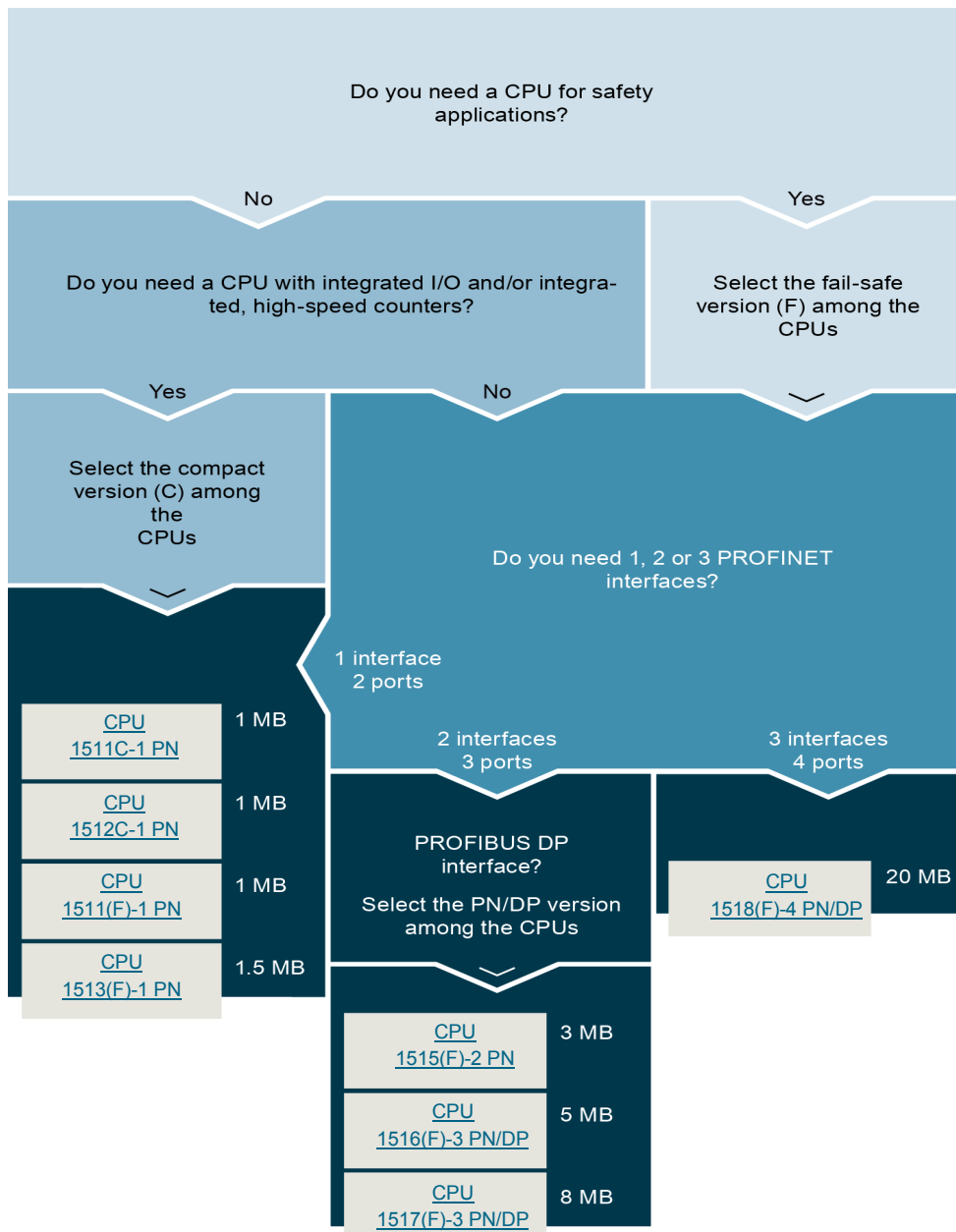









The CPU provides you with the following options:





Selection guide for CPUs

7.2 Technical specifications of CPUs

Standard-CPU and F-CPU

CPU	1511-1 PN	1513-1 PN	1515-2 PN	1516-3 PN/DP	1517-3 PN/DP	1518-4 PN/DP
	1511F-1 PN	1513F-1 PN	1515F-2 PN	1516F-3 PN/DP	1517F-3 PN/DP	1518F-4 PN/DP
Article number						
Standard-CPU	6ES7511-1AK00-0AB0	6ES7513-1AL00-0AB0	6ES7515-2AM00-0AB0	6ES7516-3AN00-0AB0	6ES7517-3AP00-0AB0	6ES7518-4AP00-0AB0
F-CPU	6ES7511-1FK00-0AB0	6ES7513-1FL00-0AB0	6ES7515-2FM00-0AB0	6ES7516-3FN00-0AB0	6ES7517-3FP00-0AB0	6ES7518-4FP00-0AB0
Manual						
Standard-CPU						
F-CPU						
Supply voltage, permissible range of all CPUs			19.2 V DC to 28.8 V DC			
Code work memory						
Standard-CPU	150 kbyte	300 kbyte	500 kbyte	1 Mbyte	2 Mbyte	4 Mbyte
F-CPU	225 kbyte	450 kbyte	750 kbyte	1.5 Mbyte	3 Mbyte	6 Mbyte
Data work memory	1 Mbyte	1.5 Mbyte	3 Mbyte	5 Mbyte	8 Mbyte	20 Mbyte
Processing times						
Bit-operations	0.06 µs	0.04 µs	0.03 µs	0.01 µs	0.002 µs	0.001 µs
Word-operations	0.072 µs	0.048 µs	0.036 µs	0.012 µs	0.003 µs	0.002 µs
Interfaces						
PROFINET IO	1	1	1	1	1	1
PROFINET	---	---	1	1	1	2
Number of PROFINET-ports	2	2	3	3	3	4
PROFIBUS DP	---	---	---	1	1	1
Technology						
Axes motion Control	6	6	30	30	96	128
Isochronous mode	X	X	X	X	X	X
Web server	X	X	X	X	X	X

Compact CPUs

Controller	1511C-1 PN	1512C-1 PN
Article number	6ES7511-1CK00-0AB0	6ES7512-1CK00-0AB0
Manual		
Supply voltage, permissible range	19.2 V DC to 28.8 V DC	19.2 V DC to 28.8 V DC
Code work memory	175 kbyte	250 kbyte
Data work memory	1 Mbyte	1 Mbyte
Processing time for bit operations	60 ns	48 ns
PROFINET interfaces	1	1
Number of PROFINET ports	2	2
Integrated analog inputs/outputs	5 inputs/2 outputs	5 inputs/2 outputs
Integrated digital inputs/outputs	16 inputs/16 outputs	32 inputs/32 outputs
Technology		
Motion control axes	6	6
Isochronous mode	X	X
High-speed counters	6	6
Web server	X	X

Code work memory: Volatile memory that contains runtime-relevant parts of the program code.

Data work memory: Volatile memory that contains the runtime-relevant parts of the data blocks and technology objects.

7.3 Safety

For fail-safe operation of your plant, program the F-CPU of the SIMATIC S7-1500. Use the "STEP 7 Safety Advanced" option package of the TIA Portal for this purpose. In combination with the TIA Portal, the F-CPU offers optimal integration of fail-safe systems:

- Integration of safety technology
- Instructions approved by German Technical Inspectorate for frequently required safety applications
- Integration of safety functions up to SIL 3 according to IEC 62061 and/or PL e according to EN ISO 13849-1
- Uniform engineering for standard and safety automation
- Simple documentation of changes
- Support in the acceptance of the safety program and no renewed acceptance of the safety program after changes in the standard program

7.4 Security

To set up secure networks, the SIMATIC S7-1500 automation system offers an integrated security concept from authorization levels up to block protection:

Degree of protection	Description
Access protection	Protection against unauthorized configuration changes through four authorization levels and integrated firewall
Know-how protection	Protection against unauthorized access and modifications to algorithms by means of password protection
Copy protection	Protection against duplication of programs by linking individual blocks with the serial number of the original memory card on the SIMATIC memory card
Locking the CPU	Protection against unauthorized access by locking the front cover with a seal or a lock

7.5 Diagnostics

Integrated diagnostics across all levels of the automation is incorporated in the SIMATIC S7-1500 automation system. All SIMATIC products have integrated diagnostic functions which you can use to detect and remedy faults.

A uniform display concept ensures that error messages in the TIA Portal, on the HMI, the Web server and in the display of the CPU are visualized identically as plain text information.

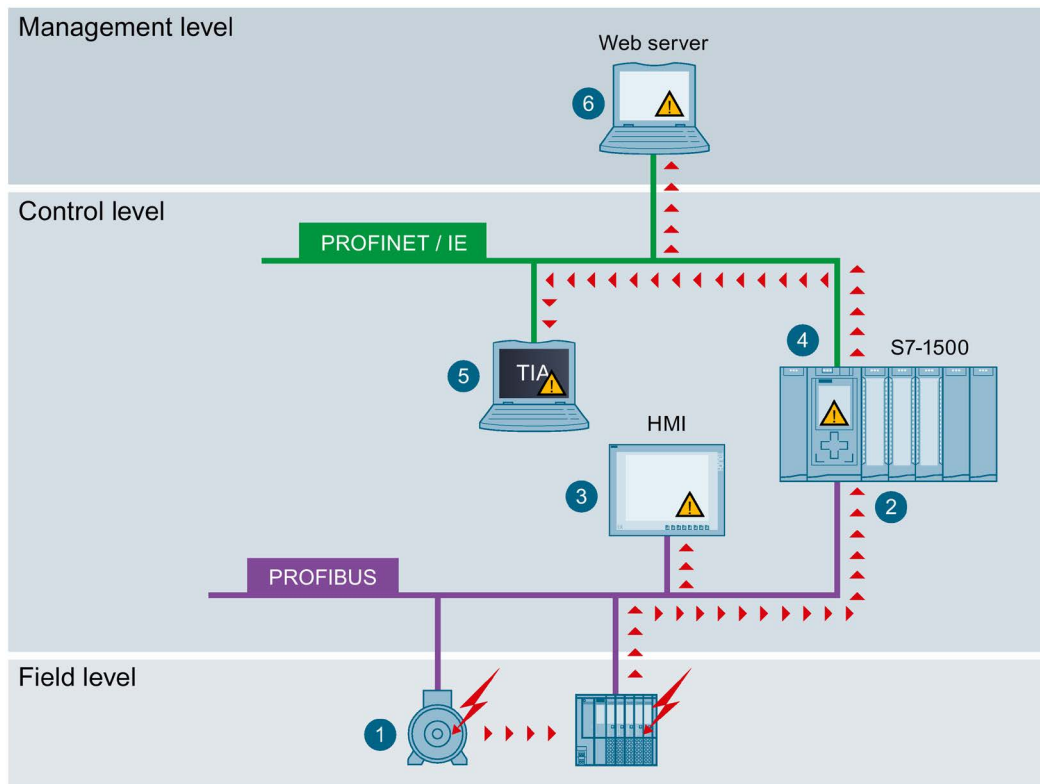

Display of diagnostic information

- 1 Monitoring functions are integrated in the hardware as standard.
- 2 Diagnostics is implemented system-wide across bus limits.
- 3 Output of the cause of the error in plain text, archiving and logging of alarms
- 4 Automatic localization of the error source
- 5 Configurability of alarms
- 6 Plant-wide, uniform display of system status

Faults in the plant are immediately detected and reported on the display devices, even in STOP mode. As a result, system diagnostics is always consistent with the actual state of the plant.

8 Interface modules for SIMATIC S7-1500 I/O devices

An interface module connects the SIMATIC S7-1500 I/O devices as ET 200MP distributed I/O system via PROFINET or PROFIBUS with the controller.

Interface modules

Short designation	IM 155-5 PN HF IM 155-5 PN ST	IM 155-5 DP ST
Article number		
High Feature (HF)	6ES7155-5AA00-0AC0	---
Standard (ST)	6ES7155-5AA00-0AB0	6ES7155-5BA00-0AB0
Manual		
High Feature (HF)		---
Standard (ST)		
Supply voltage	24 V DC	24 V DC
Number of IO modules	30	12
Interfaces	1 x PROFINET IO; integrated 2-port switch	1 x PROFIBUS
Min. slave interval	---	100 µs
Isochronous real-time communication (IRT)	X	---
Isochronous mode	X (shortest cycle 250 µs)	---
Prioritized startup	X	---
Device replacement without programming device	X (LLDP; address assignment by a tool, for example, the TIA Portal)	---
Shared device		
High Feature (HF)	4 IO controllers	---
Standard (ST)	2 IO controllers	---
Identification data	I&M 0 to 3	I&M 0 to 3
Media redundancy (MRP)	X	---
Media redundancy with planned duplication (MRPD)		
High Feature (HF)	X	---
Standard (ST)	---	---
System redundancy on S7-400H		
High Feature (HF)	With GSD file and STEP 7 V5.5 SP3 or higher	---
Standard (ST)	---	---
GSD file for ET 200MP	PROFINET	PROFIBUS

9 Inputs/outputs

The I/O modules form the interface between the controller and the process. The controller detects the current process state via the connected sensors and actuators, and triggers the corresponding reactions.



Digital and analog modules provide the inputs/outputs that are required for the respective task.

The input/output modules are divided into function classes.

Function classes of input/output modules

The table below shows selected properties and technical specifications of different function classes of input/output modules.

Function class		
High Speed (HS)	<ul style="list-style-type: none"> Special modules for extremely fast applications Shortest input delays Shortest conversion times Isochronous mode 	
High Feature (HF)	<ul style="list-style-type: none"> Flexible use Even for complex applications Parameters for each channel Diagnostics for each channel Add-on functions 	With analog modules <ul style="list-style-type: none"> Highest accuracy (<0.1%) High common-mode voltage, single channel isolation if necessary
Standard (ST)	<ul style="list-style-type: none"> Medium price range Parameter per load group / module Diagnostics per load group / module 	With analog modules <ul style="list-style-type: none"> Universal modules Accuracy = 0.3% Common-mode voltage approx. 10 V to 20 V
Basic (BA)	<ul style="list-style-type: none"> Inexpensive, simple modules No parameters No diagnostics 	

9.1 Which I/O devices are the correct ones?

SIMATIC S7-1500 offers a wide range of I/O modules. Depending on the complexity of your plant and the technical and functional requirements, you perform your planning flexibly and in a modular manner with SIMATIC components.

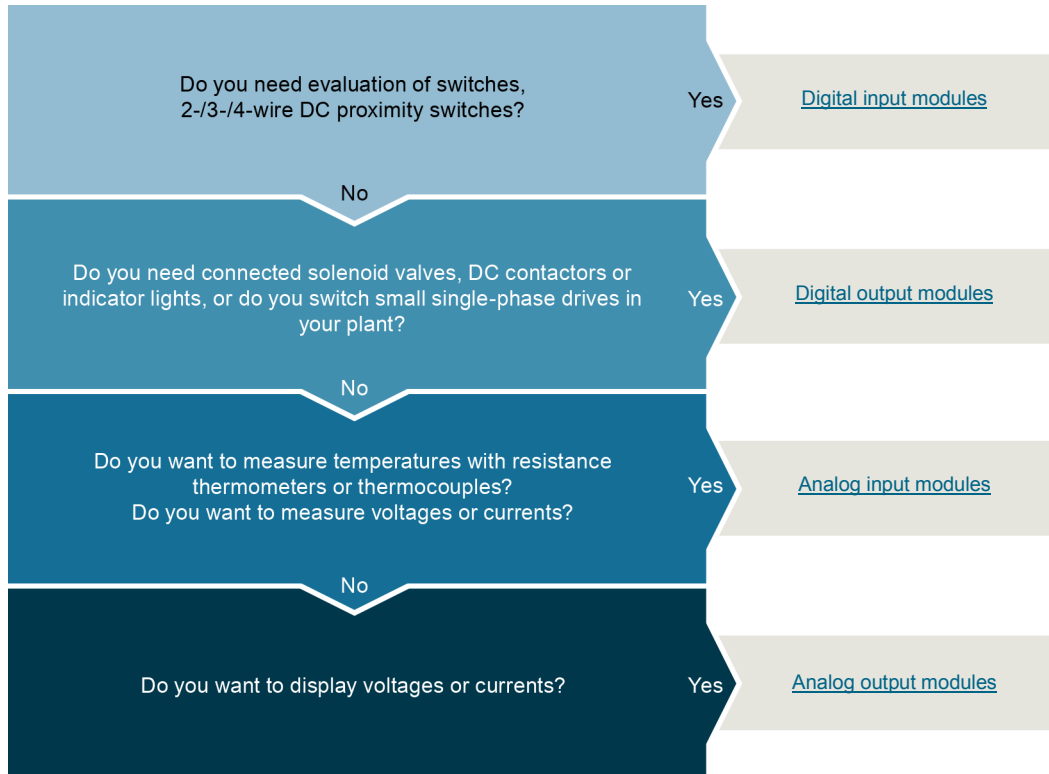

Selection guide for input/output modules







9.2 Digital input modules

Digital input modules and digital input/output module





Short designation	DI 16x24VDC HF DI 16x24VDC BA	DI 32x24VDC HF DI 32x24VDC BA	DI 16x24VDC SRC BA	DI 16x230VAC BA	DI 16x24VDC / DQ 16x24V/0.5A BA
Article number					
High Feature (HF)	6ES7521-1BH00-0AB0	6ES7521-1BL00-0AB0	---	---	---
Basic (BA)	6ES7521-1BH10-0AA0	6ES7521-1BL10-0AA0	6ES7521-1BH50-0AA0	6ES7521-1FH00-0AA0	6ES7523-1BL00-0AA0
Manual					
High Feature (HF)			---	---	---
Basic (BA)					
Width					
High Feature (HF)	35 mm	35 mm	---	---	---
Basic (BA)	25 mm	25 mm	35 mm	35 mm	25 mm
Number of inputs	16	32	16	16	16
Electrical isolation between channels	---	X	---	X	---
Number of potential groups	1	2	1	4	1
Rated input voltage	24 V DC	24 V DC	24 V DC	120/230 V AC	24 V DC
Diagnostic interrupt	Only with HF	Only with HF	---	---	---
Hardware interrupt	Only with HF	Only with HF	---	---	---
Isochronous mode	Only with HF	Only with HF	---	---	---
Input delay					
High Feature (HF)	0.05 ms to 20 ms (configurable)	0.05 ms to 20 ms (configurable)	---	---	---
Basic (BA)	Typ. 3 ms (fixed)	Typ. 3 ms (fixed)	Typ. 3 ms (fixed)	Typ. 25 ms (fixed)	1.2 ms to 4.8 ms (configurable)
Extended functions	Only with HF: Counting up to 1 kHz	Only with HF: Counting up to 1 kHz	---	---	---

9.3 Digital output modules

Digital output modules and digital input/output module (DC)



Short designation	DQ 8x24VDC/2A HF	DQ 32x24VDC/ 0.5A ST DQ 32x24VDC/ 0.5A BA	DQ 16x24VDC/ 0.5A ST DQ 16x24VDC/ 0.5A BA	DI 16x24VDC / DQ16x24V/0.5A BA
Article number				
High Feature (HF)	6ES7522-1BF00-0AB0	---	---	---
Standard (ST)	---	6ES7522-1BL00-0AB0	6ES7522-1BH00-0AB0	---
Basic (BA)	---	6ES7522-1BL10-0AA0	6ES7522-1BH10-0AA0	6ES7523-1BL00-0AA0
Manual				
High Feature (HF)		---	---	---
Standard (ST)	---			---
Basic (BA)	---			
Width				
High Feature (HF)	35 mm	---	---	---
Standard (ST)	---	35 mm	35 mm	---
Basic (BA)	---	25 mm	25 mm	25 mm
Number of outputs	8	32	16	16
Type	Transistor	Transistor	Transistor	Transistor
Electrical isolation between channels	X	X	X	X
Number of potential groups	2	4	2	2
Rated output voltage	24 V DC	24 V DC	24 V DC	24 V DC
Rated output current	2 A	0.5 A	0.5 A	0.5 A
Diagnostic interrupt	X	Only with ST	Only with ST	---
Hardware interrupt	---	---	---	---
Isochronous mode	---	Only with ST	Only with ST	---

Digital output modules (AC)

Short designation	DQ 8x230V- AC/5A ST Relais	DQ 16x230V- AC/2A ST Relais	DQ 8x230V- AC/2A ST Triac	DQ 16x230V- AC/1A ST Triac
Article number	6ES7522-5HF00-0AB0	6ES7522-5HH00-0AB0	6ES7522-5FF00-0AB0	6ES7522-5FH00-0AB0
Manual				
Width	35 mm	35 mm	35 mm	35 mm
Number of outputs	8	16	8	16
Type	Relais	Relais	Triac	Triac
Electrical isolation between channels	X	X	X	X
Number of potential groups	16	8	8	8
Relay coil supply voltage	24 V DC	24 V DC	---	---
Rated output voltage	24 V DC to 120 V DC / 24 V AC to 230 V AC	24 V DC to 120 V DC / 24 V AC to 230 V AC	230 V AC	230 V AC
Rated output current	5 A	2 A	2 A	1 A
Diagnostic interrupt	X	X	---	---
Hardware interrupt	---	---	---	---





9.4 Analog input modules

Analog input modules and analog input/output module

Short designation	AI 8xU/I HS	AI 8xU/I/RTD/TC ST	AI 4xU/I/RTD/TC ST	AI 4xU/I/RTD/TC/AQ 2xU/I ST
Article number	6ES7531-7NF10-0AB0	6ES7531-7KF00-0AB0	6ES7531-7QD00-0AB0	6ES7531-7QE00-0AB0
Manual				
Width	35 mm	35 mm	25 mm	25 mm
Number of inputs	8	8	4	4
Resolution	16 bits including sign	16 bits including sign	16 bits including sign	16 bits including sign
Measurement type	Voltage, current	Voltage, current, resistance, thermal resistor, thermocouple	Voltage, current, resistance, thermal resistor, thermocouple	Voltage, current, resistance, thermal resistor, thermocouple
Electrical isolation between channels	---	---	---	---
Rated supply voltage	24 V DC	24 V DC	24 V DC	24 V DC
Permissible potential difference between inputs (UCM)	10 V DC	10 V DC	20 V DC	20 V DC
Diagnostic interrupt	X	X	X	X
Hardware interrupt	X Two high limits and two low limits in each case	X Two high limits and two low limits in each case	X Two high limits and two low limits in each case	X Two high limits and two low limits in each case
Isochronous mode	X	---	---	---
Conversion time (per channel)	125 µs, per module, regardless of number of activated channels	9/23/27/107 ms	9/23/27/107 ms	9/23/27/107 ms

9.5 Analog output modules

Analog output modules and analog input/output module

Short designation	AQ 8xU/I HS	AQ 4xU/I ST	AQ 2xU/I ST	AI 4xU/I/RTD/TC/ AQ 2xU/I ST
Article number	6ES7532-5HF00-0AB0	6ES7532-5HD00-0AB0	6ES7532-5NB00-0AB0	6ES7534-7QE00-0AB0
Manual				
Width	35 mm	35 mm	25 mm	25 mm
Number of outputs	8	4	2	2
Resolution	16 bits including sign	16 bits including sign	16 bits including sign	16 bits including sign
Output type	Voltage/current	Voltage/current	Voltage/current	Voltage/current
Electrical isolation between channels	---	---	---	---
Rated supply voltage	24 V DC	24 V DC	24 V DC	24 V DC
Diagnostic interrupt	X	X	X	X
Isochronous mode	X	---	---	---

10 Communication

10.1 Overview

Interfaces for communication via PROFINET and PROFIBUS DP (as of CPU 1516) are already integrated in the CPUs. Additional communication modules enhance the communication capabilities of the SIMATIC S7-1500 with additional functions or interfaces. For your automation task you have the following communication options available via the individual interfaces:

Communication options	PN/IE	DP	Serial
PG communication for commissioning, testing, diagnostics	X	X	---
HMI communication for operator control and monitoring	X	X	---
Data exchange with TCP/IP, UDP, ISO-on-TCP, ISO protocol	X	---	---
Communication via Modbus TCP	X	---	---
Sending process alarms via e-mail	X	---	---
File management and file access via FTP (File Transfer Protocol); CP may be the FTP client and FTP server	X	---	---
S7 communication	X	X	---
Serial point-to-point connection Data exchange via point-to-point with Freepoint, 3964 (R), USS or Modbus protocol	---	---	X
Web server Data exchange via HTTP(S), for example for diagnostics	X	---	---
SNMP (Simple Network Management Protocol)	X	---	---
Time synchronization	X	X	---

10.2 Safety-related communication via fail-safe modules

The figure below provides an overview of the possibilities of safety-related communication via PROFINET IO in SIMATIC Safety fail-safe systems with S7-1500 F-CPUs.

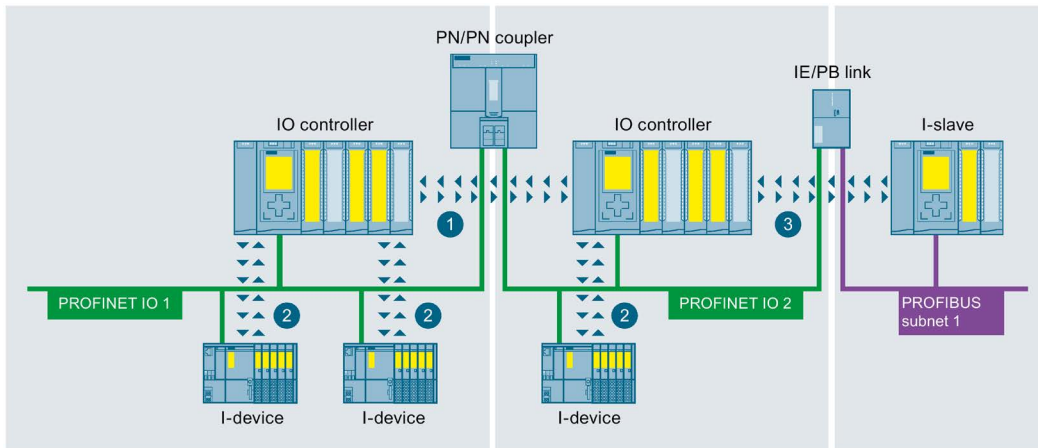

Example of safety-related communication



- 1 Safety-related IO controller - IO controller communication
- 2 Safety-related IO controller - I-device communication
- 3 Safety-related IO controller - I-slave communication

10.3 Communication modules/processors



For special requirements of your plant, use communications processors (CPs) for security functions to secure Industrial Ethernet networks.

If your system requires additional interfaces, communication modules (CM) expand your S7-1500 CPU with other interfaces of an interface type such as PROFINET, PROFIBUS or point-to-point connection. The CMs for point-to-point connection allow, for example, Freeport or Modbus communication via their RS232, RS422 and RS485 interfaces.





Communication modules for PROFINET and Industrial Ethernet

Short designation	CM 1542-1	CP 1543-1
Article number:	6GK7 542-1AX00-0XE0	6GK7543-1AX00-0XE0
Manual		
Bus system	PROFINET	Industrial Ethernet
Interface	RJ45	RJ45
Data transmission rate	10/100 Mbit/s	10/100/1000 Mbit/s
Functionality and protocols	TCP/IP, ISO-on-TCP, UDP, S7 communication, IP Broadcast / Multicast, SNMPv1	TCP/IP, ISO, UDP, S7 communication, IP-Broadcast/Multicast, security, diagnostics SNMPV1/V3, DHCP, FTP client/server, email, IPV4/IPV6
Diagnostic interrupt	X	X
Hardware interrupt	X	---
Isochronous mode	---	---

Communication modules for PROFIBUS

Short designation	CM 1542-5	CP 1542-5
Article number:	6GK7542-5DX00-0XE0	6GK7542-5FX00-0XE0
Manual		
Bus system	PROFIBUS	PROFIBUS
Interface	RS485	RS485
Data transmission rate	9600 bit/s to 12 Mbit/s	9600 bit/s to 12 Mbit/s
Functionality and protocols	DPV1 master/slave, S7 communication, PG/OP communication, open user communication	DPV1 master/slave, S7 communication, PG/OP communication
Diagnostic interrupt	X	X
Hardware interrupt	X	X
Isochronous mode	---	---

Communication modules for point-to-point connection

Short designation	CM PtP RS232 HF CM PtP RS232 BA	CM PtP RS422/485 HF CM PtP RS422/485 BA
Article number		
High Feature (HF)	6ES7541-1AD00-0AB0	6ES7541-1AB00-0AB0
Basic (BA)	6ES7540-1AD00-0AA0	6ES7540-1AB00-0AA0
Manual		
High Feature (HF)		
Basic (BA)		
Interface	RS232	RS422/485
Data transmission rate		
High Feature (HF)	300 to 115 200 bit/s	300 to 115 200 bit/s
Basic (BA)	300 to 19 200 bit/s	300 to 19 200 bit/s
Frame length, max.		
High Feature (HF)	4 kbyte	4 kbyte
Basic (BA)	1 kbyte	1 kbyte
Diagnostic interrupt	X	X
Hardware interrupt	---	---
Isochronous mode	---	---
Protocols		
High Feature (HF)	Freeport, 3964 (R), Modbus RTU master, Modbus RTU slave	Freeport, 3964 (R), Modbus RTU master, Modbus RTU slave
Basic (BA)	Freeport, 3964 (R)	Freeport, 3964 (R)

11 Technology functions

11.1 Motion Control

You use the integrated motion control functionality of SIMATIC S7-1500 for positioning and moving axes. Depending on the [CPU](#), the SIMATIC S7-1500 automation system supports between 6 and 128 axes.

With motion control instructions according to PLCopen, you control PROFIdrive capable drives and drives with analog setpoint interface.

Motion control technology objects

The table below shows the technology objects that are supported by the SIMATIC S7-1500.

Technology objects	SIMATIC S7-1500
Speed-controlled axis	X
Positioning axis	X
Synchronous axis	X
External encoder	X

Motion control technology functions

The table below shows the technology functions of the SIMATIC S7-1500.

Technology functions	SIMATIC S7-1500
Enable/disable axis	X
Acknowledge error/reinitialize	X
Move axis with speed setpoint	X
Move axis in jog mode	X
Pause axis	X
Home axis (absolute and on the fly)	X
Set position	X
Position axis relatively	X
Position axis absolutely	X
Position axis superimposed to active movement	X
Link axes to each other in gearing	X

Motion control configuration example

SINAMIC Startdrive in the TIA Portal provides you with access to the axis control panel and comprehensive online and diagnostic functions that support easy commissioning and optimization of drives.

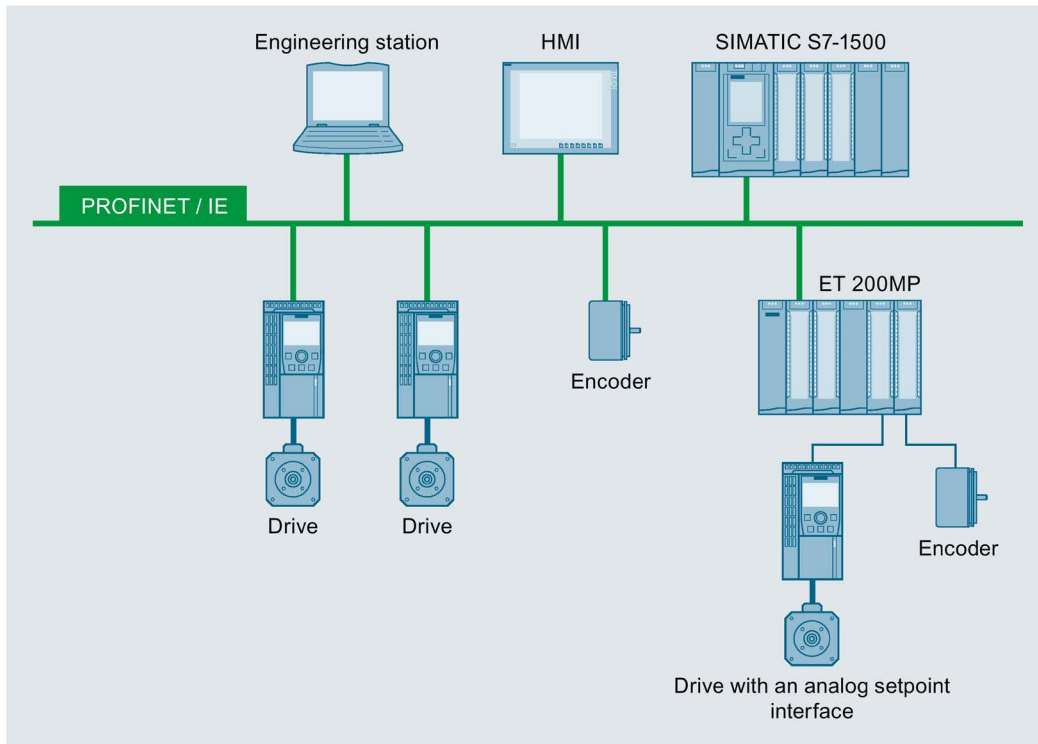

Example of a motion control configuration

11.2 Other technology functions

11.2.1 Integrated compact controllers

PID compact controllers are integrated as standard in all S7-1500 CPUs. In your plant, the PID controller adjusts a physical setpoint and stabilizes it against interferences at the same time. Depending on your plant, you can use different PID controllers. All controllers support the following functions:

- Manageable configuration screens
- Automatic determination of the controller parameters
- Commissioning screens with integrated trace

PID controller versions

PID controllers	Description
PID Compact	Continuous PID controller
PID 3Step	Step controller for integrating actuators
PID Temp	Temperature controller for heating and cooling with two separate actuators

11.2.2 Counting and measuring



Technology functions for counting and measuring are integrated into the SIMATIC S7-1500 compact CPUs.

Function	Value	Description
Six high-speed counters	Up to 100 kHz	For pulse and incremental encoders
Frequency measurement	0.04 Hz - 400 kHz	
Period duration measurement	2.5 μ s - 25 s	
Velocity measurement		Dependent on measurement interval and signal evaluation Unit can be defined by user

11.3 Technology modules

11.3.1 Technology modules for counting, measuring and positioning

For technological tasks, powerful technology modules are available that perform these tasks largely autonomously and reduce the load on the CPU. The table below shows the available technology modules for counting, measuring and positioning.

Short designation	TM Count 2x24V	TM PosInput 2
Article number:	6ES7550-1AA00-0AB0	6ES7551-1AB00-0AB0
Manual		
Connectable encoders	Incremental encoders for signals, 24 V, asymmetric, Pulse encoders with/without direction signal, Pulse encoders up/down	Incremental encoders for signals to RS-422 (5 V differential signal), Pulse encoders with/without direction signal, Pulse encoders up/down, Absolute encoders (SSI)
Max. count frequency	200 kHz: 800 kHz with pulse quadruplication	1 MHz 4 MHz with pulse quadruplication
Integrated DI	3 DIs per counter channel for <ul style="list-style-type: none"> • Start • Stopp • Capture • Synchronization 	2 DIs per counter channel for <ul style="list-style-type: none"> • Start • Stopp • Capture • Synchronization
Integrated DQ	2 DQs for comparators and limit values	2 DQs for comparators and limit values
Counting functions	Comparator Adjustable counting range, Incremental position detection	Comparator Adjustable counting range, Incremental and absolute position detection
Measuring functions	Frequency Period duration Velocity	Frequency Period duration Velocity
Diagnostic interrupt	X	X
Hardware interrupt	X	X
Isochronous mode	X	X

11.3.2 Technology module for time-based IO

Extremely high requirements on precision and speed can be met with time-based IO - regardless of the performance of the controller and the fieldbus. Time-based IO ensures that signals are output with a precisely defined response time. The I/O signals are processed on a time basis. The table below shows the main features of the technology module for time-based IO.

The table below shows the main features of the technology module for time-based IO.

Short designation	TM Timer DIDQ 16x24V
Article number:	6ES7552-1AA00-0AB0
Manual	
Connectable encoders	24 V incremental encoder with signals A and B 24 V pulse encoder with a signal
Max. count frequency	200 kHz with quadruple evaluation
Integrated DI	Up to 8 DIs with the following functions: <ul style="list-style-type: none"> • Up to 2 time stamps per cycle (resolution 1 µs) • 32x oversampling • Counting function up to 50 kHz • Incremental encoder acquisition with 2 phase-shifted tracks • Configurable input filter to suppress interference
Integrated DQ	Up to 16 DQs with the following functions: <ul style="list-style-type: none"> • Up to 2 time stamps per cycle (resolution 1 µs) • 32x oversampling • Pulse-width modulated output • Configurable substitute values per DQ
Diagnostic interrupt	X
Hardware interrupt	---
Isochronous mode	X

12 Power supply

The power supply of an automation system to be dimensioned according to plant size. A system power supply is already integrated in the SIMATIC S7-1500 CPUs. Depending on the plant size, you can expand the integrated system power supply with up to two additional system power supply modules. If your plant has high power requirements, you can also connect load power supply modules. In this case, the CPU/interface module and system power supply feed electricity into the backplane bus. The supplied power is added together.

The main differences between the two power supplies for the SIMATIC S7-1500 automation system are listed below:

Power supply	Description
System power supply (PS)	<p>Supplies only internally required system voltage.</p> <p>Supplies parts of the module electronics and the LEDs.</p> <p>A system power supply can also supply CPUs or interface modules if these are not connected to a 24 V DC load power supply.</p>
Load power supply (PM)	<p>For input and output circuits of the plant's modules, sensors and actuators.</p> <p>The load power supply has no backplane bus.</p> <p>The supply of the CPU or of the interface module with 24 V DC is optional if you supply the voltage for the backplane bus via a system power supply.</p>

Configuration example of a system with load power supply

The following figure shows a system configuration with load power supply and additional system power supply.

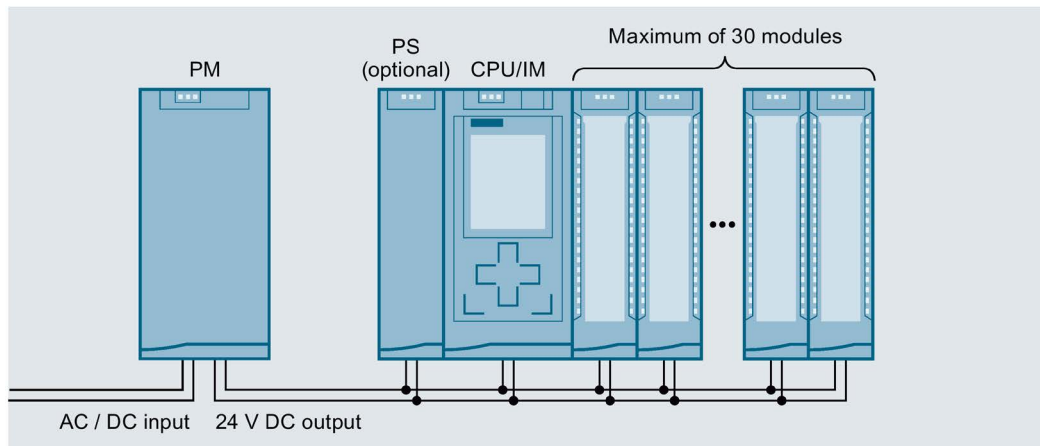



Overall configuration of power supply

In order to ensure the supply of the modules from the backplane bus, the infed power is compared with the required power in the engineering system.

As early as in the planning stages, make sure that the power fed into the backplane bus is always greater than or equivalent to the power drawn.



System power supply modules

System power supplies supply the internal electronics of the S7-1500 modules with power via the backplane bus. The table below shows the available system power supply modules:

Short designation	PS 25W 24V DC	PS 60W 24/48/60V DC	PS 60W 120/230V AC/DC
Article number	6ES7505-0KA00-0AB0	6ES7505-0RA00-0AB0	6ES7507-0RA00-0AB0
Manual			
Rated input voltage	24 V DC	24 V DC, 48 V DC, 60 V DC	120 V AC, 230 V AC 120 V DC, 230 V DC
Output power	25 W	60 W	60 W
Electrical isolation from the backplane bus	X	X	X
Diagnostic interrupt	X	X	X

Load power supply modules

The load power supply modules with automatic range selection of the input voltage are optimally adapted in design and functionality to the SIMATIC S7-1500 controller. The table below shows the available load power supply modules:

Short designation	PM 70W 120/230V AC	PM 190W 120/230V AC
Article number:	6EP1332-4BA00	6EP1333-4BA00
Manual		
Rated input voltage	120/230 V AC, with automatic switchover	120/230 V AC, with automatic switchover
Output voltage	24 V DC	24 V DC
Rated output current	3 A	8 A
Power consumption	84 W	213 W

13 Connection elements

Front connector and shield contact

The front connectors are used to wire the I/O modules. For modules with EMC critical signals, such as analog modules and technology modules, the front connectors also need a shield contact.

The front connectors are available for 35 mm modules with screw terminals and push-in terminals and for 25 mm modules with push-in terminals.

The shield contact consists of shield bracket and shield terminal. Together with the shield terminal, the shield bracket allows the low-impedance connection of cable shields with minimum installation times. The shielding takes place without tools and is included in the scope of delivery.

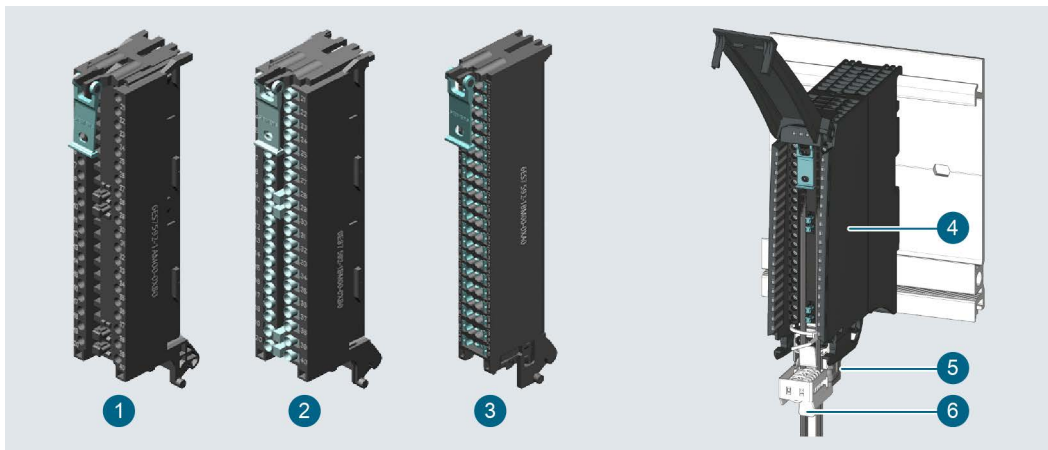

Versions of the front connector with and without shield

- 1 Front connector 35 mm with screw terminals
- 2 Front connector 35 mm with push-in terminals
- 3 Front connector 25 mm with push-in terminals
- 4 Front connector
- 5 Shield bracket
- 6 Shield terminal

14 Software

14.1 TIA Portal

The SIMATIC controllers are integrated into the Totally Integrated Automation Portal. Engineering with the TIA Portal offers configuration and programming, common data storage and a uniform operating concept for control, visualization and drives.

The TIA Portal simplifies the integrated engineering in all configuration phases of a plant.

TIA Portal			
SIMATIC STEP 7 Professional	SIMATIC STEP 7 Safety Advanced	SINAMICS Startdrive	SIMATIC WinCC
Hardware configuration Parameter assignment Networking Programming with LAD, FBD, STL, SCL and Graph Trace Motion control Diagnostics Integrated know-how and copy protection Online-offline comparison of hardware and software components	Fail-safe programming Instructions for frequently required safety applications approved by German Technical Inspectorate (TÜV) Functional signature for user program Support in the acceptance of the safety program	Use of motion control functionality Commissioning for drives Interaction between controller and drives	Visualization with efficient graphics system Intuitive operator control and monitoring Quick access to plant information Flexible availability of plant data Efficient diagnostics in engineering

14.2 SIMATIC Automation Tool

You can use the free [SIMATIC Automation Tool](#) to run commissioning and maintenance activities simultaneously on various SIMATIC S7 stations as bulk operation independently of the TIA Portal. The SIMATIC Automation Tool provides a multitude of functions:

- Scanning of a PROFINET/Ethernet plant network and identification of all connected CPUs
- Address assignment (IP, subnet, gateway) and station name (PROFINET device) to a CPU
- Transfer of the date and the PG/PC time converted to UTC time to the module
- Program download to CPU
- Operating mode switchover RUN/STOP
- Localization of the CPU by means of LED flashing
- Reading out CPU error information
- Reading of CPU diagnostic buffer
- Reset to factory settings
- Updating the firmware of the CPU and connected modules

14.3 PRONETA

With SIEMENS PRONETA (PROFINET network analysis), you analyze the plant network during commissioning. PRONETA features two core functions:

- The topology overview independently scans PROFINET and all connected components.
- The IO check is a fast test of the wiring and the module configuration of a plant.

[SIEMENS PRONETA](#) is also available to you for free on the Internet.

14.4 SIMATIC S7 App

With the [SIMATIC S7 app](#) you can establish a secure connection via WLAN to SIMATIC S7-1500 and ET 200SP with the following functions:

- Detect up to 50 networked CPUs via HTTPS and establish a connection
- Change CPU operating mode (RUN/STOP)
- Read out CPU diagnostics information and send via e-mail
- Monitor and modify variables and tags
- High security through encrypted communication and encrypted profile data; password to start app and establish the connection

15 Additional information

15.1 Documentation of the system

The documentation for the SIMATIC S7-1500 automation system is divided into three areas:

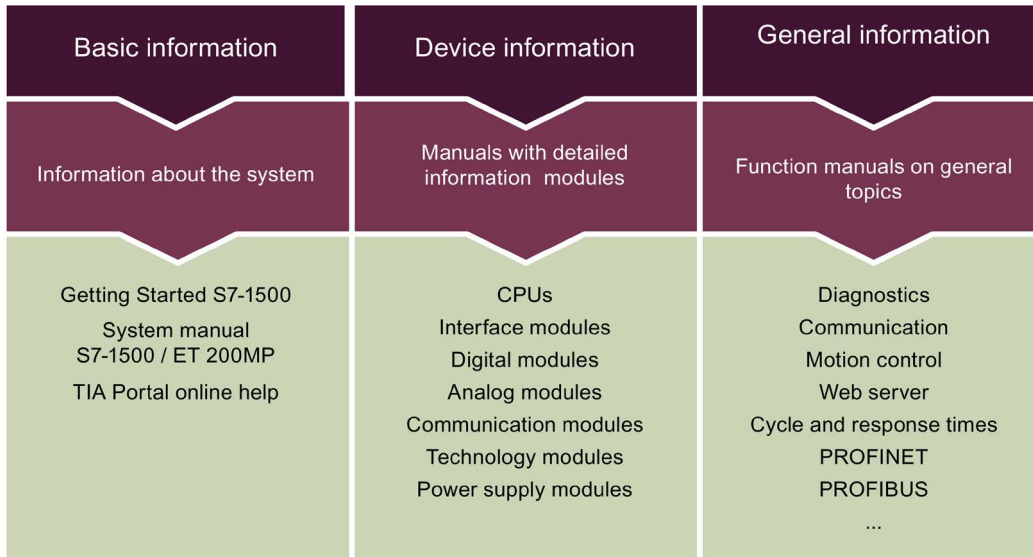

The [system manual](#) describes in detail the installation, wiring, configuration and commissioning of the system. You can find an overview of the documentation on the [Internet](#).

For new SIMATIC users, a multimedia [Getting Started](#) is available for S7-1500 and the TIA Portal in the Product Support.

Assembling your own documentation

In the Siemens Industry Online Support, the ["Documentation"](#) function enables you to compile your own "documentation" from the manuals found in the Product Support section. Other Product Support contents such as FAQs or characteristics can also be added to these compilations.

15.2 Application examples and tools

[Application examples and tools](#) support you in solving your automation tasks. Solutions are shown in interplay with multiple components - separated from the focus on individual products.

15.3 CAx downloads

Siemens offers you efficient access to all available CAx-relevant data via the [CAx downloads](#). These support you in the electrotechnical and mechanical planning of a control cabinet, for example.

15.4 FAQs

To make it easier for you to get started with plant planning with SIMATIC controllers, an overview of important and frequently asked questions about SIMATIC S7-1500 is provided below.

-
- > [Which SIMATIC and SITOP modules can you use with S7-1500 as load power supply module \(PM\)?](#)
-
- > [Which panels can communicate with a SIMATIC S7-1200 or S7-1500 in the TIA Portal?](#)
-
- > [How should you configure the system power supplies for the S7-1500 in STEP 7 \(TIA Portal\) so that all the connected modules are supplied?](#)
-
- > [How do you load a project into the CPU in STEP 7 \(TIA Portal\)?](#)
-
- > [How do you load the project data from the CPU into the programming device in STEP 7 \(TIA Portal\)?](#)
-
- > [How do you configure the S7-1500 if modules in the physical configuration are missing compared with configuration or are in a different slot?](#)
-
- > [How do you synchronize projects for the S7-1500 in STEP 7 \(TIA Portal\) when multiple users are working on a task at the same time?](#)
-
- > [How do you estimate the memory requirements of your user program in the load memory of the S7-1500 CPU and the ET 200SP CPU \(Open Controller\)?](#)
-
- > [What options does the S7-1500 provide for downloading data in RUN?](#)
-
- > [Why is universal definition and utilization of symbols in STEP 7 \(TIA Portal\) V12 obligatory for the S7-1500?](#)
-
- > [What is the meaning of the system constants in STEP 7 \(TIA Portal\) with S7-1200/1500?](#)
-

A comprehensive selection of additional FAQs is available on the [Internet](#).

Validity

This document supplements the product documentation for SIMATIC S7-1500/ET 200MP.

Make sure that the product documentation is available for all activities with the product.

Disclaimer of liability

We have reviewed the contents of this publication to ensure consistency with the hardware and software described. However, since deviations cannot be precluded entirely, we cannot guarantee full consistency. The information in this publication is reviewed regularly and any necessary corrections are included in subsequent editions.
