

SIEMENS



Switching Devices

Totally Integrated Power – SENTRON

Configu-
ration
Manual

Edition
10/2014

siemens.com/lowvoltage

Switching Devices



2	Introduction
5	5TE8 control switches
7	5TE48 pushbuttons
9	5TE58 light indicators
10	5TE81/82 ON/OFF switches
11	5TE83...88 ON/OFF switches
13	5TL1 ON/OFF switches
15	5TE DC isolators
17	5ST busbars for modular installation devices
18	5TT4 remote control switches
24	5TT4 switching relays
26	5TT5 Insta contactors
32	5TT50 Insta contactors, AC/DC technology 5TT58 Insta contactors, AC technology
38	5TT3 soft-starting devices
40	Controls
41	7LF, 5TT3 timers
47	7LF4 digital time switches
51	7LF5 mechanical time switches
56	7LF6 timers for buildings 5TT3 timers for industry

For further technical product information:

Service & Support Portal:

www.siemens.com/lowvoltage/product-support

→ Product List:
Technical specifications







→ Entry List:
Certificates / Characteristics /
Download / FAQ / Manuals /
Updates

Switching Devices

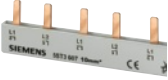
Introduction

Overview

Devices	Page	Application	Standards	Used in		
				Non-residential buildings	Residential buildings	Industry
	5	<p>For the switching of lighting and other electrical devices up to 20 A.</p> <p>For use in control cabinets for the logical linking of functions.</p>	IEC/EN 60947-3, (VDE 0660-107); IEC/EN 60669-1, (VDE 0632-1); GB 14048.3 CCC	✓	✓	✓
	7	<p>To be used as pushbuttons in control systems, e.g. to switch on seal-in circuits or as pushbuttons with maintained-contact function for manual use, as control switches or for the switching of loads up to 20 A.</p>	IEC/EN 60947-3, (VDE 0660-107); IEC/EN 60669-1, (VDE 0632-1); GB 14048.3 CCC	✓	--	✓
	9	<p>Light indicators for signaling switching states or faults in systems.</p>	DIN VDE 0710-1-11	✓	--	✓
	10	<p>For switching of lighting, motors and other electrical devices</p> <p>TE81: 20 A TE82: 32 A.</p>	20 A: IEC/EN 60947-3, (VDE 0660-107); IEC/EN 60669-1 32 A: IEC/EN 60947-3, (VDE 0660-107)	✓	✓	✓
	11	<p>For switching of lighting, motors and other electrical devices</p>	32 A ... 125 A: IEC/EN 60947-3, (VDE 0660-107) 40 A and 100 A: IEC/EN 60669-1, (VDE 0632-1)	✓	✓	✓
	13	<p>ON/OFF switches used for controlling of lighting, switching motors and other electrical loads.</p>	32 A ... 125 A: IEC/EN 60947-3, (VDE 0660-107) 40 A and 100 A: IEC/EN 60669-1, (VDE 0632-1)	✓	✓	✓
	15	<p>The DC isolator is a switch disconnecter specially designed for activating solar modules in photovoltaic systems according to DIN VDE 0100-712.</p>	IEC/EN 60947-3, IEC/EN 60669-1, GB 14018.3 CCC	✓	✓	✓

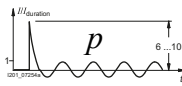
Devices	Page	Application	Standards	Used in		
				Non-residential buildings	Residential buildings	Industry
 <p>5ST busbars for modular installation devices</p>	17	For fast and safe connection	IEC/EN 60439-1, (VDE 0660-500)	✓	--	✓
 <p>5TT4 remote control switches</p>	18	For the switching of lighting up to 16 A in rooms using several pushbuttons and central ON/OFF switches.	IEC 60669-1; IEC 60669-2-2; DIN EN 60669-1-1 (VDE 0632); DIN EN 60669-2-2 (VDE 0632-2-2)	✓	✓	✓
 <p>5TT4 switching relays</p>	24	For the switching of small loads up to 16 A or as coupling devices in control systems.	DIN EN 60947-5-1, (VDE 0660-200); DIN EN 60947-1, (VDE 0660-100); GB 14048.4 CCC	✓	--	✓
5TT5 Insta contactors						
 <p>5TT50 Insta contactors, AC/DC technology</p>	26	Insta contactors 20 A, 25 A, 40 A and 63 A for the switching of heating and lighting, such as fluorescent lamps, incandescent lamps, ohmic or inductive loads.	IEC 60947-4-1; IEC 60947-5-1; IEC 61095; EN 60947-4-1; EN 60947-5-1; EN 61095; VDE 0660; UL 508; GB 14048.4 CCC	✓	✓	✓
 <p>5TT58 Insta contactors, AC technology</p>	32	Insta contactors 20 A, 25 A, 40 A and 63 A for the switching of heating and lighting, such as fluorescent lamps, incandescent lamps, ohmic or inductive loads.	IEC 60947-4-1; IEC 60947-5-1; IEC 61095; EN 60947-4-1; EN 60947-5-1; EN 61095; VDE 0660; NF C 61-480, (NF EN 61095)	✓	✓	✓
 <p>5TT3 soft-starting devices</p>	38	Protection of machines with transmission, belt or chain drives, conveyor belts, fans, pumps, compressors, packing machines or door operating mechanisms	DIN EN 60947-4-2, (VDE 0660-117)	--	--	✓
 <p>Controls</p>	40	For the ON/OFF switching of loads, contact selection for lighting installations, OFF switching of direct currents and the switching of safety extra-low voltages. A wide range of options for practical use.				

Switching Devices

Introduction

Devices	Page	Application	Standards	Used in			
				Non-residential buildings	Residential buildings	Industry	
7LF, 5TT3 timers							
	7LF4 digital time switches	41	Minute-precise switching of devices and system components in day, week and year programs. Unique due to the wide variety of functions offered by the Mini and Top versions; for PC programming Astro, Profi and Expert	IEC 60730-1 and IEC 60730-2-7 EN 60730-1 and EN 60730-2-7 VDE 0631-1 and -2-7	✓	✓	✓
	7LF5 mechanical time switches	47	Accurate and 15-minute switching accuracy. With automatic time setting during commissioning and automatic switching to daylight savings.	IEC 60730-1 and IEC 60730-2-7 EN 60730-1 and EN 60730-2-7 VDE 0631-1 and -2-7 UL 60730 UL 917	✓	✓	✓
	7LF6 timers for buildings	51	Lighting controls with stairwell lighting timers ensure the safe use of stairwells and save energy. Expanded applications for common rooms and garages, as well as the time switching of ventilators and fluorescent lamps.	IEC 60699 EN 60669, DIN 18015	✓	✓	
	5TT3 timers for industry	56	Multifunctional, delay, wiper, flashing and OFF-delay timers in control circuits expand the use of distribution boards in both small and large plants.	IEC 60255 EN 60255			✓

Overview

Two-way switches are used in control cabinets and distribution boards for switching small loads on/off or over.

Group switches with center position permit the positions open/stop/closed, for example to control counter-clockwise rotation - Off - clockwise rotation.

Control switches in a range of contact versions have an integral control lamp for the ON setting.

The auxiliary switch (AS) signals the contact position of the switch. It has the same design as the auxiliary switch used for the miniature circuit breakers (see Catalog LV10, chapter "Miniature circuit breakers").

Technical specifications

				5TE81
Standards				IEC/EN 60947-3; IEC/EN 60669-1
Approvals				IEC/EN 60947-3; GB 14048.3-2008 CCC
Rated operational current I_e	Per conducting path	A		20
Rated operational voltage U_e	1-pole	V AC		230
	Multi-pole	V AC		400
Rated power dissipation P_v	Contact per pole	VA		0.7
Conventional free-air thermal current I_{the}			A	20
Rated breaking capacity	At p.f. = 0.65	A		60
Rated making capacity	At p.f. = 0.65	A		60
Short-circuit strength In conjunction with fuse of the same rated operational current	EN 60269 gL/gG	kA		10
Rated impulse withstand voltage U_{imp}			kV	> 5
Clearances	Open contacts	mm		$2 \times > 2$
	Between the poles	mm		> 7
Creepage distances			mm	> 7
Mechanical service life	Switching cycles			25000
Electrical service life	Switching cycles			10000
Minimum contact load			V; mA	10; 300
Rated short-time currents Per conducting path at p.f. = 0.7 (The respective rated surge current can be calculated by multiplying by a factor of 1.5).	Up to 0.2 s	A		650
	Up to 0.5 s	A		400
	Up to 1 s	A		290
	Up to 3 s	A		170
Terminals Max. tightening torque	± screw (Pozidriv)			1
		Nm		1.2
Conductor cross-sections	Rigid	mm ²		1.5 ... 6
	Flexible, with end sleeve	mm ²		1 ... 6
Permissible ambient temperature			°C	-5 ... +40
Climatic withstand capability At 95 % relative humidity			°C	45
	Acc. to DIN 50015			

Switching Devices

5TE8 control switches

Dimensional drawings

Two-way and group switches with center position, 20 A

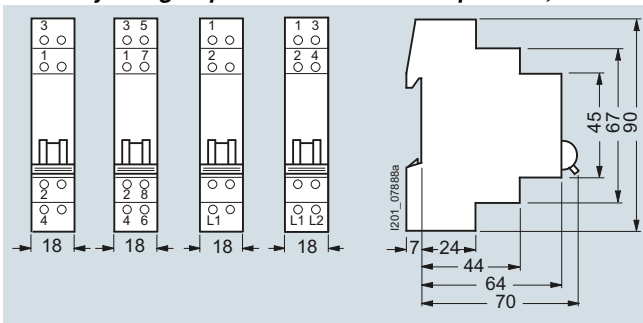

5TE8151 5TE8152 5TE8141 5TE8142
5TE8153 5TE8161 5TE8162

5TE8 control switches, 20 A, with lamp

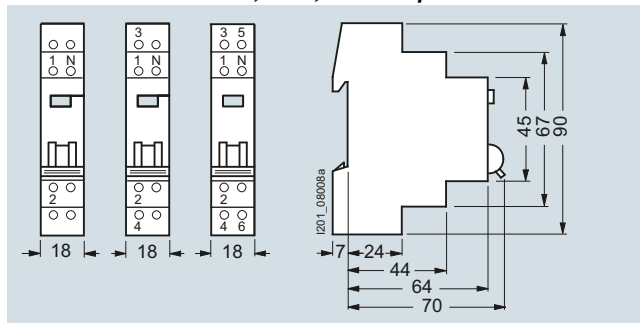

5TE8101 5TE8102 5TE8103
5TE8101-3
5TE8105

5TE8 control switches, 20 A, with lamp and auxiliary switch

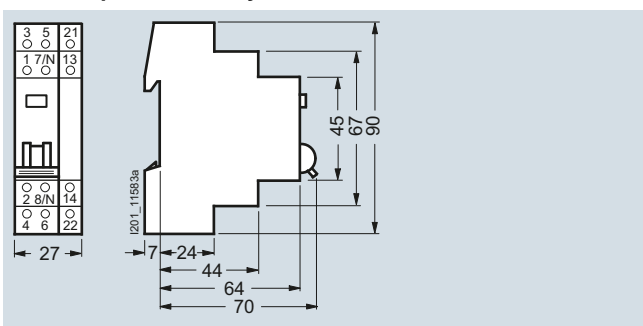

5TE8108

5ST3 auxiliary switches

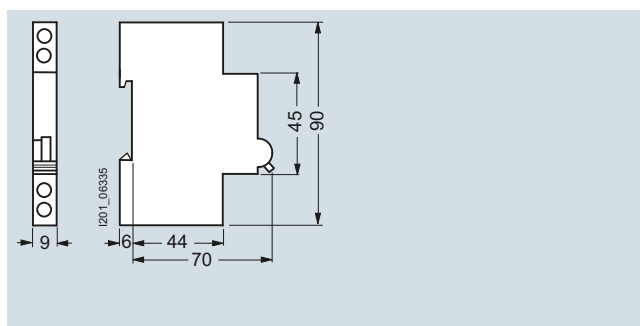

5ST3010
5ST3011
5ST3012

Circuit diagrams

Graphic symbols

Two-way switches, group switches with center position, 20 A

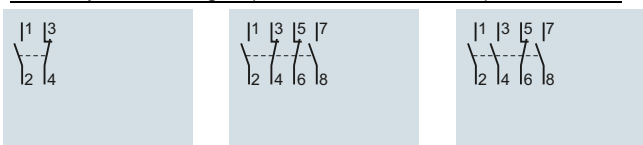

5TE8151 5TE8152 5TE8153

5TE8 control switches, 20 A, with lamp

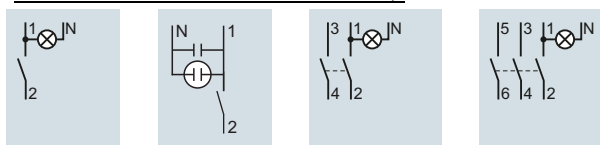

5TE8101 5TE8105 5TE8102 5TE8103
5TE8101-3

5TE8 control switches, 20 A, with lamp and auxiliary switch

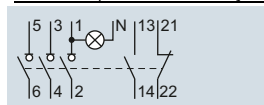

5TE8108

5ST3 auxiliary switches

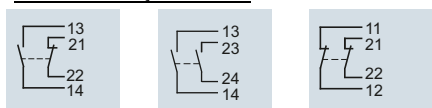

5ST3010 5ST3011 5ST3012

Overview

The pushbuttons are used in control systems, e.g. to switch on seal-in circuits or as pushbuttons with maintained-contact

function for manual use, as control switches or for the switching of loads up to 20 A.

Technical specifications

				5TE48
Standards				IEC/EN 60947-3 IEC/EN 60669-1 IEC/EN 60947-3 (VDE 0660-107)
Approvals				
Rated operational current I_e	Per conducting path	A	20	
Rated operational voltage U_e	1-pole	V AC	230	
	Multi-pole	V AC	400	
Rated power dissipation P_V	Per pole	VA	0.6	
Conventional free-air thermal current I_{the}			A	20
Rated breaking capacity	At p.f. = 0.65	A	60	
Rated making capacity	At p.f. = 0.65	A	60	
Rated impulse withstand voltage U_{imp}			kV	> 5
Clearances	Open contacts	mm	2 x > 2	
	Between the poles	mm	> 7	
Creepage distances			mm	> 7
Mechanical service life	Switching cycles			25000
Minimum contact load			V; mA	10; 300
Rated short-time currents				
Per conducting path at p.f. = 0.7	Up to 0.2 s	A	650	
	Up to 0.5 s	A	400	
	Up to 1 s	A	290	
	Up to 3 s	A	170	
(The respective rated surge current can be calculated by multiplying by a factor of 1.5).				
Terminals	± screw (Pozidriv)			1
Max. tightening torque		Nm	1.2	
Conductor cross-sections	Rigid	mm ²	1.5 ... 6	
	Flexible, with end sleeve	mm ²	1 ... 6	
Permissible ambient temperature			°C	-5 ... +40
Climatic withstand capability				
At 95 % relative humidity	Acc. to DIN 50015	°C	45	

Power loss of 5TG805. lamps		5TG8050	5TG8051	5TG8052	5TG8053	5TG8054	5TG8055
Rated operational voltage U_e	V AC	12	24	48	60	115	230
Rated power dissipation P_V	mW	70	160	350	420	70	170
Rated operational voltage U_e	V DC	12	24	48	60	110	220
Rated power dissipation P_V	mW	85	190	450	550	50	135

Power loss of 5TG805.-. LEDs		5TG805.-.
Rated power dissipation P_V		
• LED	VA	0.4

Color	Color coding according to IEC 60073		
	Safety of people or environment	Process state	System state
Red	Danger	Emergency	Faulty
Yellow	Warning/Caution	Abnormal	
Green	Safety	Normal	
Blue	Stipulation		
White, gray, black	No special significance assigned		

Switching Devices

5TE48 pushbuttons

Dimensional drawings

5TE48 pushbuttons

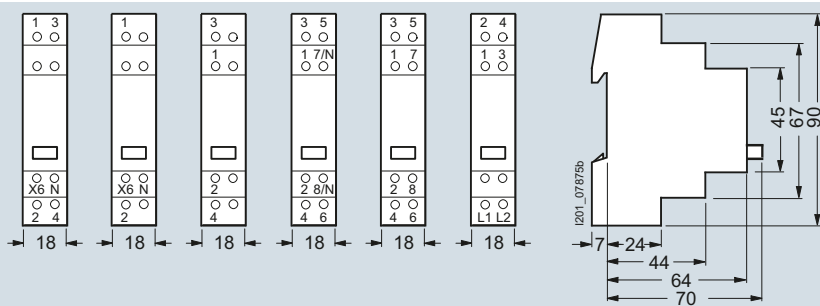

- 5TE4820 5TE4821 5TE4800 5TE4812 5TE4813 5TE4814
- 5TE4823 5TE4822 5TE4805
- 5TE4824 5TE4806
- 5TE4807
- 5TE4808
- 5TE4810
- 5TE4811

5TE4804 pushbuttons

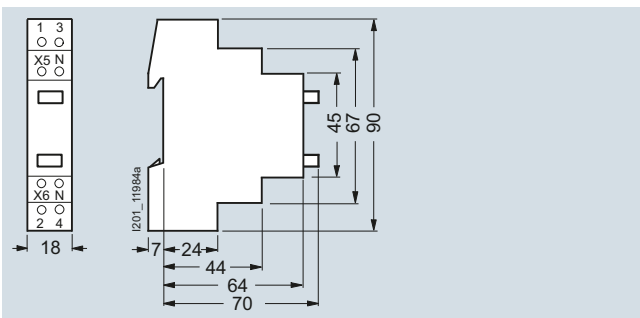

5TE4804

5TE48 double pushbuttons with maintained-contact function

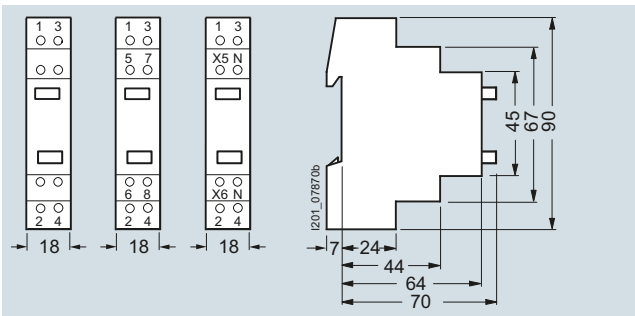

5TE4830 5TE4831 5TE4840
5TE4841

Circuit diagrams

Graphic symbols

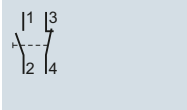

5TE4800
5TE4805
5TE4806
5TE4807
5TE4808

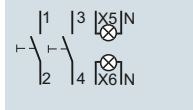

5TE4804

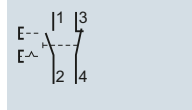

5TE4810

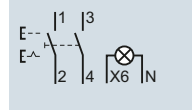

5TE4823

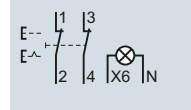

5TE4824

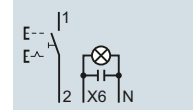

5TE4822

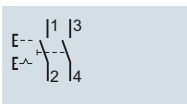

5TE4811

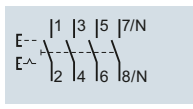

5TE4812

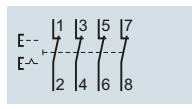

5TE4813

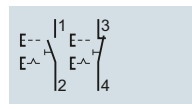

5TE4830

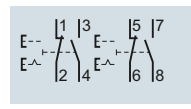

5TE4831

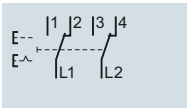

5TE4814

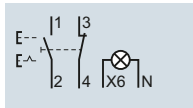

5TE4820

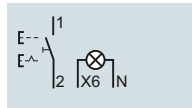

5TE4821

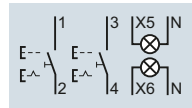

5TE4840

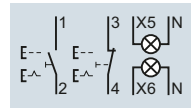

5TE4841

Overview

Light indicators are used to signal switching states or faults in systems.

They are available as single, double or triple light indicators.

Technical specifications

			5TE58
Standards			DIN VDE 0710-1-11
Rated operational voltage U_e	Max.	V AC	230 (for different voltages see 5TG8 lamps)
Rated power dissipation P_v		VA	See 5TG8 lamps
Clearances	Between the terminals	mm	> 7
Terminals	± screw (Pozidriv)		1
Max. tightening torque		Nm	1.2
Conductor cross-sections	Rigid	mm ²	1.5 ... 6
	Flexible, with end sleeve	mm ²	1 ... 6
Permissible ambient temperature		°C	-5 ... +40
Climatic withstand capability			
At 95 % relative humidity	Acc. to DIN 50015	°C	45

			5TG805.
Rated power dissipation P_v			
• LED	VA	0.4	

Color coding according to IEC 60073

Color	Meaning	Process state	
		Process state	System state
Red	Danger	Emergency	Faulty
Yellow	Warning/Caution	Abnormal	
Green	Safety	Normal	
Blue	Stipulation		
White	No special significance assigned		

Dimensional drawings

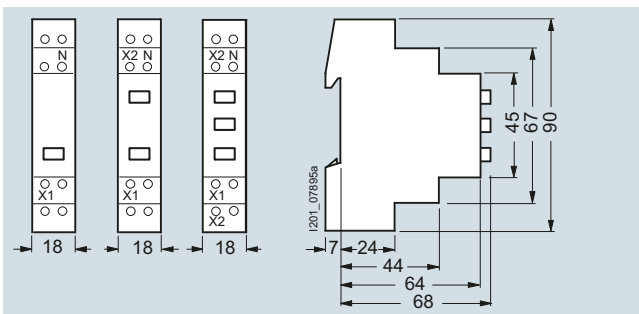

5TE5800 5TE5801 5TE5802
5TE5804 5TE5803

Circuit diagrams

Graphic symbols

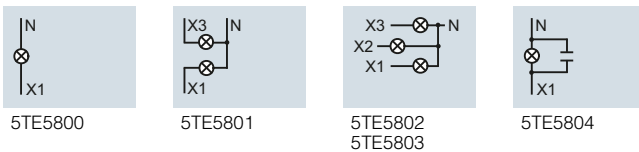

5TE5800 5TE5801 5TE5802 5TE5803 5TE5804

Switching Devices

5TE81/82 ON/OFF switches

Overview

The devices are used for the switching of lighting, motors and other electrical devices.

There is a compact series of space-saving devices with up to 4 NO contacts in a single MW available for rated currents 20 A and 32 A.

In addition, the 5TE2 device versions can be used as switch disconnectors according to EN 60947-1 and serve as main control switches for the disconnection or isolation of plants according to EN 60204-1.

Technical specifications

			5TE81	5TE82
Standards			IEC/EN 60947-3, (VDE 0660-107); IEC/EN 60669-1	IEC/EN 60947-3, (VDE 0660-107)
Approvals			IEC/EN 60947-3 (VDE 0660-107)	
Rated operational current I_e	Per conducting path	A	20	32
Rated operational voltage U_e	1-pole	V AC	230	
	Multi-pole	V AC	400	
Rated power dissipation P_v	Per pole, max.	VA	0.7	
Rated thermal current I_{th}		A	20	32
Rated breaking capacity	At p.f. = 0.65	A	60	96
Rated making capacity	At p.f. = 0.65	A	60	96
Rated short-circuit making capacity I_{cm} In conjunction with fuse of the same rated operational current	DIN EN 60269 gL/gG	kA	10	
Rated impulse withstand voltage U_{imp}		kV	> 5	
Clearances	Open contacts	mm	2 × > 2	
	Between the poles	mm	> 7	
Creepage distances		mm	> 7	
Mechanical service life		Switching cycles	25000	
Electrical service life		Switching cycles	10000	
Minimum contact load		V; mA	10; 300	
Rated short-time withstand current I_{cw} Per conducting path at p.f. = 0.7 (The corresponding rated surge current can be established by multiplying by factor 1.5.)	Up to 0.2 s	A	650	1000
	Up to 0.5 s	A	400	630
	Up to 1 s	A	290	450
	Up to 3 s	A	170	250
Terminals Max. tightening torque	± screw (Pozidriv)	Nm	1	
			1.2	
Conductor cross-sections	Rigid	mm ²	1.5 ... 6	
	Flexible, with end sleeve	mm ²	1 ... 6	
Permissible ambient temperature		°C	-5 ... +40	
Climatic withstand capability At 95 % relative humidity	Acc. to DIN 50015	°C	45	

				5TE83	5TE84	5TE85	5TE86	5TE87	5TE88
Standards				IEC/EN 60947-3 (VDE 0660-107)					
				--	IEC/EN 60669-1 (VDE 0632-1)				--
Approvals				EN 60669-1					
Rated operational current I_e	Per conducting path	A	32	40	63	80	100	125	
Rated operational voltage U_e	1-pole	V AC	230						
	Multi-pole	V AC	400						
Rated power dissipation P_V	Per pole, max.	VA	0.7	0.9	2.2	3.5	5.5	8.6	
Rated thermal current I_{th}		A	32	40	63	80	100	125	
Rated breaking capacity	At p.f. = 0.65	A	96	120	196	240	300	375	
Rated making capacity	At p.f. = 0.65	A	96	120	196	240	300	375	
Rated short-circuit making capacity I_{cm}	In conjunction with fuse of the same rated operational current	EN 60269 gL/gG	kA	10					
Rated impulse withstand voltage U_{imp}		kV	> 5						
Clearances	Open contacts	mm	> 7						
	Between the poles	mm	> 7						
Creepage distances		mm	> 7						
Mechanical service life		Switching cycles	20000						
Electrical service life		Switching cycles	10000		5000	1000			
Minimum contact load		V; mA	24; 300						
Rated power	1-pole	kW	5	6.5	10	13	16	16	
Switching of resistive loads	2-pole	kW	9	11	18	22	28	28	
including moderate overload AC-21	3-/4-pole	kW	15	15	30	39	48	48	
Rated short-time withstand current I_{cw}	Per conducting path at p.f. = 0.7	A	760	950	1500	2700	3400	3400	
	Up to 0.2 s	A	500	630	1000	1650	2100	2100	
	Up to 0.5 s	A	400	500	800	1350	1700	1700	
	Up to 1 s	A	280	350	560	800	1000	1000	
	Up to 3 s	A							
Terminals	± screw (Pozidriv)	Nm	2						
Max. tightening torque		Nm	3.5						
Conductor cross-sections	Rigid	mm ²	1 ... 35			2.5 ... 50			
	Flexible, with end sleeve	mm ²	1 ... 35			2.5 ... 50			
Permissible ambient temperature		°C	-5 ... +40						
Climatic withstand capability	At 95 % relative humidity	°C	45						
	Acc. to DIN 50015	°C	45						

Switching Devices

5TE83...88 ON/OFF switches

5TE8 ON/OFF switches, 32 A to 125 A

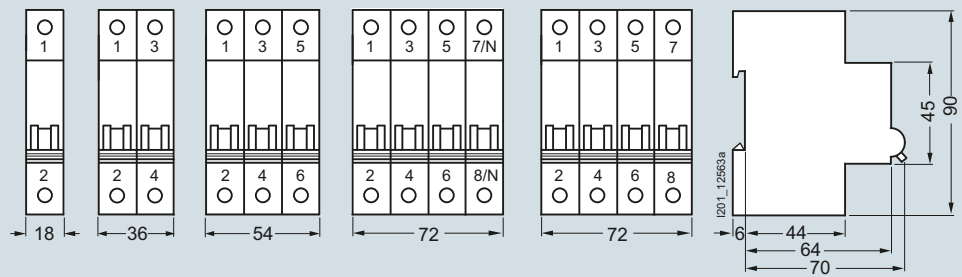

- | | | | | |
|---------|---------|---------|---------|---------|
| 5TE8311 | 5TE8312 | 5TE8313 | 5TE8314 | 5TE8315 |
| 5TE8411 | 5TE8412 | 5TE8413 | 5TE8414 | 5TE8415 |
| 5TE8511 | 5TE8512 | 5TE8513 | 5TE8514 | 5TE8515 |
| 5TE8521 | 5TE8522 | 5TE8523 | 5TE8524 | |
| | | 5TE8533 | | |
| 5TE8611 | 5TE8612 | 5TE8613 | 5TE8614 | 5TE8615 |
| 5TE8711 | 5TE8712 | 5TE8713 | 5TE8714 | 5TE8715 |
| 5TE8721 | 5TE8722 | 5TE8723 | 5TE8724 | |
| 5TE8811 | 5TE8812 | 5TE8813 | 5TE8814 | 5TE8815 |

5ST3 auxiliary switches

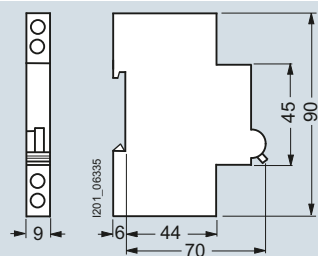

- 5ST3010
5ST3011
5ST3012

Phase connectors/N conductor connectors

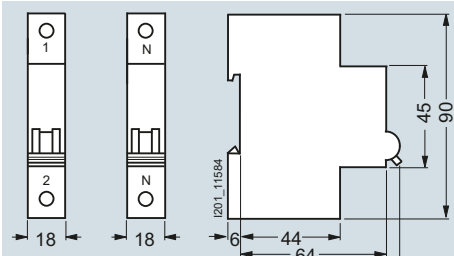

- 5TE9112 5TE9113

Circuit diagrams

Graphic symbols

5TE8 ON/OFF switches

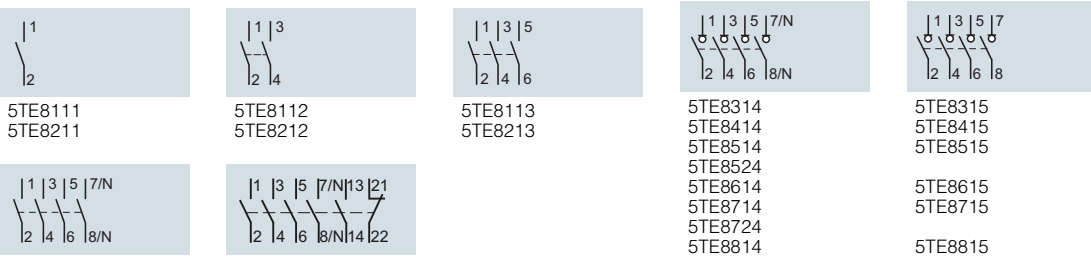

5ST3 auxiliary switches

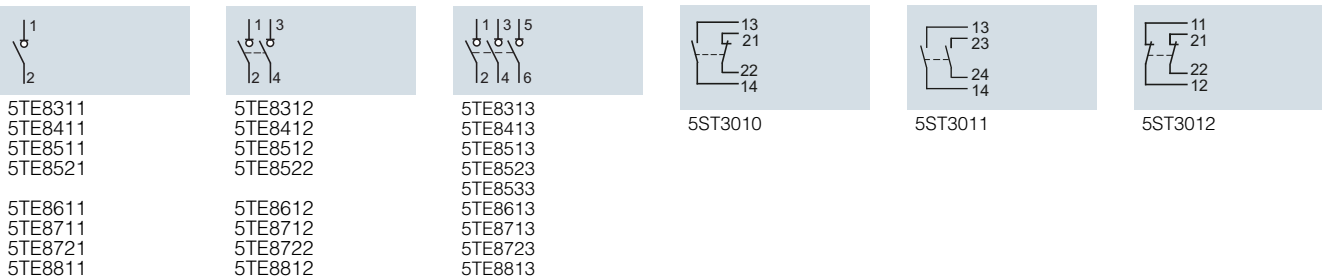

Overview

The new 5TL1 ON/OFF switches are used for the switching of lighting, motors and other electrical devices. Rated currents range between 32 A and 125 A. The new design of the 5TL1 ON/OFF switches allows them to be optically perfectly integrated in the series of RCCBs and MCBs.

In addition, the 5TL1 device versions can be used as switch disconnectors according to EN 60947-1 and can be used as main control switches for the disconnection or isolation of systems according to EN 60204-1.

Technical specifications

			5TL1132	5TL1140	5TL1163	5TL1180	5TL1191	5TL1192	
			5TL1232	5TL1240	5TL1263	5TL1280	5TL1291	5TL1292	
			5TL1332	5TL1340	5TL1363	5TL1380	5TL1391	5TL1392	
			5TL1432	5TL1440	5TL1463	5TL1480	5TL1491	5TL1492	
			5TL1632	5TL1640	5TL1663	5TL1680	5TL1691	5TL1692	
Standards			IEC/EN 60947-3 (VDE 0660-107)						
			--	IEC/EN 60669-1 (VDE 0632-1)				--	
Approvals			EN 60669-1						
Rated operational current I_e	Per conducting path	A	32	40	63	80	100	125	
Rated operational voltage U_e	1-pole	V AC	250						
	Multi-pole	V AC	440						
Rated power dissipation P_v	Per pole, max.	VA	0.7	0.9	2.2	3.5	5.5	8.6	
Rated thermal current I_{th}		A	32	40	63	80	100	125	
Rated breaking capacity AC-22A	At p.f. = 0.65	A	96	120	196	240	300	375	
Rated making capacity AC-22A	At p.f. = 0.65	A	96	120	196	240	300	375	
Rated short-circuit making capacity I_{cm}	In conjunction with fuse of the same rated operational current	EN 60269 gL/gG	10						
Rated impulse withstand voltage U_{imp}		kV	>5						
Clearances	Open contacts	mm	>7						
	between the poles	mm	>7						
Creepage distances		mm	>7						
Mechanical service life		Switching cycles	20000						
Electrical service life		Switching cycles	10000		5000	1000			
Minimum contact load		V; mA	24; 300						
Rated power	1-pole	kW	5	6.5	10	13	16	16	
	2-pole	kW	9	11	18	22	28	28	
	3-/4-pole	kW	15	15	30	39	48	48	
Rated short-time withstand current I_{cw}	Per conducting path at p.f. = 0.7								
	Up to 0.2 s	A	760	950	1500	2700	3400	3400	
	Up to 0.5 s	A	500	630	1000	1650	2100	2100	
	Up to 1 s	A	400	500	800	1350	1700	1700	
	Up to 3 s	A	280	350	560	800	1000	1000	
	(The corresponding rated surge current can be established by multiplying by factor 1.5.)								
Terminals	± screw (Pozidriv)		2						
	Max. tightening torque	Nm	3.5						
Conductor cross-sections	Rigid	mm ²	1 ... 35			2.5 ... 50			
	Flexible, with end sleeve	mm ²	1 ... 35			2.5 ... 50			
Permissible ambient temperature		°C	-5 ... +40						
Climatic withstand capability	At 95 % relative humidity	Acc. to DIN 50015	°C						
		°C	45						

Switching Devices

5TL1 ON/OFF switches

Dimensional drawings

5TL1 ON/OFF switches, 32 A to 125 A

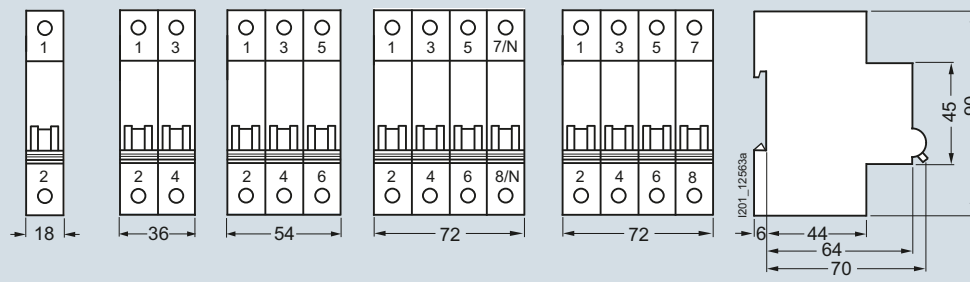

- | | | | | |
|-----------|-----------|-----------|-----------|-----------|
| 5TL1163-1 | 5TL1263-1 | 5TL1363-1 | 5TL1663-1 | 5TL1432-0 |
| 5TL1191-1 | 5TL1291-1 | 5TL1391-1 | 5TL1691-1 | 5TL1440-0 |
| 5TL1132-0 | 5TL1232-0 | 5TL1332-0 | 5TL1632-0 | 5TL1463-0 |
| 5TL1140-0 | 5TL1240-0 | 5TL1340-0 | 5TL1640-0 | 5TL1480-0 |
| 5TL1163-0 | 5TL1263-0 | 5TL1363-0 | 5TL1663-0 | 5TL1491-0 |
| 5TL1180-0 | 5TL1280-0 | 5TL1380-0 | 5TL1680-0 | 5TL1492-0 |
| 5TL1191-0 | 5TL1291-0 | 5TL1391-0 | 5TL1691-0 | |
| 5TL1192-0 | 5TL1292-0 | 5TL1392-0 | 5TL1692-0 | |

5ST3 auxiliary switches

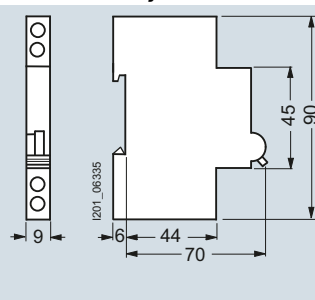

- 5ST3010
- 5ST3011
- 5ST3012
- 5ST3013
- 5ST3014
- 5ST3015

Phase connectors/N conductor connectors

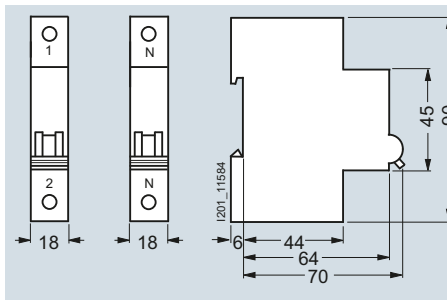

- 5TL1192-4
- 5TL1192-3

Circuit diagrams

Graphic symbols

5TL1 ON/OFF switches

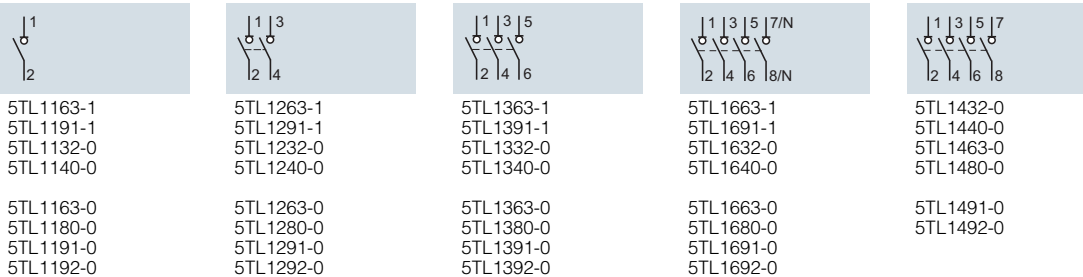

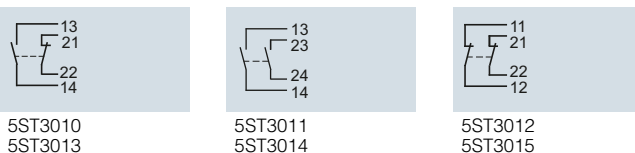

5ST3 auxiliary switches



Overview

- Switch disconnectors for isolating solar modules in photovoltaic systems acc. to DIN VDE 0100-712
- Compact DIN rail device for applications up to 1000 V DC
- Separate switching position indication for unambiguous indication of the switching state
- Compatible with all miniature circuit breaker accessories - reduced stock-keeping
- The effective touch protection when grasping the device considerably exceeds the requirements of BGV A3
- Manual snap-on fixing and release systems that require no tools enable fast assembly and disassembly of switch disconnectors
- Clear and visible conductor connection that can be easily checked in front of the busbar

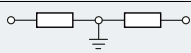
Technical specifications

		5TE2515-1	
Standards			IEC/EN 60947-3, IEC/EN 60669-1
Rated operational current I_e		A	63
Rated operational voltage U_e	For 4 poles in series	V DC	880
Rated power dissipation P_V	Per pole, max.	W	4.4
Rated short-circuit strength I_{cw}	1000 V DC, 4-pole	A	760
Rated short-circuit making capacity I_{cm}	1000 V DC, 4-pole	A	500
Rated impulse withstand voltage U_{imp}		kV	> 4
Max. operational voltage U_{max}		V DC	1000
Overvoltage category			II at $U = 880 \text{ V} \dots 440 \text{ V}$  I at $U = 1000 \text{ V}$ 
Mechanical service life		Switching cycles	10000
Electrical service life		Switching cycles	5000
Utilization category			DC-21B
Minimum contact load		V; mA	24; 300
Terminals	± screw (Pozidriv)		PZ 2
Max. tightening torque		Nm	2.5 ... 3
Conductor cross-sections	Rigid	mm ²	0.75 ... 35
	Flexible, with end sleeve	mm ²	0.75 ... 25
Permissible ambient temperature		°C	-25 ... +45
Climatic withstand capability			
At 95 % relative humidity	Acc. to DIN 50015	°C	45

Switching Devices

5TE DC isolators

Dimensional drawings

5TE2 DC isolators

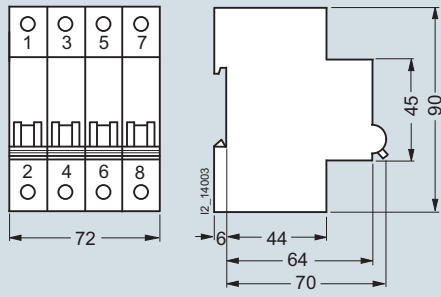

5TE2515-1

5ST3 auxiliary switches

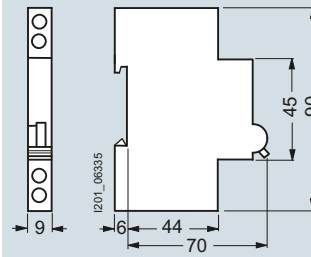

5ST3010
5ST3011
5ST3012

Circuit diagrams

5TE2 DC isolators



5TE2515-1

5ST3 auxiliary switches



5ST3010



5ST3011



5ST3012

Configuration

For DC voltages up to 1000 V, the four poles need to be connected in series. In contrast to normal flush-mounting switches, these devices are also fitted with arcing chambers and permanent solenoids to aid the positive quenching of the electric arc in direct currents.

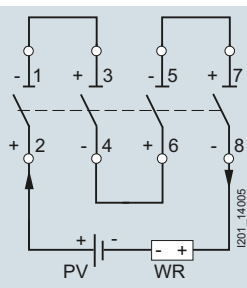

For this reason it is essential to comply with the polarity specifications of the switches when connecting the conductor. Suitable precautions should be taken during plant configuration to ensure there can be no polarity reversal in DC operation (e.g. photovoltaic systems).

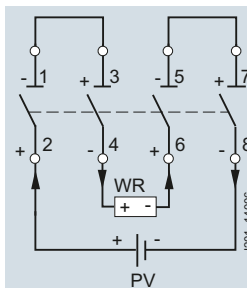

Legend:

PV: Photovoltaic
WR: Inverter

Overview

Siemens has developed a rail-mounting concept which makes the linking of switching devices just as easy as that of miniature circuit breakers.

The arrangement of the terminals on the devices is adapted to the bus mounting. With only two busbars, this saves considerable mounting time.

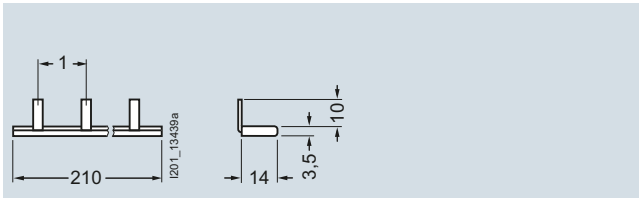
Dimensional drawings

5TE9100

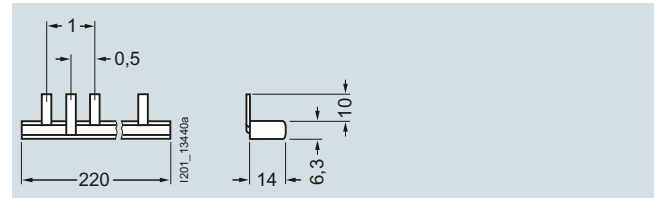

5TE9101

Note:

Pin spacing in MW
Dimensions of side views in mm (approx.)

Switching Devices

5TT4 remote control switches

Overview

Remote control switches are used in residential and non-residential buildings, as well as the switchgear engineering sector. They trip in the event of "current intrushes", i.e. pulses, and then electromechanically save the switching position, even in the event of a power failure.

All the devices have the VDE mark and can also be equipped with an additional auxiliary switch. All devices have a switching

position indication and are operated manually. The switching noise is particularly quiet and meets the requirements of residential buildings.

Note:

Busbars to match the 5TT41 remote control switches [can be found on page 17](#).

Technical specifications

	Remote control switches				Auxiliary switches	
	5TT4101 5TT4102 5TT4105 5TT4111 5TT4112 5TT4115	5TT4103 5TT4104	5TT412 5TT415	5TT413 5TT414	5TT4900	5TT4901
Standards	IEC 60669-1, IEC 60669-2, IEC 60669-3, EN 60669 (VDE 0632), EN 60669-2-2, EN 60669-2-2/A1				DIN EN 60947-1 (VDE 0660 Part 100) EN 60947-5-1 (VDE 0660 Part 200)	
Approvals	VDE					
Contact type	1 NO 2 NO 1 NO 1 NC	3 NO 4 NO	1 NO 2 NO 3 NO 1 NO 1 NC	Series Shutter/ blind	1 CO	1 CO
Manual operation	Yes				--	
Switching position indication	Yes				--	
Rated control voltage U_c	V AC V DC	8 ... 230 12 ... 110			-- --	
Primary operating range	$\times U_c$	0.8 ... 1.1			--	
Rated frequency f_c (AC types)	Hz	50			--	
Rated impulse withstand voltage U_{imp}	kV	4			1	
Rated power dissipation P_v						
• Magnet coil, only pulse	W/VA	4.5/7	9/13	4.5/7	--	
• Per contact at 16 A	W	1.2			--	
Minimum contact load	V AC; mA	10; 100			5 AC/DC; 1	
Rated operational current I_e at p.f. $\varphi = 0.6 \dots 1$	A	16			5	0.1
Rated operational voltage U_e						
• 1 NO	V AC	250	--	250	--	250
• 2 NO	V AC	400	--	400	250	--
• 3 NO	V AC	--	400	400	--	--
• 4 NO	V AC	--	400	--	--	--
• 1 NO + 1 NC	V AC	250	--	250	--	--
Glow lamp load at 230 V	mA	5			--	
• With 1 5TT4 920 compensator	mA	25			--	
• With 2x 5TT4 920 compensators	mA	45			--	
Incandescent lamp load²⁾	W	1200			--	
Different phases between magnet coil/contact		Permissible			--	
Contact gap	mm	> 1.2			< 1.2	
Safe separation						
Creepage distances and clearances between magnet coil/contact	mm	> 6				
Pushbutton malfunction						
Protected against continuous voltage, safe due to design		Yes	PTC	Yes ¹⁾	Yes	--
Minimum pulse duration	ms	50				
Electrical service life						
AtI_e/U_e , p.f. = 0.6; incandescent lamp load 600 W	In switching cycles	50000				
Terminals \pm screw (Pozi driv)		1				
Conductor cross-sections						
• Rigid	mm ²	1.5 ... 6			0.5 ... 4	
• Flexible, with end sleeve	mm ²	1 ... 6			0.75 ... 4	
Climatic withstand capability						
At 95 % relative humidity	Acc. to DIN 50015	°C	35			
Permissible ambient temperature		°C	-10 ... +40			
Degree of protection	Acc. to DIN EN 60529		IP20, with connected conductors			
Mounting position			Any			

¹⁾ For 2.5 MW 5TT4123-0 devices with PTC.

²⁾ For 15 000 switching cycles.

Dimensional drawings

5TT41 remote control switches

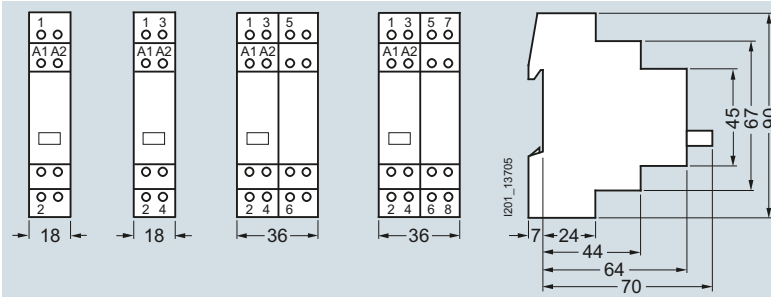

5TT4101 5TT4102 5TT4103 5TT4104
5TT4105
5TT4115

5TT412 remote control switches with central ON/OFF switching

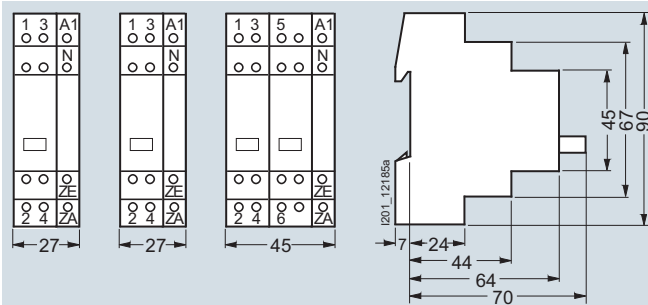

5TT4121-0 5TT4122-0 5TT4123-0
5TT4121-2 5TT4122-2
5TT4125-0

5TT4132-0 series remote control switches and 5TT4142 shutter/blind remote control switches

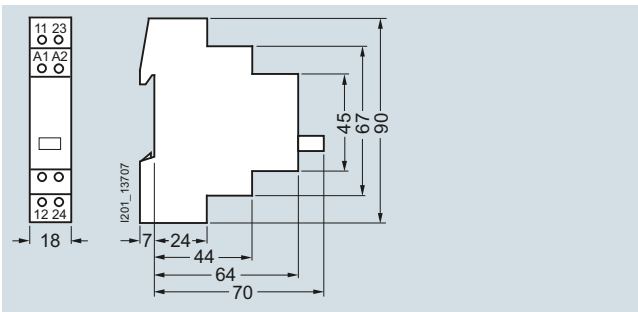

5TT4132
5TT4142

Remote control switches with central and group ON/OFF switching

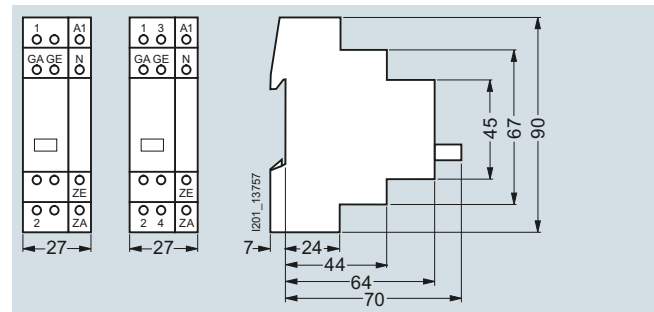

5TT4151 5TT4152

Auxiliary switches

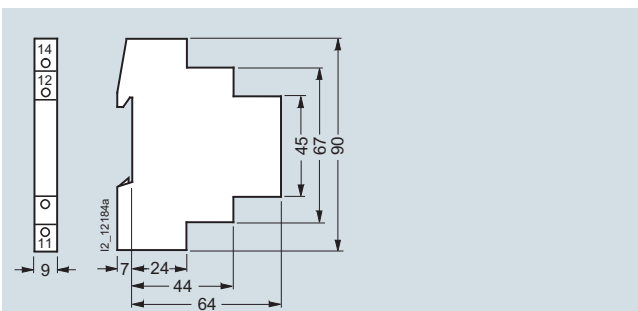

5TT490.

Compensator

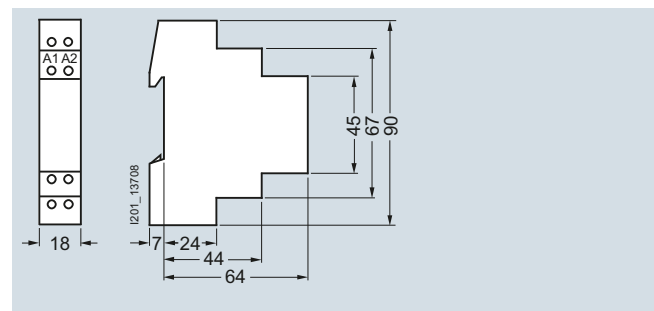

5TT4920

Switching Devices

5TT4 remote control switches

Circuit diagrams

Graphic symbols

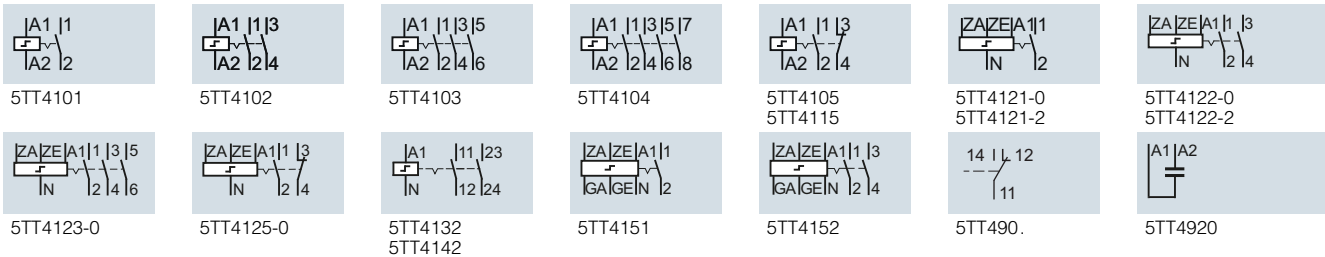

More information

Mechanical storage

Remote control switches are used to switch lighting through the use of several pushbuttons. This makes complex cross/two-way switching unnecessary. With each pushbutton impulse, the remote control switch changes its contact position from "OFF" to "ON", etc. In the event of a power failure, the last switching position is mechanically stored. Electromechanical remote control switches have no standby loss.

Pushbutton malfunction

Pushbuttons can jam and then supply continuous voltage to the remote control switch. All remote control switches are protected against this type of malfunction through their design or through PTC.

Central switching functions

Versions with central ON/OFF function allow the central switching of all connected remote control switches. This type of central switching can also be actuated using a time switch. All remote control switches can be switched to the ON or OFF switching state, regardless of their current switching state.

Contact sequences

1 – 2 – 1+2 – 0 or 1 – 0 – 2 – 0 means:

- 0: No contact closed
- 1: Only contact 1 closed
- 2: Only contact 2 closed
- 1+2: Contact 1 and Contact 2 are closed

The contact positions are constantly changing with each pushbutton impulse.

Note:

Synchronous switching of the contacts cannot be guaranteed with parallel switching. Products with central/group switching must be used for the mutual control of several remote control switches.

Bus mounting



- All 5TT41 remote control switches can be bus-mounted with each other. This saves time and space.

Note:

Busbars to match the 5TT41 remote control switches can be found on page 17.

Circuit example for 5TT4101-0

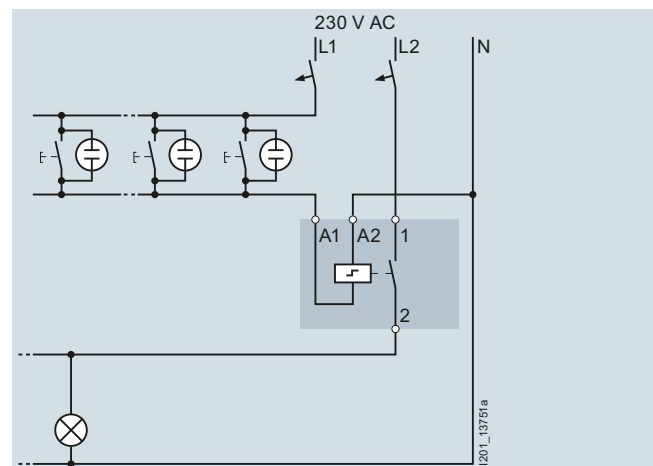

Single-phase lighting circuit with 230 V AC actuation, e.g. in office buildings

Typical circuit for 5TT4122-0 with central ON/OFF switching

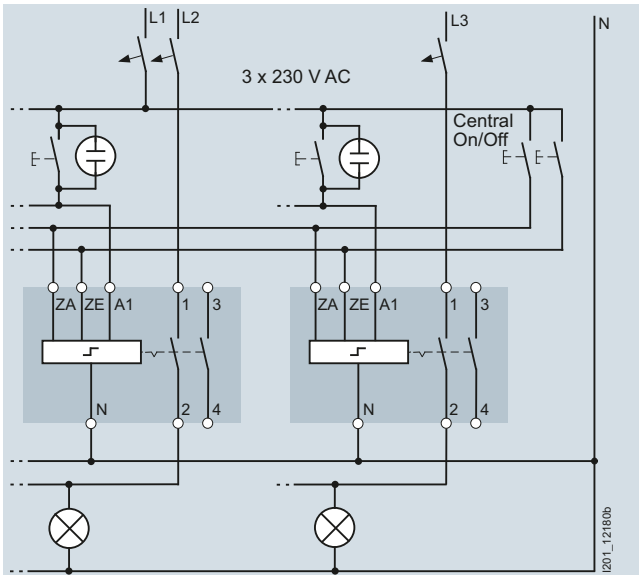

With the 2 pushbuttons "central ON" and "OFF", all remote control switches can be switched on or off from a central point, e.g. at the start and end of operation. A time switch with a one-second pulse (e.g. 7LF4444-0) can also be used if desired. Once a central on/off switching operation has been executed, the remote control switches can also be switched on and off locally at any time. Remote control switches with central ON/OFF switching can also be used to quickly and easily set up a panic circuit/panic lighting using conventional installation methods.

The input terminals on the remote control switch need to be connected to the same phase (L1, L2 or L3) and over the same residual current protective device. Otherwise residual current protective devices may be tripped unintentionally, or short circuits might occur.

Typical circuit for 5TT4101-4

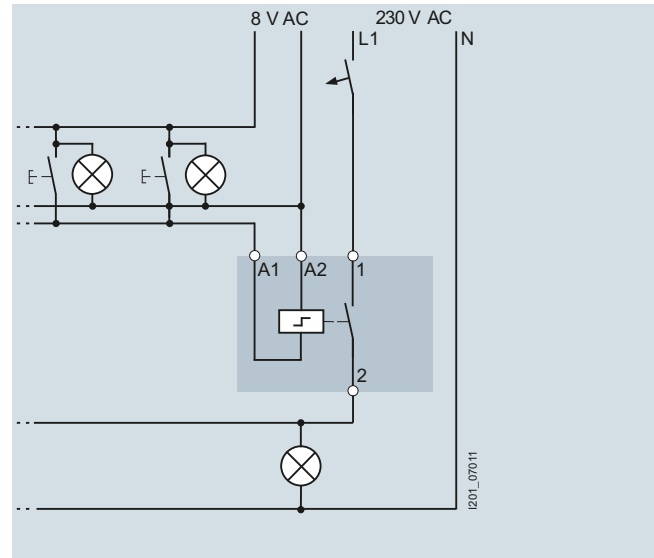

Single-phase lighting circuit with safety extra-low voltage 8 V AC, illuminated pushbutton

This circuit is also suitable for the control of circuits with a high number of illuminated pushbuttons.

Typical circuit 5TT4121-0 with central ON/OFF switching and time switch

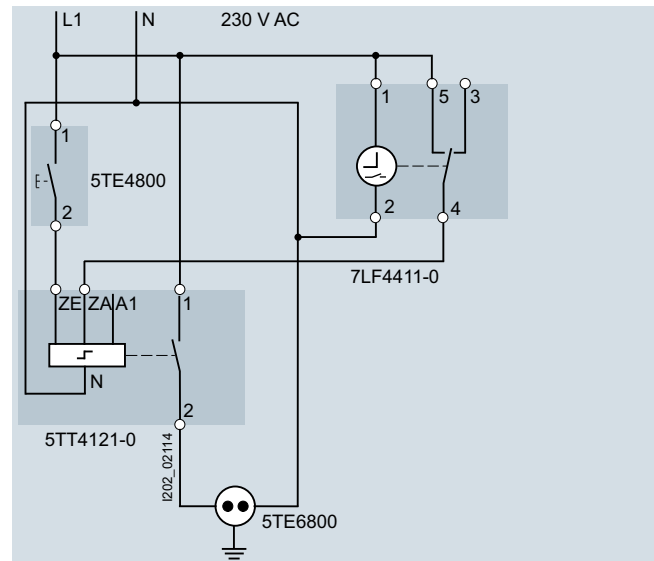

Switching Devices

5TT4 remote control switches

Typical circuit for 5TT4152-0 with central ON/OFF switching and ON/OFF group switching

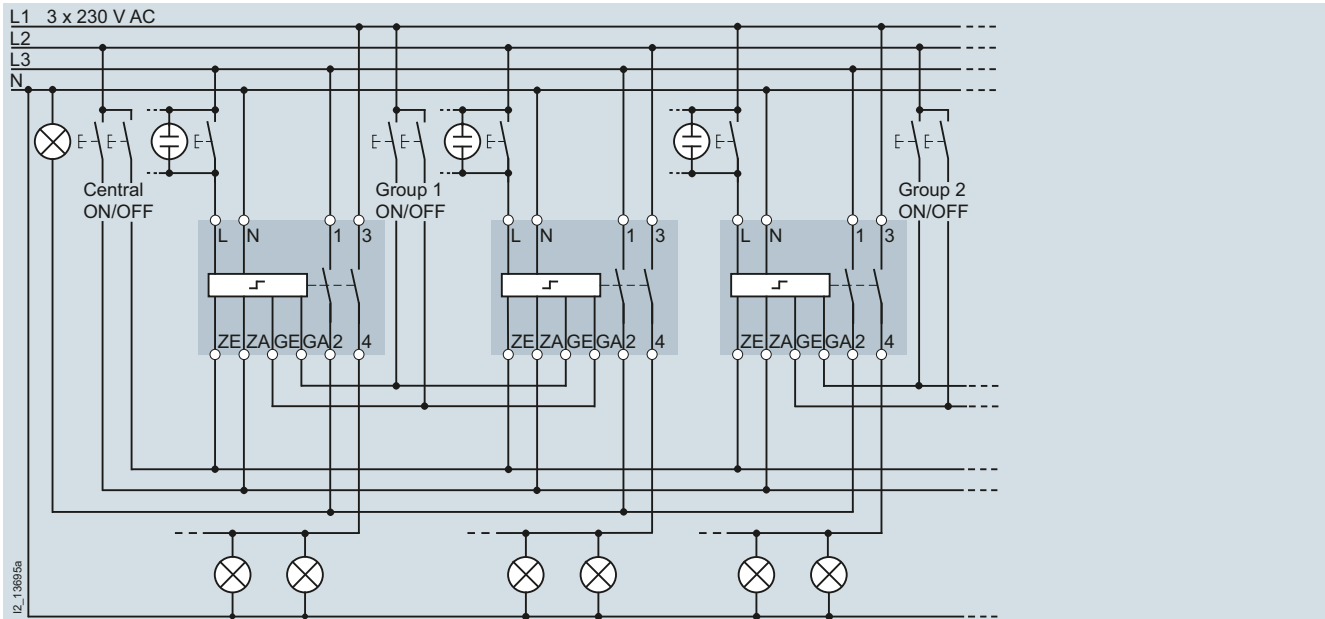

With the 2 pushbuttons central "ON" and "OFF", all remote control switches can be switched on or off from a central point, e.g. at the start and end of operation.

With the 2 pushbuttons group "ON" and "OFF", all remote control switches assigned to a group can be switched on or off, e.g. corridor. A digital 7LF44 time switch with a switching command of 1 s can also be used for the "Central" or "Group" function.

Once a central on/off switching operation has been executed, the remote control switches can also be switched on and off locally at any time. The phase relations of ZA, ZE and GA, GE and L can be different. If contact 1/2 is used as checkback contact for the central "ON" and "OFF" function, as shown above, terminal 1 of all remote control switches must be in phase.

Typical circuit: glow lamp load and 5TT4920 compensator

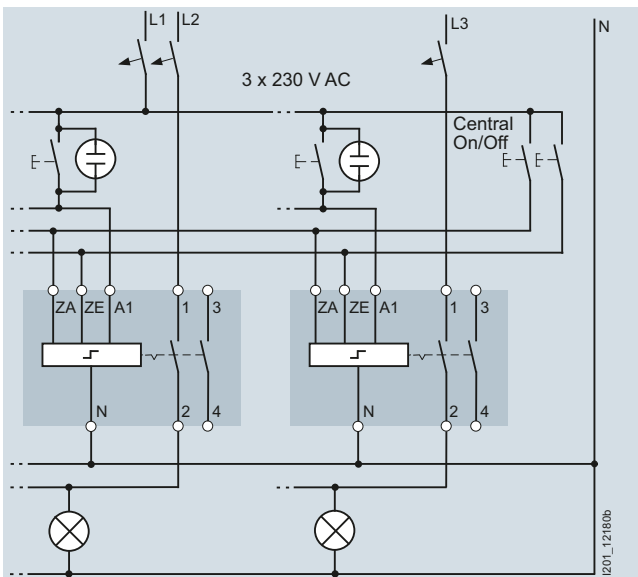

The use of multiple illuminated pushbuttons, in particular 230 V AC glow lamps, could cause the remote control switch to trip accidentally, or no longer drop out, due to the current used by the lamps. This may also occur at high line capacities. By connecting a 5TT4920 compensator in parallel to the coil, the glow lamp load of the remote control switch is increased from 5 mA to 25 mA. Several compensators can be connected in parallel. The power consumption of 230 V 5TG73... glow lamps for pushbuttons is: Low luminosity 0.18 mA – medium 0.9 mA – high 1.35 mA, the power consumption of LED 5SG735... lighting is approx. 1.5 mA.

To reduce capacitive coupling due to long cable lengths, we recommend using shielded cables. Particularly in systems with frequency converter controlled motors or with parallel cable routes (e.g. cable support systems), the induced current may impair the function of the devices.

Switching of lamps

			Remote control switches			
			5TT4101 5TT4102 5TT4105 5TT4115	5TT4103 5TT4104	5TT412 5TT415	5TT413 5TT414
Switching of transformers for halogen lamps		W	1200			
Fluorescent and compact lamps in ballast operation						
• Uncorrected	L18W	Unit(s)	35	30		
	L36W	Unit(s)	35	30		
	L58W	Unit(s)	25	20		
• Parallel-corrected	L18W/4.5 μF	Unit(s)	40	50		
	L36W/4.5 μF	Unit(s)	40	50		
	L58W/7 μF	Unit(s)	28	30		
• DUO switching, 2-lamp	L18W	Unit(s)	2 × 30	2 × 24		
	L36W	Unit(s)	2 × 30	2 × 24		
	L58W	Unit(s)	2 × 30	2 × 16		
Fluorescent and compact lamps with electronic ballast (ECG)						
• AC operation, 1-lamp	L18W	Unit(s)	36	30		
	L36W	Unit(s)	36	30		
	L58W	Unit(s)	24	20		
• AC operation, 2-lamp	L18W/4.5 μF	Unit(s)	2 × 22	2 × 18		
	L36W/4.5 μF	Unit(s)	2 × 22	2 × 18		
	L58W/7 μF	Unit(s)	2 × 15	2 × 12		

The specified values are intended to serve as a guideline only. The max. number of illuminants may vary, depending on the manufacturer. The values specified here refer to Osram illuminants and ballasts.

Switching Devices

5TT4 switching relays

Overview

Switching relays are used in residential, non-residential and industrial buildings for the purpose of contact multiplication. They can be used with safe isolation between coil voltage and contact.

With the 5TE9100 and 5TE9101 busbars, the switching relays can be mounted quickly and safely, e.g. by bus mounting the N conductor and/or infeed.

Note:

Busbars to match the 5TT42 switching relays [can be found on page 17](#).

Technical specifications

		5TT4 201-	5TT4 202-	5TT4 204-	5TT4 205-	5TT4 206-	5TT4 207-	5TT4 217-	
Standards		EN 60947-5-1, EN 60669-2-2							
Approvals		VDE, CCC							
Contact type		1 NO	2 NO	4 NO	1 NO + 1 NC	1 CO	2 CO	2 CO	
Manual operation		Yes							
Rated control voltage U_c	V AC V DC	8 ... 230						-- 12 ... 110	
Primary operating range	$\times U_c$	0.8 ... 1.1							
Rated frequency f_c	Hz	50							
Rated impulse withstand voltage U_{imp}	kV	4							
Rated power dissipation P_v									
• Magnet coil	W/VA	2.4/3.0	2.4/3.0	4.8/6.0	2.4/3.0	2.4/3.0	2.4/3.0	1.7	
• Per contact at 16 A	W	1.0							
Minimum contact load	V AC; mA	10; 100							
Rated operational current I_o									
At p.f. = 0.6 ... 1	A	16							
Rated operational voltage U_o		250	400	400	400	250	400	400	
Different phases									
Between magnet coil/contact		Permissible							
Contact gap	mm	> 1.2				< 1.2			
Safe separation	mm	> 6							
Electrical service life									
At U_o/U_c , p.f. = 0.6; incandescent lamp load 600 W	Switching cycles	50000							
Terminals	\pm screw (Pozidriv)	1							
Conductor cross-sections									
• Rigid	mm ²	1.5 ... 6							
• Flexible, with end sleeve	mm ²	1 ... 6							
Climatic withstand capability									
At 95 % relative humidity	Acc. to DIN 50015	°C		35					
Permissible ambient temperature		°C							
		-10 ... +40							
Degree of protection	Acc. to DIN EN 60529	IP20, with connected conductors							
Mounting position		Any							

Dimensional drawings

5TT42 switching relays

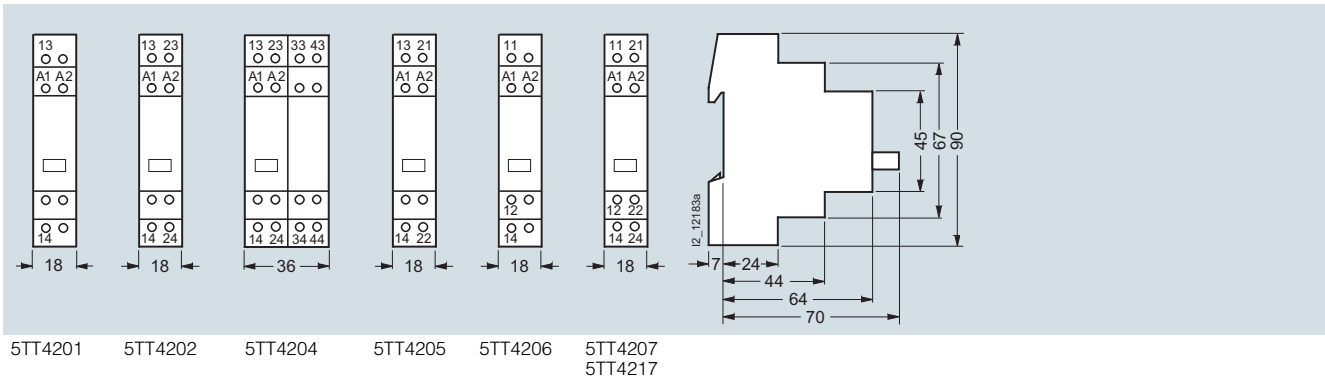

Circuit diagrams

Graphic symbols

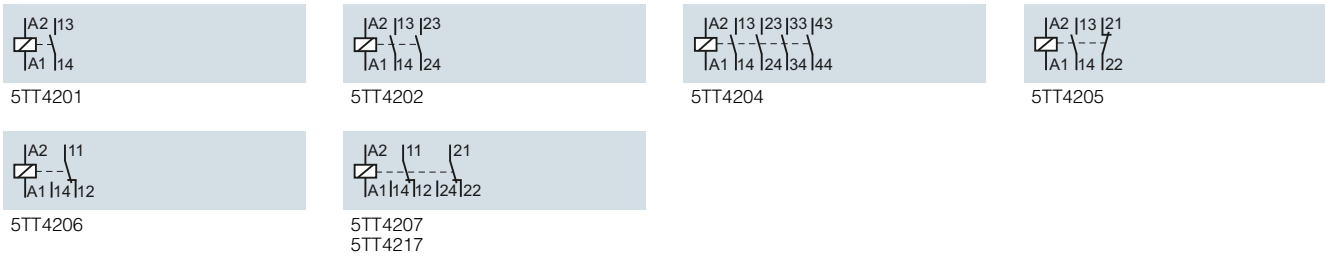

More information

			5TT42...-
Incandescent lamp load			W 600
At U_e/U_n , p.f. = 0.6; incandescent lamp load 600 W			
Switching of transformers for halogen lamps			W 1200
Fluorescent and compact lamps			
In ballast operation			
• Uncorrected	L18W	Unit(s)	27
	L36W	Unit(s)	24
	L58W	Unit(s)	15
Fluorescent and compact lamps			
With electronic ballast (ECG)			
• AC operation, 1-lamp	L18W	Unit(s)	43
	L36W	Unit(s)	24
	L58W	Unit(s)	15
Metal-vapor and high-pressure mercury-vapor lamps			
• Uncorrected	50 W	Unit(s)	12
	80 W	Unit(s)	9
	125 W	Unit(s)	6
	250 W	Unit(s)	3
	400 W	Unit(s)	2
	700W	Unit(s)	1
	1000 W	Unit(s)	1
Halogen metal-vapor lamps (HQI)			
• Uncorrected	70 W	Unit(s)	8
	150 W	Unit(s)	4
	250 W	Unit(s)	2
	400 W	Unit(s)	1
High-pressure sodium-vapor lamps			
• Uncorrected	50 W	Unit(s)	10
	70 W	Unit(s)	8
	110 W	Unit(s)	6
	150 W	Unit(s)	4
	250 W	Unit(s)	1

The specified values are intended to serve as a guideline only. The max. number of illuminants may vary, depending on the manufacturer. The values specified here refer to Osram illuminants and ballasts.

Bus mounting

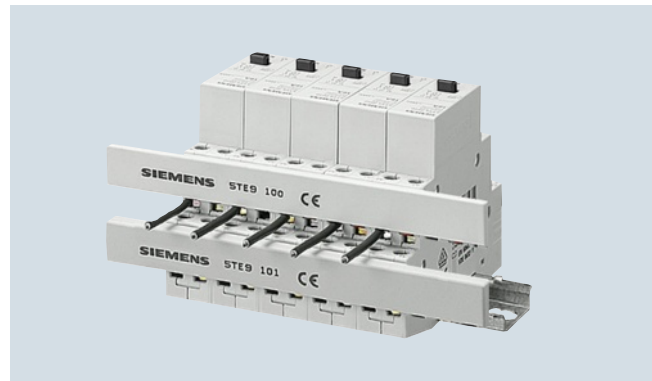

- All 5TT42 switching relays can be bus-mounted with each other. This saves time and space.

Note:

Busbars to match the 5TT42 switching relays [can be found on page 17](#).

Switching Devices

5TT5 Insta contactors

5TT50 Insta contactors, AC/DC technology

Overview

The Insta contactors are the ideal switching device for controlling AC/DC control voltage in industrial applications and infrastructure.

In addition to their basic function, they can also be used for the ON/OFF switching of single-phase and three-phase electrical motors.

The 5TT50 Insta contactors meet the requirements of EN 60947 and are approved to UL 508.

The simultaneous switching of lamp loads at varying phases can be achieved with a single contactor, whereby it is essential to strive for/ensure a symmetrical load of the phases. Upstream short-circuit detection devices must disconnect at all poles or must be equipped with phase failure detection. Violations of the specified capacitor load limits may cause excessive inrush peak currents. The level of inrush peak currents is also affected by the following factors:

- Length and cross-section of the installed supply lines
- Type of electronic ballasts
- Brand/make of lamp



- Insta contactors with O/I automatic function enable the testing of a plant via manual switch without the need to apply a control voltage



- Switching position indication for fast recognition of operating states offers greater safety when checking the plant

Technical specifications

		5TT500 2-pole	5TT503 4-pole	5TT504 4-pole	5TT505 4-pole
Standards		EN 60947-4-1; EN 60947-5-1; EN 61095			
Approvals		UL 508; UL File No. E303328; CCC			
Rated frequency at AC f_n	Hz	50/60			
Rated control voltage U_c	V AC V DC	24, 230 24, 220	24, 115, 230 24, 110, 220	24, 230 24, 230	
Primary operating range	$\times U_c$	0.85 ... 1.1			
Rated operational voltage U_e	V	230	400		
Rated operational current I_e	at V AC	Acc. to UL 480; acc. to IEC 440			
• AC-1/AC-7a, NO contacts	A	20	25	40	63
• AC-1/AC-7a, NC contacts	A	20	25	40	63
• AC-3/AC-7b, NO contacts	A	9	8.5	22	30
• AC-3/AC-7b, NC contacts	A	6	8.5	22	30
Rated power dissipation P_v					
• Pick-up power (without manual switch or manual switch in "I" position)	VA/W	2.1/2.1	2.6/2.6	5/5	5/5
• Pick-up power (with manual switching in "AUTO" position)	VA/W	2.1/4.1	2.6/2.6	5/5	5/5
• Holding power	VA/W	2.1/2.1	2.6/2.6	5/5	5/5
• Per contact AC-1/AC-7a	VA	1.7	2.2	4	8
Switching times					
• Closing (NO contacts)	ms	15 - 45	15 - 45	15 - 20	
• Opening (NO contacts)	ms	20 - 50	20 - 70	35 - 45	
Rated impulse withstand voltage U_{imp}	kV	≤ 4			
Contact gap (S contacts) min.	mm	3.6			
Electrical service life					
At I_e and load	AC-1/AC-7a AC-3/AC-7b	For switch. cycles For switch. cycles	200000 300000	100000	150000
Mechanical service life		For switching cycles	3 million		
Maximum switching frequency					
At load	AC-1/AC-7a AC-3/AC-7b	Switching cycles/h Switching cycles/h	600 600		
Switching of resistive loads AC-1		V AC	230	400	
For rated operational power P_s (NO contacts)					
• Single-phase	kW	4	5.4	8.7	13.3
• Three-phase	kW	--	16	26	40
Switching of three-phase asynchronous motors AC-3		V AC	230	400	
For rated operational power P_s (NO contacts)					
• Single-phase	kW	1.3/0.75	1.3/1.3	3.7/3.7	5/5
• Three-phase	kW	--	4	11	15
Minimum switching capacity		V; mA	$\geq 17; 50$		
Overload withstand capability					
Per conducting path (NO contacts only) at 10 s	A	72	68	176	240
Short-circuit protection, according to coordination type 1					
Back-up fuse characteristic gL/gG	A	20	25	63	80
Terminals	\pm screw (Pozidriv)				
• Coil connection		1	1		
• Main connection		1	2		
Tightening torques					
• Coil connection	Nm	0.6	0.6		
• Main connection	Nm	1.2	3.5		
Conductor cross-sections					
• Coil connection					
- Solid	mm ²	1.0 ... 2.5			
- Stranded, with end sleeve	mm ²	1.0 ... 2.5			
- AWG cables	AWG	16 ... 10			
Tightening torques	lb.in	8			
• Main connection					
- Solid	mm ²	1.0 ... 10	1.5 ... 25		
- Stranded, with end sleeve	mm ²	1.0 ... 6	1.5 ... 16		
- AWG cables	AWG	16 ... 8	16 ... 4		
Tightening torques	lb.in	9	20		
Permissible ambient temperature					
• For operation	°C	-15 ... +55 ¹⁾			
• For storage	°C	-50 ... +80			
Degree of protection	Acc. to DIN EN 60529	IP 20, with connected conductors			
Acc. to UL 508					
UL 508 General Use 240 V/480 V	I_n FLA	A A	20 25	40 40	63 63
UL 508 AC discharge lamps		A	20	30	40
UL 508 motor load 240 V	Power	hp	1	3	7.5
UL 508 motor load 480 V	Power	hp	--	5	15
UL 508 short circuit at 480 V	K5 fuses	A kA	20 5	25 60	70 70

¹⁾ Contactors can be operated at ambient temperatures of between -25 °C and +70 °C, but only under special conditions.

For more information, please contact Siemens Support. For questions concerning heat dissipation, please refer to instructions in the "Switching Devices" configuration manual.

Switching Devices

5TT5 Insta contactors

5TT50 Insta contactors, AC/DC technology

Dimensional drawings

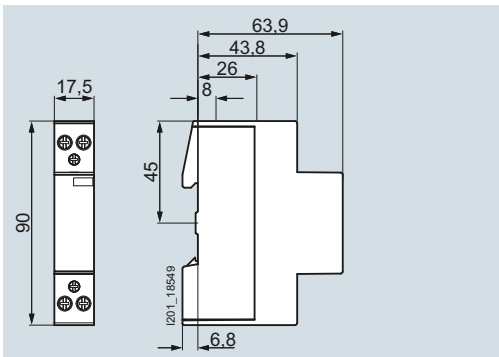

5TT5001-0
5TT5001-2

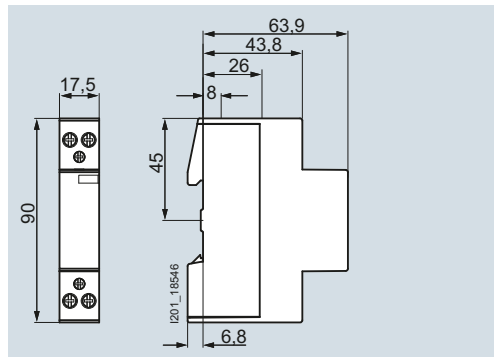

5TT5002-0
5TT5002-2

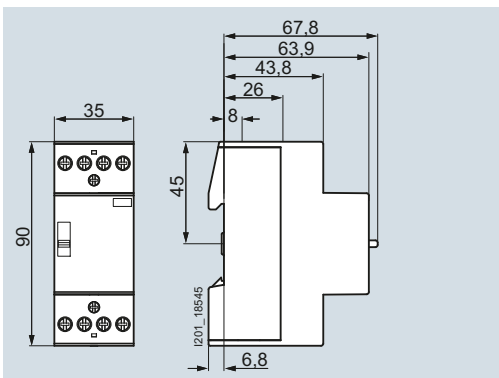

5TT5031-6
5TT5031-8

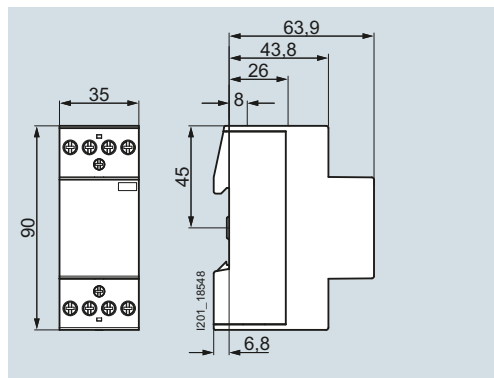

5TT5032-0
5TT5032-2

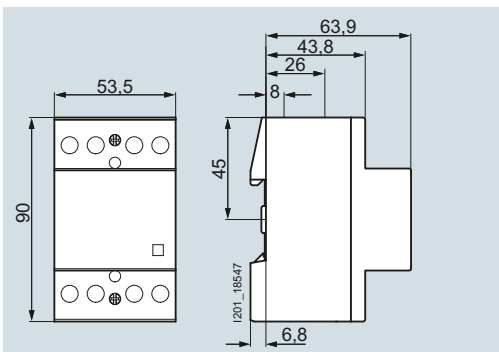

5TT5041-0
5TT5041-2

Circuit diagrams

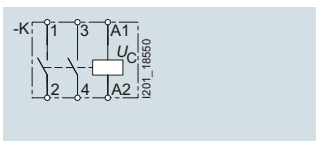

5TT5000

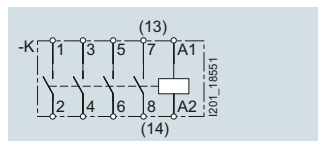

5TT5030
5TT5040
5TT5050

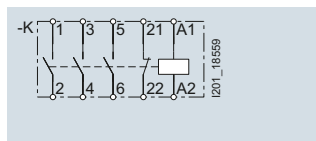

5TT5031
5TT5041
5TT5051

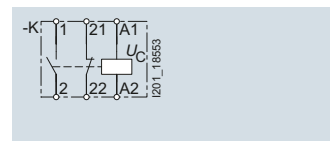

5TT5001

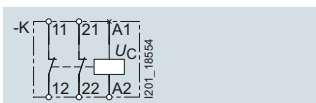

5TT5002

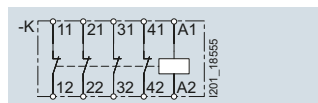

5TT5033
5TT5043

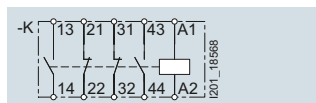

5TT5032
5TT5042
5TT5052

More information

Mounting position of Insta contactors, AC/DC technology

The installation of the devices is permissible in the positions shown in the following diagram (0° to 90°, 270° to 0°). There are no restrictions when the devices are installed in these normal mounting positions.

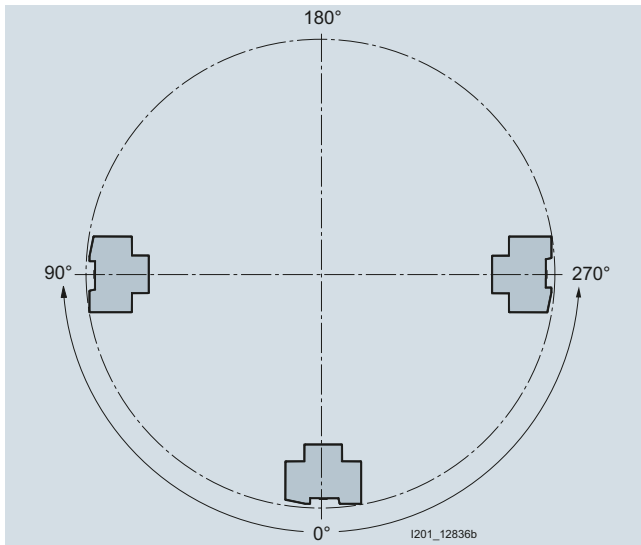

Heat dissipation

If several Insta contactors with AC magnet system are mounted in series in a distribution board, there are no restrictions for the types 25 A, 40 A and 63 A within the permissible ambient temperature range up to 55 °C. For 20 A types within the temperature range up to 40 °C, a 5TG8240 spacer must be installed after every third Insta contactor, and in the temperature range above 40 °C to 55 °C, after every second contactor.

Manual switching with O/I/Automatic function

The 5TT50... versions also offer manual switching. The knob allows preselection of 3 positions:

- Knob in the "AUTO" position
Automatic mode → normal protective function
- Knob in the "I" position
Continuous operation → switched on manually (without control signal; when a control signal is applied, the manual switching is unlocked, i.e. the knob is automatically reset to the "AUTO" position)
- Knob in the "O" position
Off → switched off (coil circuit interrupted)

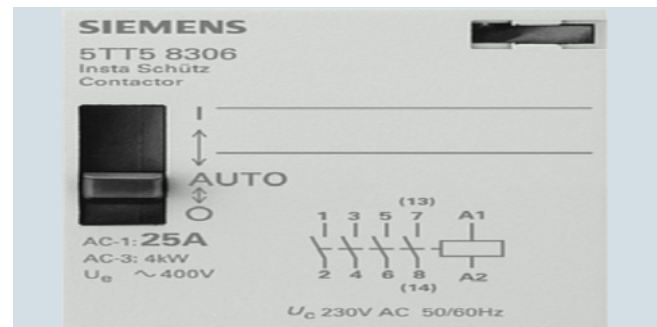

System test without applying a control voltage

Insta contactors with O/I/Automatic function enable the testing of a plant by manual switching without the need to apply a control voltage.

Automatic resetting through control signal

When applying a control signal to the terminals A1 and A2, the Insta contactors can be reset from continuous operation mode ("I" position) to automatic mode ("AUTO" position).

Switching Devices

5TT5 Insta contactors

5TT50 Insta contactors, AC/DC technology

Switching of alternating voltages DC-1

Permissible DC switching currents for NO contacts with resistive load				1 contact	2 contacts in series	3 contacts in series	4 contacts in series
5TT500	2-pole, 20 A	I_e for	$U_e = 24$ V DC	A 20	20	--	--
			$U_e = 110$ V DC	A 6	10	--	--
			$U_e = 220$ V DC	A 0.6	6	--	--
5TT503	4-pole, 25 A	I_e for	$U_e = 24$ V DC	A 25	25	25	25
			$U_e = 110$ V DC	A 6	10	20	20
			$U_e = 220$ V DC	A 0.6	6	15	15
5TT504	4-pole, 40 A	I_e for	$U_e = 24$ V DC	A 40	40	40	40
			$U_e = 110$ V DC	A 4	10	30	40
			$U_e = 220$ V DC	A 1.2	8	20	40
5TT505	4-pole, 63 A	I_e for	$U_e = 24$ V DC	A 63	63	63	63
			$U_e = 110$ V DC	A 4	10	35	63
			$U_e = 220$ V DC	A 1.2	8	30	63

Switching of lamps

Incandescent lamp loads, lamp type			1000 W	500 W	200 W	100 W	60 W
5TT500 , 2-pole	20 A	Per NO/NC	1	3	10	20	33
5TT503 , 4-pole	25 A	Per NO/NC	1	3	10	20	33
5TT504 , 4-pole	40 A	Per NO/NC	4	8	20	40	65
5TT505 , 4-pole	63 A	Per NO/NC	5	10	25	50	85

Maximum number of lamps in units, per NO contact/NC contact at 230 V AC, 50 Hz.

Fluorescent and compact lamps in ballast operation (permissible number of lamps in units per NO contact/NC contact at 230 V AC, 50 Hz)

Lamp type	W	Capacitance μ F	Uncorrected			Parallel-corrected			DUO switching, 2-lamp		
			L18	L36	L58	L18	L36	L58	2 × L18	2 × L36	2 × L58
5TT500 , 2-pole	20 A	Per NO/NC	22	17	14	7	7	4	30	17	10
5TT503 , 4-pole	25 A	Per NO/NC	24	20	17	8	8	5	40	24	14
5TT504 , 4-pole	40 A	Per NO/NC	90	65	45	48	48	31	100	65	40
5TT505 , 4-pole	63 A	Per NO/NC	140	95	70	73	73	47	150	95	60

Fluorescent and compact lamps with electronic ballast (ECG) (permissible number of lamps in units per NO contact/NC contact at 230 V AC, 50 Hz)

Lamp type	W	1 lamp			2 lamp			
		1 × L18	1 × L36	1 × L58	2 × L18	2 × L36	2 × L58	
5TT500 , 2-pole	20 A	Per NO/NC	25	15	14	12	7	7
5TT503 , 4-pole	25 A	Per NO/NC	35	20	19	17	10	9
5TT504 , 4-pole	40 A	Per NO/NC	100	52	50	50	26	25
5TT505 , 4-pole	63 A	Per NO/NC	140	75	72	70	38	36

High-pressure mercury-vapor lamps (HQL) (permissible number of lamps in units per NO contact/NC contact at 230 V AC, 50 Hz)

Lamp type	W	Capacitance μ F	Uncorrected							Parallel-corrected						
			50	80	125	250	400	700	1000	50	80	125	250	400	700	1000
5TT500 , 2-pole	20 A	Per NO/NC	14	10	7	4	2	1	1	4	4	3	1	1	0	0
5TT503 , 4-pole	25 A	Per NO/NC	18	13	9	5	3	2	1	5	5	4	2	1	0	0
5TT504 , 4-pole	40 A	Per NO/NC	38	29	20	10	7	4	3	31	27	22	12	9	5	4
5TT505 , 4-pole	63 A	Per NO/NC	55	42	29	15	10	6	4	47	41	33	18	13	7	5

Halogen metal-vapor lamps (HQI)

(permissible number of lamps in units per NO contact/NC contact at 230 V AC, 50 Hz)

Lamp type Capacitance	W μF	Uncorrected					Parallel-corrected					With electronic ballast PCI						
		70	150	250	400	1000	2000	70	150	250	400	1000	2000	20	35	70	150	
5TT500, 2-pole	20 A	Per NO/NC	10	5	3	3	1	0	2	1	0	0	0	0	9	6	5	4
5TT503, 4-pole	25 A	Per NO/NC	12	7	4	3	1	0	3	1	1	0	0	9	6	5	4	
5TT504, 4-pole	40 A	Per NO/NC	23	12	7	6	2	1	18	11	6	6	2	1	18	11	10	8
5TT505, 4-pole	63 A	Per NO/NC	32	18	10	9	3	1	25	15	9	8	3	2	20	13	12	10

High-pressure sodium-vapor lamps (NAV)

(permissible number of lamps in units per NO contact/NC contact at 230 V AC, 50 Hz)

Lamp type Capacitance	W μF	Uncorrected				Parallel-corrected				With electronic ballast PCI				
		150	250	400	1000	150	250	400	1000	20	35	70	150	
5TT500, 2-pole	20 A	Per NO/NC	5	3	2	0	1	0	0	0	9	6	5	4
5TT503, 4-pole	25 A	Per NO/NC	6	4	2	1	1	1	0	0	9	6	5	4
5TT504, 4-pole	40 A	Per NO/NC	17	10	6	3	11	6	4	2	18	11	10	8
5TT505, 4-pole	63 A	Per NO/NC	22	13	8	3	16	10	6	3	20	13	12	12

Low-pressure sodium-vapor lamps

(permissible number of lamps in units per NO contact/NC contact at 230 V AC, 50 Hz)

Lamp type Capacitance	W μF	Uncorrected					Parallel-corrected							
		18	35	55	90	135	180	18	35	55	90	135	180	
5TT500, 2-pole	20 A	Per NO/NC	22	7	7	4	3	3	6	1	1	1	--	--
5TT503, 4-pole	25 A	Per NO/NC	27	9	9	5	4	4	7	1	1	1	--	--
5TT504, 4-pole	40 A	Per NO/NC	71	23	23	14	10	10	44	11	11	8	4	5
5TT505, 4-pole	63 A	Per NO/NC	90	30	30	19	13	13	66	16	16	12	7	8

Lumilux T5 type FC fluorescent lamps with electronic ballast (ECG)

(permissible number of lamps in units per NO contact/NC contact at 230 V AC, 50 Hz)

Lamp type	W	1 lamp			2 lamp			
		22	40	55	2 × 22	2 × 40	2 × 55	
5TT500, 2-pole	20 A	Per NO/NC	22	12	8	11	6	4
5TT503, 4-pole	25 A	Per NO/NC	30	15	12	15	7	6
5TT504, 4-pole	40 A	Per NO/NC	80	40	30	40	20	15
5TT505, 4-pole	63 A	Per NO/NC	110	60	45	55	30	22

Lumilux T5 type HE fluorescent lamps with electronic ballast (ECG)

(permissible number of lamps in units per NO contact/NC contact at 230 V AC, 50 Hz)

Lamp type	W	1 lamp				2 lamp				
		14	21	28	35	2 × 14	2 × 21	2 × 28	2 × 35	
5TT500, 2-pole	20 A	Per NO/NC	30	22	18	14	15	11	9	7
5TT503, 4-pole	25 A	Per NO/NC	40	30	22	18	20	15	11	9
5TT504, 4-pole	40 A	Per NO/NC	105	80	60	48	52	40	30	24
5TT505, 4-pole	63 A	Per NO/NC	150	115	90	70	75	57	45	35

Lumilux T5 type HO fluorescent lamps with electronic ballast (ECG)

(permissible number of lamps in units per NO contact/NC contact at 230 V AC, 50 Hz)

Lamp type	W	1 lamp					2 lamp					
		24	39	49	54	80	2 × 24	2 × 39	2 × 49	2 × 54	2 × 80	
5TT500, 2-pole	20 A	Per NO/NC	20	12	10	9	6	10	6	5	4	3
5TT503, 4-pole	25 A	Per NO/NC	26	16	14	13	8	13	8	7	6	4
5TT504, 4-pole	40 A	Per NO/NC	70	42	35	32	22	35	21	17	16	11
5TT505, 4-pole	63 A	Per NO/NC	100	62	52	47	32	50	31	26	23	16

Switching Devices

5TT5 Insta contactors

5TT58 Insta contactors, AC technology

Overview

The 5TT58 Insta contactors are equipped with an AC magnet system and are ideal for use under harsh conditions. The auxiliary switches can be mounted without tools. When equipped with terminal covers, the devices can also be sealed.



- Extremely long service life of 3 million switching cycles
- Safe cable routing through the cable entry funnel
- Insulated right through to the cable entry funnel
- Auxiliary switches can be retrofitted on all versions - even on the 20 A type

Insta contactors without manual switch

Insta contactors are ideal for a wide range of uses in industry, such as for motors where distribution technology plays a major role, e.g. in installations for heat pumps and air conditioning technology. In addition to their basic function, they can also be used for the ON/OFF switching of single-phase and three-phase electrical motors.

Insta contactors with manual switch

Insta contactors with manual operation can be switched on and off by hand.

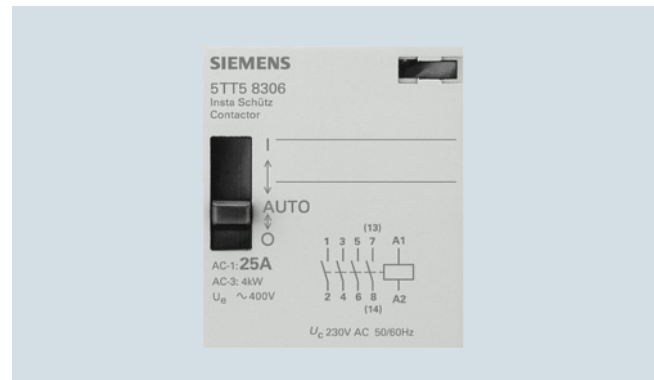

- Insta contactors with O/I/Automatic function enable the testing of a plant by manual switch without the need to apply a control voltage
- Switching position indication for fast recognition of operating states offers greater safety when checking the plant

Technical specifications

			Insta contactors				Auxiliary switches				
			5TT580.	5TT582., 5TT583.	5TT584.	5TT585.	5TT5910				
Standards			IEC 60947-4-1, IEC 60947-5-1, IEC 61095; EN 60947-4-1, EN 60947-5-1, EN 61095, VDE 0660 CCC				IEC 60947-5-1				
Approvals											
Number of poles			2	4	4	4	2				
Rated frequency at AC			Hz				50/60				
Rated control voltage U_c			V AC		24, 230	24, 115, 230	24, 230	24, 230	--		
Primary operating range			$\times U_c$		0.85 ... 1.1				--		
Rated operational voltage U_e			V AC		230	400		230/400			
Rated operational current I_e			A		20	25	40	63	6/4 (230/400 V)		
Rated power dissipation P_v			VA/W		6/3.8	10/5	15.4/6		--		
• Pick-up power (without manual switch or manual switch in "I" position)			VA/W		12/10	33/25	62/50		--		
• Pick-up power (with manual switching in "AUTO" position)			VA/W		2.8/1.2	5.5/1.6	7.7/3		--		
• Holding power			VA/W		1.7	2.2	4	8	--		
• Per contact			VA						--		
Switching times											
• Closing (NO contacts)			ms		15 ... 25	10 ... 20	15 ... 20		--		
• Opening (NO contacts)			ms		20	20	10		--		
• Closing (NC contacts)			ms		20 ... 30	20 ... 30	5 ... 10		--		
• Opening (NC contacts)			ms		10	10	10 ... 15		--		
Rated impulse withstand voltage U_{imp}			kV		4						
Rated insulation voltage U_i			V		440		500				
Contact gap, minimum			mm		3.6		3.4		4		
Electrical service life											
At I_e and load											
• AC-1/AC-7a			For switching cycles		200000		100000		--		
• AC-3/AC-7b			For switching cycles		300000		500000		150000		
Mechanical service life			For switching cycles		3 million						
Maximum switching frequency											
At load			In switching cycles/h		600						
Switching of resistive loads AC-1/AC-7a											
For rated operational power P_s											
• Single-phase 230 V			kW		4	5.4	8.7	13.3	--		
• Three-phase 400 V			kW		--	16	26	40	--		
Switching of three-phase asynchronous motors AC-3/AC-7b											
For rated operational power P_s											
• Single-phase 230 V			kW		1.3 ¹⁾	1.3	3.7	5	--		
• Three-phase 400 V			kW		--	4	11	15	--		
Minimum switching capacity			V; mA		17; 50				12; 5		
Overload withstand capability											
Per conducting path			At 10 s		A		72	68	176	240	--
(NO contacts only)											
Short-circuit protection, according to coordination type 1											
Back-up fuse characteristic gL/gG			A		20	25	63	80	6		
Terminals			\pm screw (Pozidriv)								
• Coil connection					1		1.2		--		
• Main connection					1		3.5		1		
Tightening torques											
• Coil connection			Nm		0.6				--		
• Main connection			Nm		1.2		2		0.8		
Conductor cross-sections											
• Coil connection			Rigid		mm ²		1.0 ... 2.5		--		
			Flexible,		mm ²		1.0 ... 2.5		--		
			with end sleeve								
• Main connection			Rigid		mm ²		1.0 ... 10		1 ... 2.5		
			Flexible,		mm ²		1.0 ... 6		1 ... 2.5		
			with end sleeve				1 ... 16				
Permissible ambient temperature²⁾											
• For operation			°C		-5 ... +55						
• For storage			°C		-30 ... +80						
Degree of protection			Acc. to EN 60529		IP20, with connected conductors						

¹⁾ For NO contacts only.

²⁾ For questions concerning heat dissipation, please refer to instructions in the "Switching Devices" configuration manual.

Switching Devices

5TT5 Insta contactors

5TT58 Insta contactors, AC technology

Switching of alternating voltages DC-1

Permissible DC switching currents for NO contacts with resistive load				1 contact	2 contacts in series	3 contacts in series	4 contacts in series
5TT580	2-pole, 20 A	I_e for	$U_e = 24$ V DC	A 20	20	--	--
			$U_e = 110$ V DC	A 6	10	--	--
			$U_e = 220$ V DC	A 0.6	6	--	--
5TT582, 5TT583	4-pole, 25 A	I_e for	$U_e = 24$ V DC	A 25	25	25	25
			$U_e = 110$ V DC	A 6	10	20	20
			$U_e = 220$ V DC	A 0.6	6	15	15
5TT584	4-pole, 40 A	I_e for	$U_e = 24$ V DC	A 40	40	40	40
			$U_e = 110$ V DC	A 4	10	30	40
			$U_e = 220$ V DC	A 1.2	8	20	40
5TT585	4-pole, 63 A	I_e for	$U_e = 24$ V DC	A 63	63	63	63
			$U_e = 110$ V DC	A 4	10	35	63
			$U_e = 220$ V DC	A 1.2	8	30	63

Switching of lamps

Incandescent lamp loads, lamp type				1000 W	500 W	200 W	100 W	60 W
5TT580	2-pole	20 A	Per NO/NC	1	3	10	20	33
5TT582	4-pole	25 A	Per NO/NC	2	4	10	20	33
5TT583	4-pole	25 A	Per NO/NC	1	3	10	20	33
5TT584	4-pole	40 A	Per NO/NC	4	8	20	40	65
5TT585	4-pole	63 A	Per NO/NC	5	10	25	50	85

Maximum number of lamps in units, per NO contact/NC contact at 230 V AC, 50 Hz.

Fluorescent and compact lamps in ballast operation

(permissible number of lamps in units per NO contact/NC contact at 230 V AC, 50 Hz)

Lamp type	W	Capacitance μ F	Uncorrected			Parallel-corrected			DUO switching, 2-lamp			
			L18	L36	L58	L18	L36	L58	2 x L18	2 x L36	2 x L58	
5TT580	2-pole	20 A	Per NO/NC	22	17	14	7	7	4	30	17	10
5TT582	4-pole	25 A	Per NO/NC	41	41	28	33	33	21	54	36	19
5TT583	4-pole	25 A	Per NO/NC	24	20	17	8	8	5	40	24	14
5TT584	4-pole	40 A	Per NO/NC	90	65	45	48	48	31	100	65	40
5TT585	4-pole	63 A	Per NO/NC	140	95	70	73	73	47	150	95	60

Fluorescent and compact lamps with electronic ballast (ECG)

(permissible number of lamps in units per NO contact/NC contact at 230 V AC, 50 Hz)

Lamp type	W	1 lamp			2 lamp				
		1 x L18	1 x L36	1 x L58	2 x L18	2 x L36	2 x L58		
5TT580	2-pole	20 A	Per NO/NC	25	15	14	12	7	7
5TT582	4-pole	25 A	Per NO/NC	35	20	19	17	10	9
5TT583	4-pole	25 A	Per NO/NC	35	20	19	17	10	9
5TT584	4-pole	40 A	Per NO/NC	100	52	50	50	26	25
5TT585	4-pole	63 A	Per NO/NC	140	75	72	70	38	36

High-pressure mercury-vapor lamps (HQL)

(permissible number of lamps in units per NO contact/NC contact at 230 V AC, 50 Hz)

Lamp type	W	Uncorrected							Parallel-corrected								
		50	80	125	250	400	700	1000	50	80	125	250	400	700	1000		
5TT580	2-pole	20 A	Per NO/NC	14	10	7	4	2	1	1	4	4	3	1	1	0	0
5TT582	4-pole	25 A	Per NO/NC	18	13	9	5	3	2	1	21	18	15	8	6	3	2
5TT583	4-pole	25 A	Per NO/NC	18	13	9	5	3	2	1	5	5	4	2	1	0	0
5TT584	4-pole	40 A	Per NO/NC	38	29	20	10	7	4	3	31	27	22	12	9	5	4
5TT585	4-pole	63 A	Per NO/NC	55	42	29	15	10	6	4	47	41	33	18	13	7	5

Halogen metal-vapor lamps (HQI)*(permissible number of lamps in units per NO contact/NC contact at 230 V AC, 50 Hz)*

Lamp type Capacitance	W μF	Uncorrected						Parallel-corrected						With electronic ballast PCI				
		70	150	250	400	1000	2000	70	150	250	400	1000	2000	20	35	70	150	
5TT580, 2-pole	20 A	Per NO/NC	10	5	3	3	1	0	2	1	0	0	0	0	9	6	5	4
5TT582, 4-pole	25 A	Per NO/NC	12	7	4	3	1	0	12	7	4	4	1	1	9	6	5	4
5TT583, 4-pole	25 A	Per NO/NC	12	7	4	3	1	0	3	1	1	0	0	9	6	5	4	
5TT584, 4-pole	40 A	Per NO/NC	23	12	7	6	2	1	18	11	6	6	2	1	18	11	10	8
5TT585, 4-pole	63 A	Per NO/NC	32	18	10	9	3	1	25	15	9	8	3	2	20	13	12	10

High-pressure sodium-vapor lamps (NAV)*(permissible number of lamps in units per NO contact/NC contact at 230 V AC, 50 Hz)*

Lamp type Capacitance	W μF	Uncorrected				Parallel-corrected				With electronic ballast PCI			
		150	250	400	1000	150	250	400	1000	20	35	70	150
5TT580, 2-pole	20 A	Per NO/NC	5	3	2	0	1	0	0	9	6	5	4
5TT582, 4-pole	25 A	Per NO/NC	6	4	2	1	7	4	3	1	9	6	5
5TT583, 4-pole	25 A	Per NO/NC	6	4	2	1	1	1	0	9	6	5	4
5TT584, 4-pole	40 A	Per NO/NC	17	10	6	3	11	6	4	2	18	11	10
5TT585, 4-pole	63 A	Per NO/NC	22	13	8	3	16	10	6	3	20	13	12

Low-pressure sodium-vapor lamps*(permissible number of lamps in units per NO contact/NC contact at 230 V AC, 50 Hz)*

Lamp type Capacitance	W μF	Uncorrected					Parallel-corrected							
		18	35	55	90	135	180	18	35	55	90	135	180	
5TT580, 2-pole	20 A	Per NO/NC	22	7	7	4	3	3	6	1	1	1	--	--
5TT582, 4-pole	25 A	Per NO/NC	27	9	9	5	4	4	30	7	7	5	3	3
5TT583, 4-pole	25 A	Per NO/NC	27	9	9	5	4	4	7	1	1	1	--	--
5TT584, 4-pole	40 A	Per NO/NC	71	23	23	14	10	10	44	11	11	8	4	5
5TT585, 4-pole	63 A	Per NO/NC	90	30	30	19	13	13	66	16	16	12	7	8

Lumilux T5 type FC fluorescent lamps with electronic ballast (ECG)*(permissible number of lamps in units per NO contact/NC contact at 230 V AC, 50 Hz)*

Lamp type	W	1 lamp			2 lamp			
		22	40	55	2 × 22	2 × 40	2 × 55	
5TT580, 2-pole	20 A	Per NO/NC	22	12	8	11	6	4
5TT582, 4-pole	25 A	Per NO/NC	30	15	12	15	7	6
5TT583, 4-pole	25 A	Per NO/NC	30	15	12	15	7	6
5TT584, 4-pole	40 A	Per NO/NC	80	40	30	40	20	15
5TT585, 4-pole	63 A	Per NO/NC	110	60	45	55	30	22

Lumilux T5 type HE fluorescent lamps with electronic ballast (ECG)*(permissible number of lamps in units per NO contact/NC contact at 230 V AC, 50 Hz)*

Lamp type	W	1 lamp				2 lamp				
		14	21	28	35	2 × 14	2 × 21	2 × 28	2 × 35	
5TT580, 2-pole	20 A	Per NO/NC	30	22	18	14	15	11	9	7
5TT582, 4-pole	25 A	Per NO/NC	40	30	22	18	20	15	11	9
5TT583, 4-pole	25 A	Per NO/NC	40	30	22	18	20	15	11	9
5TT584, 4-pole	40 A	Per NO/NC	105	80	60	48	52	40	30	24
5TT585, 4-pole	63 A	Per NO/NC	150	115	90	70	75	57	45	35

Lumilux T5 type HO fluorescent lamps with electronic ballast (ECG)*(permissible number of lamps in units per NO contact/NC contact at 230 V AC, 50 Hz)*

Lamp type	W	1 lamp					2 lamp					
		24	39	49	54	80	2 × 24	2 × 39	2 × 49	2 × 54	2 × 80	
5TT580, 2-pole	20 A	Per NO/NC	20	12	10	9	6	10	6	5	4	3
5TT582, 4-pole	25 A	Per NO/NC	26	16	14	13	8	13	8	7	6	4
5TT583, 4-pole	25 A	Per NO/NC	26	16	14	13	8	13	8	7	6	4
5TT584, 4-pole	40 A	Per NO/NC	70	42	35	32	22	35	21	17	16	11
5TT585, 4-pole	63 A	Per NO/NC	100	62	52	47	32	50	31	26	23	16

Switching Devices

5TT5 Insta contactors

5TT58 Insta contactors, AC technology

Dimensional drawings

Insta contactors, AC technology

Without manual switching

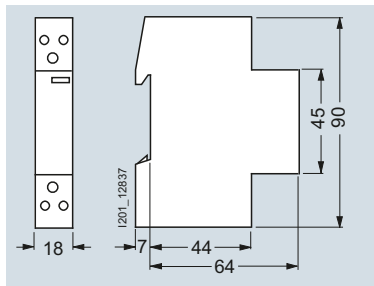

5TT580.-0
5TT580.-2

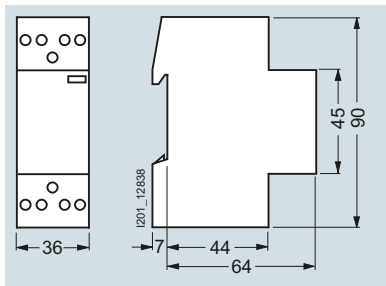

5TT5820-0
5TT583.-0
5TT583.-2

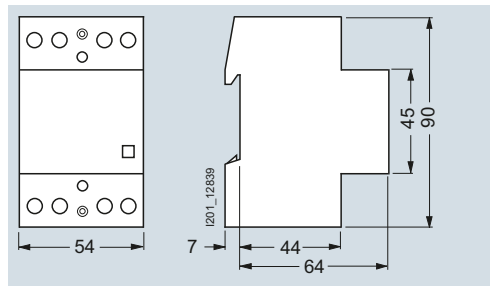

5TT584.-0
5TT584.-2
5TT585.-0
5TT585.-2

with manual switching

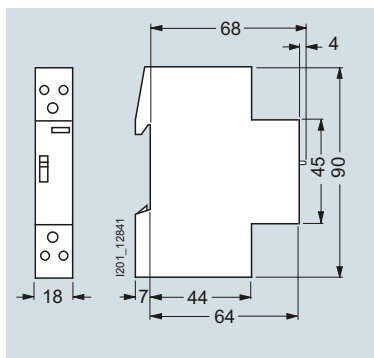

5TT580.-6
5TT580.-8

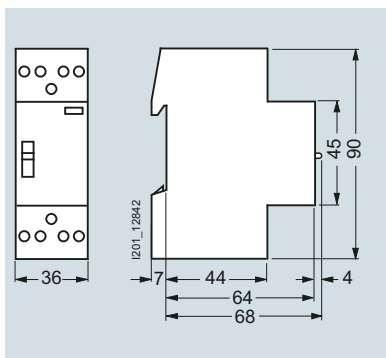

5TT583.-6
5TT583.-8

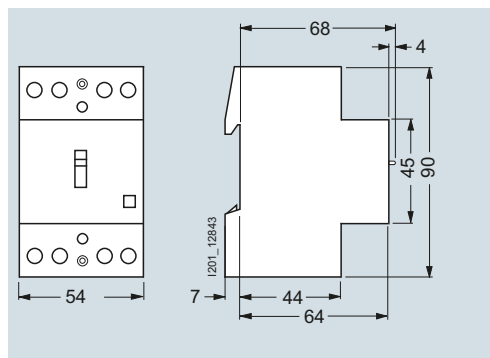

5TT584.-6
5TT584.-8
5TT585.-6

Auxiliary switches

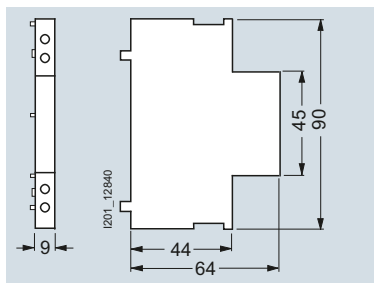

5TT5910-0
5TT5910-1

Circuit diagrams

Graphic symbols

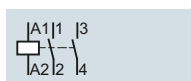

5TT5800

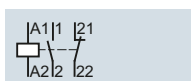

5TT5801

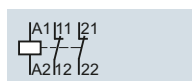

5TT5802

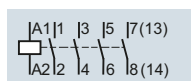

5TT5820
5TT5830
5TT5840
5TT5850

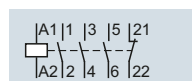

5TT5831
5TT5841
5TT5851

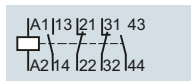

5TT5832
5TT5842
5TT5852

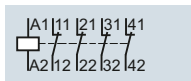

5TT5833
5TT5843
5TT5853



5TT5910-0



5TT5910-1

More information

Mounting position, Insta contactors, AC technology

The installation of the devices is permissible in the positions shown in the following diagram (0° to 90°, 270° to 0°). There are no restrictions when the devices are installed in these normal mounting positions.

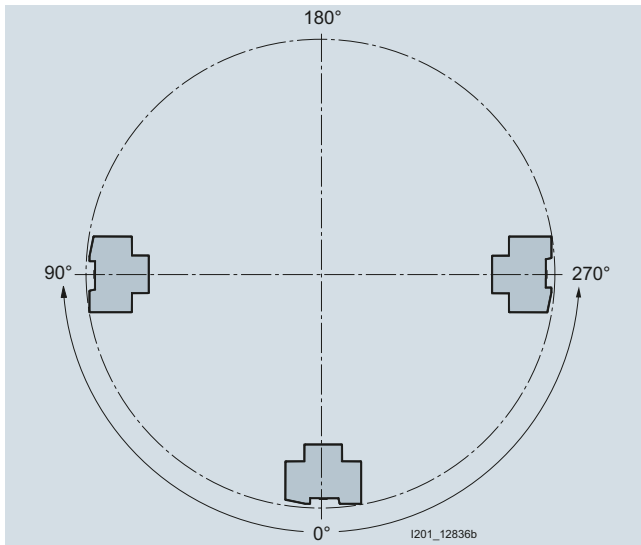

Heat dissipation

If several Insta contactors with AC magnet system are mounted in series in a distribution board, there are no restrictions for the types 25 A, 40 A and 63 A within the permissible ambient temperature range up to 55 °C. For 20 A types within the temperature range up to 40 °C, a 5TG8240 spacer must be installed after every third Insta contactor, and in the temperature range above 40 °C to 55 °C, after every second contactor.

Manual switching with O//Automatic function

The 5TT58...-6 and 5TT58...-8 versions also offer manual switching. The knob allows preselection of 3 positions:

- Knob in the "AUTO" position
Automatic mode → normal protective function
- Knob in the "I" position
Continuous operation → switched on manually (without control signal; when a control signal is applied, the manual switching is unlocked, i.e. the knob is automatically reset to the "AUTO" position)
- Knob in the "O" position
Off → switched off (coil circuit interrupted)

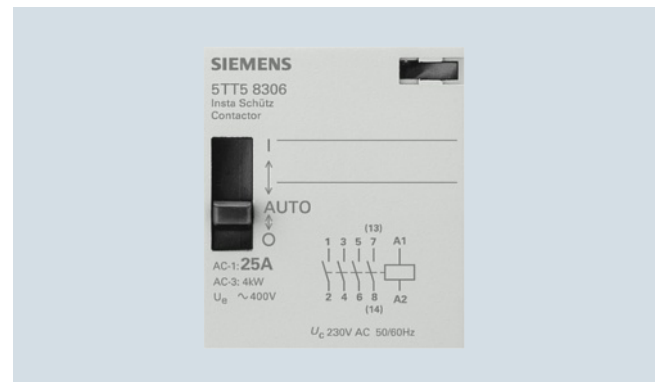

System test without applying a control voltage

Insta contactors with O//Automatic function enable the testing of a plant by manual switching without the need to apply a control voltage.

Automatic resetting through control signal

When applying a control signal to the terminals A1 and A2, the Insta contactors can be reset from continuous operation mode ("I" position) to automatic mode ("AUTO" position).

Switching Devices

5TT3 soft-starting devices

Overview

The soft-starting device is an electronic control unit for the soft startup of single-phase asynchronous machines. A phase control causes the current to rise steadily. This also increases the motor torque and the drive starts up smoothly. The starting current is minimized. There is no speed adjustment. There is no marked soft start behavior without a mechanically connected load.

If the power semiconductor is to be protected against short-circuits or ground faults during startup, a quick-acting fuse must be installed. In the case of high switching frequencies, we recommend installing a thermistor motor protection for monitoring the permissible motor temperature.

The soft-starting device must not be operated with capacitive load. It can be retrofitted in existing plants at any time.

Technical specifications

		5TT3440	5TT3441
Standards		EN 60947-4-2 (VDE 0660-117)	
Supply/motor voltage	V AC	400	230
Primary operating range	$\times U_c$	0.8 ... 1.1	
Rated power	VA	3.5	1.4
Rated frequency	Hz	50/60	
Rated power dissipation P_v	Coil/drive Contact ¹⁾ per pole	3.5 4.6	1.7 0.7
Rated output of motor			
- Max.	At 400 V	VA	5500
- Min.	At 400 V	VA	300
Startup voltage		%	30 ... 70
Starting ramp		s	0.1 ... 10
Recovery time		ms	100
Switching frequency			
$3 \times I_N, T_{AN} = 10 \text{ s}, v_U = 20 \%$		Switching cycles/h	36 (up to 3 kW)
$3 \times I_N, T_{AN} = 10 \text{ s}, v_U = 20 \%$		Switching cycles/h	20 (from 3...5.5 kW)
Semiconductor fuse	Quick-acting	A	35
Conductor cross-sections	Rigid Flexible, with end sleeve	max. mm ² min. mm ²	2 x 2.5 1 x 0.5
Permissible ambient temperature		°C	-20 ... +60
Climatic withstand capability	Acc. to EN 60068-1		20/60/4

¹⁾ For rated operational current.

Dimensional drawings

5TT344. soft-starting device

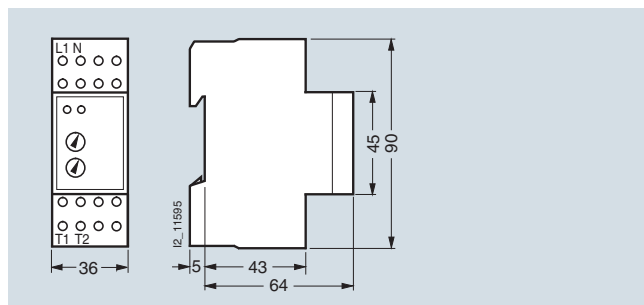

5TT3441

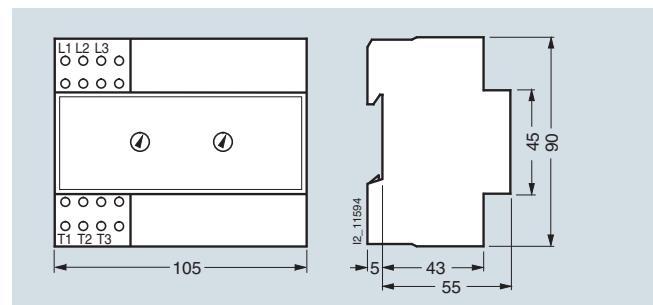

5TT3440

Circuit diagrams

Typical circuit for 5TT3441

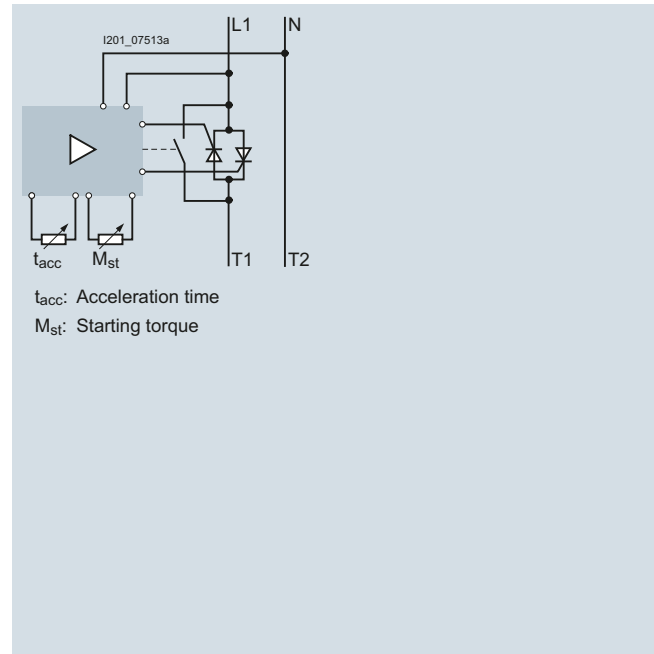
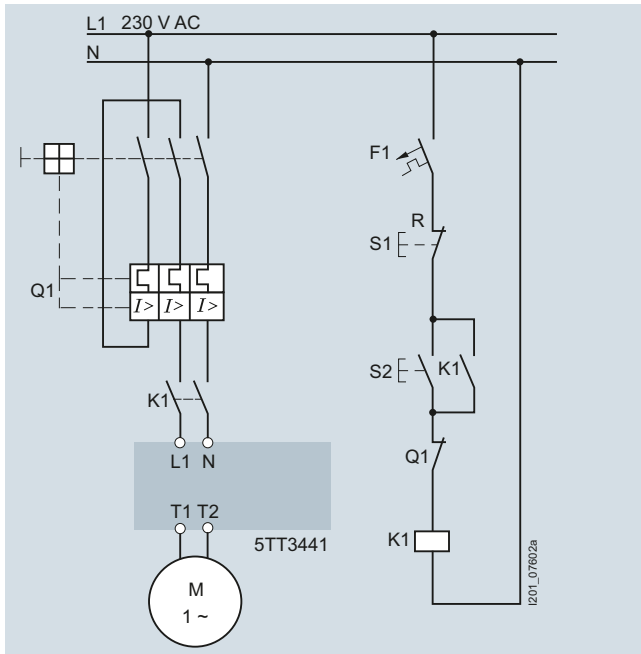

Typical circuit for 5TT3440

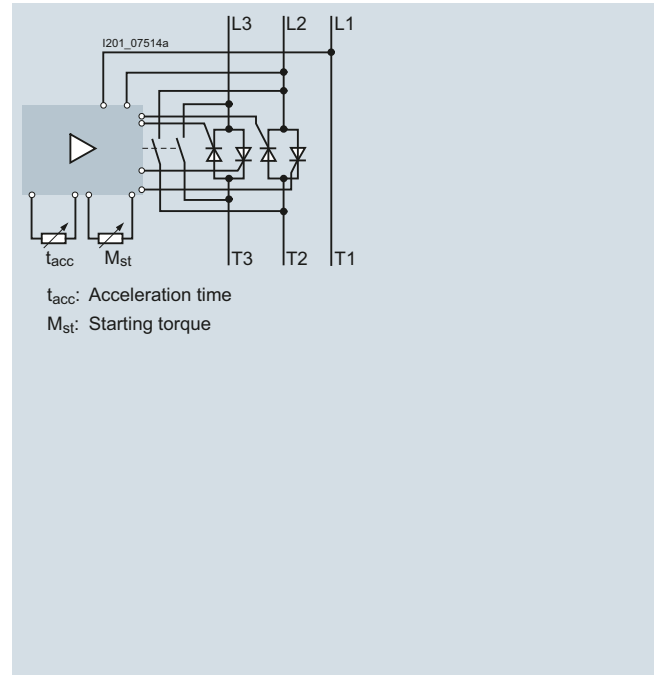
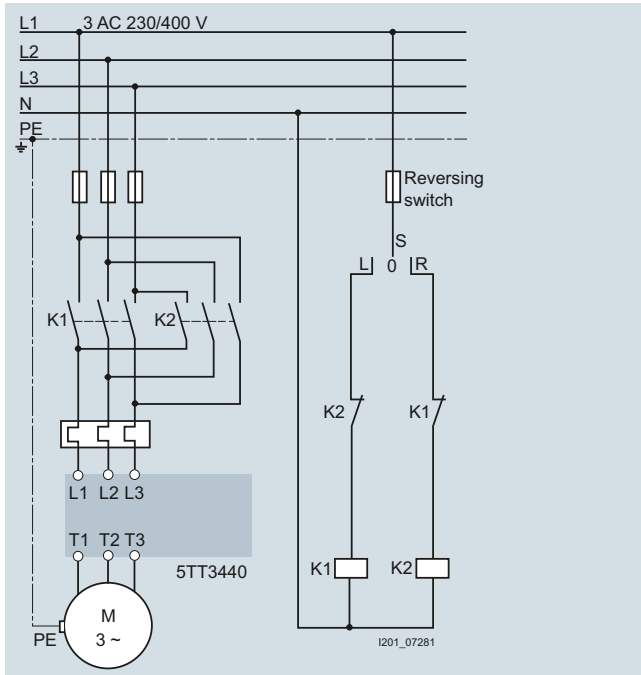

Switching Devices

Controls

Overview

Switching on loads

The increased making currents of different loads and thus the risk of contacts welding is often underestimated.

Resistive load:

The resistive load, e.g. electric heating, does not increase the making current.

Incandescent lamps:

The cold coiled filament in incandescent lamps or halogen lamps causes a 6 to 10-fold making current for approx. 10 ms.

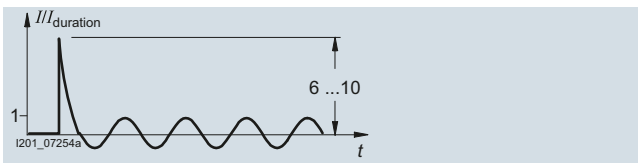

Uncorrected fluorescent lamps:

When switched on over several periods, the heating current of the coiled filament and the operational current produce a 2 to 2.5-fold inductive current.

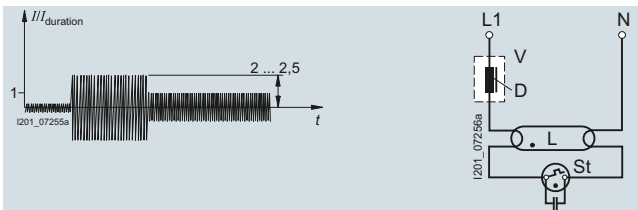

Fluorescent lamps with parallel compensation:

When switched on, the capacitor causes an extreme, up to 13-fold, current for approx. 10 ms.

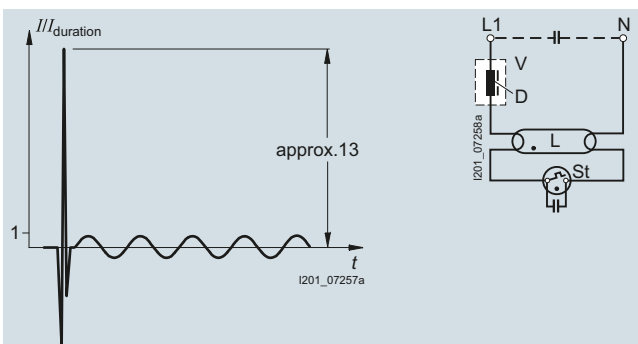

Fluorescent lamps in duo connection:

The series capacitor results in compensation. In spite of this, an increased making current is produced over several periods, just as for uncorrected fluorescent lamps.

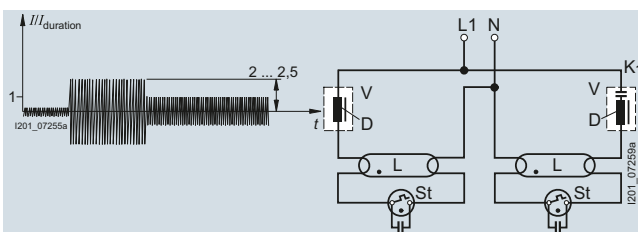

Selecting contacts for lighting systems

A wide range of different contacts are used for modular installation devices:

- Contactor contacts with > 3 mm contact gap, as for Insta contactors, AC technology
- Switching relay contacts with m contacts (contact gap > 1.2 mm but < 3 mm)
- Manually operated contacts with > 3 mm contact gap, as for 5TE8 switches
- Relay contacts with μ contacts (contact gap > 0.5 mm), like those used on the printed boards of electronic devices

The selection tables in the Technical Specifications will help you to find the correct switching device for the different lighting installations.

Switching off loads

If a contact with current flowing through it opens, this always ignites an electric arc above 24 to 30 V. This arc depends on voltage, length of isolating distance, speed of contact, actuating angle and amperage. The principle of the so-called zero cutoff is that after no more than 1½ half-waves, the electric arc is quenched in the zero point. There are no further quenching aids or current limiters, as is the case with miniature circuit breakers.

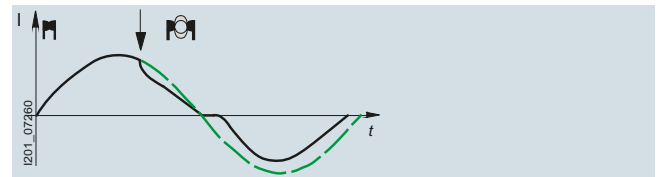

Switching off direct currents

When switching direct voltages, there is no zero passage of current for the arc to be interrupted. To be able to switch significant currents despite this, contacts are connected in series to increase the isolating distance.

Some switching devices are provided with planning data for switching direct currents. Compliance with these planning data is essential. If the data values are exceeded the electric arc is not reliably quenched and there is a risk of fire.



Safe separation

When operating 230 V and safety extra-low voltage SELV – voltage of bell transformers or transformers for permanent load – on a device, it is essential to ensure "safe separation". At least 8 mm of creepage and air clearances and a withstand voltage of more than 4 kV is needed for this. If these conditions – 8 mm or 4 kV – are not fulfilled, the term "electrical separation" as "not SELV" is used instead of the term "safe separation".

Overview

Today, time switching is a matter of course.

In fact, it is now hard to imagine many process sequences and energy saving processes without time switching. It could also be argued that time switching satisfies a basic need in the electrical installation sector.

New-generation digital time switches have a wider variety of functions than their predecessors and are easier to operate, thanks to better possible solutions.

They can be used to switch systems or devices or for functions such as: irrigation plants, hothouses, garden systems, swimming pools, filter systems, canopy controls, break signals, bell chimes, shop-window lighting, illuminated advertising, sports-hall lighting, traffic-light controls, street lighting, illuminated signs, office lighting, stairway and entrance lighting, object lighting, preheating of industrial furnaces, injection-molding machines, ovens, heating systems, air-conditioning systems, fans and ventilation systems, heating and circulating pumps, and sauna systems.

The devices have the VDE mark and are UL approved (not 7LF4444).

Switching Devices

7LF, 5TT3 Timers

7LF4 digital time switches

Technical specifications

			Mini 7LF4401-5	Top 7LF4511 7LF4512	Profi 7LF4521 7LF4522	Astro 7LF4531 7LF4532	Expert 7LF4444	
Standards			EN 60730-1, -2-7; VDE 0631-1, -2-7				EN 60730-1, -2-7; VDE 0631-1, -2-7	
Approvals			CSA C22.2 No. 14 and 177		VDE			
Supply								
• Rated control supply voltage U_c		V AC	110 ... 240	230	230	230	120/230	
		V AC/DC	--	--	24	--	24	
- Primary operating range		$\times U_c$	0.85 ... 1.1	0.85 ... 1.1	0.85 ... 1.1 ¹⁾	0.85 ... 1.1	80 ... 253 V ¹⁾	
- Frequency ranges		Hz	50 ... 60	50 ... 60	50 ... 60 ²⁾	50 ... 60	50 ... 60 ²⁾	
• Rated power dissipation P_v		VA	0.035	2	2	2	2.5/4 ³⁾	
Channels/contacts								
• Switching channels			1	1 or 2			4	
- Rated operational voltage U_e		V AC	250					
- Rated operational current I_e	At p.f. = 1	A	16					
	At p.f. = 0.6	A	10					
• Contacts			1 CO	1 or 2 CO			4 CO	
- Mechanical switching cycles (in millions)			> 5	10				
- Electrical switching cycles	At p.f. = 1		6000 (20 A)	100000				
• Minimum contact load		V; mA	12; 100					
- Incandescent lamp load		A	5	8				
- Fluorescent lamp load		VA	58	60		600	58	
	Uncorrected	VA	1400	2300		2000	1400	
- Energy-saving lamp load		W	100	60 VA		1000	100	
Safety								
• Different phases permissible between actuator/contact			Yes					
• Rated impulse withstand voltage U_{imp}		kV	4.0					
- EMC: burst	Acc. to IEC 61000-4-4	kV	> 4.4					
- EMC: surge	Acc. to IEC 61000-4-5	kV	> 2.0					
- Electrostatic discharge	Acc. to IEC 61000-4-2	kV	> 8.0					
• Power reserve storage	Mains/battery	a	6/2	3	5			
- Battery type			Li primary cell					
• Program memory	Captive		--	No	Yes			
• Overvoltage category	Acc. to EN 61010-1		III					
Function								
• Minimum switching sequences			1 min		1 s			
• Make and break cycles			1 min		1 s			
• Clock errors per day	Typical	s/day	+0.3 ± 1	± 1.5	0.1	± 0.1	± 0.2	
• Control input	Terminal S		--	No	Yes			
• Memory spaces								
- Programs ⁴⁾			28	28 (2 × 14)	56 (2 × 28)	56 (2 × 28)	4 × 3 × 28	
- Pulse (alternatively)			--			84		
- Pulse cycle			--			1 s ... < 60 min		
Connections								
• Terminals ± screw (Pozidriv)			PZ 1					
• Conductor cross-sections of main current paths								
- Rigid, max.		mm ²	4					
- Rigid, min.		mm ²	1.5					
- Flexible with end sleeve	Max.	mm ²	2.5					
Environmental conditions								
• Permissible ambient temperature		°C	-10 ... +55		-20 ... +55			
• Storage temperature		°C	-20 ... +60					
• Climatic withstand capability	Acc. to EN 60068-1		10/055/21		20/055/21			
• Degree of protection	Acc. to EN 60529		IP20, with connected conductors					
• Safety class	Acc. to EN 60730-1		II					

¹⁾ For 24 V devices (7LF4521-2, 7LF4522-2 and 7LF4444-2):
Tolerance -10/+10 %; operating range 0.9 ... 1.1 × U_c .

²⁾ For 24 V devices (7LF4521-2, 7LF4522-2 and 7LF4444-2):
Frequency range 0 ... 60 Hz.

³⁾ For 24 V device (7LF4444-2): $P_v = 4$ VA.

⁴⁾ A program consists of an ON time, an OFF time and assigned ON and OFF days or day blocks.

Dimensional drawings

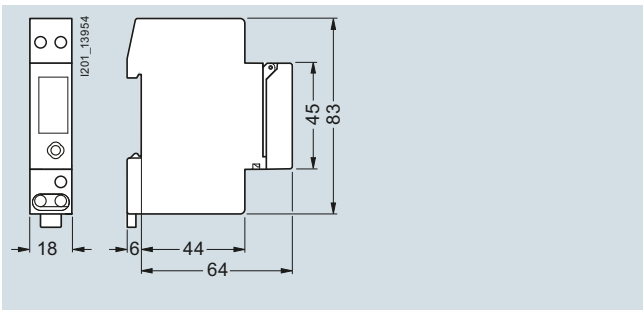

7LF4401-5

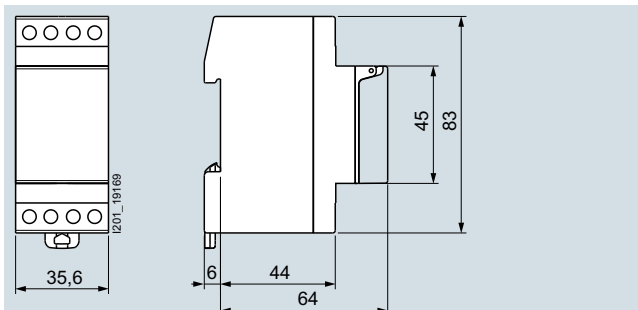

7LF451.
7LF452.
7LF453.

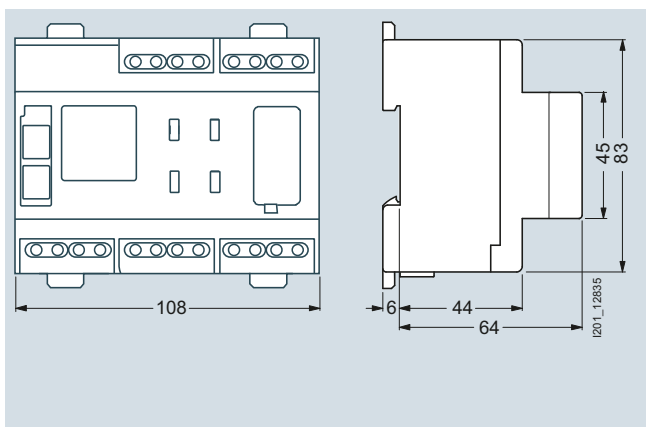

7LF4444

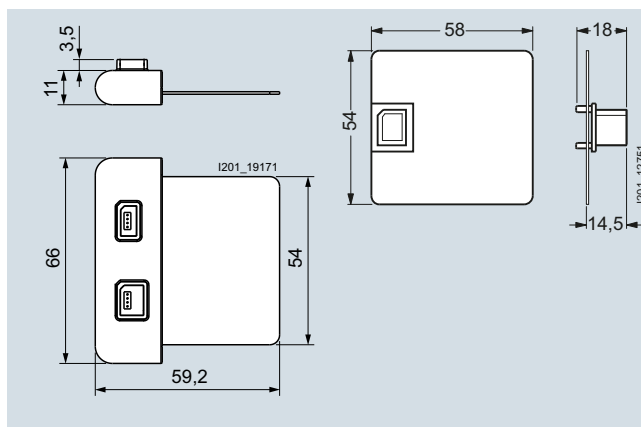

7LF4941-0
USB adapter

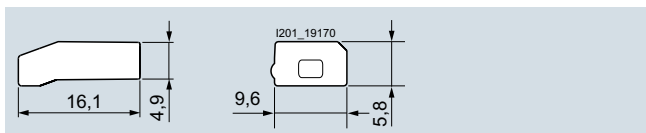

7LF4941-1

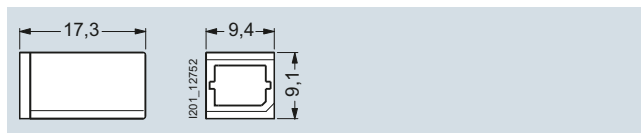

7LF4940-2

Circuit diagrams

Graphic symbols

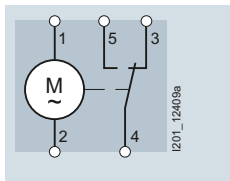

7LF4401-5

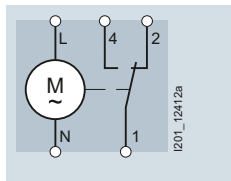

7LF4511
7LF4521
7LF4531

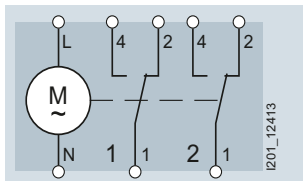

7LF4512
7LF4522
7LF4532

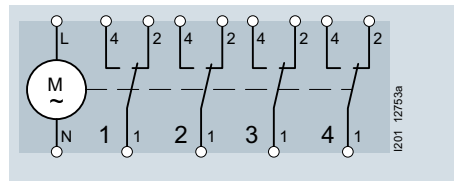

7LF4444

Switching Devices

7LF, 5TT3 Timers

7LF4 digital time switches

More information

Mini digital time switch



The Mini digital time switch with a width of only 1 MW and its hourly, daily and weekly program is ideal for replacement and installation in distribution boards with limited space.

The Mini digital time switch can be used flexibly as it can also be operated in battery mode with all its functionalities. Furthermore, the actuator of the clock can be removed from its enclosure for easy programming over the 5-way joystick prior to mounting.

Top, Profi, Astro and Expert digital time switches

Whether you are using text-assisted programming directly on the device or user-friendly programming on the PC, the Top, Profi, Astro and Expert digital time switches will make your work quicker and easier.

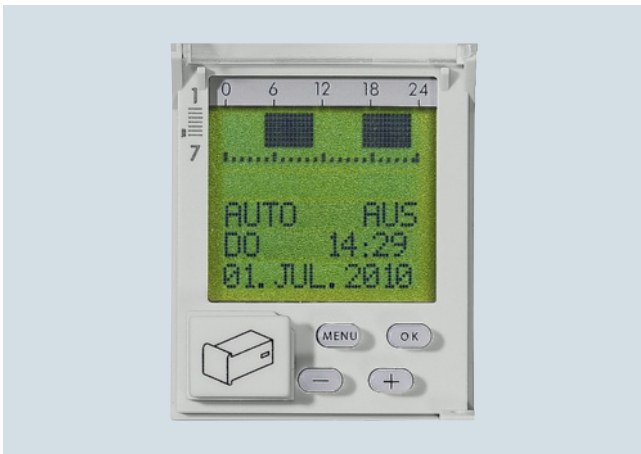

Simple operation:

Four programming keys offer user-friendly assistance with a text menu.

Display that is easy to read:

If you have to change the setting on the digital time switch inside a dark control cabinet, the integrated backlit display and illuminated control elements ensure that you retain an overview of what is what.

Straightforward commissioning:

You can start programming immediately. Profi, Astro and Expert are supplied with the time, date and automatic daylight savings for Central Europe already set.

Clear contrast:

In order to retain an overview even if lighting is poor and temperatures extreme, the display contrast can be adjusted, practically down to the finest detail.

User-friendly programming:

Operating and programming a digital time switch has never been so simple, straightforward and user-friendly.

1-channel time switches allow input of up to 56 switching programs, 2-channel time switches allow up to 28 programs per channel and 4-channel time switches up to 84 programs per channel. This means that the Profi, Astro and Expert time switches are ideally equipped for even the most complex of tasks.

Each entry required is clearly indicated so no prolonged studying of the operating instructions is required. A particularly practical feature is that the digital time switch can be programmed when not connected to a supply voltage.

The Profi, Astro and Expert digital time switches offer more than reliable switching. Numerous integrated, easy-to-use functions ensure that these problem solvers are as simple to operate as they are versatile.

A data key enables easy programming of the Profi, Astro and Expert digital time switches at a PC, simplifies the setting of time switch programs and saves enormous amounts of time. This prevents human error and enables simple copying of complete time switch programs to different time switches.

Astro function:

The Astro and Expert time switches have one key strength: the Astro function. The exact time of sunrise and sunset is available for every location and every day in the year. For example, this means that connected exterior lighting only switches on when it gets dark - on short winter days as well as summer days, when it is light for much longer. The advantages are clear:

- Cost-savings, because electricity is only used when the lighting is really needed, and because this prolongs the service life of the lighting itself. Particularly in the case of dusk-dependent lighting controls
- Safety and convenience, because the light is always switched on when it is dark
- Ease-of-use, because the digital time switch does not have to be reprogrammed throughout the year
- Simplest possible installation, as the Astro digital time switch works in the distribution board. No further need for laborious cable laying to the light sensors. This means that it is not necessary to lay cables across the lightning protection zones. The compact 2-WM range is also ideally suited for subsequent installation or replacement.

It goes without saying that the Astro and Expert digital time switches do not just switch at dawn and dusk; complex, combined programs are also possible. You always have the choice between astronomically calculated and individually set switching times, or a combination of both.

PC programming:



The Profi, Astro and Expert digital time switches support plug-in data keys, thus providing you with even more security and convenience:

For example, you can read a program out from a digital time switch via the data key, copy the program to the PC and save and edit it there - or you could just transfer it to another clock. You can also work with several data keys. Programs can then be changed in a matter of seconds.

A backup copy ensures faster service. If the time switch has been manipulated, the data key can be used to retransfer the saved program to the clock without any problem.

Thanks to the standard operator interface, based on MS Office, there is no need for laborious program training.

Pulse function on a 1-channel device:

Up to 84 start times and one pulse time can be programmed on the time switch using the pulse function. The pulse duration can be selected between 1 s and 59 min 59 s.

Random function:

If the random function is activated, the set switching times are shifted at random within a range of +/- 30 min.

Operating hours counter:

Particularly in commercial applications, it is often necessary to determine the operating life of the switched load, e.g., lights. The operating hours counter displays the total ON duration per channel and the date of the last reset.

Holiday function:

The start and end dates of the holiday period are set in the holiday program. If the holiday program is activated, the digital time switch does not carry out any programmed switching commands during the relative period but, depending on the respective input, is set to "CONTINUOUSLY OFF" or "CONTINUOUSLY ON" during the holiday period. Once the holiday period has elapsed, the digital time switch again begins to perform switching automatically in accordance with the programmed switching times.

Control input:

The follow-on time that can be set in the control input enables the relay to be switched in addition to and in parallel with the switching program. The follow-on time can be set within the range 0 min ... 23 h 59 min, and begins as soon as the voltage on the control input drops.

1 h test:

The "1H TEST" function can be used for simulating switching. If "1H TEST" is activated, the switching outputs are switched for one hour. Once this period has elapsed, the digital time switch again begins to perform switchings automatically in accordance with the programmed switching times.

PIN code:

Input and programming can be disabled using a four-digit PIN code.

Week programs:

Programs that are designed to be repeated regularly every week, e.g. light control, heating control. A week program comprises an ON/OFF time and assigned ON/OFF days.

Year programs:

Programs that are only to be executed within a defined period of validity. They overlap with the week programs of the same channel according to an OR operation. The period of validity is specified by entering the start/end date. Validity from start date 00:00:00 to end date 24:00:00. The start date must be prior to the end date. Within their period of validity, these programs act as week programs. Outside their period of validity, these programs have no influence on the switching behavior.

Exception programs:

Have a higher priority than week and year programs. Week and year programs of the same channel will not be executed within the period of validity of an exception program. However, within the period of validity other exception programs will be executed. The different exception programs overlap according to an OR operation.

Cycle function:

On the year time switch, channel 1 has an additional option for "cyclic switching". The term "cyclic switching" means that within a specific period, the time switch is switched on for a specific duration (ON time). The cycle time can be set between 2 seconds and 2 hours. The ON time can be set between one second and one hour.

Switching Devices

7LF, 5TT3 Timers

7LF4 digital time switches

USB adapters



The Profi, Astro and Expert time switches are easy to program at the PC using the data key with the USB adapter and software. This enables more complex time-switching programs to be created quickly and easily. The saving and copying of time-switching programs is also child's play.

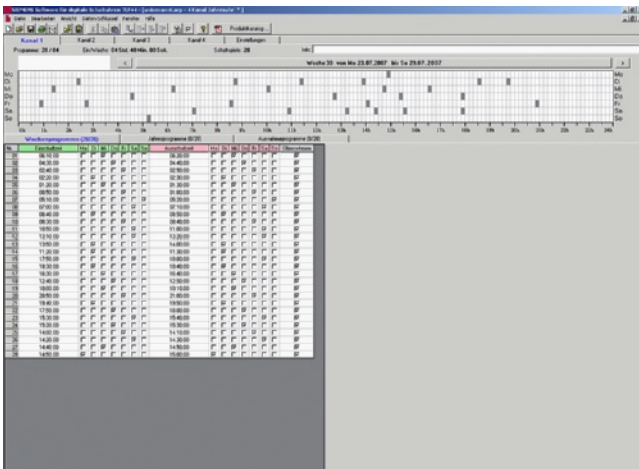

- Clear data on the annual ON time of the load enables a precise statement on the annual power consumption
- You can create the control program for the digital time switch on your home PC at your convenience, save it on the data key and use the key to transfer the program to the clock on site
- Time is not only saved when creating and transferring programs, but also in respect of maintenance

Overview

Today, time switching is a matter of course.

Making energy savings by means of time switching has become a matter of course. Nowadays, many process sequences would be inconceivable without time switching.

If the minimum switching interval is sufficient, mechanical time switches are always used. The press-down tabs can be set to a minimum interval of 15 minutes, without the need to use a tool. They can be used to switch systems or system components or for functions such as: irrigation systems, greenhouses, public gardens, swimming pools, filtering installations, canopy controls, church bells, shop window lighting, advertising lighting, gym lighting, traffic signal controls, street lighting, illuminated signs, office lighting, lighting of stairwells and entrances, object illumination, preheating of industrial furnaces, spraying machines, ovens, heating systems, air-conditioning systems, fans and ventilation systems, heating and circulation pumps and sauna systems.

All devices have the VDE mark and are approved to UL.

Switching Devices

7LF, 5TT3 Timers

7LF5 mechanical time switches

Technical specifications

	Synchronous time switches without power reserve				Quartz-clock time switches with power reserve					
	7LF5 300-1	7LF5 300-5	7LF5 300-6	7LF5 301-0	7LF5 301-1	7LF5 301-4	7LF5 301-5	7LF5 301-6	7LF5 301-7	7LF5 305-0
Standards	DIN EN 60730-1, -2-7, UL 917, UL 917, CSA C22.2 No. 14 and 177									
Approvals	VDE, UL File: E301698									
Operating mode	Synchronous				Quartz					
• Time program	Day	Day	Week	Day	Day	Day	Week	Day	Week	Day
Supply										
• Rated control supply voltage U_c	V AC	230			230					
- Primary operating range	$\times U_c$	0.85 ... 1.1			0.85 ... 1.1					
• Rated frequency	Hz	50			50					
- Frequency ranges	Hz	50			50/60					
• Rated power dissipation P_v	VA	1			1	0.2	0.2	1	1	1
Channels/contacts										
• Switching channels		1			1					
- Rated operational voltage U_e	V AC	250			250					
- Rated operational current I_e										
At p.f. = 1	A	16			16					
At p.f. = 0.6	A	4			4					
• Contacts			1 NO	1 CO	1 CO	1 CO	1 CO	1 CO	1 CO	1 CO
- Mechanical switching cycles in millions		20								
- Electrical switching cycles at p.f. = 1		100000								
• Minimum contact load	V; mA	4; 1			4; 1					
- Incandescent lamp load	A	5			5					
- Fluorescent lamps										
At 7 μ A	VA	60			60					
Uncorrected	VA	1400			1400					
Safety										
• Different phases permissible between actuator/contact		Yes			Yes					
• Electrical isolation, creepage distances and clearances, actuator/contact	mm	8/6			8/6					
• Rated impulse withstand voltage U_{imp} actuator/contact	kV	4			4					
- EMC: burst acc. to IEC 61000-4-4	kV	> 4.4			> 4.4					
- EMC: surge acc. to IEC 61000-4-5	kV	> 2.0			> 2.0					
- Electrostatic discharge acc. to IEC 61000-4-2	kV	> 8.0			> 8.0					
• Power reserve storage	a	--			100 h	6			100 h	
- Minimum charging time	h	--			48	--			48	
- Battery type		--			NiMH cell	Li primary cell		NiMH cell		
- Service life of battery										
At 20 °C	a	--			6	10			6	
At 40 °C	a	--			5					
• Overvoltage category acc. to EN 61010-1		III			III					
Function										
• Minimum switching sequences	min	30	240	30	30	240	30	240	30	
• Make and break cycles	min	15	120	10	15	120	15	120	10	
• Switching accuracy	min	± 5	± 30	± 5	± 5	± 30	± 5	± 30	± 5	± 5
• Clock errors per day		System-synchronized			± 2.5 s	± 60 /year		± 2.5 s		
Connections										
• Terminals \pm screw (Pozidriv)		PZ 1			PZ 1					
• Conductor cross-sections of main current paths										
- Rigid, max.	mm ²	4			4					
- Rigid, min.	mm ²	1.5			1.5					
- Flexible, with end sleeve	mm ²	2.5			2.5					
- Flexible, without end sleeve	mm ²	4			4					
Environmental conditions										
• Permissible ambient temperature	°C	-10 ... +55			-10 ... +55					
• Storage temperature	°C	-10 ... +60			-10 ... +60					
• Climatic withstand capability	Acc. to EN 60068-1	10/055/21			10/055/21					
• Degree of protection	Acc. to DIN EN 60529	IP20, with connected conductors			IP20, with connected conductors					
• Safety class	Acc. to EN 61140	II			II					

Dimensional drawings

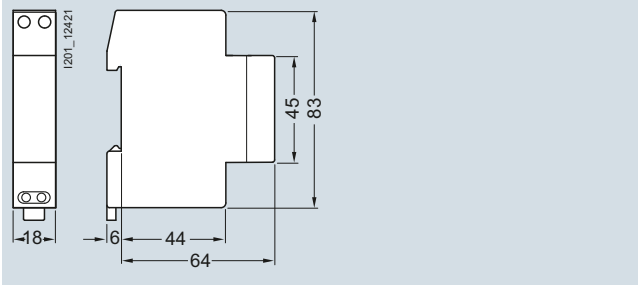

7LF5300-1
7LF5300-7
7LF5301-1

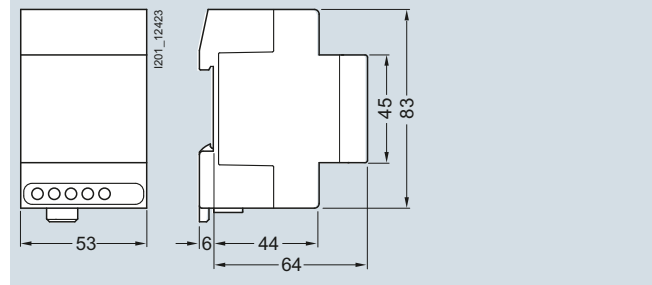

7LF5300-5
7LF5300-6
7LF5301-4
7LF5301-5
7LF5301-6
7LF5301-7

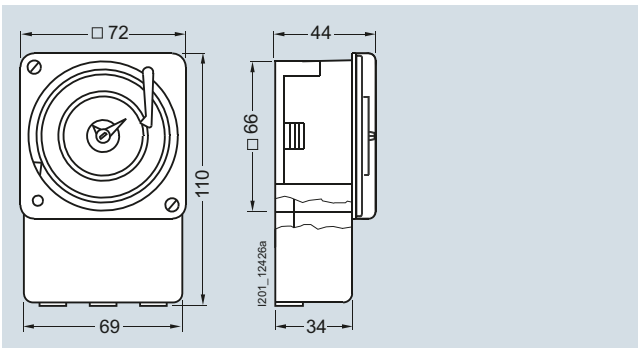

7LF5301-0
7LF5305-0

Circuit diagrams

Graphic symbols

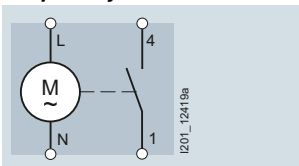

7LF5300-1
7LF5300-7
7LF5301-1

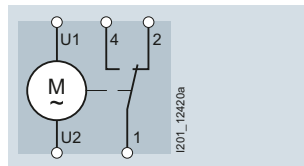

7LF5300-5
7LF5300-6
7LF5301-0
7LF5301-4
7LF5301-5
7LF5301-6
7LF5301-7
7LF5305-0

Switching Devices

7LF, 5TT3 Timers

7LF5 mechanical time switches

More information



Mechanical time switches with day disk

Synchronous time switches without power reserve

The control gear is driven by a synchronous motor so it is dependent on the power supply frequency. If this frequency is unstable, the devices cannot be used. In the event of a power failure, the time switch will stop.

Quartz-clock time switches with power reserve

A quartz electronic circuit supplies the drive with a stabilized frequency so that the time switch is not dependent on the power supply frequency. In the event of a power failure, the time switch continues to operate on its power reserve.

Automatic setting function

This makes installing the 7LF5301-4 and 7LF5301-5 time switches quick and easy. These time switches self-adjust during commissioning in fast mode to the correct time and correct day within the Central European zone. The relevant daylight-saving adjustment is also made automatically. Another advantage is that, once the supply voltage is reconnected following a power failure, the correct time and day are reset using quartz precision.

Precision quartz clockwork

Accuracy: The internal precision clockwork has an accuracy of ± 1 min. per year. Until now, this level of accuracy and automatic operational safety was only possible using digital time switches.

Optimization of power consumption due to minimum make and break cycles of 15 minutes: it is possible to set the switching times in 15-minute patterns, with a switching interval of at least 30 minutes.



Mechanical time switches with week disk

LED display

Adjustment data for Central Europe are stored in the switch and an LED display provides information about the current status.

So, all you have to do is unpack, snap on, connect, and set the desired switching times, all without the need for tools. This saves time and money.

Clear design

The clear design aids understanding. Switching times can be easily identified.

As regards the weekly time switch, a minimum switching interval of 240 minutes results in a switching step of only 120 minutes.

Overview

Siemens stairwell lighting timers enable the required time to be set precisely without tools using the push-to-lock knurling wheel. The stairwell lighting timers in four-wire installations can be switched back on again at any time by simply pressing the

switch. A maintained light switch prevents the need for repeated pressing, for example when moving house. The various types are also available with warning of impending switch-off.

Technical specifications

		7LF6110	7LF6111	7LF6113	5TT1303	7LF6114	7LF6115	7LF6116	7LF6112
Standards		IEC 60669, EN 60669							
Supply									
• Rated control supply voltage U_c	At 50/60 Hz	V AC	230						
- Primary operating range		$\times U_c$	0.9 ... 1.1						
• Rated power dissipation P_v		VA	Approx. 5						
Setting range		min	0.5 ... 10		1 ... 10	0.5 ... 10	3 ... 60		0.5 ... 10
• Accuracy		s	±30						
Manual switches	Automatic/permanent		Yes						
Minimum push duration		ms	30						
Voltage endurance	At pushbutton input (pushbutton malfunction)		Yes						
Short-circuit strength		A	700		--	700			
Channels/contacts									
• Switching channels	At p.f. = 1	V AC	250						
- Rated operational voltage U_e		A	16		--	10	16		
- Rated operational current I_e		mm	> 3		0.3	> 3			
• Contact gap		V; mA	10; 300						
• Minimum contact load									
Max. incandescent lamp load		W	2000		--	2000		--	
Max. energy-saving lamp load 14 W		Unit(s)	20		--	20		--	
Fluorescent lamp load 58 W									
- Uncorrected	1 lamp 2 lamp	Unit(s)	20		--	20			
- DUO switching		Unit(s)	2 × 20		--	2 × 20			
- Siemens ECG		Unit(s)	10		6	10			
		Unit(s)	2 × 5		3	2 × 5			
Glow lamp load		mA	50		10	50		--	
Max. fan load		VA	--						200
Connections									
• Terminals ± screw (Pozidriv)			PZ 1						
• Conductor cross-sections of main current paths									
- Rigid	Min.	mm ²	1.5 ... 6						
- Flexible, with end sleeve		mm ²	1						
Environmental conditions									
• Climatic withstand capability	Acc. to EN 60068-1	°C	-20 ... +50						
• Degree of protection	Acc. to EN 60529		IP20, with connected conductors						

Switching Devices

7LF, 5TT3 Timers

7LF6 timers for buildings

Dimensional drawings

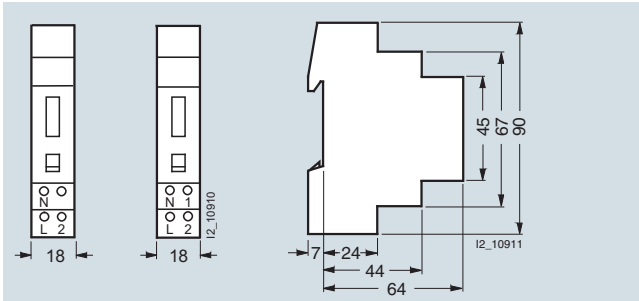

7LF6110 7LF6111
7LF6112
7LF6113
7LF6114
7LF6115
7LF6116

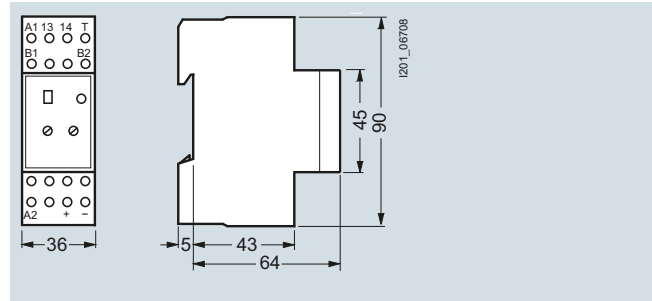

5TT1303

Circuit diagrams

Typical circuit for 7LF6111 timer in 4-wire circuit, L-momentary, resettable

Usual circuit for new installation with separate cable routing for pushbuttons and lights. The additional DI switch allows external switching to continuous light or a time switch can also be used for this purpose. An additional attic circuit is also available, which operates independently of the timer, but on the same electrical circuit. The timer can be restarted before the set time expires.

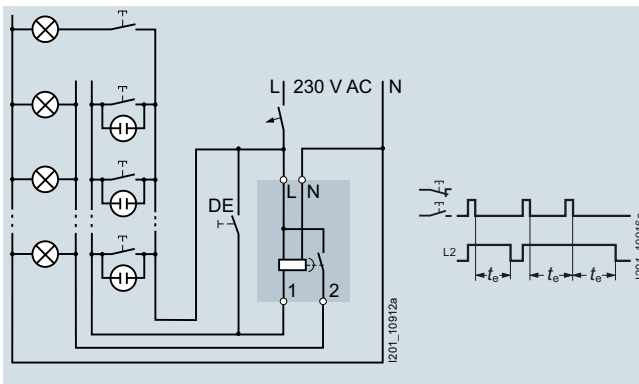

t_e = runtime

Typical circuit for 7LF6111 timer in 3-wire circuit, N-momentary, resettable

Can only be used with a limited number of wires. The timer can be restarted before the set time expires. While this 3-wire circuit with N-momentary contact is technically possible, it does not comply with DIN VDE 0100-460. However, it is used in old systems for replacement purposes.

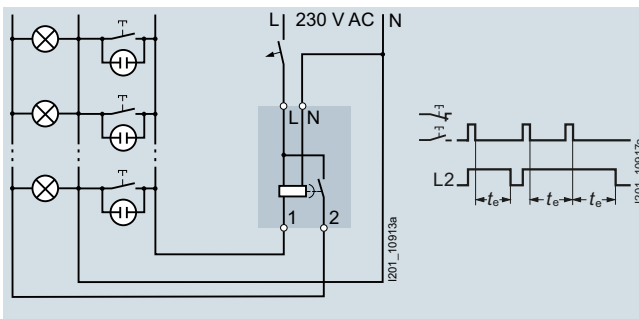

t_e = runtime

Typical circuit for 7LF6112 timer for fans up to 200 VA

The switch switches the light on immediately, e.g. in a toilet. After a delay of approx. 1 minute, the fan is switched on. When the light is switched off, the fan continues to run for the time set at the timer.

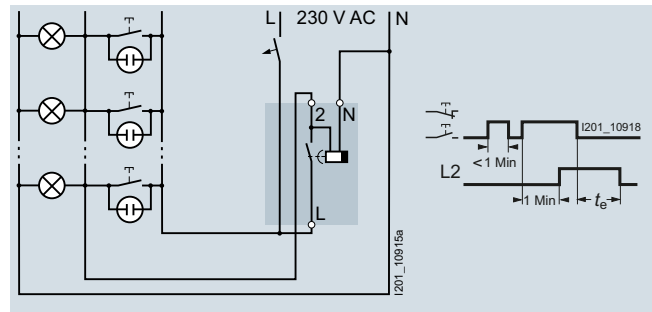

t_e = runtime

Typical circuit for 7LF6115 energy-saving timer with prewarning

The timer is connected in the same way as the 7LF6111 timer in a 4-wire or 3-wire circuit. The energy-saving timer is activated at the first press of the button and deactivated at the second press. If it is not switched off manually, it is automatically switched off after the set time, max. 60 minutes. 20 and 40 seconds before expiry, the light flashes briefly twice (50 ms) to warn of the impending tripping. This allows time to reset the switch while the light is still on. Prior to the warning time, a push of the button ends the timing interval.

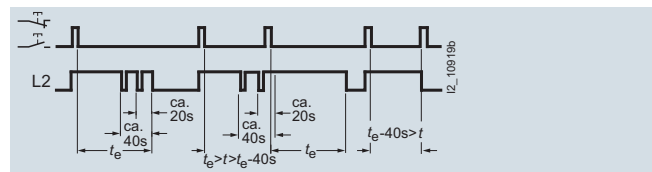

t_e = runtime

Typical circuit for 7LF6116 energy-saving timer

The timer is connected in the same way as the 7LF6115 timer in a 4-wire or 3-wire circuit. The energy-saving timer switches on if pressed once and switches off when it is pressed again briefly (less than 1 second).

Resetting is possible by pressing a second time for longer (more than 1 second). If it is not switched off manually, it is automatically switched off after the set time, max. 60 minutes.

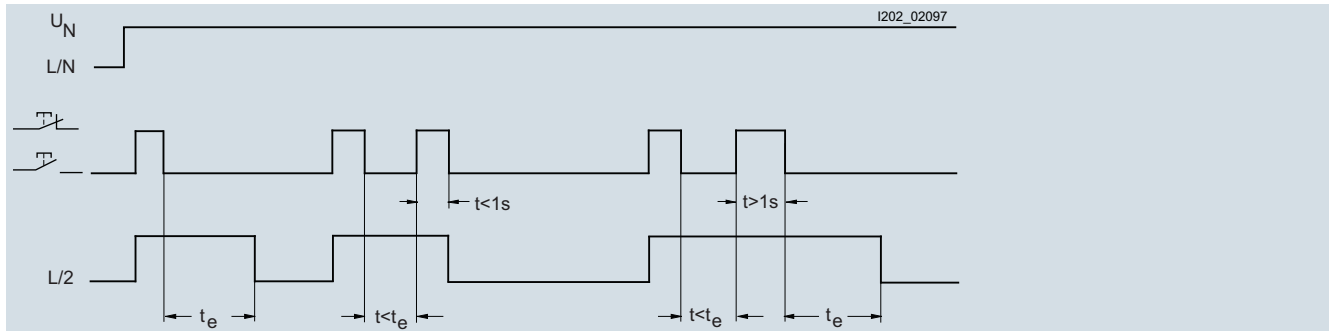

t_e = runtime

Lighting in ancillary rooms and corridors

In rooms subject to less frequent use (basements, ironing rooms, attics, heating oil storerooms) there is a risk of the lighting remaining on unnecessarily for lengthy periods. In such cases, the 7LF6115 and 7LF6116 energy-saving timers can considerably reduce energy costs while increasing user-friendliness.

Occupants leaving a room can switch off the light by pushbutton, just like an installation with remote control switch. In the event that occupants are unable to switch the light off, or simply forget, it will go out automatically after a pre-set time.

The 7LF6115 and 7LF6116 energy-saving timers can also be used in corridors, e.g. as replacements for remote control switches. In this case they combine the familiar functionality of a remote control switch with the energy-saving features of a stairwell lighting timer.

Typical circuit for 7LF6110 timer in 3-wire circuit, L-momentary contact, not resettable

Circuit for new installation with shared cable routing for pushbuttons and lights. The timer can only be restarted after the set time expires.

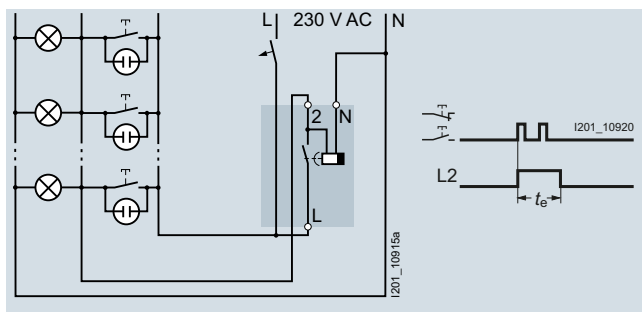

t_e = runtime

Typical circuit for 7LF6113 timer with prewarning

The timer is connected in the same way as the 7LF6111 timer in a 4-wire or 3-wire circuit. 20 and 40 seconds before expiry, the light flashes briefly twice (50 ms) to warn of the impending tripping. This allows time to reset the switch while the light is still on.

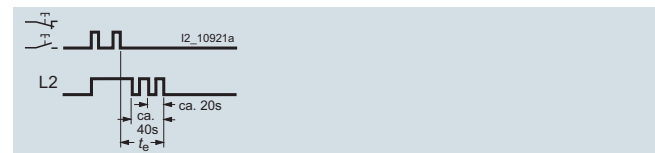

t_e = runtime

Typical circuit for 7LF6114 lighting timer with prewarning

The timer is connected in the same way as the 7LF6111 timer in a 4-wire or 3-wire circuit. When pressed, the lighting timer switches on for the set runtime, up to 10 minutes. If the switch is pressed for more than one second, the light is switched on for four times the set time, i.e. up to 40 minutes. The last press of the pushbutton is definitive. 20 and 40 seconds before expiry, the light flashes briefly twice (50 ms) to warn of the impending tripping. This allows time to reset the switch while the light is still on. The timing interval restarts each time the button is pressed.

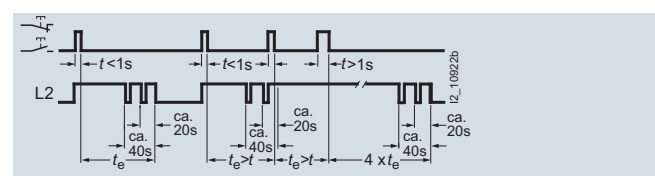

t_e = runtime

Switching Devices

7LF, 5TT3 Timers

7LF6 timers for buildings

Typical circuit for 5TT1303 ECG control switch

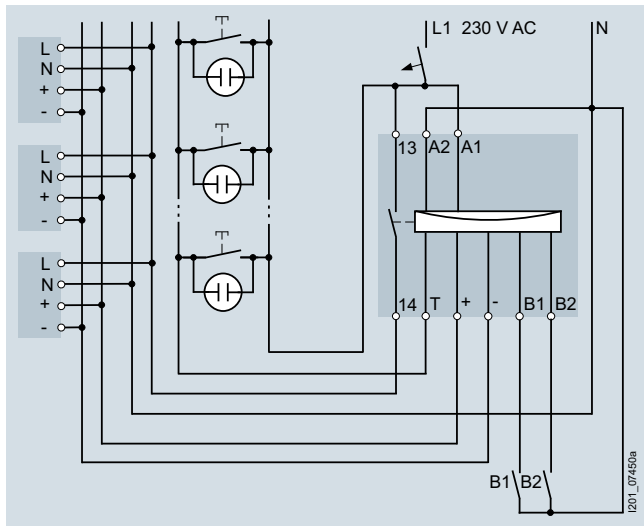

The device is fitted with a direct voltage input for the control of an ECG. When the pushbutton is actuated, the power supply is released and the ECG is brightened for up to 10 minutes, depending on the setting of the timer.

On expiry of this time, the ECG is dimmed according to the set dimmer level, if pressed again it brightens again. If no requests are made for 30 minutes (no buttons pressed), the lighting is fully deactivated. In addition to these functions, the dimming time and brightness period can also be controlled using a separate pushbutton or time switch over the control inputs B1 and B2.

Switching the ECG and the fluorescent lamp as little as possible extends the service life.

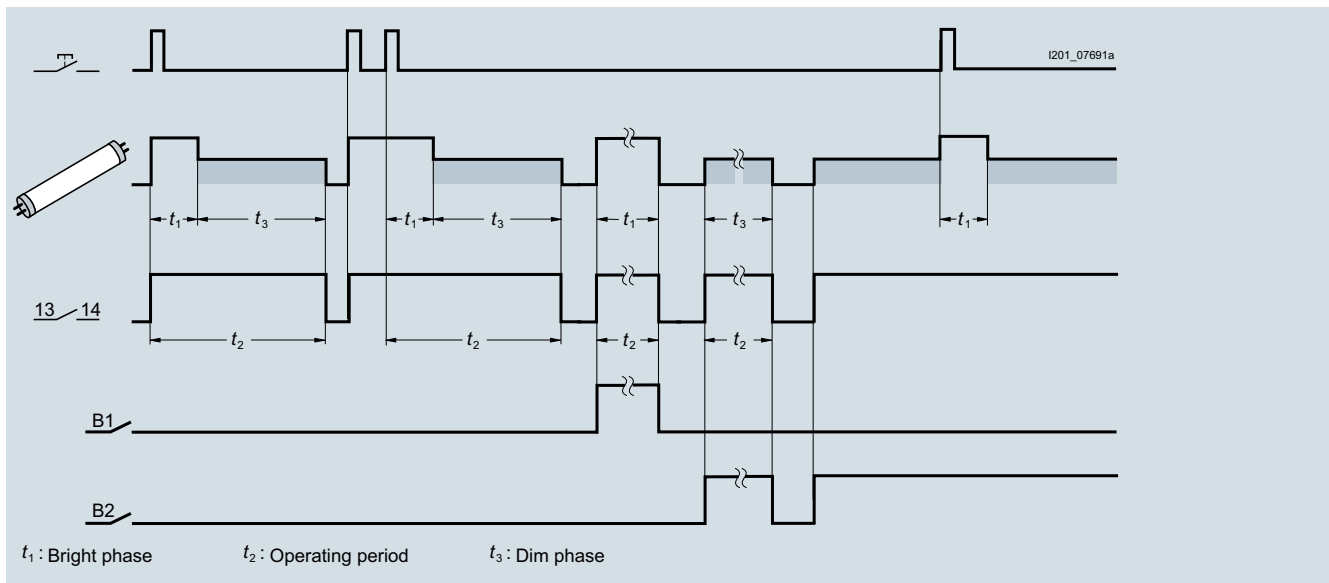

Hall lighting in nursing home

At meal times, from 5 to 7 p.m., the light in the corridors can be permanently switched on using a time switch (contact B1). Between 7 p.m. and 10 p.m., the lighting is dimmed using switch B2. Simply press the corridor pushbutton again to return the lighting to the bright setting at any time. After 10 p.m., the light is switched off. It can be switched back on at any time by pressing the corridor pushbutton.

Corridor lighting in hospitals

During the day – i.e. during peak periods, lunch times, visiting times, shift changes, doctor's rounds – the light is switched on. During quiet periods, i.e. afternoons and nights, the light is switched to a dimmed state. A patient can switch the light back to the bright setting at any time by pressing the corridor pushbutton. In emergencies, the nurse can use a B1 switch to switch to "emergency operation", i.e. permanently bright (no time limit of brightness period).

More information

Stairwell lighting

This is required in DIN 18015-2 "Electrical installations in residential buildings; Nature and extent of minimum equipment". What is less known is that 100 lux is required according to EN 12464-1 "Lighting of work places" for interior areas and corridors, section 5.3. This means that approx. 60 W incandescent lamps, 25 W energy-saving lamps or 25 W fluorescent lamps need to be used. It is hard to see why lower requirements should apply to stairwells in residential buildings than stipulated in EN 12464-1.

4-wire circuit, L-momentary contact

4 wires are installed within the building. The timing interval is started by pressing phase L. During the runtime, the timer can be reset at all times.

3-wire circuit, L-momentary contact

3 wires are installed within the building. The timing interval is started by pressing phase L. No resetting is possible during the runtime as the pushbutton input and output are exposed to the same potential during this period. The glow lamps are switched off during the runtime.

3-wire circuit, N-momentary contact

3 wires are installed within the building. The timing interval is started by pressing the N conductor. During the runtime, the timer can be reset at all times. However, this switching no longer corresponds to DIN VDE 0100 and is now only used in old systems.

Safety through warning prior to switch-off

DIN 18015-2 "Electrical installations in residential buildings; Nature and extent of minimum equipment" stipulates that the automatic lighting-off control in stairwells of apartment blocks must be equipped with a warning function to prevent sudden darkness in the building. This contribution towards safety is offered by 4 device versions. The 7LF6113 stairwell lighting timer, the 7LF6114 lighting timer and the 7LF6115 energy-saving timer warn of an impending switch-off by flashing, the 5TT1303 stairwell lighting timer ECG warns of an impending switch-off by dimming, allowing sufficient time for the light switch to be pressed again.

Manual switches

All timers have a manual switch for the function "Automatic/ON". This allows the operator to switch to continuous light in the event of moving house or emergencies.

Useful continuous contact

Pushbuttons should never jam. For this reason, all our timers have a safeguard to prevent this type of malfunction. Even better, this feature can be used (e.g. by caretakers of properties) to switch to a continuous light in the event of moving house or emergencies.

Setting accuracy

The electronic remote control switches offer a high degree of accuracy. The runtime can be set precisely to +30 seconds using the push-to-lock knurling wheel setting. The factory settings ensure that the limit values of 1 and 10 or 60 minutes can be reliably set.

Short-circuit strength

Stairwell lighting timers are primarily used for the switching of incandescent lamps, which may occasionally be subject to short circuits. A key feature of all devices is their high short-circuit strength without the contacts welding.

Switching of fluorescent lamps

In order to extend their service life as far as possible, fluorescent lamps should only be switched using a stairwell lighting timer if the switching frequency is not excessive. Using electronic ballast (ECG) to operate them is more gentle on the device and saves energy. The 5TT1303 stairwell lighting timer ECG switches the electronic ballast and warns of the impending switch-off by dimming.

Switching of energy-saving lamps

The switching of energy-saving lamps depends greatly on the lamp type used. Standard energy-saving lamps are generally unsuitable for warning by flashing or dimming prior to switch-off.

The 7LF6110 and 7LF6111 stairwell timers and the 7LF6116 energy-saving timers without warning of impending switch-off are suitable for the use of standard energy-saving lamps (e.g. OSRAM DULUX EL).

For applications with warning of impending switch-off (7LF6113 and 7LF6114 stairwell lighting timers or 7LF6115 energy-saving timers) we recommend the use of special energy-saving lamps such as OSRAM DULUX EL FACILITY or OSRAM DULUX EL VARIO.

Download from the Internet:

For more information [please visit us on the Internet at: www.siemens.com/lowvoltage](http://www.siemens.com/lowvoltage)

Switching Devices

7LF, 5TT3 Timers

5TT3 timers for industry

Overview

Time relays are primarily used in series applications where the use of PLC controls is too labor and cost-intensive. Multifunction

relays with a range of functionalities and clear and intuitive operation are now market standard.

Technical specifications

		5TT3185	5TT3181 5TT3182 5TT3183	5TT3184
Standards		EN 60255; DIN VDE 0435-110		
Supply				
• Rated control supply voltage U_c	V AC	12 ... 240	220 ... 240	110 ... 240
- Primary operating range	V DC	12 ... 240	--	110 ... 240
	$\times U_c$	0.8 ... 1.1		
• Rated frequency f_n	Hz	45 ... 400	50/60	
• Rated power dissipation P_V	VA	Approx. 1.5	Approx. 5	Approx. 1
Setting ranges		See setting ranges, timing intervals		
Recovery time	ms	15 ... 80	Approx. 40	Approx. 100
Contacts				
• Switching channels				
- Rated operational voltage U_e	V AC	250		
- Rated operational current I_e	A	4	8	5
• Contact gap	mm	μ contact		
- Minimum contact load	V; mA	10; 300		
Rated impulse withstand voltage U_{imp}	Input/output	kV	> 4	
Electrical service life	In switching cycles At AC-15	1 A	1.5 $\times 10^5$	-- 1.5 $\times 10^5$
			--	1.5 $\times 10^5$ --
Connections				
• Terminals \pm screw (Pozidriv)			2	
• Conductor cross-sections of main current paths				
- Rigid, max.	mm ²	2 \times 2.5		
- Flexible, with end sleeve, min.	mm ²	2 \times 1.5		
Environmental conditions				
• Permissible ambient temperature		°C	-40 ... +60	
• Climatic withstand capability	Acc. to EN 60068-1		40/60/4	

Dimensional drawings

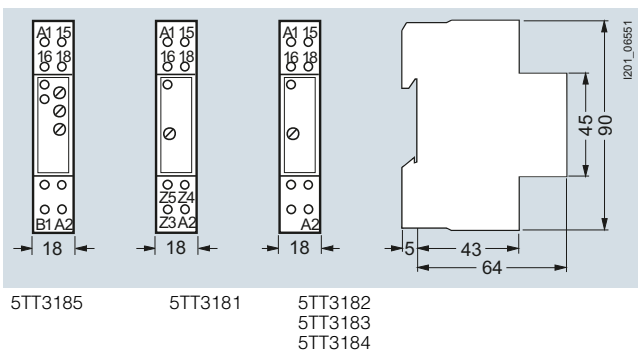

Circuit diagrams

Graphic symbols

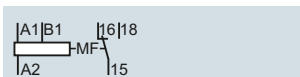

5TT3185

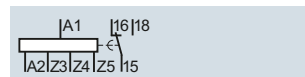

5TT3181

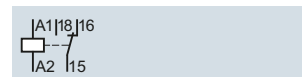
5TT3182
5TT3183
5TT3184

More information

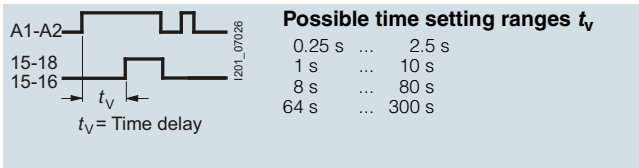
5TT3181 delay timer

Response delay

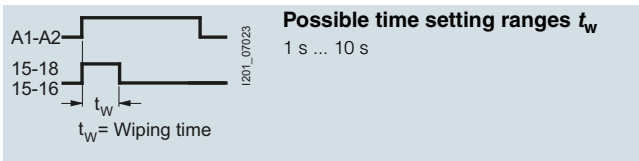
5TT3182 wiper timer

Wiper function

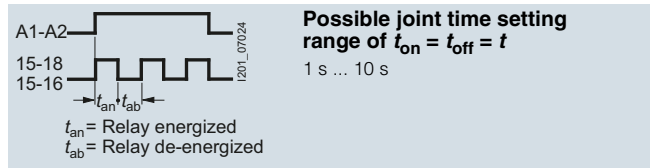
5TT3183 flashing timer

Flashing function

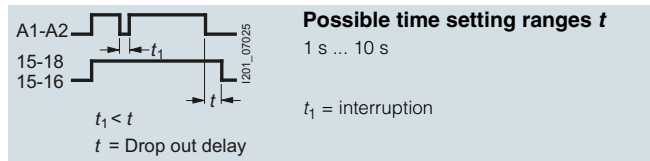
5TT3184 delay-off timer

OFF-delay

Switching Devices

7LF, 5TT3 Timers

5TT3 timers for industry

5TT3185 multifunction timer

Setting aids

The period of the flashing of the green LED 1 when set for a timing interval is $1 s \pm 4\%$, which can therefore be used as a setting aid. This is particularly useful in the lower time setting range and for long delay times because of the accuracy of the multiplication factors between the individual time ranges.

Example:

Delay time to be set: 40 min.

Using the fine setting, this delay time can be set within the setting range 3 ... 300 min. However, in this case it takes a long time to check the time and requires several operational sequences in realtime. To speed up the setting process, the setting range is switched to 0.03 ... 3 min. In this case, the required value corresponds to a delay time 0.4 min (= 24 s). The timing interval is triggered and the potentiometer is set to 24 flashing periods of the yellow LED 2. The device is then set

back to the setting range 3 ... 300 min and the setting process is completed.

Time operation interruption/time addition

For the functions AV, EW, IE, BI, the timing interval can be interrupted at any time by activating B1 (+) and continued again by removing the control voltage (time addition).

Control input B1

The functions RV, IF, AW, AV/RV can be controlled using the control input B1 (+) with potential against terminal A2. The auxiliary voltage of terminal A1 - or any other voltage within the range 12 ... 240 V AC/DC - can be used for this purpose. The operation of parallel loads (e.g. contactors) from B1 (+) to A2 is also permissible.

If voltage is simultaneously applied to the control input B1 (+) and A1 for the IF function, an output pulse is triggered with the set time interval t_1 .

Control S1	Position Function switch	Contact U_c	Timing diagram	Possible time setting ranges t :
		A1-A2		0.02 ... 1 s 0.06 ... 6 s 0.3 ... 30 s 0.03 ... 3 min 0.3 ... 30 min 3 ... 300 min 0.3 ... 30 h 3 ... 300 h
Response delay	AV ①	15-18 15-16		
Passing make contact function	EW ②	15-18 15-16		
Pulse generator, delayed	IE ③	15-18 15-16		
Flashing relay, starting with impulse	BI ④	15-18 15-16		
Control S2		A1-A2		
OFF-delay	RV ⑤	15-18 15-16		
Pulse shape	IF ⑥	15-18 15-16		
Passing break contact function	AW ⑦	15-18 15-16		
Response delay OFF-delay	AV/RV ⑧	15-18 15-16		

A1 15
16 18
A2
B1(+)
E2

LED 1 green
E1
LED 2 yellow
Z
E2

LED 1 green: Status display
E1: Time range adjuster
LED 2 yellow: Switch position indicator
Z: Fine adjuster for time ranges
E2: Function setting Timing intervals

Control S1

Contact S1
For the functions: response delay, passing make contact function, pulse generator delayed, clock generator – (start with pulse) – the timing interval is triggered by closing the switching contact S1.

Control S2

Control contact S2
The functions: off-delay, pulse shape, passing break contact function, response and off-delay are triggered by continuous power supply over the control contact S2 between A1 and B1 (+).

User interfaces
LED 1 Status display
LED 2 Switching position indication
E1 Setting range adjuster
Z Fine adjuster for setting ranges
E2 Function settings for timing intervals

Device displays
LED 1 Lights up if operational voltage is applied (green)
LED 2 indicates the timing interval and state of the equalizing relay (yellow)

- Continuous light
- Off output relay not activated, no timing interval
- On output relay not activated, no timing interval
- Flashing light
- Short on, long off
- Output relay not activated, timing interval
- Short on, long off
- Output relay activated, timing interval

Front view
LED 1 green: Status display
LED 2 yellow: Switching position indication

E1: Setting range adjuster
Z: Fine adjuster for setting ranges
E2: Function settings for timing intervals

Siemens AG
Energy Management
Low Voltage & Products
Postfach 10 09 53
93009 REGENSBURG
GERMANY

Subject to change without prior notice
PDF (3ZW1012-5TT57-0AC1)
PH 0115 58 En
Produced in Germany
© Siemens AG 2015

The information provided in this configuration manual contains merely general descriptions or characteristics of performance which in case of actual use do not always apply as described or which may change as a result of further development of the products. An obligation to provide the respective characteristics shall only exist if expressly agreed in the terms of contract. Availability and technical specifications are subject to change without notice.
All product designations may be trademarks or product names of Siemens AG or supplier companies whose use by third parties for their own purposes could violate the rights of the owners.