

# SIEMENS

## SITRANS L

### Ultrasonic level transmitters SITRANS Probe LU240 with mA/ HART

Compact Operating Instructions

<u>Getting started</u>	<b>1</b>
<u>Introduction</u>	<b>2</b>
<u>Safety notes</u>	<b>3</b>
<u>Description</u>	<b>4</b>
<u>Installing/mounting</u>	<b>5</b>
<u>Connecting</u>	<b>6</b>
<u>Commissioning</u>	<b>7</b>
<u>Service and maintenance</u>	<b>8</b>
<u>Technical data</u>	<b>9</b>
<u>HART communication</u>	<b>10</b>
<u>Certificates and support</u>	<b>11</b>

7ML51 (SITRANS Probe LU240)

## Legal information

### Warning notice system

This manual contains notices you have to observe in order to ensure your personal safety, as well as to prevent damage to property. The notices referring to your personal safety are highlighted in the manual by a safety alert symbol, notices referring only to property damage have no safety alert symbol. These notices shown below are graded according to the degree of danger.

<b>⚠ DANGER</b>
indicates that death or severe personal injury <b>will</b> result if proper precautions are not taken.

<b>⚠ WARNING</b>
indicates that death or severe personal injury <b>may</b> result if proper precautions are not taken.

<b>⚠ CAUTION</b>
indicates that minor personal injury can result if proper precautions are not taken.

<b>NOTICE</b>
indicates that property damage can result if proper precautions are not taken.

If more than one degree of danger is present, the warning notice representing the highest degree of danger will be used. A notice warning of injury to persons with a safety alert symbol may also include a warning relating to property damage.

### Qualified Personnel

The product/system described in this documentation may be operated only by **personnel qualified** for the specific task in accordance with the relevant documentation, in particular its warning notices and safety instructions. Qualified personnel are those who, based on their training and experience, are capable of identifying risks and avoiding potential hazards when working with these products/systems.

### Proper use of Siemens products

Note the following:

<b>⚠ WARNING</b>
Siemens products may only be used for the applications described in the catalog and in the relevant technical documentation. If products and components from other manufacturers are used, these must be recommended or approved by Siemens. Proper transport, storage, installation, assembly, commissioning, operation and maintenance are required to ensure that the products operate safely and without any problems. The permissible ambient conditions must be complied with. The information in the relevant documentation must be observed.

### Trademarks

All names identified by ® are registered trademarks of Siemens AG. The remaining trademarks in this publication may be trademarks whose use by third parties for their own purposes could violate the rights of the owner.

### Disclaimer of Liability

We have reviewed the contents of this publication to ensure consistency with the hardware and software described. Since variance cannot be precluded entirely, we cannot guarantee full consistency. However, the information in this publication is reviewed regularly and any necessary corrections are included in subsequent editions.

# Table of contents

<b>1</b>	<b>Getting started.....</b>	<b>5</b>
<b>2</b>	<b>Introduction.....</b>	<b>7</b>
2.1	Purpose of this documentation.....	7
2.2	Designated use.....	7
2.3	Product compatibility.....	7
2.4	Checking the consignment.....	8
2.5	Security information.....	8
2.6	Transportation and storage.....	9
2.7	Notes on warranty.....	9
<b>3</b>	<b>Safety notes.....</b>	<b>11</b>
3.1	Preconditions for use.....	11
3.1.1	Safety marking symbols.....	11
3.1.2	Laws and directives.....	11
3.1.3	Conformity with European directives.....	12
3.2	Requirements for special applications.....	12
3.3	Use in hazardous areas.....	13
<b>4</b>	<b>Description.....</b>	<b>15</b>
<b>5</b>	<b>Installing/mounting.....</b>	<b>17</b>
5.1	Basic safety notes.....	17
5.1.1	Installation location requirements.....	18
5.1.1.1	Recommended.....	19
5.1.1.2	Avoid.....	20
5.1.2	Proper mounting.....	21
5.1.2.1	Process connections.....	21
5.2	Disassembly.....	22
<b>6</b>	<b>Connecting.....</b>	<b>23</b>
6.1	Basic safety notes.....	23
6.2	Connecting SITRANS Probe LU240.....	23
6.2.1	Wiring instructions.....	24
6.3	Hazardous area installations.....	25
6.3.1	Nameplates for hazardous area installations.....	26
6.3.1.1	Intrinsic safety wiring.....	26
6.3.1.2	Non-incendive wiring.....	27
6.3.1.3	Further information related to hazardous area installations.....	27
6.3.2	Instructions specific to hazardous area installations.....	27
6.3.2.1	Instructions in accordance with IEC 60079-0:2011 clause 30.....	27

<b>7</b>	<b>Commissioning.....</b>	<b>29</b>
7.1	Basic safety notes.....	29
7.2	Local commissioning.....	29
7.2.1	Activating SITRANS Probe LU240.....	29
7.2.2	Local display.....	30
7.2.3	Display symbols.....	30
7.2.4	Display views.....	30
7.2.5	Parameter menus.....	32
7.2.6	Programming.....	33
7.2.7	Wizards.....	34
7.2.7.1	Quick commissioning: Level/Space/Distance/Custom.....	35
7.2.7.2	Quick commissioning: Volume.....	40
7.2.7.3	Quick commissioning: Volume flow.....	41
<b>8</b>	<b>Service and maintenance.....</b>	<b>43</b>
8.1	Basic safety notes.....	43
8.2	Cleaning.....	43
8.3	Maintenance and repair work.....	44
8.3.1	Replacing the display.....	44
8.3.1.1	Remove existing display.....	44
8.3.1.2	Install a new display.....	45
8.4	Return procedure.....	46
8.5	Disposal.....	46
<b>9</b>	<b>Technical data.....</b>	<b>49</b>
9.1	Power.....	49
9.2	Performance.....	50
9.3	Interface.....	50
9.4	Outputs.....	51
9.5	Construction.....	51
9.6	Operating conditions.....	52
9.7	Process.....	52
9.8	Communication.....	52
9.9	Approvals.....	53
<b>10</b>	<b>HART communication.....</b>	<b>55</b>
<b>11</b>	<b>Certificates and support.....</b>	<b>57</b>
11.1	Certificates.....	57
11.2	Technical support.....	57
11.3	QR code label.....	58
	<b>Index.....</b>	<b>59</b>

# Getting started

## Introduction

Use this chapter as a quick reference. It provides links to the steps required for startup.

Before you begin, read the following safety information:

- General safety information (Page 11)
- Basic safety information: Installing/mounting (Page 17)
- Basic safety information: Connecting (Page 23)
- Basic safety information: Commissioning (Page 29)

Read the entire Operating Instructions to achieve optimum device performance.

## Procedure

1. **Install/mount the device.**  
Installation location requirements (Page 18)
2. **Connect the device.**  
Connecting SITRANS Probe LU240 (Page 23)
3. **Install (optional) display**  
Install a new display (Page 45)
4. **Power up the device.**  
Activating SITRANS Probe LU240 (Page 29)
5. **Commission the device via quick commissioning wizard:**  
Quick commissioning: Level/Space/Distance/Custom (Page 35)  
Quick commissioning: Volume (Page 40)  
Quick commissioning: Volume flow (Page 41)

Startup is complete.



## Introduction

### 2.1 Purpose of this documentation

These instructions are a brief summary of important features, functions and safety information, and contain all information required for safe use of the device. Read the instructions carefully prior to installation and commissioning. In order to use the device correctly, first review its principle of operation.

The instructions are aimed at persons who install and commission the device.

To realize optimum performance from the device, read the complete operating instructions.

### 2.2 Designated use

Use the device to measure process media in accordance with the information in the operating instructions.

<b>NOTICE</b>
<b>Use in a domestic environment</b>
This Class A Group 1 equipment is intended for use in industrial areas.
In a domestic environment this device may cause radio interference.

### 2.3 Product compatibility

The following table describes compatibility between document edition, device revision, engineering system and associated Electronic Device Description (EDD).

Manual edition	Remarks	Device revision	Compatible version of device integration package	
10/2018	First edition	HART FW: 1.00.00 or later HW: 1.00.00 or later Device revision 1 or later	SIMATIC PDM V9.1	EDD: 1.00.00 or later
			AMS Device Manager V13.5	EDD: 1.00.00 or later
			SITRANS DTM V4.1 SP4	EDD: 1.00.00 or later
			Field communicator (FC) 375/475 V3.8	EDD: 1.00.00 or later
			SITRANS library	EDD: 1.00.00 or later

## 2.4 Checking the consignment

1. Check the packaging and the delivered items for visible damages.
2. Report any claims for damages immediately to the shipping company.
3. Retain damaged parts for clarification.
4. Check the scope of delivery by comparing your order to the shipping documents for correctness and completeness.

 <b>WARNING</b>
<b>Using a damaged or incomplete device</b>
Risk of explosion in hazardous areas.
<ul style="list-style-type: none"><li>• Do not use damaged or incomplete devices.</li></ul>

## 2.5 Security information

Siemens provides products and solutions with industrial security functions that support the secure operation of plants, systems, machines, and networks.

In order to protect plants, systems, machines and networks against cyber threats, it is necessary to implement – and continuously maintain – a holistic, state-of-the-art industrial security concept. Siemens' products and solutions constitute one element of such a concept.

Customers are responsible for preventing unauthorized access to their plants, systems, machines and networks. Such systems, machines and components should only be connected to an enterprise network or the internet if and to the extent such a connection is necessary and only when appropriate security measures (e.g. firewalls and/or network segmentation) are in place.

For additional information on industrial security measures that may be implemented, please visit:

<https://www.siemens.com/industrialsecurity>

Siemens' products and solutions undergo continuous development to make them more secure. Siemens strongly recommends that product updates are applied as soon as they are available and that the latest product versions are used. Use of product versions that are no longer supported, and failure to apply the latest updates may increase customer's exposure to cyber threats.

To stay informed about product updates, subscribe to the Siemens Industrial Security RSS Feed under

<https://www.siemens.com/industrialsecurity>.



## 2.6 Transportation and storage

To guarantee sufficient protection during transport and storage, observe the following:

- Keep the original packaging for subsequent transportation.
- Devices/replacement parts should be returned in their original packaging.
- If the original packaging is no longer available, ensure that all shipments are properly packaged to provide sufficient protection during transport. Siemens cannot assume liability for any costs associated with transportation damages.

<b>NOTICE</b>
<b>Insufficient protection during storage</b>
The packaging only provides limited protection against moisture and infiltration.
<ul style="list-style-type: none"><li>• Provide additional packaging as necessary.</li></ul>



Special conditions for storage and transportation of the device are listed in Technical data (Page 49).

## 2.7 Notes on warranty

The contents of this manual shall not become part of or modify any prior or existing agreement, commitment or legal relationship. The sales contract contains all obligations on the part of Siemens as well as the complete and solely applicable warranty conditions. Any statements regarding device versions described in the manual do not create new warranties or modify the existing warranty.

The content reflects the technical status at the time of publishing. Siemens reserves the right to make technical changes in the course of further development.





## Safety notes

### 3.1 Preconditions for use

This device left the factory in good working condition. In order to maintain this status and to ensure safe operation of the device, observe these instructions and all the specifications relevant to safety.

Observe the information and symbols on the device. Do not remove any information or symbols from the device. Always keep the information and symbols in a completely legible state.

#### 3.1.1 Safety marking symbols

In manual	On product	Description
		WARNING: refer to accompanying documents (manual) for details.
		Dispose of in an environmentally safe manner, and according to local regulations.

#### 3.1.2 Laws and directives

Observe the test certification, provisions and laws applicable in your country during connection, assembly and operation. These include, for example:

- National Electrical Code (NEC - NFPA 70) (USA)
- Canadian Electrical Code (CEC) (Canada)

Further provisions for hazardous area applications are for example:

- IEC 60079-14 (international)
- EN 60079-14 (EU)
- For Korea only:

이 기기는 업무용(A 급) 전자파 적합기기로서 판매자 또는 사용자는 이 점을 주의하시기 바라며 가정 외의

지역에서 사용하는 것을 목적으로 합니다

### 3.1.3 Conformity with European directives

The CE marking on the device symbolizes the conformity with the following European directives:

Electromagnetic compatibility EMC 2014/30/EU	Directive of the European Parliament and of the Council on the harmonisation of the laws of the Member States relating to electromagnetic compatibility
Low voltage directive LVD 2014/35/EU	Directive of the European Parliament and of the Council on the harmonisation of the laws of the Member States relating to the making available on the market of electrical equipment designed for use within certain voltage limits
Atmosphère explosible ATEX 2014/34/EU	Directive of the European Parliament and the Council on the harmonisation of the laws of the Member States relating to equipment and protective systems intended for use in potentially explosive atmospheres
2011/65/EU RoHS	Directive of the European Parliament and the Council on the restriction of the use of certain hazardous substances in electrical and electronic equipment

The applicable directives can be found in the EU declaration of conformity of the specific device.

 <b>WARNING</b>
<b>Improper device modifications</b>
Risk to personnel, system and environment can result from modifications to the device, particularly in hazardous areas.
<ul style="list-style-type: none"><li>• Only carry out modifications that are described in the instructions for the device. Failure to observe this requirement cancels the manufacturer's warranty and the product approvals.</li></ul>

## 3.2 Requirements for special applications

Due to the large number of possible applications, each detail of the described device versions for each possible scenario during commissioning, operation, maintenance or operation in systems cannot be considered in the instructions. If you need additional information not covered by these instructions, contact your local Siemens office or company representative.

---

### Note

#### Operation under special ambient conditions

We highly recommend that you contact your Siemens representative or our application department before you operate the device under special ambient conditions as can be encountered in nuclear power plants or when the device is used for research and development purposes.

---

**Note****Operation under special atmospheric conditions**

Ultrasonic measurement requires that the sound wave travel through the atmosphere in a consistent manner. Applications with atmospheric conditions different from air (including, but not limited to, gas layer stratification, very high methane or CO<sub>2</sub> concentrations), should be properly assessed to ensure safe, reliable use in the event of measurement errors due to sound wave velocity changes.

### 3.3 Use in hazardous areas

**Qualified personnel for hazardous area applications**

Persons who install, connect, commission, operate, and service the device in a hazardous area must have the following specific qualifications:

- They are authorized, trained or instructed in operating and maintaining devices and systems according to the safety regulations for electrical circuits, high pressures, aggressive, and hazardous media.
- They are authorized, trained, or instructed in carrying out work on electrical circuits for hazardous systems.
- They are trained or instructed in maintenance and use of appropriate safety equipment according to the pertinent safety regulations.

** WARNING****Use in hazardous area**

Risk of explosion.

- Only use equipment that is approved for use in the intended hazardous area and labelled accordingly.
- Don't use devices that have been operated outside the conditions specified for hazardous areas. If you have used the device outside the conditions for hazardous areas permanently make all Ex markings unrecognizable on the nameplate.

 **WARNING**

**Loss of safety of device with type of protection "Intrinsic safety Ex i"**

If the device or its components have already been operated in non-intrinsically safe circuits or the electrical specifications have not been observed, the safety of the device is no longer ensured for use in hazardous areas. There is a risk of explosion.

- Connect the device with type of protection "Intrinsic safety" solely to an intrinsically safe circuit.
- Observe the specifications for the electrical data on the certificate and/or in Technical data (Page 49).

## Description

SITRANS Probe LU240 ultrasonic level transmitter with HART, 4 to 20 mA is ideal for level, volume, and volume flow measurements. It works with liquids, slurries, and bulk materials up to 12 meters (40 feet).

This device supports HART communication protocol.

### Typical PLC/mA configuration

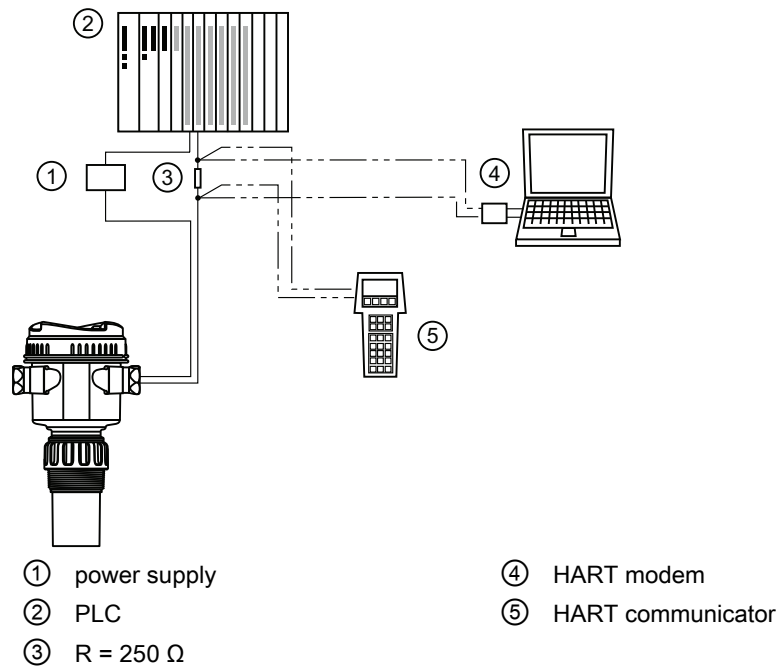







# Installing/mounting

## 5.1 Basic safety notes

 <b>CAUTION</b>
<b>Hot surfaces resulting from hot process media</b> Risk of burns resulting from surface temperatures above 65 °C (149 °F). <ul style="list-style-type: none"><li>• Take appropriate protective measures, for example contact protection.</li><li>• Make sure that protective measures do not cause the maximum permissible ambient temperature to be exceeded. Refer to the information in Technical data (Page 49).</li></ul>

 <b>WARNING</b>
<b>Wetted parts unsuitable for the process media</b> Risk of injury or damage to device. Hot, toxic and corrosive media could be released if the process medium is unsuitable for the wetted parts. <ul style="list-style-type: none"><li>• Ensure that the material of the device parts wetted by the process medium is suitable for the medium. Refer to the information in Technical data (Page 49).</li></ul>

---

### Note

#### Material compatibility

Siemens can provide you with support concerning selection of sensor components wetted by process media. However, you are responsible for the selection of components. Siemens accepts no liability for faults or failures resulting from incompatible materials.

---

 <b>WARNING</b>
<b>Unsuitable connecting parts</b> Risk of injury or poisoning. In case of improper mounting, hot, toxic, and corrosive process media could be released at the connections. <ul style="list-style-type: none"><li>• Ensure that connecting parts (such as flange gaskets and bolts) are suitable for connection and process media.</li></ul>

 <b>WARNING</b>
<b>Exceeded maximum permissible operating pressure</b> Risk of injury or poisoning. The maximum permissible operating pressure depends on the device version, pressure limit and temperature rating. The device can be damaged if the operating pressure is exceeded. Hot, toxic and corrosive process media could be released. Ensure that maximum permissible operating pressure of the device is not exceeded. Refer to the information on the nameplate and/or in Technical data (Page 49).

 <b>CAUTION</b>
<b>External stresses and loads</b> Damage to device by severe external stresses and loads (e.g. thermal expansion or pipe tension). Process media can be released. <ul style="list-style-type: none"><li>• Prevent severe external stresses and loads from acting on the device.</li></ul>

### 5.1.1 Installation location requirements

<b>NOTICE</b>
<b>Strong vibrations</b> Damage to device. <ul style="list-style-type: none"><li>• In installations with strong vibrations, mount the transmitter in a low vibration environment.</li></ul>

 <b>CAUTION</b>
<b>Aggressive atmospheres</b> Damage to device through penetration of aggressive vapors. <ul style="list-style-type: none"><li>• Ensure that the device is suitable for the application.</li></ul>

 <b>CAUTION</b>
<b>Direct sunlight</b> Device damage. The device can overheat or materials become brittle due to UV exposure. <ul style="list-style-type: none"><li>• Protect the device from direct sunlight.</li><li>• Make sure that the maximum permissible ambient temperature is not exceeded. Refer to the information in Operating conditions (Page 52).</li></ul>

<b>NOTICE</b>
<b>Mounting location</b> <ul style="list-style-type: none"><li>• Ideally, mount device so that face of transducer is at least 300 mm (1 ft) above the highest anticipated material level.</li></ul>

#### 5.1.1.1

#### Recommended

- Ambient temperature within  $-40$  to  $+80$  °C ( $-40$  to  $+176$  °F)
- Process temperature within  $-40$  to  $+85$  °C ( $-40$  to  $+185$  °F)
- Environment suitable to the housing rating and materials of construction
- Sound path perpendicular to the material surface
- Display and local buttons easily accessible for programming
- Cable entries easily accessible for wiring
- Sufficient room to open device lid with clear access
- Mounting surface free from vibration
- Place for a laptop computer provided for on-site configuration (optional, as laptop not required for configuration)

<b>NOTICE</b>
<b>Device rotation</b> The device can be rotated separate from the process connection. <ul style="list-style-type: none"><li>• There is no limit to the number of times device can be rotated without damage.</li></ul>

5.1 Basic safety notes

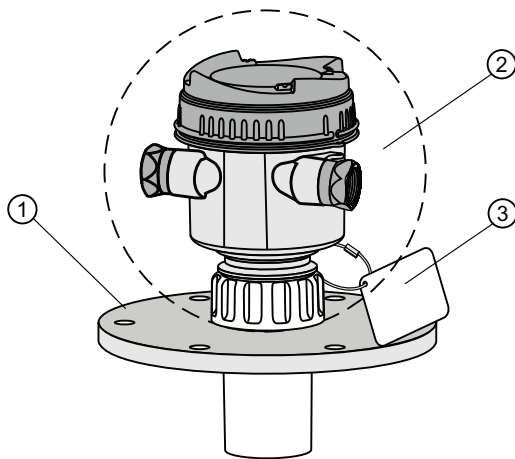

- ① Customer-supplied flange
- ② Ambient temperature surrounding enclosure  $-40$  to  $+80$  °C ( $-40$  to  $+176$  °F)
- ③ Device tag (optional)

5.1.1.2 Avoid

- Proximity to high voltage or current wiring, high voltage or current contacts, and to variable frequency motor speed controllers
- Exposure to direct sunlight. (Provide a sun shield to avoid direct sunlight.)
- Interference to sound path from obstructions (such as rough walls, seams, rungs, etc.), or from fill path

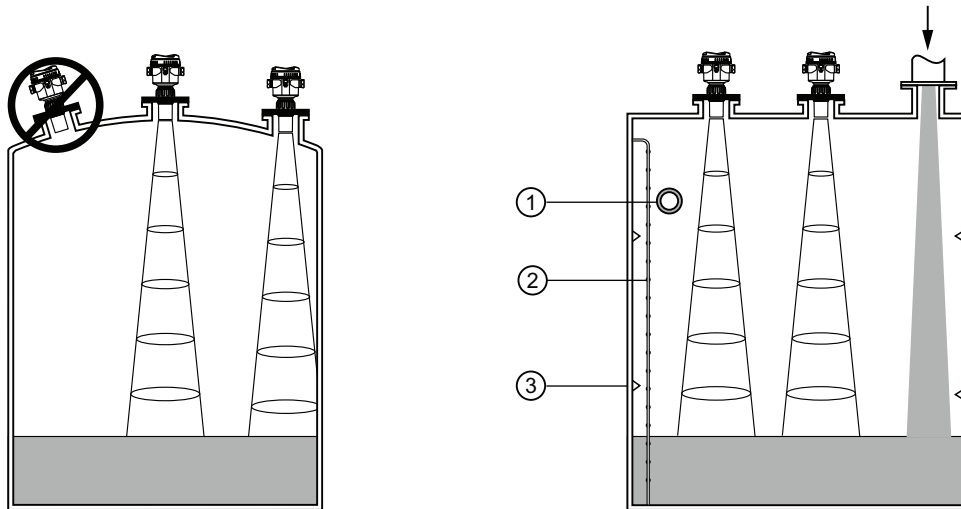

- ① Pipe
- ② Rungs
- ③ Seams

## 5.1.2 Proper mounting

### NOTICE

#### Incorrect mounting

The device can be damaged, destroyed, or its functionality impaired through improper mounting.

- Before installing ensure there is no visible damage to the device.
- Make sure that process connectors are clean, and suitable gaskets and glands are used.
- Mount the device using suitable tools. Refer to the information in Technical data (Page 49).

### 5.1.2.1 Process connections

Process connections are available with three thread types:

- 2" NPT [(Taper), ASME B1.20.1]
- R 2" [(BSPT), EN 10226]
- G 2" [(BSPP), EN ISO 228-1]

### NOTICE

#### Process connection type

The thread type can be found on the device process connection, defined by a letter in the mold, near the end of the threads.

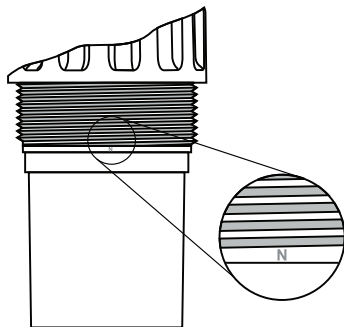

N=NPT

B=R2/BSPT

P=G2/BSPP/PF2

1. Before inserting device into its mounting connection, ensure threads are of the same type to avoid damaging them.
2. Screw device into process connection and hand tighten, or use a strap wrench to seat gasket if required (1/4 turn past hand tight is recommended).

## 5.2 Disassembly

<p> <b>WARNING</b></p>
<p><b>Incorrect disassembly</b></p> <p>The following risks may result from incorrect disassembly:</p> <ul style="list-style-type: none"><li>- Injury through electric shock</li><li>- Risk through emerging media when connected to the process</li><li>- Risk of explosion in hazardous area</li></ul> <p>In order to disassemble correctly, observe the following:</p> <ul style="list-style-type: none"><li>● Before starting work, make sure that you have switched off all physical variables such as pressure, temperature, electricity etc. or that they have a harmless value.</li><li>● If the device contains hazardous media, it must be emptied prior to disassembly. Make sure that no environmentally hazardous media are released.</li><li>● Secure the remaining connections so that no damage can result if the process is started unintentionally.</li></ul>

## Connecting

### 6.1 Basic safety notes

<b>NOTICE</b>
<p><b>Condensation in the device</b></p> <p>Damage to device through formation of condensation if the temperature difference between transportation or storage and the mounting location exceeds 20 °C (36 °F).</p> <ul style="list-style-type: none"> <li>• Before taking the device into operation let the device adapt for several hours in the new environment.</li> </ul>

 <b>WARNING</b>
<p><b>Connecting device in energized state</b></p> <p>Risk of explosion in hazardous areas.</p> <ul style="list-style-type: none"> <li>• Connect devices in hazardous areas only in a de-energized state.</li> </ul>

### 6.2 Connecting SITRANS Probe LU240

 <b>WARNING</b>
<p><b>Incorrect connection to power source</b></p> <p>Risk to personnel, system and environment can result from improper power connection.</p> <ul style="list-style-type: none"> <li>• The DC input terminals shall be supplied from a source providing electrical isolation between the input and output, in order to meet the applicable safety requirements of IEC 61010-1. For example, SELV source.</li> <li>• All field wiring must have insulation suitable for rated voltages.</li> </ul>

 <b>WARNING</b>
<p><b>Loss of protection</b></p> <p>Loss of approvals can result from improper connection.</p> <ul style="list-style-type: none"> <li>• Check the nameplate on your device, to verify the approval rating.</li> <li>• Use approved cable gland/conduit seal to maintain TYPE 4X, TYPE 6, IP66, IP68 ratings.</li> <li>• See Hazardous area installations (Page 25).</li> </ul>

**Note**

**Considerations for connecting device**

- Use shielded, twisted pair cable (wire gauge AWG 22 to AWG 14/ 0.34 mm<sup>2</sup> to 2.08 mm<sup>2</sup>).
  - Separate cables and conduits may be required to conform to standard instrumentation wiring practices, or electrical codes.
  - If cable is routed through conduit, use only approved suitable-size hubs for waterproof applications.
  - Non-metallic enclosure does not provide a continuous ground path between conduit connections: use grounding-type bushings and jumpers.
  - More detailed information can be found on Hazardous area installations (Page 25).
- 

**6.2.1 Wiring instructions**

**Note**

**Initial connection**

The display is not connected to the device when shipped. If this is not initial connection, remove the display before wiring. See Remove existing display (Page 44).

---

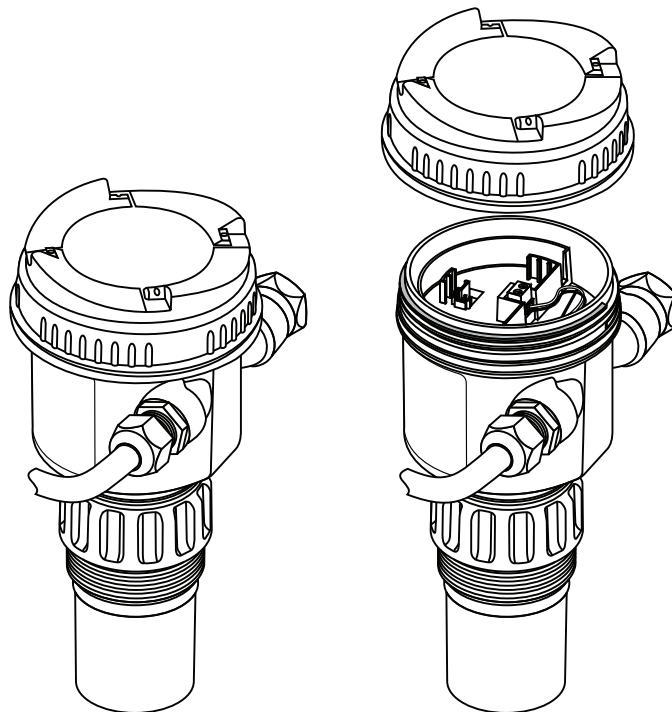



1. Turn lid by hand in a counter-clockwise direction to remove it from device.
2. Strip cable jacket for approximately 70 mm (2.75") from end of cable, and thread wires through gland.
3. Connect wires to terminals as shown below: polarity is identified on terminal block.

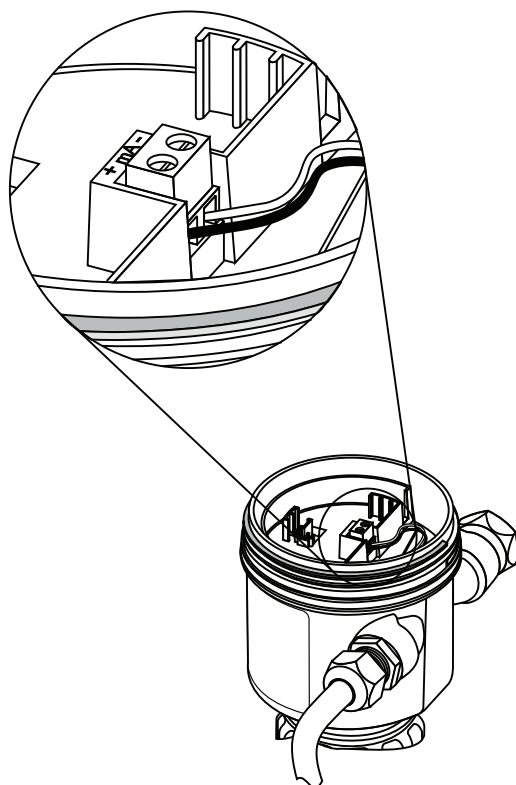

4. Tighten gland to form a good seal.
5. Press female end of cable from optional display onto male four-pin connector. See Remove existing display (Page 44) for illustration.
6. Set optional display into enclosure. Buttons on display should sit over terminal block. Gently turn display a quarter turn clockwise to secure the display in the enclosure.
7. Replace device lid. Thread onto enclosure, turning clockwise. Hand tighten.

## 6.3 Hazardous area installations

### **WARNING**

#### **Improper power supply**

Risk of explosion in hazardous areas as result of incorrect power supply.

- Connect the device in accordance with the specified power supply and signal circuits. The relevant specifications can be found in the certificates, in Technical data (Page 49) or on the nameplate.

### 6.3.1 Nameplates for hazardous area installations

#### 6.3.1.1 Intrinsic safety wiring

#### Device nameplate (ATEX/IECEX/INMETRO/RCM)

**Note**

**Sample nameplate**

This nameplate is given as an example only.

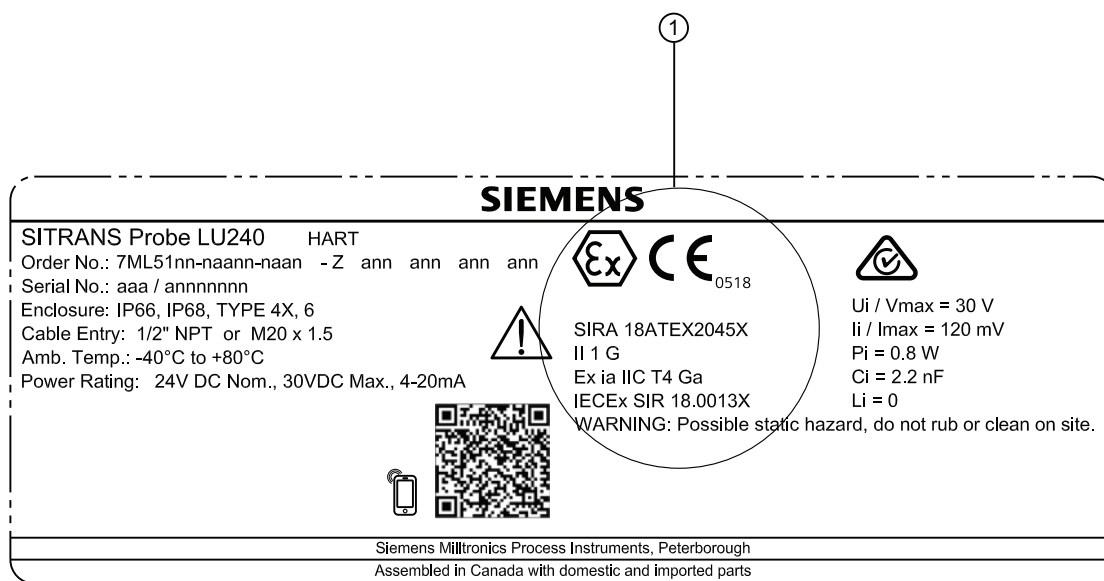

① ATEX certificate

The ATEX certificate number (SIRA 18ATEX2045X) listed on the nameplate can be downloaded from our website:

Product page ([www.siemens.com/sitransprobelu240](http://www.siemens.com/sitransprobelu240))

Go to **Support > Approvals/Certificates**.

The IECEx certificate listed on the nameplate can be viewed on the IECEx website:

<http://iecex.iec.ch> (<http://iecex.iec.ch>)

Under the "Certified Equipment" tab in the "Certificate/ExTR/QAR number" field, enter the IECEx SIR number:18.0013X.

For more information on hazardous area installations, refer to Instructions specific to hazardous area installations (Page 27).

### Connection drawing (FM/CSA)

The FM/CSA connection drawing number (A5E44090649A) listed on the device nameplate can be downloaded from our website:

Product page ([www.siemens.com/sitransprobelu240](http://www.siemens.com/sitransprobelu240))

Go to **Technical Info > Images, graphics, drawings.**

### 6.3.1.2 Non-incendive wiring

### Connection drawing (FM)

The FM connection drawing number (A5E44092290) listed on the device nameplate can be downloaded from our website:

Product page ([www.siemens.com/sitransprobelu240](http://www.siemens.com/sitransprobelu240))

Go to **Technical info > Images, graphics, drawings.**

### 6.3.1.3 Further information related to hazardous area installations



- For wiring requirements follow local regulations.
- Use approved cable gland/conduit seal to maintain Type 4X, Type 6, IP66, IP68 ratings.

## 6.3.2 Instructions specific to hazardous area installations

### 6.3.2.1 Instructions in accordance with IEC 60079-0:2011 clause 30

The following instructions relevant to safe use in a hazardous area apply to equipment covered by certificate numbers Sira 18ATEX2045X and IECEx SIR 18.0013X.

1. The certification marking is as follows:

Certificate number:	IECEx SIR 18.0013X	Sira 18ATEX2045X
Certification code:	Ex ia IIC T4 Ga	Ex ia IIC T4 Ga
Other marking:		 

2. The equipment may be used in zones 0, 1 & 2 with flammable gases and vapours with apparatus groups IIA, IIB & IIC and with temperature classes T4.
3. The equipment is only certified for use in ambient temperatures in the range -40 °C to +80 °C and should not be used outside this range.
4. Installation shall be carried out in accordance with the applicable code of practice by suitably-trained personnel.
5. There are no special checking or maintenance conditions other than a periodic check.
6. With regard to explosion safety, it is not necessary to check for correct operation.

6.3 Hazardous area installations

7. The equipment contains no user-replaceable parts and is not intended to be repaired by the user. Repair of the equipment is to be carried out by the manufacturer, or their approved agents, in accordance with the applicable code of practice.
8. Repair of this equipment shall be carried out in accordance with the applicable code of practice.
9. If the equipment is likely to come into contact with aggressive substances, e.g. acidic liquids or gases that may attack metals or solvents that may affect polymeric materials, then it is the responsibility of the user to take suitable precautions that prevent it from being adversely affected thus ensuring that the type of protection is not compromised.
10. The certificate number has an 'X' suffix which indicates that special conditions of installation and use apply. Those installing or inspecting this equipment must have access to the contents of the certificate or these instructions. The conditions listed in the certificate are reproduced below:
  - Under certain extreme circumstances, the non-metallic parts incorporated in the enclosure of this equipment may generate an ignition-capable level of electrostatic charge. Therefore the equipment shall not be installed in a location where the external conditions are conducive to the build-up of electrostatic charge on such surfaces.
  - In addition, the equipment shall only be cleaned with a damp cloth. This is particularly important if the equipment is installed in a zone 0 location.

# Commissioning

## 7.1 Basic safety notes

 <b>WARNING</b>
<b>Loss of explosion protection</b> Risk of explosion when device is not properly commissioned If opening device <ul style="list-style-type: none"><li>• Isolate from power.</li></ul> - or - <ul style="list-style-type: none"><li>• Ensure that the atmosphere is explosion-free (hot work permit).</li></ul> Ensure device is properly closed before returning to operation.

## 7.2 Local commissioning

### 7.2.1 Activating SITRANS Probe LU240

Power up the device.

SITRANS Probe LU240 runs through an initialization routine for approximately three seconds. Next, the device name and then firmware revision appear. The display goes into **measurement view** (measured process values show as "- - - -" before the first measurement is completed). The "Distance" measurement (displayed in meters) appears first by default. Press ▼ button to scroll through other values in **measurement view**.

The device is now ready for operation.

### 7.2.2 Local display

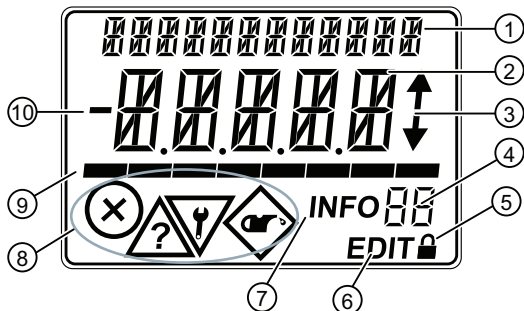

- ① Title line
- ② Main line
- ③ UP/DOWN navigation arrows
- ④ Info field
- ⑤ Lock symbol
- ⑥ EDIT indicator
- ⑦ INFO indicator
- ⑧ NE107 diagnostic states
- ⑨ Bar graph
- ⑩ Sign of the process value

### 7.2.3 Display symbols

INFO field	Symbol	Meaning
LP	🔒	Device is write-protected via parameter "User PIN".
LL		Device is write-protected via parameter "Button lock".
Co		Loop test is running.
	EDIT	When symbol is flashing, you can edit the parameter.
	INFO	Diagnostic message. The ID next to the "INFO" symbol is used for identification of the diagnostic message.

For a complete list of diagnostic messages that appear on the local display, refer to the **Diagnosing and troubleshooting** chapter of the full operating instructions.

### 7.2.4 Display views

**Note**

**Display views**

- **Edit view** and **measurement view** refer to the display only. While the device is in **edit view**, the output remains active and continues to respond to changes in the device.
- The display will return to **measurement view** after ten minutes of inactivity (from last button press), when in **edit view** and from within a wizard. Pressing ► button will then take you to the main navigation menu. (It will not return to the screen from which the timeout occurred.)

**Measurement view** shows the current measured values of the device as well as status and diagnostic messages.

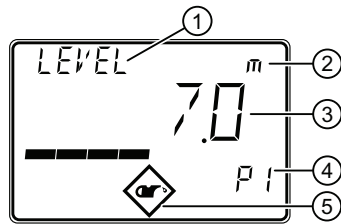

- ① Process value name
- ② Process value unit  
(① and ② alternate on display)
- ③ Process value measurement  
If the process value is too large to be shown on the display (value has more than 5 digits), hashes "#####" will be shown instead.
- ④ Process value number
- ⑤ Diagnostic symbol

**Parameter view** shows the parameters, parameter values and the wizards of the device.

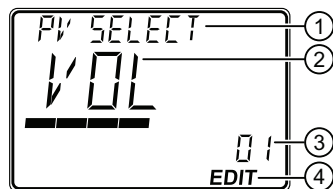

- ① Parameter name
- ② Parameter value
- ③ Parameter number
- ④ "EDIT" symbol (permanently enabled)

### Edit view

Change parameter values in this view. Wizards are available for specific parameters.

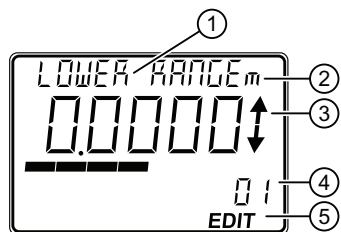

- ① Parameter name
- ② Process value unit (① and ② alternate on display)
- ③ Scrolling arrows (within options list only)
- ④ Parameter number
- ⑤ "EDIT" symbol (flashing)

**Service view**

Sets operation of local device display to show menu numbers in **parameter view**.

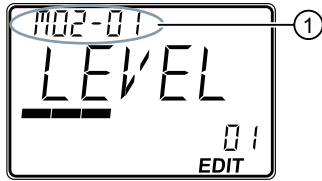

① Menu number

Parameter name (top left), parameter unit (if available, top right), and menu number (as shown above, top left) alternate in two-second intervals.

**Note****Show menu numbers on local display**

To view menu numbers on the device, parameter "Service view" must be enabled. (Go to menu "Setup > Local display".)

- The item number of the current selection appears in the **info field**.
- The menu number in which the current selection resides, appears on the **title line** (thus no menu numbers appear for top-level menu items, such as "QUICK START", "SETUP", etc.).

**7.2.5****Parameter menus****Note****Complete parameter list**

For a complete list of parameters with instructions, and dimension drawings, see the full operating instructions.

Parameters are identified by name and organized into function groups, then arranged in a three-level menu structure.

On the local display:

- Navigate to a menu - menu name shows on **title line**, and "MENU" shows on **main line**. (**Info field** shows number of current selection within menu structure.)
- Navigate to a wizard - wizard name shows on **title line**, and "WIZ" shows on **main line**. (**Info field** shows number of current selection within menu structure.)
- Navigate to a parameter - parameter name shows on **title line**, and parameter number shows in **info field**.







**Note****Items numbers may not appear sequentially**

Although item numbers are sequential, they may not appear so as some menus and parameters are only visible on the device based on configuration settings.





## 7.2.6 Programming

From **measurement view**, press  button to enter **parameter view** and open the first menu level **M 01**.





**To select a listed option:**

1. Navigate to the desired parameter.
2. Press  button to open **edit view**. The current selection is highlighted.
3. Scroll to a new selection using  and  buttons.
4. Press  button to accept it. The display returns to **parameter view** and shows the new selection.

**To change a numeric value:**

1. Navigate to the desired parameter.
2. When selected, the current value is displayed.
3. Press  button to configure it. The "EDIT" symbol is flashing.
4. Use  and  buttons to increase or decrease the value. Press and hold button to increase scrolling speed.
5. To escape without saving your changes, press  button to return to **parameter view**.
6. Press  button to accept the new value. The display returns to **parameter view** ("EDIT" symbol is no longer flashing) and shows the new selection. Review for accuracy.

**Button functions for editing**

Button	Name		Function
	UP or DOWN arrow	Selecting parameter settings	Scrolls to item
		Alpha-numeric editing	Increases or decreases value. Pressing and holding will increase scrolling speed through values.
	RIGHT arrow	Selecting parameters	Accepts the data (writes the parameter setting)
	LEFT arrow	Selecting parameter settings	Cancels <b>edit view</b> without changing the parameter setting.

## 7.2.7 Wizards

---

### Note

#### Complete parameter list

For a complete list of parameters with instructions, and dimension drawings, see the full operating instructions.

---

#### Quick commissioning wizard

The SITRANS Probe LU240 provides a single quick commissioning wizard that can be used for various applications.

The initial wizard steps are common for all application types. Subsequent wizard parameters will vary depending on the application you choose. For the purpose of documenting, three separate lists follow. These lists include the wizard parameters available to commission each application type (see links below).

1. From **measurement view**, press ► button to enter **parameter view**. The first level menu (QUICK START) will display. Press ► button to enter this menu.
2. Press ► button again to enter "Quick commissioning wizard" (COMMISSION). In the wizard, it is not necessary to press ▼ button to navigate to the next step. In each step, you are taken directly to **edit view**.
3. Set "Operation", then "Material type".  
Subsequent wizard parameters will vary depending on the application you choose. See links below to step you through the wizard appropriate to your application.
4. Select "Yes" to confirm all parameter changes as the final step in the quick commissioning wizard, and return to **parameter view**. "DONE" will appear on the main line of the display.
5. Press ◀ button three times to return to **measurement view**.

For more information about commissioning a Level, Space, Distance or Custom application, go to Quick commissioning: Level/Space/Distance/Custom (Page 35).

For more information about commissioning a Volume application, go to Quick commissioning: Volume (Page 40).

For more information about commissioning a Volume flow application, go to Quick commissioning: Volume flow (Page 41).

**Note****Important information regarding the use of commissioning wizard**

- A reset to factory defaults should be performed before running "Quick commissioning wizard" if the device has been used in a previous application. (Go to menu "**Maintenance and diagnostics > Resets**", and for parameter "Reset", select setting "Factory reset".)
- Settings for quick commissioning wizard are inter-related and changes apply only after "Confirm" is set to 'Yes' in final step.
- Do not use quick commissioning wizard to modify individual parameters. (See instead chapter "Parameter assignment - Local" in full operating instructions.) Perform customization for your application only *after* "Quick commissioning wizard" has been completed.

**Note****Wizard operation requires 22.5 mA**

Device output will read 22.5 mA during wizard operation. When wizard completes, device output will return to normal behavior.

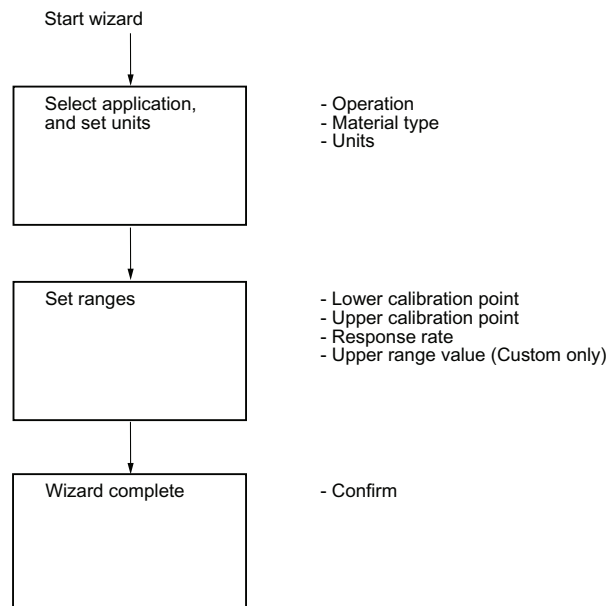
**7.2.7.1****Quick commissioning: Level/Space/Distance/Custom**

**Note**

**Distance and Custom applications**

- When "Operation" is set to "Distance", setting the upper calibration point is not required (will not appear in the wizard).
- Only when "Operation" is set to "Custom", is the upper range value required (will appear in the wizard).

**Note**

**Output remains active**

While the device is being configured, the output remains active and continues to respond to changes in the device.

**Note**

**Parameter options**

In the following wizard steps, a full list of options for each parameter is shown. However, some options may not appear on the device, based on the application selected.

**Operation**

Sets operation mode which defines output and local display.

Setting	Level	LEVEL
	Space	SPACE
	Distance	DIST
	Volume	VOL
	Volume flow	VFLOW
	Custom	CUSTM
Default	Level	LEVEL

**Note**

**Completing a Custom setup**

For a custom application ("Operation" set to "Custom"), at least one pair of input and output breakpoints (parameters "X-value" and "Y-value") must be defined *after* the wizard is complete. Refer to full operating instructions: In **Parameter assignment - Local** chapter, see menu **Setup > Custom > Customized characteristic curve**.

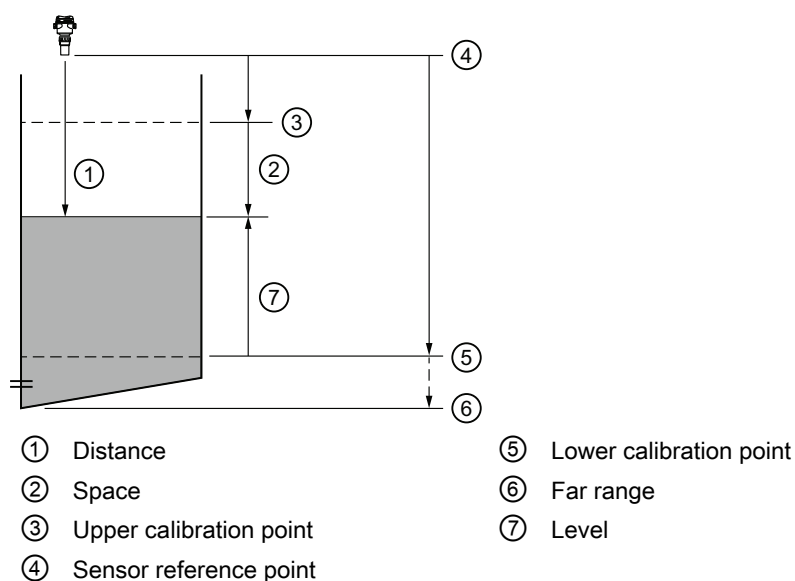

Setting		Description	Reference point
Level	LEVEL	Height of material	Lower calibration point (process empty level)
Space	SPACE	Distance to material surface	Upper calibration point (process full level)
Distance	DIST		Sensor reference point
Custom	CUSTM	Linearization table (level/volume or level/flow breakpoints)	Lower calibration point

## Material type

Used to optimize performance based on material type.

Setting	Liquid	LQD
	Solid	SOLID
Default	Liquid	LQD

## Units

Sets measurement units used.

			Default
Setting	Meters	m	3 decimal places
	Centimeters	cm	1 decimal place
	Millimeters	mm	0 decimal places
	Feet	Ft	3 decimal places
	Inches	in	2 decimal places
Default	Meters	m	3 decimal places

**Note**

**Dynamic decimal places**

Each setting for parameter "Units" has a default number of decimal places used to show the process value on the local display. However, if the value is too large to show on the segment display, the decimal places will be automatically adjusted to show the process value.

**Lower calibration point**

Sets distance from sensor reference point to lower calibration point: usually process empty level.

Setting	<ul style="list-style-type: none"> <li>• 0 to 6 m (6 m device)</li> <li>• 0 to 12 m (12 m device)</li> </ul>
Default	<ul style="list-style-type: none"> <li>• 6 m (6 m device)</li> <li>• 12 m (12 m device)</li> </ul>

Defined in parameter "Units".

**Upper calibration point**

Sets distance from sensor reference point to upper calibration point: usually process full level.

Setting	<ul style="list-style-type: none"> <li>• 0 to 6 m (6 m device)</li> <li>• 0 to 12 m (12 m device)</li> </ul>
Default	0 m

Defined in parameter "Units".

**Response rate**

Sets reaction speed of device to measurement changes in target range.

Use a setting just faster than the maximum filling or emptying rate (whichever is faster).

**Note**

**Response rate**

The parameter "Response rate" can only be set through the "Quick commissioning" wizard and any changes made to parameters "Fill rate", "Empty rate" or "Damping value" following the completion of the wizard will supersede the response rate setting.

Setting	Slow	SLOW	0.1 m/min (fill/empty rate)
	Medium	MED	1.0 m/min (fill/empty rate)
	Fast	FAST	10.0 m/min (fill/empty rate)
Default	Slow		

Further information can be found in full operating instructions - see **Measurement response** in **Technical reference** appendix.

## Upper range value

Sets process value that corresponds to 20 mA loop current.

Setting	0 to 9999999
Default	100 <Custom units>

### Note

#### "Upper range value" (URV) versus "Upper scaling point"

- When parameter "Upper range value" is set within the "Quick commissioning wizard", the parameter "Upper scaling point" is automatically adjusted to the same value.
- Setting a value for either parameter *outside* of the wizard will not automatically adjust the other value.

### Note

#### Changing custom units

If a change is made to custom units, be sure to rescale the output, as rescaling for custom units is not handled automatically by the device.

- Use parameters "Upper range value" and "Upper scaling point" to rescale output.

## Confirm

Applies settings as last step in wizard.

Setting	Yes. Wizard completes and settings are applied.	YES
	No. Returned to start of wizard. (Settings are saved to perform wizard again, but not applied until "Confirm" set to "YES".)	NO
Default	No	NO

### 7.2.7.2 Quick commissioning: Volume

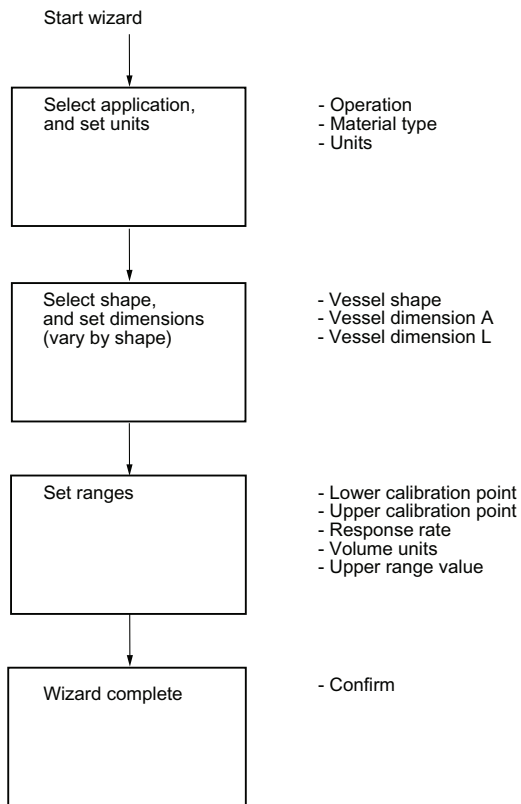



### 7.2.7.3 Quick commissioning: Volume flow

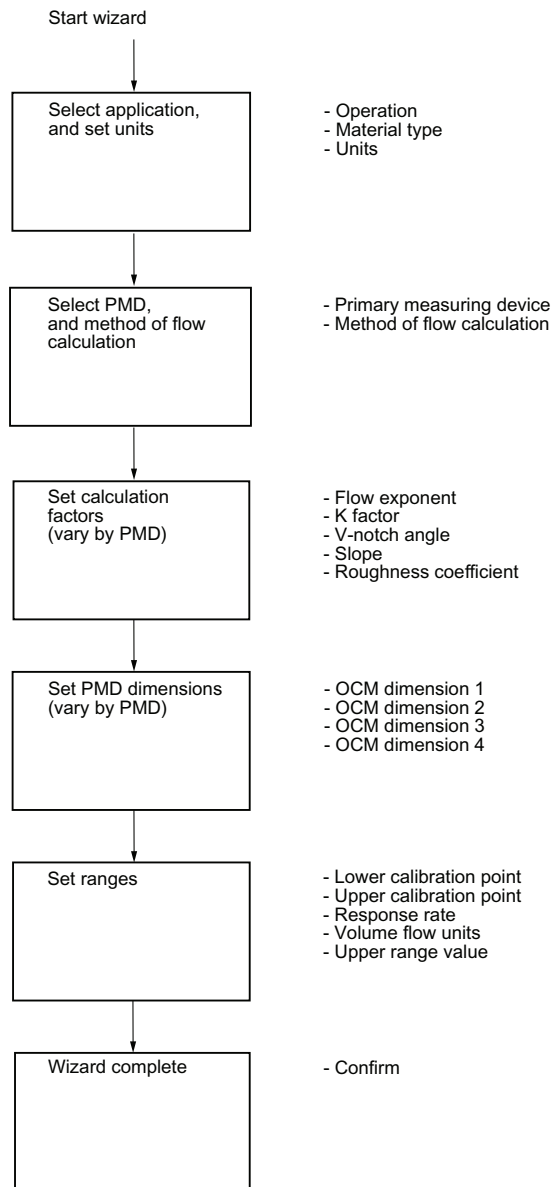



## Service and maintenance

### 8.1 Basic safety notes

The device is maintenance-free. However, a periodic inspection according to pertinent directives and regulations must be carried out.

An inspection can include check of:

- Ambient conditions
- Seal integrity of the process connections, cable entries, and cover screws
- Reliability of power supply, lightning protection, and grounds

#### NOTICE

##### Penetration of moisture into the device

Device damage.

- Make sure when carrying out cleaning and maintenance work that no moisture penetrates the inside of the device.

#### CAUTION

##### Releasing button lock

Improper modification of parameters could influence process safety.

- Make sure that only authorized personnel may cancel the button locking of devices for safety-related applications.

### 8.2 Cleaning

#### Cleaning the enclosure

- Clean the outside of the enclosure with the inscriptions and the display window using a cloth moistened with water or a mild detergent.
- Do not use any aggressive cleansing agents or solvents, e.g. acetone. Plastic parts or the painted surface could be damaged. The inscriptions could become unreadable.

 <b>WARNING</b>
<b>Maintenance during continued operation in a hazardous area</b>
There is a risk of explosion when carrying out repairs and maintenance on the device in a hazardous area.
<ul style="list-style-type: none"><li>• Isolate the device from power.</li></ul>
- or -
<ul style="list-style-type: none"><li>• Ensure that the atmosphere is explosion-free (hot work permit).</li></ul>

## 8.3 Maintenance and repair work

 <b>WARNING</b>
<b>Impermissible repair of the device</b>
<ul style="list-style-type: none"><li>• Repair must be carried out by Siemens authorized personnel only.</li></ul>

 <b>WARNING</b>
<b>Humid environment</b>
Risk of electric shock.
<ul style="list-style-type: none"><li>• Avoid working on the device when it is energized.</li><li>• If working on an energized device is necessary, ensure that the environment is dry.</li><li>• Make sure when carrying out cleaning and maintenance work that no moisture penetrates the inside of the device.</li></ul>

### 8.3.1 Replacing the display

#### 8.3.1.1 Remove existing display

To remove display for wiring or to replace a damaged display, follow steps below:

1. Turn lid by hand in a counter-clockwise direction to remove it from device.
2. Remove display by gently turning the display a quarter turn counter-clockwise, to free it from the enclosure.
3. Pull up to disconnect display cable from connector. The display is now free to lift out of enclosure.  
(Dispose of a damaged display according to local regulations.)

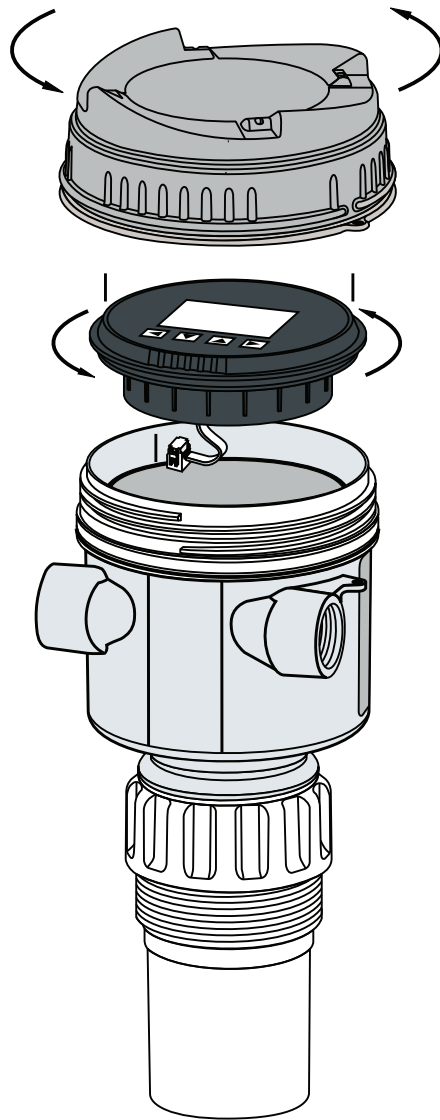

### 8.3.1.2 Install a new display

---

#### Note

#### Mounting orientation for display

The display can be mounted in 1 of 4 positions at 90 degree intervals, for easy viewing after installation.

---

1. Press the female end of cable from replacement display onto male four-pin connector.
2. Set replacement display into enclosure approximately one quarter turn counter-clockwise from the desired final orientation. Gently turn display one quarter turn clockwise to secure the display in the enclosure.
3. Replace device lid. Thread onto enclosure, turning clockwise. Hand tighten.

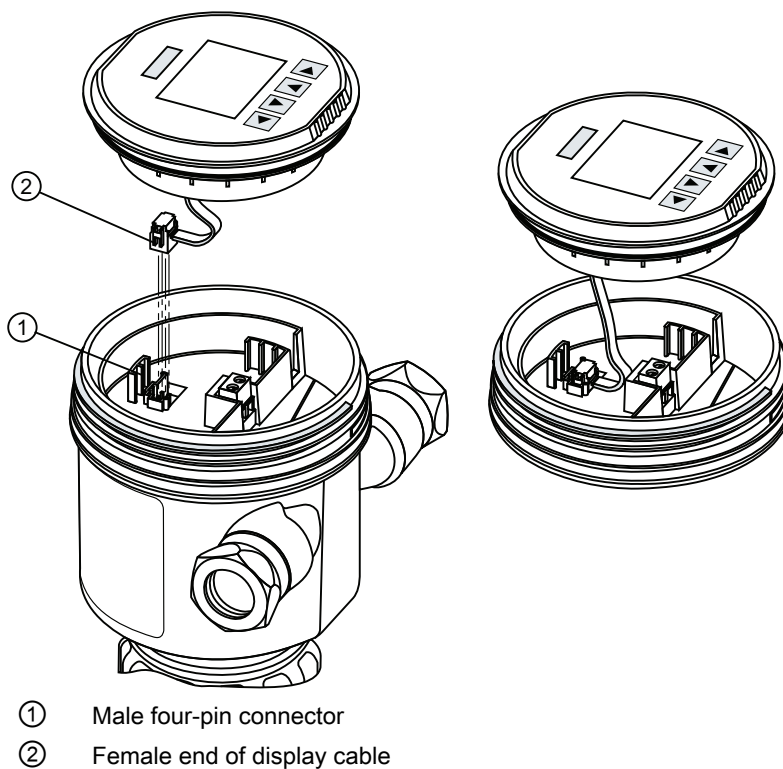

## 8.4 Return procedure

Enclose the bill of lading, return document and decontamination certificate in a clear plastic pouch and attach it firmly to the outside of the packaging. Any devices/replacement parts which are returned without a decontamination declaration will be cleaned at your expense before further processing. For further details, refer to the operating instructions.

## 8.5 Disposal



Devices described in this manual should be recycled. They may not be disposed of in the municipal waste disposal services according to the Directive 2012/19/EC on waste electronic and electrical equipment (WEEE). Devices can be returned to the supplier within the EC, or to a locally approved disposal service for eco-friendly recycling. Observe the specific regulations valid in your country.

Further information about devices containing batteries can be found at: Information about battery / product return (WEEE) (<https://support.industry.siemens.com/cs/document/109479891/>)

---

**Note**

**Special disposal required**

The device includes components that require special disposal.

- Dispose of the device properly and environmentally through a local waste disposal contractor.
-





## Technical data

---

### Note

#### Device specifications

Siemens makes every attempt to ensure the accuracy of these specifications but reserves the right to change them at any time.

---



---

### Note

#### Device-specific approvals

Always refer to nameplates on the device for device-specific approvals.

---



---

### Note

#### Power

Nominal 24 V DC at maximum 550 Ohm. For other configurations, see **Loop power** in **Technical reference** appendix of full operating instructions.

---

## 9.1 Power

Supply voltage	30 V DC maximum
Signal range	4 to 20 mA
Startup current	3.6 mA maximum

SITRANS Probe LU240 with Explosion protection Ex ia	
$U_i$ (Input voltage)	30 V DC maximum
$I_i$ (Input current)	120 mA DC maximum
$P_i$ (Input power)	0.8 W
$C_i$ (Effective inner capacitance)	0 nF
$L_i$ (Effective inner inductance)	0 mH

## 9.2 Performance

Reference operating conditions (in accordance with IEC 60770-1)	
Ambient temperature	+15 to +25 °C
Humidity	45 to 75% relative humidity
Ambient pressure	860 to 1060 mbar

Measurement accuracy (in accordance with IEC 60770-1)	
Measured error (accuracy)	+/- the greater of 0.15% of range or 6mm (accuracy valid from 0.25 m)
Non-repeatability	≤ 3 mm (0.12") (included in accuracy specification)
Deadband (resolution)	≤ 3 mm (0.12") (included in accuracy specification)
Hysteresis error	Not applicable

Analog output accuracy (in accordance with IEC 60770-1)	
Measured error (accuracy)	0.02% of 4..20 mA span (including hysteresis and non-repeatability)
Non-repeatability	<1 µA (included in accuracy specification)
Deadband (resolution)	<1 µA (included in accuracy specification)
Hysteresis error	Not applicable

Frequency	54 KHz
Measurement range <sup>1)</sup>	<ul style="list-style-type: none"> <li>• Up to 6 m (6 m device)</li> <li>• Up to 12 m (12 m device)</li> </ul>
Blanking distance	0.2 m (0.66 ft)
Update time at 4 mA	<4 s
Beam angle	10° at -3 dB boundary
Temperature compensation	Integrated to compensate over temperature range
Memory	Non-volatile EEPROM, no battery required

<sup>1)</sup> Reference point for measurement is the transducer face (also known as sensor reference point).

## 9.3 Interface

HART	Standard, integral to analog output
Configuration	Local buttons, or engineering system such as Siemens SIMATIC PDM (via PC)
Display (local)	Multi-segment alphanumeric liquid crystal, with bar graph (representing Level)

## 9.4 Outputs

Analog output	<ul style="list-style-type: none"> <li>• 4 to 20 mA</li> </ul>
	<ul style="list-style-type: none"> <li>• 800 ohms maximum</li> </ul>
	<ul style="list-style-type: none"> <li>• <math>\pm 0.02</math> mA accuracy</li> <li>• Resolution of <math>&lt; 1 \mu\text{A}</math></li> </ul>

## 9.5 Construction

Process connections	<ul style="list-style-type: none"> <li>• 2" NPT (ASME B1.20.1) (tapered thread)</li> <li>• R 2" [(BSPT), EN 10226-1] (tapered thread)</li> <li>• G 2" [(BSPP), EN ISO 228-1] (parallel thread)</li> </ul>	
Transducer/nosecone	<ul style="list-style-type: none"> <li>• Buna-N seal</li> <li>• PVDF (polyvinylidene fluoride)</li> <li>• ETFE (ethylene-tetrafluoroethylene)</li> </ul>	
Enclosure	Body material	Plastic (PBT/PC - polybutylene terephthalate/polycarbonate)
	Electrical connections/cable entries	<ul style="list-style-type: none"> <li>• 2 x M20 x 1.5 (one general purpose cable gland and one blocking plug provided)</li> <li>• 1 x 1/2" NPT</li> </ul>
	Ingress protection	<ul style="list-style-type: none"> <li>• IP66, TYPE 4X</li> <li>• IP68, TYPE 6</li> </ul>
Clear lid	Plastic (PBT/PC - polybutylene terephthalate/polycarbonate)	
Blind lid	Plastic (PC - polycarbonate)	
Weight	0.93 kg	
Installation torques	Cable gland to enclosure (Siemens supplied, metric)	10 Nm

### Note

#### Specific configuration requirements

Check the ambient and operating temperatures under Operating conditions (Page 52) and Process (Page 52); also check Approvals (Page 53) for the specific configuration you are about to use or install.

Use approved cable gland/conduit seal to maintain Type 4X, Type 6, IP66, IP68 ratings.

For dimensions of parts listed above, see **Dimension drawings** chapter in full operating instructions.

## 9.6 Operating conditions

Location	Indoor/outdoor	
Altitude	5000 m (16,404 ft) maximum	
Vibration resistance	0.5 g at frequencies from 10 Hz to 100 Hz	
Bump/shock resistance	25 g	
Ambient temperature	Storage	-40 to +85 °C
	Operating	-40 to +80 °C
Relative humidity	Suitable for outdoor (TYPE 4X, TYPE 6, IP66, IP68 enclosure)	
Installation category	I	
Pollution degree	4	
EMC performance	Emission	EN 55011/CISPR-11
	Immunity	EN/IEC 61326-1 (Industry)

## 9.7 Process

Temperature (at flange or threads)	-40 to +85 °C (-40 to +185 °F)
Pressure (vessel)	0.5 bar g/7.25 psi g

## 9.8 Communication

Communication type	<ul style="list-style-type: none"> <li>• HART</li> <li>• 4 to 20 mA</li> </ul>
Supported engineering systems	<ul style="list-style-type: none"> <li>• SIMATIC PDM</li> <li>• AMS Device Manager</li> <li>• FC375/FC475</li> <li>• FDT (such as Pactware, or Fieldcare)</li> <li>• SITRANS library for use with PCS-7</li> </ul>

## 9.9 Approvals

General	FM/C <sub>CSA</sub> <sub>US</sub> , CE, RCM		
Hazardous	Intrinsic safety	Europe	ATEX II 1 GD, Ex ia IIC T4 Ga
		International	IECEX SIR 18.0013X, Ex ia IIC T4 Ga
		US/Canada	FM/CSA Class I, Div.1, Groups A, B, C, D Class II, Div.1, Groups E, F, G Class III T4
		Brazil	INMETRO Ex ia IIC T4 Ga
		China	NEPSI Ex ia IIC T4 Ga
		South Africa	SABS Ex ia IIC Tx Ga
	Non-incendive	US	FM Class I, Div. 2, Groups A, B, C, D Tx



## HART communication

This device supports HART communication protocol.

SITRANS Probe LU240 can be configured over the HART network using the HART Communicator 375/475 by Emerson, or a software package. The recommended software package is the SIMATIC Process Device Manager (PDM) by Siemens.

---

### Note

#### Supported HART parameters

For a list of applicable parameters, see the full operating instructions.

---

### SIMATIC PDM

This software package is designed to permit easy configuration, monitoring, and troubleshooting of HART devices. The HART EDD for SITRANS Probe LU240 was written with SIMATIC PDM in mind and has been extensively tested with this software.

### HART Electronic Device Description (EDD)

In order to configure a HART device, the configuration software requires the HART Electronic Device Description specific to the device. Download the HART EDD for SITRANS Probe LU240 from the product page of our website:

- Product page ([www.siemens.com/sitransprobelu240](http://www.siemens.com/sitransprobelu240))

Click **Support > Software Downloads**. Older versions of the library will have to be updated in order to use all the features of SITRANS Probe LU240.





## Certificates and support

### 11.1 Certificates

You can find certificates on the Internet at Certificates (<http://www.siemens.com/processinstrumentation/certificates>) or on an included DVD.

### 11.2 Technical support

#### Technical Support

If this documentation does not provide complete answers to any technical questions you may have, contact Technical Support at:

- Support request (<http://www.siemens.com/automation/support-request>)
- More information about our Technical Support is available at Technical Support (<http://www.siemens.com/automation/csi/service>)

#### Internet Service & Support

In addition to our documentation, Siemens provides a comprehensive support solution at:

- Services & Support (<http://www.siemens.com/automation/service&support>)

#### Personal contact

If you have additional questions about the device, please contact your Siemens personal contact at:

- Partner (<http://www.automation.siemens.com/partner>)

To find the personal contact for your product, go to "All Products and Branches" and select "Products & Services > Industrial Automation > Process Instrumentation".

#### Documentation

You can find documentation on various products and systems at:

- Instructions and manuals (<http://www.siemens.com/processinstrumentation/documentation>)

## **11.3 QR code label**

A QR code label can be found on the device. With the use of a smart phone, the QR code provides a direct link to a website with information specific to the device, such as manuals, FAQs, certificates, etc.

# Index

## A

Approvals, 26  
specifications, 53

## C

Certificates, 11, 57  
Cleaning, 43  
Communication protocol  
HART electronic device description, 55  
Compact Operating Instructions, 57  
conduits  
requirements, 23  
Configuration  
HART modem, 15  
Customer Support, (Refer to Technical Support)

## D

Disassembly, 22  
Disposal, 46, 47  
Documentation, 57

## F

Firmware revision, 29

## H

HART communication foundation  
downloading the electronic device description  
(EDD), 55  
HART modem  
system configuration, 15  
Hazardous area  
Laws and directives, 11  
Qualified personnel, 13  
hazardous area installations device nameplate, 26  
HMI  
activating, 29  
operating the display, 29  
Hotline, (Refer to Support request)

## I

Instructions and manuals, 57

## M

Maintenance, 43  
Manuals, 57  
Modifications  
correct usage, 12  
improper, 12

## O

Operating conditions, 52  
Operating Instructions, 57  
Output  
specifications, 51

## P

Performance  
specifications, 50  
Power  
source requirements, 23  
specification, 49

## Q

QR code label, 58  
Qualified personnel, 13

## R

Reference conditions, 50  
Return procedure, 46

## S

Scope of delivery, 8  
Sensor reference point, 37  
Service, 57  
Service & Support, 57  
Internet, 57

SIMATIC PDM  
    with HART devices, 55  
Support, 57  
Support request, 57

## **T**

Technical data, 49  
Technical Support, 57  
    Partner,  
    Personal contact, 57  
Test certificates, 11

## **W**

Warranty, 9