

Extractive continuous process gas analysis

Series 6

ULTRAMAT 6

General information

1

Overview



The ULTRAMAT 6 single-channel or dual-channel gas analyzers operate according to the NDIR two-beam alternating light principle and measure gases highly selectively whose absorption bands lie in the infrared wavelength range from 2 to 9 μm , such as CO, CO₂, NO, SO₂, NH₃, H₂O as well as CH₄ and other hydrocarbons.

Single-channel analyzers can simultaneously measure up to 2 gas components, while dual-channel analyzers can simultaneously measure 3 (or 4 on request) gas components.

Benefits

High selectivity with double-layer detector and optical coupler

- Reliable measurements even in complex gas mixtures

Low detection limits

- Measurements with low concentrations

Corrosion-resistant materials in gas path (option)

- Measurement possible in highly corrosive sample gases

Analyzer cells can be cleaned as required on site

- Cost savings due to reuse after contamination

Electronics and physics: gas-tight isolation, purging is possible, IP65

- Long service life even in harsh environments

Heated versions (option)

- Use also in presence of gases condensing at low temperature

Ex(p) for Zones 1 and 2 (in accordance with to ATEX 2G and ATEX 3G)

Application

Fields of application

- Measurement for boiler control in incineration plants
- Emission measurements in incineration plants
- Measurement in the automotive industry (test benches)
- Warning equipment
- Process gas concentrations in chemical plants
- Trace measurements in pure gas processes
- Environmental protection
- TLV (Threshold Limit Value) monitoring at the workplace
- Quality monitoring
- Ex versions for analyzing flammable and non-flammable gases or vapors for use in hazardous areas

Special versions

Special applications

Besides the standard combinations, special applications concerning material in the gas path, material in the sample chambers (e.g. Titan, Hastelloy C22) and measured components are also available on request

Performance-tested version / QAL

For measurements of CO, NO, SO₂ and O₂ according to 13th and 27th BImSchV and TA Luft, performance-tested versions according to EN 15267 are available.

Certified measuring ranges:

- 1-component analyzer
 - CO: 0 to 75 mg/m³; 0 to 10 000 mg/m³
 - NO: 0 to 100 mg/m³; 0 to 10 000 mg/m³
 - SO₂: 0 to 75 mg/m³; 0 to 1 500 mg/m³
- O₂: 0 to 5 vol.%; 0 to 25 vol.%

In addition, performance-tested versions of the ULTRAMAT 6 meet the requirements set forth in EN 14956 and QAL 1 according to EN 14181. The conformity of devices with both standards is accelerated by the TÜV.

The determination of the device drift according to EN 14181 (QAL 3) can be done manually as well as with the SIPROM GA maintenance and service software on the PLC. In addition, selected manufacturers of emission evaluation computers offer the possibility for downloading the drift data via the analyzer's serial interface and to automatically record and process it in the evaluation computer.

Flow-type reference compartment

- The flow through the reference compartment should be adapted to the sample gas flow
- The gas supply of the reduced flow-type reference compartment should have an upstream pressure of 3 000 to 5 000 hPa (abs.). The flow is then automatically regulated at approximately 8 ml/min using a restrictor.

Design

19" rack unit

- 19" rack unit with 4 HU for installation
 - In hinged frame
 - In cabinets with or without telescope rails
- Front plate can be swiveled downwards for service purposes (laptop connection)
- Internal gas paths: hose made of FKM (Viton) or pipe made of titanium or stainless steel
- Gas connections for sample gas inlet and outlet: pipe diameter 6 mm or 1/4"
- Flow indicator for sample gas on front plate (option)
- Pressure switch in sample gas path for flow monitoring (option)

Field device

- Two-door enclosure with gas-tight separation of analyzer and electronics sections from gas path
- Individually purgeable enclosure halves
- Parts in contact with sample gas can be heated up to 65 °C (option)
- Gas path: hose made of FKM (Viton) or pipe made of titanium or stainless steel (further materials possible as special applications)
- Gas connections for sample gas inlet and outlet: pipe union for pipe diameter 6 mm or 1/4"
- Purging gas connections: pipe diameter 10 mm or 3/8"

Display and control panel

- Large LCD panel for simultaneous display of:
 - Measured value (digital and analog displays)
 - Status bar
 - Measuring ranges
- Contrast of the LCD field adjustable via the menu
- Washable membrane keyboard with five softkeys
- Menu-driven operation for parameterization, test functions, adjustment
- Operator support in plain text
- Graphic display of concentration trend; programmable time intervals
- Bilingual operating software: German/English, English/Spanish, French/English, Spanish/English, Italian/English

Inputs and outputs

- One analog output per medium (from 0, 2, 4 to 20 mA; NAMUR configurable)
- Two analog inputs freely configurable (e.g. correction of cross-interferences or external pressure sensor)
- Six digital inputs freely configurable (e.g. for measurement range switchover, processing of external signals from sample preparation)
- Six relay outputs freely configurable e.g. for fault, maintenance request, limit alarm, external solenoid valves)
- Expansion by eight additional digital inputs and eight additional relay outputs e.g. for autocalibration with up to four calibration gases

Communication

RS 485 present in the basic unit (connection at the rear; for the rack unit also behind the front plate).

Options

- AK interface for the automotive industry with extended functions
- RS 485/RS 232 converter
- RS 485/Ethernet converter
- RS 485/USB converter
- Connection to networks via PROFIBUS DP/PA interface
- SIPROM GA software as the service and maintenance tool

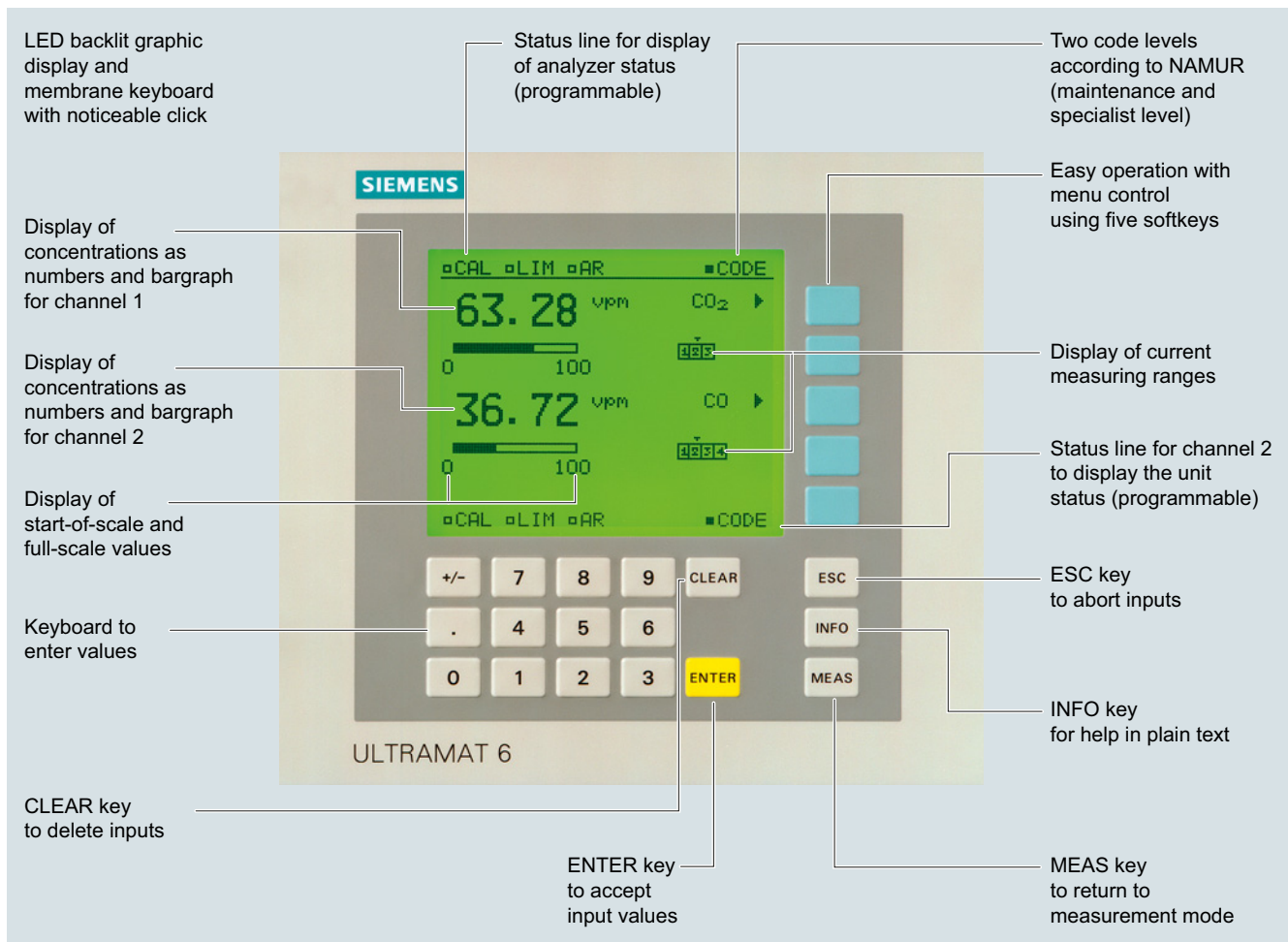

ULTRAMAT 6, membrane keyboard and graphic display

Extractive continuous process gas analysis

Series 6

ULTRAMAT 6

1

General information

Designs – Parts wetted by sample gas, standard

Gas path		19" rack unit	Field device	Field device Ex
With hoses	Bushing		Stainless steel, mat. no. 1.4571	-
	Hose		FKM (e.g. Viton)	
	Sample chamber:			
	• Body		Aluminum	
	• Lining		Aluminum	
• Fitting		Stainless steel, mat. no. 1.4571, O-ring: FKM (e.g. Viton) or FFKM (Kalrez)		
• Window		CaF ₂ , adhesive: E353, O-ring: FKM (e.g. Viton) or FFKM (Kalrez)		
With pipes	Bushing		Titanium	
	Pipe		Titanium, O-ring: FKM (e.g. Viton) or FFKM (Kalrez)	
	Sample chamber:			
	• Body		Aluminum	
	• Lining		Tantalum (only for cell length 20 mm to 180 mm)	
• Window		CaF ₂ , adhesive: E353, O-ring: FKM (e.g. Viton) or FFKM (Kalrez)		
With pipes	Bushing		Stainless steel, mat. no. 1.4571	
	Pipe		Stainless steel, mat. no. 1.4571, O-ring: FKM (e.g. Viton) or FFKM (Kalrez)	
	Sample chamber:			
	• Body		Aluminum	
	• Lining		Aluminum or tantalum (tantalum only for cell length 20 mm to 180 mm)	
• Window		CaF ₂ , adhesive: E353, O-ring: FKM (e.g. Viton) or FFKM (Kalrez)		

Options

Gas path		19" rack unit	Field device	Field device Ex
Flow indicator	Measurement pipe		Duran glass	-
	Variable area		Duran glass	
	Suspension boundary		PTFE (Teflon)	
	Angle pieces		FKM (e.g. Viton)	
Pressure switch	Membrane		FKM (e.g. Viton)	-
	Enclosure		PA 6.3T	

Versions – Parts wetted by sample gas, special applications (examples)

Gas path		19" rack unit	Field device	Field device Ex
With pipes	Bushing		e.g. Hastelloy C22	
	Pipe		e.g. Hastelloy C22, O-ring: FKM (e.g. Viton) or FFKM (Kalrez)	
	Sample chamber:			
	• Body		e.g. Hastelloy C22	
	• Window		CaF ₂ , without adhesive O-ring: FKM (e.g. Viton) or FFKM (Kalrez)	

Gas path (19" rack unit)**Legend for the gas path figures**

1	Sample gas inlet channel 1	8	Restrictor
2	Sample gas outlet channel 1	9	Purge gas inlet
3	Reference gas outlet (option)	10	Connection of atmospheric pressure sensor
4	Reference gas inlet (option)	11	Atmospheric pressure sensor
5	Sample gas inlet channel 2	12	Flow indicator in sample gas path (option)
6	Sample gas outlet channel 2	13	Pressure switch in sample gas path (option)
7	IR physical system		

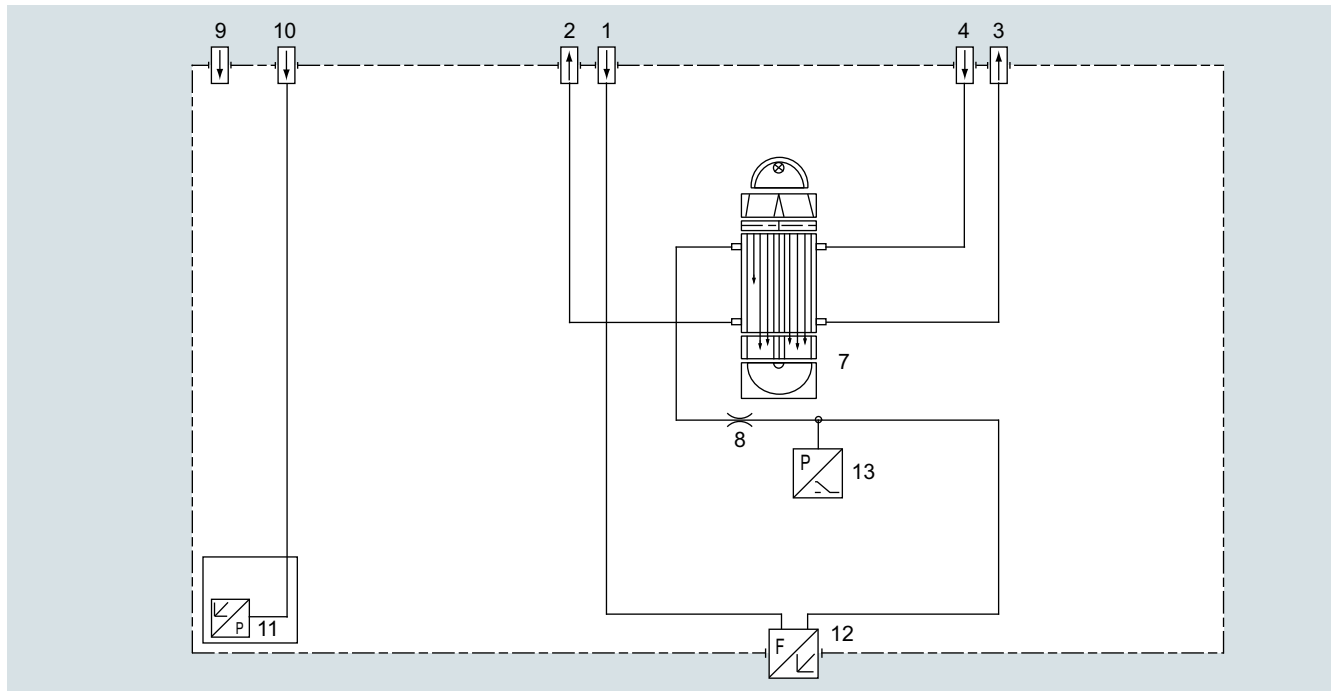

Gas path ULTRAMAT 6, single-channel unit, 19" unit, with flow-type reference cell (option)

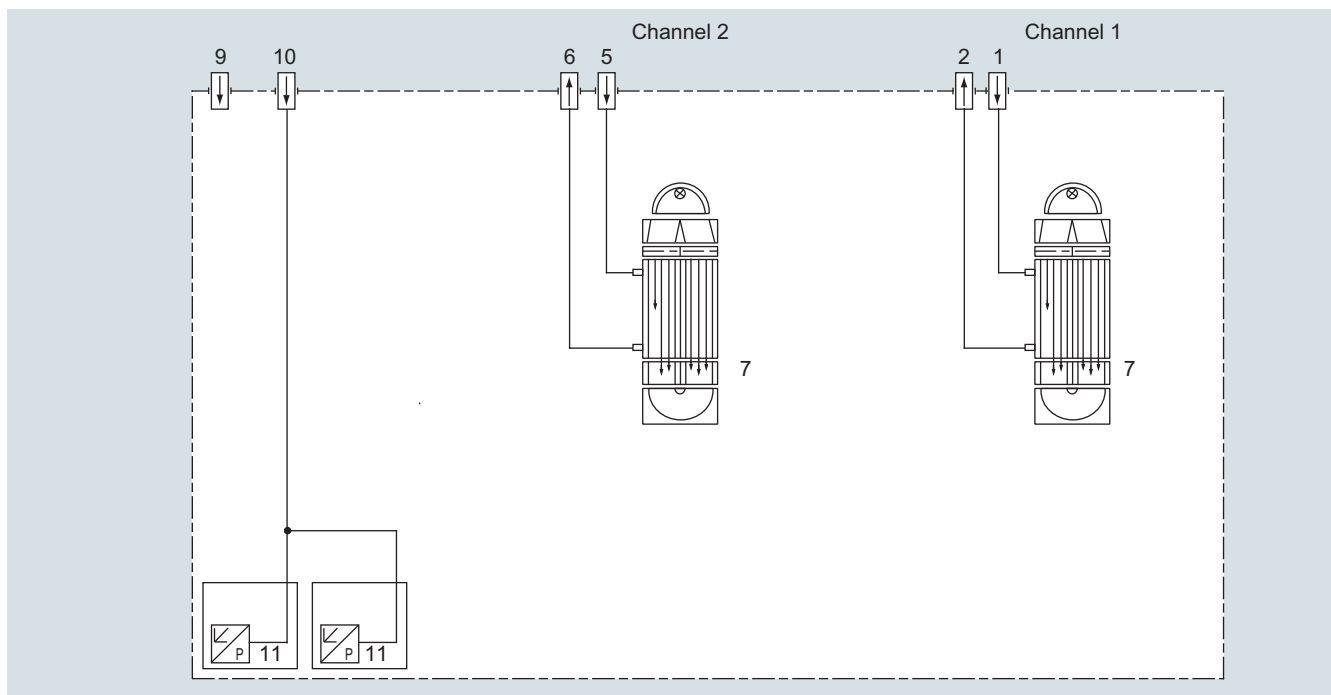

Gas path ULTRAMAT 6, dual-channel unit, 19" unit

Extractive continuous process gas analysis

Series 6

ULTRAMAT 6

1

General information

Gas path (field device)

Legend for the gas path figures

1	Sample gas inlet	7	Purging gas outlet (analyzer side)
2	Sample gas outlet	8	Purging gas inlet (analyzer side)
3	Reference gas inlet (option)	9	Connection of atmospheric pressure sensor
4	Reference gas outlet (option)	10	IR physical system
5	Purging gas inlet (electronics side)	11	Atmospheric pressure sensor
6	Purging gas outlet (electronics side)		

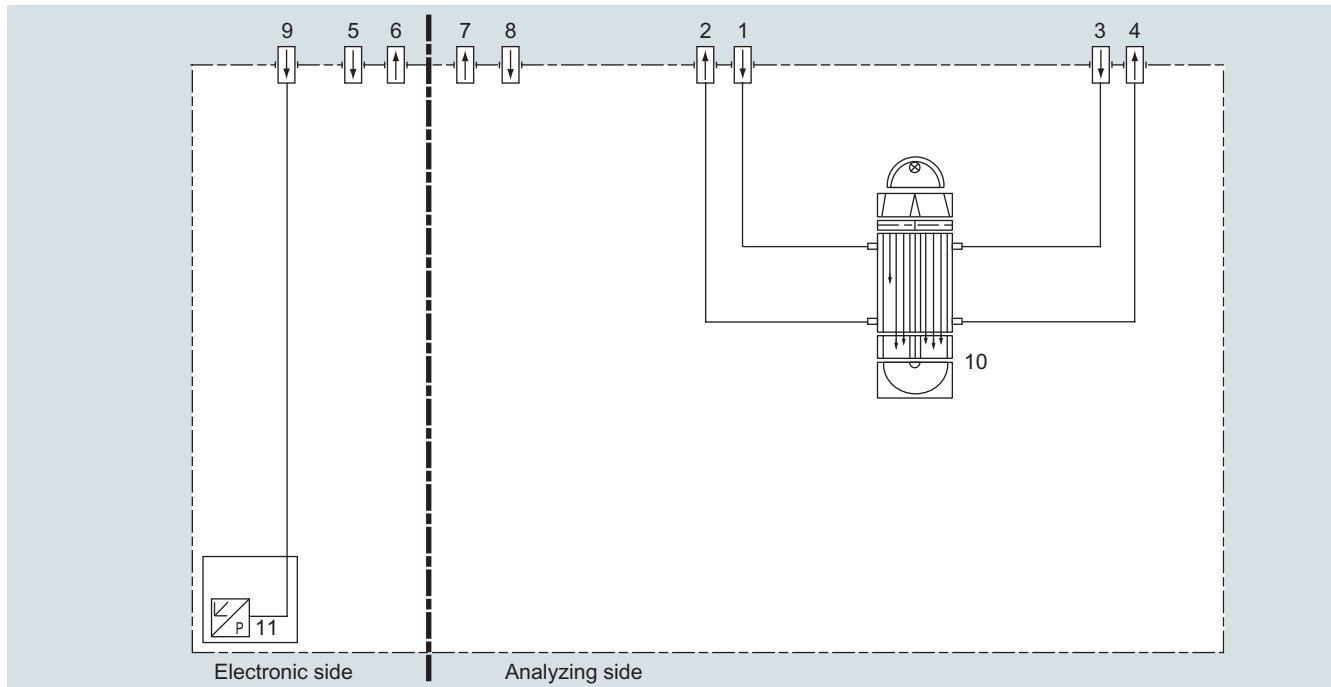

Gas path ULTRAMAT 6, field unit, with flow-type reference cell (option)

Function

Principle of operation

The ULTRAMAT 6 gas analyzer operates according to the infrared two-beam alternating light principle with double-layer detector and optical coupler.

The measuring principle is based on the molecule-specific absorption of bands of infrared radiation. The absorbed wavelengths are characteristic to the individual gases, but may partially overlap. This results in cross-sensitivities which are reduced to a minimum in the ULTRAMAT 6 gas analyzers by the following measures:

- Gas-filled filter cell (beam divider)
- Double-layer detector with optical coupler
- Optical filters if necessary

The figure shows the measuring principle. An IR source (1) which is heated to approx. 700 °C and which can be shifted to balance the system is divided by the beam divider (3) into two equal beams (sample and reference beams). The beam divider also acts as a filter cell.

The reference beam passes through a reference cell (8) filled with N₂ (a non-infrared-active gas) and reaches the right-hand side of the detector (11) practically unattenuated. The sample beam passes through the sample chamber (7) through which the sample gas flows and reaches the left-hand side of the detector (10) attenuated to a lesser or greater extent depending on the concentration of the sample gas. The detector is filled with a defined concentration of the gas component to be measured.

The detector is designed as a double-layer detector. The center of the absorption band is preferentially absorbed in the upper detector layer, the edges of the band are absorbed to approximately the same extent in the upper and lower layers. The upper and lower detector layers are connected together via the microflow sensor (12). This coupling means that the spectral sensitivity has a very narrow band.

The optical coupler (13) lengthens the lower receiver cell layer optically. The infrared absorption in the second detector layer is varied by changing the slider position (14). It is thus possible to individually minimize the influence of interfering components.

A chopper (5) rotates between the beam divider and the sample chamber and interrupts the two beams alternately and periodically. If absorption takes place in the sample chamber, a pulsating flow is generated between the two detector levels which is converted by the microflow sensor (12) into an electric signal.

The microflow sensor consists of two nickel-plated grids heated to approximately 120 °C, which, along with two supplementary resistors, form a Wheatstone bridge. The pulsating flow together with the dense arrangement of the Ni grids causes a change in resistance. This leads to an offset in the bridge, which is dependent on the concentration of the sample gas.

Notes

The sample gases must be fed into the analyzers free of dust. Condensation should be prevented from occurring in the sample chambers. Therefore, the use of gas modified for the measuring task is necessary in most application cases.

As far as possible, the ambient air of the analyzer should not have a large concentration of the gas components to be measured.

Flow-type reference sides with reduced flow must not be operated with flammable or toxic gases.

Flow-type reference sides with reduced flow and an O₂ content > 70% may only be used together with Y02 (Clean for O₂).

Channels with electronically suppressed zero point only differ from the standard version in the measuring range parameterization.

Physically suppressed zeros can be provided as a special application.

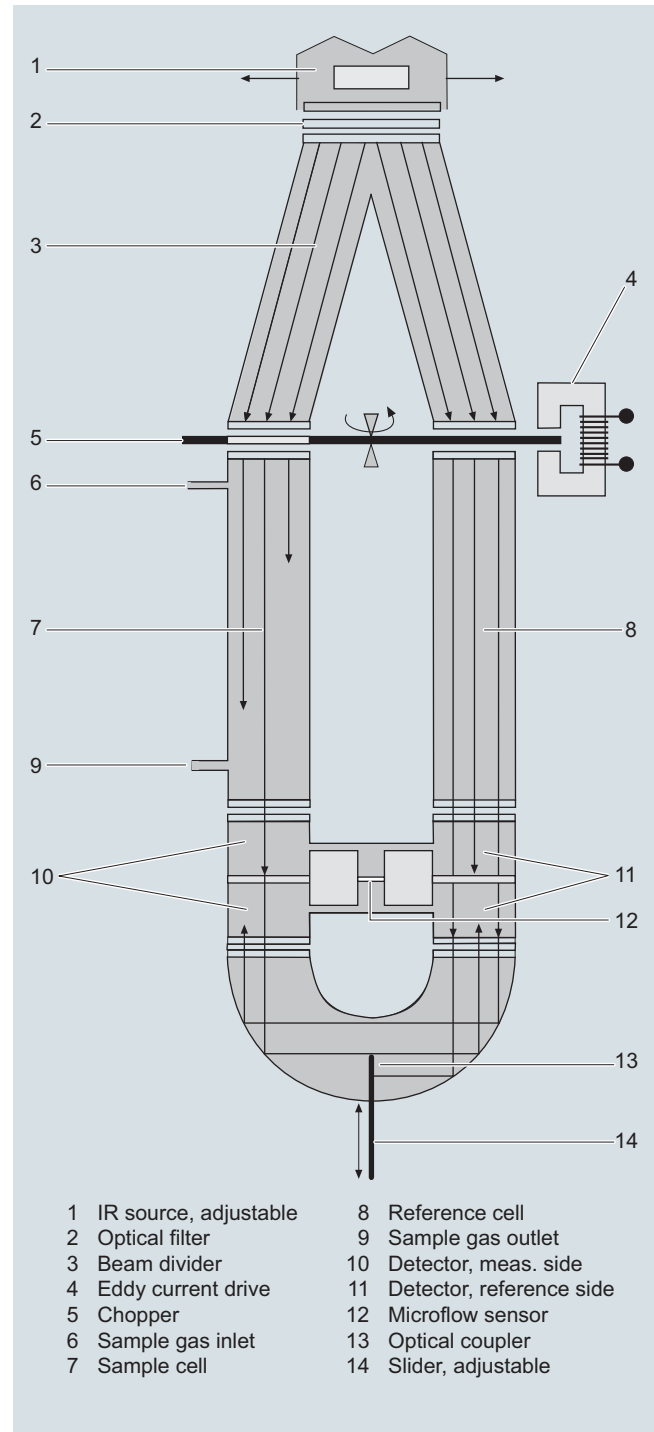

ULTRAMAT 6, principle of operation

Extractive continuous process gas analysis

Series 6

ULTRAMAT 6

1

General information

Essential characteristics

- Dimension of measured value freely selectable (e.g. vpm, mg/m³)
- Four freely-configurable measuring ranges per component
- Measuring ranges with suppressed zero point possible
- Measuring range identification
- Galvanically isolated signal output 0/2/4 to 20 mA per component
- Automatic or manual measuring range switchover selectable; remote switching is also possible
- Differential measuring ranges with flow-type reference cell
- Storage of measured values possible during adjustments
- Time constants selectable within wide limits (static/dynamic noise suppression); i.e. the response time of the analyzer or component can be matched to the respective measuring task
- Short response time
- Low long-term drift
- Measuring point switchover for up to 6 measuring points (programmable)
- Measuring point identification
- Monitoring of sample gas flow (option)
- Internal pressure sensor for correction of variations in atmospheric pressure in the range 700 to 1 200 hPa absolute
- External pressure sensor can be connected for correction of variations in the process gas pressure in the range 700 to 1 500 hPa absolute (option)
- Two control levels with separate authorization codes to prevent unintentional and unauthorized inputs
- Automatic, configurable measuring range calibration
- Simple handling using a numerical membrane keyboard and operator prompting
- Operation based on NAMUR recommendation
- Customer-specific analyzer options such as:
 - Customer acceptance
 - TAG labels
 - Clean for O₂ service (specially cleaned gas path)
- Easy device replacement since electric connections can be simply disconnected from the device
- Sample chambers for use in presence of highly corrosive sample gases, e.g. tantalum layer or sample chamber made of Hastelloy C22 (special application)

Additional features, dual-channel version

- Separate design of physical unit, electronics, inputs/outputs and power supply for each channel
- Display and operation via common LCD panel and keyboard
- Measurement channels 1 and 2 can be converted to series connection (linking of gas connections from channel 1 to channel 2 on rear)

Technical specifications

General information		Measuring response	
Measuring ranges	4, internally and externally switchable; autoranging is also possible	Output signal fluctuation	Based on sample gas pressure 1 013 hPa absolute, 0.5 l/min sample gas flow and 25 °C ambient temperature < ± 1% of the smallest possible measuring range according to rating plate
Smallest possible measuring range	Dependent on the application: e.g. CO: 0 ... 10 vpm, CO ₂ : 0 ... 5 vpm	Zero point drift	< ± 1% of the current measuring range/week
Largest possible measuring span	Dependent on the application	Measured-value drift	< ± 1% of the current measuring range/week
Measuring range with suppressed zero point	Any zero point within 0 ... 100 vol.% can be implemented; smallest possible span 20%	Repeatability	≤ 1% of the current measuring range
Operating position	Front wall, vertical	Detection limit	1% of the smallest possible measuring range
Conformity	CE mark in accordance with EN 50081-1, EN 50082-2	Linearity error	± 0.5 % of the full-scale value
Influence of interfering gases must be considered separately		Influencing variables	
Design, enclosure		Ambient temperature	Based on sample gas pressure 1 013 hPa absolute, 0.5 l/min sample gas flow and 25 °C ambient temperature < 1% of current measuring range/10 K (with constant receiver cell temperature)
Weight	Approx. 15 kg (with one IR channel) Approx. 21 kg (with two IR channels)	Sample gas pressure	• With disabled pressure compensation: < 0.15% of the span/1% change in atmospheric pressure • With disabled pressure compensation: < 1.5% of the span/1% change in atmospheric pressure
Degree of protection	IP20 according to EN 60529	Sample gas flow	Negligible
Electrical characteristics		Auxiliary power	< 0.1% of the current measuring range with rated voltage ± 10%
EMC (electromagnetic compatibility)	In accordance with standard requirements of NAMUR NE21 (08/98)	Environmental conditions	Application-specific measuring influences possible if ambient air contains measured components or cross interference-sensitive gases
Electrical safety	According to EN 61010-1, overvoltage category III	Electrical inputs and outputs	
Auxiliary power	100 ... 120 V AC (nominal range of use 90 ... 132 V), 48 ... 63 Hz or 200 ... 240 V AC (nominal range of use 180 ... 264 V), 48 ... 63 Hz	Analog output	0/2/4 ... 20 mA, isolated; load ≤ 750 Ω
Power consumption	1-channel unit: Approx. 40 VA 2-channel unit: Approx. 70 VA	Relay outputs	6, with changeover contacts, freely configurable, e.g. for measuring range identification; load: 24 V AC/DC/1 A, isolated, non-sparking
Fuse values		Analog inputs	2, dimensioned for 0/2/4 ... 20 mA for external pressure sensor and accompanying gas influence correction (correction of cross-interference)
• 100 ... 120 V	1 T/250 (7MB2121) 1.6 T/250 (7MB2123)	Digital inputs	6, designed for 24 V, isolated, freely configurable, e.g. for measuring range switchover
• 200 ... 240 V	0.63 T/250 (7MB2121) 1 T/250 (7MB2123)	Serial interface	RS 485
Gas inlet conditions		Options	AUTOCAL function each with 8 additional digital inputs and relay outputs, also with PROFIBUS PA or PROFIBUS DP
Permissible sample gas pressure		Climatic conditions	
• With hoses		Permissible ambient temperature	-30 ... +70 °C during storage and transportation, 5 ... 45 °C during operation
- Without pressure switch	600 ... 1 500 hPa (absolute)	Permissible humidity	< 90% RH (relative humidity) as annual average, during storage and transportation (dew point must not be under-shot)
- With pressure switch	700 ... 1 300 hPa (absolute)		
• With pipes (without pressure switch)	600 ... 1 500 hPa (absolute)		
Sample gas flow	18 ... 90 l/h (0.3 ... 1.5 l/min)		
Sample gas temperature	Min. 0 ... max. 50 °C, but above the dew point		
Sample gas humidity	< 90% RH (relative humidity), or dependent on measuring task, non-condensing		
Dynamic response			
Warm-up period	At room temperature < 30 min (the technical specification will be met after 2 hours)		
Delayed display (T ₉₀ -time)	Dependent on length of analyzer chamber, sample gas line and configurable damping		
Damping (electrical time constant)	0 ... 100 s, configurable		
Dead time (purging time of the gas path in the unit at 1 l/min)	Approximately 0.5 ... 5 s, depending on version		
Time for device-internal signal processing	< 1 s		
Pressure correction range			
Pressure sensor			
• Internal	700 ... 1 200 hPa absolute		
• External	700 ... 1 500 hPa absolute		

Extractive continuous process gas analysis

Series 6

ULTRAMAT 6

19" rack unit

1

Selection and ordering data

Article No.

ULTRAMAT 6 gas analyzer

Single-channel 19" rack unit for installation in cabinets

7MB2121- - - - - A A

Cannot be combined

➤ Click on the Article No. for the online configuration in the PIA Life Cycle Portal.

Gas connections for sample gas and reference gas

Pipe with 6 mm outer diameter

0

0 → A21

Pipe with 1/4" outer diameter

1

1 → A20

Measured component	Possible with measuring range identification	
CO	11 ... 30	A
CO highly selective (with optical filter) ²⁾	12 ... 30	B
CO ³⁾		X
CO ₂	10 ... 30	C
CH ₄	13 ... 30	D
C ₂ H ₂	15 ... 30	E
C ₂ H ₄	15 ... 30	F
C ₂ H ₆	14 ... 30	G
C ₃ H ₆	14 ... 30	H
C ₃ H ₈	13 ... 30	J
C ₄ H ₆	15 ... 30	K
C ₄ H ₁₀	14 ... 30	L
C ₆ H ₁₄	14 ... 30	M
SO ₂ ⁴⁾	13 ... 30	N
NO ⁴⁾	14 ... 20, 22	P
NH ₃ (dry)	14 ... 30	Q
H ₂ O	17 ... 20, 22	R
N ₂ O	13 ... 30	S

Q
R

Smallest measuring range	Largest measuring range	Measuring range identification
0 ... 5 vpm	0 ... 100 vpm	10
0 ... 10 vpm	0 ... 200 vpm	11
0 ... 20 vpm	0 ... 400 vpm	12
0 ... 50 vpm	0 ... 1 000 vpm	13
0 ... 100 vpm	0 ... 1 000 vpm	14
0 ... 300 vpm	0 ... 3 000 vpm	15
0 ... 500 vpm	0 ... 5 000 vpm	16
0 ... 1 000 vpm	0 ... 10 000 vpm	17
0 ... 3 000 vpm	0 ... 10 000 vpm	18
0 ... 3 000 vpm	0 ... 30 000 vpm	19
0 ... 5 000 vpm	0 ... 15 000 vpm	20
0 ... 5 000 vpm	0 ... 50 000 vpm	21
0 ... 1 %	0 ... 3 %	22
0 ... 1 %	0 ... 10 %	23
0 ... 3 %	0 ... 10 %	24
0 ... 3 %	0 ... 30 %	25
0 ... 5 %	0 ... 15 %	26
0 ... 5 %	0 ... 50 %	27
0 ... 10 %	0 ... 30 %	28
0 ... 10 %	0 ... 100 %	29
0 ... 30 %	0 ... 100 %	30

A
B
C
D
E
F
G
H
J
K
L
M
N
P
Q
R
S
W

Internal gas paths	Sample chamber ¹⁾ (lining)	Reference chamber (flow-type)	
Hose made of FKM (Viton)	Aluminum	Non-flow-type	0
	Aluminum	Flow-type	1
Pipe made of titanium	Tantalum	Non-flow-type	4
	Tantalum	Flow-type	5
Stainless steel pipe (mat. no. 1.4571)	Aluminum	Non-flow-type	6
	Tantalum	Non-flow-type	8

0 → A20, A21

1

4 → A20, A21, Y02

5 → Y02

6 → A20, A21

8 → A20, A21



With sample gas monitoring

Hose made of FKM (Viton)	Aluminum	Non-flow-type	2
	Aluminum	Flow-type	3

2 → A20, A21

3

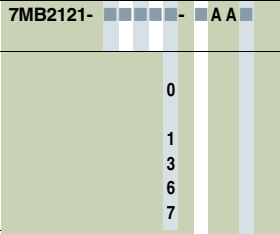
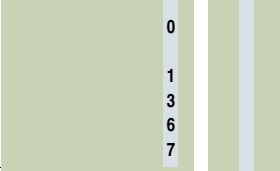
Footnotes: see next page

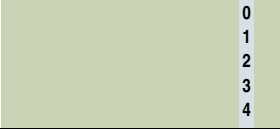
Selection and ordering data	Article No.
ULTRAMAT 6 gas analyzer Single-channel 19" rack unit for installation in cabinets	7MB2121-  - A A Cannot be combined
<u>Add-on electronics</u> Without AUTOCAL function • With 8 additional digital inputs/outputs • With serial interface for the automotive industry (AK) • With 8 digital inputs/outputs, PROFIBUS PA interface • With 8 digital inputs/outputs, PROFIBUS DP interface	 0 → Y27 1 3 → E20 6 7
<u>Power supply</u> 100 ... 120 V AC, 48 ... 63 Hz 200 ... 240 V AC, 48 ... 63 Hz	 0 1
<u>Operating software and documentation</u> German English French Spanish Italian	 0 1 2 3 4
Additional versions	Order code
Add "-Z" to Article No. and specify Order code	
Flow-type reference cell with reduced flow, 6 mm	A20
Flow-type reference cell with reduced flow, 1/4"	A21
Telescopic rails (2 units)	A31
TAG labels (specific lettering based on customer information)	B03
Kalrez gaskets in sample gas path	B04
SIL conformity declaration (SIL 2) Functional Safety according to IEC 61508 and IEC 61511	C20
FM/CSA certificate – Class I Div 2	E20
Clean for O ₂ service (specially cleaned gas path)	Y02
Measuring range indication in plain text, if different from the standard setting	Y11
Special setting (only in conjunction with an application no., e.g. extended measuring range)	Y12
Extended special setting (only in conjunction with an application no., e.g. determination of cross-interferences)	Y13
QAL1 according to SIRA/MCERTS	Y17
Performance-tested according to EN 15267	Y27
Accessories	Article No.
RS 485/Ethernet converter	A5E00852383
RS 485/RS 232 converter	C79451-Z1589-U1
RS 485/USB converter	A5E00852382
AUTOCAL function with serial interface for the automotive industry (AK)	C79451-A3480-D512
AUTOCAL function with 8 digital inputs/outputs	C79451-A3480-D511
AUTOCAL function with 8 digital inputs/outputs and PROFIBUS PA	A5E00057307
AUTOCAL function with 8 digital inputs/outputs and PROFIBUS DP	A5E00057312
Set of Torx screwdrivers	A5E34821625

1) Only for cell length 20 to 180 mm

2) QAL1: see table "Performance tested according to EN 15267 (single component)", page 1/54

3) QAL1: see table "Based on QAL1 according to SIRA/MCERTS (single component)", page 1/54

4) QAL1: See table "Based on QAL1 according to SIRA/MCERTS (single component) and performance-tested according to EN 15267 (single component)", page 1/54

Extractive continuous process gas analysis

Series 6

ULTRAMAT 6

19" rack unit

1

Selection and ordering data

Article No.

ULTRAMAT 6 gas analyzer

Two-channel 19" rack unit for installation in cabinets for measuring 2 IR components

7MB2123- - - - - Cannot be combined

Click on the Article No. in the online configuration in the PIA Life Cycle Portal.

Gas connections for sample gas and reference gas

Pipe with 6 mm outer diameter

Pipe with 1/4" outer diameter

0 → A21, A41
1 → A20, A40

Channel 1

Measured component	Possible with measuring range identification
CO	11 ... 30
CO highly selective (with optical filter) ²⁾	12 ... 30
CO ³⁾	
CO ₂	10 ... 30
CH ₄	13 ... 30
C ₂ H ₂	15 ... 30
C ₂ H ₄	15 ... 30
C ₂ H ₆	14 ... 30
C ₃ H ₆	14 ... 30
C ₃ H ₈	13 ... 30
C ₄ H ₆	15 ... 30
C ₄ H ₁₀	14 ... 30
C ₆ H ₁₄	14 ... 30
SO ₂ ⁴⁾	13 ... 30
NO ⁴⁾	14 ... 20, 22
NH ₃ (dry)	14 ... 30
H ₂ O	17 ... 20, 22
N ₂ O	13 ... 30

A
B
X
C
D
E
F
G
H
J
K
L
M
N
P
Q
R
S

Q
R

Smallest measuring range	Largest measuring range	Measuring range identification
--------------------------	-------------------------	--------------------------------

0 ... 5 vpm	0 ... 100 vpm	10
0 ... 10 vpm	0 ... 200 vpm	11
0 ... 20 vpm	0 ... 400 vpm	12
0 ... 50 vpm	0 ... 1 000 vpm	13
0 ... 100 vpm	0 ... 1 000 vpm	14
0 ... 300 vpm	0 ... 3 000 vpm	15
0 ... 500 vpm	0 ... 5 000 vpm	16
0 ... 1 000 vpm	0 ... 10 000 vpm	17
0 ... 3 000 vpm	0 ... 10 000 vpm	18
0 ... 3 000 vpm	0 ... 30 000 vpm	19
0 ... 5 000 vpm	0 ... 15 000 vpm	20
0 ... 5 000 vpm	0 ... 50 000 vpm	21
0 ... 1 %	0 ... 3 %	22
0 ... 1 %	0 ... 10 %	23
0 ... 3 %	0 ... 10 %	24
0 ... 3 %	0 ... 30 %	25
0 ... 5 %	0 ... 15 %	26
0 ... 5 %	0 ... 50 %	27
0 ... 10 %	0 ... 30 %	28
0 ... 10 %	0 ... 100 %	29
0 ... 30 %	0 ... 100 %	30

A
B
C
D
E
F
G
H
J
K
L
M
N
P
Q
R
S
T
U
V
W

Internal gas paths	Sample chamber ¹⁾ (lining)	Reference chamber (flow-type)
--------------------	---------------------------------------	-------------------------------

Hose made of FKM (Viton)	Aluminum	Non-flow-type	0
	Aluminum	Flow-type	1
Pipe made of titanium	Tantalum	Non-flow-type	4
	Tantalum	Flow-type	5
Stainless steel pipe (mat. no. 1.4571)	Aluminum	Non-flow-type	6
	Tantalum	Non-flow-type	8

0 → A20, A21, A40, A41
1
4 → A20, A21, A40, A41, Y02
5 → Y02
6 → A20, A21, A40, A41
8 → A20, A21, A40, A41

With sample gas monitoring

Hose made of FKM (Viton)	Aluminum	Non-flow-type	2
	Aluminum	Flow-type	3

2 → A20, A21, A40, A41
3

¹⁾ Only for cell length 20 to 180 mm

²⁾ QAL1: see table "Performance tested according to EN 15267 (single component)", page 1/54

³⁾ QAL1: see table "Based on QAL1 according to SIRA/MCERTS (single component)", page 1/54

⁴⁾ QAL1: See table "Based on QAL1 according to SIRA/MCERTS (single component) and performance-tested according to EN 15267 (single component)", page 1/54

Extractive continuous process gas analysis

Series 6
ULTRAMAT 6

19" rack unit

1

Selection and ordering data			Article No.	
ULTRAMAT 6 gas analyzer			7MB2123- - - - -	
Two-channel 19" rack unit for installation in cabinets for measuring 2 IR components			Cannot be combined	
<u>Add-on electronics</u>				
Without			0	
AUTOCAL function			1	
• With 8 additional digital inputs/outputs each for channel 1			2	
• With 8 additional digital inputs/outputs each for channel 2			3	
• With 8 additional digital inputs/outputs each for channel 1 and channel 2			5	
• With serial interface for the automotive industry (AK)			6	
• With 8 additional digital inputs/outputs each for channel 1 and channel 2 and PROFIBUS PA interface			7	
• With 8 additional digital inputs/outputs each for channel 1 and channel 2 and PROFIBUS DP interface				
<u>Power supply</u>				
100 ... 120 V AC, 48 ... 63 Hz			0	
200 ... 240 V AC, 48 ... 63 Hz			1	
<u>Channel 2</u>				
<u>Measured component</u>	<u>Possible with measuring range identification</u>			
CO	11 ... 30		A	
CO highly selective (with optical filter) ¹⁾	12 ... 30		B	
CO ²⁾			X	
CO ₂	10 ... 30		C	
CH ₄	13 ... 30		D	
C ₂ H ₂	15 ... 30		E	
C ₂ H ₄	15 ... 30		F	
C ₂ H ₆	14 ... 30		G	
C ₃ H ₆	14 ... 30		H	
C ₃ H ₈	13 ... 30		J	
C ₄ H ₆	15 ... 30		K	
C ₄ H ₁₀	14 ... 30		L	
C ₆ H ₁₄	14 ... 30		M	
SO ₂ ³⁾	13 ... 30		N	
NO ³⁾	14 ... 20, 22		P	
NH ₃ (dry)	14 ... 30		Q	
H ₂ O	17 ... 20, 22		R	
N ₂ O	13 ... 30		S	
<u>Smallest measuring range</u>	<u>Largest measuring range</u>	<u>Measuring range identification</u>		
0 ... 5 vpm	0 ... 100 vpm	10	A	
0 ... 10 vpm	0 ... 200 vpm	11	B	
0 ... 20 vpm	0 ... 400 vpm	12	C	
0 ... 50 vpm	0 ... 1 000 vpm	13	D	
0 ... 100 vpm	0 ... 1 000 vpm	14	E	
0 ... 300 vpm	0 ... 3 000 vpm	15	F	
0 ... 500 vpm	0 ... 5 000 vpm	16	G	
0 ... 1 000 vpm	0 ... 10 000 vpm	17	H	
0 ... 3 000 vpm	0 ... 10 000 vpm	18	J	
0 ... 3 000 vpm	0 ... 30 000 vpm	19	K	
0 ... 5 000 vpm	0 ... 15 000 vpm	20	L	
0 ... 5 000 vpm	0 ... 50 000 vpm	21	M	
0 ... 1 %	0 ... 3 %	22	N	
0 ... 1 %	0 ... 10 %	23	P	
0 ... 3 %	0 ... 10 %	24	Q	
0 ... 3 %	0 ... 30 %	25	R	
0 ... 5 %	0 ... 15 %	26	S	
0 ... 5 %	0 ... 50 %	27	T	
0 ... 10 %	0 ... 30 %	28	U	
0 ... 10 %	0 ... 100 %	29	V	
0 ... 30 %	0 ... 100 %	30	W	
<u>Operating software and documentation</u>				
German			0	
English			1	
French			2	
Spanish			3	
Italian			4	

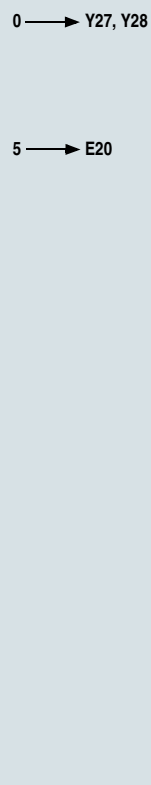

¹⁾ QAL1: see table "Performance tested according to EN 15267 (single component)", page 1/54
²⁾ QAL1: see table "Based on QAL1 according to SIRA/MCERTS (single component)", page 1/54
³⁾ QAL1: See table "Based on QAL1 according to SIRA/MCERTS (single component) and performance-tested according to EN 15267 (single component)", page 1/54

Extractive continuous process gas analysis

Series 6

ULTRAMAT 6

19" rack unit

1

Selection and ordering data

<i>Additional versions</i>	Order code	Cannot be combined
Add "-Z" to Article No. and specify Order codes.		
Flow-type reference cell with reduced flow, 6 mm (channel 1)	A20	
Flow-type reference cell with reduced flow, ¼" (channel 1)	A21	
Flow-type reference cell with reduced flow, 6 mm (channel 2)	A40	
Flow-type reference cell with reduced flow, ¼" (channel 2)	A41	
Connection pipe (can only be combined with the appropriate gas connection diameter and internal gas path materials)		
• Made of titanium, 6 mm, complete with screwed gland, for sample gas side	A22	
• Made of titanium, 6 mm, complete with screwed gland, for reference gas side	A23	
• Made of titanium, ¼", complete with screwed gland, for sample gas side	A24	
• Made of titanium, ¼", complete with screwed gland, for reference gas side	A25	
• Made of stainless steel (mat. no. 1.4571), 6 mm, complete with screwed gland, for sample gas side	A27	
• Made of stainless steel (mat. no. 1.4571), ¼", complete with screwed gland, for sample gas side	A29	
Telescopic rails (2 units)	A31	
TAG labels (specific lettering based on customer information)	B03	
Kalrez gaskets in sample gas path (channel 1)	B04	
Kalrez gaskets in sample gas path (channel 2)	B05	
SIL conformity declaration (SIL 2) Functional Safety according to IEC 61508 and IEC 61511	C20	
FM/CSA certificate – Class I Div 2	E20	
Clean for O ₂ service (specially cleaned gas path; channels 1 + 2)	Y02	
Measuring range indication in plain text, if different from the standard setting	Y11	
Special setting (only in conjunction with an application no., e.g. extended measuring range)	Y12	
Extended special setting (only in conjunction with an application no., e.g. determination of cross-interferences)	Y13	
QAL1 according to SIRI/MCERTS (1st channel)	Y17	
QAL1 according to SIRI/MCERTS (2nd channel)	Y18	
Performance-tested according to EN 15267 (1st channel)	Y27	
Performance-tested according to EN 15267 (2nd channel)	Y28	
Accessories	Article No.	
RS 485/Ethernet converter	A5E00852383	
RS 485/RS 232 converter	C79451-Z1589-U1	
RS 485/USB converter	A5E00852382	
AUTOCAL function with serial interface for the automotive industry (AK)	C79451-A3480-D33	
AUTOCAL function with 8 digital inputs/outputs for channel 1 or channel 2	C79451-A3480-D511	
AUTOCAL function with 8 digital inputs/outputs and PROFIBUS PA for channel 1 or channel 2	A5E00057307	
AUTOCAL function with 8 digital inputs/outputs and PROFIBUS DP for channel 1 or channel 2	A5E00057312	
Set of Torx screwdrivers	A5E34821625	

Selection and ordering data			Article No.	
ULTRAMAT 6 gas analyzer			7MB2124-	
Single-channel or dual-channel 19" rack unit for installation in cabinets for measuring 2 or 3 IR components			Cannot be combined	
Click on the Article No. for the online configuration in the PIA Life Cycle Portal.				
<u>Gas connections for sample gas and reference gas</u>				
Pipe with 6 mm outer diameter			0	0 → A21, A41
Pipe with 1/4" outer diameter			1	1 → A20, A40
<u>Measured component</u>	<u>Smallest measuring range</u>	<u>Largest measuring range</u>		
CO	0 ... 100 vpm	0 ... 1 000 vpm	AA	
NO	0 ... 100 vpm	0 ... 1 000 vpm		
CO	0 ... 300 vpm	0 ... 3 000 vpm	AB	
NO	0 ... 300 vpm	0 ... 3 000 vpm		
CO	0 ... 1 000 vpm	0 ... 10 000 vpm	AC	
NO	0 ... 1 000 vpm	0 ... 10 000 vpm		
For CO/NO (QAL1; see table "Based on QAL1 according to SIRA/MCERTS (2 components in series)", page 1/54)				
CO ₂	0 ... 100 vpm	0 ... 1 000 vpm	BA	
CO	0 ... 100 vpm	0 ... 1 000 vpm		
CO ₂	0 ... 300 vpm	0 ... 3 000 vpm	BB	
CO	0 ... 300 vpm	0 ... 3 000 vpm		
CO ₂	0 ... 1 000 vpm	0 ... 10 000 vpm	BC	
CO	0 ... 1 000 vpm	0 ... 10 000 vpm		
CO ₂	0 ... 3 000 vpm	0 ... 30 000 vpm	BD	
CO	0 ... 3 000 vpm	0 ... 30 000 vpm		
CO ₂	0 ... 1 %	0 ... 10 %	BE	
CO	0 ... 1 %	0 ... 10 %		
CO ₂	0 ... 3 %	0 ... 30 %	BF	
CO	0 ... 3 %	0 ... 30 %		
CO ₂	0 ... 10 %	0 ... 100 %	BG	
CO	0 ... 10 %	0 ... 100 %		
CO ₂	0 ... 10 %	0 ... 100 %	CG	
CH ₄	0 ... 10 %	0 ... 100 %		
CO ₂	0 ... 300 vpm	0 ... 3 000 vpm	DB	
NO	0 ... 300 vpm	0 ... 3 000 vpm		
<u>Internal gas paths</u>	<u>Sample chamber¹⁾ (lining)</u>	<u>Reference chamber (flow-type)</u>		
Hose made of FKM (Viton)	Aluminum	Non-flow-type	0	0 → A20, A21, A40, A41
	Aluminum	Flow-type	1	
Pipe made of titanium	Tantalum	Non-flow-type	4	4 → A20, A21, A40, A41, Y02
	Tantalum	Flow-type	5	
Stainless steel pipe (mat. no. 1.4571)	Aluminum	Non-flow-type	6	5 → Y02
	Tantalum	Non-flow-type	8	
				6 → A20, A21, A40, A41
				8 → A20, A21, A40, A41
<u>With sample gas monitoring</u>				
Hose made of FKM (Viton)	Aluminum	Non-flow-type	2	2 → A20, A21, A40, A41
	Aluminum	Flow-type	3	
<u>Add-on electronics</u>				
Without				
AUTOCAL function				
• With 8 additional digital inputs/outputs each for channel 1				
• With 8 additional digital inputs/outputs each for channel 1 and channel 2				
• With serial interface for the automotive industry (AK), channel 1				
• With serial interface for the automotive industry (AK), channel 1 and channel 2				
• With 8 additional digital inputs/outputs for channel 1 and PROFIBUS PA interface				
• With 8 additional digital inputs/outputs each for channel 1 and channel 2 and PROFIBUS PA interface				
• With 8 additional digital inputs/outputs for channel 1 and PROFIBUS DP interface				
• With 8 additional digital inputs/outputs each for channel 1 and channel 2 and PROFIBUS DP interface				
1) Only for cell length 20 to 180 mm				

Extractive continuous process gas analysis

Series 6

ULTRAMAT 6

19" rack unit

1

Selection and ordering data

Article No.

ULTRAMAT 6 gas analyzer

7MB2124-

Cannot be combined

Single-channel or dual-channel 19" rack unit for installation in cabinets for measuring 2 or 3 IR components

Power supply

100 ... 120 V AC, 48 ... 63 Hz
200 ... 240 V AC, 48 ... 63 Hz

Channel 2

Measured component

Possible with measuring range identification

Without channel 2

CO	11 ... 30
CO highly selective (with optical filter)	12 ... 30
CO (QAL1; see table "Based on QAL1 according to SIRA/MCERTS (single component)", page 1/54)	
CO ₂	10 ... 30
CH ₄	13 ... 30
C ₂ H ₂	15 ... 30
C ₂ H ₄	15 ... 30
C ₂ H ₆	14 ... 30
C ₃ H ₆	14 ... 30
C ₃ H ₈	13 ... 30
C ₄ H ₆	15 ... 30
C ₄ H ₁₀	14 ... 30
C ₆ H ₁₄	14 ... 30
SO ₂ (QAL1; see table "Based on QAL1 according to SIRA/MCERTS (single component)", page 1/54)	13 ... 30
NO (QAL1; see table "Based on QAL1 according to SIRA/MCERTS (single component)", page 1/54)	14 ... 20, 22
NH ₃ (dry)	14 ... 30
H ₂ O	17 ... 20, 22
N ₂ O	13 ... 30

Smallest measuring range

Largest measuring range

Measuring range identification

Without channel 2

0 ... 5 vpm	0 ... 100 vpm	10
0 ... 10 vpm	0 ... 200 vpm	11
0 ... 20 vpm	0 ... 400 vpm	12
0 ... 50 vpm	0 ... 1 000 vpm	13
0 ... 100 vpm	0 ... 1 000 vpm	14
0 ... 300 vpm	0 ... 3 000 vpm	15
0 ... 500 vpm	0 ... 5 000 vpm	16
0 ... 1 000 vpm	0 ... 10 000 vpm	17
0 ... 3 000 vpm	0 ... 10 000 vpm	18
0 ... 3 000 vpm	0 ... 30 000 vpm	19
0 ... 5 000 vpm	0 ... 15 000 vpm	20
0 ... 5 000 vpm	0 ... 50 000 vpm	21
0 ... 1 %	0 ... 3 %	22
0 ... 1 %	0 ... 10 %	23
0 ... 3 %	0 ... 10 %	24
0 ... 3 %	0 ... 30 %	25
0 ... 5 %	0 ... 15 %	26
0 ... 5 %	0 ... 50 %	27
0 ... 10 %	0 ... 30 %	28
0 ... 10 %	0 ... 100 %	29
0 ... 30 %	0 ... 100 %	30

Operating software and documentation

German
English
French
Spanish
Italian

0
1

W
A
B
X
C
D
E
F
G
H
J
K
L
M
N
P
Q
R
S

W

Q
R

X
A
B
C
D
E
F
G
H
J
K
L
M
N
P
Q
R
S
T
U
V
W

X → A40, A41, B05

0
1
2
3
4

Selection and ordering data

<i>Additional versions</i>	Order code	Cannot be combined
Add "-Z" to Article No. and specify Order codes.		
Flow-type reference cell with reduced flow, 6 mm (channel 1)	A20	
Flow-type reference cell with reduced flow, 1/4" (channel 1)	A21	
Flow-type reference cell with reduced flow, 6 mm (channel 2)	A40	
Flow-type reference cell with reduced flow, 1/4" (channel 2)	A41	
Connection pipe (can only be combined with the appropriate gas connection diameter and internal gas path materials)		
• Made of titanium, 6 mm, complete with screwed gland, for sample gas side	A22	
• Made of titanium, 6 mm, complete with screwed gland, for reference gas side	A23	
• Made of titanium, 1/4", complete with screwed gland, for sample gas side	A24	
• Made of titanium, 1/4", complete with screwed gland, for reference gas side	A25	
• Made of stainless steel (mat. no. 1.4571), 6 mm, complete with screwed gland, for sample gas side	A27	
• Made of stainless steel (mat. no. 1.4571), 1/4", complete with screwed gland, for sample gas side	A29	
Telescopic rails (2 units)	A31	
TAG labels (specific lettering based on customer information)	B03	
Kalrez gaskets in sample gas path (channel 1)	B04	
Kalrez gaskets in sample gas path (channel 2)	B05	
SIL conformity declaration (SIL 2) Functional Safety according to IEC 61508 and IEC 61511	C20	
FM/CSA certificate – Class I Div 2	E20	
Clean for O ₂ service (specially cleaned gas path; channels 1 + 2)	Y02	
Measuring range indication in plain text, if different from the standard setting	Y11	
Special setting (only in conjunction with an application no., e.g. extended measuring range)	Y12	
Extended special setting (only in conjunction with an application no., e.g. determination of cross-interferences)	Y13	
QAL1 according to SIRA/MCERTS (1st channel)	Y17	
QAL1 according to SIRA/MCERTS (2nd channel)	Y18	
<i>Accessories</i>	Article No.	
RS 485/Ethernet converter	A5E00852383	
RS 485/RS 232 converter	C79451-Z1589-U1	
RS 485/USB converter	A5E00852382	
AUTOCAL function with serial interface for the automotive industry (AK)	C79451-A3480-D33	
AUTOCAL function with 8 digital inputs/outputs for channel 1 or channel 2	C79451-A3480-D511	
AUTOCAL function with 8 digital inputs/outputs and PROFIBUS PA for channel 1 or channel 2	A5E00057307	
AUTOCAL function with 8 digital inputs/outputs and PROFIBUS DP for channel 1 or channel 2	A5E00057312	
Set of Torx screwdrivers	A5E34821625	

Extractive continuous process gas analysis

Series 6

ULTRAMAT 6

19" rack unit

Based on QAL1 according to SIRAMCERTS (single component)

Only in conjunction with order code Y17/Y18

Component Measuring range identification	CO (QAL1)		SO ₂ (QAL1)		NO (QAL1)	
	Smallest measuring range from 0 to ...	Largest measuring range from 0 to ...	Smallest measuring range from 0 to ...	Largest measuring range from 0 to ...	Smallest measuring range from 0 to ...	Largest measuring range from 0 to ...
C			75 mg/m ³	1 500 mg/m ³		
D	50 mg/m ³	1 000 mg/m ³	300 mg/m ³	3 000 mg/m ³		
E			500 mg/m ³	5 000 mg/m ³	100 mg/m ³	2 000 mg/m ³
F	300 mg/m ³	3 000 mg/m ³	1 000 mg/m ³	10 000 mg/m ³	300 mg/m ³	3 000 mg/m ³
G	500 mg/m ³	5 000 mg/m ³			500 mg/m ³	5 000 mg/m ³
H	1 000 mg/m ³	10 000 mg/m ³	3 000 mg/m ³	30 000 mg/m ³	1 000 mg/m ³	10 000 mg/m ³
K	3 000 mg/m ³	30 000 mg/m ³	10 g/m ³	100 g/m ³	3 000 mg/m ³	30 000 mg/m ³

Example for ordering

ULTRAMAT 6, QAL1

Component: CO

Measuring range: 0 to 50 / 1 000 mg/m³

with hoses, non-flow-type reference compartment

without automatic adjustment (AUTOCAL)

230 V AC; German

7MB2121-0XD00-1AA0-Z +Y17

Performance-tested according to EN 15267 (single component)

Only in conjunction with order code Y27/Y28

Component Measuring range identification	CO (QAL1)		SO ₂ (QAL1)		NO (QAL1)	
	Smallest measuring range from 0 to ...	Largest measuring range from 0 to ...	Smallest measuring range from 0 to ...	Largest measuring range from 0 to ...	Smallest measuring range from 0 to ...	Largest measuring range from 0 to ...
C			75 mg/m ³	1 500 mg/m ³		
D	75 mg/m ³	1 250 mg/m ³				
E	125 mg/m ³	1 250 mg/m ³			100 mg/m ³	2 000 mg/m ³
F	300 mg/m ³	3 000 mg/m ³			300 mg/m ³	3 000 mg/m ³
G	500 mg/m ³	5 000 mg/m ³			500 mg/m ³	5 000 mg/m ³
H	1 000 mg/m ³	10 000 mg/m ³			1 000 mg/m ³	10 000 mg/m ³
J	3 000 mg/m ³	10 000 mg/m ³			3 000 mg/m ³	10 000 mg/m ³

Example for ordering

ULTRAMAT 6 2-channel, performance-tested according to EN 15267

Components: CO + SO₂Measuring range: CO: 0 to 75 / 1 250 mg/m³, SO₂: 0 to 75 / 1 500 mg/m³

with hoses, non-flow-type reference compartment

with automatic adjustment (AUTOCAL)

230 V AC; German

7MB2123-0BD03-1NC0-Z +Y27+Y28

Based on QAL1 according to SIRAMCERTS (2 components in series)

Only in conjunction with order code Y17

Component Measuring range identification	CO (QAL1)		NO (QAL1)	
	Smallest measuring range from 0 to ...	Largest measuring range from 0 to ...	Smallest measuring range from 0 to ...	Largest measuring range from 0 to ...
AA	75 mg/m ³	1 000 mg/m ³	200 mg/m ³	2 000 mg/m ³
AB	300 mg/m ³	3 000 mg/m ³	300 mg/m ³	3 000 mg/m ³
AC	1 000 mg/m ³	10 000 mg/m ³	1 000 mg/m ³	10 000 mg/m ³

Example for ordering

ULTRAMAT 6 2-channel, QAL1

Components: CO/NO + SO₂Measuring range: CO: 0 to 75 / 1 000 mg/m³, NO: 0 to 200 / 2 000 mg/m³, SO₂: 0 to 75 / 1 500 mg/m³

with hoses, non-flow-type reference compartment

without automatic adjustment (AUTOCAL)

230 V AC; German

7MB2124-0AA00-1NC0-Z+Y17+Y18Ordering information measured component N₂OCertification in accordance with AM0028 and AM0034 (Kyoto Protocol) for measuring N₂O, measuring range 0 ... 300 vpm / 3 000 vpm.

Version: Standard device

Dimensional drawings

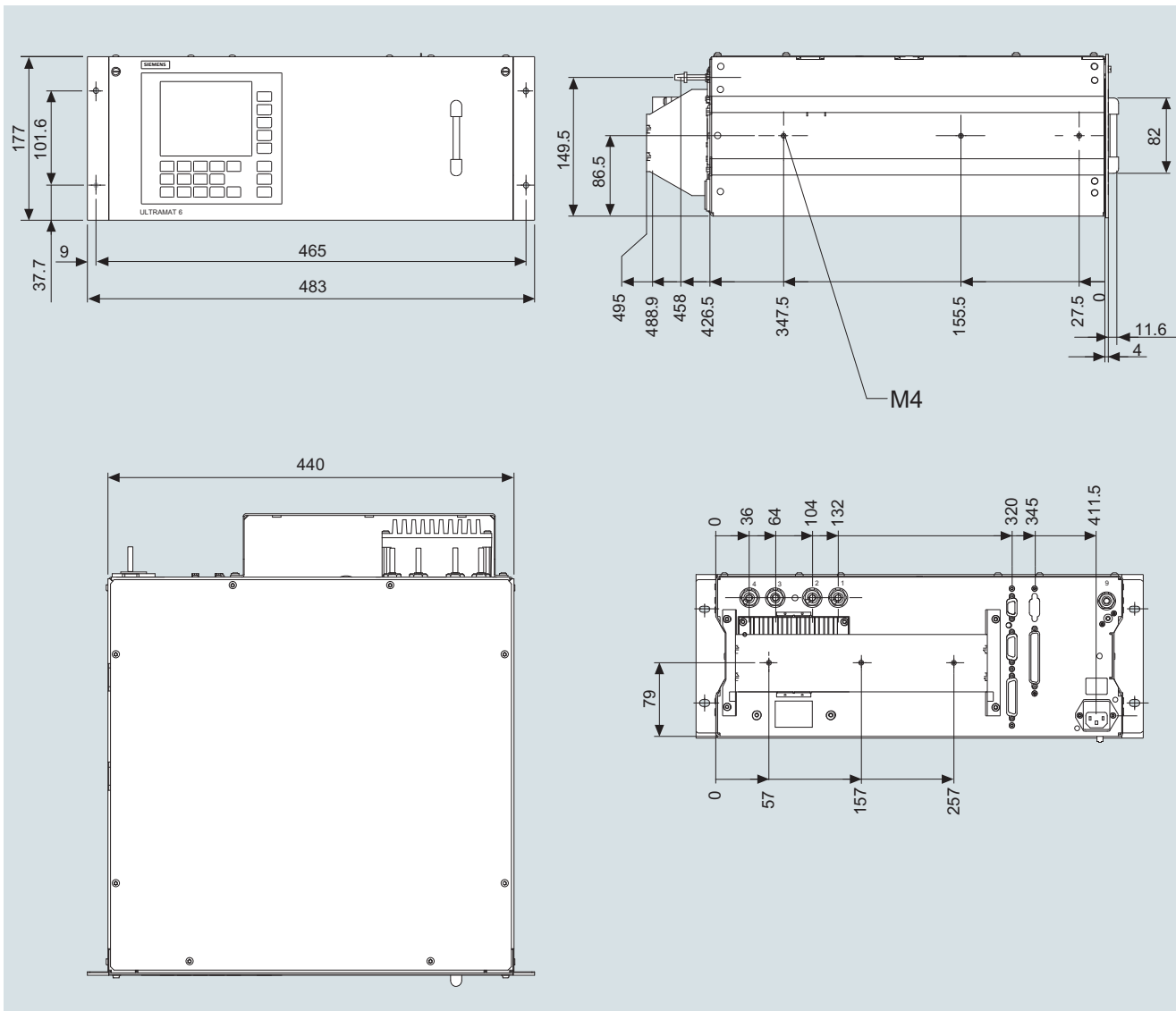

ULTRAMAT 6, 19" rack unit, dimensions in mm (example: 1-channel version)

Extractive continuous process gas analysis

Series 6

ULTRAMAT 6

19" rack unit

1

Circuit diagrams

Pin assignment (electrical and gas connections)

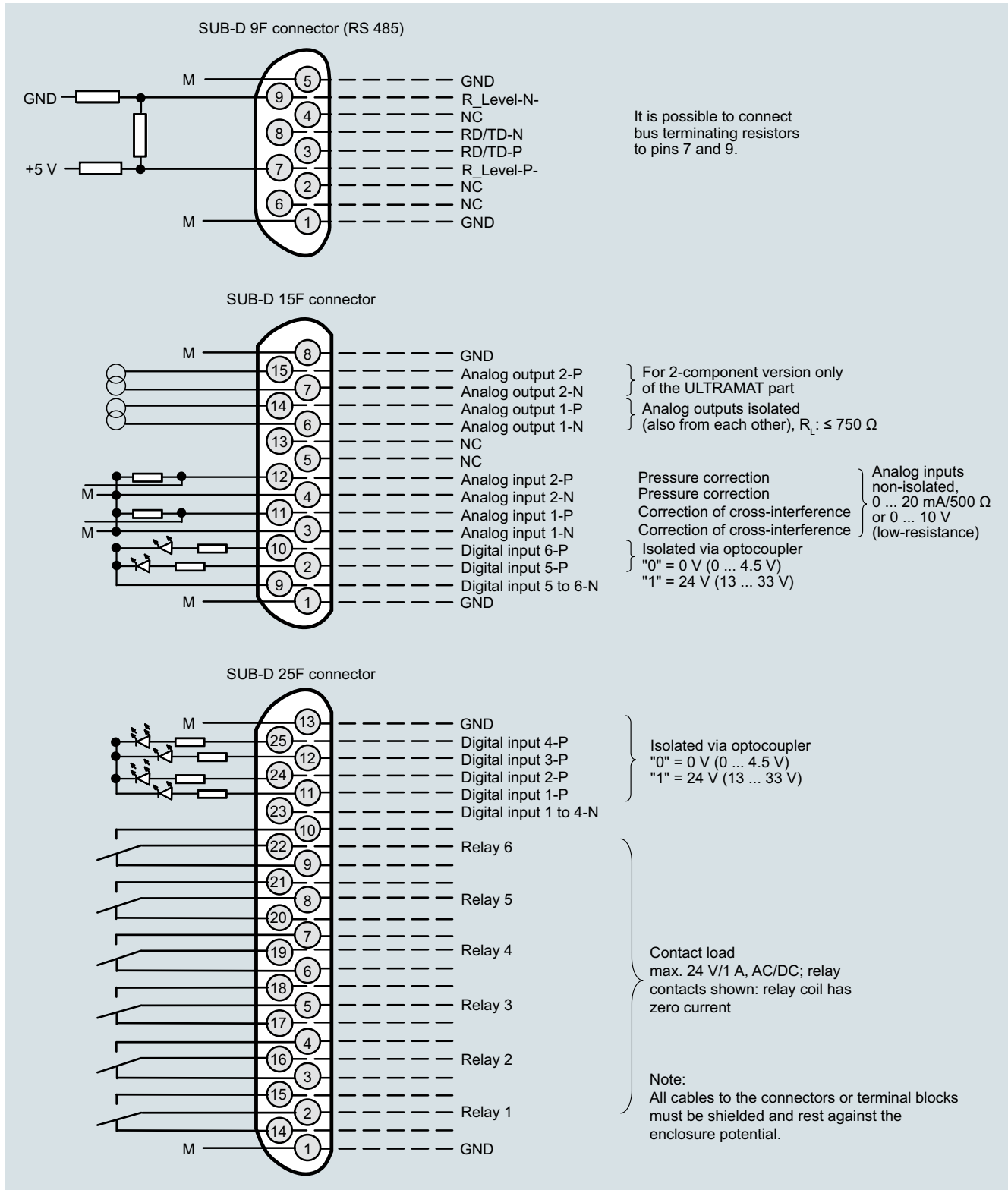

ULTRAMAT 6, 19" rack unit, pin assignment

Connector SUB-D 37F (option)

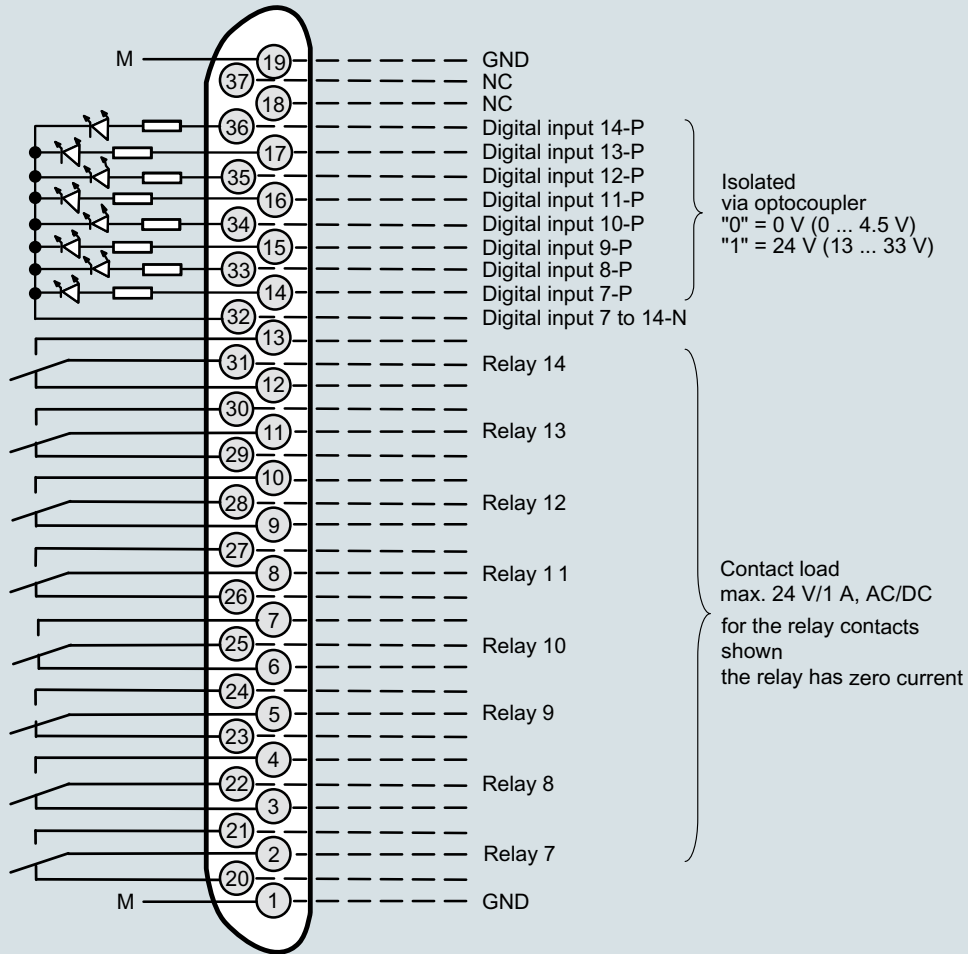

Connector SUB-D 9F
PROFIBUS DP

optional

Connector SUB-D 9M
PROFIBUS PA

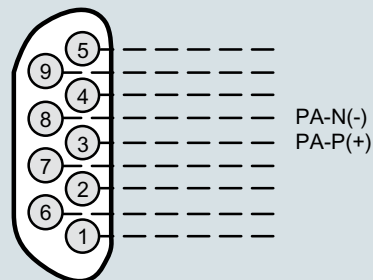
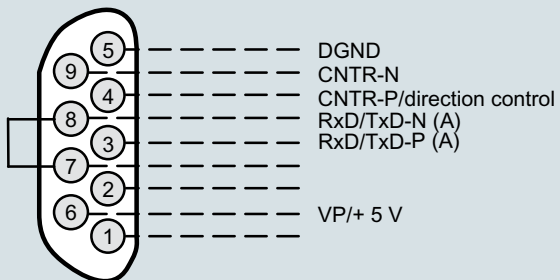

Note:
All cables to the connectors or terminal blocks must be shielded and rest against the enclosure potential.

ULTRAMAT 6, 19" rack unit, pin assignment of the AUTOCAL board and PROFIBUS connectors

Extractive continuous process gas analysis

Series 6

ULTRAMAT 6

19" rack unit

1

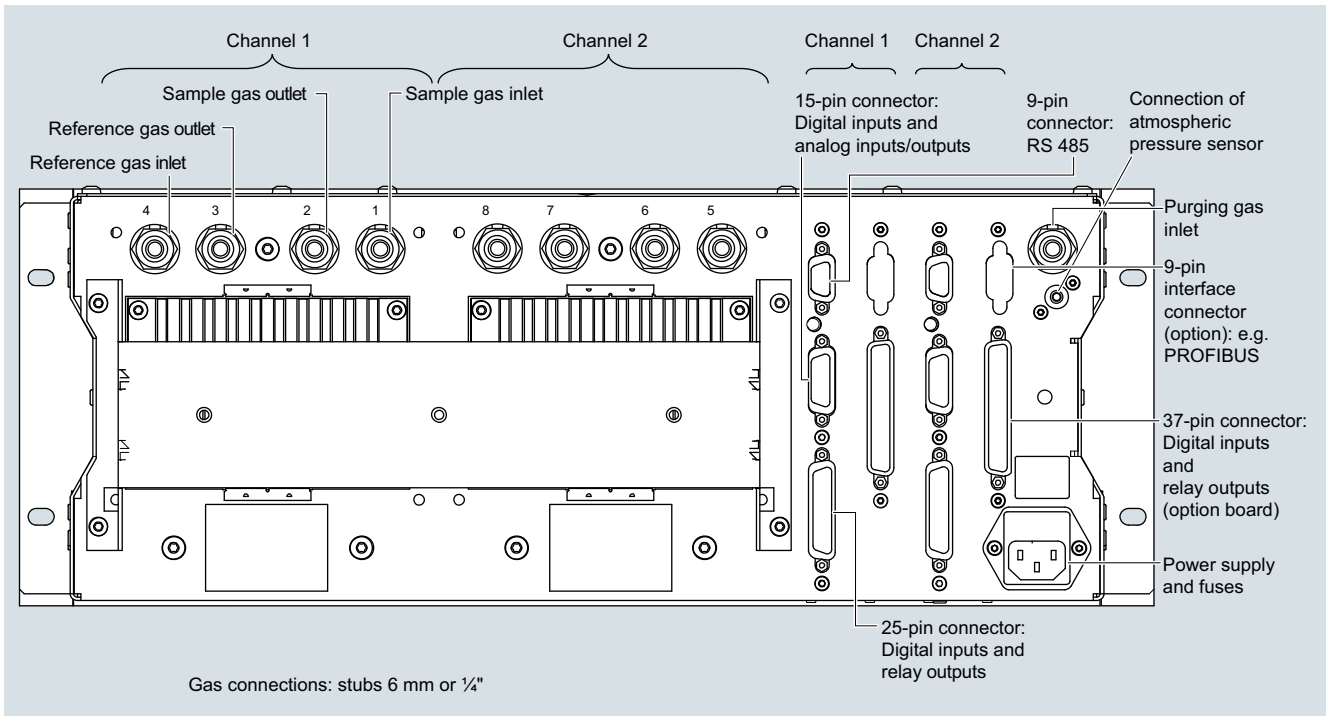

ULTRAMAT 6, 19" rack unit, gas connections and electrical connections (example: 2-channel version)

Technical specifications

General information		Damping (electrical time constant)	0 ... 100 s, configurable
Measuring ranges	4, internally and externally switchable; autoranging is also possible	Dead time (purging time of the gas path in the unit at 1 l/min)	Approximately 0.5 ... 5 s, depending on version
Smallest possible measuring range	Dependent on the application, e.g. CO: 0 ... 10 vpm, CO ₂ : 0 ... 5 vpm	Time for device-internal signal processing	< 1 s
Largest possible measuring range	Dependent on the application	Pressure correction range	
Measuring range with suppressed zero point	Any zero point within 0 ... 100 vol.% can be implemented; smallest possible span 20%	Pressure sensor	
Heated version	65 °C	• Internal	700 ... 1 200 hPa absolute
Operating position	Front wall, vertical	• External	700 ... 1 500 hPa absolute
Conformity	CE mark in accordance with EN 50081-1, EN 50082-2	Measuring response	
Influence of interfering gases must be considered separately		Output signal fluctuation	Based on sample gas pressure 1 013 hPa absolute, 0.5 l/min sample gas flow and 25 °C ambient temperature
Design, enclosure		Zero point drift	< ± 1% of the smallest possible measuring range according to rating plate
Weight	Approx. 32 kg	Zero point drift	< ± 1% of the current measuring range/week
Degree of protection	IP65 in accordance with EN 60529, restricted breathing enclosure to EN 50021	Measured-value drift	< ± 1% of the current measuring range/week
Electrical characteristics		Repeatability	≤ 1% of the current measuring range
Auxiliary power	100 ... 120 V AC (nominal range of use 90 ... 132 V), 48 ... 63 Hz or 200 ... 240 V AC (nominal range of use 180 ... 264 V), 48 ... 63 Hz	Detection limit	1% of the smallest possible measuring range
Power consumption	Approx. 35 VA; approx. 330 VA with heated version	Linearity error	± 0.5 % of the full-scale value
EMC (electromagnetic compatibility)	In accordance with standard requirements of NAMUR NE21 (08/98)	Influencing variables	
Electrical safety	In accordance with EN 61010-1	Ambient temperature	Based on sample gas pressure 1 013 hPa absolute, 0.5 l/min sample gas flow and 25 °C ambient temperature
• Heated units	Overvoltage category II	Sample gas pressure	< 1% of current measuring range/10 K (with constant receiver cell temperature)
• Unheated units	Overvoltage category III	Sample gas pressure	With disabled pressure compensation: < 0.15% of the setpoint/1 % change in atmospheric pressure
Fuse values (unheated unit)		Sample gas flow	Negligible
• 100 ... 120 V	F3: 1 T/250; F4: 1 T/250	Auxiliary power	< 0.1% of the current measuring range with rated voltage ± 10%
• 200 ... 240 V	F3: 0.63 T/250; F4: 0.63 T/250	Environmental conditions	Application-specific measuring influences possible if ambient air contains measured component or cross interference-sensitive gases
Fuse values (heated unit)		Electrical inputs and outputs	
• 100 ... 120 V	F1: 1 T/250; F2: 4 T/250 F3: 4 T/250; F4: 4 T/250	Analog output	0/2/4 ... 20 mA, isolated; load 750 Ω
• 200 ... 240 V	F1: 0.63 T/250; F2: 2.5 T/250 F3: 2.5 T/250; F4: 2.5 T/250	Relay outputs	6, with changeover contacts, freely configurable, e.g. for measuring range identification; load: 24 V AC/DC/1 A, isolated, non-sparking
Gas inlet conditions		Analog inputs	2, dimensioned for 0/2/4 ... 20 mA for external pressure sensor and accompanying gas influence correction (correction of cross-interference)
Permissible sample gas pressure		Digital inputs	6, designed for 24 V, isolated, freely configurable, e.g. for measuring range switchover
• With hoses (without pressure switch)	600 ... 1 500 hPa (absolute)	Serial interface	RS 485
• With pipes (without pressure switch)	600 ... 1 500 hPa (absolute)	Options	AUTOCAL function each with 8 additional digital inputs and relay outputs, also with PROFIBUS PA or PROFIBUS DP
- Ex (leakage compensation)	600 ... 1 160 hPa (absolute)	Climatic conditions	
- Ex (continuous purging)	600 ... 1 500 hPa (absolute)	Permissible ambient temperature	-30 ... +70 °C during storage and transportation; 5 ... 45 °C during operation
Purging gas pressure		Permissible humidity	< 90% RH (RH: relative humidity) within average annual value, during storage and transportation (dew point must not be undershot)
• Permanent	< 165 hPa above ambient pressure		
• For short periods	250 hPa above ambient pressure		
Sample gas flow	18 ... 90 l/h (0.3 ... 1.5 l/min)		
Sample gas temperature	Min. 0 ... max. 50 °C, but above the dew point, for heated version min. 0 ... max. 80 °C		
Sample gas humidity	< 90% RH (RH: relative humidity) or dependent on measuring task		
Dynamic response			
Warm-up period	At room temperature < 30 min (the technical specification will be met after 2 hours)		
Delayed display (T ₉₀ -time)	Dependent on length of analyzer chamber, sample gas line and configurable damping		

Extractive continuous process gas analysis

Series 6

ULTRAMAT 6

Field device

1

Selection and ordering data

ULTRAMAT 6 gas analyzer

For installation in the field, single-channel, 1 component

➤ Click on the Article No. for the online configuration in the PIA Life Cycle Portal.

Gas connections

Ferrule screw connection for pipe, outer diameter 6 mm

Ferrule screw connection for pipe, outer diameter 1/4"

Measured component

Measured component	Possible with measuring range identification	
CO	11 ... 30	
CO highly selective (with optical filter)	12 ... 30	
CO (QAL1; see table "Based on QAL1 according to SIRA/MCERTS (single component)", page 1/65)		
CO ₂	10 ... 30	
CH ₄	13 ... 30	
C ₂ H ₂	15 ... 30	
C ₂ H ₄	15 ... 30	
C ₂ H ₆	14 ... 30	
C ₃ H ₆	14 ... 30	
C ₃ H ₈	13 ... 30	
C ₄ H ₆	15 ... 30	
C ₄ H ₁₀	14 ... 30	
C ₆ H ₁₄	14 ... 30	
SO ₂ (QAL1; see table "Based on QAL1 according to SIRA/MCERTS (single component)", page 1/65)	13 ... 30	
NO (QAL1; see table "Based on QAL1 according to SIRA/MCERTS (single component)", page 1/65)	14 ... 20, 22	
NH ₃ (dry)	14 ... 30	
H ₂ O	17 ... 20; 22 (17 to 24, 26; heated)	
N ₂ O	13 ... 30	

Smallest measuring range	Largest measuring range	Measuring range identification
--------------------------	-------------------------	--------------------------------

0 ... 5 vpm	0 ... 100 vpm	10
0 ... 10 vpm	0 ... 200 vpm	11
0 ... 20 vpm	0 ... 400 vpm	12
0 ... 50 vpm	0 ... 1 000 vpm	13
0 ... 100 vpm	0 ... 1 000 vpm	14
0 ... 300 vpm	0 ... 3 000 vpm	15
0 ... 500 vpm	0 ... 5 000 vpm	16
0 ... 1 000 vpm	0 ... 10 000 vpm	17
0 ... 3 000 vpm	0 ... 10 000 vpm	19
0 ... 3 000 vpm	0 ... 30 000 vpm	19
0 ... 5 000 vpm	0 ... 15 000 vpm	20
0 ... 5 000 vpm	0 ... 50 000 vpm	21
0 ... 1 %	0 ... 3 %	22
0 ... 1 %	0 ... 10 %	23
0 ... 3 %	0 ... 10 %	24
0 ... 3 %	0 ... 30 %	25
0 ... 5 %	0 ... 15 %	26
0 ... 5 %	0 ... 50 %	27
0 ... 10 %	0 ... 30 %	28
0 ... 10 %	0 ... 100 %	29
0 ... 30 %	0 ... 100 %	30

Article No.

7MB2111- - - - - A

Cannot be combined

0 → A29

1 → A28

A

B

X

C

D

E

F

G

H

J

K

L

M

N

P

Q

R

S

Q

R

A

B

C

D

E

F

G

H

J

K

L

M

N

P

Q

R

S

T

U

V

W

Selection and ordering data

Article No.

ULTRAMAT 6 gas analyzer

7MB2111- - - - - A

Cannot be combined

For installation in the field, single-channel, 1 component

Internal gas paths	Sample chamber (lining)	Reference chamber (flow-type)			
Hose made of FKM (Viton)	Aluminum	Non-flow-type	0	0	0 → A28, A29
	Aluminum	Flow-type	1	1	1 → A28, A29
Pipe made of titanium	Tantalum ¹⁾	Non-flow-type	2	2	2 → A28, A29, Y02
	Tantalum ¹⁾	Flow-type	3	3	3 → Y02
Stainless steel pipe (mat. no. 1.4571)	Aluminum	Non-flow-type	6	6	6 → A28, A29
	Tantalum ¹⁾	Non-flow-type	8	8	8 → A28, A29
<u>Add-on electronics</u>					
Without			0		
AUTOCAL function					
• With 8 additional digital inputs/outputs			1		
• With 8 digital inputs/outputs and PROFIBUS PA interface			6		6 → E12
• With 8 digital inputs/outputs and PROFIBUS DP interface			7		7 → E12
• With 8 digital inputs/outputs and PROFIBUS PA Ex i			8		
<u>Power supply</u>					
Standard unit and acc. to ATEX II 3G version (Zone 2)					
• 100 ... 120 V AC, 48 ... 63 Hz			0	0	
• 200 ... 240 V AC, 48 ... 63 Hz			1	1	
ATEX II 2G versions (Zone 1), incl. certificate					
• 100 ... 120 V AC, 48 ... 63 Hz, according to ATEX II 2G ²⁾ (operating mode: leakage compensation)			2	2	
• 200 ... 240 V AC, 48 ... 63 Hz, according to ATEX II 2G ²⁾ (operating mode: leakage compensation)			3	3	
• 100 ... 120 V AC, 48 ... 63 Hz, according to ATEX II 2G ²⁾ (operating mode: continuous purging)			6	6	
• 200 ... 240 V AC, 48 ... 63 Hz, according to ATEX II 2G ²⁾ (operating mode: continuous purging)			7	7	
<u>Heating of internal gas paths and analyzer unit</u>					
Without					
With (max. 65 °C)				A B	
<u>Language (supplied documentation, software)</u>					
German				0	
English				1	
French				2	
Spanish				3	
Italian				4	

1) Only for cell length 20 to 180 mm

2) Only in connection with an approved purging unit

Extractive continuous process gas analysis

Series 6

ULTRAMAT 6

Field device

1

Selection and ordering data

<u>Additional versions</u>	Order code
Add "-Z" to Article No. and specify Order codes.	
Flow-type reference cell with reduced flow, 6 mm	A28
Flow-type reference cell with reduced flow, 1/4"	A29
TAG labels (specific lettering based on customer information)	B03
Kalrez gaskets in sample gas path	B04
SIL conformity declaration (SIL 2) Functional Safety according to IEC 61508 and IEC 61511	C20
<u>Ex versions</u>	
Possible combinations: see table "Ex configurations – principle selection criteria (Series 6)", chapter "General information"	
ATEX II 3G certificate; restricted breathing enclosure, non-flammable gases	E11
ATEX II 3G certificate; flammable gases	E12
FM/CSA certificate – Class I Div 2	E20
ATEX II 3D certificate; potentially explosive dust atmospheres	
<ul style="list-style-type: none"> In non-hazardous gas zone 	E40
<ul style="list-style-type: none"> In Ex zone acc. to ATEX II 3G, non-flammable gases 	E41
<ul style="list-style-type: none"> In Ex zone acc. to ATEX II 3G, flammable gases¹⁾ 	E42
BARTEC Ex p purging unit "Leakage compensation"	E71
BARTEC Ex p purging unit "Continuous purging"	E72
Clean for O ₂ service (specially cleaned gas path)	Y02
Measuring range indication in plain text, if different from the standard setting	Y11
Special setting (only in conjunction with an application no., e.g. extended measuring range)	Y12
Extended special setting (only in conjunction with an application no., e.g. determination of cross-interferences)	Y13
QAL1 according to SIRAMCERTS	Y17
<u>Additional units for Ex versions</u>	Article No.
<u>Category ATEX II 2G (zone 1)</u>	
BARTEC Ex p purging unit, 230 V, "leakage compensation"	7MB8000-2BA
BARTEC Ex p purging unit, 115 V, "leakage compensation"	7MB8000-2BB
BARTEC Ex p purging unit, 230 V, "continuous purging"	7MB8000-2CA
BARTEC Ex p purging unit, 115 V, "continuous purging"	7MB8000-2CB
Ex i isolating transformer	7MB8000-3AB
Ex isolating relay, 230 V	7MB8000-4AA
Ex isolating relay, 110 V	7MB8000-4AB
Differential pressure switch for corrosive and non-corrosive gases	7MB8000-5AA
Stainless steel flame arrestor	7MB8000-6BA
Hastelloy flame arrestor	7MB8000-6BB
<u>Category ATEX II 3G (Zone 2)</u>	
BARTEC Ex p purging unit, 230 V, "continuous purging"	7MB8000-2CA
BARTEC Ex p purging unit, 115 V, "continuous purging"	7MB8000-2CB
<u>FM/CSA (Class I Div. 2)</u>	
Ex purging unit MiniPurge FM	7MB8000-1AA
<u>Accessories</u>	Article No.
RS 485/Ethernet converter	A5E00852383
RS 485/RS 232 converter	C79451-Z1589-U1
RS 485/USB converter	A5E00852382
AUTOCAL function with 8 digital inputs/outputs	A5E00064223
AUTOCAL function with 8 digital inputs/outputs and PROFIBUS PA	A5E00057315
AUTOCAL function with 8 digital inputs/outputs and PROFIBUS DP	A5E00057318
AUTOCAL function with 8 digital inputs/outputs and PROFIBUS PA Ex i (firmware 4.1.10 required)	A5E00057317
Set of Torx screwdrivers	A5E34821625

¹⁾ Only in connection with an approved purging unit

Selection and ordering data			Article No.	
ULTRAMAT 6 gas analyzer For installation in the field, single-channel, 2 components			7MB2112- - - - - A	
<p>Click on the Article No. for the online configuration in the PIA Life Cycle Portal.</p> <p>Gas connections Ferrule screw connection for pipe, outer diameter 6 mm Ferrule screw connection for pipe, outer diameter 1/4"</p>			Cannot be combined 0 → A29 1 → A28	
<u>Measured component</u>	<u>Smallest measuring range</u>	<u>Largest measuring range</u>		
CO	0 ... 100 vpm	0 ... 1 000 vpm	AA	
NO	0 ... 100 vpm	0 ... 1 000 vpm		
CO	0 ... 300 vpm	0 ... 3 000 vpm	AB	
NO	0 ... 300 vpm	0 ... 3 000 vpm		
CO	0 ... 1 000 vpm	0 ... 10 000 vpm	AC	
NO	0 ... 1 000 vpm	0 ... 10 000 vpm		
For CO/NO (QAL1; see table "Based on QAL1 according to SIRA/MCERTS (2 components in series)", page 1/65)				
CO ₂	0 ... 100 vpm	0 ... 1 000 vpm	BA	
CO	0 ... 100 vpm	0 ... 1 000 vpm		
CO ₂	0 ... 300 vpm	0 ... 3 000 vpm	BB	
CO	0 ... 300 vpm	0 ... 3 000 vpm		
CO ₂	0 ... 1 000 vpm	0 ... 10 000 vpm	BC	
CO	0 ... 1 000 vpm	0 ... 10 000 vpm		
CO ₂	0 ... 3 000 vpm	0 ... 30 000 vpm	BD	
CO	0 ... 3 000 vpm	0 ... 30 000 vpm		
CO ₂	0 ... 1 %	0 ... 10 %	BE	
CO	0 ... 1 %	0 ... 10 %		
CO ₂	0 ... 3 %	0 ... 30 %	BF	
CO	0 ... 3 %	0 ... 30 %		
CO ₂	0 ... 10 %	0 ... 100 %	BG	
CO	0 ... 10 %	0 ... 100 %		
CO ₂	0 ... 10 %	0 ... 100 %	CG	
CH ₄	0 ... 10 %	0 ... 100 %		
CO ₂	0 ... 100 vpm	0 ... 1 000 vpm	DA	
NO	0 ... 100 vpm	0 ... 1 000 vpm		
CO ₂	0 ... 300 vpm	0 ... 3 000 vpm	DB	
NO	0 ... 300 vpm	0 ... 3 000 vpm		
<u>Internal gas paths</u>	<u>Sample chamber (lining)</u>	<u>Reference chamber (flow-type)</u>		
Hose made of FKM (Viton)	Aluminum	Non-flow-type	0	0 → A28, A29
	Aluminum	Flow-type	1	
Pipe made of titanium	Tantalum ¹⁾	Non-flow-type	2	2 → A28, A29, Y02
	Tantalum ¹⁾	Flow-type	3	
Stainless steel pipe (mat. no. 1.4571)	Aluminum	Non-flow-type	6	6 → A28, A29
	Tantalum ¹⁾	Non-flow-type	8	
<u>Add-on electronics</u>				
Without			0	
AUTOCAL function				
• With 8 additional digital inputs/outputs			1	
• With 8 digital inputs/outputs and PROFIBUS PA interface			6	
• With 8 digital inputs/outputs and PROFIBUS DP interface			7	
• With 8 digital inputs/outputs and PROFIBUS PA Ex i			8	
<u>Power supply</u>				
Standard unit and acc. to ATEX II 3G version (Zone 2)				
• 100 ... 120 V AC, 48 ... 63 Hz			0	
• 200 ... 240 V AC, 48 ... 63 Hz			1	
ATEX II 2G versions (Zone 1), incl. certificate				
• 100 ... 120 V AC, 48 ... 63 Hz, according to ATEX II 2G ²⁾ (operating mode: leakage compensation)			2	2
• 200 ... 240 V AC, 48 ... 63 Hz, according to ATEX II 2G ²⁾ (operating mode: leakage compensation)			3	3
• 100 ... 120 V AC, 48 ... 63 Hz, according to ATEX II 2G ²⁾ (operating mode: continuous purging)			6	6
• 200 ... 240 V AC, 48 ... 63 Hz, according to ATEX II 2G ²⁾ (operating mode: continuous purging)			7	7
<u>Heating of internal gas paths and analyzer unit</u>				
none			A	
With (max. 65 °C)			B	

Extractive continuous process gas analysis

Series 6

ULTRAMAT 6

Field device

1

Selection and ordering data

ULTRAMAT 6 gas analyzer

For installation in the field, single-channel, 2 components

Article No.

7MB2112-  Cannot be combined

Language (supplied documentation, software)

German
English
French
Spanish
Italian

0
1
2
3
4

1) Only for cell length 20 to 180 mm.

2) See also "Additional units for Ex versions".

Additional versions

Order code

Add "-Z" to Article No. and specify Order codes.

Flow-type reference cell with reduced flow, 6 mm

A28

Flow-type reference cell with reduced flow, ¼"

A29

TAG labels (specific lettering based on customer information)

B03

Kalrez gaskets in sample gas path

B04

SIL conformity declaration (SIL 2) Functional Safety according to IEC 61508 and IEC 61511

C20

Ex versions

Possible combinations: see table "Ex configurations – principle selection criteria (Series 6), chapter "General information"

ATEX II 3G certificate; restricted breathing enclosure, non-flammable gases

E11

ATEX II 3G certificate; flammable gases

E12

CSA certificate – Class I Div 2

E20

ATEX II 3D certificate; potentially explosive dust atmospheres

- In non-hazardous gas zone

E40

- In Ex zone acc. to ATEX II 3G, non-flammable gases

E41

- In Ex zone acc. to ATEX II 3G, flammable gases

E42

BARTEC Ex p purging unit "Leakage compensation"

E71

BARTEC Ex p purging unit "Continuous purging"

E72

Clean for O₂ service (specially cleaned gas path)

Y02

Measuring range indication in plain text, if different from the standard setting

Y11

Special setting (only in conjunction with an application no., e.g. extended measuring range)

Y12

Extended special setting

Y13

(only in conjunction with an application no., e.g. determination of cross-interferences)

QAL1 according to SIRA/MCERTS

Y17

Additional units for Ex versions

Article No.

Category ATEX II 2G (zone 1)

BARTEC Ex p purging unit, 230 V, "leakage compensation"

7MB8000-2BA

BARTEC Ex p purging unit, 115 V, "leakage compensation"

7MB8000-2BB

BARTEC Ex p purging unit, 230 V, "continuous purging"

7MB8000-2CA

BARTEC Ex p purging unit, 115 V, "continuous purging"

7MB8000-2CB

Ex i isolating transformer

7MB8000-3AB

Ex isolating relay, 230 V

7MB8000-4AA

Ex isolating relay, 110 V

7MB8000-4AB

Differential pressure switch for corrosive and non-corrosive gases

7MB8000-5AA

Stainless steel flame arrestor

7MB8000-6BA

Hastelloy flame arrestor

7MB8000-6BB

Category ATEX II 3G (Zone 2)

BARTEC Ex p purging unit, 230 V, "continuous purging"

7MB8000-2CA

BARTEC Ex p purging unit, 115 V, "continuous purging"

7MB8000-2CB

FM/CSA (Class I Div. 2)

Ex purging unit MiniPurge FM

7MB8000-1AA

Accessories

Article No.

RS 485/Ethernet converter

A5E00852383

RS 485/RS 232 converter

C79451-Z1589-U1

RS 485/USB converter

A5E00852382

AUTOCAL function with 8 digital inputs/outputs

A5E00064223

AUTOCAL function with 8 digital inputs/outputs and PROFIBUS PA

A5E00057315

AUTOCAL function with 8 digital inputs/outputs and PROFIBUS DP

A5E00057318

AUTOCAL function with 8 digital inputs/outputs and PROFIBUS PA Ex i (firmware 4.1.10 required)

A5E00057317

Set of Torx screwdrivers

A5E34821625

Based on QAL1 according to SIRAMCERTS (single component)

Only with additional suffix Z (Y17, Y18)

Component Measuring range identification	CO (QAL1)		SO ₂ (QAL1)		NO (QAL1)	
	Smallest measuring range from 0 to ...	Largest measuring range from 0 to ...	Smallest measuring range from 0 to ...	Largest measuring range from 0 to ...	Smallest measuring range from 0 to ...	Largest measuring range from 0 to ...
C			75 mg/m ³	1 500 mg/m ³		
D	50 mg/m ³	1 000 mg/m ³	300 mg/m ³	3 000 mg/m ³		
E			500 mg/m ³	5 000 mg/m ³	100 mg/m ³	2 000 mg/m ³
F	300 mg/m ³	3 000 mg/m ³	1 000 mg/m ³	10 000 mg/m ³	300 mg/m ³	3 000 mg/m ³
G	500 mg/m ³	5 000 mg/m ³			500 mg/m ³	5 000 mg/m ³
H	1 000 mg/m ³	10 000 mg/m ³	3 000 mg/m ³	30 000 mg/m ³	1 000 mg/m ³	10 000 mg/m ³
K	3 000 mg/m ³	30 000 mg/m ³	10 g/m ³	100 g/m ³	3 000 mg/m ³	30 000 mg/m ³

Example for ordering

ULTRAMAT 6, QAL1 (1-component unit)

Component: CO

Measuring range: 0 to 50 / 1 000 mg/m³

with hoses, non-flow-type reference compartment

without automatic adjustment (AUTOCAL)

230 V AC; without heating, German

7MB2111-0XD00-1AA0-Z +Y17**Based on QAL1 according to SIRAMCERTS (2 components in series)**

Component Measuring range identification	CO (QAL1)		NO (QAL1)	
	Smallest measuring range from 0 to ...	Largest measuring range from 0 to ...	Smallest measuring range from 0 to ...	Largest measuring range from 0 to ...
AA	75 mg/m ³	1 000 mg/m ³	200 mg/m ³	2 000 mg/m ³
AB	300 mg/m ³	3 000 mg/m ³	300 mg/m ³	3 000 mg/m ³
AC	1 000 mg/m ³	10 000 mg/m ³	1 000 mg/m ³	10 000 mg/m ³

Example for ordering

ULTRAMAT 6, QAL1 (2 components in series)

Components: CO/NO

Measuring range CO: 0 to 75 / 1 000 mg/m³, NO: 0 to 200 / 2 000 mg/m³

with hoses, non-flow-type reference compartment

without automatic adjustment (AUTOCAL)

230 V AC; without heating, German

7MB2112-0AA00-1AA0-Z +Y17**Note:** for 3 components take both tables into consideration.Ordering information measured component N₂OCertification in accordance with AM0028 and AM0034 (Kyoto Protocol) for measuring N₂O, measuring range 0 to 300 vpm / 3 000 vpm.

Version: Standard device

Extractive continuous process gas analysis

Series 6

ULTRAMAT 6

Field device

1

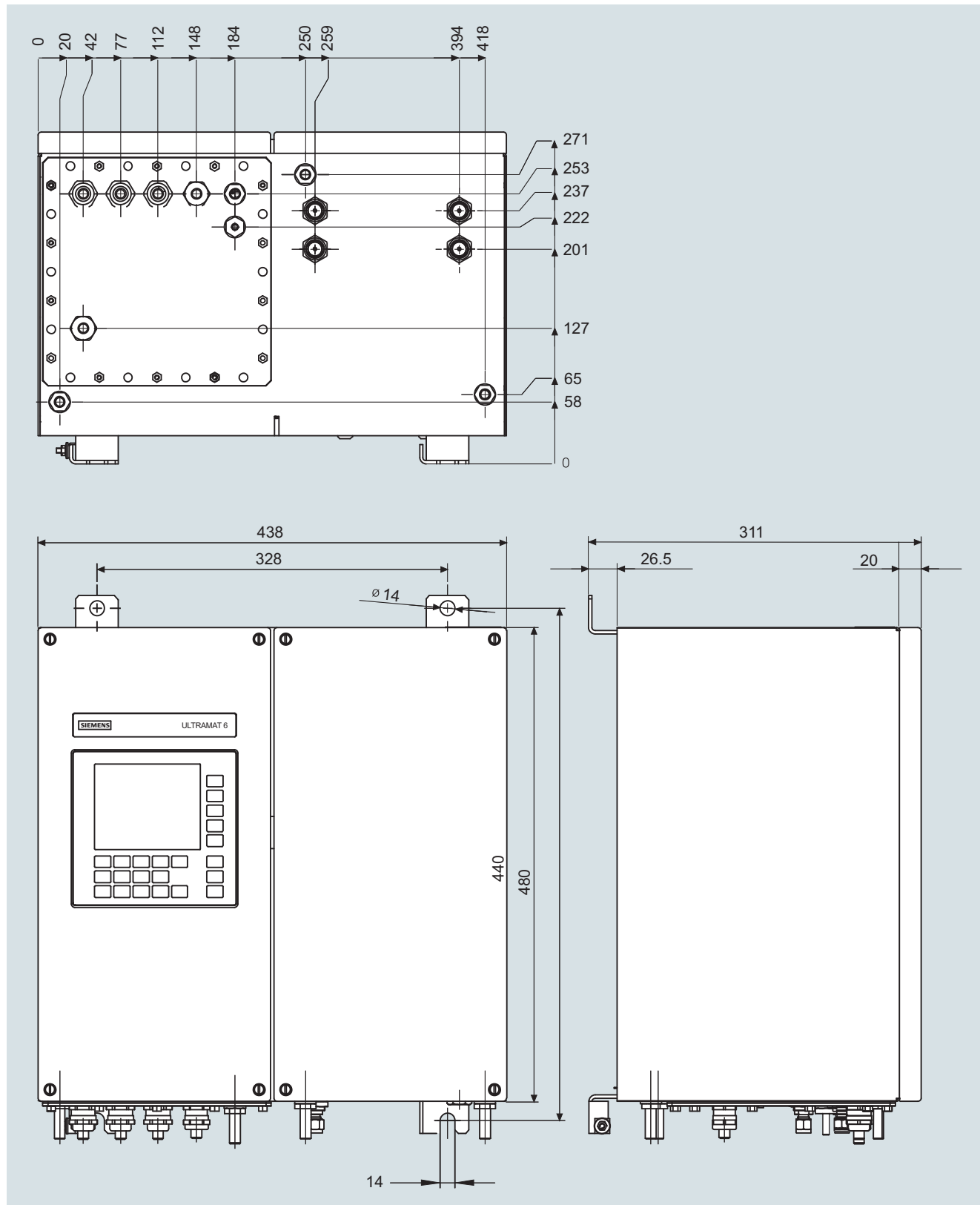
Dimensional drawings

ULTRAMAT 6, field unit, dimensions in mm

Circuit diagrams

Pin assignment (electrical and gas connections)

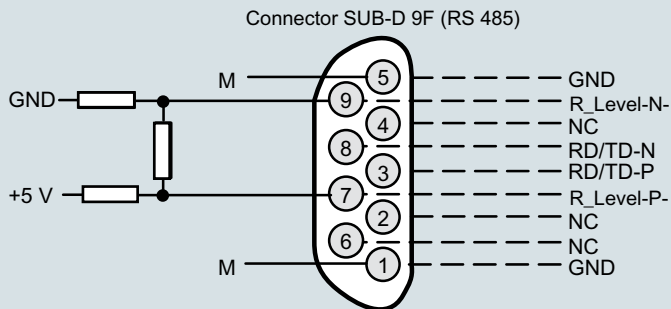

It is possible to connect bus terminating resistors to pins 7 and 9.

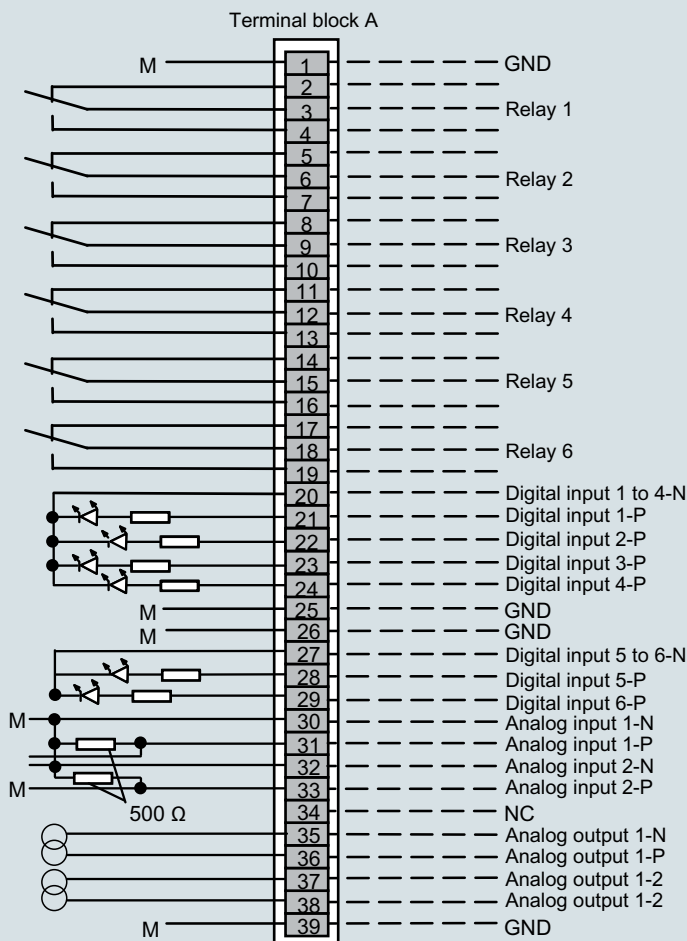

Contact load max.
24 V/1 A, AC/DC; relay contacts shown: relay coil has zero current

Isolated via optocoupler
"0" = 0 V (0 ... 4.5 V)
"1" = 24 V (13 ... 33 V)

Isolated via optocoupler
"0" = 0 V (0 ... 4.5 V)
"1" = 24 V (13 ... 33 V)
} Correction of cross-interference } Analog inputs non-isolated,
} Pressure correction } 0 ... 20 mA or 0 ... 10 V (internal resistance ≤ 500 Ω)

} Component 1 } Analog outputs isolated
} Component 2 (if available) }

Note:
All cables to the connectors or terminal blocks must be shielded and rest against the enclosure potential.

ULTRAMAT 6, field device, pin and terminal assignment

Extractive continuous process gas analysis

Series 6
ULTRAMAT 6

Field device

1

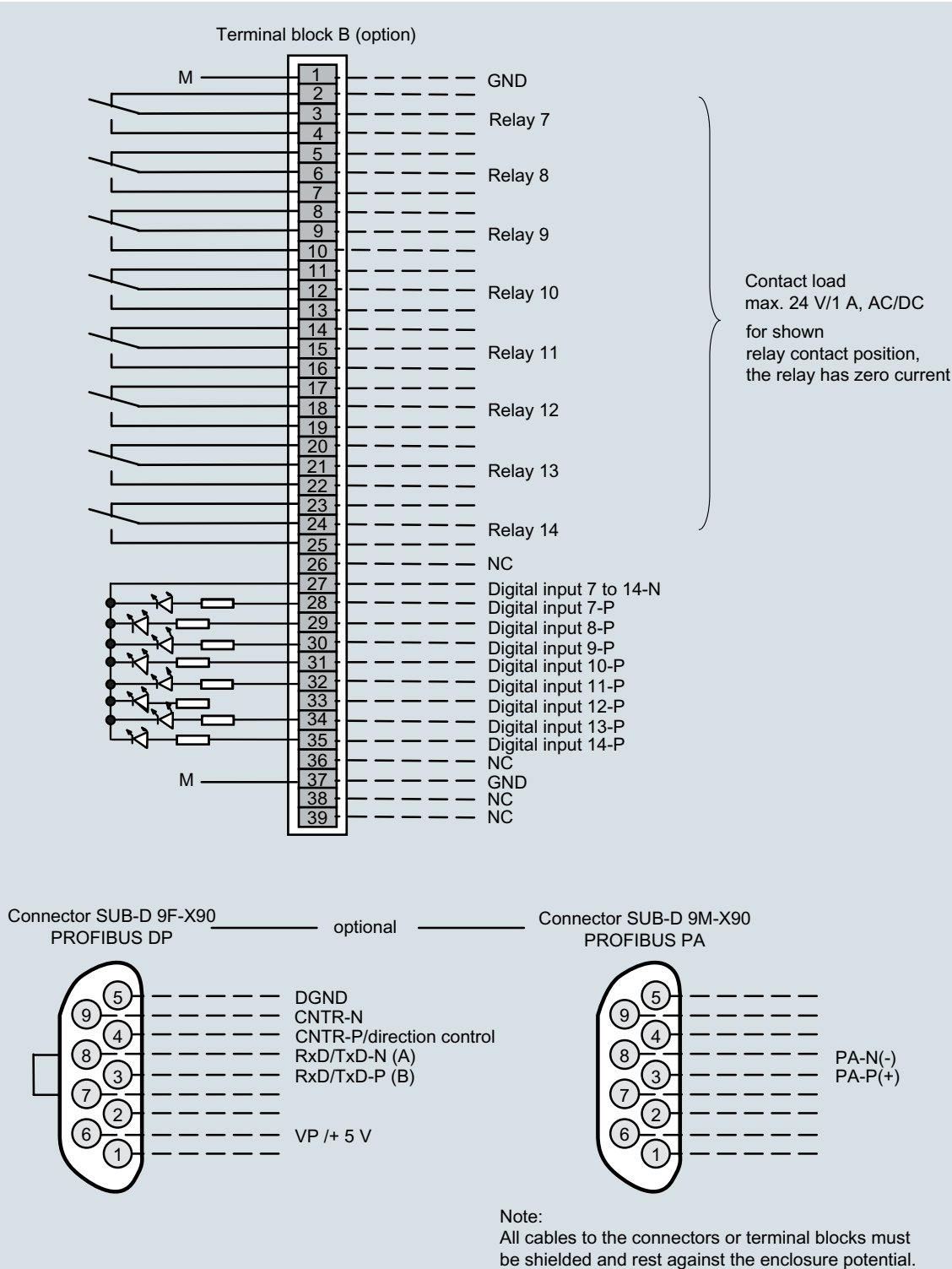

ULTRAMAT 6, field device, pin and terminal assignment of the AUTOCAL board and PROFIBUS connectors

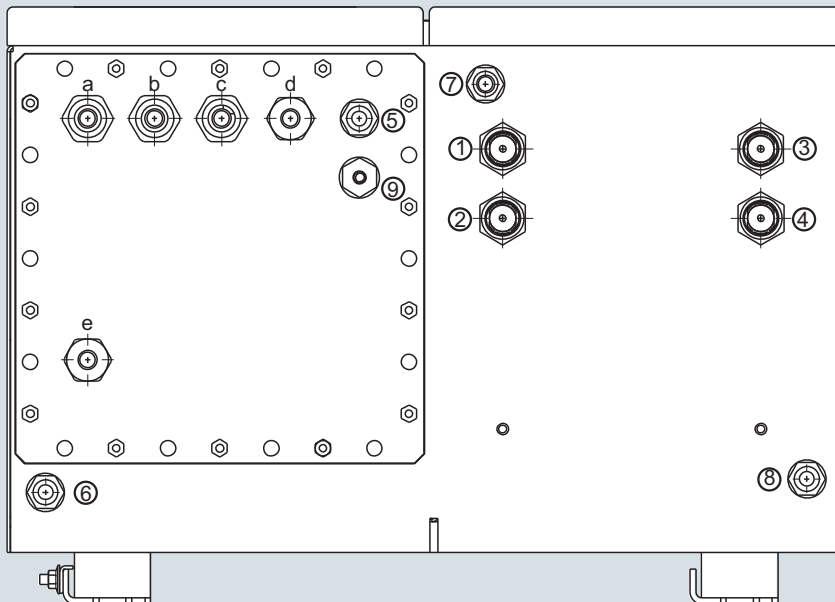

Gas connections

- | | | |
|-----|--|---|
| ① | Sample gas inlet | } Clamping gland for pipe
Ø 6 mm or 1/4" |
| ② | Sample gas outlet | |
| ③ | Reference gas inlet (option) | |
| ④ | Reference gas outlet (option) | |
| ⑤-⑧ | Purging gas inlets/outlets, stubs Ø 10 mm or 3/8" | |
| ⑨ | Connection atmospheric pressure sensor, stubs Ø 1/4" | |

Electrical connections

- | | |
|-------|--|
| a - c | Signal cable (Ø 10 ... 14 mm)
(analog + digital): cable gland M20x1.5 |
| d | Interface connection: (Ø 7 ... 12 mm)
cable gland M20x1.5 |
| e | Power supply: (Ø 7 ... 12 mm)
cable gland M20x1.5 |

ULTRAMAT 6, field device, gas connections and electrical connections

Extractive continuous process gas analysis

Series 6

ULTRAMAT 6

Documentation, suggestions for spare parts

1

Selection and ordering data

Operating instructions	Article No.
ULTRAMAT 6 / OXYMAT 6 Gas analyzer for IR-absorbing gases and oxygen	
• German	C79000-G5200-C143
• English	C79000-G5276-C143
• French	C79000-G5277-C143
• Spanish	C79000-G5278-C143
• Italian	C79000-G5272-C143

More information

The complete documentation is available in various languages for downloading free of charge:

<http://www.siemens.com/processanalytics/documentation>

Selection and ordering data

Description							2 years (quantity)	5 years (quantity)	Article No.
	7MB-2121	7MB-2123	7MB-2124	7MB-2111	7MB-2112	7MB-2111/2 Ex			
Analyzer unit									
O-ring for cover (window)	x	x	x	x	x	x	2	4	C79121-Z100-A24
Cover (cell length 20 ... 180 mm)	x	x	x	x	x	x	2	2	C79451-A3462-B151
Cover (cell length 0.2 ... 6 mm)	x	x	x	x	x	x	2	2	C79451-A3462-B152
O-rings, set	x	x	x	x	x	x		1	C79451-A3462-D501
Sample gas path									
O-ring (hose clip)				x	x	x	2	4	C71121-Z100-A159
Pressure switch	x	x	x				1	2	C79302-Z1210-A2
Flow indicator	x	x	x				1	2	C79402-Z560-T1
Hose clip	x	x	x	x	x	x		1	C79451-A3478-C9
Heating cartridge (heated unit)				x	x	x		1	W75083-A1004-F120
Electronics									
Temperature fuse (heated unit)				x	x			1	W75054-T1001-A150
Fuse (device fuse)						x	1	2	A5E00061505
Temperature controller - electronics, 230 V AC				x	x	x		1	A5E00118527
Temperature controller - electronics, 115 V AC				x	x	x		1	A5E00118530
Fan, 24 V DC (heated unit)				x	x	x		1	A5E00302916
Front plate with keyboard	x	x	x				1	1	C79165-A3042-B504
Temperature sensor				x	x	x		1	C79165-A3044-B176
Adapter plate, LCD/keyboard	x	x	x	x	x		1	1	C79451-A3474-B605
Motherboard, with firmware: see spare parts list	x	x	x	x	x	x		1	
LC display	x	x	x	x	x		1	1	A5E31474846
Connector filter	x	x	x	x	x			1	W75041-E5602-K2
Fusible element, T 0.63 A/250 V	x		x	x	x	x	2	3	W79054-L1010-T630
Fusible element, T 1 A/250 V	x	x	x	x	x	x	2	3	W79054-L1011-T100
Fusible element, T 1.6 A/250 V		x	x				2	3	W79054-L1011-T160
Fusible element, T 2.5 A/250 V				x	x	x	2	3	W79054-L1011-T250

If the ULTRAMAT 6 is supplied with a specially cleaned gas path for high oxygen content ("Cleaned for O₂ service"), please ensure that you specify this when ordering spare parts. This is the only way to guarantee that the gas path will continue to comply with the special requirements for this version.