

Extractive continuous process gas analysis

SIPROCESS UV600

1

Overview



The function of the SIPROCESS UV600 gas analyzer is based on UV resonance absorption spectrometry. It also is used to measure very low NO, NO₂, SO₂ or H₂S concentrations in gases.

Benefits

- For NO, NO₂, SO₂: Very low cross-sensitivity with other gases
- All modules are thermostatically-controlled, and thus independent of the ambient temperature
- Simultaneous measurement of NO and NO₂ with subsequent calculation of total. Therefore neither an NO₂ converter nor a CLD analyzer is required.
- Measurement in the UV range:
 - No cross-sensitivity with H₂O and CO₂
 - Very low SO₂ and NO measuring ranges possible
- UV resonance absorption spectrometry:
 - Measurement of very low NO concentrations
 - Very low cross-sensitivity possible
- Very long service life of UV lamp (usually 2 years)
- Low drifts and high stability thanks to four-channel measuring method with double generation of quotient
- True reference measurement for low-drift, stable results
- Interface for remote monitoring in networks and linking to process control systems
- Optional calibration unit
 - Filter wheel with calibration cells which can be automatically swung into the optical path
 - Low consumption of calibration gas
 - Manual or automatic calibration possible

Application

Fields of application

Emission measurements

- Measurement of low NO concentrations in power plants or gas turbines
- Monitoring of NO_x in denitrification plants by direct measurement of NO and NO₂, as well as summation to NO_x in the analyzer
- Efficient measurement in desulfurization plants
- Monitoring of very small SO₂ and NO concentrations
- Emission measurements in the paper and cellulose industries

Process monitoring

- Measurement of SO₂ in process gases in the paper and petrochemical industries
- Optimization of NO_x emissions in exhaust gas in the automotive industry

H₂S measurement

- In typical emission applications
- Taking account of possible cross-sensitivities (e.g. from mercaptan)"

Design

- 19" rack unit with 4 HU for installation
 - in hinged frame
 - in cabinets with or without telescopic rails
- Internal gas paths: hose made of FKM (Viton™) or pipe made of PTFE or stainless steel
- Gas connections for sample gas inlet and outlet and for reference gas: fittings, pipe diameter of 6 mm or ¼"

Display and control panel

- Large LCD panel for simultaneous display of measured value and device status
- Sensor buttons with context-based functions
- Display protected by glass pane
- Contrast of the LC display can be adjusted

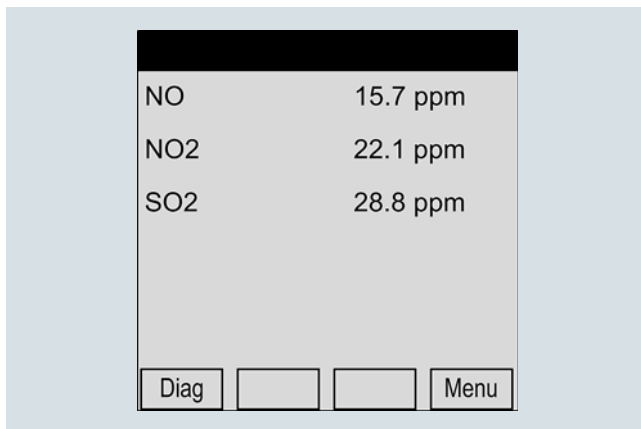

SIPROCESS UV600, display and control panel

Inputs and outputs

- 2 configurable analog inputs
- 4 configurable analog outputs
- 8 digital inputs
- 8 digital outputs

Communications

Connection via SIPROCESS-UV600-specific software tool

Materials wetted by sample gas

Component	Material
Analyzer unit (sample chamber)	Aluminum or stainless steel mat. no. 1.4404 ¹⁾ , epoxy resin
Optical window	CaF ₂ or quartz ¹⁾ , epoxy resin
Gas path, gaskets	FKM (Viton), PTFE, stainless steel mat. no. 1.4571 ¹⁾
Chamber	Aluminum or stainless steel ¹⁾
Gas inlet/outlet	PVDF, stainless steel, mat. no. 1.4401 ¹⁾
Moisture sensor	Stainless steel mat. no. 1.4571, platinum, epoxy resin
Diaphragm pump	
• Central body	PVDF
• Diaphragm	FKM (Viton), EPDM

¹⁾ Depending on the version

Gas flow chart

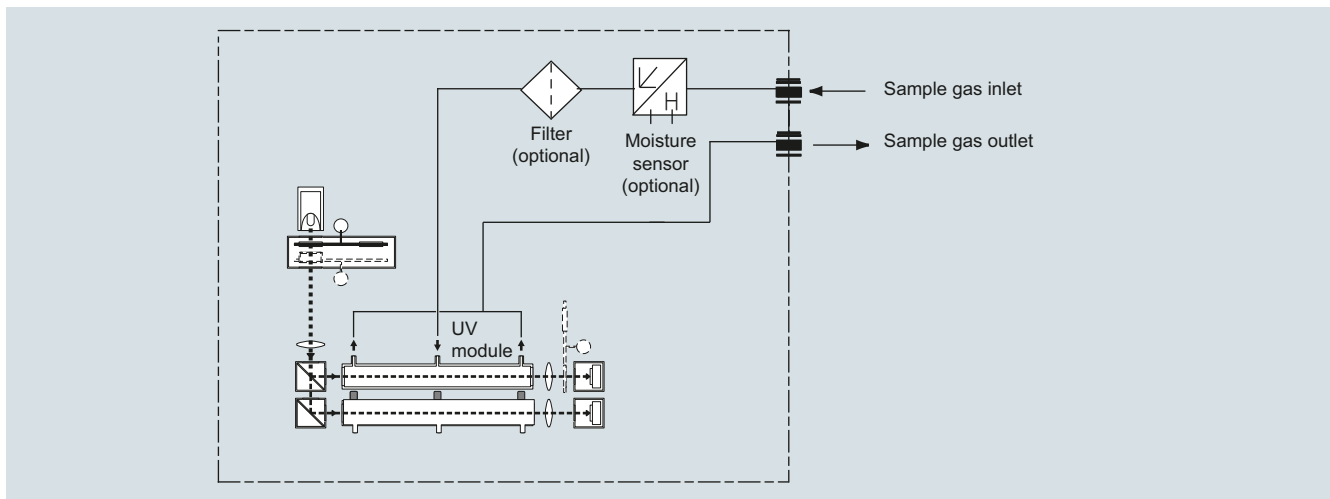

SIPROCESS UV600, gas flow chart

Extractive continuous process gas analysis

SIPROCESS UV600

1

Mode of operation

The measuring principle of the SIPROCESS UV600 is based on the molecule-specific absorption of gases in the ultraviolet wavelength range. Radiation of a wavelength appropriate to the measurement is passed through the sample, and the selective absorption which is proportional to the concentration of the measured component is determined.

Measuring method

An electrodeless discharge lamp (1) emits broadband in the ultraviolet spectral range. A filter wheel unit (2) generates the ultraviolet radiation suitable for the respective measured component. Either interference filter correlation (IFC) or gas filter correlation (GFC), or a combination of the two methods, can be used for this purpose.

Interference filter correlation (IFC)

The sample and reference radiations are generated alternately with two different interference filters being swung into the beam path (filter wheel 2a).

Gas filter correlation (GFC)

Especially when NO is the measured component, the reference radiation is generated by swinging in a gas filter which is filled with the associated gas (filter wheel 2b).

IFC and GFC

The two filter wheels are combined in order to measure NO in combination with other measured components.

Design of the UV analyzer module

After passing through the filter unit, the beam is directed via a lens (3), a beam divider (4) and a mirror (4) into the sample chamber (6) and reference chamber (7).

The sample beam passes through the sample chamber (6), into which sample gas flows, and its intensity is weakened in line with the concentration of the measured component. The reference beam is directed via a mirror (5) into the reference chamber (7). This is filled with a neutral gas.

The detectors (9) receive the sample and reference beams in succession. These measured signals are amplified and evaluated using electronics.

The measuring system is temperature-controlled to minimize external temperature influences.

The physical state of the measuring system is recorded simultaneously through time-offset detection of the reference beam, and compensated if necessary.

A quotient is generated for each detector from the determined signal values, and the ratio of these quotients determined. This double generation of quotients means that symmetrical signal drifts are compensated in the best possible manner in addition to proportional signal drifts.

Note

The sample gases must be fed into the analyzers free of dust. Condensation in the sample chambers must be prevented. Therefore, the use of gas modified for the measuring task is necessary in most application cases.

Additional measures depending on the application must be taken when introducing gases with flammable components at concentrations above the lower explosive limit (LEL). Please contact the technical department in such cases.

Function

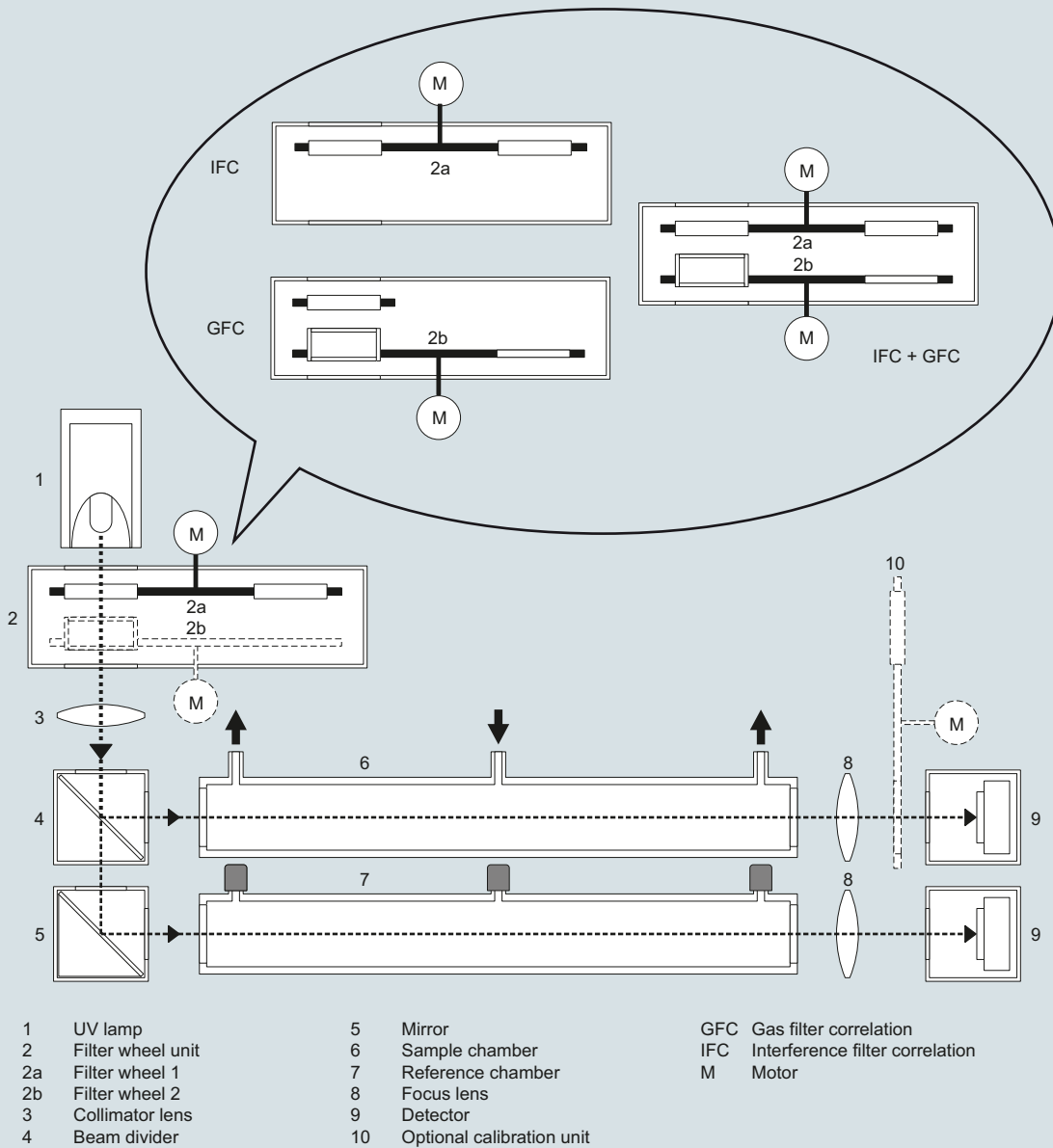

SIPROCESS UV600, operating principle

Extractive continuous process gas analysis



SIPROCESS UV600

1

Technical specifications

General information		Gas inlet conditions	
Measuring ranges	3, automatic measuring range switching	Permissible sample gas pressure	Relative to ambient/atmospheric air pressure: -200 ... +300 hPa (-0.2 ... +0.3 bar)
Detection limit (2σ)	< 1% of span	Sample gas flow	20 ... 120 l/h (333 ... 2 000 ml/min)
Smallest possible span	Dependent on order configuration NO: 0 ... 10 / 0 ... 20 / 0 ... 25 / 0 ... 50 vpm NO ₂ : 0 ... 10 ¹ / 0 ... 20 / 0 ... 25 / 0 ... 50 vpm SO ₂ : 0 ... 10 ¹ / 0 ... 20 / 0 ... 25 / 0 ... 50 vpm H ₂ S: 0 ... 25 / 0 ... 50 vpm	Sample gas temperature	5 ... 55 °C
Largest possible span	Dependent on order configuration NO, NO ₂ , SO ₂ : 0 ... 300 to 0 ... 1 000 vpm H ₂ S: 0 ... 500 to 0 ... 1 000 vpm	Measuring response	
UV lamp		Reference point drift	< ±1%/week of respective span
• Design	EDL, electrodeless discharge lamp	Zero point drift	
• Service life	≈ 2 years (17 500 h)	• Standard measuring ranges	< ± 1%/week of respective span
Conformity	CE mark	• Small measuring ranges (≤ 2x smallest measuring range)	< ± 2%/week of respective span
Design, enclosure		• Measured components NO, NO ₂ , SO ₂	< ± 1%/day of respective span
Degree of protection	IP40	Repeatability (reproducibility)	< ± 1% of respective span
Weight	approx. 17 kg	Linearity error	< ± 1% of respective span
Requirements of location of use		Electric inputs and outputs	
Installation location	Within closed building	Analog output	4, 0 ... 24 mA ; floating (electrically isolated), residual ripple 0.02 mA, resolution 0.1 % (20 μA), max. load 500 Ω, max. voltage ± 50 V
Atmospheric pressure in the environment	700 ... 1 200 hPa	Relay outputs	8, with changeover contacts, max. voltage ± 50 V loading capacity: Max. 30 V AC / max. 48 V DC / max. 500 mA
Relative humidity	10 ... 95 %, non-condensing	Analog inputs	2, 0 ... 20 mA, reference potential GND, max. signal strength 30 mA, max. overcurrent protection ± 1 A, max. voltage ± 50 V
Permissible contamination	Pollution degree 1	Digital inputs	8, switching range 14 ... 42 V (external control voltage), max. voltage ± 50 V
Maximum geographic altitude of location of use	2 500 m above sea level	Serial interface	RS485, Ethernet (LAN)
Permissible ambient temperature		1) Only for daily recalibration and air-conditioned environment (± 2 °C)	
• Operation	+5 ... +45 °C (41 ... 113 °F)		
• Transport and storage	-10 ... +70 °C (14 ... 158 °F)		
Operating position	Front wall, vertical , max. ± 15° angle for each spatial axis (maximum permissible inclination of the base surface during operation with constant operating position)		
Permissible vibrations/shocks			
• Vibration displacement	0.035 mm (in the range 5 ... 59 Hz)		
• Amplitude of the starting acceleration	5 m/s ² (in the range 59 ... 160 Hz)		
Electrical characteristics			
Line voltage (optional, see nameplate)	93 ... 132 V AC, 186 ... 264 V AC		
Line frequency (AC)	47 ... 63 Hz		
Permissible overvoltages (transient surges in the power supply network)	Up to overvoltage category II in accordance with IEC 60364-4-443		
Power consumption	Approx. 50 VA, max. 300 VA		
EMC interference immunity (electromagnetic compatibility)	In accordance with EN 61326-1, EN 61326-2-1, EN 61000-6-2, EN 61000-6-4 and EU Directive 2004/108/EC. In the case of electromagnetic radiation in the frequency range from 750 MHz ± 20 MHz, increased measuring errors can occur for small measuring ranges		
Electrical safety	In accordance with EN 61010-1		
Internal line fuses			
• primary	6.3 A, not replaceable		
• secondary	8 A		

Selection and ordering data

Product description			Article No.			
SIPROCESS UV600 gas analyzer, incl. gas module and barometric pressure compensation			7MB2621-		Cannot be combined	
						
Click on the Article No. for the online configuration in the PIA Life Cycle Portal.						
Enclosure, version and gas paths 19" rack unit for installation in cabinets						
<u>Gas connections</u>	<u>Gas connections</u>	<u>Gas paths</u>				
Diameter	Material	Material				
• 6 mm pipe	• PVDF	• Hose / Viton				
• 6 mm pipe	• Swagelok	• PTFE				
• 6 mm pipe	• Swagelok	• Stainless steel, with pipes				
• 1/4" pipe	• Swagelok	• Stainless steel, with pipes				
			0	0		
			1		1 → C15	
			2		2 → C15	
			3		3 → C15	
1. UV measured component						
<u>Measured component</u>	<u>Smallest/largest measuring range</u>	<u>corresponds to</u>				
NO	0 ... 10 / 0 ... 300 ppmv	0 ... 15 / 0 ... 450 mg/m ³	AA			AA → Y17
	0 ... 20 / 0 ... 400 ppmv	0 ... 25 / 0 ... 500 mg/m ³	AB			AB → Y17
	0 ... 25 / 0 ... 500 ppmv	0 ... 35 / 0 ... 700 mg/m ³	AC			AC → Y17
	0 ... 50 / 0 ... 1 000 ppmv	0 ... 70 / 0 ... 1 250 mg/m ³	AD			
NO ₂	0 ... 10 / 0 ... 300 ppmv ¹⁾	0 ... 20 / 0 ... 600 mg/m ³ ¹⁾	BA	BA	BA	BA → Y17
	0 ... 20 / 0 ... 400 ppmv	0 ... 40 / 0 ... 800 mg/m ³	BB	BB	BB	BB → Y17
	0 ... 25 / 0 ... 500 ppmv	0 ... 50 / 0 ... 1 000 mg/m ³	BC	BC	BC	
	0 ... 50 / 0 ... 1 000 ppmv	0 ... 100 / 0 ... 2 000 mg/m ³	BD	BD	BD	
SO ₂	0 ... 10 / 0 ... 300 ppmv ¹⁾	0 ... 25 / 0 ... 750 mg/m ³ ¹⁾	CA		CA	CA → Y17
	0 ... 20 / 0 ... 400 ppmv	0 ... 50 / 0 ... 1 000 mg/m ³	CB		CB	CB → Y17
	0 ... 25 / 0 ... 500 ppmv	0 ... 75 / 0 ... 1 500 mg/m ³	CC		CC	
	0 ... 50 / 0 ... 1 000 ppmv	0 ... 130 / 0 ... 2 600 mg/m ³	CD		CD	
H ₂ S	0 ... 25 / 0 ... 500 ppmv	0 ... 40 / 0 ... 800 mg/m ³	DC	DC	DC	DC → Y17
	0 ... 50 / 0 ... 1 000 ppmv	0 ... 75 / 0 ... 1 500 mg/m ³	DD	DD	DD	DD → Y17
2. UV measured component						
<u>Measured component</u>	<u>Smallest/largest measuring range</u>					
None			00	00		00 → B12
NO ₂	0 ... 10 / 0 ... 300 ppmv ¹⁾	0 ... 20 / 0 ... 600 mg/m ³ ¹⁾	21	21	21	21 → B11, Y17
	0 ... 20 / 0 ... 400 ppmv	0 ... 40 / 0 ... 800 mg/m ³	22	22	22	22 → B11, Y17
	0 ... 25 / 0 ... 500 ppmv	0 ... 50 / 0 ... 1 000 mg/m ³	23	23	23	23 → B11
	0 ... 50 / 0 ... 1 000 ppmv	0 ... 100 / 0 ... 2 000 mg/m ³	24	24	24	24 → B11
SO ₂	0 ... 10 / 0 ... 300 ppmv ¹⁾	0 ... 25 / 0 ... 750 mg/m ³ ¹⁾	31		31	31 → B11, Y17
	0 ... 20 / 0 ... 400 ppmv	0 ... 50 / 0 ... 1 000 mg/m ³	32		32	32 → B11, Y17
	0 ... 25 / 0 ... 500 ppmv	0 ... 75 / 0 ... 1 500 mg/m ³	33		33	33 → B11
	0 ... 50 / 0 ... 1 000 ppmv	0 ... 130 / 0 ... 2 600 mg/m ³	34		34	34 → B11
H ₂ S	0 ... 25 / 0 ... 500 ppmv	0 ... 40 / 0 ... 800 mg/m ³	43	43	43	43 → B11, Y17
	0 ... 50 / 0 ... 1 000 ppmv	0 ... 75 / 0 ... 1 500 mg/m ³	44	44	44	44 → B11, Y17
3. UV measured component						
<u>Measured component</u>	<u>Smallest/largest measuring range</u>					
None			XX			XX → B13
SO ₂	0 ... 10 / 0 ... 300 ppmv ¹⁾	0 ... 25 / 0 ... 750 mg/m ³ ¹⁾	CA	CA	CA	CA → B11, B12, Y17
	0 ... 20 / 0 ... 400 ppmv	0 ... 50 / 0 ... 1 000 mg/m ³	CB	CB	CB	CB → B11, B12, Y17
	0 ... 25 / 0 ... 500 ppmv	0 ... 75 / 0 ... 1 500 mg/m ³	CC	CC	CC	CC → B11, B12
	0 ... 50 / 0 ... 1 000 ppmv	0 ... 130 / 0 ... 2 600 mg/m ³	CD	CD	CD	CD → B11, B12
H ₂ S	0 ... 25 / 0 ... 500 ppmv	0 ... 40 / 0 ... 800 mg/m ³	DC	DC	DC	DC → B11, B12, Y17
	0 ... 50 / 0 ... 1 000 ppmv	0 ... 75 / 0 ... 1 500 mg/m ³	DD	DD	DD	DD → B11, B12, Y17
Language of software and documentation						
German			0			
English			1			
French			2			
Spanish			3			
Italian			4			

¹⁾ Smallest measuring range 0...10 ppmv requires daily calibration and temperature-controlled environment (± 2 °C). Use of an additional calibration unit (B11, B12 or B13) recommended. 2 measured-value outputs are required on the I/O module for this measurement range switchover. A maximum of 4 measured-value outputs are available per I/O module. For versions with 3 sample gas components - including more than 1 component with measuring range 0...10/0...300 vpm - a second I/O module (option: A13) is required!

Extractive continuous process gas analysis

SIPROCESS UV600

1

Product description			
Additional versions	Order code		
Please add "-Z" to Article No. and specify Order code.			
Second IO module	A13		
Calibration unit for 1st sample gas component	B11		
Calibration unit for 1st and 2nd sample gas components	B12		
Calibration unit for all 3 sample gas components	B13		
Flow monitor	C11		
Humidity monitor	C12		
Pressure sensor (sample gas)	C14		
Internal sample gas pump	C15		
Special setting (only in conjunction with an application no., e.g. special measuring range)	Y12		
Extended special setting (only in conjunction with an application no., e.g. determination of cross-interferences)	Y13		
Prepared for QAL1, standard measured-value output in mg/m ³	Y17		
Spare parts recommendation for preventative maintenance	Quantity for 2 years	Quantity for 5 years	Article No.
Article No.Safety filter FI64	1	2	A5E03707235
Power supply units, 24 V DC, 10 A		1	A5E03707236
Distribution board		1	A5E03707240
FKM hose d = 3/5, length = 1 m	2	5	A5E03707757
MEDL UV lamp with heater	1	1 ... 2	A5E03707918
Motor flange 3		1	A5E03707919
Motor flange 2		1	A5E03707920
Gas filter with holder, for measurement of NO	1	2	A5E03707921
SIPROCESS UV600 chamber H = 300 mm, aluminum		1	A5E03707925
Calibration chamber with holder for NO		1	A5E03707941
Calibration chamber with holder for SO ₂ and H ₂ S		1	A5E03707942
Calibration chamber with holder for NO ₂		1	A5E03707943
Heater with 380 mm long cable, for SIPROCESS UV600: MEDL, chamber, motor flange	1	2	A5E03707968
Moisture sensor	1	2	A5E41110446
Spare parts set - pressure sensor with gasket and O-ring		1	A5E03707970
Flow sensor with temperature sensor	1	2	A5E03707971
Diaphragm pump type 123, 24 V DC / 50 Hz		1	A5E03707986
Diaphragm assembly, EPDM for types 110-125	1	2	A5E03707987
O-ring for gas pump suspension	1	2	A5E03707988

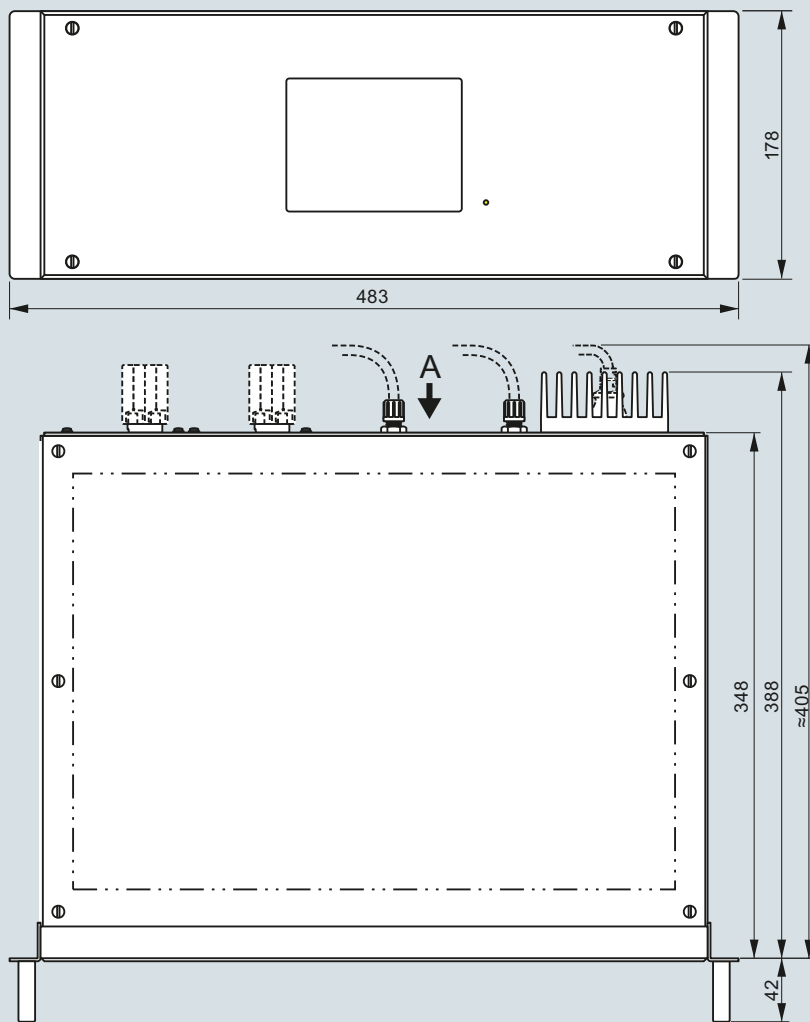
Dimensional drawings

SIPROCESS UV600, 19" rack unit, dimensions in mm

Extractive continuous process gas analysis

SIPROCESS UV600

1

Circuit diagrams

Electrical connections

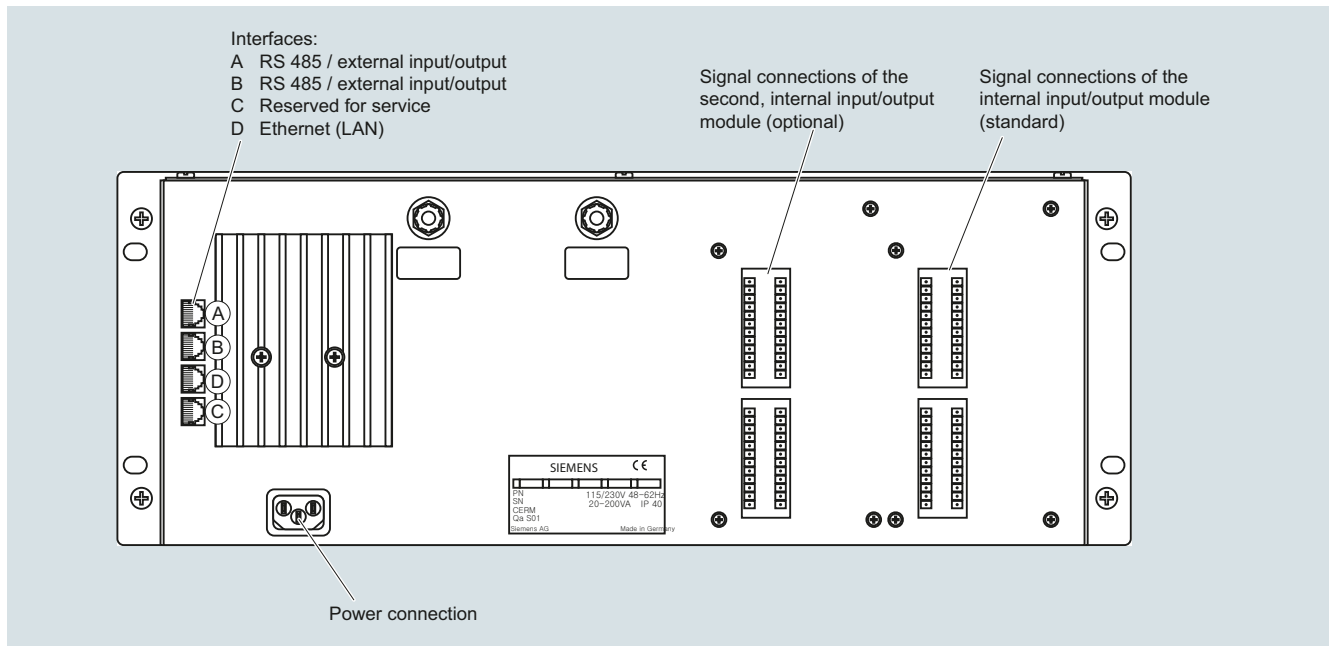

SIPROCESS UV600, gas connections and electrical connections

The SIPROCESS UV600 is supplied as standard with one or (optionally) two input/output modules. The logic function of the signal connections can be configured individually with the service and maintenance software specific to SIPROCESS UV600.

The signal connections are available at terminal strips X3, X4, X5 and X7 on the 12-pin plug connectors of the input/output modules. The scope of delivery includes the corresponding counterparts (plug connectors) with screw terminals.

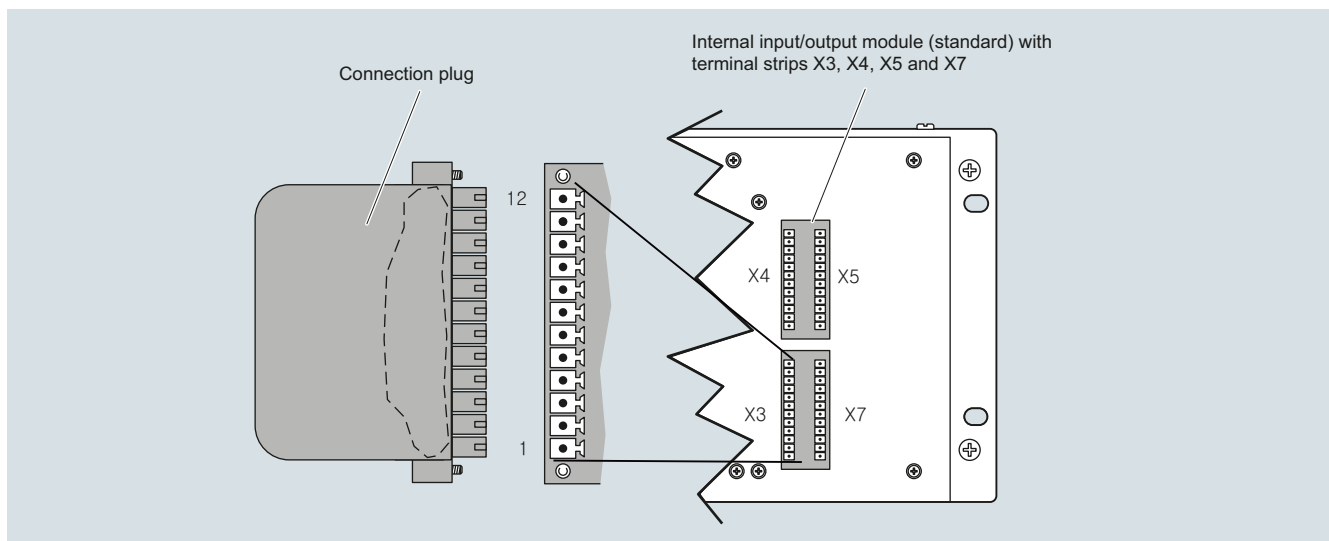

SIPROCESS UV600, signal connections and plug connectors

Pin assignments

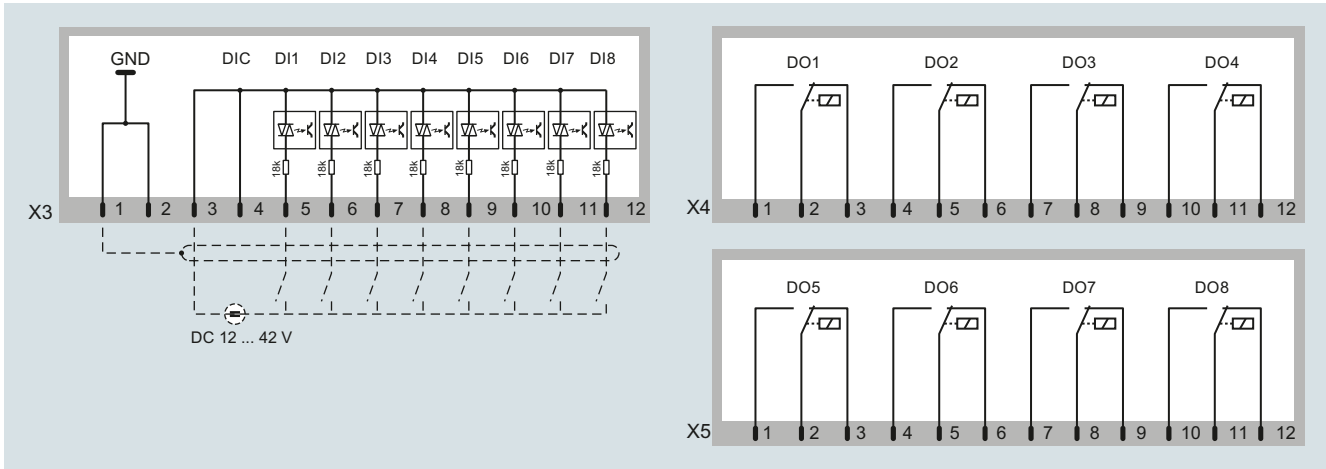

SIPROCESS UV600, pin assignments of digital inputs X3 (DI1 to DI8) and digital outputs X4 (DO1 to DO4) and X5 (DO5 to DO8)

Characteristics of the digital inputs:

- Floating optocouplers with common reference potential (DIC)
- Switching range 14 ... 42 V DC (external control voltage)
- The digital inputs can be operated either with positive or negative voltage
- With inverted switching logic, the logic function of the control input is active if no current is flowing through the control input
- Maximum voltage: ± 50 V

Characteristics of the digital outputs:

- Floating relay changeover contacts
- Single-pole changeover switch, three connections
- Maximum voltage: ± 50 V
- Connect inductive loads (e.g. relays, solenoid valves ...) via spark-quenching diodes only
- Maximum load-carrying capacity (standard): Max. 30 V AC, max. 48 V DC, max. 500 mA.

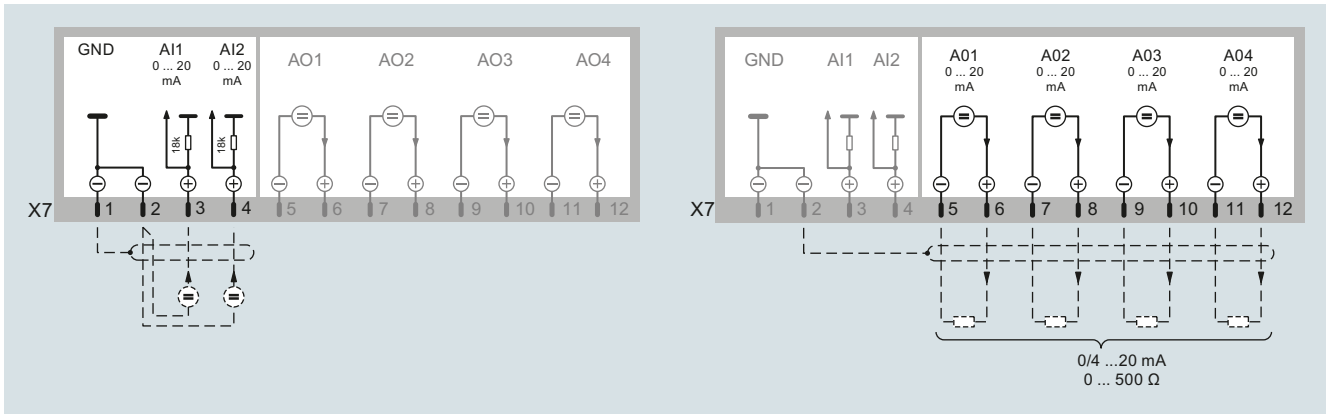

SIPROCESS UV600, pin assignment of the analog inputs X7 (AI1 and AI2) and analog outputs X7 (AO1 to AO4)

Characteristics of the analog inputs:

- The input signal is an analog current signal (standard 0 ... 20 mA, maximum 30 mA)
- The signal current must be provided by an external current source
- Load (internal resistance) of analog input: 10Ω
- Reference potential GND (see figure, analog inputs)
- Overcurrent protection: $\pm 1\,000$ mA
- Max. voltage: ± 50 V

Characteristics of the analog outputs:

- Analog outputs are floating (electrically isolated) and provide a load-independent current signal
- Signal range 0 ... 24 mA
- Residual ripple 0.02 mA
- Resolution 0.1%
- Accuracy 0.25% of full-scale value
- Maximum load 500Ω
- Maximum voltage ± 50 V
- Adjustable start or error state

Note for electrical isolation:

The electrical isolation is canceled if the negative poles of the analog outputs are connected to GND.