

Overview

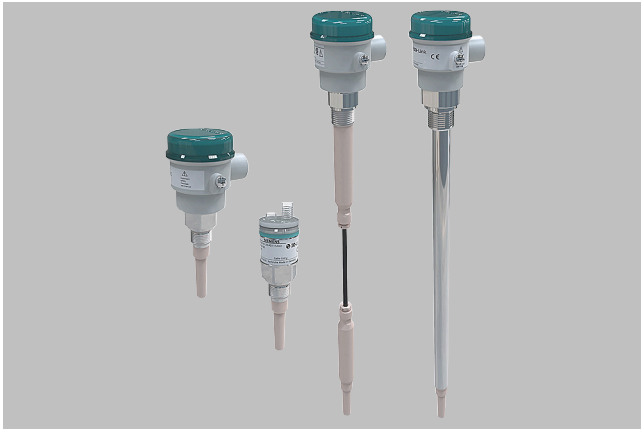

SITRANS LCS100 is a point level switch that detects point level in liquids, solids, slurries, foam, and interface detection. Its compact design is ideal for confined spaces with plastic or stainless steel process connections and flexible rod and cable probe extensions. SITRANS LCS100 is used for overflow, high, low, and demand applications as well as pump protection. It works in all types of vessels, pipes, and silos in a broad range of industries including food, pharmaceuticals, chemical, petrochemical, water, and machine building.

Benefits

- Potted construction provides protection from shock and vibration
- Factory calibrated to work in most applications without tuning
- Active shield and tunable to compensate for build-up
- Optional IO-link communication and remote testing
- Options for plastic or Stainless steel enclosure and M12 connection

Application

SITRANS LCS100's flexible insertion length, starting at 92 mm (3.6 inch), and its versatility in various applications and in vessels or pipes make it a good fit for most point level applications.

Its advanced design provides accurate, repeatable, switchpoint performance. The PPS (Polyphenylene sulfide) probe [optional PVDF (Polyvinylidene Fluoride)] and optional peek are chemically resistant with an effective process operating temperature range from -40 to +125 °C (-40 to +257 °F). The fully potted design ensures reliability in a vibrating environment such as agitated tanks. When used with a SensGuard protection cover, the LCS100 is protected from shearing, impact, and abrasion in tough primary processes.

The SITRANS LCS100 is available with either a stainless steel enclosure or a polyester enclosure and stainless steel or PPS process connection options.

- Key Applications: liquids, slurries, powders, granules, food and pharmaceuticals, chemicals, hazardous areas

Configuration

Probe distance

- Observe nozzle length (probe should lead into the product).
- Observe minimum distance between two probes, and to the metal vessel wall.

Correct

Probe leads into the product

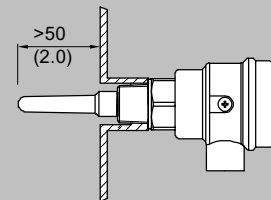

Wrong

Nozzel too long

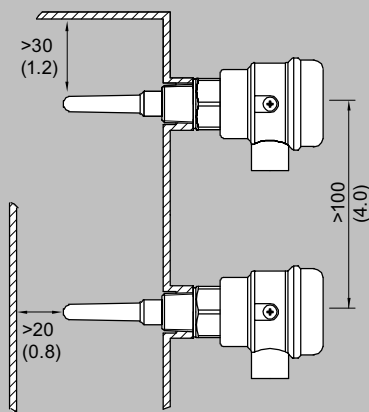
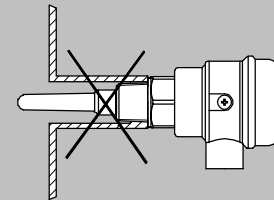

SITRANS LCS100 Installation, dimensions in mm (inch)

Selection and ordering data (continued)

		Article No.											
SITRANS LCS100 Point level switch Versatile, compact point level switch, detects level in liquids and solids. For use with overflow, high, low, and demand applications as well as pump protection. ideal for use in confined spaces with stainless steel process connections. Supports IO-link communications.		7	M	L	7	0	1	0	0	0	0	A	0
Click on the Article No. for the online configuration in the PIA Life Cycle Portal.													
Electronic													
2-wire (8/16 mA or 4 ... 20 mA), 4-wire relay (general purpose) or transistor (intrinsically safe)		1											
¾-wire, IO-Link, PNP, NPN, Push/Pull ¹⁾		2											
Process connection													
Thread G ½" DIN ISO 228-1, hygienic								A	A				
Thread G ½" DIN ISO 228-1								A	B				
Thread G ¾" DIN ISO 228-1								A	C				
Thread G 1" DIN ISO 228-1								A	D				
Thread NPT ¾" ASME B 1.20.1								A	E				
Tri-clamp DN25 (1") /DN40 (1 ½")DIN 32676 Type A (DIN 11851), DIN 32676 Type C (ASME BPE 2009)								A	F				
Tri-clamp DN50 (2") DIN 32676 Type A (DIN 11851), DIN 32676 Type C (ASME BPE 2009)								A	G				
Flange DN 25, PN 16/40 EN 1092-1 Type A flat faced ²⁾								A	H				
Flange DN 40, PN 16/40 EN 1092-1 Type A flat faced ²⁾								A	J				
Flange DN 50, PN 16/25/40 EN 1092-1 Type A flat faced ²⁾								A	K				
Flange 1" 150 lb ASME B16.5, raised face ²⁾								A	L				
Flange 1" 300 lb ASME B16.5, raised face ²⁾								A	M				
Flange 1 ½" 150 lb ASME B16.5, raised face ²⁾								A	N				
Flange 1 ½" 300 lb ASME B16.5, raised face ²⁾								A	P				
Flange 2" 150 lb ASME B16.5, raised face ²⁾								A	Q				
Flange 2" 300 lb ASME B16.5, raised face ²⁾								A	R				
Material of sensor													
PPS ³⁾									1				
PVDF ³⁾									2				
PEEK ⁴⁾									3				
Material of process connection													
1.4404 (316L)									3				
Enclosure													
Enclosure Ø65 mm (2.56 inch), internal terminal block, cable gland M20 x 1.5 (attached)											1		
Enclosure Ø65 mm (2.56 inch), internal terminal block, conduit NPT ½"											2		
Enclosure Ø65 mm (2.56 inch), M12-plug (mounted in M20 x 1.5) ¹⁾											3		
Enclosure Ø35 mm (1.38 inch), M12-plug ⁵⁾											4		
Approvals													
Ordinary Locations/General Purpose (Non-Ex): CE, UKCA												A	
Ordinary Locations/General Purpose (Non-Ex): CE, UKCA, FM, CSA												B	
ATEX II 1G Ex ia IIC T* Ga, IECEX Ex ia IIC T* Ga;												C	
ATEX II 1/2G Ex ia IIC T* Ga/Gb, IECEX Ex ia IIC T* Ga/Gb;													
ATEX II 1/2D Ex ia IIC T ₂₀₀ * Da/Db, IECEX Ex ia IIC T ₂₀₀ * Da/Db													
FM/CSA IS Cl. I, II, III Div. 1 Gr. A-G													D

Selection and ordering data (continued)

		Article No.												
SITRANS LCS100 Point level switch Rod extended, versatile point level switch, detects level in liquids and solids. For use with overflow, high, low, and demand applications as well as pump protection. Supports IO-link communications.		7ML702	●	-	●	●	●	●	●	-	●	●	A	0
Material of process connection and extension											1			
Enclosure													1	
Enclosure Ø65 mm (2.56 inch), internal terminal block, cable gland M20 x 1.5 (attached)													2	
Enclosure Ø65 mm (2.56 inch), internal terminal block, conduit NPT ½"													3	
Enclosure Ø65 mm (2.56 inch), M12-plug (mounted in M20 x 1.5) ²⁾														
Approvals														
Ordinary Locations/General Purpose (Non-Ex): CE, UKCA													A	
Ordinary Locations/General Purpose (Non-Ex): CE, UKCA, FM, CSA													B	
ATEX II 1G Ex ia IIC T* Ga, IECEx Ex ia IIC T* Ga;													C	
ATEX II 1/2G Ex ia IIC T* Ga/Gb, IECEx Ex ia IIC T* Ga/Gb;														
ATEX II 1/2D Ex ia IIIC T ₂₀₀ * Da/Db, IECEx Ex ia IIIC T ₂₀₀ * Da/Db														
FM/CSA IS Cl. I, II, III Div.1 Gr. A-G													D	

Selection and ordering data	
Further designs	
Please add "-Z" to Order No. and specify Order code(s).	
Total insertion length	Y01
Custom insertion length: enter total length, min. 301 mm (11.85 inch), max. 4 000 mm (157.48 inch). Specify in plain text.	
Sliding sleeve [max.process pressure -1 ... 10 bar (-14 ... 146 psi)]⁴⁾⁵⁾	
Sliding sleeve G1 ¼", DIN ISO 228-1 1.4404 (316L)	P12
Sliding sleeve G1 ½", DIN ISO 228-1 1.4404 (316L)	P13
Sliding sleeve NPT1 ¼", ASME B 1.20.1 1.4404 (316L)	P14
Sliding sleeve NPT1 ½", ASME B 1.20.1 1.4404 (316L)	P15
Stainless steel tag [70 x 13 mm (2.76 x 0.51 inch)]:	
Tag (max. 27 characters), plate, stainless steel 304/1.4301	Y17
Wetted seals	
FFKM seal O-ring ⁶⁾	A22

Selection and ordering data	
Test certificates	
Declaration of compliance 2.1 (EN 10204) - delivery meets order requirements	C19
Inspection certificate 3.1 (EN 10204) - material of pressure-containing and wetted parts	C12
Approvals¹⁾ and certificates	
INMETRO Ex-Approval ⁸⁾	E25
WHG/VLAREM Overfill and Leakage certificate	E61
Operating instructions	
All literature is available to download for free, in a range of languages, at http://www.siemens.com/processinstrumentation/documentation .	

- 1) With Ex-approvals intrinsically safe: Electronic connection ONLY with 2-wire.
- 2) Available only with Approvals options A and B.
- 3) Flange is screwed to process connection.
- 4) Process connection of the unit is ¾" (Process connection options AC or AE). Sliding sleeve has process connections as selected in this position.
- 5) Minimum extension length for sliding sleeve: 500 mm (19.69 inch).
- 6) Ambient and process temperatures are limited to -20 °C (-4 °F).
- 7) Max. process pressure: -1 ... +25 bar (-15 ... 363 psi).
- 8) Available only with Approvals option C; specific INMETRO Ex-marking.

		Article No.												
SITRANS LCS100 Point level switch Cable extended, versatile point level switch, detects level in liquids and solids. For use with overflow, high, low, and demand applications as well as pump protection. Supports IO-link communications.		7ML703	●	-	●	●	●	●	●	-	●	●	A	0
Click on the Article No. for the online configuration in the PIA Life Cycle Portal.														
Electronic														
2-wire (8/16 mA or 4 ... 20 mA), 4-wire relay (general purpose) ¹⁾													1	

SITRANS LCS100

Selection and ordering data (continued)

		Article No.										
SITRANS LCS100 Point level switch Cable extended, versatile point level switch, detects level in liquids and solids. For use with overflow, high, low, and demand applications as well as pump protection. Supports IO-link communications.		7	M	L	7	0	3	-	0	0	A	0
Extension length												
Fix extension 500 mm (19.69 inch)											0	
Fix extension 1 000 mm (39.37 inch) ²⁾											1	
Fix extension 1 500 mm (59.06 inch) ²⁾											2	
Fix extension 2 000 mm (78.74 inch) ²⁾											3	
Add order code Y01 and plain text: "Insertion length ... mm"												
501 ... 1 000 mm (19.72 ... 39.37 inch) ³⁾											4	
1 001 ... 5 000 mm (39.41 ... 196.85 inch) ³⁾											5	
5 001 ... 10 000 mm (39.41 ... 196.85 inch)											6	
10 001 ... 15 000 mm (196.89 ... 393.70 inch)											7	
15 001 ... 20 000 mm (590.59 ... 787.40 inch)											8	
Process connection												
Thread G 3/8" DIN ISO 228-1								A	C			
Thread G 1" DIN ISO 228-1								A	D			
Thread NPT 3/4" ASME B 1.20.1								A	E			
Flange DN 25, PN 16/40 EN 1092-1 type A flat faced ⁴⁾								A	H			
Flange DN 40, PN 16/40 EN 1092-1 type A flat faced ⁴⁾								A	J			
Flange DN 50, PN 16/25/40 EN 1092-1 type A flat faced ⁴⁾								A	K			
Flange 1" 150 lb ASME B16.5, raised face ⁴⁾								A	L			
Flange 1 1/2" 150 lb ASME B16.5, raised face ⁴⁾								A	N			
Flange 2" 150 lb ASME B16.5, raised face ⁴⁾								A	Q			
Material of sensor												
PPS											1	
Material of process connection and extension												
PPS, extension cable FEP, extension cable fixing PPS ⁵⁾											1	
1.4404 (316L), extension cable FEP, extension cable fixing PPS											3	
Enclosure												
Enclosure Ø65 mm (2.56 inch), internal terminal block, cable gland M20 x 1.5 (attached)											1	
Enclosure Ø65 mm (2.56 inch), internal terminal block, conduit NPT 1/2"											2	
Enclosure Ø65 mm (2.56 inch), M12-plug (mounted in M20 x 1.5) ⁶⁾											3	
Approvals												
Ordinary Locations/General Purpose (Non-Ex): CE, UKCA												A
Ordinary Locations/General Purpose (Non-Ex): CE, UKCA, FM, CSA												B
ATEX II 1G Ex ia IIC T* Ga, IECEX Ex ia IIC T* Ga;												C
ATEX II 1/2G Ex ia IIC T* Ga/Gb, IECEX Ex ia IIC T* Ga/Gb												
FM/CSA IS Cl. I Div.1 Gr. A-D												D

Selection and ordering data	
Further designs	
Please add "-Z" to Order No. and specify Order code(s).	
Total insertion length	
Custom insertion length: enter total length, min. 501 mm (19.72 inch), max. 20 000 mm (787.40 inch). Specify in plain text.	Y01
Stainless steel tag [70 x 13 mm (2.76 x 0.51 inch)]:	
Tag (max. 27 characters), plate, stainless steel 304/1.4301	Y17

Selection and ordering data	
Wetted seals	
FFKM seal O-ring ⁷⁾	A22
Test certificates	
Declaration of compliance 2.1 (EN 10204) - delivery meets order requirements	C19
Inspection certificate 3.1 (EN 10204) - material of pressure-containing and wetted parts	C12
Approvals and Certificates	
INMETRO Ex-Approval ⁹⁾	E25
WHG/VLAREM Overfill and Leakage certificate	E61

Selection and ordering data (continued)**Selection and ordering data****Operating instructions**

All literature is available to download for free, in a range of languages, at <http://www.siemens.com/processinstrumentation/documentation>.

- 1) With Ex-approvals intrinsically safe: Electronic connection ONLY with 2-wire.
- 2) Length can be shortened by customer with use of the Shortening kit for extension cable, found in Accessories.
- 3) Can be used with Shortening kit for extension cable, found in Accessories.

- 4) Flange is screwed to process connection.
- 5) Available only with Process connection option AD, with Thread G1" and option AE, Thread NPT ¾".
- 6) Available with Approval options A and B only.
- 7) Ambient and process temperatures are limited to -20 °C (-4 °F).
- 8) Max. process pressure: -1 ... +25 bar (-15 ... 363 psi).
- 9) Available only with Approvals option C; specific INMETRO Ex-marking.

SITRANS LCS100

Technical specifications

	Compact (7ML701 and 7ML700)	Extended (7ML702 and 7ML703)
Mode of Operation		
Measuring principle	Capacitive level detection	Capacitive level detection
Input		
Measured variable	Change in pF (pF)	Change in pF (pF)
Output		
Output signal		
• Alarm output	8/16 mA or 4 ... 20 mA, 2-wire loop or IO-Link, PNP, NPN	8/16 mA or 4 ... 20 mA, 2-wire loop or IO-Link, PNP, NPN *IO-Link not available with Cable version
• Switch output	4-wire relay (general purpose) or transistor (intrinsically safe)	4-wire relay (general purpose) or transistor (intrinsically safe)
• Fail-safe mode	Min. or max.	Min. or max.
Accuracy		
Repeatability	2 mm (0.08 inch)	2 mm (0.08 inch)
Rated operating conditions¹⁾		
Installation conditions		
• Location	Indoor and outdoor	Indoor and outdoor
Ambient conditions		
• Ambient temperature	-40 ... +85 °C (-40 ... +185 °F)	-40 ... +85 °C (-40 ... +185 °F)
• Storage temperature	-40 ... +80 °C (-40 ... +176 °F)	-40 ... +80 °C (-40 ... +176 °F)
• Installation category	I	I
• Pollution degree	4	4
Medium conditions		
• Relative dielectric constant ϵ_r	Min. 1.5	Min. 1.5
• Process temperature – configuration dependent	-40 ... +125 °C (-40 ... +257 °F), see temperature curve	-40 ... +125 °C (-40 ... +257 °F), see temperature curve
• Pressure (vessel) – configuration dependent	-1 ... 25 bar (363 psi) – Stainless Process connection -1 ... 10 bar (146 psi) – PPS process connection	-1 ... 25 bar (363 psi) - Rod extensions -1 ... 10 bar (146 psi) - Cable extensions
• Degree of protection		
- Enclosure Ø65 mm	Type 4X/IP68	Type 4X/IP68
- Enclosure Ø35 mm	Type 4X/IP68	Not applicable
• Cable inlet	½" NPT or M20 x 1.5	½" NPT or M20 x 1.5
Device version		
Material		
• Body (enclosure version)	Thermoplastic polyester	Thermoplastic polyester
• Lid (enclosure version)	Transparent thermoplastic polycarbonate (PC)	Transparent thermoplastic polycarbonate (PC)
• Enclosure Ø35 mm	316L stainless steel	Not applicable
Sensor length (nominal)	92 mm (3.6 inch)	300 ... 4 000 mm (11.8 ... 157 inch) - Rod version 400 ... 20 000 mm (15.7 ... 787 inch) - Cable version

Technical specifications (continued)

	Compact (7ML701 and 7ML700)	Extended (7ML702 and 7ML703)
Process connection material of probe/wetted parts ²⁾	Connection: 316L stainless steel or PPS; Process seal: FKM (optional FFKM); Sensor: PEEK or PPS or PVDF	Connection: 316L stainless steel or PPS; Process seal: FKM (optional FFKM); Sensor: PPS or PVDF Extension: Pipe 316L Cable: FEP jacketed
Connection (Enclosure 65 mm)	Terminal block, terminals 0.14 ... 1.5 mm ² (AWG 28 ... 16) or M12 x 1 according to IEC 61076-2-101, male, 4-pole, coding A-standard	Terminal block, terminals 0.14 ... 1.5 mm ² (AWG 28 ... 16) or M12 x 1 according to IEC 61076-2-101, male, 4-pole, coding A-standard
Connection (Enclosure 35 mm)	M12 x 1 according to IEC 61076-2-101, male, 4-pole, coding A-standard	Not applicable
Process connection	Thread: G ½", G ¾", G 1", NPT ¾" Tri-clamp DN25 (1"), DN40 (1 1/2"), DN50 (2") DIN 32676 Type A (DIN 11851) and DIN 32676 Type C (ASME BPE 2009) Flange (screwed) DN 25, 40, 50; ASME 1", 1 ½", 2"	Thread: G ¾", G 1", NPT ¾" Flange: DN 25, 40, 50; ASME 1", 1 ½", 2" Adapters for G 1 ½", NPT 1 ¼", NPT 1 ½"
Power supply		
Standard	<ul style="list-style-type: none"> 4-wire with relay supply: 9 ... 33 V DC, 0.7W including 10 % of EN 61010-1 2-wire with 8/16 or 4 ... 20 mA loop: 9 ... 33 V DC, 0.7W including 10 % of EN 61010-1 IO-Link / PNP / NPN 10 ... 30 V DC, incl. 10 % of EN 61010-1 	<ul style="list-style-type: none"> 4-wire with relay supply: 9 ... 33 V DC, 0.7W including 10 % of EN 61010-1 2-wire with 8/16 or 4 ... 20 mA loop: 9 ... 33 V DC, 0.7W including 10 % of EN 61010-1 IO-Link / PNP / NPN 10 ... 30 V DC, incl. 10 % of EN 61010-1
Intrinsically Safe	<ul style="list-style-type: none"> 2-wire with 8/16 or 4 ... 20 mA loop: 10.8 ... 30 V DC, 0.7W incl. 10 % of EN 61010-1, intrinsically safe barrier required 4-wire with relay: 10.8 ... 30 V DC, 0.7W incl. 10 % of EN 61010-1, intrinsically safe barrier required 	<ul style="list-style-type: none"> 2-wire with 8/16 or 4 ... 20 mA loop: 10.8 ... 30 V DC, 0.7W incl. 10 % of EN 61010-1, intrinsically safe barrier required
Certificates and approvals	<ul style="list-style-type: none"> General purpose: CE, UKCA, FM, CSA ATEX II 1G, 1/2G Ex ia IIC ATEX II 1D, 1/2D Ex ia IIIC IEC Ex ia IIC IEC Ex ia IIIC FM/CSA IS Class I, II, III, Div. 1, Groups A ... G Overfill protection: WHG (Germany) VLAREM 	<ul style="list-style-type: none"> General purpose: CE, UKCA, FM, CSA ATEX II 1G, 1/2G Ex ia IIC ATEX II 1D, 1/2D Ex ia IIIC IEC Ex ia IIC IEC Ex ia IIIC FM/CSA IS Class I, II, III, Div. 1, Groups A ... G Overfill protection: WHG (Germany) VLAREM

- ¹⁾ When operation is in areas classified as hazardous, observe restrictions according to relevant certificate. See also Pressure/Temperature curves.
²⁾ For caustic materials, consult a local sales person for alternative O-rings. For more information, please visit http://www.automation.siemens.com/asp_app.

Characteristic curves

Ambient and process temperature (Non-Ex version)

Mounting with short socket

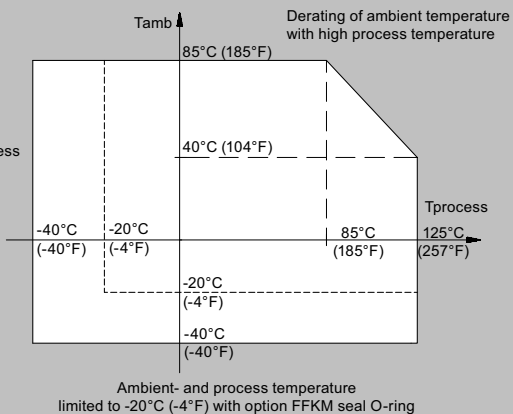
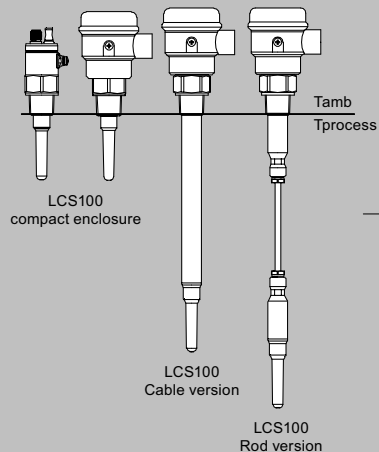

Mounting with long socket

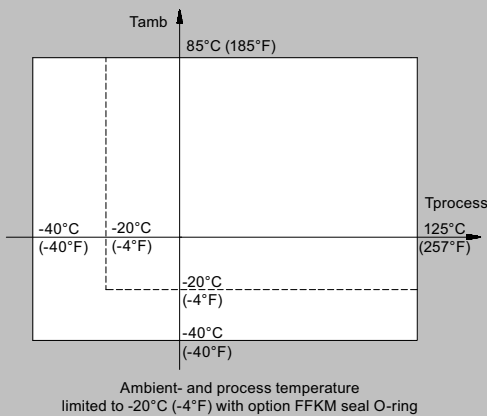
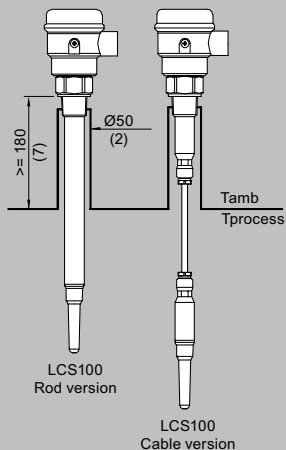

SITRANS LCS100 Ambient and process temperature, dimensions in mm (inch)

SITRANS LCS100

Dimensional drawings

Compact version: Stainless steel process connection, enclosure Ø65 mm (2.56 inch)

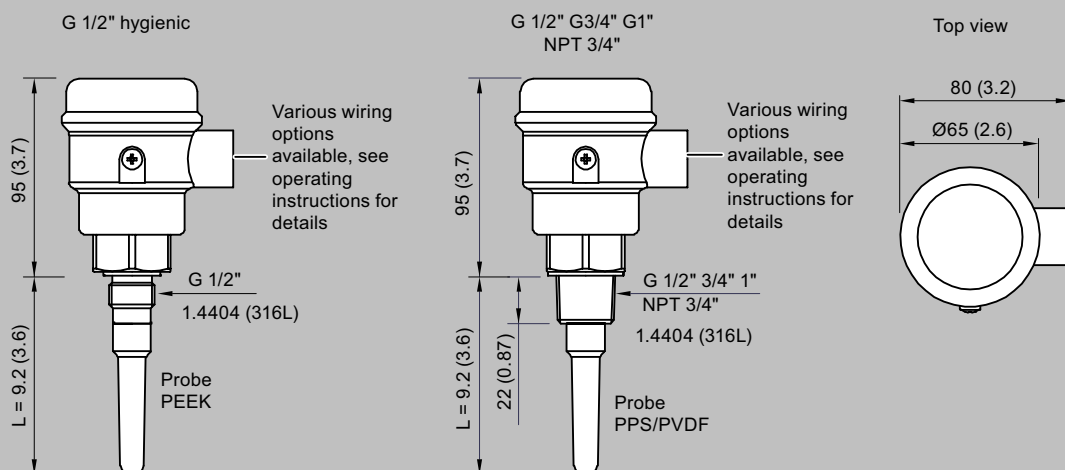

Note: Short extension length version with stainless steel process connection are available with certificate EHEDG EL class I

Compact version: Stainless steel process connection, enclosure Ø35 mm (1.38 inch)

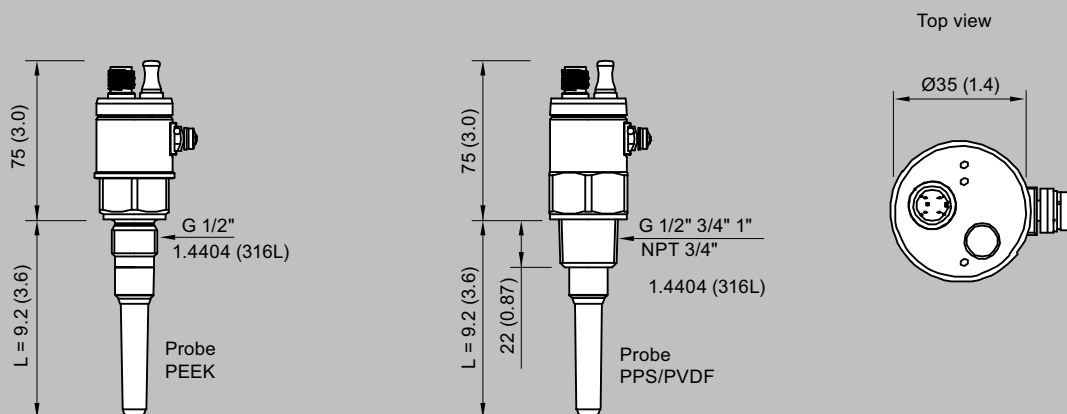

Note: Short extension length version with stainless steel process connection are available with certificate EHEDG EL class I

SITRANS LCS100, Compact stainless steel, dimensions in mm (inch)

Dimensional drawings (continued)

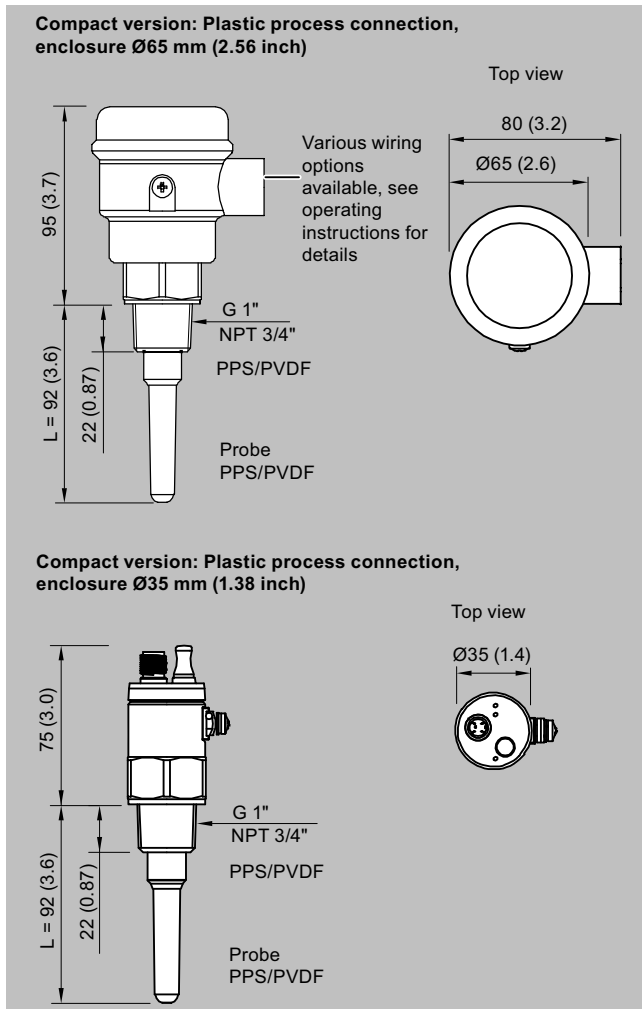

SITRANS LCS100, Compact with plastic process connection, dimensions in mm (inch)

SITRANS LCS100

Dimensional drawings (continued)

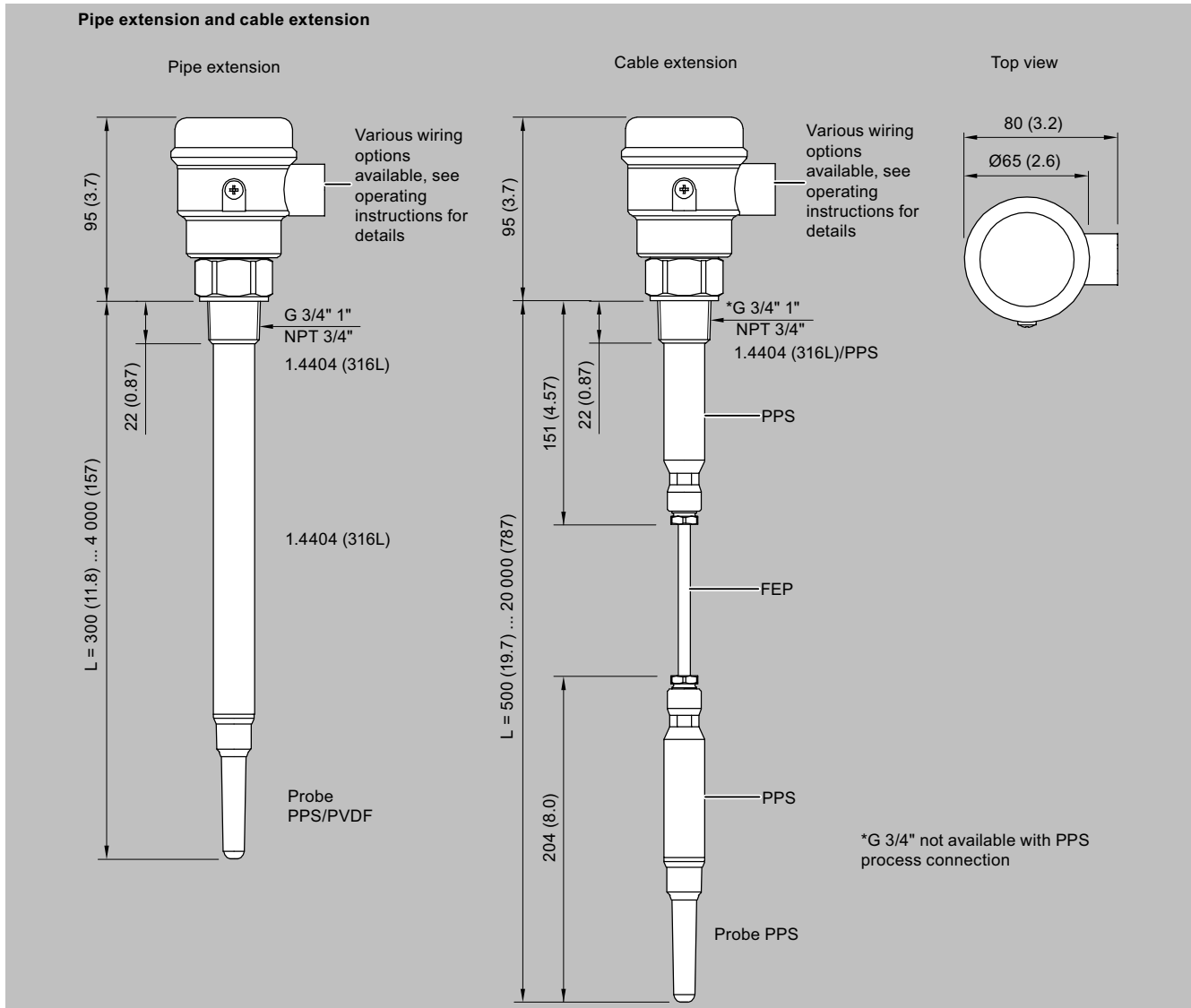

SITRANS LCS100, Pipe and cable extension, dimensions in mm (inch)

Circuit diagrams

2-wire operation with 8/16 mA loop

8/16 mA loop: 9 .. 33 V DC,
0,7W incl. 10% of EN 61010-1

External resistor in loop: The
above stated voltage is the
resulting voltage on the unit.
Any voltage drop on an external
series resistance must be
considered.

$$R_{\max} = (V_{\text{supply}} - 9 \text{ V}) / 16 \text{ mA}$$

Example: 24 V supply allows
R_{max} of 938 Ohms

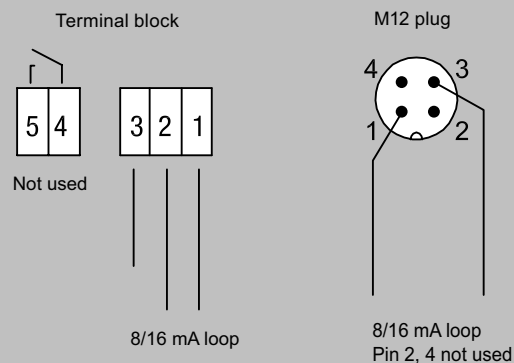
**4-wire operation with DC supply and relay (signal output)**

Power supply: 9 .. 33 V DC,
0,7W incl. 10% of EN 61010-1

Signal output: Floating relay SPST

Max. 60 V DC or 30 V AC; Limited to
35 V DC or 16 V AC in wet locations
Max. 1 A, 60 W

External fuse: max.1A, fast or
slow, HBC, 250V

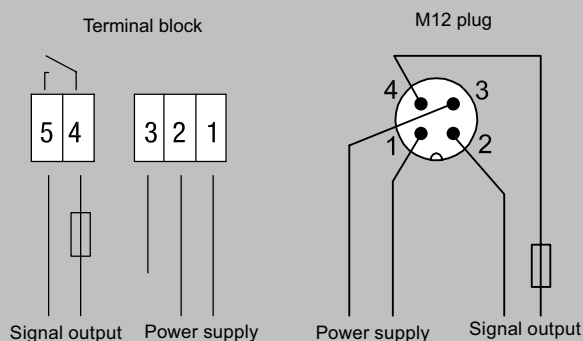

SITRANS LCS100, Standard connections

SITRANS LCS100

Circuit diagrams (continued)

Intrinsically safe version: 2-wire operation with 8/16 mA loop

8/16 mA loop: 10.8 .. 30 V DC,
0,7W incl. 10% of EN 61010-1

Intrinsically safe supply required
(barrier or signal conditioning
instruments): $U_i=30\text{ V}$ $I_i=160\text{ mA}$
 $P_i=0,8\text{ W}$, $C_i=7,6\text{ nF}$ $L_i=0,3\text{ mH}$

External resistor in loop: The above
stated voltage is the resulting voltage on the unit.
Any voltage drop on an external series resistance
must be considered.

$$R_{\max} = (V_{\text{supply}} - 10.8\text{ V}) / 16\text{ mA}$$

Example: 24 V supply allows
 R_{\max} of 825 Ohms

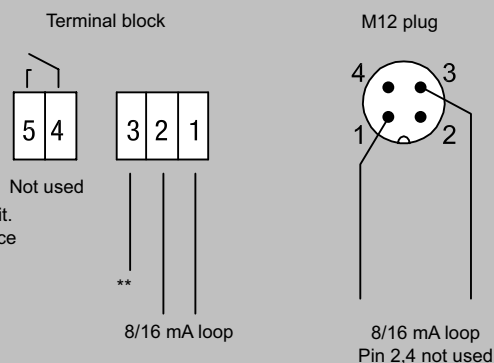
**Intrinsically safe version: 4-wire operation with DC supply and solid state relay (signal output)**

This operation is only available for LCS100 compact
with enclosure $\varnothing 65\text{ mm}$ (2.56 inch) and connection via
terminal block (Solid state relay integrated).

Power supply: 10.8 .. 30 V DC, 0,7W incl. 10% of
EN 61010-1

Intrinsically safe barrier required: $U_i=30\text{ V}$ $I_i=160\text{ mA}$
 $P_i=0,8\text{ W}$, $C_i=7,6\text{ nF}$ $L_i=0,3\text{ mH}$

Signal output: Solid state relay

Max. switching voltage / current: 30 V DC / 82mA

For connection to an intrinsically safe "switch amplifier
for contact input" or to an intrinsically safe PLC
with integrated input card for contact input.
 $U_i=30\text{ V}$ $I_i=200\text{ mA}$ $P_i=350\text{ mW}$, $C_i=4,2\text{ nF}$, $L_i=0$

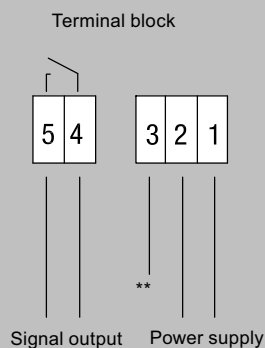

SITRANS LCS100, Intrinsically safe connections