

SIEMENS



SIMATIC

S7-1200

SM 1238 Energy Meter 480VAC (6ES7238-5XA32-0XB0)

Manual

Edition

01/2019

Answers for industry.

SIEMENS

SIMATIC

S7-1200 SM 1238 Energy Meter 480VAC (6ES7238-5XA32-0XB0)



Manual

Preface	
Documentation guide	1
Product overview	2
Wiring	3
Configure I/O address space	4
Quick start	5
Reading and processing measured values	6
Energy counters	7
Operating hours counter	8
Minimum and maximum values	9
Phase-based measurements	10
Configuration with the TIA Portal	11
Status LEDs and diagnostic interrupt alarms	12
Technical specifications	13
Module configuration data record (DS 128)	A
Measured variables	B
Module version configuration options	C
Process data variant options	D
Measured value data records	E
Tips and tricks	F
Embedded software license	G

Legal information

Warning notice system

This manual contains notices you have to observe in order to ensure your personal safety, as well as to prevent damage to property. The notices referring to your personal safety are highlighted in the manual by a safety alert symbol, notices referring only to property damage have no safety alert symbol. These notices shown below are graded according to the degree of danger.

 DANGER
indicates that death or severe personal injury will result if proper precautions are not taken.
 WARNING
indicates that death or severe personal injury may result if proper precautions are not taken.
 CAUTION
indicates that minor personal injury can result if proper precautions are not taken.
NOTICE
indicates that property damage can result if proper precautions are not taken.

If more than one degree of danger is present, the warning notice representing the highest degree of danger will be used. A notice warning of injury to persons with a safety alert symbol may also include a warning relating to property damage.

Qualified Personnel

The product/system described in this documentation may be operated only by **personnel qualified** for the specific task in accordance with the relevant documentation, in particular its warning notices and safety instructions. Qualified personnel are those who, based on their training and experience, are capable of identifying risks and avoiding potential hazards when working with these products/systems.

Proper use of Siemens products

Note the following:

 WARNING
Siemens products may only be used for the applications described in the catalog and in the relevant technical documentation. If products and components from other manufacturers are used, these must be recommended or approved by Siemens. Proper transport, storage, installation, assembly, commissioning, operation and maintenance are required to ensure that the products operate safely and without any problems. The permissible ambient conditions must be complied with. The information in the relevant documentation must be observed.

Trademarks

All names identified by ® are registered trademarks of Siemens AG. The remaining trademarks in this publication may be trademarks whose use by third parties for their own purposes could violate the rights of the owner.

Disclaimer of Liability

We have reviewed the contents of this publication to ensure consistency with the hardware and software described. Since variance cannot be precluded entirely, we cannot guarantee full consistency. However, the information in this publication is reviewed regularly and any necessary corrections are included in subsequent editions.

Preface

Purpose of the documentation

This SM 1238 Energy Meter 480VAC (6ES7238-5XA32-0XB0) device manual complements the system manual for the S7-1200 Programmable controller (<https://support.industry.siemens.com/cs/ww/en/view/107623221>). Functions that generally apply to the PLC system are described in the S7-1200 system manual.

This manual and the system manual provide the technical information necessary to develop and commission energy metering automation.

Conventions

Please also observe notes marked as follows:

Note

A note contains important information on the product described in the documentation, on the handling of the product, and identifies parts of the documentation that are important to understand.

Security information

Siemens provides products and solutions with industrial security functions that support the secure operation of plants, systems, machines and networks.

In order to protect plants, systems, machines and networks against cyber threats, it is necessary to implement – and continuously maintain – a holistic, state-of-the-art industrial security concept. Siemens' products and solutions constitute one element of such a concept.

Customers are responsible for preventing unauthorized access to their plants, systems, machines and networks. Such systems, machines and components should only be connected to an enterprise network or the internet if and to the extent such a connection is necessary and only when appropriate security measures (e.g. firewalls and/or network segmentation) are in place.

For additional information on industrial security measures that can be implemented, please visit (<https://www.siemens.com/industrialsecurity>).

Siemens' products and solutions undergo continuous development to make them more secure. Siemens strongly recommends that product updates are applied as soon as they are available and that the latest product versions are used. Use of product versions that are no longer supported, and failure to apply the latest updates may increase customers' exposure to cyber threats.

To stay informed about product updates, subscribe to the Siemens Industrial Security RSS Feed visit (<https://www.siemens.com/industrialsecurity>).

Table of contents

	Preface	3
1	Documentation guide	8
2	Product overview	11
2.1	Area of application	11
2.2	Properties of the SM 1238 Energy Meter 480VAC	13
2.3	Firmware updates and S7-1200 CPU version compatibility	14
3	Wiring	15
3.1	Connecting AC power and the measured load	15
3.2	Connection examples	19
3.3	Electrical current transformer selection	22
4	Configure I/O address space	25
4.1	TIA Portal project overview	25
4.2	Choosing a module version	26
4.2.1	Module version options	26
4.2.2	STEP 7 project planning and module versions	29
4.2.3	Changing the Process data variant in RUN mode	30
4.2.4	Recommendations on the choice of a module version	31
5	Quick start	32
5.1	Getting measured values quickly	32
6	Reading and processing measured values	34
6.1	Basics for reading measured values	34
6.2	Quality information	36
6.3	Reading measured values from the user data cyclically	39
6.4	Read measured value from a measured data record	40
7	Energy counters	41
7.1	How the energy meter works	41
7.2	Configuring the energy counters.....	44
7.3	Evaluating energy counters and overflow counters	46
7.4	Resetting energy counter and overflow counters	47
7.4.1	Introduction	47
7.4.2	Resetting energy counters by user data	47
7.4.3	Resetting energy counters and overflow counters by data set DS 143	49
7.4.4	Example reset of energy counters and overflow counters by data set DS 143	51
7.5	Data record for energy counters (DS 143).....	53

7.5.1	Structure of energy counter data DS 143	53
7.5.2	Structure of the control and feedback interface DS 143	59
8	Operating hours counter.....	61
8.1	How the operating hours counter works	61
8.2	Resetting the operating hours counter.....	62
8.2.1	Introduction	62
8.2.2	Resetting the operating hours counter by user data.....	62
8.2.3	Resetting the operating hours counter by data set DS 143.....	63
9	Minimum and maximum values	65
9.1	Minimum and maximum values	65
9.2	Resetting minimum and maximum values	66
10	Phase-based measurements.....	68
10.1	Phase-based measurements	68
11	Configuration with the TIA Portal	70
11.1	TIA Portal Device configuration	70
11.2	General information parameters	71
11.3	Module parameters	71
11.3.1	AI configuration parameters.....	71
11.3.1.1	Diagnostics (module scope parameters)	71
11.3.1.2	Measurement (module scope parameters).....	71
11.3.2	Process data parameters.....	74
11.3.2.1	Operating mode	74
11.4	AI 3 (AC phase parameters)	76
11.4.1	Inputs (phase channel parameters).....	76
11.4.1.1	Line conductors 1, 2, and 3 parameters	76
11.5	I/O addresses.....	80
11.5.1	I/O start addresses, Process image update and PIP partition.....	80
11.5.2	Hardware identifier.....	81
12	Status LEDs and diagnostic interrupt alarms	82
12.1	Status and error LED display	82
12.2	Diagnostic alarms	84
12.3	Diagnostics response.....	86
13	Technical specifications	88
13.1	Technical specifications	88
A	Module configuration data record (DS 128)	93
A.1	Configuration by parameter data record	93
A.2	Parameter data record 128.....	94
B	Measured variables.....	102
B.1	Measured process variables and connection type	102

C	Module version configuration options	110
C.1	Module version "2 bytes I/ 2 bytes O"	110
C.2	Module versions that allow run-time change of Siemens defined Process data variants....	113
C.2.1	Module version "32 I bytes I/ 12 bytes O"	113
C.2.2	Module version "112 bytes I/ 12 bytes O"	117
C.3	Module version "EE@Industry measured data profile" E0 / E1 / E2 / E3	122
D	Process data variant options	126
D.1	Overview of Process data variant options	126
D.2	Total power L1, L2, L3 (W# 16# FE).....	128
D.3	Active power L1, L2, L3 (W# 16# FD).....	129
D.4	Reactive power L1, L2, L3 (W# 16# FC)	130
D.5	Apparent power L1, L2, L3 (W# 16# FB)	131
D.6	Basic measurement values L1, L2, L3 (W# 16# FA)	132
D.7	Total energy L1, L2, L3 (W# 16# F9).....	133
D.8	Energy L1 (W# 16# F8).....	134
D.9	Energy L2 (W# 16# F7).....	135
D.10	Energy L3 (W# 16# F6).....	136
D.11	Basic values 3-phase measurement L1, L2, L3 (W# 16# F5)	137
D.12	Quality values 3-phase measurement (W# 16# F0)	138
D.13	Energy measurement (periodical) overage meter (W# 16# EF).....	139
D.14	EE@Industry measurement data profile E3 (W# 16# E3)	140
D.15	EE@Industry measurement data profile E2 (W# 16# E2)	141
D.16	EE@Industry measurement data profile E1 (W# 16# E1)	141
D.17	EE@Industry measurement data profile E0 (W# 16# E0)	142
D.18	Basic values single phase measurement L1 (W# 16# 9F)	142
D.19	Basic values single phase measurement L1a (W# 16# 9E)	143
D.20	Basic values single phase measurement L2 (W# 16# 9D).....	144
D.21	Basic values single phase measurement L2a (W# 16# 9C).....	145
D.22	Basic values single phase measurement L3 (W# 16# 9B)	146
D.23	Basic values single phase measurement L3a (W# 16# 9A)	147
E	Measured value data records	148
E.1	Overview of all measured data records	148
E.2	Base measurements data record (DS 142)	149
E.3	Energy counters data record (DS 143)	151
E.4	Maximum values data record (DS 144)	156
E.5	Minimum values data record (DS 145)	157

E.6	L1 phase-based values data record (DS 147)	158
E.7	L2 phase-based values data record (DS 148)	159
E.8	L3 phase-based values data record (DS 149)	160
E.9	Advanced measurements and status values (DS 150)	162
F	Tips and tricks	164
F.1	Tips and tricks	164
G	Embedded software license	165
G.1	Software license conditions	165
	Index	168

Documentation guide

The documentation for the SIMATIC S7-1200 programmable controller is arranged into three areas.

This arrangement enables you to access the specific content that you need.

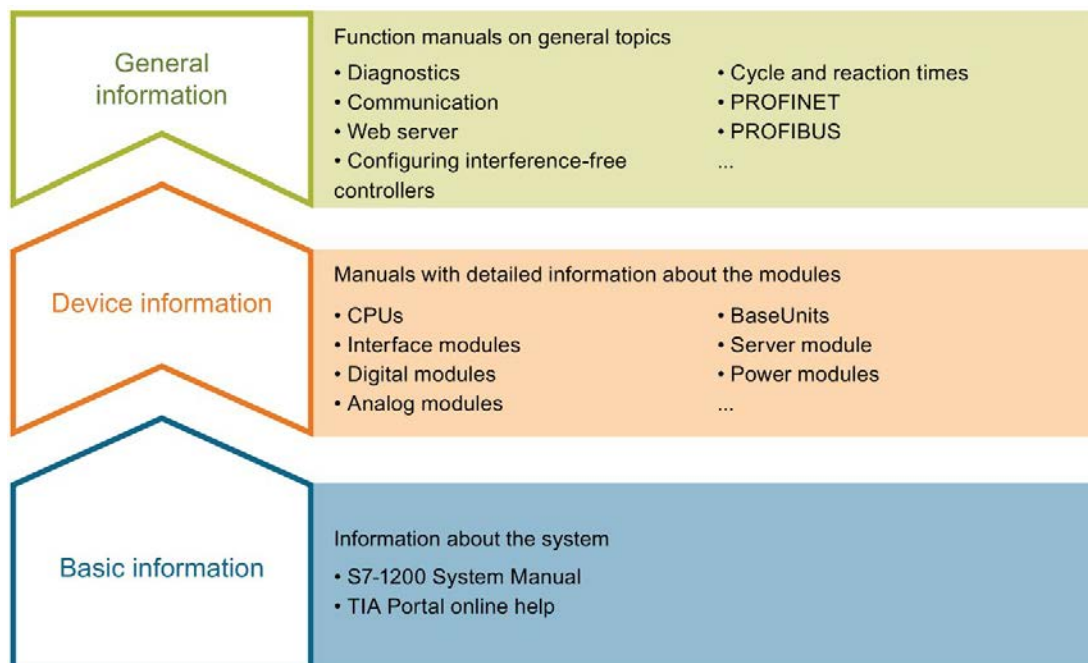

Basic information

The S7-1200 system Manual and Getting Started describe in detail the configuration, installation, wiring, and commissioning of a SIMATIC S7-1200 programmable logic control system. The TIA portal and STEP 7 online help also support you during configuration and programming.

Device information

This device manual contains a compact description of the module-specific information, such as properties, terminal diagrams, characteristics, and technical specifications.

General information

The function manuals contain detailed descriptions on general topics regarding the SIMATIC S7-1200 system (for example, diagnostics, communication, Motion Control, and Web server).

You can download the documentation free of charge from the Internet (<https://www.siemens.com/global/en/home/products/automation/systems/industrial.html>).

Changes and supplements to the manuals are documented in a Product Information document.

S7-1200 system manual

The system manual contains the documentation of the SIMATIC S7-1200.

You can find the S7-1200 system manual on the Internet (<https://support.industry.siemens.com/cs/ww/en/view/91696622>).

"mySupport"

With "mySupport", your personal workspace, you make the most of your Industry Online Support.

In "mySupport" you can store filters, favorites and tags, request CAx data and put together your personal library in the Documentation area. Furthermore, your data is automatically filled into support requests and you always have an overview of your current requests.

You need to register once to use the full functionality of "mySupport".

You can find "mySupport" on the Internet (<https://support.industry.siemens.com/My/ww/en>).

"mySupport" -Documentation

In the Documentation area of "mySupport", you can combine complete manuals or parts of them to make your own custom manual.

You can export the manual in PDF format or in an editable format.

You can find "mySupport" - Documentation on the Internet (<https://support.industry.siemens.com/my/WW/en/documentation>).

"mySupport" - CAx data

In the CAx Data area of "mySupport", you have access to the latest product data for your CAx or CAe system.

You configure your own download package with a few clicks.

In doing so you can select:

- Product images, 2D dimension drawings, 3D models, internal circuit diagrams, EPLAN macro files
- Manuals, characteristics, operating manuals, certificates
- Product master data

You can find "mySupport" - CAx Data on the Internet (<https://support.industry.siemens.com/my/WW/en/CAxOnline>).

Application examples

The application examples support you with various tools and examples for solving your automation tasks. Solutions are shown in interplay with multiple components in the system - separated from the focus in individual products.

You can find Applications examples on the Internet (<https://support.industry.siemens.com/cs/ww/en/sc/2054>).

TIA Selection Tool

With the TIA Selection Tool, you can select, configure and order devices for Totally Integrated Automation (TIA).

This tool is the successor of the SIMATIC Selection Tool and combines the known configurators for automation technology into one tool.

With the TIA Selection Tool, you can generate a complete order list from your product selection or product configuration.

You can find the TIA Selection Tool on the Internet

(<http://w3.siemens.com/mcms/topics/en/simatic/tia-selection-tool>).

See also

SIMATIC manual overview

(<https://www.siemens.com/global/en/home/products/automation/systems/industrial/plc/s7-1200.html>)

Product overview

2.1 Area of application

Introduction

Energy efficiency is increasingly important to industry. Rising energy prices, increasing pressure to improve profitability, and the growing awareness of climate protection are important reasons to reduce energy costs and monitor energy consumption.

Where can you use the SM 1238 Energy Meter 480VAC?

SM 1238 Energy Meter 480VAC is designed for machine-level deployment in a S7-1200 system. The module records over 200 different electrical measurement and energy values. It lets you measure the energy requirements of individual components of a production plant down to the machine level.

Using the measured values provided by the SM 1238 Energy Meter 480VAC, you can determine energy consumption and power demand. You can determine consumption forecasts and efficiency from the measured values. Power measurements are relevant for load management and maintenance. In addition, you can use the measurements for energy reporting and for determining the CO₂ footprint.

Note

Measuring dangerous electrical quantities

The SM 1238 Energy Meter 480VAC is not tested according to DIN EN 61010-2-030 and may therefore not be used to verify, measure or monitor protective measures according to DIN EN 61557.

Qualified personnel must ensure through additional measures that no danger ensues for humans and the environment, if there is an incorrect measurement.

Measuring with SM 1238 Energy Meter 480VAC

A typical AC power network for a production plant is divided into three voltage ranges:

- The infeed of the entire plant
- The distribution, for example, to individual lines within the plant
- The end electrical loads such as the machines in a production line.

The following figure shows measurement in an electricity supply network:

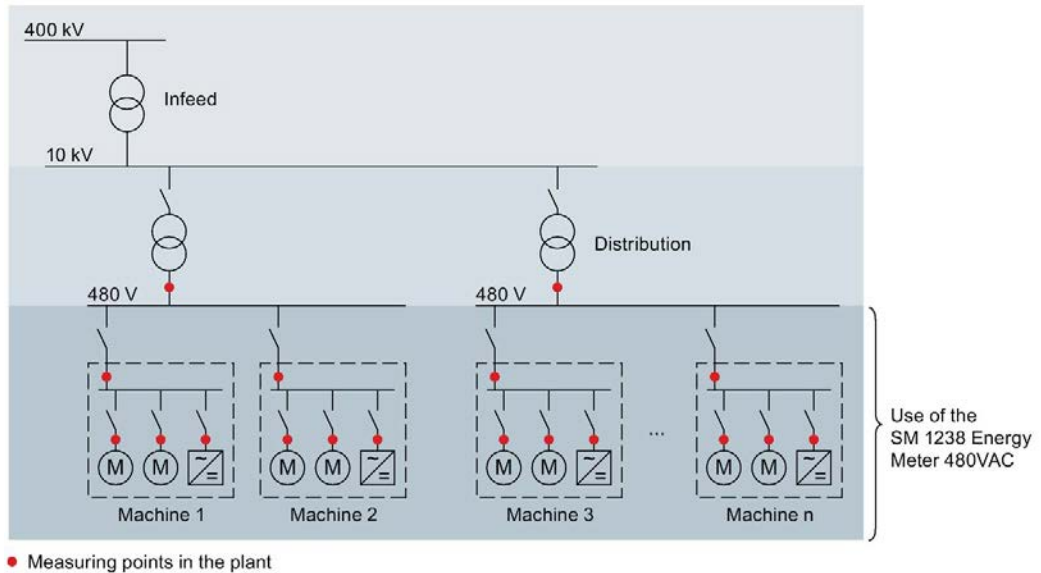

Figure 2-1 Use of the SM 1238 Energy Meter 480VAC

Advantages of the SM 1238 Energy Meter 480VAC

The SM 1238 Energy Meter 480VAC has the following advantages:

- Space-saving especially for use in a control cabinet
- You can plug in a maximum of eight Energy Meter modules to one S7-1200 PLC
- Expansion of existing I/O to monitor and record power consumption

2.2 Properties of the SM 1238 Energy Meter 480VAC

Article number

6ES7238-5XA32-0XB0

Powering the module

Module revision F-stand 1 modules are powered from the L1 input voltage and require a minimum of 90 V AC for module operation. Module revision F-stand 2 and higher are powered from the CPU bus and will operate with an input voltage of 0 V AC on L1.

Properties

The module has the following technical properties:

- Measurement of electrical variables from single-phase, two-phase and three-phase AC power supply networks
- Maximum nominal voltage between two outer conductors 480 V AC (max. phase voltage 277 V AC)
- Recording of:
 - Voltages
 - Currents
 - Phase angles
 - Power (electrical load - active W, reactive var, apparent VA)
 - Energy usage counter (electrical work)
 - Frequencies
 - Minimum and maximum values
 - Power factors (ratio of real power/apparent power)
 - Operating hours counter

The module supports the following functions:

- Firmware update
- I&M identification data
- Reconfiguration in RUN
- Diagnostics interrupts

Configuration tool

You can configure the module with STEP 7 (TIA Portal) V13 SP1 with Update 8 or higher and HSP 0151.

Accessories

SM 1238 Energy Meter 480VAC modules are shipped with keyed terminal blocks installed. If you need additional terminal blocks, a terminal block kit (a special keyed terminal block is required) must be ordered separately.

You can find additional information on the accessories in the S7-1200 system manual (<https://support.industry.siemens.com/cs/ww/en/view/91696622>).

2.3 Firmware updates and S7-1200 CPU version compatibility

The SM 1238 Energy Meter 480VAC module is compatible with S7-1200 CPUs that have firmware version V4.1 or higher.

SM 1238 Energy Meter 480VAC firmware update via SD card and S7-1200 CPU V4.1 is not supported.

Supported methods to update SM 1238 Energy Meter 480 VAC firmware

Using **S7-1200 CPU V4.1**:

- TIA Portal signal module firmware loader
- S7-1200 CPU Webserver firmware loader
- SIMATIC Automation Tool firmware update

Using **S7-1200 CPU V4.2** (or higher):

- TIA Portal signal module firmware loader
- S7-1200 CPU Webserver firmware loader
- SIMATIC Automation Tool firmware update
- SD card via S7-1200 CPU card slot loader

Note

For F-Stand 1 modules firmware update process requires power from phase 1

Before starting a firmware update, you must plug the SM 1238 Energy Meter 480VAC into an S7-1200 CPU **and** connect phase 1 (90 V AC minimum) to the Energy meter's UL1 and N terminals.

Wiring

3.1 Connecting AC power and the measured load

General safety instructions

 **WARNING**

Danger to life and dangerous system conditions can occur if the following requirements are not met

A switch or circuit-breaker must be included in the installation.

The switch or circuit-breaker must be suitably located and easily reached.

The switch or circuit-breaker must be marked as the disconnecting device for the equipment.

 **WARNING**

Danger to life due to electric shock

Touching live parts can lead to death or severe injuries.

Before beginning any work de-energize the system and the Energy Meter and short-circuit installed transformers.

 **WARNING**

Danger to life, dangerous system conditions and material damage possible

Removing and inserting the Energy Meter under live voltage is prohibited!

If you remove and insert the Energy Meter under live voltage during operation, the transformers used can produce dangerous induction voltages and electric arcs and dangerous system conditions can arise.

The Energy Meter may only be removed and inserted during operation if the measured voltages applied to the module are disconnected at all phases at the terminals UL1, UL2, UL3 **and** special electrical current transformer terminals are used that short-circuit the transformer at the secondary side when removed.

 **CAUTION**

Use only in AC networks

The Energy Meter is destroyed if used with direct voltage / direct current.

Use the Energy Meter solely to measure the electrical characteristics of AC networks.

3.1 Connecting AC power and the measured load

Supplying the module

For F-Stand 1 modules the module is always supplied via UL1 and N. The required minimum voltage is 90 VAC.

AC power source grounding systems

The SM 1238 Energy Meter 480VAC works with the following IEC defined grounding systems.

- TN
- TT
- IT: You must create an artificial N-conductor (for example, by means of a 1:1 voltage transformer) in IT networks due to the missing neutral conductor. You can then use the module.

Protecting the connection cables

To protect the connection cables at UL1, UL2 and UL3, make sure there is adequate cable protection, especially after conductor cross-sectional area transitions.

If short-circuit resistance according to IEC 61439-1:2009 is ensured by the design, there is no need for separate line protection devices at the power line phase connections.

Terminal block wiring diagram

X10 terminal block - phase voltage connections

- Direct connection when safely possible
- Connect to line protection devices as shown
- Connect to voltage transformers for phase to phase voltage higher than 480 VAC
- For F-stand 1 modules the module is powered from phase 1 (UL1 and N).
- For F-stand 1 modules 90 VAC minimum at (UL1 and N) is required for operation.

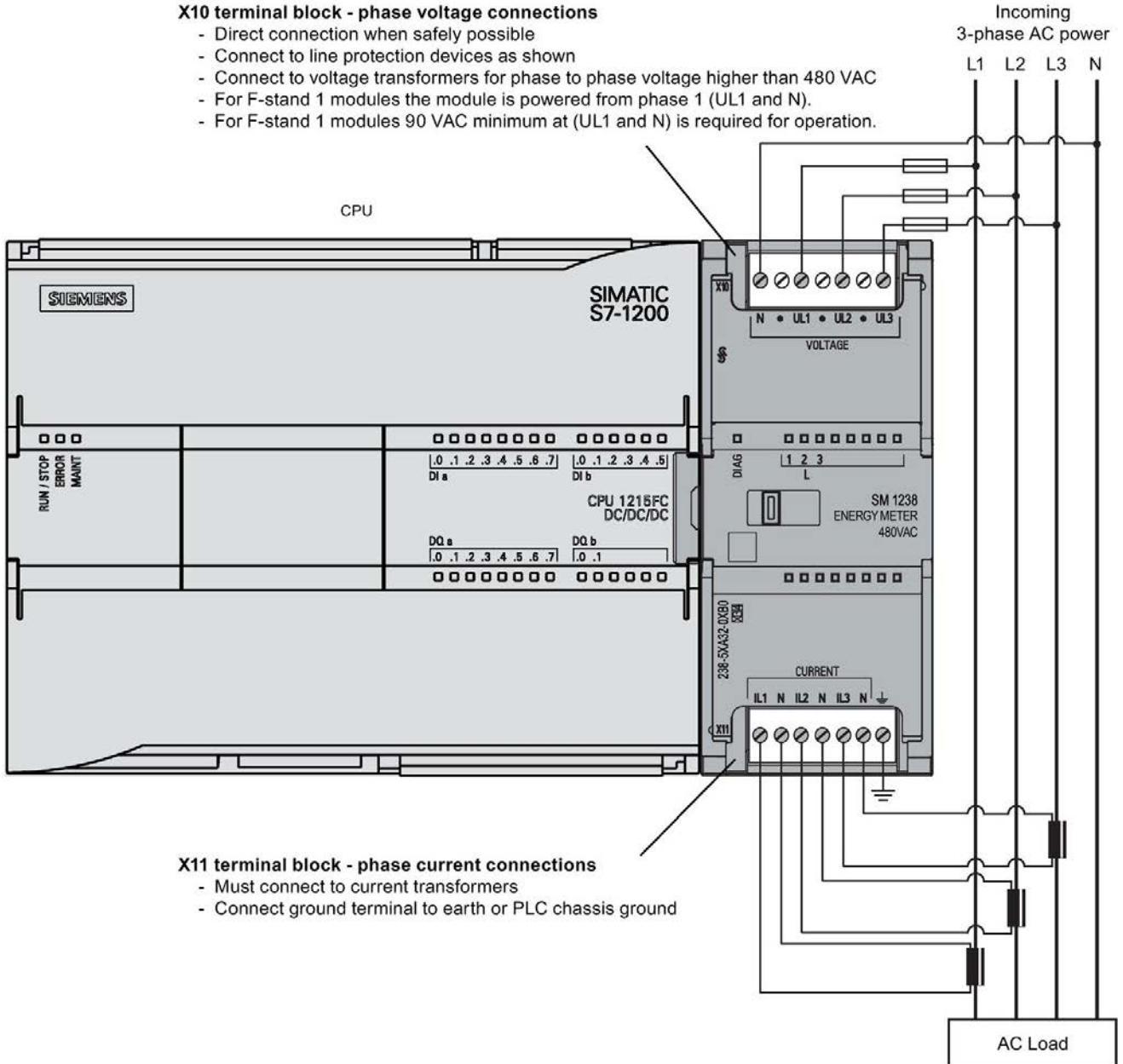

X11 terminal block - phase current connections

- Must connect to current transformers
- Connect ground terminal to earth or PLC chassis ground

3.1 Connecting AC power and the measured load

Figure 3-1 SM 1238 Energy Meter 480VAC wiring diagram

Table 3- 1 Connector pin locations for SM 1238 Energy meter 480VAC (6ES7 238-5XA32-0XB0)

Pin	X10	X11
1	N	
2	No connection	
3	UL1	
4	No connection	
5	UL2	
6	No connection	
7	UL3	
8		IL1
9		N
10		IL2
11		N
12		IL3
13		N
14		Functional Earth

Connection types

The SM 1238 Energy Meter 480VAC supports the following connection types:

- **1P2W:** 1-phase, 2-wire
- **3P4W:**, 3-phase, 4-wire
- **3P4W1:** 3-phase, 4-wire. symmetrical load
- **3x1P2W:** 3 x 1-phase, 2-wire each
- **2P3W:** 2 phases, 3-wire

The input circuit of the module must correspond to one of these connection types. Select the appropriate connection type for the intended use.

For more wiring examples, see the section Connection examples (Page 19).

Information on the requirements for electrical current transformers is available in the section Electrical current transformer selection (Page 22).

3.2 Connection examples

The following figures show the connection of the Energy Meter for three-phase, two-phase and single-phase measurements. Note that the Energy Meter must always be connected with electrical current transformers. The use of voltage transformers is optional.

Connection type	Wiring diagram	Comment
<p>3P4W Three-phase measurement, 4 wires</p>		<p>Any load Connection with three electrical current transformers</p>
<p>3P4W Three-phase measurement, 4 wires</p>		<p>Any load Connection with three current and three voltage transformers</p>
<p>3P4W1 Three-phase measurement, 4 wires</p>		<p>Symmetrical (balanced) load Connection with one electrical current transformer</p> <p>The values for phase 1 are measured. Since the phase loads are balanced, values for phase 2, phase 3, and total values are calculated in the module.</p>

3.2 Connection examples

Connection type	Wiring diagram	Comment
<p>3P4W1 Three-phase measurement, 4 wires</p>		<p>Symmetrical (balanced) load Connection with one current and one voltage transformer</p> <p>The values for phase 1 are measured. Since the phase loads are balanced, values for phase 2, phase 3, and total values are calculated in the module.</p>
<p>2P3W Two-phase measurement, 3 wires</p>		<p>Any load Connection with two electrical current transformers. The Energy meter supplies value "0" for all measured values of Phase 3 and for some cross-phase measured values.</p>
<p>2P3W Two-phase measurement, 3 wires</p>		<p>Any load Connection with two current and two voltage transformers The Energy meter supplies value "0" for all measured values of Phase 3 and for some cross-phase measured values.</p>
<p>1P2W Single-phase measurement, 2 wires</p>		<p>Connection with one electrical current transformer. The Energy meter supplies value "0" for all measured values of Phases 2 and 3 as well as for some cross-phase measured values.</p>

Connection type	Wiring diagram	Comment
<p>1P2W Single-phase measurement, 2 wires</p>		<p>Connection with one current and one voltage transformer The Energy meter supplies value "0" for all measured values of Phases 2 and 3 as well as for some cross-phase measured values.</p>
<p>3 x 1P2W 3 x single-phase measurement</p>		<p>Connection with three electrical current transformers for any three loads that are all connected to phase 1 The maximum permissible secondary current in the transformer is 1 A.</p>
<p>3 x 1P2W 3 x single-phase measurement</p>		<p>Connection with three current transformers and three voltage transformers, for any three loads that are all connected to phase 1 Maximum permissible secondary current of the transformer is 1 A.</p>

* If short-circuit resistance is ensured by conformity to IEC 61439-1:2009, there is no need for separate line protection devices.

3.3 Electrical current transformer selection

Introduction

Connection with an electrical current transformer is always required for electrical current measurement. Use toroid coils with an accuracy class of 0.5, 1 or 3.

Sizing the electrical current transformer

Using an electrical current transformer with the recommended electrical characteristics provides:

- Accurate results from the measurements and
- Prevention of overload or damage to the electrical current transformers.

Electrical current transformer requirements

Use electrical current transformers with a load capacity 1.5 to 2 times greater than the power dissipation in the terminal circuit (consisting of the resistance of the connection cables and the load of energy meter).

- 1.5 times the load power dissipation is required to prevent the transformer from overloading.
- 2 times the load power dissipation is required to ensure electrical current limiting, in the case of a short-circuit.

Maximum length of the connection cable

You must not exceed the load Z_n to avoid overloading or damaging the electrical current transformer. Z_n is specified on the data sheet of the electrical current transformer (in VA). To prevent exceeding this limit, the entire load resistance that consists of the resistance of the connection cable and the internal resistance of the SM 1238 Energy Meter 480VAC (see following figure) must be below a certain resistance value (depending on Z_n and I_{max}).

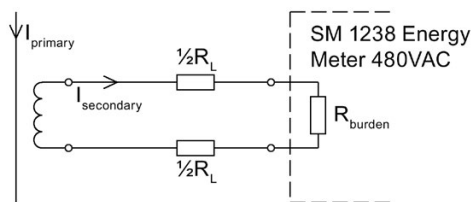

Figure 3-2 Maximum length for connection cable

The maximum value of the resistance of the connection cable is obtained with the following formula:

$$R_{L, \max} = \frac{Z_n}{I_{\max}^2} - R_{\text{burden}}$$

R_L	Cable resistance in ohms	I_{\max}	Secondary electrical current of the transformer
Z_n	Electrical current transformer rated load in VA	R_{burden}	Resistance within the SM 1238 Energy Meter 480VAC = 25 mΩ (milliohms)

Maximum value for the resistance of the connection cable

Based on the maximum cable resistance in ohms, you then calculate the maximum length of the connection cable. To do this, check the data sheet of the connection cable you are using.

Note

The length of the connection cable (outwards and return) must not exceed 200 meters.

Example: Use of electrical current transformer 500/5A

The maximum primary current in the application is 400 A. This means that the maximum secondary current I_{\max} is 4 A. The load of the Energy Meter including connection resistance is $R_{\text{Burden}} = 25 \text{ m}\Omega$.

The maximum resistance of the connection cable (outgoing and incoming line) is obtained using the following formula:

$$R_{L, \max} = \frac{Z_n}{I_{\max}^2} - R_{\text{Burden}} = \frac{5 \text{ VA}}{16 \text{ A}^2} - 25 \text{ m}\Omega = 312.5 \text{ m}\Omega - 25 \text{ m}\Omega = 287.5 \text{ m}\Omega$$

The maximum cable resistance between the transformer and the terminals of the Energy Meter may not exceed 287.5 mΩ, in this case. The corresponding cable length (outgoing and incoming line) depends on the cross-sectional area of the copper cable and can be determined by using the following table.

The following table shows the resistance values of copper cables for typical cross-sections, where the copper resistivity ρ equals 0.017857 Ω x mm²/m.

Cross-section	AWG	Cable resistance for copper				
		0.5 m	1 m	5 m	10 m	50 m
0.25 mm ²	24	35.7 mΩ	71.4 mΩ	357.1 mΩ	714.3 mΩ	3571.4 mΩ
0.34 mm ²	22	26.3 mΩ	52.5 mΩ	262.6 mΩ	525.2 mΩ	2626.0 mΩ
0.5 mm ²	21	17.9 mΩ	35.7 mΩ	178.6 mΩ	357.1 mΩ	1785.7 mΩ
0.75 mm ²	19/20	11.9 mΩ	23.8 mΩ	119.0 mΩ	238.1 mΩ	1190.5 mΩ
1.0 mm ²	18	8.9 mΩ	17.9 mΩ	89.3 mΩ	178.6 mΩ	892.9 mΩ
1.5 mm ²	16	6.0 mΩ	11.9 mΩ	59.5 mΩ	119.0 mΩ	595.2 mΩ
2.5 mm ²	14	3.6 mΩ	7.1 mΩ	35.7 mΩ	71.4 mΩ	357.1 mΩ

Checking the relationship of burden load and power loss

The rated load of the transformer must be 1.5 to 2 times greater than the power loss in the connection circuit to ensure that the transformer is not overloaded and that the electrical current limitation is ensured during a short-circuit.

At a maximum secondary current of 4 A, the power loss in the connection circuit is calculated according to the following formula for a connection cable (outgoing and incoming line) with a length of 10 m, a cross-section of 1.0 mm², and an Energy meter load resistance R_{Burden} of 25 mΩ:

$$P_{\text{Connection circuit}} = (R_{\text{Connection cable}} + R_{\text{Burden}}) \times I_{\text{Max. secondary}}^2$$

$$P_{\text{Connection circuit}} = (178.6 \text{ m}\Omega + 25 \text{ m}\Omega) \times 4^2 \text{ A}^2 = 3.26 \text{ W}$$

The ratio of rated load and power loss in the connection circuit is:

$$\frac{Z_{\text{N Rated load}}}{P_{\text{Connection circuit}}} = \frac{5 \text{ VA}}{3.26 \text{ W}} = 1.54$$

The required ratio of the electrical current transformer's rated load and power loss in the connection circuit is within the required range (between 1.5 and 2). The example electrical current transformer has the correct electrical characteristics for this application.

Configure I/O address space

4.1 TIA Portal project overview

Introduction

To configure the SM 1238 Energy Meter 480VAC after connecting it, you use the TIA portal device configuration software. In addition, you can change some parameters in RUN mode, with the user program.

Configuring

You configure the SM 1238 Energy Meter 480VAC with STEP 7 (TIA Portal) V13 SP1 with Update 8 or higher and HSP 0151. The HSP or Hardware Service Pack adds the Energy meter to the TIA Portal hardware catalog.

The following steps show the basic procedure for configuring the S7-1200 CPU and SM 1238 Energy Meter 480VAC.

1. Find the S7-1200 CPU that you are using in the hardware catalog insert the CPU in your project's Device view window.
2. Find the SM 1238 Energy Meter 480VAC in the hardware catalog under the AI (Analog Input) folder and insert the module into your device view window, on the CPU's right-side. You can use any right-side position.
3. Click on the SM 1238 Energy Meter 480VAC module image in the device view to see the module's configuration parameters on the Properties tab.
4. Set the parameters of the SM 1238 Energy Meter 480VAC for your requirements.

Once the configuration has been compiled without errors, you can download the configuration to the CPU and begin S7-1200 and SM 1238 Energy Meter 480VAC operations with your user program.

For configuration parameter details, see Configuration with the TIA Portal (Page 70).

4.2 Choosing a module version

4.2.1 Module version options

Introduction

When you configure the SM 1238 Energy Meter 480VAC, you use the parameter "Module version" to select the size of the PLC user data program interface and whether the measurement data group is fixed or if changing the Process data variant with your program logic is allowed.

Each module version supplies quality information via the input user data.

With the exception of the module version "2 I / 2 Q", you can read the measured values as user data cyclically from the PLC process image. You also have the option to read measured value records from the SM 1238 Energy Meter 480VAC acyclically by using the RDREC instruction.

Influence of the module version on the address space

Note

Influence of the SM 1238 Energy Meter 480 VAC on I/O address allocation in the S7-1200 PLC

The available address space of a S7-1200 CPU is influenced by the following factors:

- S7-1200 CPU model
- Other I/O modules that may be plugged into the S7-1200 CPU

The maximum I/O address space required by the SM 1238 Energy Meter 480VAC is determined by the size of the user data provided to your control program.

The configuration parameters "Module version" and "Process data variant" (when enabled) set the maximum size of the user data.

The choice of Module version and Process data variant is influenced by the following factors:

- Planned application
- Available address space

The following table shows the different Module version options and the required I/O address space:

Module version name	Process data variant options	Number of input I bytes used	Number of output Q bytes used	Comment	Changing Process data variant in RUN possible
2 bytes I / 2 bytes O	No Process data variants available	2	2	Contains quality information only.	No
32 bytes I / 12 bytes O	All Process data variants possible, except EE@Industry measurement data profile e3	32	12		Yes
112 bytes I / 12 bytes O	All Process data variants possible	112	12		Yes
EE@Industry measurement data profiles e0 / e1 / e2 / e3	No Process data variants available	e0: 12 e1: 4 e2: 12 e3: 104	12	Content depends on the data profile choice. Contains no quality information.	No

When you select the "32 bytes I /12 bytes O" or the "112 bytes I /12 bytes O" module version, you **must** also select a "Process data variant" pre-defined measurement group from the following table.

Process data variant options and hexadecimal identifier codes	Number of input I bytes used	Number of output Q bytes used
Total power L1, L2, L3 (FE _H)	32	12
Active power L1, L2, L3 (FD _H)	32	12
Reactive power L1, L2, L3 (FC _H)	32	12
Apparent power L1, L2, L3 (FB _H)	32	12
Basic measurement values (FA _H)	32	12
Total energy L1, L2, L3 (F9 _H)	32	12
Energy L1 (F8 _H)	32	12
Quality values 3-phase measurement (F0 _H)	32	12
Energy meter (periodical) overage meter (EF _H)	32	12
¹ EE@Industry Measurement Data Profile e3 (E3 _H)	112	12
EE@Industry Measurement Data Profile e2 (E2 _H)	32	12
EE@Industry Measurement Data Profile e1 (E1 _H)	32	12
EE@Industry Measurement Data Profile e0 (E0 _H)	32	12
Basic values Single Phase Measurement L1 (9F _H)	32	12
Basic values Single Phase Measurement L1a (9E _H)	32	12
Basic values Single Phase Measurement L2 (9D _H)	32	12
Basic values Single Phase Measurement L2a (9C _H)	32	12
Basic values Single Phase Measurement L3 (9B _H)	32	12
Basic values Single Phase Measurement L3a (9A _H)	32	12

¹ EE@Industry Measurement Data Profile e3 (E3_H) is only available with the "112 bytes I /12 bytes O" module version.

Module version features

The following table shows which module version is suitable for a given purpose.

Module version	Application	Note
2 bytes I / 2 bytes O	<ul style="list-style-type: none"> • Use of several SM 1238 Energy Meter 480VAC in an S7-1200 CPU or where a small address space is available • Reading quality information for measured values • Counting of operating hours and energy • Acyclic acquisition of measured values (optional) • Consistent measured values (optional) 	Read the measured values via the RDREC instruction from a measured value data record
32 bytes I / 12 bytes O	<ul style="list-style-type: none"> • Cyclic measurement per phase • Counting of operating hours and energy • Flexibility by switching predefined Process data variants during RUN mode. 	Available measured values depend on the active Process data variant.
112 bytes I / 12 bytes O		
EE@Industry measurement data profile e0 / e1 / e2 / e3	<ul style="list-style-type: none"> • Cyclic measurement per phase • Counting of operating hours and energy 	Available measured values depend on the configured measurement data profile.

4.2.2 STEP 7 project planning and module versions

Module versions with fixed Process data

Module version	User data	Address space	Comment
2 bytes I / 2 bytes O	No cyclic process data. Access to measured values through RDREC read data record instruction.	2-byte inputs / 2-byte outputs	Information about the structure of the 2 bytes I /2 bytes O module version is available in the appendix Module version "2 bytes I /2 bytes O" (Page 110)
EE@Industry E0	Process data in accordance with EE@Industry measurement data profiles	12 byte inputs / 12 byte outputs	Information about the structure of the EE@Industry measured data profiles is available in the appendix Module version "EE@Industry measurement data profile E0 / E1 / E2 / E3" (Page 122).
EE@Industry E1		4 byte inputs / 12 byte outputs	
EE@Industry E2		12 byte inputs / 12 byte outputs	
EE@Industry E3		104 byte inputs / 12 byte outputs	

Module versions with selectable Process data variants

Module version	User data	Address space	Comment
32 bytes I / 12 bytes O	Selectable Process data variants	32 byte inputs / 12 byte outputs	You can change the Process data variant during operation.
112 bytes I / 12 bytes O		112 byte inputs / 12 byte outputs	Information about the structure of the 32 bytes I /12 bytes O module version is available in the appendix Module version "32 bytes I /12 bytes O" (Page 113). Information about the structure of the 112 bytes I /12 bytes O module version is available in the appendix Module version "112 bytes I /12 bytes O" (Page 117). Information about the Process data variants is available in the appendix "Overview of Process data variant options" (Page 126)Hotspot-Text.

4.2.3 Changing the Process data variant in RUN mode

Introduction

Your program can change the Process data variant by writing Q byte 0 (in the current Process data variant) with the ID value of a different Process data variant.

The following figure shows that the EE@Industry measured data profile e3 (E3_H) is only possible for the "112 bytes I/ 12 bytes O" module version.

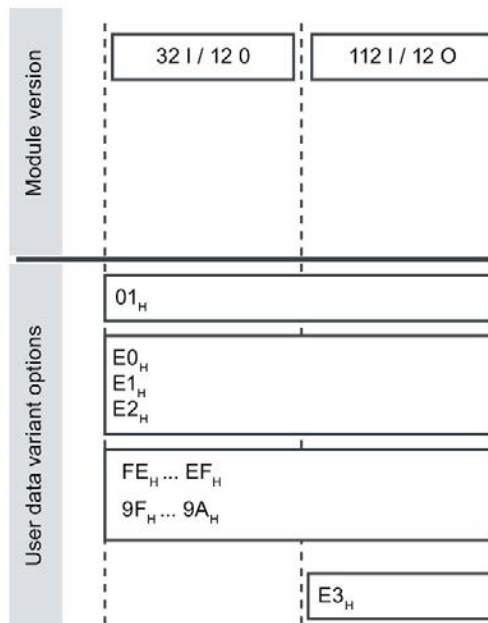

Requirement

- User program has been created.
- SM 1238 Energy Meter 480VAC is configured as module version "32 bytes I/ 12 bytes Q" or "112 bytes I/ 12 bytes Q".
- Start address of the output Q address in the process image of the CPU is known.

Procedure

1. Create one constant with the data type BYTE per Process data variant.
2. Enter the Process data variant ID as a value in each case.
3. Write the constant to the start address of the module in the process image output.

Result

The Process data variant is switched on the next cycle.

Note

Information about Process data variant changeover

The Process data variant change fails and defaults to the parameterized Process data variant (stored in DS 128), in the following cases:

- A "0" is written in byte 0 in the output data of a Process data variant.
 - Byte 0 in the output data of a Process data variant contains an invalid value:
 - Code for the Process data variant not available
 - or
 - Available address space is not sufficient for the Process data variant.
-

4.2.4 Recommendations on the choice of a module version

The following table shows which module version is suitable for a given purpose.

Module version	Application	Note
2 bytes I / 2 bytes O	<ul style="list-style-type: none"> • Using a maximum of 8 SM 1238 Energy Meter 480VAC modules with one S7-1200 PLC or where there is limited address space available 	<ul style="list-style-type: none"> • Read the measured values solely via the RDREC instruction from a measured value data record. • Quality information about the measured values is always available.
EE@Industry measurement data profile E0 / E1 / E2 / E3	<ul style="list-style-type: none"> • Cyclic measurement per phase • Supply measured values in accordance with the EE@Industry measured data profile 	<ul style="list-style-type: none"> • Available measured values depend on the configured measurement data profile. • The process data are fixed and cannot be changed dynamically. Alternatively, you can read the measured values asynchronously from a measured value data record via the RDREC instruction. • No quality information
32 bytes I / 12 bytes O	<ul style="list-style-type: none"> • Cyclic measurement per phase • Flexibility by switching pre-defined Process data variants during RUN mode 	<ul style="list-style-type: none"> • Quality information about the measured values is always available. • Depending on the active Process data variant, you must convert the measured values in the CPU to physical values using the supplied scaling factor. • One cycle elapses for each Process data variant changeover. Measured values from the next Process data variant are thus supplied with a slight time offset. <p>Alternatively, read the measured values asynchronously from a measured value data record via the RDREC instruction. Consistent measured values of a measuring cycle are supplied.</p>
112 bytes I / 12 bytes O		

Quick start

5.1 Getting measured values quickly

Introduction

This section shows you how to read and view your first measured values from the SM 1238 Energy Meter 480VAC.

Requirements

- The Energy Meter is wired to your AC network with one of the connection types shown in the Wiring (Page 15) section.
- The SM 1238 Energy Meter 480VAC is available in the STEP 7 hardware catalog for your project's Device configuration.

Procedure

1. Configure an S7-1200 CPU.
2. Plug in an SM 1238 Energy Meter 480VAC module, on the right-side of an S7-1200 CPU, and connect to an AC power network.
3. Set the following Module parameters in the AI configuration "Measurement" group:
 - "Connection type" that you have used for the SM 1238 Energy Meter 480VAC (e.g. 3P4W 3-phase, 4-wire)
 - "Voltage measuring range", which is the phase voltage (UL1-N) of your electrical power source (e.g. 230 V AC)
 - "Line frequency" of your power source (e.g. 60 Hz)
4. Set the following Module parameters in the Process data "Operating mode" group:
 - Set the "Module version" to "32 byte I/12 bytes O".
 - Set the "Process data variant" to "Total power L1, L2, L3 (W# 16# FE)".
5. Set the following module parameters in the "AI 3" > "Inputs" > Line conductor 1, 2, and 3 groups.
 - Primary and secondary current of your transformer (e.g. 100 A and 1 A)
 - Primary and secondary voltages of the used voltage transformer (e.g. 230 V and 230 V)
6. Leave all other parameters at their default settings.
7. Successfully compile the configuration, switch On the S7-1200 CPU power, and download the configuration to the CPU.

Result

Once the Energy Meter is powered On, it provides the measured values for the Process data variant with variant ID 254 (FE_H).

The following table shows which measured values are stored in the 32 bytes of output data from the module. The module output data is read by your program through 32 input I byte addresses and your program controls the module with 12 output Q byte addresses.

Each measured variable is referenced via the measured value ID. An overview of all the measured variables and IDs is provided in the section Measured variables and connection type (Page 102).

Table 5- 1 Total power L1, L2, L3 Process data variant

Byte	Allocation	Data type	Unit	Value range	Measured value ID
0	Process data variant	BYTE	-	254 (FE _H)	-
1	Quality information = QQ ₁ I ₃ U ₃ I ₂ U ₂ I ₁ U ₁	BYTE	Bit string	qq xx xx xx	-
2 ... 3	Current L1	UINT	1 mA	0 ... 65535	66007
4 ... 5	Current L2	UINT	1 mA	0 ... 65535	66008
6 ... 7	Current L3	UINT	1 mA	0 ... 65535	66009
8 ... 9	Total active power L1L2L3	INT	1 W	-27648 ... 27648	66034
10 ... 11	Total reactive power L1L2L3	INT	1 var	-27648 ... 27648	66035
12 ... 13	Total apparent power L1L2L3	INT	1 VA	-27648 ... 27648	66036
14 ... 17	Total active energy L1L2L3	UDINT	1 Wh	0 ... 4294967295	225
18 ... 21	Total reactive energy L1L2L3	UDINT	1 varh	0 ... 4294967295	226
22	Reserved	BYTE	-	0	-
23	Total power factor L1L2L3	USINT	0.01	0 ... 100	66037
24	Scaling current L1	USINT	-	0 ... 255	-
25	Scaling current L2	USINT	-	0 ... 255	-
26	Scaling current L3	USINT	-	0 ... 255	-
27	Scaling total active power L1L2L3	USINT	-	0 ... 255	-
28	Scaling total reactive power L1L2L3	USINT	-	0 ... 255	-
29	Scaling total apparent power L1L2L3	USINT	-	0 ... 255	-
30	Scaling total active energy L1L2L3	USINT	-	0 ... 255	-
31	Scaling total reactive energy L1L2L3	USINT	-	0 ... 255	-

Additional information

If you want more information on the evaluation and interpretation of the measured values, continue reading the section Reading and processing measured values (Page 34).

Reading and processing measured values

6.1 Basics for reading measured values

Introduction

The SM 1238 Energy Meter 480VAC provides the measured values and variables through the following methods:

- Cyclic: User data
- Acyclic: Measured value data records

Process data

Process data variants provide a set of Siemens defined measured values. The measured values are cyclically written to the process image of the CPU. With some Process data variants, the measured values are supplied as raw data, which you can convert to the corresponding physical values using a supplied scaling factor.

Measured value data record

Each measured value data record supplies physical values that you can process immediately. You can read the values of a measured value data record acyclically with the RDREC instruction and a PLC tag. You need a corresponding PLC tag for each measured value data record.

STEP 7 (TIA Portal) can read and display the measured values in a watch table.

Validity of the measured values

After supplying power to the module (for F-stand 1 supply voltage UL1), the first measured values are available after approximately 2 seconds.

In the input user data, the content of byte 0 is set to the selected Process data variant ID. You can detect a change in byte 0 value as a trigger event.

As soon as the module has valid measured values, the value of this byte changes to a value within the Process data variant ID value range.

Initial startup of the module

After the first startup or restart of the module, the configuration parameters are transferred to the module. You can preset a Process data variant in the parameters of the hardware configuration. This variant remains in effect until a different Process data variant is selected in the output data (byte 0). Your program can use this method to control the type of process data available to your program.

The Process data variant defined in parameter data record 128 is used under the following conditions:

- A "0" is written in byte 0 in the output data of a Process data variant.
 - Byte 0 in the output data of a Process data variant contains an invalid value:
 - Code for the Process data variant not available
 - or
 - Available address space is not sufficient for the selected Process data variant.
- See "Module version options (Page 26)".

Measured values of electrical current become "0"

The electrical current and all other measured values based on it are suppressed (or set to "0") in the data records and in the process data in the following cases:

- Incoming current is less than the configured "Low limit electrical current measurement" parameter
- Incoming secondary current at the channel is higher than 12 A

The following measured values and derived measured variables of the phase involved become "0":

- Effective electrical current value
- Active power
- Reactive power
- Apparent power
- Neutral conductor current
- Phase angle
- Power factor

A floating mean value is formed from the power values. These only become "0" after a time delay. The operating hours counter and the energy counter for active, reactive and apparent energy of the reset phase stops counting.

Substitute value behavior

The SM 1238 Energy Meter 480VAC provides the substitute value "0" to S7-1200 CPU inputs.

6.2 Quality information

Introduction

The SM 1238 Energy Meter 480VAC supplies quality information about the measurements in a status word. This information can be used to evaluate:

- Currents (I_{L1} , I_{L2} , I_{L3}) and voltages (U_1 , U_2 , U_3) lie within the valid measuring range
- Operating voltage to electrical current phase angle quadrants for each of the 3 phases
- Direction of rotation of a 3-phase system

Quality information for 3-phase system

The module saves the quality information in the measurement value ID 65503 as a bit string in 2 bytes.

You can access the quality information via:

- Process data variant "Quality values three-phase measurement (ID 240 or F0H)
- Process data (measured value ID 65503)
- Measured value data record 150

In addition, you can evaluate the quality information in byte 1 in all the Process data variants.

Quality information for individual phases

You can also evaluate the quality information for individual phases in the measured value data records DS 147, DS 148, and DS 149. You can obtain the phase-specific quality information under:

- Measured value ID 65500 for Phase 1 (Channel 0).
- Measured value ID 65501 for Phase 2 (Channel 1).
- Measured value ID 65502 for Phase 3 (Channel 2).

In contrast to the measured value 65503, the measured values with IDs 65500, 65501, and 65502 contain only the phase-specific information for current, voltage, and operating quadrant. The information about the other phases and the rotating field direction have the value 0.

Structure of the quality information

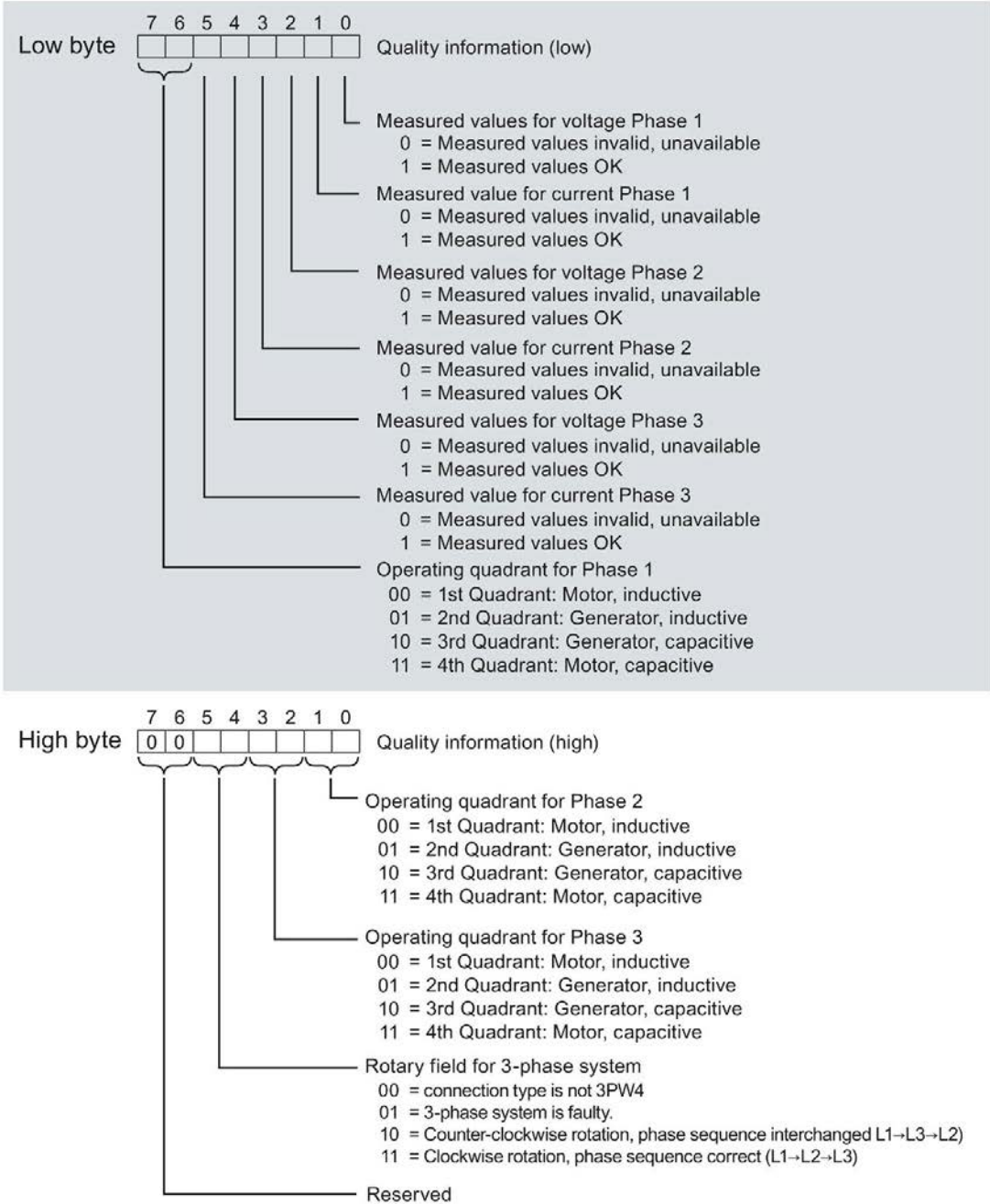

Figure 6-1 Quality data structure

Operating quadrant

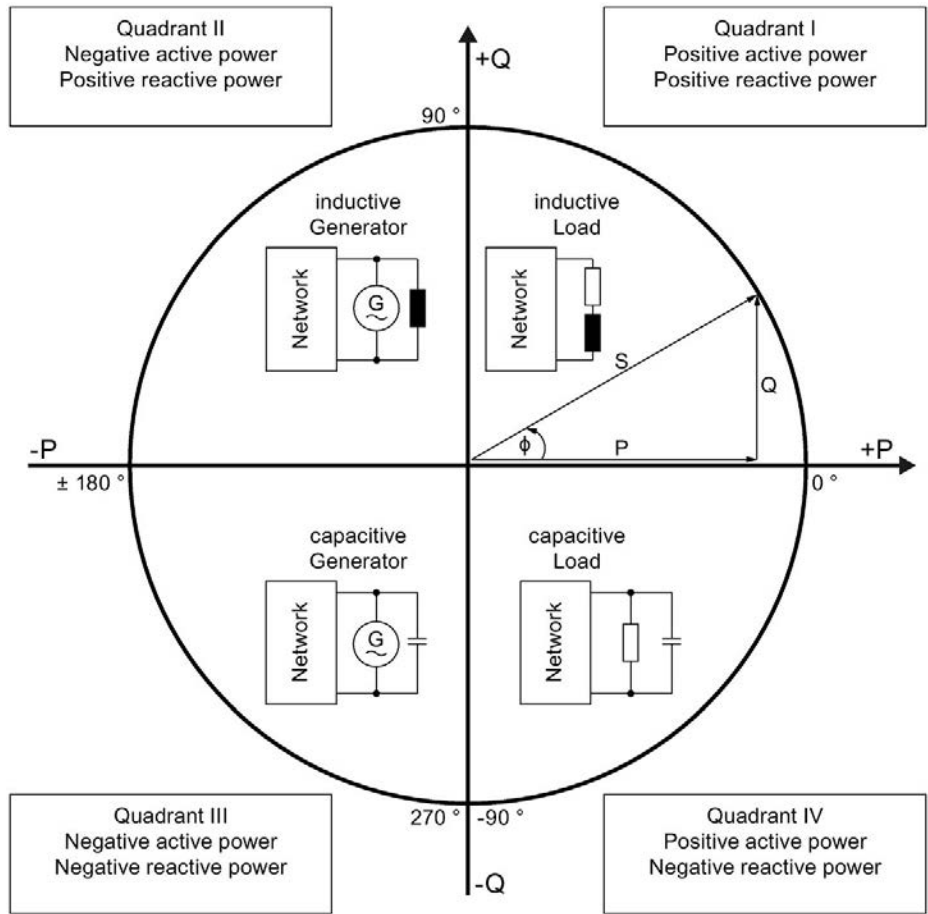

Figure 6-2 Voltage to electrical current phase angle quadrant in the quality bits

6.3 Reading measured values from the user data cyclically

Requirement

- STEP 7 (TIA Portal) is open.
- SM 1238 Energy Meter 480VAC module is configured.

Scaling of measured values in the user data

Since the value range of 16-bit values is often smaller than the value range of the physical value, a scaling factor is supplied together with the basic value in the user data for the respective measured or calculated process values. You determine the actual value of the measured variable with the following formula:

Actual value of measured quantity = measured value in the user data x 10^{scaling factor}

Procedure

To read measured values from the user data cyclically, proceed as follows:

1. Read the relevant measured value from the PLC's input data.
2. Read the scaling factor for the scaled measured values and convert the measured value using the scaling factor.

Example

The Process data variant 254 (FE_H) "Total power L1, L2, L3" is configured on the SM 1238 Energy Meter 480VAC. Read the measured value for "Current L1".

Table 6- 1 Total power L1L2L3

Byte	Allocation	Data type	Unit	Value range	Measured value ID
0	Process data variant	BYTE	-	254 (FE _H)	-
1	Quality information = QQ ₁ I ₃ U ₃ I ₂ U ₂ I ₁ U ₁	BYTE	Bit string	qq xx xx xx	-
2 ... 3	Current L1	UINT	1 mA	0 ... 65535	66007
4 ... 5	Current L2	UINT	1 mA	0 ... 65535	66008
6 ... 7	Current L3	UINT	1 mA	0 ... 65535	66009
:	:	:	:	:	:
24	Scaling current L1	USINT	-	0 ... 255	-
25	Scaling current L2	USINT	-	0 ... 255	-
26	Scaling current L3	USINT	-	0 ... 255	-
:	:	:	:	:	:
31	Scaling total reactive energy L1L2L3	USINT	-	0 ... 255	-

6.4 Read measured value from a measured data record

In the Process data variant FE_H (254) the measured value for the current L1 is stored in Bytes 2 and 3. The current is supplied by the module as a 16-bit fixed-point number in the value range from 0 ... 65535 in 1 mA units. In addition, the scaling factor for the current L1 must be read. The module supplies the related scaling factor in Byte 24.

The actual value for current L1 is calculated as follows:

Actual value for current L1 = Current L1 x 10^{Scaling current L1}

6.4 Read measured value from a measured data record

Introduction

Use the RDREC instruction to read measured values from a measured value data record. The values read are stored in a PLC variable with user-defined data type (UDT).

You can find more information on the "RDREC" instruction in the STEP 7 (TIA Portal) documentation.

Requirement

- STEP 7 is open.
- SM 1238 Energy Meter 480VAC module is configured.

Procedure

1. In STEP 7, create a user-defined data type with the structure of the data record to be read.
2. Insert the number of structural elements, which corresponds to the number of entries contained in the measured value data record.
3. Insert the RDREC instruction in the user program.
4. Configure the RDREC instruction as follows:
 - ID: Hardware identifier or start address of the Energy Meter (depending on the CPU used).
 - INDEX: Number of measured value data record whose entries are read.
 - MLEN: Length of the measured value data record in bytes. "0" if all the entries are to be read.
 - RECORD: Target range for the read data record Length depends on MLEN.
5. Call the RDREC instruction with REQ = 1.

Result

The values from the measured value data record are transferred into the target data area.

Energy counters

7.1 How the energy meter works

Introduction

The SM 1238 Energy Meter 480VAC provides 42 energy counters that detect both line-based and phase-based energy values.

- Active energy (total, outflow, inflow)
- Reactive energy (total, outflow, inflow)
- Apparent energy (total)

How energy recording works

The Energy Meter calculates the active, reactive and apparent energy based on the measured currents and voltages and the calculation cycle. The active, reactive and apparent energies are updated in each calculation cycle.

Values retained through power interruption

All the counter states of the module are stored retentively in the Energy Meter. After an interruption (e.g. System power Off → System power On), the energy counting resumes using the retentively stored values.

Configuring

You configure the following settings for the energy counter:

- Activation of the gate for the energy counter
The gate allows you to start and stop the counters via output data (DQ bit). If you deactivate the gate, the count starts immediately when the Energy Meter is switched on.
- Modes of the energy counters
The energy counters count either infinitely or periodically. For periodic counting, the adjustable full-scale values are 10^3 , 10^6 , 10^{12} and 10^{15} Wh (Watt hour). When the full-scale value is exceeded, the energy counter begins again at 0. At the same time the overflow counter is incremented by 1 (see Resetting energy counter and overflow counters (Page 47)).

The settings apply to the energy counters for all phases.

Changing properties in RUN

You can change the following properties of energy counters in runtime:

- Enable / disable energy counter
- Reset energy counter
- Set initial values for the energy counter
- Change the mode of the energy counter

Automatic reset of the energy counter

The energy counters are automatically reset to "0" when parameter settings relevant to the energy counter are changed. In the case of phase-specific changing of parameter settings relevant to the energy counter only the energy counters of the respective phases are reset.

Changing of the following parameters results in resetting of the energy counters:

- Measurement type or range
- Electrical current transformer (primary current/secondary current)
- Voltage transformer (primary voltage/secondary voltage)
- Direction of current
- Full-scale value for energy counter
- Mode of the energy counter (infinite / periodic)

Example

The following figure shows the effect of initial value, reset and start/stop parameters with activated gating using the energy counter as an example:

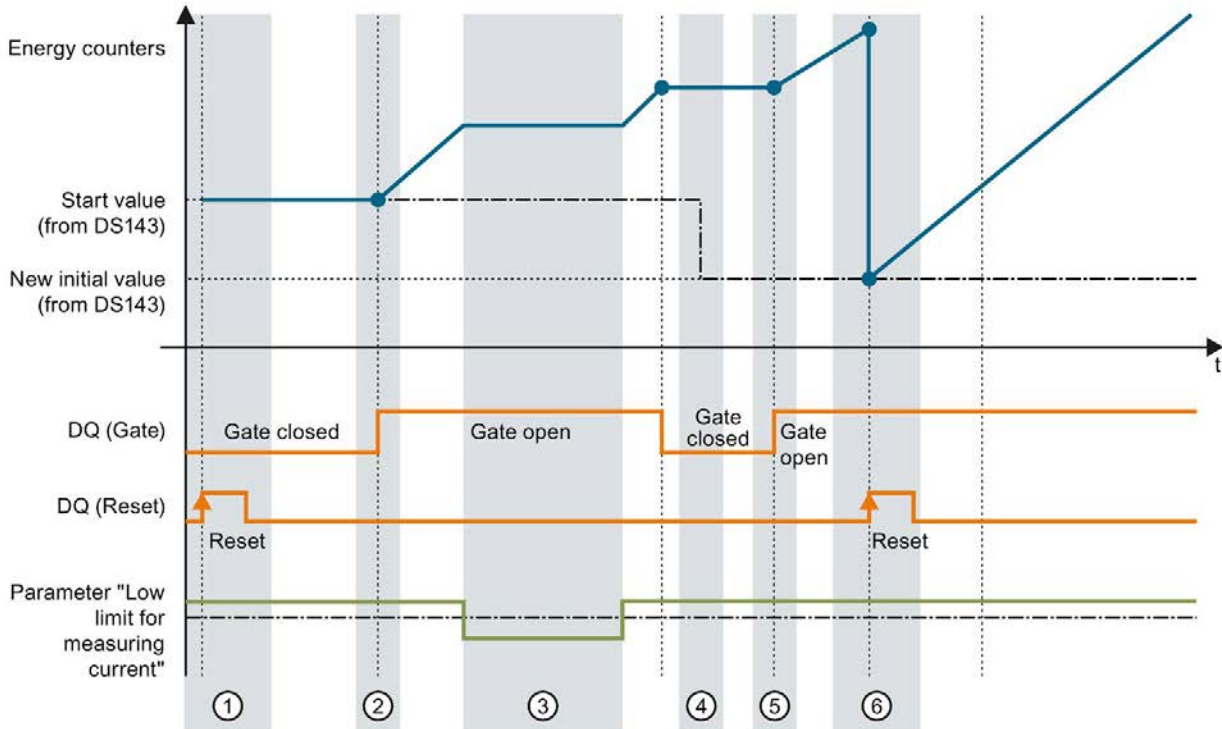

- ① The counter is reset to the value assigned in the configuration. The gate is closed. The counter does not count.
- ② The gate is opened via the control byte 1 in the output data of the Process data variant. The counter counts.
- ③ The current is less than the configured electrical current low limit. The counter does not count.
- ④ The gate is closed. The counter does not count. A new start value is written to the measured value data record 143 with the WRREC instruction.
- ⑤ The gate is opened again via the control byte 1 in the output data of the Process data variant. The counter counts with the new start value.
- ⑥ The counter is reset via the control byte 1 in the output data of the Process data variant. The counter counts from the new start value that was transferred from the measured value data record 143.

7.2 Configuring the energy counters

Overview

You can configure the various counters of the SM 1238 Energy Meter 480VAC as follows:

- Activate / Deactivate
- Start / stop counters using gate
- Set and reset start value

Energy counter gate control

You have the option of starting and stopping the energy counter using a gate. To use the gate function, you must:

- Enable the "Activate gate for energy meter" parameter in the configuration of the SM 1238 Energy Meter 480VAC.
- Set the DQ bit for the counter gate in the user data Control byte 1 of the output data (Bit 6 in Control byte 1).

The "Activate gate for energy meter" parameter and the DQ bit for the counter gate behave like the parallel connection of contacts.

Gate enabled: Gate "open" if DQ = "1"

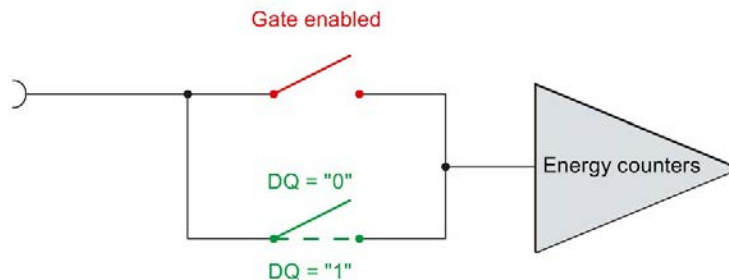

Figure 7-1 Gate switch activated

If you deselect the "Activate gate for energy meter" parameter in the configuration of the SM 1238 Energy Meter 480VAC, the energy counters operate independently of the DQ bit as long as the electrical current value lies above the configured "Low limit electrical current measurement".

Gate disabled: Gate is always "open" (signal path closed)

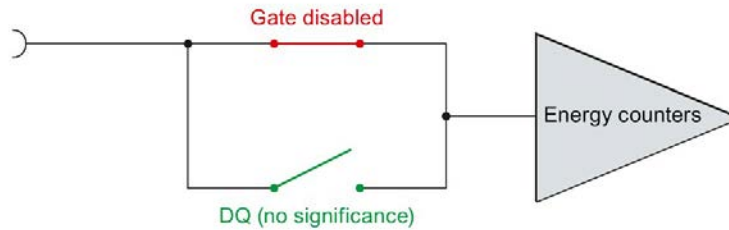

Figure 7-2 Gate switch deactivated

Set and reset start value

The counters can be set to their start value via the output data of each Process data variant. For energy counters, you must reset the bit of the energy counter in control byte 2 of the data record 143.

You can reset each energy counter to the start value or assign a new start value via the data record 143. You define the moment for updating of the start values in the data record 143 and the user data control byte 1. Start values are either applied immediately, or after a reset bit transition from 0 to 1.

You can find a detailed description of this behavior in section Resetting energy counter and overflow counters (Page 47).

7.3 Evaluating energy counters and overflow counters

Introduction

The energy counters are evaluated by:

- Using the input data of the Process data variants for energy
 - Process data variant "Total energy L1 L2 L3" (ID 249 or F9_H)
 - Process data variant "Energy L1" (ID 248 or F8_H)
 - Process data variant "Energy L2" (ID 247 or F7_H)
 - Process data variant "Energy L3" (ID 246 or F6_H)
- Using the input data of the Process data variant and the measured value IDs for energy counters
- By reading measurement data records
 - "Data record for basic measured values (DS 142)" for evaluation of the total energies L1 L2 L3
 - "Data record for energy counter (DS 143)" for evaluation of the phase-specific energy
 - "Data record for phase-specific measured values L1 - L3 (DS 147 - 149) for evaluation of the phase-specific energies

The overflow counters are evaluated by:

- Using the input data of the Process data variant and the measured value IDs for overflow counters
- Reading the "Data record for energy counters (DS 143)"

Evaluate measured values

The evaluation of measured values via the input data of Process data variants and reading of data records with the RDREC instruction is described in the section Reading and processing measured values (Page 34).

7.4 Resetting energy counter and overflow counters

7.4.1 Introduction

Introduction

At the beginning of a factory production run, it may be useful to reset the energy and overflow counters of the Energy meter. The energy counters are reset to their start values and the overflow counters are reset to 0.

The following section describes how to:

- Reset energy counters via the user data output data.
- Reset energy counters and overflow counters via data record 143.

7.4.2 Resetting energy counters by user data

Introduction

Due to the differing lengths of the output data, resetting the energy counters depends on the configured module version.

If you use module versions with 12 bytes output data, you can

- Reset energy counters for **all** phases separately by active, reactive and apparent energy.
- Reset energy counters for each **individual** phase separately by active, reactive and apparent energy.

If you use the module version with 2 bytes output data, you always reset **all** the energy counters simultaneously. Separate resetting of the active, reactive or apparent energy counters is only possible via data set DS 143, for details see section Resetting energy counters and overflow counters by data set DS 143 (Page 49).

Requirements

Resetting of the energy counters is enabled via user data in the default setting and may not be blocked in Control byte 1 of the data record 143.

Reset procedure for module versions with 12 bytes of output data

Resetting energy counters for all 3 phases

1. Select the categories of energy counter that you want to reset in byte 2:
 - Set bit 5 for active energy counters.
 - Set bit 6 for reactive energy counters.
 - Set bit 7 for apparent energy counters.

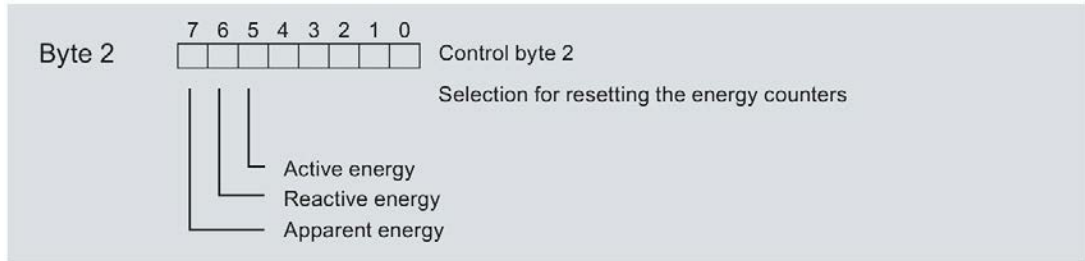

Figure 7-3 Selection of energy counters

2. Set the reset bit (bit 7) in byte 1.

If there is an edge change of the reset bit for energy counters from 0 to 1, the module resets all energy counters that you previously selected in byte 2.

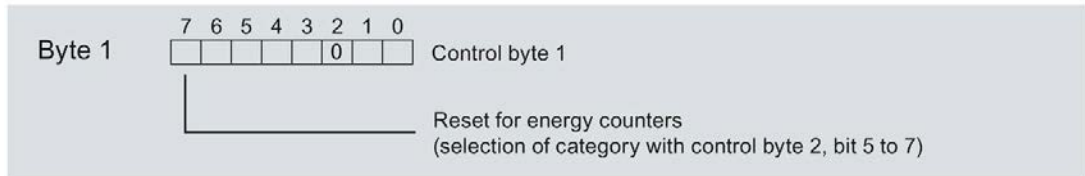

Figure 7-4 Reset bit for energy counters

Resetting energy counters for phase-specific measurement

You can also reset the energy counters on a phase-specific basis using the output data.

Follow the procedure for "Resetting energy counters for all 3 phases" as applicable.

1. Select the categories of energy counter that you want to reset on a phase-specific basis.
 - Set the bits for the phase 1 energy counters in byte 7.
 - Set the bits for the phase 2 energy counters in byte 9.
 - Set the bits for the phase 3 energy counters in byte 11.
2. Set the reset bit (bit 7)
 - in byte 6 for phase 1
 - in byte 8 for phase 2
 - in byte 10 for phase 3

If there is an edge change of the phase-specific reset bit for energy counters from 0 to 1, the module resets the energy counters for the given phase:

Reset procedure for module version with 2 bytes of output data

Set the reset bit (Bit 7) in Control byte 1 from 0 to 1 through a positive edge change.

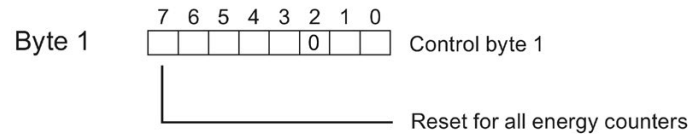

Figure 7-5 Resetting the energy counters for module version with 2 bytes of output data

Start values

After the reset, the energy counters count with the assigned start values (default = 0). You can change the start values for the energy counters via data record DS 143, for details see section Resetting energy counters and overflow counters by data set DS 143 (Page 49).

7.4.3 Resetting energy counters and overflow counters by data set DS 143

Introduction

You can reset the energy counters and their overflow counters, for all module versions via the data record DS 143. Resetting is possible for:

- Energy counters and overflow counters for each phase separately
- Active, reactive and apparent energy counters.

Procedure for all module versions using data record DS 143

1. In Control byte 1 of DS 143, set the reset bit (Bit 2) to 1 and Bit 0 to 1 for the overflow counter.
2. In Control byte 2 of DS 143, set the category of the energy counters (active, reactive, apparent energy) to 1 via Bits 5 to 7.
3. In Control byte 1 of DS 143, set Bit 7 for when to apply the start values to the desired energy counters:
 - Bit 7 to 0, if the start value is applied immediately after the transfer of the data record
 - Bit 7 to 1, if the start value is only applied after the reset bit has been set in the output data of the user data.

In Control byte 1 of the DS 143, set the reset bit (Bit 2) to 1 and Bit 0 to 1 for the overflow counter.

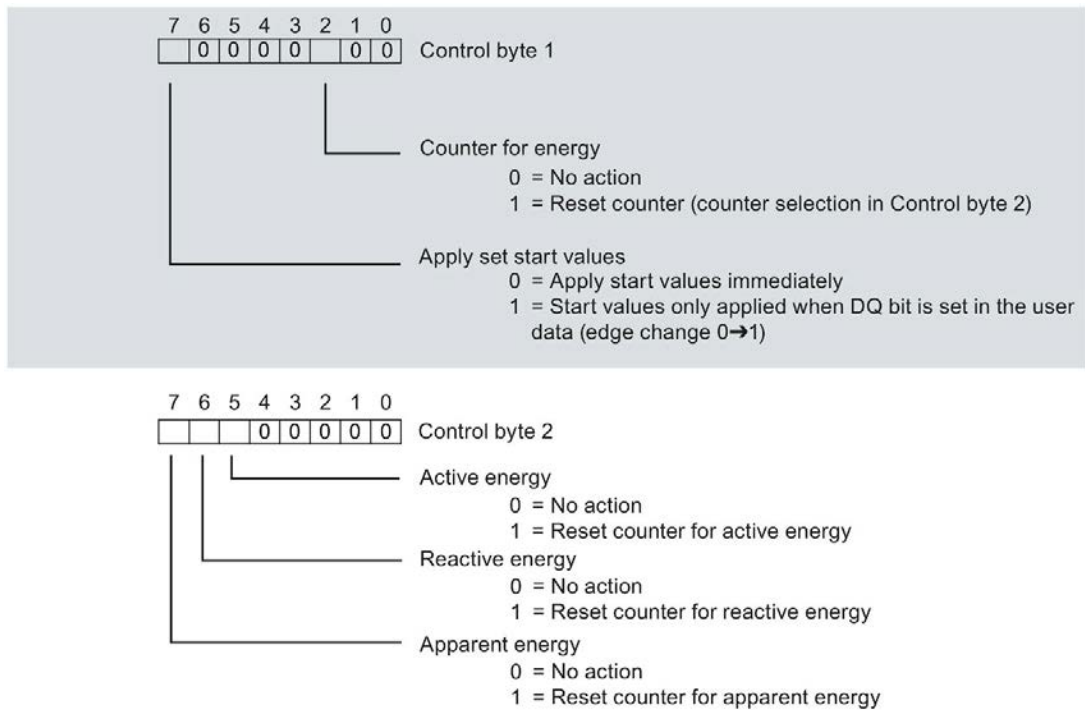

Figure 7-6 Energy counter control information DS 143

4. Transfer the data record with the WRREC instruction.

Start values

You can control when the start values are applied in Control byte 1 via Bit 7. After the reset, the energy counters count with the assigned start values (default = 0) and the overflow counters begin again with 0. You can change the start values for the energy counters via data record DS 143.

7.4.4 Example reset of energy counters and overflow counters by data set DS 143

Introduction

Before you can transfer the data record DS 143 to PLC memory, you have to create a user-defined PLC data type in your user program that has an identical structure to data record DS 143.

Procedure

1. Create a PLC data type that has an identical structure to data record DS 143.

Detailed information on the structure of data record 143 is available in section Structure of energy counter data DS 143 (Page 151).

Byte	Measured variable	Data type	Unit	Value range	Measured value ID
0	Version	BYTE	-	1	-
1	Reserved	BYTE	-	0	-
2	Control byte 1 - L1	BYTE	Bit string	-	-
3	Control byte 2 - L1	BYTE	Bit string		
4	Control byte 1 - L2	BYTE	Bit string		
5	Control byte 2 - L2	BYTE	Bit string		
6	Control byte 1 - L3	BYTE	Bit string		
7	Control byte 2 - L3	BYTE	Bit string		
8 ... 15	Active energy inflow (initial value) L1	LREAL	Wh		
16 ... 23	Active energy outflow (initial value) L1	LREAL	Wh	61181	
:	:	:	:	:	:
162 ... 165	Operating hours counter L2 (initial value)	REAL	h	See Section Structure of energy counter data DS 143 (Page 151)	65506
166 ... 169	Operating hours counter L3 (initial value)	REAL	h		65507

2. Create a user-defined PLC data type and allocate the values of the data record in a DB or instance DB.

Byte 0 and byte 1:

Enter the value 01_H in Byte 0 and the value 00_H to Byte 1.

Byte 2 ... byte 7: Control bytes for energy and overflow counter

In the control byte for the respective phases, assign which energy and overflow counters that you want to reset.

The control bytes assign each phase (L1, L2, L3) separately and which energy meter values to reset.

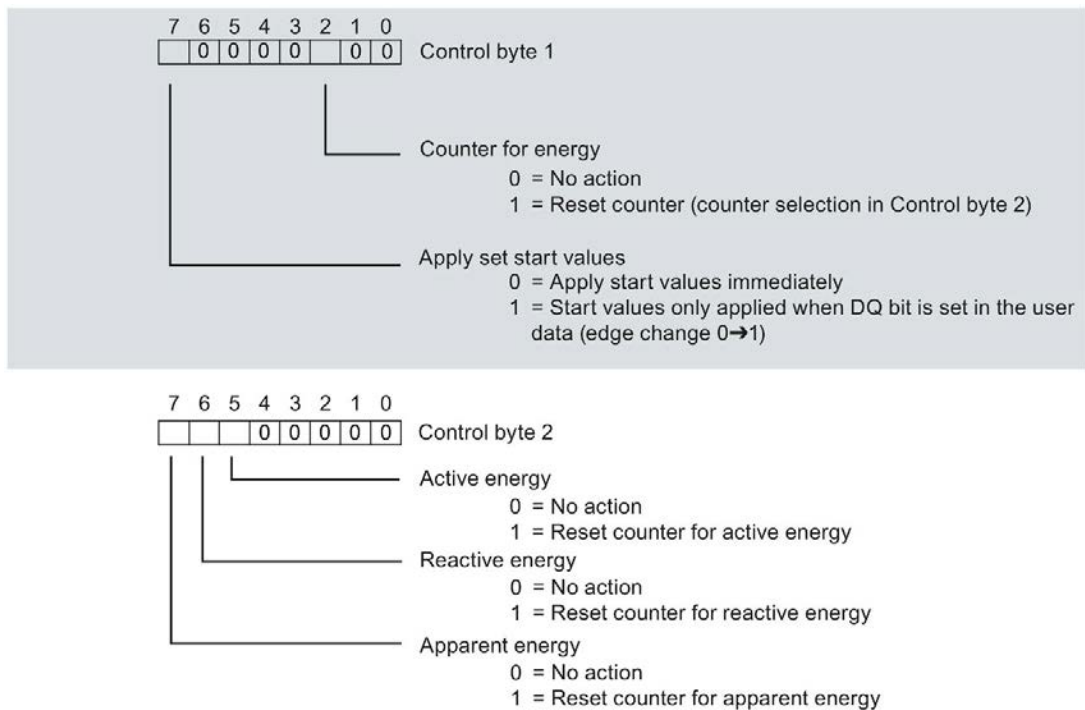

Figure 7-7 Control information DS 143 for energy and overflow counter

Byte 8 ... byte 127: Start values for the individual energy meters

The start values for energy counters in data record 143 are 64-bit floating point numbers. This format corresponds to the data type LREAL in the S7-1200 CPU.

Byte 128 ... byte 157: Initial values for overflow counters

The initial values for overflow counters in data record 143 are 16-bit integers. This format corresponds to the data type UINT in the S7-1200 CPU.

3. Write the data record to the SM 1238 Energy Meter 480VAC module using the "WRREC" instruction.

The input parameters must be allocated as follows:

- REQ: A new write job is triggered if REQ = TRUE.
- ID: Hardware identifier or start address of the Energy Meter (depending on the CPU used)
- INDEX: The data record number: 143
- LEN: The maximum length of the data record: 170
- RECORD: A pointer to the data area in the CPU which includes data record 143

Note

If you want to write or read several SM 1238 Energy Meter 480VAC modules at the same time, do not exceed the maximum number of active communication jobs allowed with SFB52/SFB53.

7.5 Data record for energy counters (DS 143)

7.5.1 Structure of energy counter data DS 143

Using energy meter data record 143

The energy meter data record 143 includes all energy counters available on the module phase-by-phase. The data record can be used for different actions:

- Reset the energy counter to an assigned value (e.g. "0")
- Read the values of the energy counters
- Read the overflow counters
- Read the operating hours

Energy meter data record 143

Table 7- 1 Energy meter data record 143

Byte	Measured variable	Data type	Unit	Value range	Measured value ID
0	Version	BYTE	-	1	-
1	Reserved	BYTE	-	0	-
2	Status / control byte 1 - L1	BYTE	Bit string	-	-
3	Status / control byte 2 - L1	BYTE	Bit string		
4	Status / control byte 1 - L2	BYTE	Bit string		
5	Status / control byte 2 - L2	BYTE	Bit string		
6	Status / control byte 1 - L3	BYTE	Bit string		
7	Status / control byte 2 - L3	BYTE	Bit string		
8 ... 15	Active energy inflow (initial value) L1	LREAL	Wh		
16 ... 23	Active energy outflow (initial value) L1	LREAL	Wh	61181	
24 ... 31	Reactive energy inflow (initial value) L1	LREAL	varh	61182	
32 ... 39	Reactive energy outflow (initial value) L1	LREAL	varh	61183	
40 ... 47	Apparent energy (initial value) L1	LREAL	VAh	61184	
48 ... 55	Active energy inflow (initial value) L2	LREAL	Wh	61200	
56 ... 63	Active energy outflow (initial value) L2	LREAL	Wh	61201	
64 ... 61	Reactive energy inflow (initial value) L2	LREAL	varh	61202	
72 ... 79	Reactive energy outflow (initial value) L2	LREAL	varh	61203	
80 ... 87	Apparent energy (initial value) L2	LREAL	VAh	61204	
88 ... 95	Active energy inflow (initial value) L3	LREAL	Wh	61220	
96 ... 103	Active energy outflow (initial value) L3	LREAL	Wh	61221	
104 ... 111	Reactive energy inflow (initial value) L3	LREAL	varh	61222	
112 ... 119	Reactive energy outflow (initial value) L3	LREAL	varh	61223	
120 ... 127	Apparent energy (initial value) L3	LREAL	VAh	61224	

Byte	Measured variable	Data type	Unit	Value range	Measured value ID
128 ... 129	Overflow counter active energy inflow L1	UINT	-	During reading: 0 ... 65535 During writing for continuous counting: 0 During writing for periodic counting: 0 ... 65500	61190
130 ... 131	Overflow counter active energy outflow L1	UINT	-		61191
132 ... 133	Overflow counter reactive energy inflow L1	UINT	-		61192
134 ... 135	Overflow counter reactive energy outflow L1	UINT	-		61193
136 ... 137	Overflow counter apparent energy L1	UINT	-		61194
138 ... 139	Overflow counter active energy inflow L2	UINT	-		61210
140 ... 141	Overflow counter active energy outflow L2	UINT	-		61211
142 ... 143	Overflow counter reactive energy inflow L2	UINT	-		61212
144 ... 145	Overflow counter reactive energy outflow L2	UINT	-		61213
146 ... 147	Overflow counter apparent energy L2	UINT	-		61214
148 ... 149	Overflow counter active energy inflow L3	UINT	-		61230
150 ... 151	Overflow counter active energy outflow L3	UINT	-		61231
152 ... 153	Overflow counter reactive energy inflow L3	UINT	-		61232
154 ... 155	Overflow counter reactive energy outflow L3	UINT	-		61233
156 ... 157	Overflow counter apparent energy L3	UINT	-	61234	
158 ... 161	Operating hours counter L1 (initial value)	REAL	h	During reading: 0 ... 3.4×10^{38}	65505
162 ... 165	Operating hours counter L2 (initial value)	REAL	h	During writing: 0 ... 10^9	65506
166 ... 169	Operating hours counter L3 (initial value)	REAL	h		65507

Status information

When data record 143 is read with the RDREC instruction, Bytes 2 to 7 supply phase-specific status information for energy counters, overflow counters, and operating hours counters.

The status information shows which counters are returning values in data record 143. If energy counters return values in the status byte 1, you can determine the type of energy counter with status byte 2.

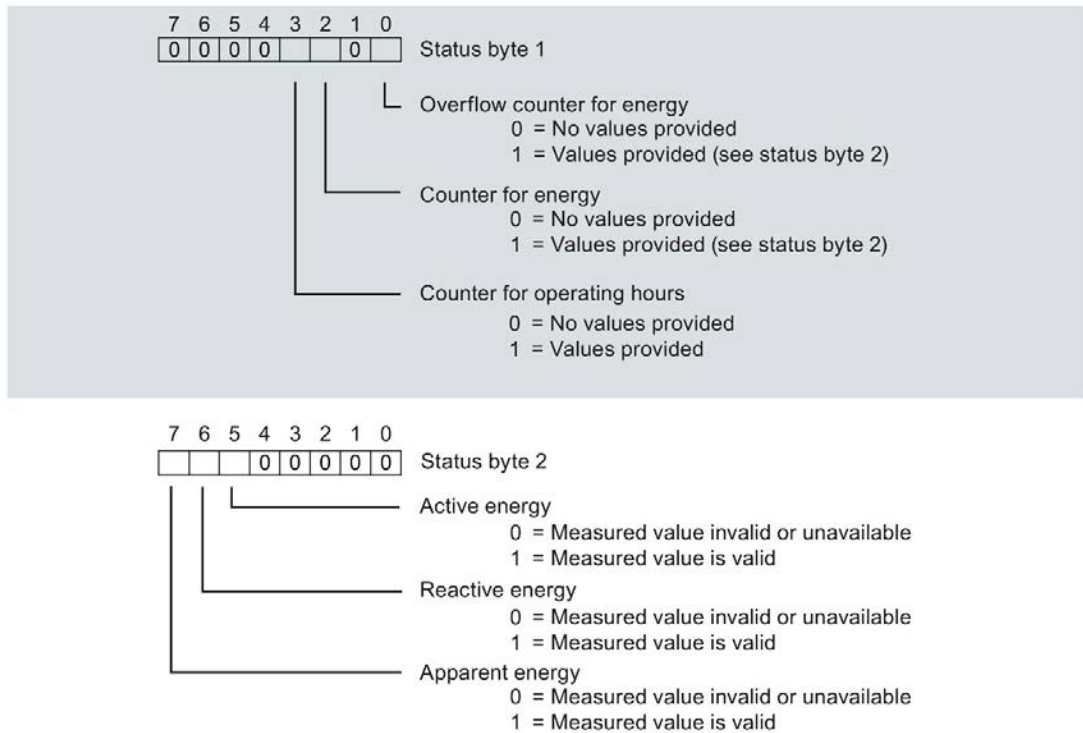

Figure 7-8 Status information DS 143

Control information

When data record 143 is written with the WRREC instruction, bytes 2 to 7 are used as phase-specific control information for energy counters, overflow counters, and operating hours counter. The length of the control information is 2 bytes for each phase:

- In control byte 1 you determine which counter you want to reset and the time when the counters are reset.
- In Control byte 2 you determine which energy counters and which overflow counters you want to reset.

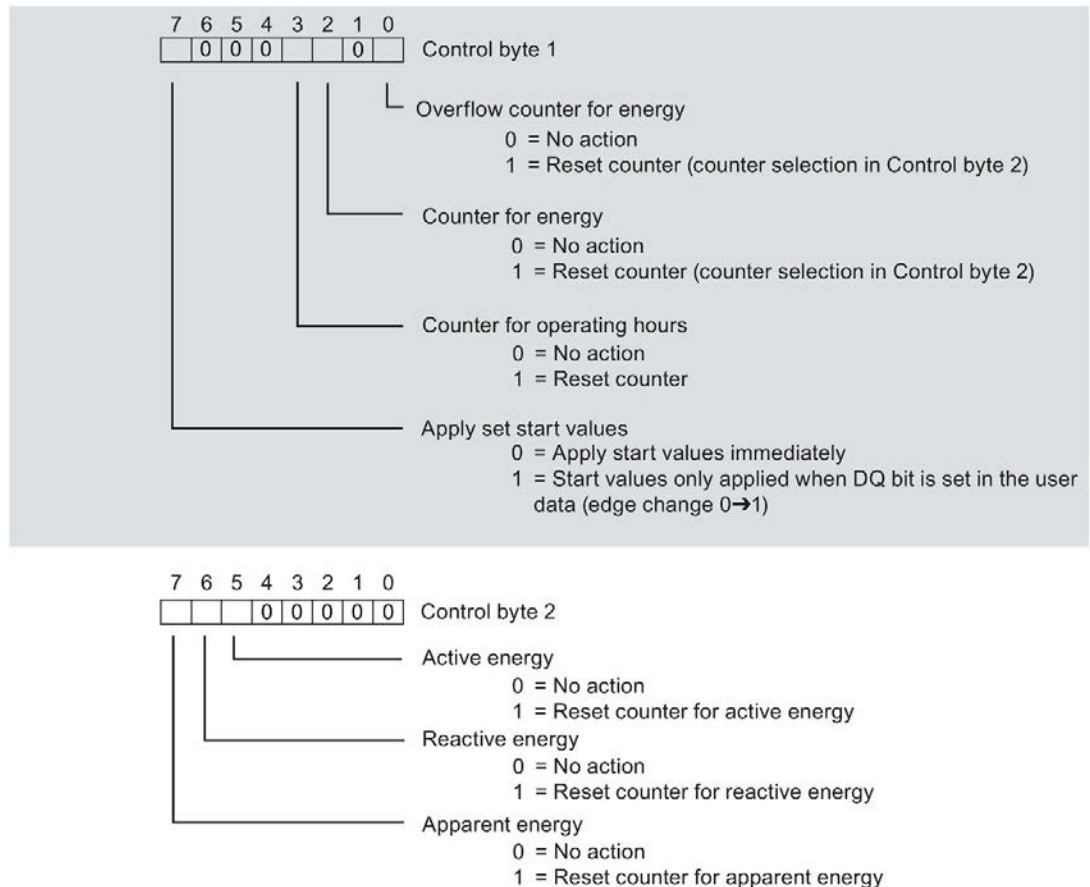

Figure 7-9 Control information DS 143

Error while transferring the data record

The module always checks all the values of the transferred data record. Only if all the values were transferred without errors does the module apply the values from the data record.

The WRREC instruction for writing data records returns error codes in the STATUS parameter, when errors occur.

The following table shows the module-specific error codes and their meaning for the measured value data record 143:

Error code in STATUS parameter (hexadecimal value)				Meaning	Solution
Byte 0	Byte 1	Byte 2	Byte 3		
DF	80	B0	00	Number of the data record unknown	Enter a valid number for the data record.
DF	80	B1	00	Length of the data record incorrect	Enter a valid value for the data record length.
DF	80	B2	00	Slot invalid or cannot be accessed.	Check the station whether the module is plugged in correctly. Check the assigned values for the parameters of the WRREC instruction
DF	80	E1	01	Reserved bits are not 0.	Check Byte 2 ... 7 and set the reserved bits back to 0.
DF	80	E1	39	Incorrect version entered.	Check Byte 0. Enter a valid version.
DF	80	E1	3A	Incorrect data record length entered.	Check the parameters of the WRREC instruction. Enter a valid length.
DF	80	E1	3C	At least one start value is invalid.	Check Bytes 8 ... 103 and Bytes 158 ... 169. The start values may not be negative.
DF	80	E1	3D	At least one start value is too large	Check Bytes 8 ... 103 and Bytes 158 ... 169. Observe the ranges of values for start values.

7.5.2 Structure of the control and feedback interface DS 143

Introduction

Bytes 2 to 7 of data record 143 form the phase-based control and feedback interface for the measured value data record of the energy counter.

- Bytes 2 and 3: Control and feedback interface for phase 1
- Bytes 4 and 5: Control and feedback interface for phase 2
- Bytes 6 and 7: Control and feedback interface for phase 3

Status information

When reading data record 143 with the RDREC instruction, bytes 2 ... 7 provide status information for the energy counter, overflow counter and operating hours counter.

The status information enables you to see which counters are returning their values in data record 143. If energy counters return their values in the status byte 1, then you can determine the type of energy counter with status byte 2.

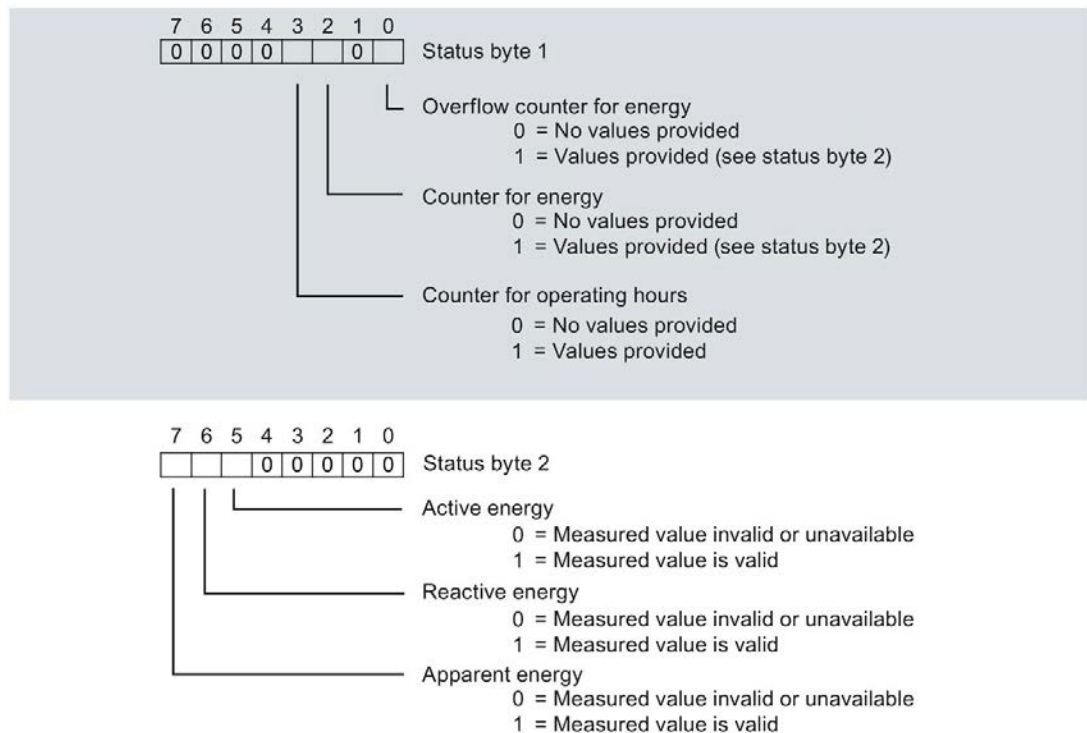

Figure 7-10 Status information DS 143

Control information

When data record 143 is written with the WRREC instruction, bytes 2 ... 7 are used as phase-specific control information for energy counters, overflow counters, and operating hours counter. The length of the control information is 2 bytes for each phase:

- In control byte 1 you determine which counter you want to reset and the time when counters are reset.
- In Control byte 2 you determine which energy counters and which overflow counters to reset.

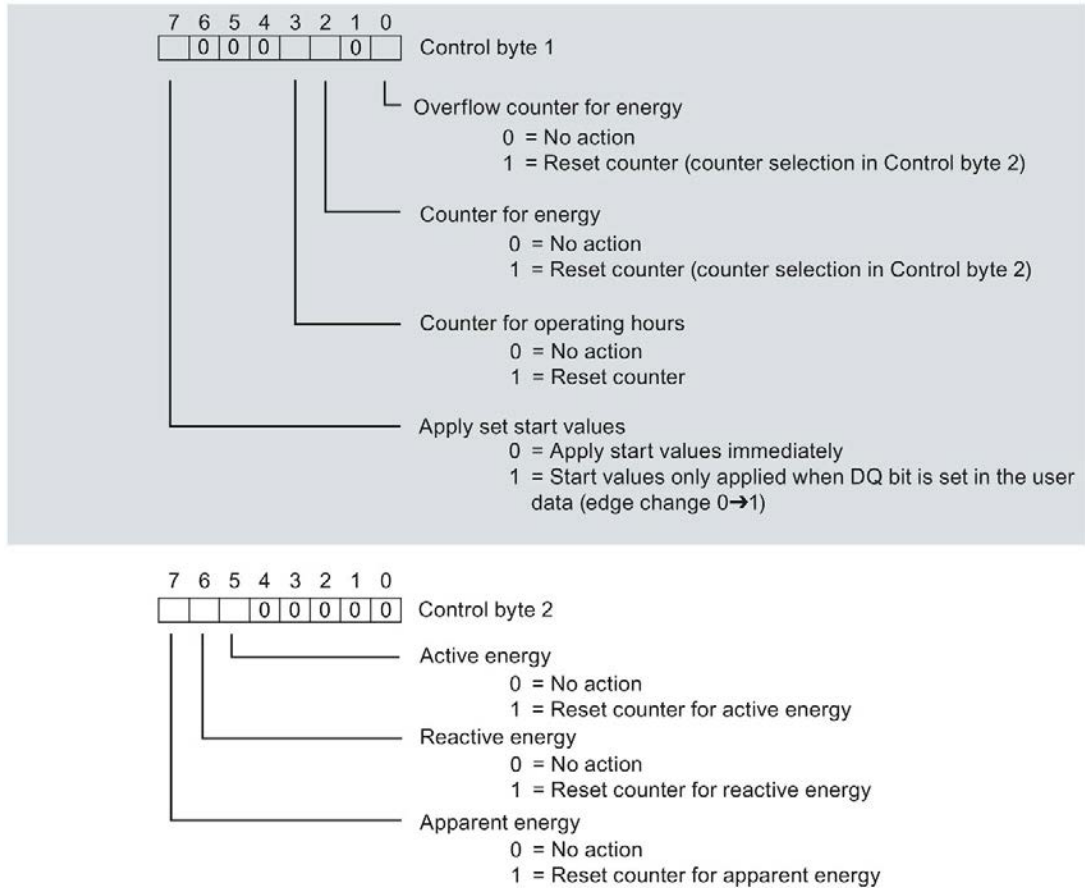

Figure 7-11 Control information DS 143

Operating hours counter

8.1 How the operating hours counter works

Introduction

The SM 1238 Energy Meter 480VAC provides one operating hour counter for each phase (L1:ID 65505, L2:ID 65506, L3:ID 65507). The operating hours of the load connected to a phase are counted when there is load current greater than the configurable "Low limit electrical current measurement". The operating hours value for all phases (L1L2L3:ID 65504) is the largest operating hour value accumulated on any one phase. The operating hours counter has a value range from 0 to 3.4×10^{38} . The values are stored retentively in the module and can be read via the data record 143 (energy counter data record) and data record 150 (Advanced measurements and status values).

Configuring

You configure the following operating hours counter setting in STEP 7 (TIA Portal):

- Activation of the gate for the operating hours counter

Changing properties in RUN

The following table shows the supported control information:

Control information	Default value	Available in
Open / close operating hours counter gate ¹	Closed	Module version output user data ²
Set initial value	0	Data record 143
Reset operating hours counter	0	Module version output user data ²

¹ Effective only with enabled gate configuration

² Gate and reset control for individual phases is supported only for module versions with 12 bytes of output user data.

8.2 Resetting the operating hours counter

8.2.1 Introduction

Introduction

At the beginning of a factory production run, it may be useful to reset the operating hours counters of the Energy meter. Resetting here means that the operating hours counters are reset to their start value.

The following section describes how you

- Reset operating hours counters via the outputs of the user data.
- Reset operating hours counters via data record 143.

8.2.2 Resetting the operating hours counter by user data

Introduction

Due to the differing lengths of the output data, resetting the operating hours counters depends on the configured module version.

If you use module versions with 12 bytes output data, you can

- Reset operating hours counters for **all** phases.
- Reset operating hours counters for each **individual** phase.

If you use the module version with 2 bytes output data, you always reset **all** the operating hours counters simultaneously. Resetting the counters by phases is only possible via data set DS 143 for this module version, for details see section Structure for energy counters (DS 143) (Page 151).

Reset procedure for module versions with 12 bytes of output data

Set the reset bit (Bit 5) in Control byte 1 from 0 to 1 through a positive edge change.

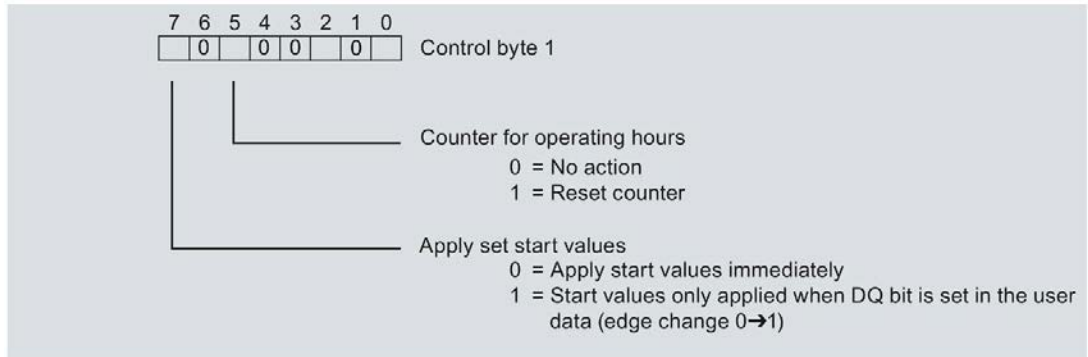

Figure 8-1 Resetting the operating hours counters for module versions with 12 bytes of output data

Reset procedure for module version with 2 bytes of output data

Set the reset bit (Bit 5) in Control byte 1 from 0 to 1 through a positive edge change.

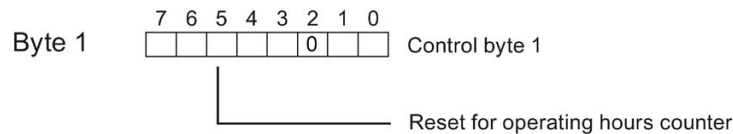

Figure 8-2 Resetting the operating hours counters for module version with 2 bytes of output data

Start values

After the reset, the operating hours counters count with the assigned start values (default = 0). You can change the start values for the operating hours counters via data record DS 143, for details see section Structure for energy counters (DS 143) (Page 151).

8.2.3 Resetting the operating hours counter by data set DS 143

Introduction

For all the module versions, you can reset the operating hours counters via the data record DS 143. Resetting the Operating hours counters for each individual phase is possible.

Procedure for all module versions via data record DS 143

1. Set the reset bit (Bit 3) in Control byte 1 to 1.
2. In Control byte 1, set Bit 7 for when to apply the start values:
 - Bit 7 to 0, if the start values are applied immediately after the transfer of the data record
 - Bit 7 to 1, if the start values are only applied after the reset bit has been set in the output data of the user data.

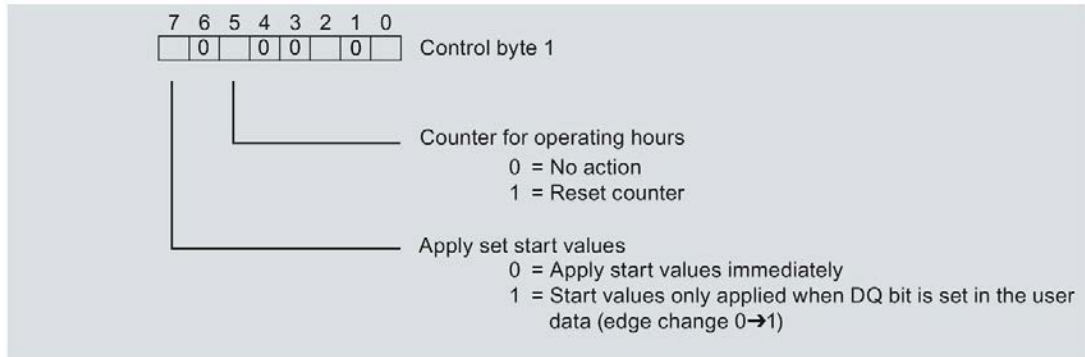

Figure 8-3 Operating hours counter control information DS 143

Start values

You assign when the start values are applied in Control byte 1 via Bit 7. After the reset the operating hours counters, count with the assigned start values (default = 0). You can change the start values for the operating hours counters via data record DS 143.

Minimum and maximum values

9.1 Minimum and maximum values

Introduction

The SM 1238 Energy Meter 480VAC stores the highest and lowest measured or calculated value, for a series of measured and calculated values. The values are stored retentively in the module and can be read using measured value data records 144 and 145.

Benefits

Your program logic can read peak values and detect irregularities in power consumption.

Calculation of minimum and maximum values

Minimum and maximum values are calculated only for phases that are used with the configured connection type. Existing minimum and maximum values that are not calculated are initialized with 0. If faults such as under or overcurrent occur during operation, then new minimum and maximum values are calculated.

The measured and calculated values are initialized as follows during commissioning of the SM 1238 Energy Meter 480VAC. These initial values ensure that the first calculation of minimum and maximum values provides a plausible result:

- Maximum values for measured and calculated values are initialized with minimum values.
- Minimum values for measured and calculated values are initialized with maximum values.

Configuring

You must configure the module with the STEP 7 (TIA Portal) Device configuration to activate the minimum and maximum values feature.

Enable calculation of minimum and maximum values in the Module parameters > AI configuration > Measurement properties.

Reset minimum and maximum values in RUN mode

Your program logic can write the PLC output Q bytes in the I/O interface that control the SM 1238 Energy Meter 480VAC value reset process.

Note

Automatic reset

If you change the parameters for current or voltage transformers, the minimum and maximum values are reset automatically to their initial values.

9.2 Resetting minimum and maximum values

Description

At the beginning of a factory production run, it may be useful to reset the minimum and maximum values of the Energy Meter. The minimum and maximum values are reset to their initial values. Initial values are described, in section Measured value record for maximum values (DS 144) (Page 156) and section Measured value record for minimum values (DS 145) (Page 157).

The size of the output data interface (2 bytes or 12 bytes) is determined by the configured Module version parameter.

If you use the module version "2 bytes I/ 2 bytes O" with a program interface of 2 Q bytes:

- You can only reset all minimum and maximum values of all variables on all three phases simultaneously.

If you use any of the other module versions, then you get a program control interface of 12 Q bytes:

- You can select which minimum and maximum values to reset and then reset these values on all three phases simultaneously **or**
- You can assign which values to reset for each of the three phases (the same or different variables for each phase) and then reset the minimum and maximum values for each phase.

Reset procedure for "2 bytes I/ 2 bytes O" module version

Set the reset bit (bit 0 or bit 1) in Control byte 1 from 0 to 1 through a positive edge transition.

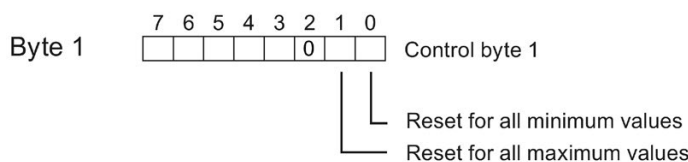

Figure 9-1 Resetting all minimum and maximum values for all phases with "2 bytes I/ 2 bytes O" module version

Reset procedure for module versions with 12 bytes of output data

1. Set the category bits (bits 0 ... 4) of the measured values that you want to reset to 1 in control byte 2 (all phases), byte 7 (phase 1), byte 9 (phase 2), or byte 11 (phase 3).
2. Set the reset bit 0 (minimum values) or bit 1 (maximum values) in Control byte 1 (all phases), byte 6 (phase 1), byte 8 (phase 2), or byte 10 (phase 3), from 0 to 1 creating a positive edge change in the output Q data.

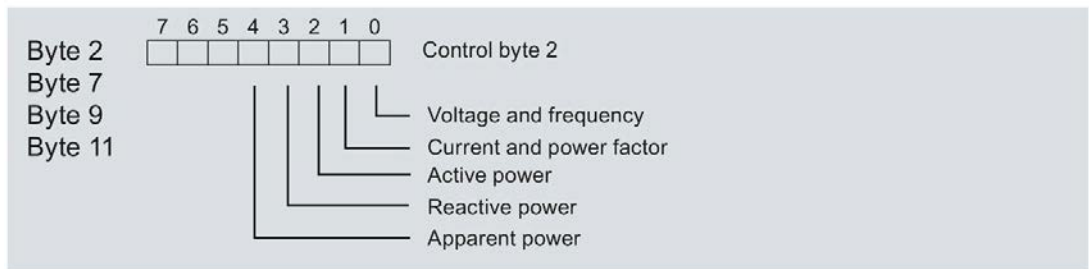

Figure 9-2 Resetting selected phases and minimum and maximum values, for module versions with 12 bytes of output data

Phase-based measurements

10.1 Phase-based measurements

Introduction

The SM 1238 Energy Meter 480VAC makes the measured values of individual phases available.

- Via Process data variants
 - Phase L1 measurements with Process data variants 154 (9A_H) and 155 (9B_H)
 - Phase L2 measurements with Process data variants 156 (9C_H) and 157 (9D_H)
 - Phase L3 measurements with Process data variants 158 (9E_H) and 159 (9F_H)
- Via measured value data records
 - Phase L1, L2 and L3 measurements with data record 142
 - Phase L1 measurements with data record 147
 - Phase L2 measurements with data record 148
 - Phase L3 measurements with data record 149

Process data variants

Using Process data variants 154 (9A_H) ... 159 (9F_H), you can evaluate the following measured values for each phase of an AC / three-phase network:

- Quality information
- Current and voltage
- Active, reactive and apparent power
- Active, reactive and apparent energy
- Power factor

You can find the structure of the Process data variants in section L1 phase-based values data record (DS 147) (Page 158).

Measured value data records

Using measured value data records DS 142, DS 147, DS 148, and DS 149 you can evaluate the following measured values for each phase of an AC three-phase network:

- Quality information
- Current and voltage
- Minimum current and minimum voltage
- Maximum current and maximum voltage
- Active, reactive and apparent power
- Minimum active, reactive and apparent power
- Maximum active, reactive and apparent power
- Active, reactive and apparent energy
- Minimum active, reactive and apparent energy
- Maximum active, reactive and apparent energy
- Power factor
- Minimum power factor
- Maximum power factor

You can find the structure of the measured value data records in section L1 phase-based values data record (DS 147) (Page 158).

Configuration with the TIA Portal

11.1 TIA Portal Device configuration

Drag the SM 1238 Energy Meter 480VAC module from the hardware catalog and drop it in a rack image. When you click on the SM 1238 Energy Meter 480VAC image in the rack, a blue line highlights the module and you can set parameters that appear below on the General tab > Properties tab.

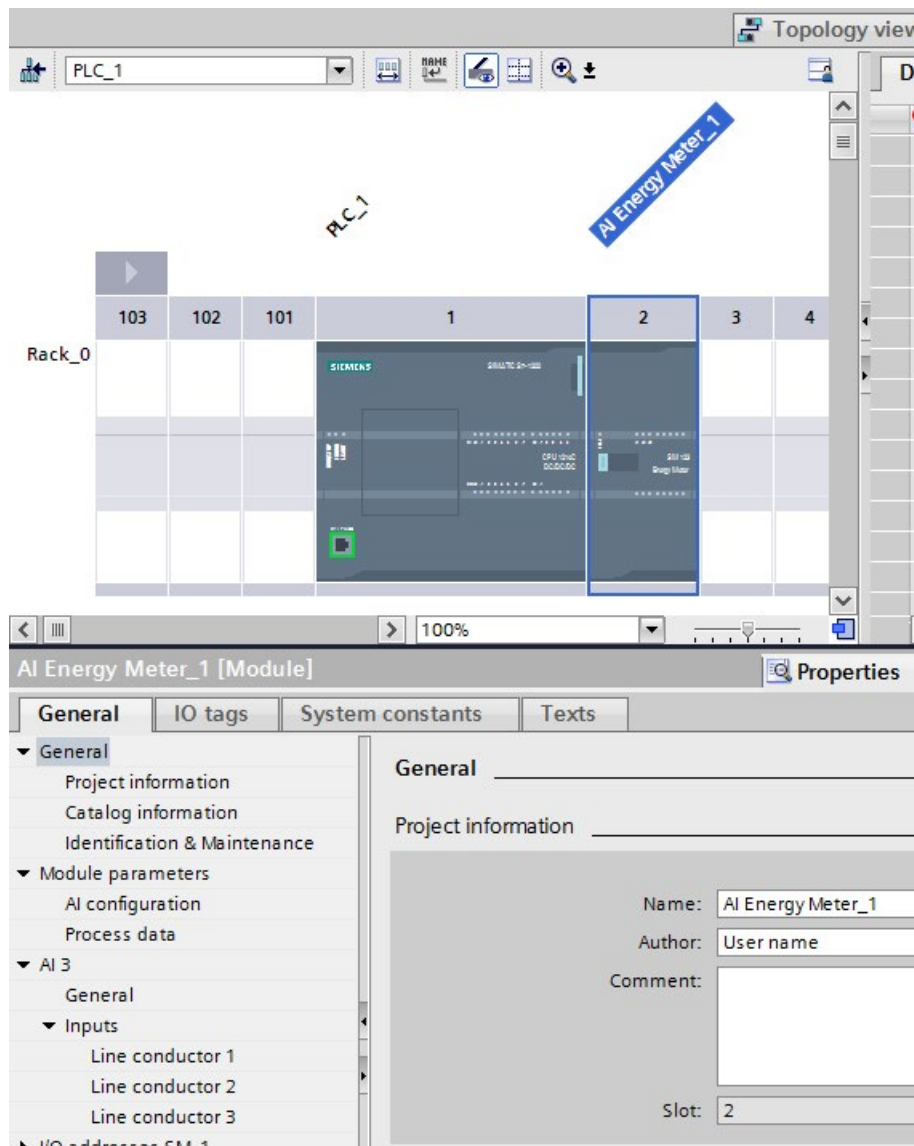

11.2 General information parameters

Enter the general project, identification, and maintenance information.

11.3 Module parameters

11.3.1 AI configuration parameters

11.3.1.1 Diagnostics (module scope parameters)

Note: Bold font indicates the factory default setting for configuration parameters.

Diagnostics (AI configuration)

Line voltage diagnostics

- Enable/**disable** optional line voltage diagnostics

Line voltage tolerance

- Enter the percentage deviation allowed (1% ... **10%** ... 50%). If enabled, deviation +/- outside this value triggers the line voltage diagnostic interrupt and "No supply voltage at L1" error message.

See also

Connection examples (Page 19)

11.3.1.2 Measurement (module scope parameters)

Measurement (AI configuration)

Connection type

- Select the AC power connection that you want to use. For wiring details, see the Connection examples (Page 19) section.
 - Disabled
 - 1P2W 1-phase, 2-wire:
Single phase measurement, two conductors, with or without voltage transformers, with one electrical current transformer
 - **3P4W 3-phase, 4-wire:**
3-phase measurement, four conductors, symmetrical and asymmetrical load, with or without voltage transformers, with three electrical current transformers
 - 3P4W1 3-phase, 4-wire, symmetrical load:
3-phase measurement, four conductors, symmetrical load, with or without one voltage transformer, with one electrical current transformer
 - 3x1P2W 3 x 1-phase, 2-wire each:
3x single phase measurement, two conductors, with or without voltage transformers, with three electrical current transformers
 - 2P3W 2 phase 3-wire:
2-phase measurement, three conductors, asymmetrical load, without voltage transformers, with two electrical current transformers

Voltage measuring range

- Select the phase voltage of your AC power.
 - 100 V
 - 110 V
 - 115 V
 - 120 V
 - 127 V
 - 190 V
 - 200 V
 - 208 V
 - 220 V
 - **230 V**
 - 240 V
 - 277 V

Line frequency

- Select the frequency of your AC power line.
 - 1 = 50 Hz
 - 2 = 60 Hz

Final value

- Select the full-scale watt hours value for periodic counting of the energy counter. The energy counters count up to a maximum value that you can assign, reset themselves automatically to "0", and continue counting energy usage. This behavior and the maximum (final) value are the same for all energy counters. The overflow counter counts the number of full-scale resets that occur.
 - No end value (count indefinitely)
 - **Count periodically to 10³ Wh (Watt hour)**
 - Count periodically to 10⁶ Wh
 - Count periodically to 10⁹ Wh
 - Count periodically to 10¹² Wh
 - Count periodically to 10¹⁵ Wh

Activate gate for energy meter

- **Enable/disable** gate circuit: When this option is enabled, the energy counter only counts when the corresponding output data bit (DQ bit) is set to 1.

Minimum and maximum value

- **Enable/disable** calculation of the minimum and maximum values. The minimum and maximum values are calculated from the start of the measurement. The calculated values are stored retentively and without a time stamp.

11.3.2 Process data parameters

11.3.2.1 Operating mode

Operating mode (Process data configuration)

Module version

- Select a Module version. The Module version selection affects user data interface size and process data availability. When you select module versions 32 bytes I/ 12 bytes O or 112 bytes I/ 12 bytes O, the Process data variant drop-list selector is enabled and you can select a Process data variant option. You can change to a different Process data variant in RUN mode with your program logic. The fixed format module version selections below use fixed user data and you cannot assign alternative Process data variants.
 - 2 bytes I/ 2 bytes O (fixed format)
 - 32 bytes I/ 12 bytes O (Process data variant format options enabled)
 - **112 bytes I/ 12 bytes O** (Process data variant format options enabled)
 - EE@Industry measured data e3 (fixed format)
 - EE@Industry measured data e2 (fixed format)
 - EE@Industry measured data e1 (fixed format)
 - EE@Industry measured data e0 (fixed format)

Process data variant

- Select the "Process data variant" to use with the "32 bytes I/12 bytes O" or "112 bytes I/12 bytes O" module versions. The module uses the selected Process data variant at power up. For measurement details, see the appendix D section Overview of data variant options (Page 126). The hexadecimal number following the variant name is the ID value for that variant.
 - **Total power L1, L2, L3 (FE_H)**
 - Active power L1, L2, L3 (FD_H)
 - Reactive power L1, L2, L3 (FC_H)
 - Apparent power L1, L2, L3 (FB_H)
 - Basic measurement values L1, L2, L3 (FA_H)
 - Total energy L1, L2, L3 (F9_H)
 - Energy L1 (F8_H)
 - Energy L2 (F7_H)
 - Energy L3 (F6_H)
 - Basic values 3-phase measurement L1, L2, L3 (F5_H)
 - Quality values 3-phase measurement L1, L2, L3 (F0_H)
 - Energy measurement (periodical) overage meter (EF_H)
 - EE@Industry measured data e3 (E3_H)
 - EE@Industry measured data e2 (E2_H)
 - EE@Industry measured data e1 (E1_H)
 - EE@Industry measured data e0 (E0_H)
 - Basic values single phase measurement L1 (9F_H)
 - Basic values single phase measurement L1a (9E_H)
 - Basic values single phase measurement L2 (9D_H)
 - Basic values single phase measurement L2a (9C_H)
 - Basic values single phase measurement L3 (9B_H)
 - Basic values single phase measurement L3a (9A_H)

11.4 AI 3 (AC phase parameters)

11.4.1 Inputs (phase channel parameters)

11.4.1.1 Line conductors 1, 2, and 3 parameters

Diagnostics (channel scope parameters)

Line conductor diagnostics configuration

Depending on your assignment of the connection type parameter, one or three line conductors are available for configuration in the Inputs parameter group.

Diagnostics (AI 3 configuration)

- Enable the Diagnostics you want, for each phase.
 - Diagnostics **overflow current** (enable\disable)
The measured current is monitored for "Tolerance factor × Measured current" after the "Tolerance time" elapses. A violation results in an electrical current overflow.

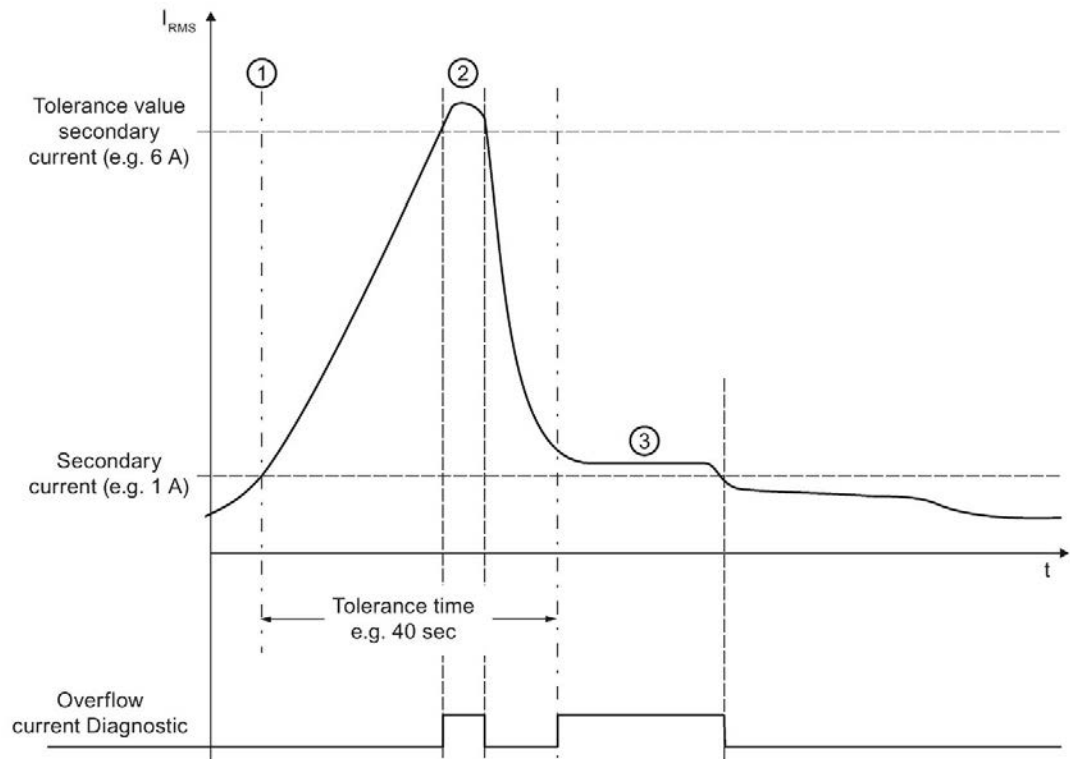

- ① The tolerance time starts as soon as the secondary electrical current value (1 A, 5 A) is exceeded.
- ② Overflow current diagnostic condition for the affected phase if the tolerance value of the secondary electrical current has been exceeded
- ③ After the set tolerance time has elapsed, the secondary electrical current value (1 A, 5 A) is monitored. A violation of the secondary electrical current value also returns the overflow current diagnostic condition.

Figure 11-1 Diagnostic response to an overcurrent event

- Diagnostics **overflow voltage** (enable\disable)
Line voltage (measuring range) is monitored for tolerance. A violation of the overflow triggers a diagnostic interrupt.
- Diagnostics **underflow voltage** (enable\disable)
Line voltage (measuring range) is monitored for tolerance. A violation of the underflow triggers a diagnostic interrupt.
- Diagnostics of **low limit voltage** (enable\disable)
Select this check box if you want a diagnostic interrupt to be triggered with the low limit for voltage is reached.

- Diagnostics overflow cumulative values (enable\disable)
A cumulative overflow in the calculated variables is displayed. The values stop at the high or low limit.

Tolerance factor overcurrent

- Enter the tolerable value of the secondary current of the transformer in 0.1A increments from 10 (1 A) ... **100** (10 A). Always verify that the current class of the transformer (1 A, 5A, ...) is appropriate.

Tolerance time overcurrent

- The monitoring time that a secondary overcurrent of the transformer is tolerated. Enter a value in millisecond units (0 ... **40000** ... 60000). A value of zero means that the monitoring time is disabled.

Measurement (channel scope parameters)

Line conductor measurement configuration

Depending on your assignment of the connection type parameter, one, two, or three line conductors are available for configuration in the Inputs parameter group. You can assign the Measurement properties for each phase that you are using.

Operating hours counter

- Assign operating hours counter properties for each AC power phase
 - Enable/**disable** operating hours counter
The counting starts from a programmable minimum value. The counter can be reset or pre-defined using data record or output bit.
 - Enable/**disable** operating hours gate control.
When the gate is activated, the operating hours counter only counts when the corresponding output data bit (DQ bit) is set to "1".

Primary current of electrical current transformer

- Assign a primary current in Amperes 1 ... 99999 (default value is **1 A**). The primary and secondary electrical current values that you assign identify the transfer factor of the electrical current transformer. The transfer factor is the multiplier for the measured current that is used to calculate the actual phase current.

Secondary current of electrical current transformer

- Select the electrical current transformer nominal secondary current value from the two drop-list options
 - **1 A**
 - 5 A

Transformer primary voltage

- Assign a primary voltage in volts (1 ... 230 ... 999999). The primary and secondary voltage values that you assign identify the transfer factor of a voltage transformer. The transfer factor is the multiplier for the measured voltage that is used to calculate the actual phase voltage.

Transformer secondary voltage

- Assign a secondary voltage in volts (1 ... 230 ... 500).

Note

You must ensure that the actual secondary voltage applied to the module's ULx inputs does not exceed the expected 277 VAC maximum.

Lower limit electrical current measurement

- Assign an electrical current limit in milliamperes (20 ... 50 ... 250). Measured currents under this limit are not recorded.
The low limit for measuring current refers to the secondary electrical current of the transformer and is used to prevent inaccurate calculations when there are very low currents. By default, the low limit for electrical current measurement is set to 50 mA. Set the low limit for the electrical current measurement to the required value depending on your process.

Tip: If you want to find the low limit for the electrical current measurement experimentally, set it to a lower value. Then, feed in a very precise low current and determine the measurement error that you can tolerate. Afterwards, set the low limit for the electrical current measurement to the limit value that you have determined.

If current falls below the low limit for the electrical current measurement, the following measured values and derived values of the affected phase are reset.

- Effective electrical current value
 - Neutral conductor current
 - Active power
 - Reactive power
 - Apparent power
 - Phase angle
 - Power factor
- A moving mean value is formed from the power values and they only become "0" after a delay time. The energy meters for active, reactive and apparent energy of the reset phase stop measuring.

Reverse electrical current direction

- Select whether or not to reverse the interpretation of electrical current direction, for this AC power phase. In the event of incorrect reversed connection of an electrical current transformer winding, this parameter can be used to correct the measured values and prevent rewiring to correct the wiring error. The direction of the current is only evident in the power measurement values. The electrical current measurement value is an unsigned rms value.
 - Disabled
 - Reverse electrical current direction

11.5 I/O addresses

11.5.1 I/O start addresses, Process image update and PIP partition

I/O address parameters

When you place one or more SM 1238 Energy Meter 480VAC modules in the TIA Portal Device configuration rack image, the I/O address blocks are automatically assigned. The input addresses are assigned in 32 byte maximum submodule blocks, so the 32 bytes I/ 12 bytes O module version setting uses one 32 byte input address block and the 112 bytes I/ 12 bytes O module version must use four 32 byte input address blocks.

For the 112 bytes I/ 12 bytes O module version, four address blocks appear in the configuration properties as four I/O address submodule groups (i.e. SM_1, SM_2, SM_3, and SM_4). The first block assigns addresses to 32 input bytes and 12 output bytes. The other address blocks assign the remainder of the input addresses and no output addresses.

When the address blocks are correctly assigned, multiple blocks of input addresses must not overlap and must be a contiguous block of addresses. It is possible that, for example, you could put more than one SM 1238 module in the rack and find the automatic assignment of input address has assigned non-contiguous input addresses. In this case, the hardware configuration compilation will fail. You must correct the start addresses to ensure multiple address blocks are contiguous and recompile the configuration successfully.

Input addresses

- Assign properties to the input I addresses that are read by your program logic.
 - Start address: Automatic or manual entry
 - End address: Automatically calculated and entry field disabled
 - Organization block: Accept the "Automatic update" default assignment or select a different OB for a time critical I/O process image update.
 - Process image: Accept the "Automatic update" default assignment or assign a Process Image Partition for the I/O data.

Output addresses

- Assign properties to the output Q addresses that are written by your program logic.
 - Start address: Automatic or manual entry
 - End address: Automatically calculated and entry field disabled
 - Organization block: Accept the "Automatic update" default assignment or select a different OB for time critical I/O process image update.
 - Process image: Accept the "Automatic update" default assignment or assign a Process Image Partition for the I/O data.

11.5.2 Hardware identifier

The hardware identifier is automatically assigned and the entry field is disabled.

Status LEDs and diagnostic interrupt alarms

12.1 Status and error LED display

DIAG and L1, L2, L3 LED displays

In the following diagram, the DIAG LED and the three phase status LEDs are colored in green. The other LED positions are not used.

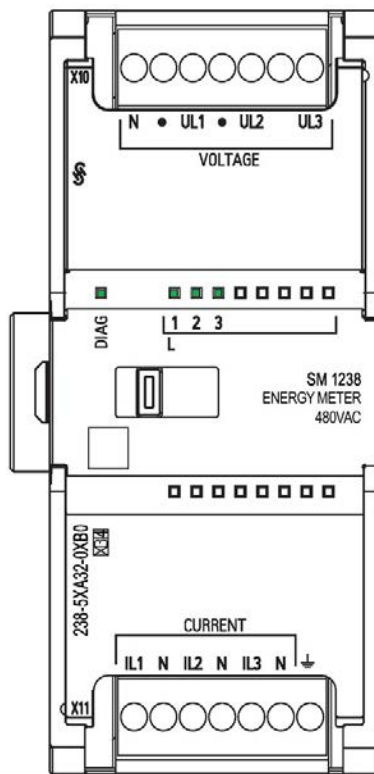

Figure 12-1 LED display





Meaning of the LED displays

The following table explains the meaning of the DIAG and phase status LED displays.

Corrective measures for diagnostic alarms can be found in the Diagnostic alarms (Page 84) section.



DIAG LED

Table 12- 1 Meaning of the DIAG LED

DIAG	Meaning
Off 	Supply voltage of the S7-1200 not OK
Green flashing 	Module not ready for operation (no parameters assigned)
Green On 	Module parameters assigned and module running properly
Red flashing 	Module parameters assigned and module diagnostic error detected

L 1, 2, 3 phase status LEDs

Table 12- 2 Meaning of the Status LED

Status	Meaning
Green On 	Channel configured and no fault has been detected.
Red flashing 	There is an error with this phase or no voltage is applied.
Red flashing on all phase LEDs 	SM 1238 Energy Meter 480VAC firmware loader is active. Note: If the phase LEDs continue flashing indefinitely after a firmware update attempt, see the Firmware updates and S7-1200 CPU version compatibility (Page 14) topic.

12.2 Diagnostic alarms

Diagnostic alarms

The SM 1238 Energy Meter 480VAC module supports diagnostic error interrupt events shown in the following table.

Note

Assignment channel in diagnostic message ↔ Phase

In the diagnostic messages the channels are counted from "Channel "0" on, in the SM 1238 Energy Meter 480VAC from Phase "1" on.

Note the following assignment:

- Channel "0" ↔ Phase "1"
 - Channel "1" ↔ Phase "2"
 - Channel "2" ↔ Phase "3"
-

Table 12-3 Error codes

Diagnostic alarm	Error code	Meaning	Remedy
Undervoltage ¹	2 _H	Line voltage (measurement range) is monitored for tolerance. Violation leads to voltage overflow/underflow error.	Observe the line voltage range
Overvoltage	3 _H		
Overload	4 _H	The measured current is monitored after expiration of the "Tolerance time", for "Tolerance factor × Measured current". Exceeding this results in an overflow electrical current error. The maximum value of the secondary current (12 A) is exceeded.	Observe the electrical current range
Overflow cumulative values	7 _H	Cumulative overflow error in the calculated values	-
Low limit ¹	8 _H	Violation of the low limit for voltage measurement. This error is generated when the voltage falls below 80VAC.	Observe the voltage range
Error	9 _H	Internal module error (diagnostic alarm on channel 0 applies to the entire module).	Replace the module
Parameter assignment error	10 _H	<ul style="list-style-type: none"> The module cannot evaluate parameters for the channel. Incorrect parameter assignment. 	Correct the parameter assignment.
Load voltage	11 _H	Missing or insufficient line voltage on phase L1 for F-stand 1 only.	Check supply
Channel is temporarily unavailable	1F _H	Firmware upgrade is being performed. Channel 0 applies to the entire module. The module is currently not performing any measurements.	--

¹ If the "Underflow voltage" and "Low limit voltage" diagnostics are active at the same time, the "Low limit voltage" diagnostics has the higher priority and deletes the "Underflow voltage" diagnostics.

12.3 Diagnostics response

Diagnostics response

This section describes the response of the SM 1238 Energy Meter 480VAC when a diagnostic error is reported.

Measured values in the case of diagnostics

After a diagnostic error occurs, measured values continue to be displayed as long as they can still be acquired. If measured values cannot be measured or calculated, "0" is displayed.

Zero suppression

If the current fed in is lower than the configured low limit for current, the measured value of the current and all dependent variables are suppressed or set to "0".

Overload limitation

If the secondary current fed in at the channel is higher than 12 A, the module limits the current and the measured value of the current and all dependent variables are set to "0".

Value falls below "Low limit electrical current measurement"

If current falls below the low limit for the electrical current measurement, the following measured values and derived variables of the affected phase are reset.

- Effective electrical current value
- Active power
- Reactive power
- Apparent power
- Phase angle
- Power factor

A moving mean value is formed from the power values and they only become "0" after a corresponding time. The energy meters for active, reactive and apparent energy of the reset phase stop measuring.

Loss of the supply voltage

At a loss of supply voltage at U_{L1} (phase 1) for F-stand 1, all measurements are interrupted.

After the supply voltage is restored, the SM 1238 Energy Meter 480VAC operates again with the configuration / parameter assignment stored in the CPU. The retentively stored values are used for the following counters and calculations:

- Energy and overflow counters
- Operating hours counters
- Counters for limit violation
- Minimum values
- Maximum values

Input data to "0"

Note

If the SM 1238 Energy Meter 480VAC is no longer recognized by the S7-1200 (for example, because it is defective or not plugged in), all input data is set to "0".

Technical specifications

13.1 Technical specifications

Article number	6ES7238-5XA32-0XB0
General information	
Product type designation	SM 1238, AI energy meter 480 V AC
HW functional status	From FS02
Firmware version	V2.0.1
Product function	
• Voltage measurement	Yes
– with voltage transformer	Yes
• Current measurement	Yes
– without current transformer	No
– with current transformer	Yes
• Energy measurement	Yes
• Frequency measurement	Yes
• Power measurement	Yes
• Active power measurement	Yes
• Reactive power measurement	Yes
• I&M data	Yes; I&M 0
• Isochronous mode	No
Engineering with	
• STEP 7 TIA Portal configurable/integrated as of version	V13 SP1
Operating mode	
• cyclic measurement	Yes
• acyclic measurement	Yes
• Acyclic measured value access	Yes
• Fixed measured value sets	Yes
• Freely definable measured value sets	No
CiR – Configuration in RUN	
Reparameterization possible in RUN	Yes
Calibration possible in RUN	Yes
Installation type/mounting	
Mounting position	Horizontal, vertical

Article number	6ES7238-5XA32-0XB0
Supply voltage	
Design of the power supply	from CPU
Type of supply voltage	DC
Input current	
Current consumption, max.	180 mA
Power loss	
Power loss, typ.	0.75 W
Address area	
Address space per module	
<ul style="list-style-type: none"> Address space per module, max. 	124 byte; 112 byte input / 12 byte output
Time of day	
Operating hours counter	
<ul style="list-style-type: none"> present 	Yes
Analog inputs	
Cycle time (all channels), typ.	50 ms; Time for consistent update of all measured and calculated values (cyclic und acyclic data)
Interrupts/diagnostics/status information	
Alarms	
<ul style="list-style-type: none"> Diagnostic alarm 	Yes
<ul style="list-style-type: none"> Limit value alarm 	Yes
<ul style="list-style-type: none"> Hardware interrupt 	No
Diagnostics indication LED	
<ul style="list-style-type: none"> Monitoring of the supply voltage (PWR-LED) 	Yes
<ul style="list-style-type: none"> Channel status display 	Yes; Green LED
<ul style="list-style-type: none"> for channel diagnostics 	Yes; red Fn LED
<ul style="list-style-type: none"> for module diagnostics 	Yes; green/red DIAG LED
Integrated Functions	
Measuring functions	
<ul style="list-style-type: none"> Measuring procedure for voltage measurement 	TRMS
<ul style="list-style-type: none"> Measuring procedure for current measurement 	TRMS
<ul style="list-style-type: none"> Type of measured value acquisition 	seamless
<ul style="list-style-type: none"> Curve shape of voltage 	Sinusoidal or distorted
<ul style="list-style-type: none"> Buffering of measured variables 	Yes
<ul style="list-style-type: none"> Parameter length 	74 byte
<ul style="list-style-type: none"> Bandwidth of measured value acquisition 	2 kHz; Harmonics: 39 / 50 Hz, 32 / 60 Hz

Article number	6ES7238-5XA32-0XB0
Measuring range	
– Frequency measurement, min.	45 Hz
– Frequency measurement, max.	65 Hz
Measuring inputs for voltage	
– Measurable line voltage between phase and neutral conductor	277 V
– Measurable line voltage between the line conductors	480 V
– Measurable line voltage between phase and neutral conductor, min.	0 V
– Measurable line voltage between phase and neutral conductor, max.	293 V
– Measurable line voltage between the line conductors, min.	0 V
– Measurable line voltage between the line conductors, max.	508 V
– Measurement category for voltage measurement in accordance with IEC 61010-2-030	CAT II; CAT III in case of guaranteed protection level of 1.5 kV
– Internal resistance line conductor and neutral conductor	3.4 MΩ
– Power consumption per phase	20 mW
– Impulse voltage resistance 1,2/50μs	1 kV
Measuring inputs for current	
– measurable relative current (AC), min.	1 %; Relative to the secondary rated current 5 A
– measurable relative current (AC), max.	100 %; Relative to the secondary rated current 5 A
– Continuous current with AC, maximum permissible	5 A
– Apparent power consumption per phase for measuring range 5 A	0.6 V·A
– Rated value short-time withstand current restricted to 1 s	100 A
– Input resistance measuring range 0 to 5 A	25 mΩ; At the terminal
– Zero point suppression	Parameterizable: 2 ... 250 mA, default 50 mA
– Surge strength	10 A; for 1 minute

Article number	6ES7238-5XA32-0XB0
Accuracy class according to IEC 61557-12	
– Measured variable voltage	0,2
– Measured variable current	0,2
– Measured variable apparent power	0.5
– Measured variable active power	0.5
– Measured variable reactive power	1
– Measured variable power factor	0.5
– Measured variable active energy	0.5
– Measured variable reactive energy	1
– Measured variable neutral current	0.5; calculated
– Measured variable phase angle	±1 °; not covered by IEC 61557-12
– Measured variable frequency	0.05
Potential separation	
Potential separation channels	
• between the channels and backplane bus	Yes; 3 700V AC (type test) CAT III
Isolation	
Isolation tested with	2 300V AC for 1 min. (type test)
Ambient conditions	
Ambient temperature during operation	
• horizontal installation, min.	-20 °C
• horizontal installation, max.	60 °C
• vertical installation, min.	-20 °C
• vertical installation, max.	50 °C
Dimensions	
Width	45 mm
Height	100 mm
Depth	75 mm
Weights	
Weight (without packaging)	165 g
Data for selecting a current transformer	
• Burden power current transformer x/1A, min.	As a function of cable length and cross section, see device manual
• Burden power current transformer x/5A, min.	As a function of cable length and cross section, see device manual

Agency approvals

The SM 1238 Energy Meter 480 VAC meets the standards and agency approvals for S7-1200 PLC system components. The approvals are listed in the General technical specifications section of the S7-1200 System Manual. You can find the S7-1200 system manual on the Internet (<https://support.industry.siemens.com/cs/ww/en/view/91696622>).

Agency approvals are also marked on the side of the module.

Module configuration data record (DS 128)

A.1 Configuration by parameter data record

Parameter assignment in the user program

You can reassign the module parameters in RUN mode. For example, you can change the diagnostics alarm behavior.

Changing parameters in RUN

The "WRREC" instruction in your program can transfer parameters to the module via the respective data record. The device configuration parameters set in STEP 7 do not change in the CPU, which means the parameters set in STEP 7 are still valid after a restart.

If you reconfigure a module (so that the user data size changes) and diagnostics are pending prior to the reconfiguration, these diagnostics are not signaled as "outgoing".

STATUS output parameter

If errors occur during the transfer of parameters with the WRREC instruction, the module continues operation with the previous parameter assignment. However, a corresponding error code is written to the STATUS output parameter.

The description of the WRREC instruction and the error codes is available in the STEP 7 online help.

A.2 Parameter data record 128

Structure of data record 128 for entire module

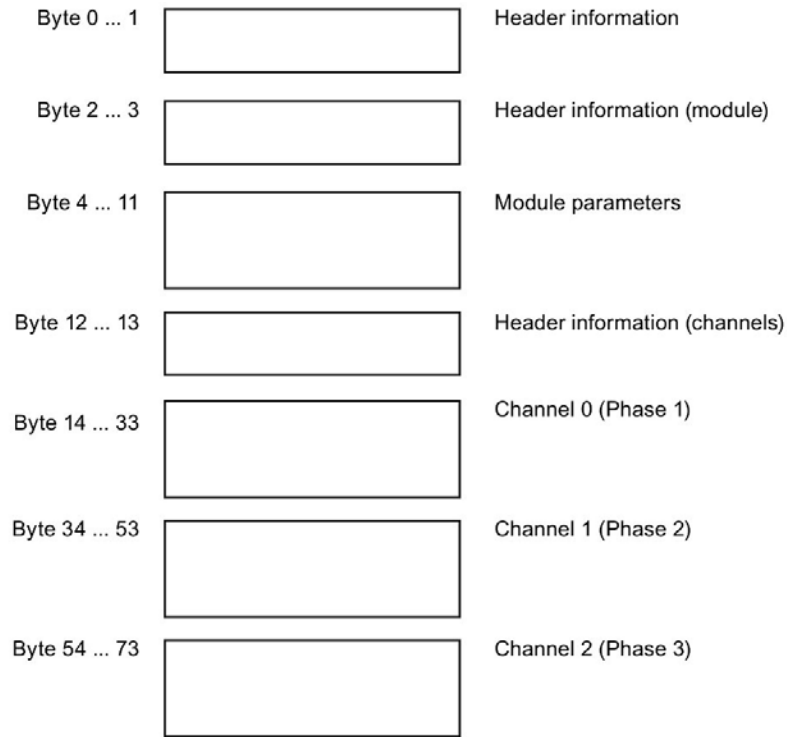

Figure A-1 Parameter data record 128

Header information

The figure below shows the structure of the header information.



Module header information

The figure below shows the structure of the header information for a module.

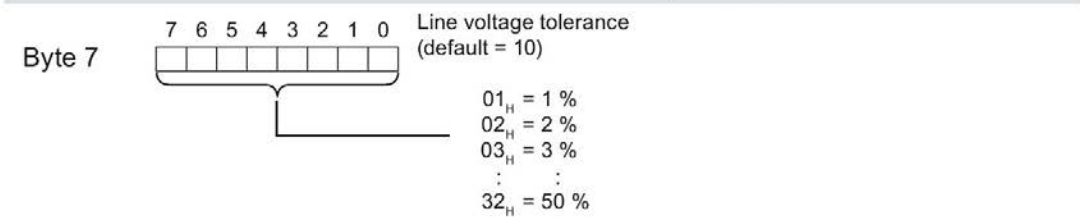
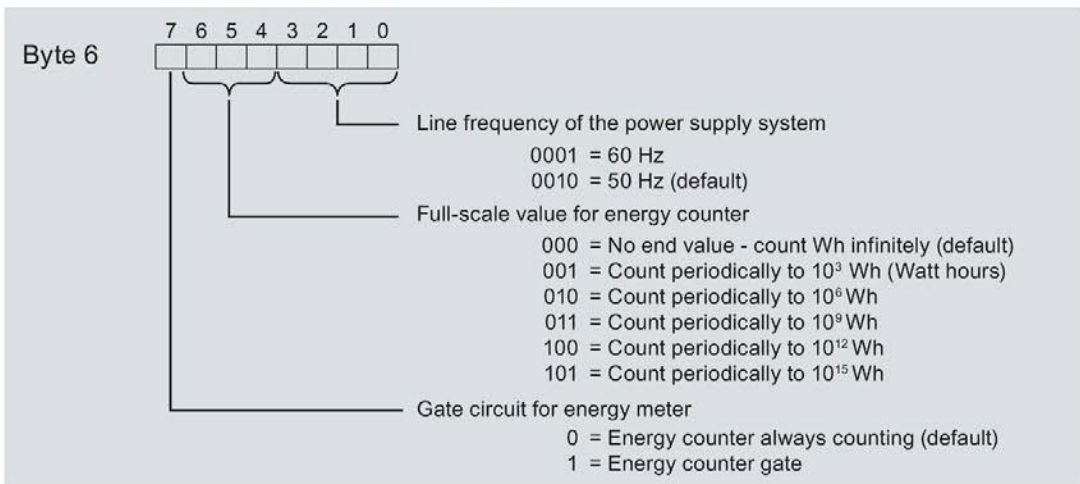
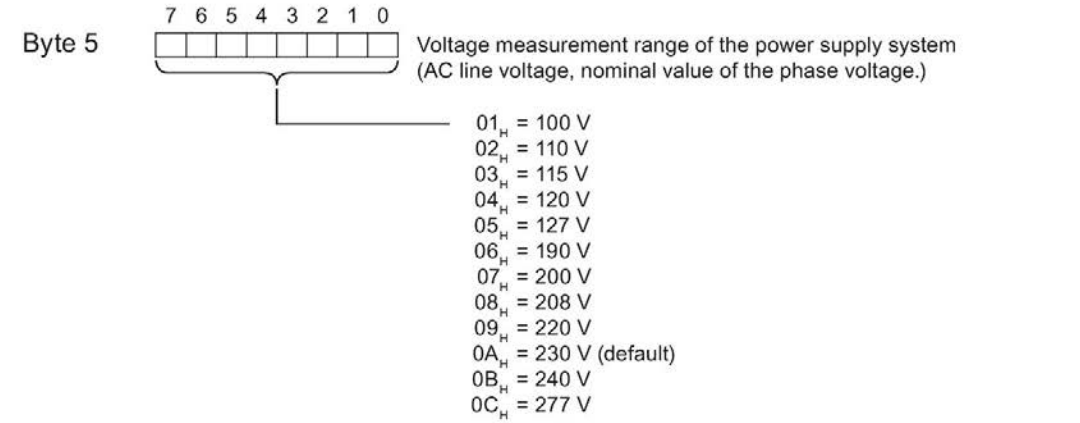
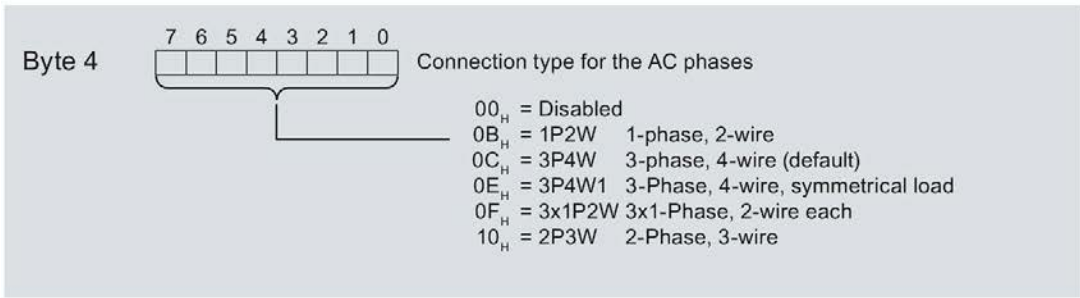

Figure A-2 Module header information

Module parameter block

The figure below shows the structure of the module parameter block.

Enable a parameter by setting the corresponding bit to "1".



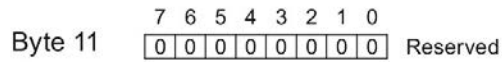
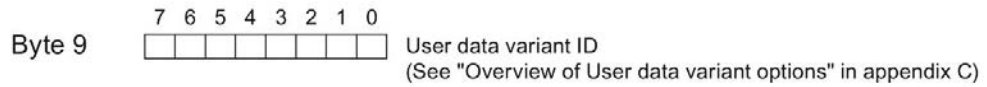
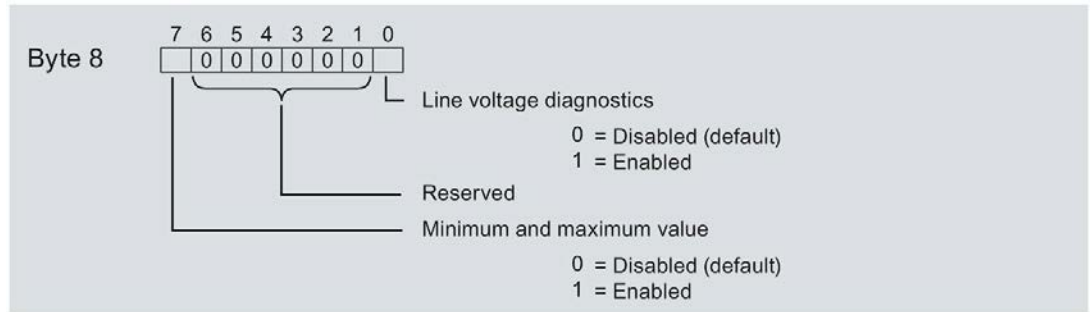

Figure A-3 Module parameter block

You can find format details about the Process data variants in the section Overview of the Process data variants (Page 126).

Channel header information

The following figure shows the structure of the header information for a channel.



Channel parameter block

The figure below shows the structure of the channel parameter block, for one AC power phase. The channel (phase) data structure is the same for all 3 AC power phases.

Enable a parameter by setting the corresponding bit to 1.

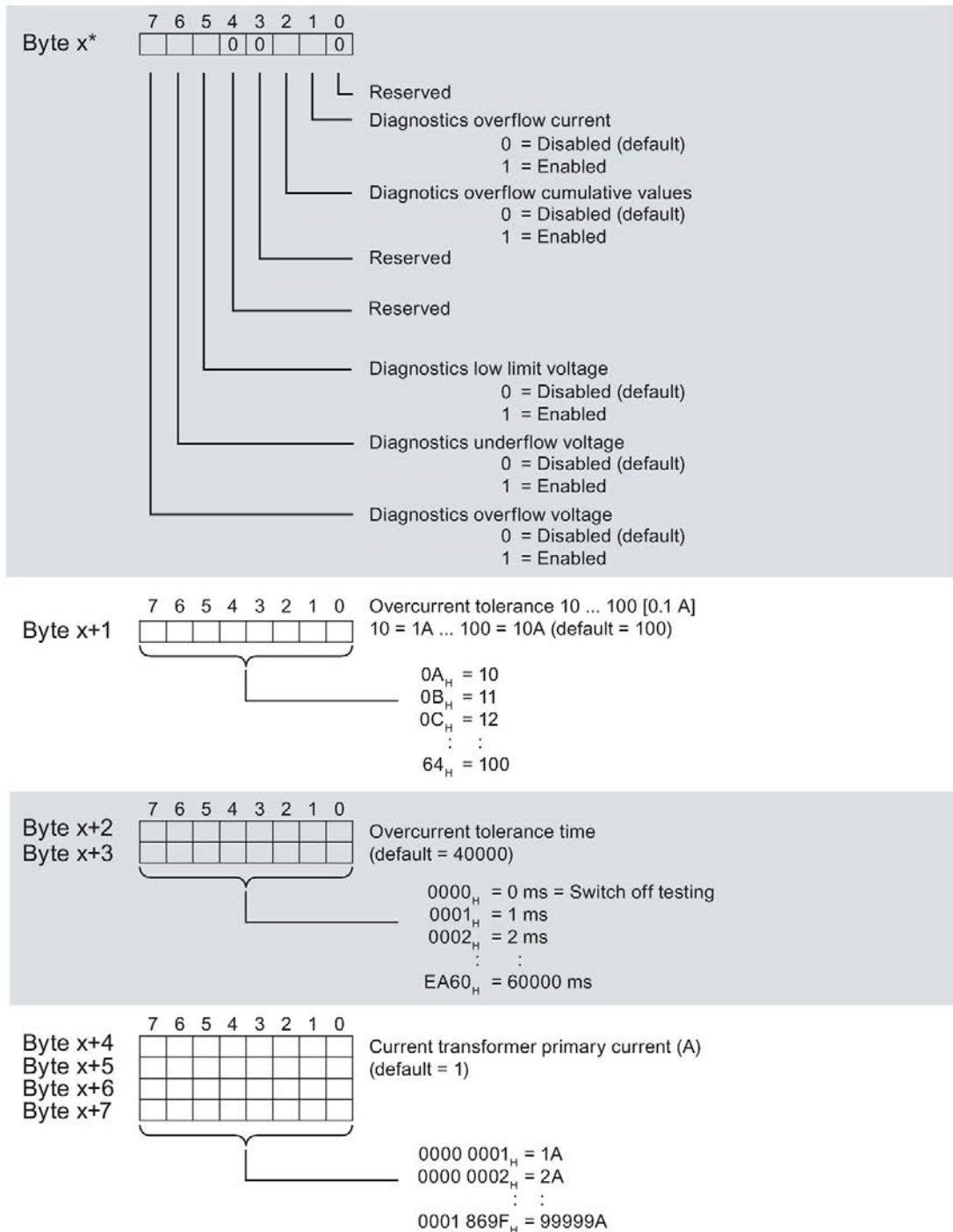

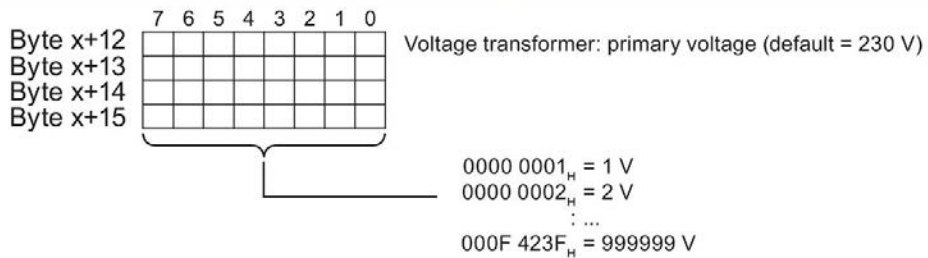
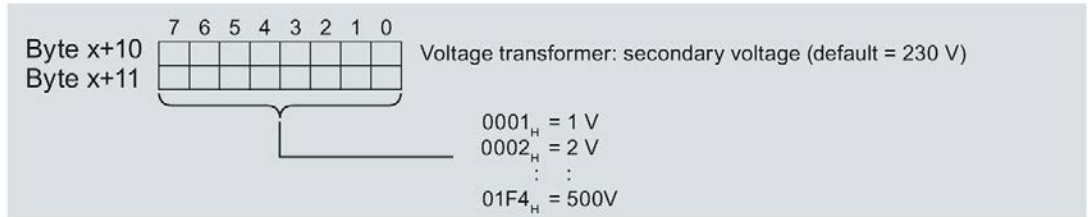
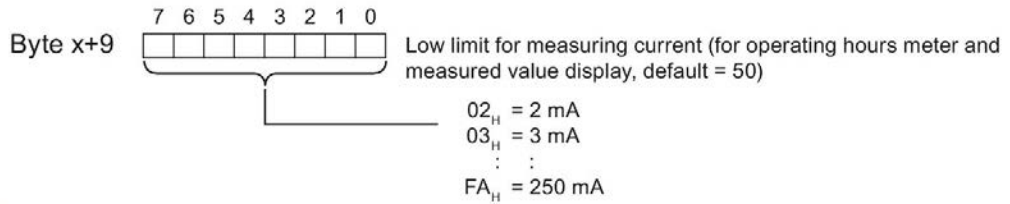
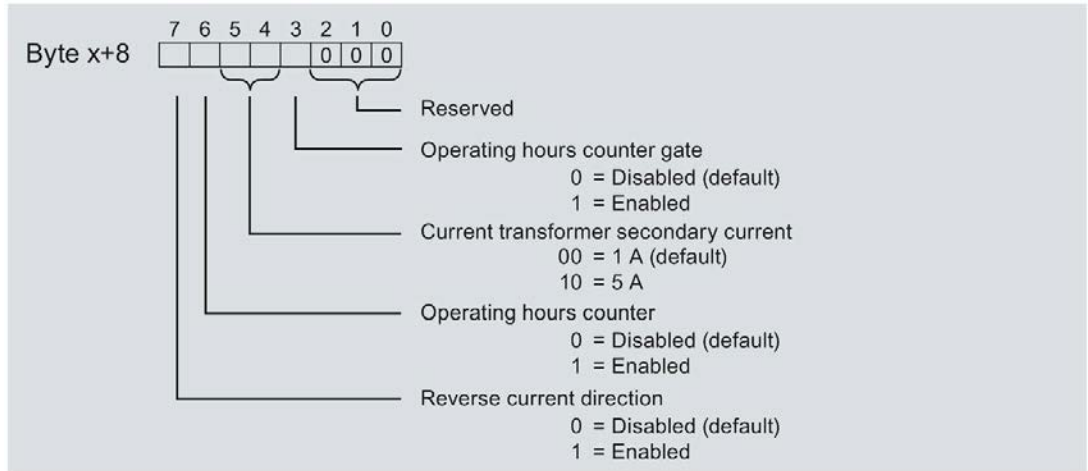

A.2 Parameter data record 128



Figure A-4 Channel parameter block

Error while transferring the parameter data record

The module always checks all the values of the transferred data record. Only if all the values were transferred without errors does the module apply the values from the data record.

The WRREC write data record instruction returns error codes when errors occur in the STATUS parameter.

The following table shows the module-specific error codes and their meaning for the parameter data record 128.

Error code in STATUS parameter (hexadecimal)				Meaning	Solution
Byte 0	Byte 1	Byte 2	Byte 3		
DF	80	B0	00	Number of the data record unknown	Enter a valid number for the data record.
DF	80	B1	00	Length of the data record incorrect	Enter a valid value for the data record length.
DF	80	B2	00	Slot invalid or cannot be accessed.	Check the station whether the module is plugged in correctly. Check the assigned values for the parameters of the WRREC instruction
DF	80	E0	01	Incorrect version	Check Byte 0. Enter valid values.
DF	80	E0	02	Error in the header information	Check Bytes 1 and 2. Correct the length and number of the parameter blocks.
DF	80	E1	01	Reserved bits are not 0.	Check Byte 10, 11, 14, 22, 30 ... 34, 42, 50 ... 54, 70 ... 74 and set the reserved bits back to 0.
DF	80	E1	02	Reserved bits are not 0.	Check Byte 8 and set the reserved bits back to 0.
DF	80	E1	05	Measuring range for voltage invalid.	Check Byte 5. Permitted values: 01H to 0CH
DF	80	E1	20	Connection type invalid.	Check Byte 4. Permitted values: 00H, 0BH ... 10H

Error code in STATUS parameter (hexadecimal)				Meaning	Solution
Byte 0	Byte 1	Byte 2	Byte 3		
DF	80	E1	21	Parameter for Process data variant not possible.	Check Byte 9. Select a different Process data variant or change the configuration.
DF	80	E1	22	Parameter for Process variant is invalid.	Check Byte 9. Select a valid code for the Process data variant.
DF	80	E1	23	Parameter for frequency is invalid.	Check Byte 6. Enter valid values.
DF	80	E1	24	Parameter for tolerance line voltage is invalid.	Check Byte 7. Enter valid values.
DF	80	E1	25	Parameter for secondary electrical current of the transformer is invalid.	Check Bit 4 and 5 in Byte 22, 42 ... 62. Enter valid values.
DF	80	E1	29	Parameter for tolerance factor overcurrent invalid.	Check Byte 15, 35 ... 55. Enter valid values.
DF	80	E1	2A	Parameter for tolerance time overcurrent invalid.	Check Byte 16 and 17, 36 ... 37, 56 ... 57. Enter valid values.
DF	80	E1	2B	Parameter for low limit measuring current invalid	Check Byte 23, 43 ... 63. Enter valid values.
DF	80	E1	2C	Parameter for primary electrical current of the transformer is invalid.	Check Byte 18 ... 21, 38 ... 41, 48 ... 61. Enter valid values.
DF	80	E1	2D	Parameter for voltage converter primary voltage invalid.	Check Byte 26 ... 29, 46 ... 49, 66 ... 69. Enter valid values.
DF	80	E1	2E	Parameter for voltage converter secondary voltage invalid.	Check Byte 24 ... 25, 44 ... 45, 64 ... 65. Enter valid values.
DF	80	E1	2F	Parameter for full-scale value for energy counters invalid.	Check Bit 4 ... 6 in Byte 6. Enter valid values.
DF	80	E1	30	Invalid data record number.	Check the data record number. Enter a valid data record number.
DF	80	E1	3E	Only for connection type 3P4W1. Parameters of electrical current and/or voltage transformers are not identical.	Check Bytes 14 ... 33, 34 ... 53, 54 ... 73. Enter identical values at all three phases.
DF	80	E1	3F	Full-scale value for energy counter too small or transfer ratio of current and voltage too high.	Increase the full-scale value or reduce the transfer ratio of the electrical current and voltage transformer.

Measured variables

B.1 Measured process variables and connection type

Measured process variables for data records and user data

The following table provides an overview of all measured process variables that are used in the data records and user data.

Note that number formats and units differ in the evaluation of records and user data.

Table B- 1 Measured process variables for data records and user data

Measured value ID	Measured variable	Data type	Unit	Value range	Connection type				
					1P2W	3x1P2W	2P3W	3P4W	3P4W1
1	Voltage UL1-N ¹	REAL	V	0.0 ... 1000000.0	✓	✓	✓	✓	✓
2	Voltage UL2-N ¹	REAL	V	0.0 ... 1000000.0		✓	✓	✓	✓
3	Voltage UL3-N ¹	REAL	V	0.0 ... 1000000.0		✓		✓	✓
4	Voltage UL1-L2 ²	REAL	V	0.0 ... 1000000.0				✓	✓
5	Voltage UL2-L3 ²	REAL	V	0.0 ... 1000000.0				✓	✓
6	Voltage UL3-L1 ²	REAL	V	0.0 ... 1000000.0				✓	✓
7	Current L1 ¹	REAL	A	0.0 ... 100000.0	✓	✓	✓	✓	✓
8	Current L2 ¹	REAL	A	0.0 ... 100000.0		✓	✓	✓	✓
9	Current L3 ¹	REAL	A	0.0 ... 100000.0		✓		✓	✓
10	Apparent power L1 ³	REAL	VA	-3.0 x 10 ⁹ ... +3.0 x 10 ⁹	✓	✓	✓	✓	✓
11	Apparent power L2 ³	REAL	VA	-3.0 x 10 ⁹ ... +3.0 x 10 ⁹		✓	✓	✓	✓
12	Apparent power L3 ³	REAL	VA	-3.0 x 10 ⁹ ... +3.0 x 10 ⁹		✓		✓	✓
13	Active power L1 ³	REAL	W	-3.0 x 10 ⁹ ... +3.0 x 10 ⁹	✓	✓	✓	✓	✓
14	Active power L2 ³	REAL	W	-3.0 x 10 ⁹ ... +3.0 x 10 ⁹		✓	✓	✓	✓
15	Active power L3 ³	REAL	W	-3.0 x 10 ⁹ ... +3.0 x 10 ⁹		✓		✓	✓
16	Reactive power L1 ³	REAL	var	-3.0 x 10 ⁹ ... +3.0 x 10 ⁹	✓	✓	✓	✓	✓
17	Reactive power L2 ³	REAL	var	-3.0 x 10 ⁹ ... +3.0 x 10 ⁹		✓	✓	✓	✓
18	Reactive power L3 ³	REAL	var	-3.0 x 10 ⁹ ... +3.0 x 10 ⁹		✓		✓	✓

B.1 Measured process variables and connection type

Measured value ID	Measured variable	Data type	Unit	Value range	Connection type				
					1P2W	3x1P2W	2P3W	3P4W	3P4W1
19	Power factor L1 ³	REAL	-	0.0 ... 1.0	✓	✓	✓	✓	✓
20	Power factor L2 ³	REAL	-	0.0 ... 1.0		✓	✓	✓	✓
21	Power factor L3 ³	REAL	-	0.0 ... 1.0		✓		✓	✓
30	Frequency ⁴	REAL	Hz	45.0 ... 65.0	✓	✓	✓	✓	✓
34	Total active power L1L2L3 ⁵	REAL	W	-3.0 x 10 ⁹ ... +3.0 x 10 ⁹	✓	✓	✓	✓	✓
35	Total reactive power L1L2L3 ⁵	REAL	var	-3.0 x 10 ⁹ ... +3.0 x 10 ⁹	✓	✓	✓	✓	✓
36	Total apparent power L1L2L3 ⁵	REAL	VA	-3.0 x 10 ⁹ ... +3.0 x 10 ⁹	✓	✓	✓	✓	✓
37	Total power factor L1L2L3 ^{6 7}	REAL	-	0.0 ... 1.0	✓	✓	✓	✓	✓
38	Amplitude balance for voltage ²	REAL	%	0 ... 100				✓	✓
39	Amplitude symmetry for current ²	REAL	%	0 ... 200				✓	✓
40	Max. voltage UL1-N ⁶	REAL	V	0.0 ... 1000000.0	✓	✓	✓	✓	✓
41	Max. voltage UL2-N ⁶	REAL	V	0.0 ... 1000000.0		✓	✓	✓	✓
42	Max. voltage UL3-N ⁶	REAL	V	0.0 ... 1000000.0		✓		✓	✓
43	Max. voltage UL1-UL2 ⁶	REAL	V	0.0 ... 1000000.0				✓	✓
44	Max. voltage UL2-UL3 ⁶	REAL	V	0.0 ... 1000000.0				✓	✓
45	Max. voltage UL3-UL1 ⁶	REAL	V	0.0 ... 1000000.0				✓	✓
46	Max. current L1 ⁶	REAL	A	0.0 ... 100000.0	✓	✓	✓	✓	✓
47	Max. current L2 ⁶	REAL	A	0.0 ... 100000.0		✓	✓	✓	✓
48	Max. current L3 ⁶	REAL	A	0.0 ... 100000.0		✓		✓	✓
49	Max. apparent power L1 ⁶	REAL	VA	-3.0 x 10 ⁹ ... +3.0 x 10 ⁹	✓	✓	✓	✓	✓
50	Max. apparent power L2 ⁶	REAL	VA	-3.0 x 10 ⁹ ... +3.0 x 10 ⁹		✓	✓	✓	✓
51	Max. apparent power L3 ⁶	REAL	VA	-3.0 x 10 ⁹ ... +3.0 x 10 ⁹		✓		✓	✓
52	Max. active power L1 ⁶	REAL	W	-3.0 x 10 ⁹ ... +3.0 x 10 ⁹	✓	✓	✓	✓	✓
53	Max. active power L2 ⁶	REAL	W	-3.0 x 10 ⁹ ... +3.0 x 10 ⁹		✓	✓	✓	✓
54	Max. active power L3 ⁶	REAL	W	-3.0 x 10 ⁹ ... +3.0 x 10 ⁹		✓		✓	✓
55	Max. reactive power L1 ⁶	REAL	var	-3.0 x 10 ⁹ ... +3.0 x 10 ⁹	✓	✓	✓	✓	✓
56	Max. reactive power L2 ⁶	REAL	var	-3.0 x 10 ⁹ ... +3.0 x 10 ⁹		✓	✓	✓	✓
57	Max. reactive power L3 ⁶	REAL	var	-3.0 x 10 ⁹ ... +3.0 x 10 ⁹		✓		✓	✓

Measured variables

B.1 Measured process variables and connection type

Measured value ID	Measured variable	Data type	Unit	Value range	Connection type				
					1P2W	3x1P2W	2P3W	3P4W	3P4W1
58	Max. power factor L1 ⁶	REAL	-	0.0 ... 1.0	✓	✓	✓	✓	✓
59	Max. power factor L2 ⁶	REAL	-	0.0 ... 1.0		✓	✓	✓	✓
60	Max. power factor L3 ⁶	REAL	-	0.0 ... 1.0		✓		✓	✓
61	Max. frequency ⁶	REAL	Hz	45.0 ... 65.0	✓	✓	✓	✓	✓
65	Max. total active power ⁶	REAL	W	-3.0 x 10 ⁹ ... +3.0 x 10 ⁹	✓	✓	✓	✓	✓
66	Max. total reactive power ⁶	REAL	var	-3.0 x 10 ⁹ ... +3.0 x 10 ⁹	✓	✓	✓	✓	✓
67	Max. total apparent power ⁶	REAL	VA	-3.0 x 10 ⁹ ... +3.0 x 10 ⁹	✓	✓	✓	✓	✓
68	Max. total power factor ⁶	REAL	-	0.0 ... 1.0	✓	✓	✓	✓	✓
70	Min. voltage UL1-N ⁶	REAL	V	0.0 ... 1000000.0	✓	✓	✓	✓	✓
71	Min. voltage UL2-N ⁶	REAL	V	0.0 ... 1000000.0		✓	✓	✓	✓
72	Min. voltage UL3-N ⁶	REAL	V	0.0 ... 1000000.0		✓		✓	✓
73	Min. voltage UL1-UL2 ⁶	REAL	V	0.0 ... 1000000.0				✓	✓
74	Min. voltage UL2-UL3 ⁶	REAL	V	0.0 ... 1000000.0				✓	✓
75	Min. voltage UL3-UL1 ⁶	REAL	V	0.0 ... 1000000.0				✓	✓
76	Min. current L1 ⁶	REAL	A	0.0 ... 100000.0	✓	✓	✓	✓	✓
77	Min. current L2 ⁶	REAL	A	0.0 ... 100000.0		✓	✓	✓	✓
78	Min. current L3 ⁶	REAL	A	0.0 ... 100000.0		✓		✓	✓
79	Min. apparent power L1 ⁶	REAL	VA	-3.0 x 10 ⁹ ... +3.0 x 10 ⁹	✓	✓	✓	✓	✓
80	Min. apparent power L2 ⁶	REAL	VA	-3.0 x 10 ⁹ ... +3.0 x 10 ⁹		✓	✓	✓	✓
81	Min. apparent power L3 ⁶	REAL	VA	-3.0 x 10 ⁹ ... +3.0 x 10 ⁹		✓		✓	✓
82	Min. active power L1 ⁶	REAL	W	-3.0 x 10 ⁹ ... +3.0 x 10 ⁹	✓	✓	✓	✓	✓
83	Min. active power L2 ⁶	REAL	W	-3.0 x 10 ⁹ ... +3.0 x 10 ⁹		✓	✓	✓	✓
84	Min. active power L3 ⁶	REAL	W	-3.0 x 10 ⁹ ... +3.0 x 10 ⁹		✓		✓	✓
85	Min. reactive power L1 ⁶	REAL	var	-3.0 x 10 ⁹ ... +3.0 x 10 ⁹	✓	✓	✓	✓	✓
86	Min. reactive power L2 ⁶	REAL	var	-3.0 x 10 ⁹ ... +3.0 x 10 ⁹		✓	✓	✓	✓
87	Min. reactive power L3 ⁶	REAL	var	-3.0 x 10 ⁹ ... +3.0 x 10 ⁹		✓		✓	✓
88	Min. power factor L1 ⁶	REAL	-	0.0 ... 1.0	✓	✓	✓	✓	✓
89	Min. power factor L2 ⁶	REAL	-	0.0 ... 1.0		✓	✓	✓	✓
90	Min. power factor L3 ⁶	REAL	-	0.0 ... 1.0		✓		✓	✓
91	Min. frequency ⁶	REAL	Hz	45.0 ... 65.0	✓	✓	✓	✓	✓

B.1 Measured process variables and connection type

Measured value ID	Measured variable	Data type	Unit	Value range	Connection type				
					1P2W	3x1P2W	2P3W	3P4W	3P4W1
95	Min. total active power ⁶	REAL	W	$-3.0 \times 10^9 \dots +3.0 \times 10^9$	✓	✓	✓	✓	✓
96	Min. total reactive power ⁶	REAL	var	$-3.0 \times 10^9 \dots +3.0 \times 10^9$	✓	✓	✓	✓	✓
97	Min. total apparent power ⁶	REAL	VA	$-3.0 \times 10^9 \dots +3.0 \times 10^9$	✓	✓	✓	✓	✓
98	Min. total power factor ⁶	REAL	-	0.0 ... 1.0	✓	✓	✓	✓	✓
200	Total active energy inflow L1L2L3 ⁶	REAL	Wh	0.0 ... 3.4×10^{38}	✓	✓	✓	✓	✓
201	Total active energy outflow L1L2L3 ⁶	REAL	Wh	0.0 ... 3.4×10^{38}	✓	✓	✓	✓	✓
202	Total reactive energy inflow L1L2L3 ⁶	REAL	varh	0.0 ... 3.4×10^{38}	✓	✓	✓	✓	✓
203	Total reactive energy outflow L1L2L3 ⁶	REAL	varh	0.0 ... 3.4×10^{38}	✓	✓	✓	✓	✓
204	Total apparent energy L1L2L3 ⁶	REAL	VAh	0.0 ... 3.4×10^{38}	✓	✓	✓	✓	✓
205	Total active energy L1L2L3 ⁶	REAL	Wh	$\pm 3.4 \times 10^{38}$	✓	✓	✓	✓	✓
206	Total reactive energy L1L2L3 ⁶	REAL	varh	$\pm 3.4 \times 10^{38}$	✓	✓	✓	✓	✓
210	Total active energy inflow L1L2L3 ⁶	LREAL	Wh	0.0 ... 1.8×10^{308}	✓	✓	✓	✓	✓
211	Total active energy outflow L1L2L3 ⁶	LREAL	Wh	0.0 ... 1.8×10^{308}	✓	✓	✓	✓	✓
212	Total reactive energy inflow L1L2L3 ⁶	LREAL	varh	0.0 ... 1.8×10^{308}	✓	✓	✓	✓	✓
213	Total reactive energy outflow L1L2L3 ⁶	LREAL	varh	0.0 ... 1.8×10^{308}	✓	✓	✓	✓	✓
214	Total apparent energy L1L2L3 ⁶	LREAL	VAh	0.0 ... 1.8×10^{308}	✓	✓	✓	✓	✓
215	Total active energy L1L2L3 ⁶	LREAL	Wh	$\pm 1.8 \times 10^{308}$	✓	✓	✓	✓	✓
216	Total reactive energy L1L2L3 ⁶	LREAL	varh	$\pm 1.8 \times 10^{308}$	✓	✓	✓	✓	✓
220	Total active energy inflow L1L2L3 ⁶	UDINT	Wh	0 ... 2147483647	✓	✓	✓	✓	✓
221	Total active energy outflow L1L2L3 ⁶	UDINT	varh	0 ... 2147483647	✓	✓	✓	✓	✓
222	Total reactive energy inflow L1L2L3 ⁶	UDINT	varh	0 ... 2147483647	✓	✓	✓	✓	✓
223	Total reactive energy outflow L1L2L3 ⁶	UDINT	VAh	0 ... 2147483647	✓	✓	✓	✓	✓
224	Total apparent energy L1L2L3 ⁶	UDINT	Wh	0 ... 2147483647	✓	✓	✓	✓	✓

Measured variables

B.1 Measured process variables and connection type

Measured value ID	Measured variable	Data type	Unit	Value range	Connection type				
					1P2W	3x1P2W	2P3W	3P4W	3P4W1
225	Total active energy L1L2L3 ⁶	DINT	Wh	±2147483647	✓	✓	✓	✓	✓
226	Total reactive energy L1L2L3 ⁶	DINT	varh	±2147483647	✓	✓	✓	✓	✓
61149	Neutral conductor current ₁	REAL	A	0.0 ... 100000.0				✓	
61178	Phase angle L1 ³	REAL	°	0.0 ... 360.0	✓	✓	✓	✓	✓
61180	Active energy inflow L1 ⁶	LREAL	Wh	0.0 ... 1.8 x 10 ³⁰⁸	✓	✓	✓	✓	✓
61181	Active energy outflow L1 ⁶	LREAL	Wh	0.0 ... 1.8 x 10 ³⁰⁸	✓	✓	✓	✓	✓
61182	Reactive energy inflow L1 ⁶	LREAL	varh	0.0 ... 1.8 x 10 ³⁰⁸	✓	✓	✓	✓	✓
61183	Reactive energy outflow L1 ⁶	LREAL	varh	0.0 ... 1.8 x 10 ³⁰⁸	✓	✓	✓	✓	✓
61184	Apparent energy L1 ⁶	LREAL	VAh	0.0 ... 1.8 x 10 ³⁰⁸	✓	✓	✓	✓	✓
61185	Active energy L1 ⁶	LREAL	Wh	±1.8 x 10 ³⁰⁸	✓	✓	✓	✓	✓
61186	Reactive energy L1 ⁶	LREAL	varh	±1.8 x 10 ³⁰⁸	✓	✓	✓	✓	✓
61190	Overflow counter active energy inflow L1 ⁶	UINT	-	0 ... 65535	✓	✓	✓	✓	✓
61191	Overflow counter active energy outflow L1 ⁶	UINT	-	0 ... 65535	✓	✓	✓	✓	✓
61192	Overflow counter reactive energy inflow L1 ⁶	UINT	-	0 ... 65535	✓	✓	✓	✓	✓
61193	Overflow counter reactive energy outflow L1 ⁶	UINT	-	0 ... 65535	✓	✓	✓	✓	✓
61194	Overflow counter apparent energy L1 ⁶	UINT	-	0 ... 65535	✓	✓	✓	✓	✓
61198	Phase angle L2 ³	REAL	°	0.0 ... 360.0		✓	✓	✓	✓
61200	Active energy inflow L2 ⁶	LREAL	Wh	0.0 ... 1.8 x 10 ³⁰⁸		✓	✓	✓	✓
61201	Active energy outflow L2 ⁶	LREAL	Wh	0.0 ... 1.8 x 10 ³⁰⁸		✓	✓	✓	✓
61202	Reactive energy inflow L2 ⁶	LREAL	varh	0.0 ... 1.8 x 10 ³⁰⁸		✓	✓	✓	✓
61203	Reactive energy outflow L2 ⁶	LREAL	varh	0.0 ... 1.8 x 10 ³⁰⁸		✓	✓	✓	✓
61204	Apparent energy L2 ⁶	LREAL	VAh	0.0 ... 1.8 x 10 ³⁰⁸		✓	✓	✓	✓
61205	Active energy L2 ⁶	LREAL	Wh	±1.8 x 10 ³⁰⁸		✓	✓	✓	✓
61206	Reactive energy L2 ⁶	LREAL	varh	±1.8 x 10 ³⁰⁸		✓	✓	✓	✓
61210	Overflow counter active energy inflow L2 ⁶	UINT	-	0 ... 65535		✓	✓	✓	✓
61211	Overflow counter active energy outflow L2 ⁶	UINT	-	0 ... 65535		✓	✓	✓	✓
61212	Overflow counter reactive energy inflow L2 ⁶	UINT	-	0 ... 65535		✓	✓	✓	✓

B.1 Measured process variables and connection type

Measured value ID	Measured variable	Data type	Unit	Value range	Connection type				
					1P2W	3x1P2W	2P3W	3P4W	3P4W1
61213	Overflow counter reactive energy outflow L2 ⁶	UINT	-	0 ... 65535		✓	✓	✓	✓
61214	Overflow counter apparent energy L2 ⁶	UINT	-	0 ... 65535		✓	✓	✓	✓
61218	Phase angle L3 ³	REAL		0.0 ... 360.0		✓		✓	✓
61220	Active energy inflow L3 ⁶	LREAL	Wh	0.0 ... 1.8 x 10 ³⁰⁸		✓		✓	✓
61221	Active energy outflow L3 ⁶	LREAL	Wh	0.0 ... 1.8 x 10 ³⁰⁸		✓		✓	✓
61222	Reactive energy inflow L3 ⁶	LREAL	varh	0.0 ... 1.8 x 10 ³⁰⁸		✓		✓	✓
61223	Reactive energy outflow L3 ⁶	LREAL	varh	0.0 ... 1.8 x 10 ³⁰⁸		✓		✓	✓
61224	Apparent energy L3 ⁶	LREAL	VAh	0.0 ... 1.8 x 10 ³⁰⁸		✓		✓	✓
61225	Active energy L3 ⁶	LREAL	Wh	±1.8 x 10 ³⁰⁸		✓		✓	✓
61226	Reactive energy 7L3 ⁶	LREAL	varh	±1.8 x 10 ³⁰⁸		✓		✓	✓
61230	Overflow counter active energy inflow L3 ⁶	UINT	-	0 ... 65535		✓		✓	✓
61231	Overflow counter active energy outflow L3 ⁶	UINT	-	0 ... 65535		✓		✓	✓
61232	Overflow counter reactive energy inflow L3 ⁶	UINT	-	0 ... 65535		✓		✓	✓
61233	Overflow counter reactive energy outflow L3 ⁶	UINT	-	0 ... 65535		✓		✓	✓
61234	Overflow counter apparent energy L3 ⁶	UINT	-	0 ... 65535		✓		✓	✓
62110	Active energy inflow L1 ⁶	UDINT	Wh	0 ... 2147483647	✓	✓	✓	✓	✓
62111	Active energy outflow L1 ⁶	UDINT	Wh	0 ... 2147483647	✓	✓	✓	✓	✓
62112	Reactive energy inflow L1 ⁶	UDINT	Varh	0 ... 2147483647	✓	✓	✓	✓	✓
62113	Reactive energy outflow L1 ⁶	UDINT	Varh	0 ... 2147483647	✓	✓	✓	✓	✓
62114	Apparent energy L1 ⁶	UDINT	Wh	0 ... 2147483647	✓	✓	✓	✓	✓
62115	Active energy L1 total (inflow - outflow) ⁶	DINT	Wh	±2147483647	✓	✓	✓	✓	✓
62116	Reactive energy L1 total (inflow - outflow) ⁶	DINT	Varh	±2147483647	✓	✓	✓	✓	✓
62210	Active energy inflow L2 ⁶	UDINT	Wh	0 ... 2147483647		✓	✓	✓	✓
62211	Active energy outflow L2 ⁶	UDINT	Wh	0 ... 2147483647		✓	✓	✓	✓
62212	Reactive energy inflow L2 ⁶	UDINT	Varh	0 ... 2147483647		✓	✓	✓	✓
62213	Reactive energy outflow L2 ⁶	UDINT	Varh	0 ... 2147483647		✓	✓	✓	✓
62214	Apparent energy L2 ⁶	UDINT	VAh	0 ... 2147483647		✓		✓	✓

Measured variables

B.1 Measured process variables and connection type

Measured value ID	Measured variable	Data type	Unit	Value range	Connection type				
					1P2W	3x1P2W	2P3W	3P4W	3P4W1
62215	Active energy L2 total (inflow - outflow) ⁶	DINT	Wh	±2147483647		✓	✓	✓	✓
62216	Reactive energy L2 total (inflow - outflow) ⁶	DINT	Varh	±2147483647		✓	✓	✓	✓
62310	Active energy inflow L3 ⁶	UDINT	Wh	0 ... 2147483647		✓		✓	✓
62311	Active energy outflow L3 ⁶	UDINT	Wh	0 ... 2147483647		✓		✓	✓
62312	Reactive energy inflow L3 ⁶	UDINT	Varh	0 ... 2147483647		✓		✓	✓
62313	Reactive energy outflow L3 ⁶	UDINT	Varh	0 ... 2147483647		✓		✓	✓
62314	Apparent energy L3 ⁶	UDINT	VAh	0 ... 2147483647		✓		✓	✓
62315	Active energy L3 total (inflow - outflow) ⁶	DINT	Wh	±2147483647		✓		✓	✓
62316	Reactive energy L3 total (inflow - outflow) ⁶	DINT	Varh	±2147483647		✓		✓	✓
65500	Qualifier L1	WORD	Bit field	0b 00 00 00 00 0b qq 00 00 xx	✓	✓	✓	✓	✓
65501	Qualifier L2	WORD	Bit field	0b 00 00 00 00 0b qq 00 xx 00		✓	✓	✓	✓
65502	Qualifier L3	WORD	Bit field	0b 00 00 00 00 0b qq xx 00 00		✓		✓	✓
65503	Qualifier L1L2L3	WORD	Bit field	0b 00 00 00 00 0b qq xx xx xx	✓	✓	✓	✓	✓
65504	Total operating hours counter L1L2L3 ⁹	REAL	h	0.0 ... 3.4 x 10 ³⁸	✓	✓	✓	✓	✓
65505	Operating hours counter L1 ⁵	REAL	h	0.0 ... 3.4 x 10 ³⁸	✓	✓	✓	✓	✓
65506	Operating hours counter L2 ⁵	REAL	h	0.0 ... 3.4 x 10 ³⁸		✓	✓	✓	✓
65507	Operating hours counter L3 ⁵	REAL	h	0.0 ... 3.4 x 10 ³⁸		✓		✓	✓
65508	Status of energy counter overflows	WORD	Bit field	0x xxxx xxxx	✓	✓	✓	✓	✓
66001	Voltage UL1-N ¹	UINT	0.01 V	0 ... 65535	✓	✓	✓	✓	✓
66002	Voltage UL2-N ¹	UINT	0.01 V	0 ... 65535		✓	✓	✓	✓
66003	Voltage UL3-N ¹	UINT	0.01 V	0 ... 65535		✓		✓	✓
66004	Voltage UL1-L2 ²	UINT	0.01 V	0 ... 65535				✓	✓
66005	Voltage UL2-L3 ²	UINT	0.01 V	0 ... 65535				✓	✓

B.1 Measured process variables and connection type

Measured value ID	Measured variable	Data type	Unit	Value range	Connection type				
					1P2W	3x1P2W	2P3W	3P4W	3P4W1
66006	Voltage UL3-L1 ²	UINT	0.01 V	0 ... 65535				✓	✓
66007	Current L1 ¹	UINT	1 mA	0 ... 65535	✓	✓	✓	✓	✓
66008	Current L2 ¹	UINT	1 mA	0 ... 65535		✓	✓	✓	✓
66009	Current L3 ¹	UINT	1 mA	0 ... 65535		✓		✓	✓
66010	Apparent power L1 ³	INT	1 VA	-27648 ... 27648	✓	✓	✓	✓	✓
66011	Apparent power L2 ³	INT	1 VA	-27648 ... 27648		✓	✓	✓	✓
66012	Apparent power L3 ³	INT	1 VA	-27648 ... 27648		✓		✓	✓
66013	Active power L1 ³	INT	1 W	-27648 ... 27648	✓	✓	✓	✓	✓
66014	Active power L2 ³	INT	1 W	-27648 ... 27648		✓	✓	✓	✓
66015	Active power L3 ³	INT	1 W	-27648 ... 27648		✓		✓	✓
66016	Reactive power L1 ³	INT	1 var	-27648 ... 27648	✓	✓	✓	✓	✓
66017	Reactive power L2 ³	INT	1 var	-27648 ... 27648		✓	✓	✓	✓
66018	Reactive power L3 ³	INT	1 var	-27648 ... 27648		✓		✓	✓
66019	Power factor L1 ³	USINT	0.01	0 ... 100	✓	✓	✓	✓	✓
66020	Power factor L2 ³	USINT	0.01	0 ... 100		✓	✓	✓	✓
66021	Power factor L3 ³	USINT	0.01	0 ... 100		✓		✓	✓
66030	Frequency ⁴	USINT	1 Hz	45 ... 65	✓	✓	✓	✓	✓
66034	Total active power L1L2L3 ⁵	INT	1 W	-27648 ... 27648	✓	✓	✓	✓	✓
66035	Total reactive power L1L2L3 ⁵	INT	1 var	-27648 ... 27648	✓	✓	✓	✓	✓
66036	Total apparent power L1L2L3 ⁵	INT	1 VA	-27648 ... 27648	✓	✓	✓	✓	✓
66037	Total power factor L1L2L3 ⁶	USINT	0.01	0 ... 100	✓	✓	✓	✓	✓
66038	Frequency ⁴	UINT	0.01 Hz	4500 ... 6500	✓	✓	✓	✓	✓

¹ Effective value

² IEC 61557-12

³ Arithmetical mean value over 200 ms as floating mean

⁴ Arithmetical mean value over 10 s as floating mean

⁵ Simple summation

⁶ Calculation from the start/restart (inflow and outflow values are positive numbers)

⁷ Determined from ratio of active and apparent power

⁸ For mapping both states as UINT (high: Energy counter overflow, low limit)

⁹ Corresponds to the maximum of the phase-specific operating hours counters

Module version configuration options

C.1 Module version "2 bytes I/ 2 bytes O"

User data

The module version has 2 bytes of input user data and 2 bytes of output user data, for status and control information. For this module version, measured variables can be read only by the measured value data records (no measured variables can be evaluated via user data).

Structure of input user data

The structure of the input user data is fixed.

Table C- 1 Structure of input user data (2 bytes)

Byte	Validity	Designation	Comment
0	Module	Process data variant	Constant = 80H
1	Module	Quality information	Quality bits describe the quality of the basic measured values

Assignment of the input user data

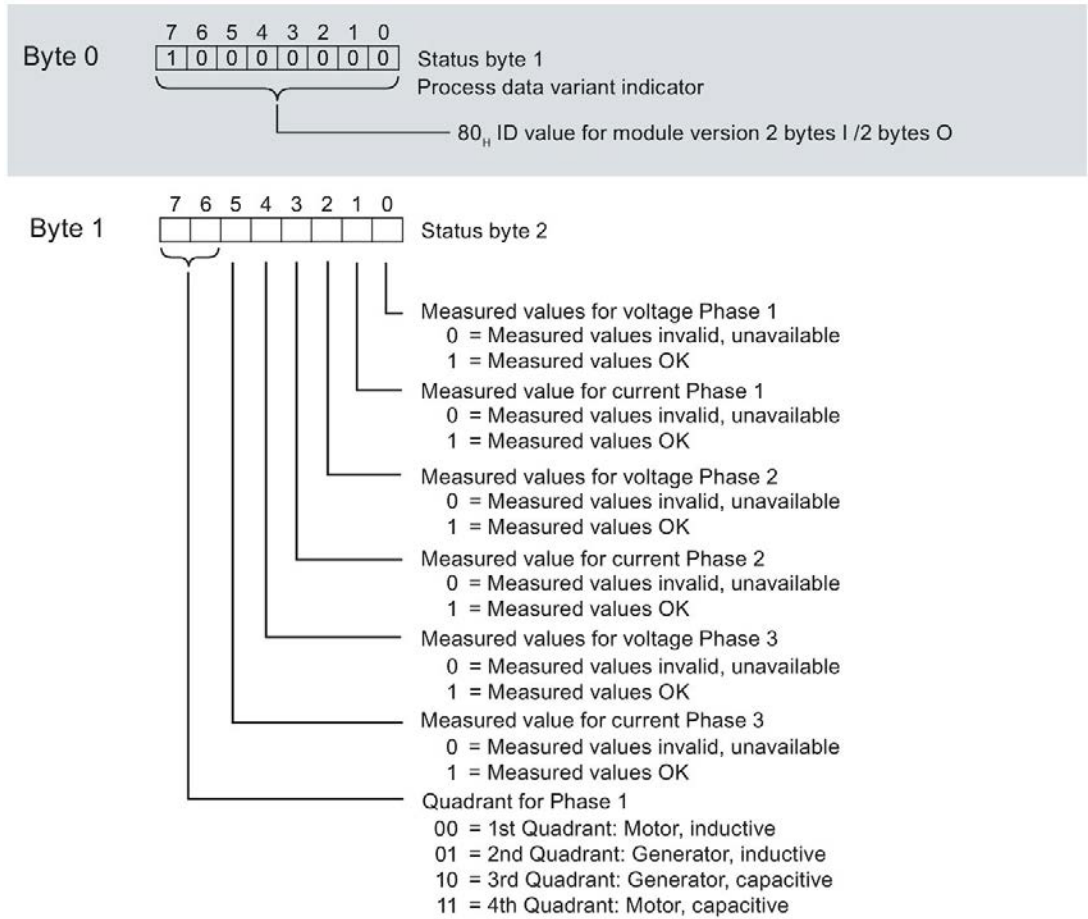

Figure C-1 Assignment of the status bytes in the input user data (2 bytes)

Structure of output user data

The structure of the output user data is fixed.

Table C- 2 Structure of output user data (2 bytes)

Byte	Validity	Designation	Comment
0	Module	Reserved	Reserved
1	Module	Control outputs	Reset values, counters, and gate control

Assignment of the output user data

All phases are controlled for these actions.

- Resetting minimum values, maximum values, operating hours counters, and energy counters.
- Gate control for operating hours counter and energy counters.

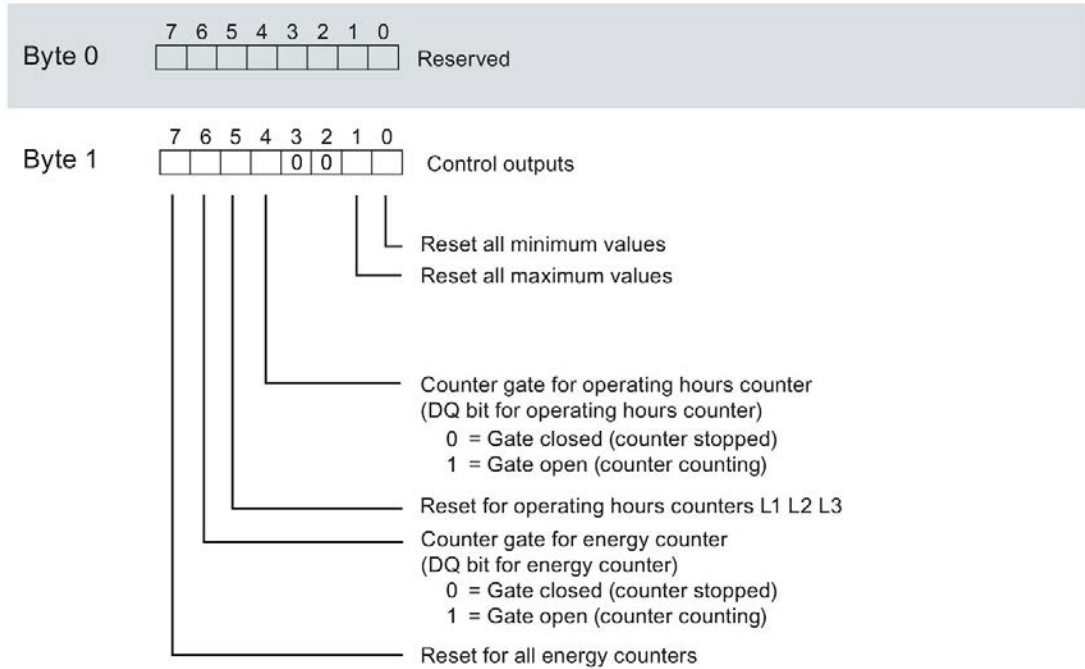

Figure C-2 Assignment of the control byte in the output user data (2 bytes)

Note

For module version 2 bytes I / 2 bytes O, a reset of the selected variables always acts on **all** measured values/counter levels of the three phases.

- Reset energy counter: Acts on all active, reactive and apparent energies of all phases
- Reset operating hours counter: Acts on the counters of Phases 1, 2, and 3
- Reset minimum / maximum values: Acts on the minimum and maximum value calculations of Phases 1, 2, and 3

C.2 Module versions that allow run-time change of Siemens defined Process data variants

C.2.1 Module version "32 I bytes I/ 12 bytes O"

User data

The module uses 32 bytes of input user data and 12 bytes of output user data. Measured variables can be read cyclically via user data (Bytes 2 ... 31) or asynchronously via measured value data records.

If you select the "32 bytes I/12 bytes O" module version, then you must also select a "Process data variant". In RUN mode, you can change to 21 of the 22 different Process data variants. The variant names indicate the different sets of measurements that are available to your program.

All Process data variant options, except EE@Industry measurement data profile e3, require 32 input bytes and 12 output bytes. The "EE@Industry measurement data profile e3" requires 112 input bytes and 12 output bytes. If you want to do RUN mode Process data variant switching that includes the EE@Industry measurement data profile e3, then you must assign the module version "112 bytes I /12 bytes O".

The actual measurement data that is transferred to the input I bytes and read by your program depends on the Process data variant selection.

You can find details about all Process data variants and the measurements they provide in the Overview of Process data variant options (Page 126) section of appendix C.

All 22 different Process data variants use the same 12 byte output format.

Structure of input user data

You can change the type of measurement data provided to the user data program interface dynamically, by changing the Process data variant which changes the measurement data available in the user data program interface.

Table C- 3 Structure of input user data (32 I bytes)

Byte	Validity	Designation	Comment
0	Module	Process data variant ID	Active Process data variant indicator
1	Module	Quality information	Quality bits describe the quality of the basic measured values
2 ... 31	Module or phase	Data	2 or 4 bytes of measured values or calculated values, according to active Process data variant

Assignment of the input user data

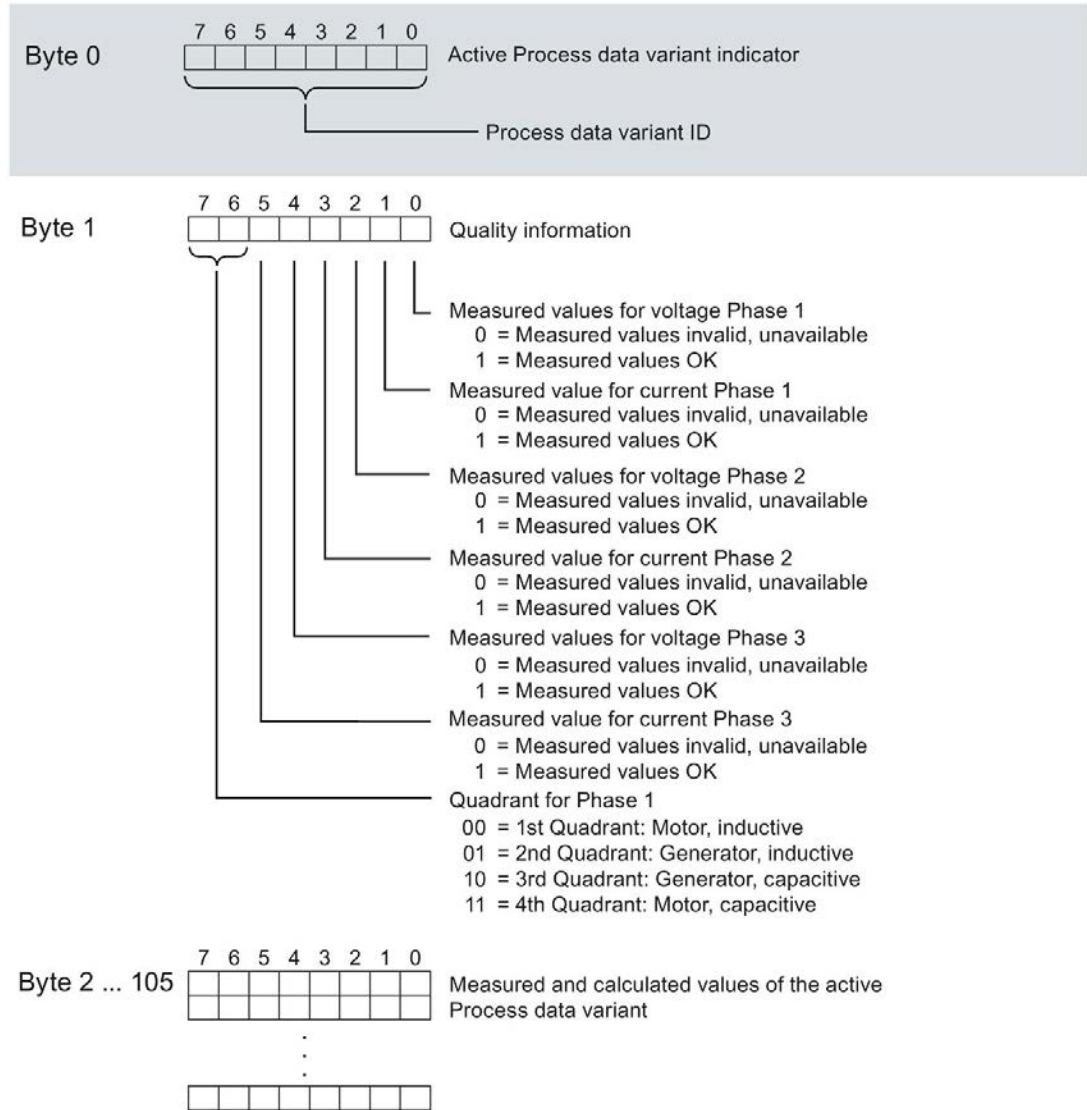

Figure C-3 Assignment of the input user data (32 bytes)

Structure of output user data for all Process data variants (12 Q byte addresses)

The structure of the output user data is fixed and is the same for all Process data variants.

Using the output user data you can control all or individual phase actions

- Resetting minimum values, maximum values, operating hours counter, and energy counters.
- Gate control for operating hours counter and energy counters.

Table C- 4 Structure of output user data (12 bytes)

Byte	Validity	Designation	Comment
0	Module	Process data variant	Control byte for switching the Process data variant
1	Module	Control byte 1	Global resetting of values and counters, gate Selection of the energy counter to be reset
2	Module	Control byte 2	
3	Module	Reserved	-
4	Module	Reserved	-
5	Module	Reserved	-
6	Phase L1	Control byte 6	Phase-specific resetting of values and counters, gate for Phase 1
7	Phase L1	Control byte 7	
8	Phase L2	Control byte 8	Phase-specific resetting of values and counters, gate for Phase 2
9	Phase L2	Control byte 9	
10	Phase L3	Control byte 10	Phase-specific resetting of values and counters, gate for Phase 3
11	Phase L3	Control byte 11	

Control byte for changing Process data variant



Figure C-4 Assignment of the control byte for Process data variant selector (Byte 0)

Control bytes for all three phases

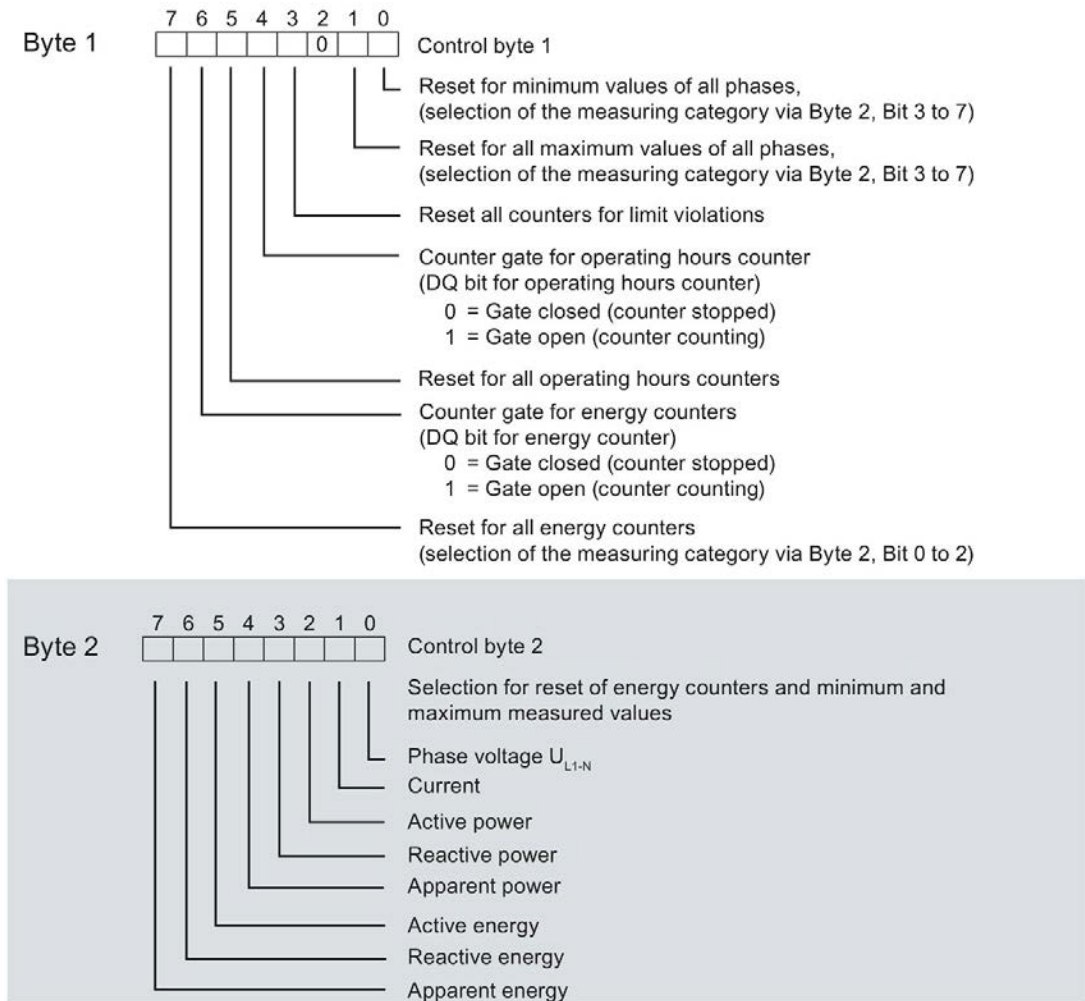

Figure C-5 Assignment of the control bytes for all three phases (bytes 1 and 2)

Control bytes for each individual phase

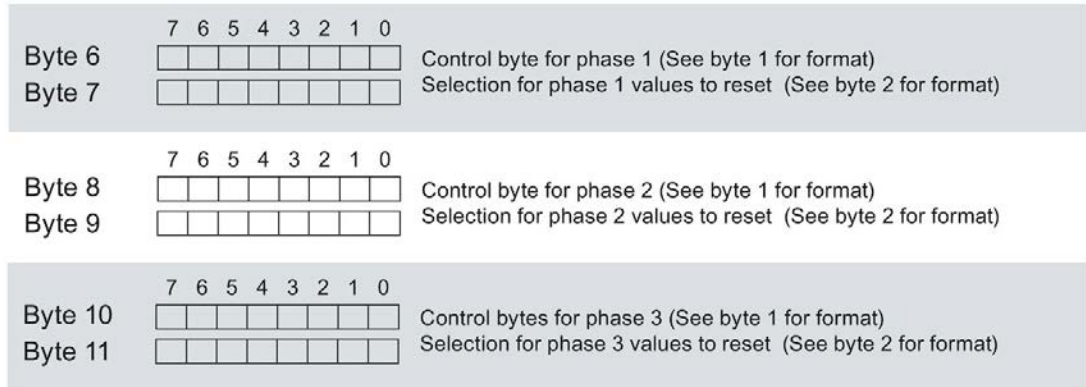

Figure C-6 Assignment of the control bytes for each individual phase (bytes 6 to 11)

C.2.2 Module version "112 bytes I/ 12 bytes O"

User data

The module uses 112 bytes of input user data and 12 bytes of output user data. Measured variables can be read cyclically via user data (Bytes 2 ... 111) or asynchronously via measured value data records.

If you select the "112 bytes I/ 12 bytes O" module version, then you must also select a "Process data variant". In RUN mode, you can switch to any one of the 22 Process data variants that provide different types of measurement data to your program.

All Process data variant options, except EE@Industry measurement data profile e3, require 32 input bytes and 12 output bytes. The "EE@Industry measurement data profile e3" requires 112 input bytes and 12 output bytes. If you select this module version that allocates 112 input bytes, then sufficient input byte addresses are allocated to switch to any of the (32 input byte) Process data variants.

The actual measurement data that is transferred to the input I bytes and read by your program depends on the Process data variant selection.

You can find details about all Process data variants and the measurements they provide in the "Process data variant" options (Page 126) section of appendix C.

All 22 Process data variants use the same 12 byte output format.

Structure of input user data (112 I byte addresses)

You can change the type of measurement data provided to the user data program interface dynamically, by changing the Process data variant which changes the measurement data in the user data program interface.

Table C- 5 Structure of input user data (112 I bytes)

Byte	Validity	Designation	Comment
0	Module	Process data variant ID	Active Process data variant indicator
1	Module	Quality information	Quality bits to describe the quality of the basic measured values
2 ... 31	Module or phase	Data	2 or 4 bytes of measured values or calculated values according to the Process data variant (for variant with 32 input bytes)
2 ... 105	Module or phase	Data	4 byte measured values or calculated values (for EE@Industry measurement data profile E3 - 112 input bytes)

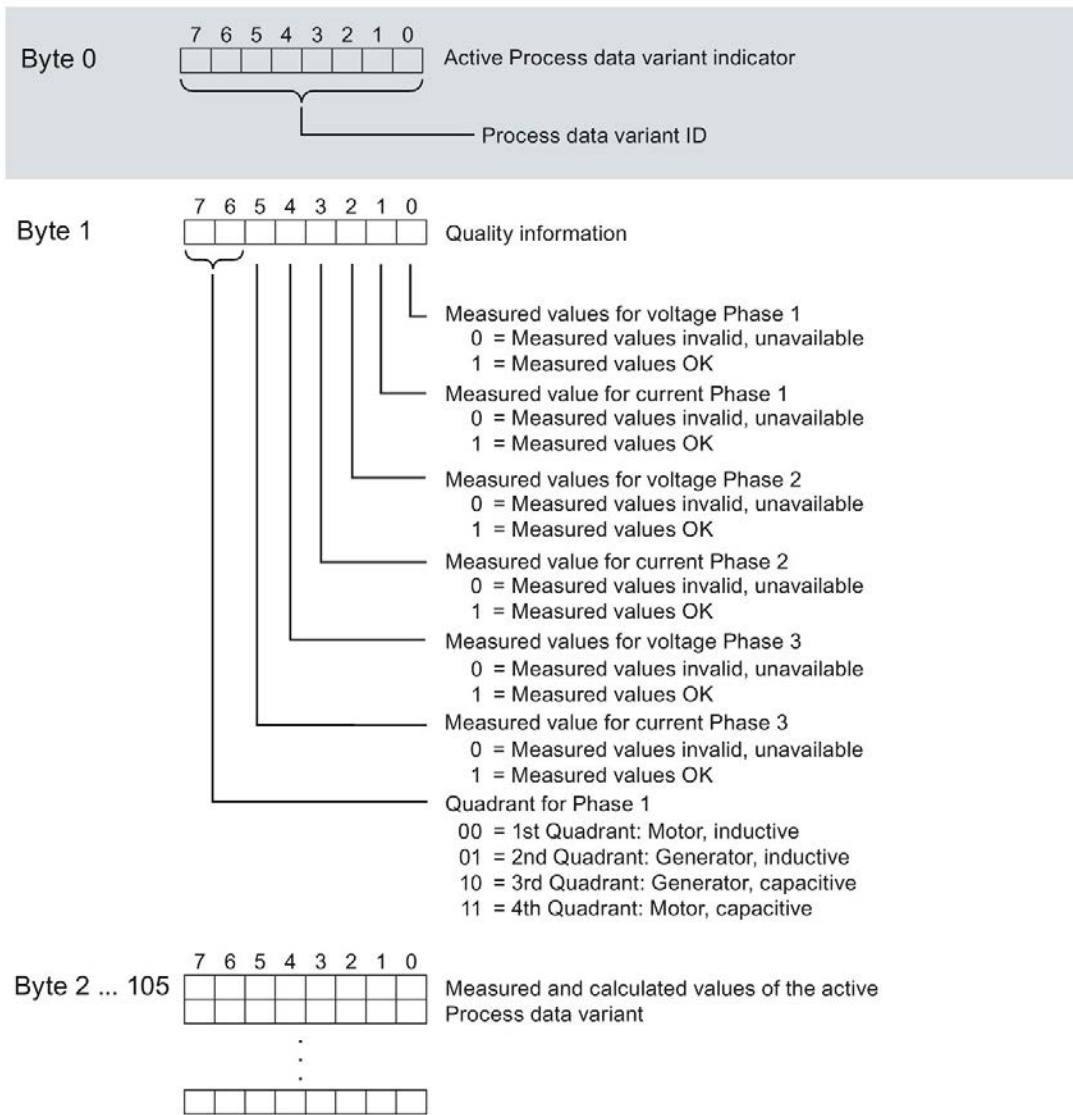

Figure C-7 Assignment of the input user data (112 bytes)

Structure of output user data for all Process data variants (12 Q byte addresses)

The structure of the output user data is fixed and is the same for all the Process data variants.

Using the output user data you can control all or individual phase actions

- Resetting minimum values, maximum values, operating hours counter, and energy counters.
- Gate control for operating hours counter and energy counters.

Table C- 6 Structure of output user data (12 bytes)

Byte	Validity	Designation	Comment
0	Module	Process data variant	Control byte for switching the Process data variant
1	Module	Digital control outputs	Reset of values, counters, and gate control
2	Module	Digital control outputs	Selection of the energy counter to be reset
3	Module	Reserved	-
4	Module	Reserved	-
5	Module	Reserved	-
6	Phase L1	Control byte 6	Phase-specific resetting of values and counters, gate for Phase 1
7	Phase L1	Control byte 7	
8	Phase L2	Control byte 8	Phase-specific resetting of values and counters, gate for Phase 2
9	Phase L2	Control byte 9	
10	Phase L3	Control byte 10	Phase-specific resetting of values and counters, gate for Phase 3
11	Phase L3	Control byte 11	

Control byte for changing Process data variant



Figure C-8 Assignment of the control byte for Process data variant selector (Byte 0)

Control bytes for all three phases

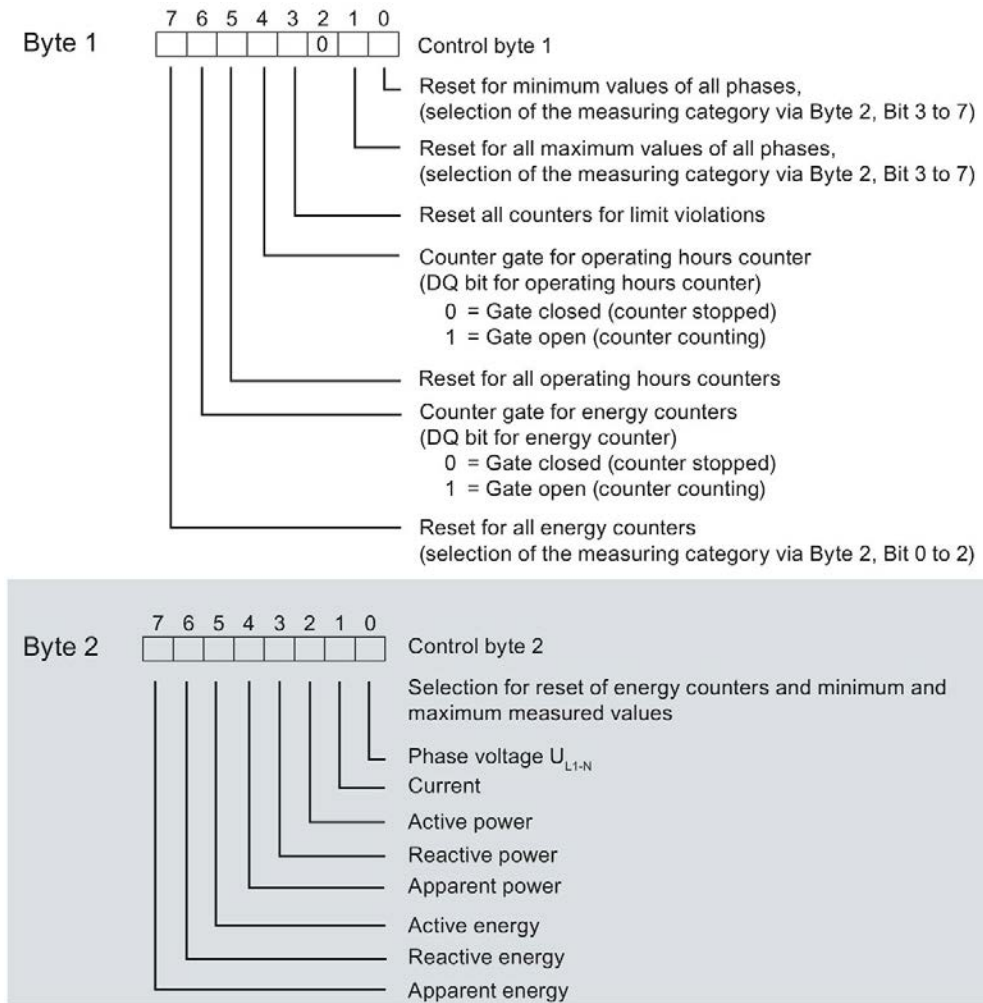

Figure C-9 Assignment of the control bytes for all three phases (bytes 1 and 2)

Control bytes for each individual phase

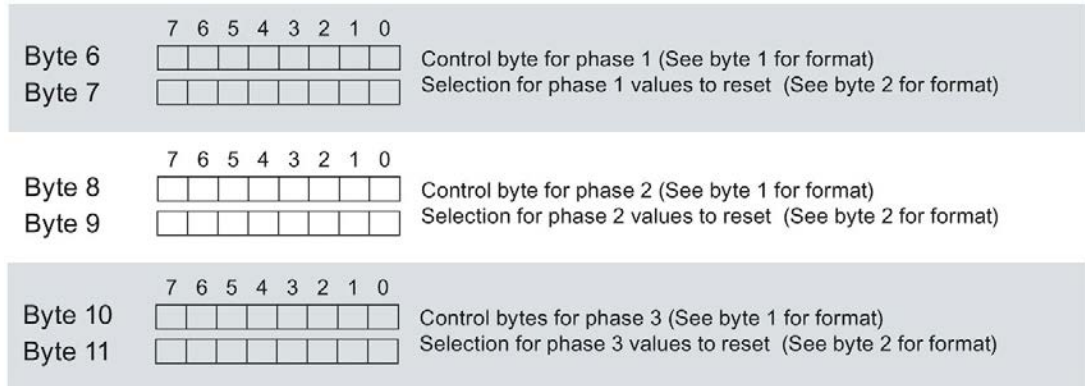

Figure C-10 Assignment of the control bytes for each individual phase (bytes 6 to 11)

C.3 Module version "EE@Industry measured data profile" E0 / E1 / E2 / E3

User data of the module

The four versions according to EE@Industry use between 4 and 104 bytes of input user data and 12 bytes of output user data. A run-time switchover to another Process data variant is not possible.

Structure of input user data

The structure of the input user data for the module versions according to the EE@Industry standard is fixed and depends on the selected measurement data profile.

Table C- 7 Module version E0H input user data

Byte	Allocation	Data type	Unit	Value range	Measured value ID
0 ... 3	Current L1	REAL	1 A	0.0 ... 100000.0	7
4 ... 7	Current L2	REAL	1 A	0.0 ... 100000.0	8
8 ... 11	Current L3	REAL	1 A	0.0 ... 100000.0	9

Table C- 8 Module version E1_H input user data

Byte	Allocation	Data type	Unit	Value range	Measured value ID
0 ... 3	Total active power L1L2L3	REAL	1 W	$-3.0 \times 10^9 \dots +3.0 \times 10^9$	34

Table C- 9 Module version E2_H input user data

Byte	Allocation	Data type	Unit	Value range	Measured value ID
0 ... 3	Total active power L1L2L3	REAL	1 W	$-3.0 \times 10^9 \dots +3.0 \times 10^9$	34
4 ... 7	Total active energy L1L2L3 inflow	REAL	1 Wh	$0 \dots 1.8 \times 10^{38}$	210
8 ... 11	Total active energy L1L2L3 outflow	REAL	1 Wh	$0 \dots 1.8 \times 10^{38}$	211

Table C- 10 Module version E3_H input user data

Byte	Allocation	Data type	Unit	Value range	Measured value ID
0 ... 3	Active power L1	REAL	1 W	$-3.0 \times 10^9 \dots +3.0 \times 10^9$	13
4 ... 7	Active power L2	REAL	1 W	$-3.0 \times 10^9 \dots +3.0 \times 10^9$	14
8 ... 11	Active power L3	REAL	1 W	$-3.0 \times 10^9 \dots +3.0 \times 10^9$	15
12 ... 15	Reactive power L1	REAL	1 var	$-3.0 \times 10^9 \dots +3.0 \times 10^9$	16
16 ... 19	Reactive power L2	REAL	1 var	$-3.0 \times 10^9 \dots +3.0 \times 10^9$	17
20 ... 23	Reactive power L3	REAL	1 var	$-3.0 \times 10^9 \dots +3.0 \times 10^9$	18
24 ... 31	Total active energy L1L2L3 inflow	LREAL	1 Wh	$0 \dots 1.8 \times 10^{308}$	210
32 ... 39	Total active energy L1L2L3 outflow	LREAL	1 Wh	$0 \dots 1.8 \times 10^{308}$	211
40 ... 47	Total reactive energy L1L2L3 inflow	LREAL	1 varh	$0 \dots 1.8 \times 10^{308}$	212
48 ... 55	Total reactive energy L1L2L3 outflow	LREAL	1 varh	$0 \dots 1.8 \times 10^{308}$	213
56 ... 59	Voltage UL1-N	REAL	1 V	$0.0 \dots 1000000.0$	1
60 ... 63	Voltage UL2-N	REAL	1 V	$0.0 \dots 1000000.0$	2
64 ... 67	Voltage UL3-N	REAL	1 V	$0.0 \dots 1000000.0$	3
68 ... 71	Voltage UL1-UL2	REAL	1 V	$0.0 \dots 1000000.0$	4
72 ... 75	Voltage UL2-UL3	REAL	1 V	$0.0 \dots 1000000.0$	5
76 ... 79	Voltage UL3-UL1	REAL	1 V	$0.0 \dots 1000000.0$	6

Byte	Allocation	Data type	Unit	Value range	Measured value ID
80 ... 83	Current L1	REAL	1 A	0.0 ... 100000.0	7
84 ... 87	Current L2	REAL	1 A	0.0 ... 100000.0	8
88 ... 91	Current L3	REAL	1 A	0.0 ... 100000.0	9
92 ... 95	Power factor L1	REAL	-	0.0 ... 1.0	19
96 ... 99	Power factor L2	REAL	-	0.0 ... 1.0	20
100 ... 103	Power factor L3	REAL	-	0.0 ... 1.0	21

Structure of output user data

The structure of the output user data is fixed

Using the output user data you can control all or individual phase actions

- Resetting minimum values, maximum values, operating hours counter, and energy counters.
- Gate control for operating hours counter and energy counters.

Table C- 11 Structure of output user data (12 bytes)

Byte	Validity	Designation	Comment
0	Module	Reserved	
1	Module	Digital control outputs	Reset of values, counters, and gate control
2	Module	Digital control outputs	Selection of the energy counter to be reset
3	Module	Reserved	-
4	Module	Reserved	-
5	Module	Reserved	-
6	Phase L1	Control byte 6	Phase-specific resetting of values and counters, gate for Phase 1
7	Phase L1	Control byte 7	
8	Phase L2	Control byte 8	Phase-specific resetting of values and counters, gate for Phase 2
9	Phase L2	Control byte 9	
10	Phase L3	Control byte 10	Phase-specific resetting of values and counters, gate for Phase 3
11	Phase L3	Control byte 11	

C.3 Module version "EE@Industry measured data profile" E0 / E1 / E2 / E3

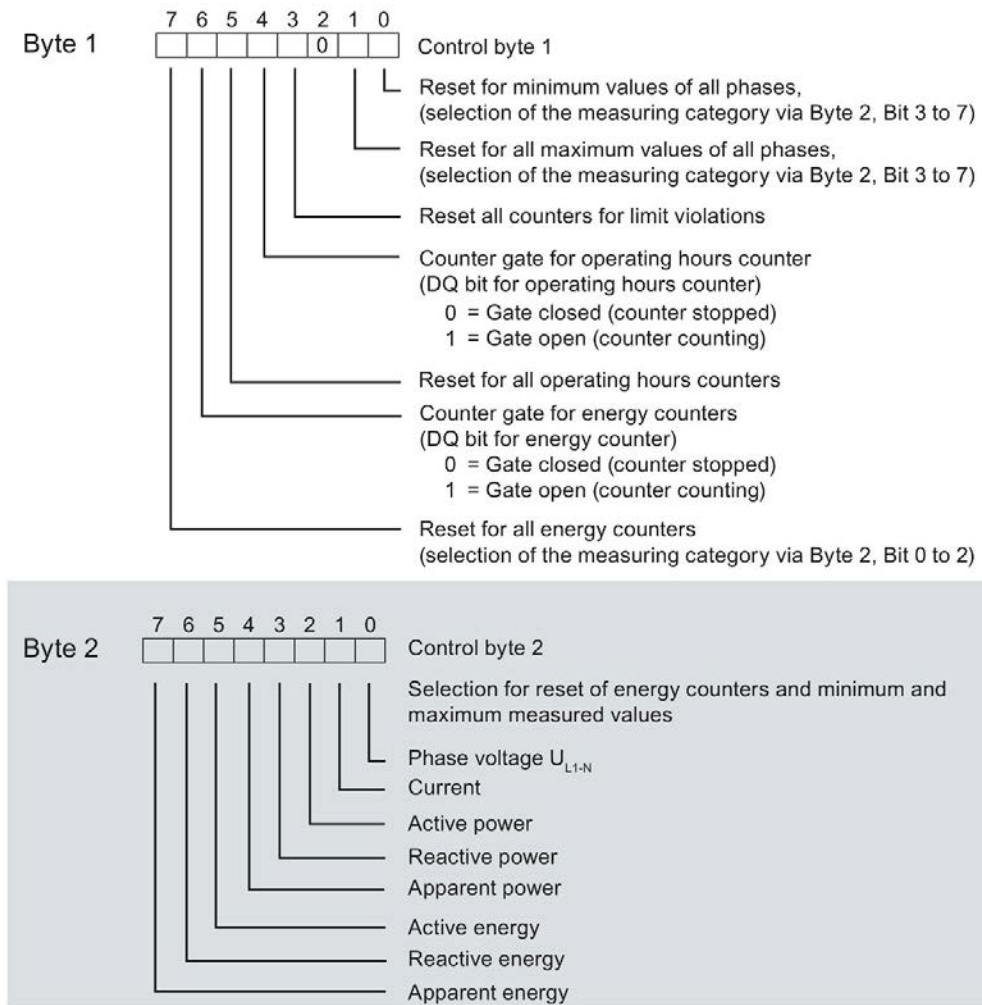

Figure C-11 Byte allocation of the 12 bytes of output data (bytes 1 to 2)

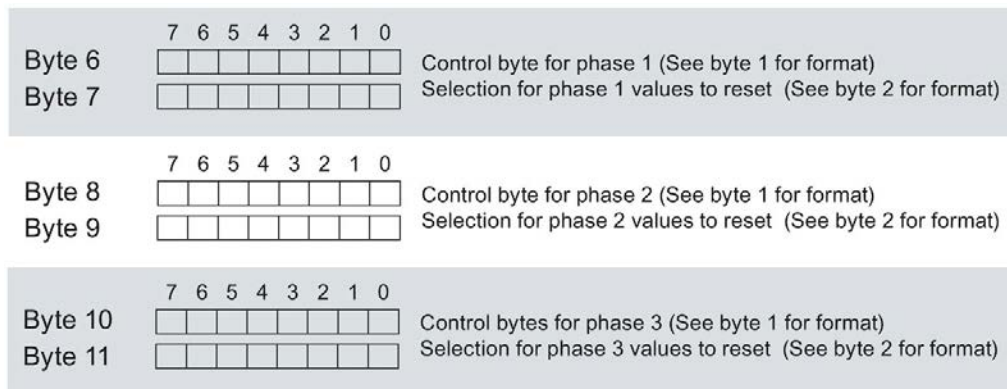

Figure C-12 Byte allocation of the 12 bytes of output data (bytes 6 to 11)

Process data variant options

D.1 Overview of Process data variant options

Process data variant selection

30 bytes/submodule is available to transfer the measured values cyclically to the input/output user data memory. You can only transmit a limited number of measured values to your program with 30 bytes of memory space. To get around this limitation, your program can change the "Process data variant" (a Siemens defined process measurement set) and begin cyclically loading the user data area with a different set of process data. The user data area is read with your program's I addresses (measurement values and status) and written with Q addresses (module control data).

TIA Portal SM 1238 device configuration

If you select the module version "32 bytes I/12 bytes O" or "112 bytes I/ 12 bytes O" in the device configuration, then you enable the drop-list where you can select the initial Process data variant. Later in RUN mode, you can change the Process data variant by writing a new ID to the Process data variant selector Q byte address.

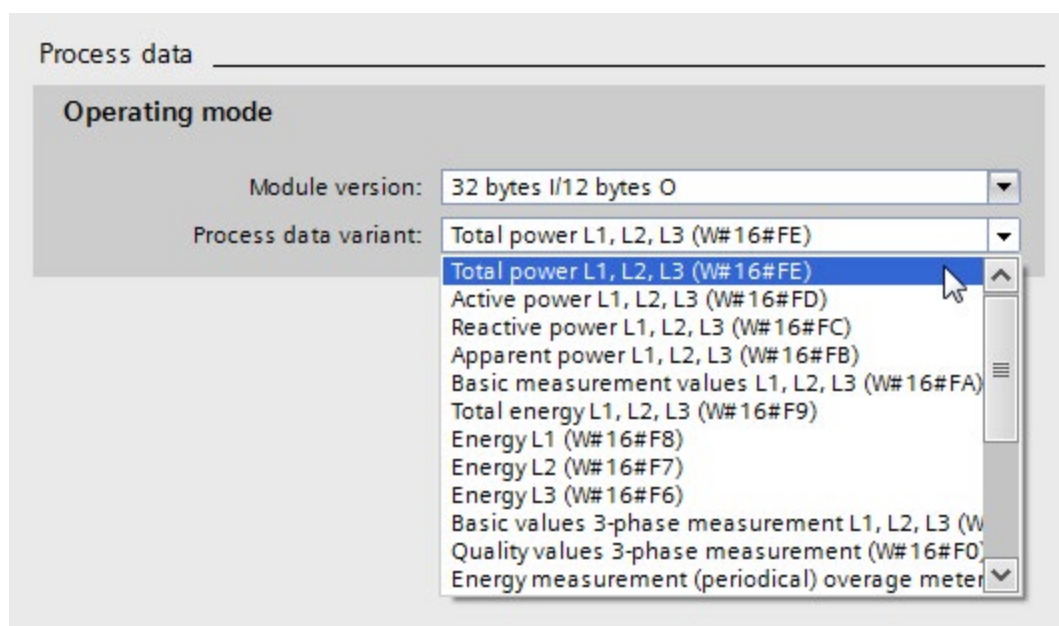

Figure D-1 TIA Portal Process data variant device configuration

User data memory and Process data variants

Your program, while in RUN mode, can select one of 22 preconfigured Process data variants from the following table.

Process data variant name	Process data variant identifier value	User data interface required I/O bytes	
		Input I	Output Q
Total power L1, L2, L3 (Page 128)	254 or FE _H (default)	32	12
Active power L1, L2, L3 (Page 129)	253 or FD _H	32	12
Reactive power L1, L2, L3 (Page 130)	252 or FC _H	32	12
Apparent power L1, L2, L3 (Page 131)	251 or FB _H	32	12
Basic measurement values L1, L2, L3 (Page 132)	250 or FA _H	32	12
Total energy L1, L2, L3 (Page 133)	249 or F9 _H	32	12
Energy L1 (Page 134)	248 or F8 _H	32	12
Energy L2 (Page 135)	247 or F7 _H	32	12
Energy L3 (Page 136)	246 or F6 _H	32	12
Basic values 3-phase measurement L1, L2, L3 (Page 137)	245 or F5 _H	32	12
Quality values 3-phase measurement (Page 138)	240 or F0 _H	32	12
Energy measurement (periodical) overage meter (Page 139)	239 or EF _H	32	12
EE@Industry measurement data profile E3 (Page 140)	227 or E3 _H	112	12
EE@Industry measurement data profile E2 (Page 141)	226 or E2 _H	32	12
EE@Industry measurement data profile E1 (Page 141)	225 or E1 _H	32	12
EE@Industry measurement data profile E0 (Page 142)	224 or E0 _H	32	12
Basic values single phase measurement L1 (Page 142)	159 or 9F _H	32	12
Basic values single phase measurement L1a (Page 143)	158 or 9E _H	32	12
Basic values single phase measurement L2 (Page 144)	157 or 9D _H	32	12
Basic values single phase measurement L2a (Page 145)	156 or 9C _H	32	12
Basic values single phase measurement L3 (Page 146)	155 or 9B _H	32	12
Basic values single phase measurement L3a (Page 147)	154 or 9A _H	32	12

D.2 Total power L1, L2, L3 (W# 16# FE)

Total power L1, L2, L3 (ID 254 or FE_H)

Table D- 1 Total power L1, L2, L3 Process data variant

Byte	Allocation	Data type	Unit	Value range	Measured value ID
0	Process data variant indicator	BYTE	-	254 (FE _H)	-
1	Quality information = QQ ₁ I ₃ U ₃ I ₂ U ₂ I ₁ U ₁	BYTE	Bit string	qq xx xx xx	-
2 ... 3	Current L1	UINT	1 mA	0 ... 65535	66007
4 ... 5	Current L2	UINT	1 mA	0 ... 65535	66008
6 ... 7	Current L3	UINT	1 mA	0 ... 65535	66009
8 ... 9	Total active power L1L2L3	INT	1 W	-27648 ... 27648	66034
10 ... 11	Total reactive power L1L2L3	INT	1 var	-27648 ... 27648	66035
12 ... 13	Total apparent power L1L2L3	INT	1 VA	-27648 ... 27648	66036
14 ... 17	Total active energy L1L2L3	DINT	1 Wh	±2147483647	225
18 ... 21	Total reactive energy L1L2L3	DINT	1 varh	±2147483647	226
22	Reserved	BYTE	-	0	-
23	Total power factor L1L2L3	USINT	0.01	0 ... 100	66037
24	Scaling current L1	USINT	-	0 ... 255	-
25	Scaling current L2	USINT	-	0 ... 255	-
26	Scaling current L3	USINT	-	0 ... 255	-
27	Scaling total active power L1L2L3	USINT	-	0 ... 255	-
28	Scaling total reactive power L1L2L3	USINT	-	0 ... 255	-
29	Scaling total apparent power L1L2L3	USINT	-	0 ... 255	-
30	Scaling total active energy L1L2L3	USINT	-	0 ... 255	-
31	Scaling total reactive energy L1L2L3	USINT	-	0 ... 255	-

D.3 Active power L1, L2, L3 (W# 16# FD)

Active power L1, L2, L3 (ID 253 or FD_H)

Table D- 2 Active power L1, L2, L3 Process data variant

Byte	Allocation	Data type	Unit	Value range	Measured value ID
0	Process data variant indicator	BYTE	-	253 (FD _H)	-
1	Quality information = QQ ₁ I ₃ U ₃ I ₂ U ₂ I ₁ U ₁	BYTE	Bit string	qq xx xx xx	-
2 ... 3	Current L1	UINT	1 mA	0 ... 65535	66007
4 ... 5	Current L2	UINT	1 mA	0 ... 65535	66008
6 ... 7	Current L3	UINT	1 mA	0 ... 65535	66009
8 ... 9	Active power L1	INT	1 W	-27648 ... 27648	66013
10 ... 11	Active power L2	INT	1 W	-27648 ... 27648	66014
12 ... 13	Active power L3	INT	1 W	-27648 ... 27648	66015
14 ... 15	Total active power L1L2L3	INT	1 W	-27648 ... 27648	66034
16 ... 19	Total active energy L1L2L3	DINT	1 Wh	±2147483647	225
20	Power factor L1	USINT	0.01	0 ... 100	66019
21	Power factor L2	USINT	0.01	0 ... 100	66020
22	Power factor L3	USINT	0.01	0 ... 100	66021
23	Total power factor L1L2L3	USINT	0.01	0 ... 100	66037
24	Scaling current L1	USINT	-	0 ... 255	-
25	Scaling current L2	USINT	-	0 ... 255	-
26	Scaling current L3	USINT	-	0 ... 255	-
27	Scaling active power L1	USINT	-	0 ... 255	-
28	Scaling active power L2	USINT	-	0 ... 255	-
29	Scaling active power L3	USINT	-	0 ... 255	-
30	Scaling active power L1L2L3	USINT	-	0 ... 255	-
31	Scaling total active energy L1L2L3	USINT	-	0 ... 255	-

D.4 Reactive power L1, L2, L3 (W# 16# FC)

Reactive power L1, L2, L3 (ID 252 or FC_H)

Table D- 3 Reactive power L1, L2, L3 Process data variant

Byte	Allocation	Data type	Unit	Value range	Measured value ID
0	Process data variant indicator	BYTE	-	252 (FC _H)	-
1	Quality information = QQ ₁ I ₃ U ₃ I ₂ U ₂ I ₁ U ₁	BYTE	Bit string	qq xx xx xx	-
2 ... 3	Current L1	UINT	1 mA	0 ... 65535	66007
4 ... 5	Current L2	UINT	1 mA	0 ... 65535	66008
6 ... 7	Current L3	UINT	1 mA	0 ... 65535	66009
8 ... 9	Reactive power L1	INT	1 var	-27648 ... 27648	66016
10 ... 11	Reactive power L2	INT	1 var	-27648 ... 27648	66017
12 ... 13	Reactive power L3	INT	1 var	-27648 ... 27648	66018
14 ... 15	Total reactive power L1L2L3	INT	1 var	-27648 ... 27648	66035
16 ... 19	Total reactive energy L1L2L3	DINT	1 varh	±2147483647	226
20	Power factor L1	USINT	0.01	0 ... 100	66019
21	Power factor L2	USINT	0.01	0 ... 100	66020
22	Power factor L3	USINT	0.01	0 ... 100	66021
23	Total power factor L1L2L3	USINT	0.01	0 ... 100	66037
24	Scaling current L1	USINT	-	0 ... 255	-
25	Scaling current L2	USINT	-	0 ... 255	-
26	Scaling current L3	USINT	-	0 ... 255	-
27	Scaling reactive power L1	USINT	-	0 ... 255	-
28	Scaling reactive power L2	USINT	-	0 ... 255	-
29	Scaling reactive power L3	USINT	-	0 ... 255	-
30	Scaling reactive power L1L2L3	USINT	-	0 ... 255	-
31	Scaling total reactive energy L1L2L3	USINT	-	0 ... 255	-

D.5 Apparent power L1, L2, L3 (W# 16# FB)

Apparent power L1, L2, L3 (ID 251 or FB_H)

Table D-4 Apparent power L1, L2, L3 Process data variant

Byte	Allocation	Data type	Unit	Value range	Measured value ID
0	Process data variant indicator	BYTE	-	251 (FB _H)	-
1	Quality information = QQ ₁ I ₃ U ₃ I ₂ U ₂ I ₁ U ₁	BYTE	Bit string	qq xx xx xx	-
2 ... 3	Current L1	UINT	1 mA	0 ... 65535	66007
4 ... 5	Current L2	UINT	1 mA	0 ... 65535	66008
6 ... 7	Current L3	UINT	1 mA	0 ... 65535	66009
8 ... 9	Apparent power L1	INT	1 VA	-27648 ... 27648	66010
10 ... 11	Apparent power L2	INT	1 VA	-27648 ... 27648	66011
12 ... 13	Apparent power L3	INT	1 VA	-27648 ... 27648	66012
14 ... 15	Total apparent power L1L2L3	INT	1 VA	-27648 ... 27648	66036
16 ... 19	Total apparent energy L1L2L3	UDINT	1 VAh	0 ... 2147483647	224
20	Power factor L1	USINT	0.01	0 ... 100	66019
21	Power factor L2	USINT	0.01	0 ... 100	66020
22	Power factor L3	USINT	0.01	0 ... 100	66021
23	Total power factor L1L2L3	USINT	0.01	0 ... 100	66037
24	Scaling current L1	USINT	-	0 ... 255	-
25	Scaling current L2	USINT	-	0 ... 255	-
26	Scaling current L3	USINT	-	0 ... 255	-
27	Scaling apparent power L1	USINT	-	0 ... 255	-
28	Scaling apparent power L2	USINT	-	0 ... 255	-
29	Scaling apparent power L3	USINT	-	0 ... 255	-
30	Scaling apparent power L1L2L3	USINT	-	0 ... 255	-
31	Scaling total apparent energy L1L2L3	USINT	-	0 ... 255	-

D.6 Basic measurement values L1, L2, L3 (W# 16# FA)

Basic measurement values L1, L2, L3 (ID 250 or FA_H)

Table D- 5 Basic measurement values L1, L2, L3 Process data variant

Byte	Allocation	Data type	Unit	Value range	Measured value ID
0	Process data variant indicator	BYTE	-	250 (FA _H)	-
1	Quality information = QQ ₁ I ₃ U ₃ I ₂ U ₂ I ₁ U ₁	BYTE	Bit string	qq xx xx xx	-
2 ... 3	Current L1	UINT	1 mA	0 ... 65535	66007
4 ... 5	Current L2	UINT	1 mA	0 ... 65535	66008
6 ... 7	Current L3	UINT	1 mA	0 ... 65535	66009
8 ... 9	Voltage UL1-N	UINT	0.01 V	0 ... 65535	66001
10 ... 11	Voltage UL2-N	UINT	0.01 V	0 ... 65535	66002
12 ... 13	Voltage UL3-N	UINT	0.01 V	0 ... 65535	66003
14 ... 15	Voltage UL1-UL2	UINT	0.01 V	0 ... 65535	66004
16 ... 17	Voltage UL2-UL3	UINT	0.01 V	0 ... 65535	66005
18 ... 19	Voltage UL3-UL1	UINT	0.01 V	0 ... 65535	66006
20	Power factor L1	USINT	0.01	0 ... 100	66019
21	Power factor L2	USINT	0.01	0 ... 100	66020
22	Power factor L3	USINT	0.01	0 ... 100	66021
23	Total power factor L1L2L3	USINT	0.01	0 ... 100	66037
24	Scaling current L1	USINT	-	0 ... 255	-
25	Scaling current L2	USINT	-	0 ... 255	-
26	Scaling current L3	USINT	-	0 ... 255	-
27	Scaling voltage UL1-N (UL1-UL2)	USINT	-	0 ... 255	-
28	Scaling voltage UL2-N (UL2-UL3)	USINT	-	0 ... 255	-
29	Scaling voltage UL3-N (UL3-UL1)	USINT	-	0 ... 255	-
30 ... 31	Frequency	UINT	0.01 Hz	4500 ... 6500	66038

D.7 Total energy L1, L2, L3 (W# 16# F9)

Total energy L1, L2, L3 (ID 249 or F9_H)

Table D- 6 Total energy L1, L2, L3 Process data variant

Byte	Allocation	Data type	Unit	Value range	Measured value ID
0	Process data variant indicator	BYTE	-	249 (F9 _H)	-
1	Quality information = QQ ₁ I ₃ U ₃ I ₂ U ₂ I ₁ U ₁	BYTE	Bit string	qq xx xx xx	-
2	Reserved	BYTE	-	-	-
3	Reserved	BYTE	-	-	-
4 ... 7	Total active energy inflow L1L2L3	UDINT	1 Wh	0 ... 2147483647	220
8 ... 11	Total active energy outflow L1L2L3	UDINT	1 Wh	0 ... 2147483647	221
11 ... 15	Total reactive energy inflow L1L2L3	UDINT	1 varh	0 ... 2147483647	222
16 ... 19	Total reactive energy outflow L1L2L3	UDINT	1 varh	0 ... 2147483647	223
20 ... 23	Total apparent energy L1L2L3	UDINT	1 VAh	0 ... 2147483647	224
24	Reserved	BYTE	-	-	-
25	Scaling active energy, inflow	USINT	-	0 ... 255	-
26	Scaling active energy, outflow	USINT	-	0 ... 255	-
27	Scaling reactive energy, inflow	USINT	-	0 ... 255	-
28	Scaling reactive energy, outflow	USINT	-	0 ... 255	-
29	Scaling apparent energy	USINT	-	0 ... 255	-
30	Reserved	BYTE	-	-	-
31	Total power factor L1L2L3	USINT	0.01	0 ... 100	66037

D.8 Energy L1 (W# 16# F8)

Energy L1 (ID 248 or F8_H)

Table D- 7 Energy L1 Process data variant

Byte	Allocation	Data type	Unit	Value range	Measured value ID
0	Process data variant indicator	BYTE	-	248 (F8 _H)	-
1	Quality information = QQ ₁ I ₃ U ₃ I ₂ U ₂ I ₁ U ₁	BYTE	Bit string	qq xx xx xx	-
2 ... 3	Current L1	UINT	1 mA	0 ... 65535	66007
4 ... 7	Active energy inflow L1	UDINT	1 Wh	0 ... 2147483647	62110
8 ... 11	Active energy outflow L1	UDINT	1 Wh	0 ... 2147483647	62111
11 ... 15	Reactive energy inflow L1	UDINT	1 varh	0 ... 2147483647	62112
16 ... 19	Reactive energy outflow L1	UDINT	1 varh	0 ... 2147483647	62113
20 ... 23	Apparent energy L1	UDINT	1 VAh	0 ... 2147483647	62114
24	Scaling current L1	USINT	-	0 ... 255	-
25	Scaling active energy inflow L1	USINT	-	0 ... 255	-
26	Scaling active energy outflow L1	USINT	-	0 ... 255	-
27	Scaling reactive energy inflow L1	USINT	-	0 ... 255	-
28	Scaling reactive energy outflow L1	USINT	-	0 ... 255	-
29	Scaling apparent energy L1	USINT	-	0 ... 255	-
30	Reserved	BYTE	-	-	-
31	Power factor L1	USINT	0.01	0 ... 100	66019

D.9 Energy L2 (W# 16# F7)

Energy L2 (ID 247 or F7_H)

Table D- 8 Energy L2 Process data variant

Byte	Allocation	Data type	Unit	Value range	Measured value ID
0	Process data variant indicator	BYTE	-	247 (F7 _H)	-
1	Quality information = QQ ₁ I ₃ U ₃ I ₂ U ₂ I ₁ U ₁	BYTE	Bit string	qq xx xx xx	-
2 ... 3	Current L2	UINT	1 mA	0 ... 65535	66008
4 ... 7	Active energy inflow L2	UDINT	1 Wh	0 ... 2147483647	62210
8 ... 11	Active energy outflow L2	UDINT	1 Wh	0 ... 2147483647	62211
11 ... 15	Reactive energy inflow L2	UDINT	1 varh	0 ... 2147483647	62212
16 ... 19	Reactive energy outflow L2	UDINT	1 varh	0 ... 2147483647	62213
20 ... 23	Apparent energy L2	UDINT	1 VAh	0 ... 2147483647	62214
24	Scaling current L2	USINT	-	0 ... 255	-
25	Scaling active energy inflow L2	USINT	-	0 ... 255	-
26	Scaling active energy outflow L2	USINT	-	0 ... 255	-
27	Scaling reactive energy inflow L2	USINT	-	0 ... 255	-
28	Scaling reactive energy outflow L2	USINT	-	0 ... 255	-
29	Scaling apparent energy L2	USINT	-	0 ... 255	-
30	Reserved	BYTE	-	-	-
31	Power factor L2	USINT	0.01	0 ... 100	66020

D.10 Energy L3 (W# 16# F6)

Energy L3 (ID 246 or F6_H)

Table D- 9 Energy L3 Process data variant

Byte	Allocation	Data type	Unit	Value range	Measured value ID
0	Process data variant indicator	BYTE	-	246 (F6 _H)	-
1	Quality information = QQ ₁ I ₃ U ₃ I ₂ U ₂ I ₁ U ₁	BYTE	Bit string	qq xx xx xx	-
2 ... 3	Current L3	UINT	1 mA	0 ... 65535	66009
4 ... 7	Active energy inflow L3	UDINT	1 Wh	0 ... 2147483647	62310
8 ... 11	Active energy L3, outflow	UDINT	1 Wh	0 ... 2147483647	62311
11 ... 15	Reactive energy inflow L3	UDINT	1 varh	0 ... 2147483647	62312
16 ... 19	Reactive energy outflow L3	UDINT	1 varh	0 ... 2147483647	62313
20 ... 23	Apparent energy L3	UDINT	1 VAh	0 ... 2147483647	62314
24	Scaling current L3	USINT	-	0 ... 255	-
25	Scaling active energy inflow L3	USINT	-	0 ... 255	-
26	Scaling active energy outflow L3	USINT	-	0 ... 255	-
27	Scaling reactive energy inflow L3	USINT	-	0 ... 255	-
28	Scaling reactive energy outflow L3	USINT	-	0 ... 255	-
29	Scaling apparent energy L3	USINT	-	0 ... 255	-
30	Reserved	BYTE	-	-	-
31	Power factor L3	USINT	0.01	0 ... 100	66021

D.11 Basic values 3-phase measurement L1, L2, L3 (W# 16# F5)

Basic values 3-phase measurement L1, L2, L3 (ID 245 or F5_H)

Table D- 10 Basic values 3-phase measurement L1, L2, L3 Process data variant

Byte	Allocation	Data type	Unit	Value range	Measured value ID
0	Process data variant indicator	BYTE	-	245 (F5 _H)	-
1	Quality information = QQ ₁ I ₃ U ₃ I ₂ U ₂ I ₁ U ₁	BYTE	Bit string	qq xx xx xx	-
2 ... 5	Total active power L1L2L3	REAL	1 W	-3.0 x 10 ⁹ ... + 3.0 x 10 ⁹	34
6 ... 9	Total active energy outflow L1L2L3	REAL	1 Wh	0.0 ... 3.4 x 10 ³⁸	211
10 ... 13	Total active energy inflow L1L2L3	REAL	1 Wh	0.0 ... 3.4 x 10 ³⁸	210
14 ... 17	Current L1	REAL	1 A	0.0 ... 100000.0	7
18 ... 21	Current L2	REAL	1 A	0.0 ... 100000.0	8
22 ... 25	Current L3	REAL	1 A	0.0 ... 100000.0	9
26 ... 27	Voltage UL1-N	UINT	0.01 V	0 ... 65535	66001
28 ... 29	Voltage UL2-N	UINT	0.01 V	0 ... 65535	66002
30 ... 31	Voltage UL3-N	UINT	0.01 V	0 ... 65535	66003

D.12 Quality values 3-phase measurement (W# 16# F0)

Quality values 3-phase measurement (ID 240 or F0_H)

Table D- 11 Quality values 3-phase measurement Process data variant

Byte	Allocation	Data type	Unit	Value range	Measured value ID
0	Process data variant indicator	BYTE	-	240 (F0H)	-
1	Quality information = QQ ₁ I ₃ U ₃ I ₂ U ₂ I ₁ U ₁	BYTE	Bit string	qq xx xx xx	-
2 ... 3	Reserved	WORD	-	-	-
4 ... 5	* Status of the energy counter overflows	WORD	Bit string	xxxx xxxx xxxx xxxx	65508
6 ... 7	Quality information = 00 DD QQ ₃ QQ ₂ QQ ₁ I ₃ U ₃ I ₂ U ₂ I ₁ U ₁	WORD	Bit string	xxxx xxxx xxxx xxxx	65503
8 ... 9	Reserved	WORD	-	-	-
10 ... 11	Reserved	WORD	-	-	-
12 ... 13	Reserved	WORD	-	-	-
14 ... 15	Reserved	WORD	-	-	-
16 ... 17	Reserved	WORD	-	-	-
18 ... 19	Reserved	WORD	-	-	-
20 ... 21	Reserved	WORD	-	-	-
22 ... 23	Reserved	WORD	-	-	-
24 ... 25	Reserved	WORD	-	-	-
26 ... 27	Reserved	WORD	-	-	-
28 ... 29	Reserved	WORD	-	-	-
30 ... 31	Reserved	WORD	-	-	-

* Energy counter count periodically - counter overflow at:

- Bit 0 = 1: Active energy inflow L1
- Bit 1 = 1: Active energy outflow L1
- Bit 2 = 1: Reactive energy inflow L1
- Bit 3 = 1: Reactive energy outflow L1
- Bit 4 = 1: Apparent energy L1
- Bit 5 = 1: Active energy inflow L2
- Bit 6 = 1: Active energy outflow L2
- Bit 7 = 1: Reactive energy inflow L2
- Bit 8 = 1: Reactive energy outflow L2
- Bit 9 = 1: Apparent energy L2
- Bit 10 = 1: Active energy inflow L3
- Bit 11 = 1: Active energy outflow L3
- Bit 12 = 1: Reactive energy inflow L3
- Bit 13 = 1: Reactive energy outflow L3
- Bit 14 = 1: Apparent energy L3
- Bit 15: Reserved

D.13 Energy measurement (periodical) overage meter (W# 16# EF)

Energy measurement (periodic) overage meter (ID 239 or EF_H)

Table D- 12 Energy measurement (periodic) overage meter Process data variant

Byte	Allocation	Data type	Unit	Value range	Measured value ID
0	Process data variant indicator	BYTE	-	239 (EFH)	-
1	Quality information = QQ ₁ I ₃ U ₃ I ₂ U ₂ I ₁ U ₁	BYTE	Bit string	qq xx xx xx	-
2 ... 3	Overflow counter for active energy inflow L1	UINT	-	0 ... 65535	65120
4 ... 5	Overflow counter for active energy outflow L1	UINT	-	0 ... 65535	65121
6 ... 7	Overflow counter for reactive energy inflow L1	UINT	-	0 ... 65535	65122
8 ... 9	Overflow counter for reactive energy outflow L1	UINT	-	0 ... 65535	65123
10 ... 11	Overflow counter for apparent energy L1	UINT	-	0 ... 65535	65124
12 ... 13	Overflow counter for active energy inflow L2	UINT	-	0 ... 65535	62220
14 ... 15	Overflow counter for active energy outflow L2	UINT	-	0 ... 65535	62221
16 ... 17	Overflow counter for reactive energy inflow L2	UINT	-	0 ... 65535	62222
18 ... 19	Overflow counter for reactive energy outflow L2	UINT	-	0 ... 65535	62223
20 ... 21	Overflow counter for apparent energy L2	UINT	-	0 ... 65535	62224
22 ... 23	Overflow counter for active energy inflow L3	UINT	-	0 ... 65535	62320
24 ... 25	Overflow counter for active energy outflow L3	UINT	-	0 ... 65535	62321
26 ... 27	Overflow counter for reactive energy inflow L3	UINT	-	0 ... 65535	62322
28 ... 29	Overflow counter for reactive energy outflow L3	UINT	-	0 ... 65535	62323
30 ... 31	Overflow counter for apparent energy L3	UINT	-	0 ... 65535	62324

D.14 EE@Industry measurement data profile E3 (W# 16# E3)

EE@Industry measurement data profile E3 (ID 227 or E3_H)

Table D- 13 EE@Industry measurement data profile E3 Process data variant

Byte	Allocation	Data type	Unit	Value range	Measured value ID
0	Process data variant indicator	BYTE	-	227 (E3 _H)	-
1	Quality information = QQ ₁ I ₃ U ₃ I ₂ U ₂ I ₁ U ₁	BYTE	Bit string	qq xx xx xx	-
2 ... 5	Active power L1	REAL	1 W	-3.0 x 10 ⁹ ... + 3.0 x 10 ⁹	13
6 ... 9	Active power L2	REAL	1 W	-3.0 x 10 ⁹ ... + 3.0 x 10 ⁹	14
10 ... 13	Active power L3	REAL	1 W	-3.0 x 10 ⁹ ... + 3.0 x 10 ⁹	15
14 ... 17	Reactive power L1	REAL	1 var	-3.0 x 10 ⁹ ... + 3.0 x 10 ⁹	16
18 ... 21	Reactive power L2	REAL	1 var	-3.0 x 10 ⁹ ... + 3.0 x 10 ⁹	17
22 ... 25	Reactive power L3	REAL	1 var	-3.0 x 10 ⁹ ... + 3.0 x 10 ⁹	18
26 ... 33	Total active energy L1L2L3 inflow	LREAL	1 Wh	0.0 ... 1.8 x 10 ³⁰⁸	210
34 ... 41	Total active energy L1L2L3 outflow	LREAL	1 Wh	0.0 ... 1.8 x 10 ³⁰⁸	211
42 ... 49	Total reactive energy L1L2L3 inflow	LREAL	1 varh	0.0 ... 1.8 x 10 ³⁰⁸	212
50 ... 57	Total reactive energy L1L2L3 outflow	LREAL	1 varh	0.0 ... 1.8 x 10 ³⁰⁸	213
58 ... 61	Voltage UL1-N	REAL	1 V	0.0 ... 1000000.0	1
62 ... 65	Voltage UL2-N	REAL	1 V	0.0 ... 1000000.0	2
66 ... 69	Voltage UL3-N	REAL	1 V	0.0 ... 1000000.0	3
70 ... 73	Voltage UL1-UL2	REAL	1 V	0.0 ... 1000000.0	4
74 ... 77	Voltage UL2-UL3	REAL	1 V	0.0 ... 1000000.0	5
78 ... 81	Voltage UL3-UL1	REAL	1 V	0.0 ... 1000000.0	6
82 ... 85	Current L1	REAL	1 A	0.0 ... 100000.0	7
86 ... 89	Current L2	REAL	1 A	0.0 ... 100000.0	8
90 ... 93	Current L3	REAL	1 A	0.0 ... 100000.0	9
94 ... 97	Power factor L1	REAL	-	0.0 ... 1.0	19
98 ... 101	Power factor L2	REAL	-	0.0 ... 1.0	20
102 ... 105	Power factor L3	REAL	-	0.0 ... 1.0	21

D.15 EE@Industry measurement data profile E2 (W# 16# E2)

EE@Industry measurement data profile E2 (ID 226 or E2_H)

You can use this structure when using the module on single-phase system L3.

Table D- 14 EE@Industry measurement data profile E2 Process data variant

Byte	Allocation	Data type	Unit	Value range	Measured value ID
0	Process data variant indicator	BYTE	-	226 (E2 _H)	-
1	Quality information = QQ ₁ I ₃ U ₃ I ₂ U ₂ I ₁ U ₁	BYTE	Bit string	qq xx xx xx	-
2 ... 5	Total active power L1L2L3	REAL	1 W	-3.0 x 10 ⁹ ... + 3.0 x 10 ⁹	34
6 ... 9	Total active energy inflow L1L2L3	REAL	1 W	3.0 x 10 ⁹	220
10 ...13	Total active energy outflow L1L2L3	REAL	1 W	3.0 x 10 ⁹	221

D.16 EE@Industry measurement data profile E1 (W# 16# E1)

EE@Industry measurement data profile E1 (ID 225 or E1_H)

You can use this structure when using the module on single-phase system L3.

Table D- 15 EE@Industry measurement data profile E1 Process data variant

Byte	Allocation	Data type	Unit	Value range	Measured value ID
0	Process data variant indicator	BYTE	-	225 (E1 _H)	-
1	Quality information = QQ ₁ I ₃ U ₃ I ₂ U ₂ I ₁ U ₁	BYTE	Bit string	qq xx xx xx	-
2 ... 5	Total active power L1L2L3	REAL	1 W	-3.0 x 10 ⁹ ... + 3.0 x 10 ⁹	34

D.17 EE@Industry measurement data profile E0 (W# 16# E0)

EE@Industry measurement data profile E0 (ID 224 or E0_H)

You can use this structure when using the module on single-phase system L3.

Table D- 16 EE@Industry measurement data profile E0 Process data variant

Byte	Allocation	Data type	Unit	Value range	Measured value ID
0	Process data variant indicator	BYTE	-	224 (E0 _H)	-
1	Quality information = QQ ₁ I ₃ U ₃ I ₂ U ₂ I ₁ U ₁	BYTE	Bit string	qq xx xx xx	-
2 ... 5	Current L1	REAL	1 A	0.0 ... 100000.0	7
6 ... 9	Current L2	REAL	1 A	0.0 ... 100000.0	8
10 ...13	Current L3	REAL	1 A	0.0 ... 100000.0	9

D.18 Basic values single phase measurement L1 (W# 16# 9F)

Basic values single phase measurement L1 (ID 159 or 9F_H)

Table D- 17 Basic values single phase measurement L1 Process data variant

Byte	Allocation	Data type	Unit	Value range	Measured value ID
0	Process data variant indicator	BYTE	-	159 (9F _H)	-
1	Quality information = QQ ₁ I ₃ U ₃ I ₂ U ₂ I ₁ U ₁	BYTE	Bit string	qq xx xx xx	-
2 ... 3	Current L1	UINT	1 mA	0 ... 65535	66007
4 ... 5	Voltage UL1-N	UINT	0.01 V	0 ... 65535	66001
6 ... 7	Active power L1	INT	1 W	-27648 ... 27648	66013
8 ... 9	Reactive power L1	INT	1 var	-27648 ... 27648	66016
10 ... 11	Apparent power L1	INT	1 VA	-27648 ... 27648	66010
12 ... 15	Active energy L1 total (inflow - outflow)	DINT	1 Wh	±2147483647	62115
16 ... 19	Reactive energy L1 total (inflow - outflow)	DINT	1 varh	±2147483647	62116
20 ... 23	Apparent energy L1	UDINT	1 VAh	0 ... 2147483647	62114
24	Scaling current L1	USINT	-	0 ... 255	-
25	Scaling active power L1	USINT	-	0 ... 255	-
26	Scaling reactive power L1	USINT	-	0 ... 255	-
27	Scaling apparent power L1	USINT	-	0 ... 255	-

D.19 Basic values single phase measurement L1a (W# 16# 9E)

Byte	Allocation	Data type	Unit	Value range	Measured value ID
28	Scaling active energy L1 total (inflow - outflow)	USINT	-	0 ... 255	-
29	Scaling reactive energy L1 total (inflow - outflow)	USINT	-	0 ... 255	-
30	Scaling apparent energy L1	USINT	-	0 ... 255	-
31	Power factor L1	USINT	0.01	0 ... 100	66019

D.19 Basic values single phase measurement L1a (W# 16# 9E)

Basic values single phase measurement L1a (ID 158 or 9E_H)

Table D- 18 Basic values single phase measurement L1a Process data variant

Byte	Allocation	Data type	Unit	Value range	Measured value ID
0	Process data variant indicator	BYTE	-	158 (9EH)	-
1	Quality information = QQ ₁ I ₃ U ₃ I ₂ U ₂ I ₁ U ₁	BYTE	Bit string	qq xx xx xx	-
2 ... 3	Current L1	UINT	1 mA	0 ... 65535	66007
4 ... 5	Voltage UL1-N	UINT	0.01 V	0 ... 65535	66001
6 ... 7	Active power L1	INT	1 W	-27648 ... 27648	66013
8 ... 9	Reactive power L1	INT	1 var	-27648 ... 27648	66016
10 ... 11	Apparent power L1	INT	1 VA	-27648 ... 27648	66010
12 ... 15	Active energy L1 total (inflow - outflow)	DINT	1 Wh	±2147483647	62115
16 ... 19	Reactive energy L1 total (inflow - outflow)	DINT	1 varh	±2147483647	62116
20 ... 23	Apparent energy L1	UDINT	1 VAh	0 ... 2147483647	62114
24	Scaling current L1	USINT	-	0 ... 255	-
25	Scaling active power L1	USINT	-	0 ... 255	-
26	Scaling reactive power L1	USINT	-	0 ... 255	-
27	Scaling apparent power L1	USINT	-	0 ... 255	-
28	Scaling active energy L1 total (inflow - outflow)	USINT	-	0 ... 255	-
29	Scaling reactive energy L1 total (inflow - outflow)	USINT	-	0 ... 255	-
30	Scaling apparent energy L1	USINT	-	0 ... 255	-
31	Scaling voltage UL1-N	USINT	-	0 ... 255	-

D.20 Basic values single phase measurement L2 (W# 16# 9D)

Basic values single phase measurement L2 (ID 157 or 9D_H)

Table D- 19 Basic values single phase measurement L2 Process data variant

Byte	Allocation	Data type	Unit	Value range	Measured value ID
0	Process data variant indicator	BYTE	-	157 (9D _H)	-
1	Quality information = QQ ₁ I ₃ U ₃ I ₂ U ₂ I ₁ U ₁	BYTE	Bit string	qq xx xx xx	-
2 ... 3	Current L2	UINT	1 mA	0 ... 65535	66008
4 ... 5	Voltage UL2-N	UINT	0.01 V	0 ... 65535	66002
6 ... 7	Active power L2	INT	1 W	-27648 ... 27648	66014
8 ... 9	Reactive power L2	INT	1 var	-27648 ... 27648	66017
10 ... 11	Apparent power L2	INT	1 VA	-27648 ... 27648	66011
12 ... 15	Active energy L2 total (inflow - outflow)	DINT	1 Wh	±2147483647	62215
16 ... 19	Reactive energy L2 total (inflow - outflow)	DINT	1 varh	±2147483647	62216
20 ... 23	Apparent energy L2	UDINT	1 VAh	0 ... 2147483647	62214
24	Scaling current L2	USINT	-	0 ... 255	-
25	Scaling active power L2	USINT	-	0 ... 255	-
26	Scaling reactive power L2	USINT	-	0 ... 255	-
27	Scaling apparent power L2	USINT	-	0 ... 255	-
28	Scaling active energy L2 total (inflow - outflow)	USINT	-	0 ... 255	-
29	Scaling reactive energy L2 total (inflow - outflow)	USINT	-	0 ... 255	-
30	Scaling apparent energy L2	USINT	-	0 ... 255	-
31	Power factor L2	USINT	0.01	0 ... 100	66020

D.21 Basic values single phase measurement L2a (W# 16# 9C)

Basic values single phase measurement L2a (ID 156 or 9C_H)

Table D- 20 Basic values single phase measurement L2a Process data variant

Byte	Allocation	Data type	Unit	Value range	Measured value ID
0	Process data variant indicator	BYTE	-	156 (9CH)	-
1	Quality information = QQ ₁ I ₃ U ₃ I ₂ U ₂ I ₁ U ₁	BYTE	Bit string	qq xx xx xx	-
2 ... 3	Current L2	UINT	1 mA	0 ... 65535	66008
4 ... 5	Voltage UL2-N	UINT	0.01 V	0 ... 65535	66002
6 ... 7	Active power L2	INT	1 W	-27648 ... 27648	66014
8 ... 9	Reactive power L2	INT	1 var	-27648 ... 27648	66017
10 ... 11	Apparent power L2	INT	1 VA	-27648 ... 27648	66011
12 ... 15	Active energy L2 total (inflow - outflow)	DINT	1 Wh	±2147483647	62215
16 ... 19	Reactive energy L2 total (inflow - outflow)	DINT	1 varh	±2147483647	62216
20 ... 23	Apparent energy L2	UDINT	1 VAh	0 ... 2147483647	62214
24	Scaling current L2	USINT	-	0 ... 255	-
25	Scaling active power L2	USINT	-	0 ... 255	-
26	Scaling reactive power L2	USINT	-	0 ... 255	-
27	Scaling apparent power L2	USINT	-	0 ... 255	-
28	Scaling active energy L2 total (inflow - outflow)	USINT	-	0 ... 255	-
29	Scaling reactive energy L2 total (inflow - outflow)	USINT	-	0 ... 255	-
30	Scaling apparent energy L2	USINT	-	0 ... 255	-
31	Scaling voltage UL2-N	USINT	-	0 ... 255	-

D.22 Basic values single phase measurement L3 (W# 16# 9B)

Basic values single phase measurement L3 (ID 155 or 9BH)

Table D- 21 Basic values single phase measurement L3 Process data variant

Byte	Allocation	Data type	Unit	Value range	Measured value ID
0	Process data variant indicator	BYTE	-	155 (9BH)	-
1	Quality information = QQ ₁ I ₃ U ₃ I ₂ U ₂ I ₁ U ₁	BYTE	Bit string	qq xx xx xx	-
2 ... 3	Current L3	UINT	1 mA	0 ... 65535	66009
4 ... 5	Voltage UL3-N	UINT	0.01 V	0 ... 65535	66003
6 ... 7	Active power L3	INT	1 W	-27648 ... 27648	66015
8 ... 9	Reactive power L3	INT	1 var	-27648 ... 27648	66018
10 ... 11	Apparent power L3	INT	1 VA	-27648 ... 27648	66012
12 ... 15	Active energy L3 total (inflow - outflow)	DINT	1 Wh	±2147483647	62315
16 ... 19	Reactive energy L3 total (inflow - outflow)	DINT	1 varh	±2147483647	62316
20 ... 23	Apparent energy L3	UDINT	1 VAh	0 ... 2147483647	62314
24	Scaling current L3	USINT	-	0 ... 255	-
25	Scaling active power L3	USINT	-	0 ... 255	-
26	Scaling reactive power L3	USINT	-	0 ... 255	-
27	Scaling apparent power L3	USINT	-	0 ... 255	-
28	Scaling active energy L3 total (inflow - outflow)	USINT	-	0 ... 255	-
29	Scaling reactive energy L3 total (inflow - outflow)	USINT	-	0 ... 255	-
30	Scaling apparent energy L3	USINT	-	0 ... 255	-
31	Power factor L3	USINT	0.01	0 ... 100	66021

D.23 Basic values single phase measurement L3a (W# 16# 9A)

Basic values single phase measurement L3a (ID 154 or 9A_H)

Table D- 22 Basic values single phase measurement L3a Process data variant

Byte	Allocation	Data type	Unit	Value range	Measured value ID
0	Process data variant indicator	BYTE	-	154 (9A _H)	-
1	Quality information = QQ ₁ I ₃ U ₃ I ₂ U ₂ I ₁ U ₁	BYTE	Bit string	qq xx xx xx	-
2 ... 3	Current L3	UINT	1 mA	0 ... 65535	66009
4 ... 5	Voltage UL3-N	UINT	0.01 V	0 ... 65535	66003
6 ... 7	Active power L3	INT	1 W	-27648 ... 27648	66015
8 ... 9	Reactive power L3	INT	1 var	-27648 ... 27648	66018
10 ... 11	Apparent power L3	INT	1 VA	-27648 ... 27648	66012
12 ... 15	Active energy L3 total (inflow - outflow)	DINT	1 Wh	±2147483647	62315
16 ... 19	Reactive energy L3 total (inflow - outflow)	DINT	1 varh	±2147483647	62316
20 ... 23	Apparent energy L3	UDINT	1 VAh	0 ... 2147483647	62314
24	Scaling current L3	USINT	-	0 ... 255	-
25	Scaling active power L3	USINT	-	0 ... 255	-
26	Scaling reactive power L3	USINT	-	0 ... 255	-
27	Scaling apparent power L3	USINT	-	0 ... 255	-
28	Scaling active energy L3 total (inflow - outflow)	USINT	-	0 ... 255	-
29	Scaling reactive energy L3 total (inflow - outflow)	USINT	-	0 ... 255	-
30	Scaling apparent energy L3	USINT	-	0 ... 255	-
31	Scaling voltage UL3-N	USINT	-	0 ... 255	-

Measured value data records

E.1 Overview of all measured data records

The SM 1238 Energy Meter 480VAC module writes the measured values in several data records that your program can read asynchronously, using the RDREC instruction. Refer to the TIA Portal online Help for details about the RDREC program instruction.

The following tables show the structure of the individual data records.

- DS 142: Base measurements data record - read only (Page 149)
- DS 143: Energy counters data record - read and write (Page 151)
- DS 144: Maximum values data record - read only (Page 156)
- DS 145: Minimum values data record - read only (Page 157)
- DS 147: L1 phase-based values data record - read only (Page 158)
- DS 148: L2 phase-based values data record - read only (Page 159)
- DS 149: L3 phase-based values data record - read only (Page 160)
- DS 150: Advanced measurements and status values - read only (Page 162)

E.2 Base measurements data record (DS 142)

Base measurement values

The following table provides an overview of all the measured variables that data record 142 supplies. Please note that, depending on the connection type that you use, some of the measured variables are not relevant and are deleted by the module.

A table of measured variable properties with rows ordered by the measured value identifier (Value ID) is provided in appendix B Measured variables for connection type (Page 102).

Table E- 1 Data record 142

Byte	Measured variable	Data type	Unit	Value range	Value ID
0	Version	BYTE	-	2	-
1	Reserved	BYTE	-	0	-
2 ... 5	Voltage UL1-N	REAL	V	0.0 ... 1000000.0	1
6 ... 9	Voltage UL2-N	REAL	V	0.0 ... 1000000.0	2
10 ... 13	Voltage UL3-N	REAL	V	0.0 ... 1000000.0	3
14 ... 17	Voltage UL1-L2	REAL	V	0.0 ... 1000000.0	4
18 ... 21	Voltage UL2-L3	REAL	V	0.0 ... 1000000.0	5
22 ... 25	Voltage UL3-L1	REAL	V	0.0 ... 1000000.0	6
26 ... 29	Current L1	REAL	A	0.0 ... 100000.0	7
30 ... 33	Current L2	REAL	A	0.0 ... 100000.0	8
34 ... 37	Current L3	REAL	A	0.0 ... 100000.0	9
38 ... 41	Power factor L1	REAL	-	0.0 ... 1.0	19
42 ... 45	Power factor L2	REAL	-	0.0 ... 1.0	20
46 ... 49	Power factor L3	REAL	-	0.0 ... 1.0	21
50 ... 53	Total power factor L1L2L3	REAL	-	0.0 ... 1.0	37
54 ... 57	Frequency	REAL	1 Hz	45.0 ... 65.0	30
58 ... 61	Amplitude unbalance for voltage	REAL	%	0 ... 100	38
62 ... 65	Amplitude unbalance for current	REAL	%	0 ... 200	39
66 ... 69	Apparent power L1	REAL	VA	-3.0 x 10 ⁹ ... +3.0 x 10 ⁹	10
70 ... 73	Apparent power L2	REAL	VA	-3.0 x 10 ⁹ ... +3.0 x 10 ⁹	11
74 ... 77	Apparent power L3	REAL	VA	-3.0 x 10 ⁹ ... +3.0 x 10 ⁹	12
78 ... 81	Total apparent power L1L2L3	REAL	VA	-3.0 x 10 ⁹ ... +3.0 x 10 ⁹	36
82 ... 85	Reactive power L1	REAL	var	-3.0 x 10 ⁹ ... +3.0 x 10 ⁹	16
86 ... 89	Reactive power L2	REAL	var	-3.0 x 10 ⁹ ... +3.0 x 10 ⁹	17
90 ... 93	Reactive power L3	REAL	var	-3.0 x 10 ⁹ ... +3.0 x 10 ⁹	18
94 ... 97	Total reactive power L1L2L3	REAL	var	-3.0 x 10 ⁹ ... +3.0 x 10 ⁹	35
98 ... 101	Active power L1	REAL	W	-3.0 x 10 ⁹ ... +3.0 x 10 ⁹	13
102 ... 105	Active power L2	REAL	W	-3.0 x 10 ⁹ ... +3.0 x 10 ⁹	14
106 ... 109	Active power L3	REAL	W	-3.0 x 10 ⁹ ... +3.0 x 10 ⁹	15
110 ... 113	Total active power L1L2L3	REAL	W	-3.0 x 10 ⁹ ... +3.0 x 10 ⁹	34

Byte	Measured variable	Data type	Unit	Value range	Value ID
114 ... 117	Phase angle L1	REAL	°	0.0 ... 360.0	61178
118 ... 121	Phase angle L2	REAL	°	0.0 ... 360.0	61198
122 ... 125	Phase angle L3	REAL	°	0.0 ... 360.0	61218
126 ... 129	Total apparent energy L1L2L3	REAL	VAh	0.0 ... 3.4×10^{38}	204
130 ... 133	Total reactive energy L1L2L3	REAL	varh	$\pm 3.4 \times 10^{38}$	206
134 ... 137	Total active energy L1L2L3	REAL	Wh	$\pm 3.4 \times 10^{38}$	205
138 ... 141	Total reactive energy inflow L1L2L3	REAL	varh	0.0 ... 3.4×10^{38}	202
142 ... 145	Total reactive energy outflow L1L2L3	REAL	varh	0.0 ... 3.4×10^{38}	203
146 ... 149	Total active energy inflow L1L2L3	REAL	Wh	0.0 ... 3.4×10^{38}	200
150 ... 153	Total active energy outflow L1L2L3	REAL	Wh	0.0 ... 3.4×10^{38}	201
154 ... 161	Total apparent energy L1L2L3	LREAL	VAh	0.0 ... 1.8×10^{308}	214
162 ... 169	Total reactive energy L1L2L3	LREAL	varh	$\pm 1.8 \times 10^{308}$	216
170 ... 177	Total active energy L1L2L3	LREAL	Wh	$\pm 1.8 \times 10^{308}$	215
178 ... 185	Total reactive energy inflow L1L2L3	LREAL	varh	0.0 ... 1.8×10^{308}	212
186 ... 193	Total reactive energy outflow L1L2L3	LREAL	varh	0.0 ... 1.8×10^{308}	213
194 ... 201	Total active energy inflow L1L2L3	LREAL	Wh	0.0 ... 1.8×10^{308}	210
202 ... 209	Total active energy outflow L1L2L3	LREAL	Wh	0.0 ... 1.8×10^{308}	211
210 ... 213	Neutral conductor current	REAL	A	0.0 ... 100000.0	61149

Note

- The cumulative value in 3-phase operation is obtained from the sums of the individual values of the phases.
- Inflow and outflow energy meters are always positive values.
- The diagnostics information "Overflow cumulative values" is not triggered in connection with the maximum values of the energy meters.

Neutral conductor current

If you operate the SM 1238 Energy Meter 480VAC with connection type 3P4W, the neutral conductor current is also determined under the following conditions:

- Transfer factors of all phase currents (primary and secondary currents) are identical.
- Measured phase currents are greater than the value of the "Low limit electrical current measurement" parameter.

The neutral is subject to a "Low limit electrical current measurement" like all other electrical current measurements. The lowest value of all three configured low limits is used as the minimum value.

If one of the conditions is not met, 0 is entered as the value for the neutral conductor current. You can read the neutral conductor current using measured value data record 142.

Reading the record

Data record 142 is located in the SM 1238 Energy Meter 480VAC module. Use the "RDREC" program instruction to read a data record from the module.

E.3 Energy counters data record (DS 143)

Energy meter data record 143 user actions

The energy meter data record 143 includes all energy counter values available on the module phase-by-phase. The data record can be used for different actions:

- Reset the energy counter to user-specific value (e.g. "0")
- Read the values of the energy counters
- Read the overflow counters
- Read the operating hours

Energy meter data record 143

Table E- 2 Energy meter data record 143

Byte	Measured variable	Format	Unit	Value range	Value ID
0	Version	Unsigned 8	Byte	1	
1	Reserved	Unsigned 8	Byte	0	
2	Control byte 1 - L1	Unsigned 8	8 bit	-	
3	Control byte 2 - L1	Unsigned 8	8 bit		
4	Control byte 1 - L2	Unsigned 8	8 bit		
5	Control byte 2 - L2	Unsigned 8	8 bit		
6	Control byte 1 - L3	Unsigned 8	8 bit		
7	Control byte 2 - L3	Unsigned 8	8 bit		
8 ... 15	Active energy inflow (initial value) L1	LREAL	Wh		
16 ... 23	Active energy outflow (initial value) L1	LREAL	Wh	Overflow 1.8e+308	61181
24 ... 31	Reactive energy inflow (initial value) L1	LREAL	vahr	Overflow 1.8e+308	61182
32 ... 39	Reactive energy outflow (initial value) L1	LREAL	varh	Overflow 1.8e+308	61183
40 ... 47	Apparent energy (initial value) L1	LREAL	VAh	Overflow 1.8e+308	61184
48 ... 55	Active energy inflow (initial value) L2	LREAL	Wh	Overflow 1.8e+308	61200
56 ... 63	Active energy outflow (initial value) L2	LREAL	Wh	Overflow 1.8e+308	61201
64 ... 61	Reactive energy inflow (initial value) L2	LREAL	varh	Overflow 1.8e+308	61202
72 ... 79	Reactive energy outflow (initial value) L2	LREAL	varh	Overflow 1.8e+308	61203
80 ... 87	Apparent energy (initial value) L2	LREAL	VAh	Overflow 1.8e+308	61204
88 ... 95	Active energy inflow (initial value) L3	LREAL	Wh	Overflow 1.8e+308	61220
96 ... 103	Active energy outflow (initial value) L3	LREAL	Wh	Overflow 1.8e+308	61221

Measured value data records

E.3 Energy counters data record (DS 143)

Byte	Measured variable	Format	Unit	Value range	Value ID
104 ... 111	Reactive energy inflow (initial value) L3	LREAL	varh	Overflow 1.8e+308	61222
112 ... 119	Reactive energy outflow (initial value) L3	LREAL	varh	Overflow 1.8e+308	61223
120 ... 127	Apparent energy (initial value) L3	LREAL	VAh	Overflow 1.8e+308	61224
128 ... 129	Overflow counter active energy inflow L1	Uint16	-	0 ... 65535	61190
130 ... 131	Overflow counter active energy outflow L1	Uint16	-	0 ... 65535	61191
132 ... 133	Overflow counter reactive energy inflow L1	Uint16	-	0 ... 65535	61192
134 ... 135	Overflow counter reactive energy outflow L1	Uint16	-	0 ... 65535	61193
136 ... 137	Overflow counter apparent energy L1	Uint16	-	0 ... 65535	61194
138 ... 139	Overflow counter active energy inflow L2	Uint16	-	0 ... 65535	61210
140 ... 141	Overflow counter active energy outflow L2	Uint16	-	0 ... 65535	61211
142 ... 143	Overflow counter reactive energy inflow L2	Uint16	-	0 ... 65535	61212
144 ... 145	Overflow counter reactive energy outflow L2	Uint16	-	0 ... 65535	61213
146 ... 147	Overflow counter apparent energy L2	Uint16	-	0 ... 65535	61214
148 ... 149	Overflow counter active energy inflow L3	Uint16	-	0 ... 65535	61230
150 ... 151	Overflow counter active energy outflow L3	Uint16	-	0 ... 65535	61231
152 ... 153	Overflow counter reactive energy inflow L3	Uint16	-	0 ... 65535	61232
154 ... 155	Overflow counter reactive energy outflow L3	Uint16	-	0 ... 65535	61233
156 ... 157	Overflow counter apparent energy L3	Uint16	-	0 ... 65535	61234
158 ... 161	Operating hours counter L1 (initial value)	REAL	h	0.0 ... 1.0e+9	65505
162 ... 165	Operating hours counter L2 (initial value)	REAL	h	0.0 ... 1.0e+9	65506
166 ... 169	Operating hours counter L3 (initial value)	REAL	h	0.0 ... 1.0e+9	65507

Status information

When data record 143 is read by the RDREC instruction, bytes 2 ... 7 supply phase-specific status information for energy counters, overflow counters and operating hours counters.

The status information enables you to see which counters are returning their values in data record 143. If energy counters return their values in the status byte 1, you can determine the type of energy counter with status byte 2.

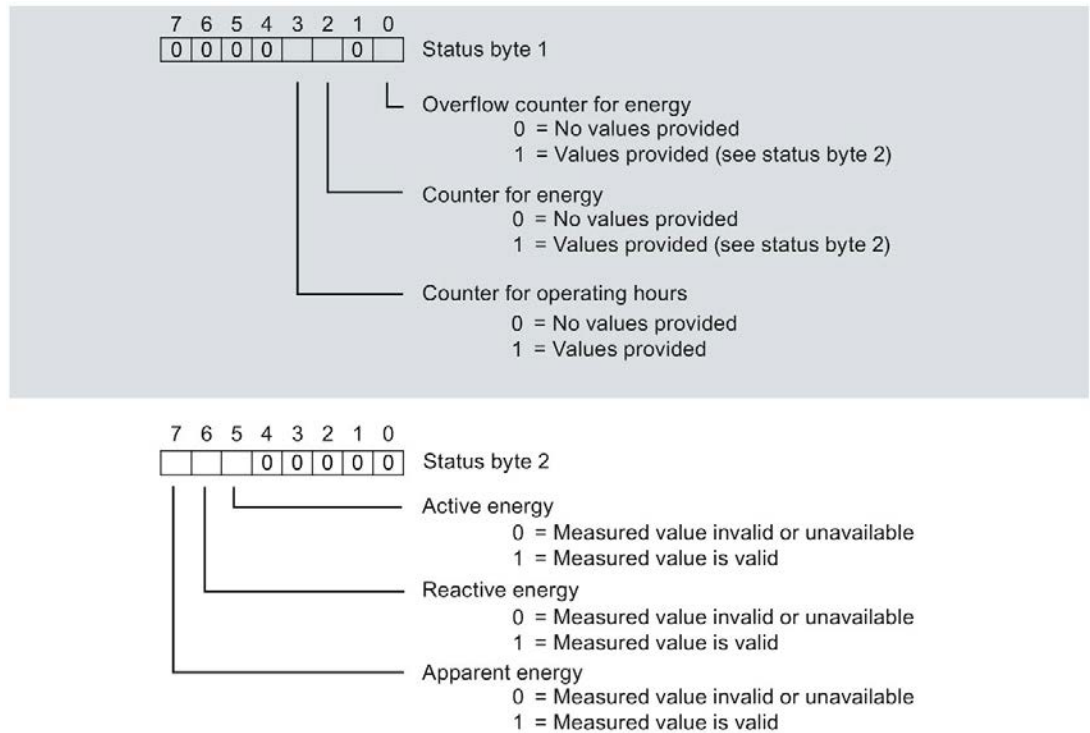

Figure E-1 Status information DS 143 (read access)

Control information

When data record 143 is written by the WRREC instruction, bytes 2 ... 7 are used as phase-specific control information for energy counters, overflow counters and operating hours counter. The length of the control information is 2 bytes for each phase:

- In control byte 1, you determine which counter you want to reset and the time at which counters are reset.
- In Control byte 2, you determine which energy counters and which overflow counters you want to reset.

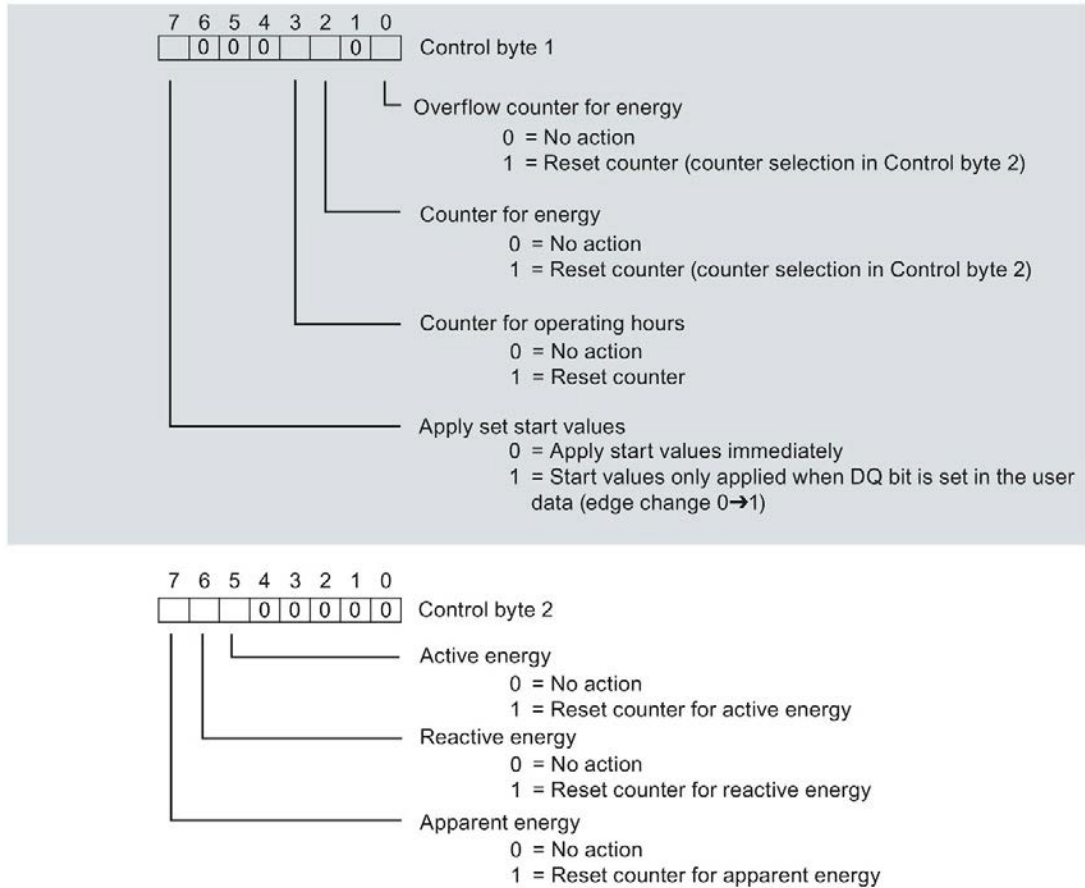

Figure E-2 Control information DS 143 (write access)

Error while transferring the data record

The module always checks all the values of the transferred data record. Only if all the values were transferred without errors does the module apply the values from the data record.

The WRREC instruction writes data records and returns corresponding error codes when errors occur in the STATUS parameter.

The following table shows the module-specific error codes and their meaning for the measured value data record 143:

Error code in STATUS parameter (hexadecimal)				Meaning	Solution
Byte 0	Byte 1	Byte 2	Byte 3		
DF	80	B0	00	Number of the data record unknown	Enter a valid number for the data record.
DF	80	B1	00	Length of the data record incorrect	Enter a valid value for the data record length.
DF	80	B2	00	Slot invalid or cannot be accessed	Check the station whether the module is plugged. Check the assigned parameter values for the WRREC instruction.
DF	80	E1	01	Reserved bits are not 0.	Check Byte 2 ... 7 and set the reserved bits to 0.
DF	80	E1	39	Incorrect version entered	Check Byte 0. Enter a valid version
DF	80	E1	3A	Incorrect data record length entered	Check the parameters of the WRREC instruction. Enter a valid length.
DF	80	E1	3C	At least one start value is invalid.	Check Bytes 8 ... 103 and Bytes 158 ... 169. The start values may not be negative.
DF	80	E1	3D	At least one start value is too large.	Check Bytes 8 ... 103 and Bytes 158 ... 169. Observe the ranges of values for start values.

E.4 Maximum values data record (DS 144)

Maximum values

The largest values measured or calculated from the time SM 1238 Energy Meter 480VAC was started are stored in this data record.

Byte	Measured variable	Format	Unit	Default	Value ID	Connection type				
						1P2W	3x1P2W	2P3W	3P4W	3P4W1
0	Version	BYTE	-	0	-	✓	✓	✓	✓	✓
1	Reserved	BYTE	-	0	-	✓	✓	✓	✓	✓
2 ... 5	Max. voltage UL1-N	REAL	V	0	40	✓	✓	✓	✓	✓
6 ... 9	Max. voltage UL2-N	REAL	V	0	41		✓	✓	✓	✓
10 ... 13	Max. voltage UL3-N	REAL	V	0	42		✓		✓	✓
14 ... 17	Max. voltage UL1-L2	REAL	V	0	43				✓	✓
18 ... 21	Max. voltage UL2-L3	REAL	V	0	44				✓	✓
22 ... 25	Max. voltage UL3-L1	REAL	V	0	45				✓	✓
26 ... 29	Max. current L1 ¹	REAL	A	0	46	✓	✓	✓	✓	✓
30 ... 33	Max. current L2 ¹	REAL	A	0.	47		✓	✓	✓	✓
34 ... 37	Max. current L3 ¹	REAL	A	0	48		✓		✓	✓
38 ... 41	Max. apparent power L1	REAL	VA	0	49	✓	✓	✓	✓	✓
42 ... 45	Max. apparent power L2	REAL	VA	0	50		✓	✓	✓	✓
46 ... 49	Max. apparent power L3	REAL	VA	0	51		✓		✓	✓
50 ... 53	Max. active power L1	REAL	W	-3.0 x 10 ⁹	52	✓	✓	✓	✓	✓
54 ... 57	Max. active power L2	REAL	W	-3.0 x 10 ⁹	53		✓	✓	✓	✓
58 ... 61	Max. active power L3	REAL	W	-3.0 x 10 ⁹	54		✓		✓	✓
62 ... 65	Max. reactive power L1	REAL	var	-3.0 x 10 ⁹	55	✓	✓	✓	✓	✓
66 ... 69	Max. reactive power L2	REAL	var	-3.0 x 10 ⁹	56		✓	✓	✓	✓
70 ... 73	Max. reactive power L3	REAL	var	-3.0 x 10 ⁹	57		✓		✓	✓
74 ... 77	Max. power factor L1	REAL	-	0	58	✓	✓	✓	✓	✓
78 ... 81	Max. power factor L2	REAL	-	0	59		✓	✓	✓	✓
82 ... 85	Max. power factor L3	REAL	-	0	60		✓		✓	✓
86 ... 89	Max. frequency	REAL	Hz	45	61	✓	✓	✓	✓	✓
90 ... 93	Max. total apparent power	REAL	VA	0	67	✓	✓	✓	✓	✓
94 ... 97	Max. total active power	REAL	W	-3.0 x 10 ⁹	65	✓	✓	✓	✓	✓
98 ... 101	Max. total reactive power	REAL	var	-3.0 x 10 ⁹	66	✓	✓	✓	✓	✓
102 ... 105	Max. total power factor	REAL	-	0	68	✓	✓	✓	✓	✓

¹ The absolute value of the electrical measured current

E.5 Minimum values data record (DS 145)

Minimum values

The smallest values measured or calculated from the time SM 1238 Energy Meter 480VAC was started are stored in this data record.

Byte	Measured variable	Format	Unit	Default	Value ID	Connection type				
						1P2W	3x1P2W	2P3W	3P4W	3P4W1
0	Version	BYTE	-	0	-	✓	✓	✓	✓	✓
1	Reserved	BYTE	-	0	-	✓	✓	✓	✓	✓
2 ... 5	Min. voltage UL1-N	REAL	V	1000000	70	✓	✓	✓	✓	✓
6 ... 9	Min. voltage UL2-N	REAL	V	1000000	71		✓	✓	✓	✓
10 ... 13	Min. voltage UL3-N	REAL	V	1000000	72		✓		✓	✓
14 ... 17	Min. voltage UL1-L2	REAL	V	1800000	73				✓	✓
18 ... 21	Min. voltage UL2-L3	REAL	V	1800000	74				✓	✓
22 ... 25	Min. voltage UL3-L1	REAL	V	1800000	75				✓	✓
26 ... 29	Min. current L1 ¹	REAL	A	100000	76	✓	✓	✓	✓	✓
30 ... 33	Min. current L2 ¹	REAL	A	100000	77		✓	✓	✓	✓
34 ... 37	Min. current L3 ¹	REAL	A	100000	78		✓		✓	✓
38 ... 41	Min. apparent power L1	REAL	VA	+3.0 x 10 ⁹	79	✓	✓	✓	✓	✓
42 ... 45	Min. apparent power L2	REAL	VA	+3.0 x 10 ⁹	80		✓	✓	✓	✓
46 ... 49	Min. apparent power L3	REAL	VA	+3.0 x 10 ⁹	81		✓		✓	✓
50 ... 53	Min. active power L1	REAL	W	+3.0 x 10 ⁹	82	✓	✓	✓	✓	✓
54 ... 57	Min. active power L2	REAL	W	+3.0 x 10 ⁹	83		✓	✓	✓	✓
58 ... 61	Min. active power L3	REAL	W	+3.0 x 10 ⁹	84		✓		✓	✓
62 ... 65	Min. reactive power L1	REAL	var	+3.0 x 10 ⁹	85	✓	✓	✓	✓	✓
66 ... 69	Min. reactive power L2	REAL	var	+3.0 x 10 ⁹	86		✓	✓	✓	✓
70 ... 73	Min. reactive power L3	REAL	var	+3.0 x 10 ⁹	87		✓		✓	✓
74 ... 77	Min. power factor L1	REAL	-	1	88	✓	✓	✓	✓	✓
78...81	Min. power factor L2	REAL	-	1	89		✓	✓	✓	✓
82 ... 85	Min. power factor L3	REAL	-	1	90		✓		✓	✓
86 ... 89	Min. frequency	REAL	Hz	65	91	✓	✓	✓	✓	✓
90 ... 93	Min. total apparent power	REAL	VA	+3.0 x 10 ⁹	97	✓	✓	✓	✓	✓
94 ... 97	Min. total active power	REAL	W	+3.0 x 10 ⁹	95	✓	✓	✓	✓	✓
98 ... 101	Min. total reactive power	REAL	var	+3.0 x 10 ⁹	96	✓	✓	✓	✓	✓
102 ... 105	Min. total power factor	REAL	-	1	98	✓	✓	✓	✓	✓

¹ The absolute value of the electrical measured current

E.6 L1 phase-based values data record (DS 147)

L1 phase measured variables (DS 147)

Byte	Measured variable	Format	Unit	Value range	Value ID	Connection type				
						1P2W	3x1P2W	2P3W	3P4W	3P4W1
0	Version	BYTE	-	0	-	✓	✓	✓	✓	✓
1	Reserved	BYTE	-	0	-	✓	✓	✓	✓	✓
2 ... 3	Qualifier L1	WORD	Bit field	0b 00 00 00 00 0b qq 00 00 xx	65500	✓	✓	✓	✓	✓
4 ... 7	Voltage UL1-N	REAL	V	0.0 ... 1000000.0	1	✓	✓	✓	✓	✓
8 ... 11	Current L1	REAL	A	0.0 ... 100000.0	7	✓	✓	✓	✓	✓
12 ... 15	Apparent power L1	REAL	VA	-3.0 x 10 ⁹ ... +3.0 x 10 ⁹	10	✓	✓	✓	✓	✓
16 ... 19	Active power L1	REAL	W	-3.0 x 10 ⁹ ... +3.0 x 10 ⁹	13	✓	✓	✓	✓	✓
20 ... 23	Reactive power L1	REAL	var	-3.0 x 10 ⁹ ... +3.0 x 10 ⁹	16	✓	✓	✓	✓	✓
24 ... 27	Power factor L1	REAL	-	0.0 ... 1.0	19	✓	✓	✓	✓	✓
28 ... 31	Phase angle L1	REAL	°	0.0 ... 360.0	61178	✓	✓	✓	✓	✓
32 ... 39	Apparent energy L1	LREAL	VAh	0.0 ... 1.8 x 10 ³⁰⁸	61184	✓	✓	✓	✓	✓
40 ... 47	Active energy (total) L1	LREAL	Wh	±1.8 x 10 ³⁰⁸	61185	✓	✓	✓	✓	✓
48 ... 55	Reactive energy (total) L1	LREAL	varh	±1.8 x 10 ³⁰⁸	61186	✓	✓	✓	✓	✓
56 ... 59	Max. voltage UL1-N	REAL	V	0.0 ... 1000000.0	40	✓	✓	✓	✓	✓
60 ... 63	Max. current L1	REAL	A	0.0 ... 100000.0	46	✓	✓	✓	✓	✓
64 ... 67	Max. apparent power L1	REAL	VA	-3.0 x 10 ⁹ ... +3.0 x 10 ⁹	49	✓	✓	✓	✓	✓
68 ... 71	Max. active power L1	REAL	W	-3.0 x 10 ⁹ ... +3.0 x 10 ⁹	52	✓	✓	✓	✓	✓
72 ... 75	Max. reactive power L1	REAL	var	-3.0 x 10 ⁹ ... +3.0 x 10 ⁹	55	✓	✓	✓	✓	✓
76 ... 79	Max. power factor L1	REAL	-	0.0 ... 1.0	58	✓	✓	✓	✓	✓
80 ... 83	Min. voltage UL1-N	REAL	V	0.0 ... 1000000.0	70	✓	✓	✓	✓	✓
84 ... 87	Min. current L1	REAL	A	0.0 ... 100000.0	76	✓				
88 ... 91	Min. apparent power L1	REAL	VA	-3.0 x 10 ⁹ ... +3.0 x 10 ⁹	79	✓	✓	✓	✓	✓
92 ... 95	Min. active power L1	REAL	W	-3.0 x 10 ⁹ ... +3.0 x 10 ⁹	83	✓	✓	✓	✓	✓

Byte	Measured variable	Format	Unit	Value range	Value ID	Connection type				
						1P2W	3x1P2W	2P3W	3P4W	3P4W1
96 ... 99	Min. reactive power L1	REAL	var	$-3.0 \times 10^9 \dots +3.0 \times 10^9$	85	✓	✓	✓	✓	✓
100 ... 103	Min. power factor L1	REAL	-	0.0 ... 1.0	88	✓	✓	✓	✓	✓

E.7 L2 phase-based values data record (DS 148)

L2 phase measured variables (DS 148)

Byte	Measured variable	Format	Unit	Value range	Value ID	Connection type				
						1P2W	3x1P2W	2P3W	3P4W	3P4W1
0	Version	BYTE	-	0	-	✓	✓	✓	✓	✓
1	Reserved	BYTE	-	0	-	✓	✓	✓	✓	✓
2 ... 3	Qualifier L2	WORD	Bit field	0b 00 00 00 00 0b qq 00 00 xx	65501		✓	✓	✓	✓
4 ... 7	Voltage UL1-N	REAL	V	0.0 ... 1000000.0	2		✓	✓	✓	✓
8 ... 11	Current L2	REAL	A	0.0 ... 100000.0	8		✓	✓	✓	✓
12 ... 15	Apparent power L2	REAL	VA	$-3.0 \times 10^9 \dots +3.0 \times 10^9$	11		✓	✓	✓	✓
16 ... 19	Active power L2	REAL	W	$-3.0 \times 10^9 \dots +3.0 \times 10^9$	14		✓	✓	✓	✓
20 ... 23	Reactive power L2	REAL	var	$-3.0 \times 10^9 \dots +3.0 \times 10^9$	17		✓	✓	✓	✓
24 ... 27	Power factor L2	REAL	-	0.0 ... 1.0	20		✓	✓	✓	✓
28 ... 31	Phase angle L2	REAL	°	0.0 ... 360.0	61198		✓	✓	✓	✓
32 ... 39	Apparent energy L2	LREAL	VAh	0.0 ... 1.8×10^{308}	61204		✓	✓	✓	✓
40 ... 47	Active energy (total) L2	LREAL	Wh	$\pm 1.8 \times 10^{308}$	61205		✓	✓	✓	✓
48 ... 55	Reactive energy (total) L2	LREAL	varh	$\pm 1.8 \times 10^{308}$	61206		✓	✓	✓	✓
56 ... 59	Max. voltage UL1-N	REAL	V	0.0 ... 1000000.0	41		✓	✓	✓	✓
60 ... 63	Max. current L2	REAL	A	0.0 ... 100000.0	47		✓	✓	✓	✓
64 ... 67	Max. apparent power L2	REAL	VA	$-3.0 \times 10^9 \dots +3.0 \times 10^9$	50		✓	✓	✓	✓
68 ... 71	Max. active power L2	REAL	W	$-3.0 \times 10^9 \dots +3.0 \times 10^9$	53		✓	✓	✓	✓

E.8 L3 phase-based values data record (DS 149)

Byte	Measured variable	Format	Unit	Value range	Value ID	Connection type				
						1P2W	3x1P2W	2P3W	3P4W	3P4W1
72 ... 75	Max. reactive power L2	REAL	var	$-3.0 \times 10^9 \dots +3.0 \times 10^9$	56		✓	✓	✓	✓
76 ... 79	Max. power factor L2	REAL	-	0.0 ... 1.0	59		✓	✓	✓	✓
80 ... 83	Min. voltage UL1-N	REAL	V	0.0 ... 1000000.0	71		✓	✓	✓	✓
84 ... 87	Min. current L2	REAL	A	0.0 ... 100000.0	77					
88 ... 91	Min. apparent power L2	REAL	VA	$-3.0 \times 10^9 \dots +3.0 \times 10^9$	80		✓	✓	✓	✓
92 ... 95	Min. active power L2	REAL	W	$-3.0 \times 10^9 \dots +3.0 \times 10^9$	84		✓	✓	✓	✓
96 ... 99	Min. reactive power L2	REAL	var	$-3.0 \times 10^9 \dots +3.0 \times 10^9$	86		✓	✓	✓	✓
100 ... 103	Min. power factor L2	REAL	-	0.0 ... 1.0	89		✓	✓	✓	✓

E.8 L3 phase-based values data record (DS 149)

L3 phase measured variables (DS 149)

Byte	Measured variable	Format	Unit	Value range	Value ID	Connection type				
						1P2W	3x1P2W	2P3W	3P4W	3P4W1
0	Version	BYTE	-	0	-	✓	✓	✓	✓	✓
1	Reserved	BYTE	-	0	-	✓	✓	✓	✓	✓
2 ... 3	Qualifier L3	WORD	Bit field	0b 00 00 00 00 0b qq 00 00 xx	65502		✓		✓	✓
4 ... 7	Voltage UL1-N	REAL	V	0.0 ... 1000000.0	3		✓		✓	✓
8 ... 11	Current L3	REAL	A	0.0 ... 100000.0	9		✓		✓	✓
12 ... 15	Apparent power L3	REAL	VA	$-3.0 \times 10^9 \dots +3.0 \times 10^9$	12		✓		✓	✓
16 ... 19	Active power L3	REAL	W	$-3.0 \times 10^9 \dots +3.0 \times 10^9$	15		✓		✓	✓
20 ... 23	Reactive power L3	REAL	var	$-3.0 \times 10^9 \dots +3.0 \times 10^9$	18		✓		✓	✓
24 ... 27	Power factor L3	REAL	-	0.0 ... 1.0	21		✓		✓	✓
28 ... 31	Phase angle L3	REAL	°	0.0 ... 360.0	61218		✓		✓	✓
32 ... 39	Apparent energy L3	LREAL	VAh	0.0 ... 1.8 x 10 ³⁰⁸	61224		✓		✓	✓

E.8 L3 phase-based values data record (DS 149)

Byte	Measured variable	Format	Unit	Value range	Value ID	Connection type				
						1P2W	3x1P2W	2P3W	3P4W	3P4W1
40 ... 47	Active energy (total) L3	LREAL	Wh	$\pm 1.8 \times 10^{308}$	61225		✓		✓	✓
48 ... 55	Reactive energy (total) L3	LREAL	varh	$\pm 1.8 \times 10^{308}$	61226		✓		✓	✓
56 ... 59	Max. voltage UL1-N	REAL	V	0.0 ... 1000000.0	42		✓		✓	✓
60 ... 63	Max. current L3	REAL	A	0.0 ... 100000.0	48		✓		✓	✓
64 ... 67	Max. apparent power L3	REAL	VA	$-3.0 \times 10^9 \dots$ $+3.0 \times 10^9$	51		✓		✓	✓
68 ... 71	Max. active power L3	REAL	W	$-3.0 \times 10^9 \dots$ $+3.0 \times 10^9$	54		✓		✓	✓
72 ... 75	Max. reactive power L3	REAL	var	$-3.0 \times 10^9 \dots$ $+3.0 \times 10^9$	57		✓		✓	✓
76 ... 79	Max. power factor L3	REAL	-	0.0 ... 1.0	60		✓		✓	✓
80 ... 83	Min. voltage UL1-N	REAL	V	0.0 ... 1000000.0	72		✓		✓	✓
84 ... 87	Min. current L3	REAL	A	0.0 ... 100000.0	78					
88 ... 91	Min. apparent power L3	REAL	VA	$-3.0 \times 10^9 \dots$ $+3.0 \times 10^9$	81		✓		✓	✓
92 ... 95	Min. active power L3	REAL	W	$-3.0 \times 10^9 \dots$ $+3.0 \times 10^9$	85		✓		✓	✓
96 ... 99	Min. reactive power L3	REAL	var	$-3.0 \times 10^9 \dots$ $\dots +3.0 \times 10^9$	87		✓		✓	✓
100 ... 103	Min. power factor L3	REAL	-	0.0 ... 1.0	90		✓		✓	✓

E.9 Advanced measurements and status values (DS 150)

Advanced measurement and status variables (DS 150)

Byte	Measured variable	Format	Unit	Value range	Value ID
0	Version	BYTE	-	0	-
1	Reserved	BYTE	-	0	-
2 ... 5	Operating hours counter L1L2L3 ¹	REAL	h	0.0 ... 3.4 x 10 ³⁸	65504
6 ... 9	Operating hours counter L1	REAL	h	0.0 ... 3.4 x 10 ³⁸	65505
10 ... 13	Operating hours counter L2	REAL	h	0.0 ... 3.4 x 10 ³⁸	65506
14 ... 17	Operating hours counter L3	REAL	h	0.0 ... 3.4 x 10 ³⁸	65507
18 ... 19	Reserved	WORD	Bit string	-	-
20 ... 21	Status of energy counter overflows ²	WORD	Bit string	xxxx xxxx xxxx xxxx	65508
22 ... 25	Reserved	UDINT	-	-	-
26 ... 29	Reserved	UDINT	-	-	-
30 ... 33	Reserved	UDINT	-	-	-
34 ... 37	Reserved	UDINT	-	-	-
38 ... 41	Reserved	UDINT	-	-	-
42 ... 45	Reserved	UDINT	-	-	-
46 ... 49	Reserved	UDINT	-	-	-
50 ... 53	Reserved	UDINT	-	-	-
54 ... 57	Reserved	UDINT	-	-	-
58 ... 61	Reserved	UDINT	-	-	-
62 ... 65	Reserved	UDINT	-	-	-
66 ... 69	Reserved	UDINT	-	-	-
70 ... 73	Reserved	UDINT	-	-	-
74 ... 77	Reserved	UDINT	-	-	-
78 ... 81	Reserved	UDINT	-	-	-

Byte	Measured variable	Format	Unit	Value range	Value ID
82 ... 85	Reserved	UDINT	-	-	-
86 ... 87	Qualifier L1L2L3	WORD	Bit string	xxxx xxxx xxxx xxxx	65503

¹ Corresponds to the maximum of the phase-specific operating hours counters

² Energy counters count periodically - counter overflow at:

- Bit 0 = 1: Active energy inflow L1
- Bit 1 = 1: Active energy outflow L1
- Bit 2 = 1: Reactive energy inflow L1
- Bit 3 = 1: Reactive energy outflow L1
- Bit 4 = 1: Apparent energy L1
- Bit 5 = 1: Active energy inflow L2
- Bit 6 = 1: Active energy outflow L2
- Bit 7 = 1: Reactive energy inflow L2
- Bit 8 = 1: Reactive energy outflow L2
- Bit 9 = 1: Apparent energy L2
- Bit 10 = 1: Active energy inflow L3
- Bit 11 = 1: Active energy outflow L3
- Bit 12 = 1: Reactive energy inflow L3
- Bit 13 = 1: Reactive energy outflow L3
- Bit 14 = 1: Apparent energy L3
- Bit 15: Reserved

Tips and tricks

F.1 Tips and tricks

Processing and visualizing energy data

The S7-1200 PLC analog I/O module "SM 1238 Energy Meter 480VAC" (6ES7238-5XA32-0XB0) emulates the behaviors and performance of the ET 200SP I/O module "Analog input module AI Energy Meter 480VAC" (6ES7134-6PA20-0BD0) with the exceptions shown in the following list.

Analog input module AI Energy Meter 480VAC features that are not supported by the SM 1238 Energy Meter 480VAC:

- User-defined I/O memory allocation (User-specific module version)
- Limit monitoring
- Hardware interrupts

STEP 7 (TIA Portal) programming methods for the two modules are similar, for features that are supported by both modules.

Information about the concepts of energy management and application examples are available from Siemens customer support on the Internet (<http://support.automation.siemens.com/WW/view/en/86299299>).



Embedded software license

G.1 Software license conditions

1) License Notes

The following notes and conditions shall apply for Siemens Software which was provided to you.

For Resellers: In order to avoid infringements of the license conditions by the reseller or the buyer, these notes and conditions and accompanying data carrier if applicable - have to be forwarded to the buyers.

Please note:

This software is protected under Copyright Laws. Unauthorized usage of this software or parts of it may result in claims for damages and will be prosecuted according to criminal as well as civil law.

This software may only be used by authorized users who have a valid license to use this software. Such a license can have been acquired by entering into a license agreement with a Siemens company or an authorized third party supplier. Please read the license terms and conditions contained in your license agreement carefully before installing and using this software.

The license agreement together with a receipt, invoice or other purchase documentation will serve as proof that you have a valid license to use this software. Please keep such proof of your valid license in order to be able to present it in case of doubt. Any use without such license or outside of the granted scope is explicitly prohibited. If you do not have a valid license, please stop using the software immediately and contact your Siemens Company or your local supplier in order to avoid claims for damages against you or your company.

Security information:

Siemens provides products and solutions with industrial security functions that support the secure operation of plants, solutions, machines, equipment and/or networks. They are important components in a holistic industrial security concept. With this in mind, Siemens™ products and solutions undergo continuous development. Siemens recommends strongly that you regularly check for product updates.

For the secure operation of Siemens products and solutions, it is necessary to take suitable preventive action (e.g. cell protection concept) and integrate each component into a holistic, state-of-the-art industrial security concept. Third-party products that may be in use should also be considered. For more information about industrial security, visit <http://www.siemens.com/industrialsecurity> (<http://www.siemens.com/industrialsecurity>).

To stay informed about product updates as they occur, sign up for a product-specific newsletter. For more information, visit <http://support.automation.siemens.com/> (http://support.automation.siemens.com).

2) License Conditions and Disclaimers for Open Source Software and other Licensed Software

In the product "SM 1238 Energy Meter 480VAC", Copyright Siemens AG, 2016 (hereinafter "Product"), the following Open Source Software is used either unchanged or in a form that we have modified, and additionally the other License Software noted below:

Liability for Open Source Software

Open Source Software is provided free of charge. We are liable for the Product including Open Source Software contained in accordance with the license conditions applicable to the Product. Any liability for use of Open Source Software beyond the program flow intended for the Product is explicitly excluded. Furthermore, any liability for defects resulting from modifications to the Open Source Software by you or third parties is excluded.

We do not provide any technical support for the Product if it has been modified.

Please note the following license conditions and copyright notices applicable to Open Source Software and other License Software:

Component	Open Source Software [Yes/No]	Acknowledgements	Copyright Information / File
IAR Embedded Workbench for MSP430 6.30 - subset	NO		LICENSE AND COPYRIGHT INFORMATION FOR COMPONENT IAR EMBEDDED WORKBENCH FOR MSP430 6.30 - SUBSET

LICENSE CONDITIONS AND COPYRIGHT NOTICES

Commercial Software: IAR Embedded Workbench for MSP430 6.30 - subset

Enclosed you'll find license conditions and copyright notices applicable for Commercial Software IAR Embedded Workbench for MSP430 6.30 - subset

License conditions:

DO NOT MODIFY THIS FILE

- *
- * Permission to use, copy, modify, distribute and sell this
- * software and its documentation for any purpose is hereby
- * granted without fee, provided that the above copyright notice
- * appear in all copies and that both that copyright notice and
- * this permission notice appear in supporting documentation.
- * Hewlett-Packard Company makes no representations about the
- * suitability of this software for any purpose. It is provided
- * "as is" without express or implied warranty.

Copyrights:

Copyright (C) 1996-2009 IAR Systems AB.

Copyright (C) 2003 IAR Systems. All rights reserved.

Copyright (c) 1992-2002 by P.J. Plauger. ALL RIGHTS RESERVED.

Copyright (c) 1992-2009 by P.J. Plauger. ALL RIGHTS RESERVED.

Copyright (c) 1994 Hewlett-Packard Company

Copyright 2001-2010 IAR Systems AB.

Copyright 2002-2008 IAR Systems AB.

Copyright 2003-2008 IAR Systems AB.

Copyright 2003-2010 IAR Systems AB.

Copyright 2003-2010 IAR Systems AB.

Copyright 2004-2008 IAR Systems AB.

Copyright 2004-2010 IAR Systems AB.

Copyright 2005-2010 IAR Systems AB.

Copyright 2007-2008,2014 IAR Systems AB.

Copyright 2009-2010 IAR Systems AB.

Copyright 2013-2013 IAR Systems AB.

© 1995?2011 IAR Systems AB.

© 1996??2015 IAR Systems AB.

Index

A

- AC power
 - application area, 11
 - electrical current transformer selection, 22
 - module wiring, 15
 - wiring examples, 19
- AI 3 (3 phase channels) configuration
 - Diagnostics (channel scope), 76
 - Measurement (channel scope), 78
- AI configuration
 - Diagnostics (module scope), 71
 - Measurement (module scope), 72

C

- Configuration
 - by parameter data record, 93
 - module version options, 26
 - module version recommendation, 31
 - parameter data record 128, 94
 - TIA Portal overview, 25
- Connection
 - application area, 11
 - examples, 19
 - module wiring, 15

D

- Device configuration (TIA Portal), 70
- Diagnostics
 - alarms, 84
 - response, 86
- Documentation guide, 8

E

- Electrical current transformer
 - configuration, 78
- Electrical current transformer
 - selection, 22
- Energy counter
 - configuration, 44
 - example reset by DS 143, 51
 - operation, 41

- reading values, 46
- resetting by data set (DS 143), 49
- resetting by user data, 47
- structure of control and feedback interface (DS 143), 59
- structure of counter data record (DS 143), 53

Errors

- diagnostic alarms, 84
- LED and status display, 82

F

- Features of Energy meter, 13
- Firmware updates and S7-1200 CPU version compatibility, 14

G

- Grounding system TN, TT, IT, 16

I

- I/O start address configuration, 80
- IT network, 16

L

- LED status and display, 82
- Line voltage configuration
 - diagnostics, 71
 - tolerance, 71

M

- Measured data records
 - Advanced measurements and status (DS 150), 162
 - Base measurement (DS 142), 149
 - Energy counters (DS 143), 151
 - L1 phase measured variables, 158
 - L2 phase measured variables, 159
 - L3 phase measured variables, 160
 - Maximum values (DS 144), 156
 - Minimum values (DS 145), 157
 - Overview, 148
- Measured values
 - availability for connection type, 102

- basics, 34
 - quality information, 36
 - quick start, 32
 - reading asynchronously from data record, 40
 - reading cyclical user data, 39
 - Measurement configuration, 72
 - Minimum and maximum values
 - operation, 65
 - resetting values, 66
 - Module version
 - 112 bytes I/ 12 bytes O, 117
 - 2 bytes I/ 2 bytes O, 110
 - 32 bytes I/ 12 bytes O, 113
 - memory usage, 29
 - recommendation, 31
- O**
- Operating hours counter
 - operation, 61
 - Resetting by data set DS 143, 63
 - Resetting by user data, 62
 - Operating mode configuration, 74
 - Overcurrent tolerance configuration, 76
- P**
- Parameters
 - Configuration data record 128, 94
 - module version options, 26
 - module version recommendation, 31
 - Phase-based measurements, 68
 - Process data variant
 - Active power L1, L2, L3, 129
 - Apparent power L1, L2, L3, 131
 - Basic measurement values L1, L2, L3, 132
 - Basic values 3-phase measurement L1, L2, L3, 137
 - Basic values single phase measurement L1, 142
 - Basic values single phase measurement L1a, 143
 - Basic values single phase measurement L2, 144
 - Basic values single phase measurement L2a, 145
 - Basic values single phase measurement L3, 146
 - Basic values single phase measurement L3a, 147
 - changing in RUN mode, 30
 - EE@Industry measurement data profile E0, 142
 - EE@Industry measurement data profile E1, 141
 - EE@Industry measurement data profile E2, 141
 - EE@Industry measurement data profile E3, 140
 - Energy L1, 134
 - Energy L2, 135
 - Energy L3, 136
 - Energy measurement (periodic) overage meter, 139
 - options, 126
 - Quality values 3-phase, 138
 - Reactive power L1, L2, L3, 130
 - Total energy L1, L2, L3, 133
 - Total power L1, L2, L3, 128
- R**
- RUN mode (changing Process data variant), 30
- S**
- S7-1200 firmware version support, 14
- T**
- TIA Portal
 - configuration overview, 25
 - Device configuration, 70
 - project planning, 29
 - Tips and tricks, 164
 - TN network, 16
 - TT network, 16
- U**
- User data configuration, 74
- V**
- Voltage transformer configuration, 78
- W**
- Wiring
 - application area, 11
 - electrical current transformer selection, 22
 - examples, 19
 - module wiring, 15