

SIEMENS



Condition Monitoring Systems

SIPLUS CMS1200

SM 1281 Condition Monitoring

Operating Instructions

Edition

06/2016

siemens.com

SIPLUS SM 1281

Condition Monitoring System SM 1281 Condition Monitoring



Operating Instructions

Preface	1
Documentation guide	2
Safety instructions	3
Fundamentals of vibration monitoring and diagnostics	4
System overview	5
Functions	6
Application planning	7
Mounting	8
Connection	9
Commissioning	10
Integrating functions with the SM 1281 library	11
Parameter assignment/configuring	12
Maintenance and servicing	13
Process and system messages, error handling	14
Technical data	15
Appendix	A

Legal information

Warning notice system

This manual contains notices you have to observe in order to ensure your personal safety, as well as to prevent damage to property. The notices referring to your personal safety are highlighted in the manual by a safety alert symbol, notices referring only to property damage have no safety alert symbol. These notices shown below are graded according to the degree of danger.

 DANGER
indicates that death or severe personal injury will result if proper precautions are not taken.
 WARNING
indicates that death or severe personal injury may result if proper precautions are not taken.
 CAUTION
indicates that minor personal injury can result if proper precautions are not taken.
NOTICE
indicates that property damage can result if proper precautions are not taken.

If more than one degree of danger is present, the warning notice representing the highest degree of danger will be used. A notice warning of injury to persons with a safety alert symbol may also include a warning relating to property damage.

Qualified Personnel

The product/system described in this documentation may be operated only by **personnel qualified** for the specific task in accordance with the relevant documentation, in particular its warning notices and safety instructions. Qualified personnel are those who, based on their training and experience, are capable of identifying risks and avoiding potential hazards when working with these products/systems.

Proper use of Siemens products

Note the following:

 WARNING
Siemens products may only be used for the applications described in the catalog and in the relevant technical documentation. If products and components from other manufacturers are used, these must be recommended or approved by Siemens. Proper transport, storage, installation, assembly, commissioning, operation and maintenance are required to ensure that the products operate safely and without any problems. The permissible ambient conditions must be complied with. The information in the relevant documentation must be observed.

Trademarks

All names identified by ® are registered trademarks of Siemens AG. The remaining trademarks in this publication may be trademarks whose use by third parties for their own purposes could violate the rights of the owner.

Disclaimer of Liability

We have reviewed the contents of this publication to ensure consistency with the hardware and software described. Since variance cannot be precluded entirely, we cannot guarantee full consistency. However, the information in this publication is reviewed regularly and any necessary corrections are included in subsequent editions.

Table of contents

1	Preface	9
2	Documentation guide	10
3	Safety instructions	11
3.1	Safety instructions.....	11
3.2	IT security.....	13
4	Fundamentals of vibration monitoring and diagnostics	14
4.1	Introduction to vibration monitoring.....	14
4.2	Mechanical vibration.....	14
4.2.1	Meaning and information content of vibration.....	14
4.2.2	Causes of mechanical vibration.....	15
4.3	Measuring vibration.....	16
4.3.1	Acceleration sensor.....	16
4.3.2	Choice of measuring point.....	17
4.3.3	Mounting on the object to be measured.....	18
4.3.4	Measured variable , frequencies, and energy.....	19
4.4	Method of fault detection and diagnostics.....	20
4.4.1	Overview of diagnostic methods.....	20
4.4.2	Types of defect and diagnostics.....	21
4.5	Vibration diagnostics by characteristic value formation in the time range.....	22
4.5.1	Overview.....	22
4.5.2	Standards and guidelines.....	23
4.5.3	Monitoring measured variable trends.....	24
4.5.4	Evaluation of the machine condition via the vibration severity (RMS).....	25
4.5.4.1	Description of the diagnostic method (RMS).....	25
4.5.4.2	Application example machine analysis: Unbalance (RMS).....	26
4.6	Vibration diagnostics by frequency analysis.....	27
4.6.1	Overview.....	27
4.6.2	Vibration velocity spectrum.....	28
4.6.2.1	Description of the diagnostic method.....	28
4.6.2.2	Application example: Unbalance.....	29
4.6.3	Vibration acceleration spectrum.....	30
4.6.3.1	Description of the diagnostic method.....	30
4.6.3.2	Application example (rotor field fault).....	31
4.6.4	Envelope spectrum.....	32
4.6.4.1	Description of the diagnostic method (envelope curve).....	32
4.6.4.2	Application example bearing analysis: Rolling element bearing damage (envelope curve).....	33
4.6.5	Method of operation for spectrum monitoring.....	34

5	System overview	35
5.1	Features	35
5.2	Configuration (integration into networks)	36
5.3	SM 1281 structure.....	37
5.4	Ordering data	37
6	Functions	38
6.1	Overview	38
6.2	Operating modes	39
6.3	Measuring mode	42
6.4	Monitoring mode	43
6.4.1	Vibration/bearing monitoring (characteristic RMS values).....	44
6.4.2	Frequency-selective monitoring (spectrum vibration velocity/acceleration)	44
6.4.3	Monitoring of envelope spectrum (roller bearing analysis)	45
6.4.4	Hysteresis	46
6.4.5	Low-frequency RMS monitoring	47
6.5	Speed measurement.....	48
6.6	Message system	49
6.7	Status and actual displays	50
6.8	Recording data.....	51
6.8.1	Recording data: Trends	51
6.8.2	Recording data: Fingerprints	52
6.8.3	Recording raw data.....	52
6.9	Self-monitoring of the system	54
6.10	Time keeping	54
6.11	Data transfer over WebDAV	55
6.12	Data exchange via FTP	57
7	Application planning	59
7.1	Shipping	59
7.2	Storage	59
7.3	Scope of delivery	59
7.4	Installation location	60
8	Mounting	63
8.1	Mounting the SM 1281.....	63
8.2	Mounting the shield clamps	64

9	Connection	65
9.1	Safety instructions and guidelines	65
9.2	Terminal assignment.....	67
9.3	Attaching the cable shield	68
9.4	24 V DC power supply	70
9.5	Connecting sensors	71
9.5.1	IEPE sensors	72
9.5.2	Speed sensors	73
9.6	Connecting to functional ground	73
9.7	Connecting Ethernet	74
10	Commissioning	75
10.1	Commissioning of SM 1281 Condition Monitoring.....	75
11	Integrating functions with the SM 1281 library	77
11.1	Function of the SM 1281 library.....	77
11.2	Software and hardware requirements.....	77
11.3	Library resources	78
11.4	Blocks.....	78
11.4.1	FB SM1281_Module	79
11.4.1.1	FB SM1281_Module - Parameters.....	81
11.4.2	FC SM1281_Channel.....	88
11.4.2.1	FC SM1281_Channel - Parameters.....	89
11.4.3	DB SM1281_Status.....	92
11.4.3.1	DB SM1281_Status - Parameter.....	93
11.4.4	DB SM1281_Backup.....	95
11.4.4.1	DB SM1281_Backup - Parameter.....	95
11.5	Working with the library.....	97
11.5.1	Integrating the library in STEP 7	97
11.5.2	Integrating blocks in STEP 7.....	99
11.5.3	Using blocks.....	103
11.5.3.1	Select operating mode/CPU restart	103
11.5.3.2	All parameters are transferred to the SM 1281.....	105
11.5.3.3	Transferring dynamic parameters to the SM 1281	106
11.5.3.4	Requesting fingerprint recording.....	106
11.5.3.5	Request recording of raw data.....	107
11.5.3.6	Backing up and restoring parameters.....	107
11.6	Update library.....	108

12	Parameter assignment/configuring	109
12.1	Overview	109
12.2	Setting initialization data via the TIA Portal	109
12.3	Parameterizing via the SM 1281 web user interface	110
12.3.1	Software and hardware requirements	110
12.3.2	General operation	111
12.3.2.1	Structure of the user interface	111
12.3.2.2	Logging in / logging out	112
12.3.2.3	Setting the language for the device	113
12.3.2.4	Changing operating mode	113
12.3.2.5	Editing and saving values and settings	114
12.3.2.6	Browser-specific operation	115
12.3.2.7	Error messages	115
12.3.3	Home page	116
12.3.3.1	Home	116
12.3.4	Monitoring values	117
12.3.4.1	Actual values	118
12.3.4.2	Spectra	121
12.3.4.3	Trends	124
12.3.4.4	Pending messages	127
12.3.4.5	Message log	128
12.3.5	Monitoring configuration	129
12.3.5.1	Velocity spectra	130
12.3.5.2	Velocity spectra > Limit bands	132
12.3.5.3	Acceleration spectra	135
12.3.5.4	Acceleration spectra > Limit bands	137
12.3.5.5	Envelope spectra	141
12.3.5.6	Envelope spectra > Limit bands	143
12.3.5.7	Envelope spectra > Bearing types	146
12.3.6	Administration	148
12.3.6.1	General	149
12.3.6.2	Save and restore	152
12.3.6.3	Cleanup	154
12.3.6.4	Identification	157
12.3.7	Help and Contact	158
12.3.8	Website for HMI panels	159
13	Maintenance and servicing	161
13.1	Firmware installation	161
13.1.1	S7 firmware update	161
13.1.2	CM firmware update	161
13.1.3	Restarting SM 1281 via the website	163
13.2	Replace SM 1281	164
13.3	Transferring backed-up initialization data to the SM 1281	165
13.4	Recycling and disposal	166

14	Process and system messages, error handling	167
14.1	LED status display	167
14.2	S7 diagnostics alarms	168
14.3	SM 1281 Web server messages	169
14.4	Operating mode: "ERROR: System not ready"	173
15	Technical data	174
15.1	Technical specifications	174
15.2	Dimensional drawing	176
A	Appendix	177
A.1	Certificates and approvals	177
A.2	Contact address	178
A.3	Licenses	178
A.4	Service & support	179
	Glossary	180
	Index	183

Preface

Purpose of this documentation

These operating instructions contain all the information required for installing, commissioning, and operating the SM 1281 Condition Monitoring. The manual also provides basic knowledge about vibration analysis and vibration diagnostics.

These operating instructions are intended for qualified personnel in the following target groups:

- Commissioning engineers
- Operating and service personnel
- I&C personnel (optional)
- Network administrator (optional)

Basic knowledge required

These operating instructions assume knowledge of automation engineering and condition monitoring.

Validity of the documentation

This documentation is valid for all components of the SIPLUS CMS1200 SM 1281 Condition Monitoring specified in these operating instructions and describes the current delivery state.

Trademarks

SIMATIC® and SIPLUS® are registered trademarks of Siemens AG.

Naming conventions

In this documentation, the terms "SM 1281", "device" and "module" are also used in place of the product designation "SIPLUS CMS1200 SM 1281 Condition Monitoring".

History

Edition	Remarks
11/2015	First edition

Documentation guide

Introduction

The documentation of the SIMATIC products has a modular structure and covers diverse topics relating to your automation system.

The complete documentation for the S7-1200 system consists of the system manual, function manuals, and manuals for the individual devices.

The STEP 7 information system (online help) also supports you in configuring and programming your automation system.

Overview of documentation

The table below lists additional documentation required for using the SM 1281.

Table 2- 1 Documentation for the SM 1281

Subject	Documentation	Most important contents
System description	System Manual S7-1200 Automation System (https://support.industry.siemens.com/cs/document/36932465/simatic-s7-s7-1200-programmable-controller?dti=0&dl=en&lc=de-WW)	<ul style="list-style-type: none"> • Application planning • Assembly • Connection • Commissioning
Designing interference-free controllers	Function Manual Designing interference-free controllers (https://support.industry.siemens.com/cs/document/59193566/simatic-s7-1500-et-200mp-et-200sp-et-200al-designing-interference-free-controllers?dti=0&dl=en&pnid=13613&lc=de-WW)	<ul style="list-style-type: none"> • Basics • Electromagnetic compatibility • Lightning protection

The latest manuals for SIMATIC products are available for download free of charge from the Internet (<http://w3.siemens.com/mcims/industrial-automation-systems-simatic/en/manual-overview/Pages/Default.aspx>).

Safety instructions

3.1 Safety instructions

 CAUTION
--

Observe the safety instructions on the inside front cover of this documentation.
--

SM 1281 devices correspond to the approvals printed on the rating plate. If you have questions about whether it is permissible to install the device in the planned environment, please contact your service representative.

NOTICE

Alterations to the devices are not permitted.

Failure to observe this requirement shall constitute a revocation of the CE approval and manufacturer's warranty.

Intended use

NOTICE

- | |
|---|
| <ul style="list-style-type: none">• The SM 1281 is a condition monitoring system for preventive monitoring of machines and plants.• The SM 1281 is not a machine protection solution. The status displays output by SM 1281 in the form of LEDs, digital outputs, Ethernet telegrams, e-mails, and web pages must not be used for control purposes (e.g. for shutting down the machine). |
|---|

Connection of sensors

 WARNING
Voltage hazards May cause death or serious injury
<p>The inputs of the SM1281 feature functional electrical isolation up to 500 V.</p> <p>Only those sensors may be used that ensure safe electrical isolation up to the maximum level of the potentials configured for the plant.</p> <p>It is imperative that you observe the insulation values of the sensors used and take additional measures, if required, to ensure safe electrical isolation.</p>

Repairs

Repairs to the device may only be performed by authorized specialists.

 WARNING
No user-serviceable parts. May cause death or serious injury
<p>Unauthorized opening or improperly performed repairs can cause considerable damage to property and/or danger to users.</p> <p>For repairs, send the device to the Return Center in Fürth.</p>

Safety extra-low voltage

 CAUTION
Safe electrical isolation
<p>For the 24 V DC power supply, use only power supply units with safe electrical isolation in accordance with IEC 60364-4-41 or HD 384.04.41 (VDE 0100, Part 410), for example, in accordance with the PELV standard.</p> <p>The supply voltage must be within the specified voltage range. Otherwise, function failures on the device cannot be excluded.</p> <p>Applies to non-isolated system design:</p> <p>Connect the terminal for GND 24 V from the 24 V power supply output to equipotential bonding for uniform reference potential. Select a connection point that is as central as possible.</p>

Note**Safety extra-low voltage**

Contact with live components can result in a mild electric shock.

- Disconnect from the power supply before starting work.
- Ensure that no wires or strands protrude from the terminals that can be touched.

3.2 IT security

IT security guidelines

Siemens provides products and solutions with industrial security functions that support the secure operation of plants, solutions, machines, equipment and/or networks. They are important components in a holistic industrial security concept. With this in mind, Siemens' products and solutions undergo continuous development. Siemens recommends strongly that you regularly check for product updates.

For the secure operation of Siemens products and solutions, it is necessary to take suitable preventive action (e.g. cell protection concept) and integrate each component into a holistic, state-of-the-art industrial security concept. Third-party products that may be in use should also be considered. For more information about industrial security, visit

<http://www.siemens.com/industrialsecurity>

(<http://www.industry.siemens.com/topics/global/en/industrial-security/Pages/default.aspx>).

To stay informed about product updates as they occur, sign up for a product-specific newsletter. For more information, visit <http://support.automation.siemens.com>

(<https://support.industry.siemens.com/cs/?lc=en-DE>).

Protective measures for the SM 1281 system

NOTICE

Make sure that only authorized persons are granted access – both physically and in terms of data technology – to the SM 1281 system.

- Change the preset password of the SM 1281 ("0000") to an individual password.
- Keep your password safe.
- Data transfer, including passwords, between a client PC and the SM 1281 via a network is carried out unsecured, i.e. without encryption.

For secured (remote) access to the SM 1281, you must therefore use a router, for example, which establishes a secure connection with encryption and authentication.

Fundamentals of vibration monitoring and diagnostics

4

4.1 Introduction to vibration monitoring

To ensure that a machine is effectively protected during operation, you need to monitor the machine using specific measured variables. The most important measured variables are those that best describe the state of the machine. Mechanical vibration is of special significance in this regard.

There is a great variety of vibration types, measured variables and characteristics when describing mechanical vibration.

4.2 Mechanical vibration

4.2.1 Meaning and information content of vibration

Term

Mechanical vibration is vibration that can be sensed and measured on the surface of objects. When dealing with machine monitoring, this especially includes the surfaces of machines, components and foundations.

Mechanical vibration is sometimes referred to as "structure-borne sound," because it is only propagated in solid structures. Audible "air-borne sound," by contrast, moves through gaseous media, such as air.

Cause of mechanical vibration

Mechanical vibration always occurs when mass moves. Such mass may be rotating or oscillating parts of machines. It can also include gasses or fluids that collide with solid objects, however.

Significance of vibration

Mechanical vibration has an especially high information content. In terms of machine monitoring, this information is highly significant in several respects as:

- Indicator of the machine condition
- Indication of dynamic stresses on the machine, machine base, adjacent machine components
- Indication of safety of operation, service life, and economic efficiency of machines
- Basics of machine diagnostics and vibration damping

Meaning of vibration diagnostics

Various symptoms on running machines allow inferences to be made about the machine condition, such as an impending damage to the machine.

Fault symptoms indicating a condition include:

- Changes in air-borne noise
- Displacement of machine components
- Rising bearing temperatures
- Changed mechanical vibration characteristics

4.2.2 Causes of mechanical vibration

Origins of vibration

Vibration largely originates from the centrifugal forces on rotating machine parts.

This may be caused by:

- Unbalance
- Misalignment of machine drive trains
- Bearing damage
- Gear defect
- Magnetic, hydraulic and / or other functional alternating forces

Transmission and severity of the vibration

Vibration of the rotor and rotor shaft is excited by dynamic forces. This vibration is then transmitted, for example, via rolling element bearings. Transmission follows this path: from moving to non-moving machine parts, from there to the machine base.

Parameters by which the severity of the transmitted vibrations can be measured include the following:

- Rigidity and damping:
 - of the machine design
 - of the bearing design
 - of the machine base
- Condition of rolling element bearing lubricant
- Decoupling the machine base
- Ratio of machine mass to machine base mass

4.3 Measuring vibration

4.3.1 Acceleration sensor

Piezoelectric sensors

Piezoelectric acceleration sensors are used for the frequencies and frequency bands to be covered for vibration monitoring with SM 1281. These sensors generate an analog voltage signal that can be further processed in response to dynamic compressive and tensile forces. Static acceleration forces, such as acceleration due to gravity, are not picked up by these sensors. An industrial standard for piezoelectric sensors is IEPE (Integrated Electronics Piezo-Electric).

The following figure shows an example of a frequency sensor with the typical frequency response.

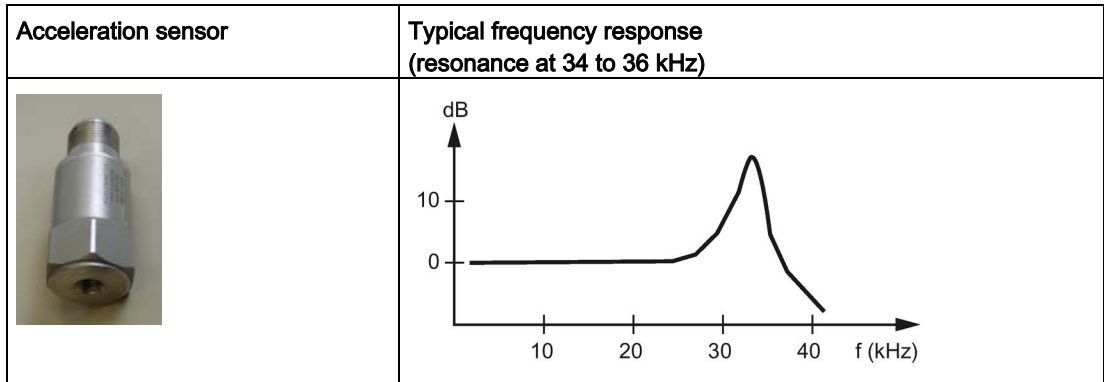

4.3.2 Choice of measuring point

Choosing the measuring point

The following gives information on how to choose the measuring point, i.e. where the acceleration sensor is to be placed.

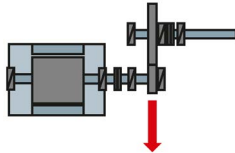
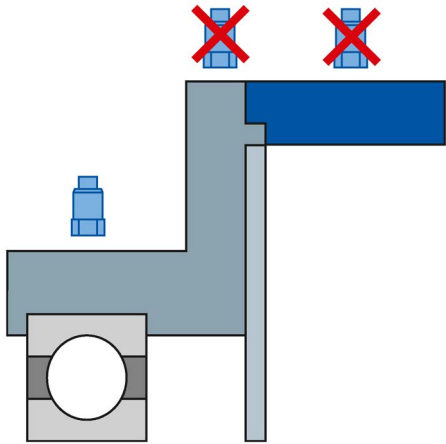
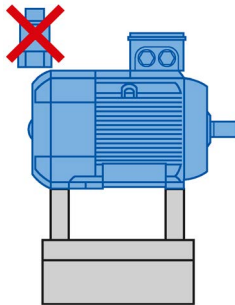
<p>For an optimum measurement result, the measurement axis of the sensor should be oriented in the direction of the load if possible.</p>	 <p>Example: Direction of load of gear wheel</p>
<p>The measurement path between the machine bearing and the measuring point should be as short and direct as possible</p> <ul style="list-style-type: none"> • The longer the signal path, the weaker vibration signals become. • Material transitions damp and/or reflect the signal to be measured. 	
<p>Freely vibrating or elastically deformable parts of the enclosure or cladding (e.g. fan cover) are not suitable as measuring points.</p>	 <p>Fan cover as measuring point</p>





4.3.3 Mounting on the object to be measured

Mounting acceleration sensors

The way the sensor is mounted will greatly influence the measurement accuracy.

A high quality of signal can only be achieved with smooth and clean mounting surfaces. Coats of paint on mounting surfaces also impair the result.

Here are some common types of fixing or mounting acceleration sensors:

Fastening methods		Suitability / special aspects	Frequency band
	Direct screw fastening with threaded bolts	For flat, smooth surface	Upper frequency limit 10 kHz to 20 kHz
	Screw fastening via adapter	For non-flat and/or coated surfaces	Upper frequency limit 10 kHz to 20 kHz
	Adhesive bond, e.g. with superglue or epoxy resin	Depending on the temperature properties of the adhesive used	Upper frequency limit 10 kHz to 18 kHz
	Fastening with permanent magnets	For fast and flexible mounting Suitability depends on adhesive force, falls off at higher frequencies	Upper frequency limit typically approx. 5 kHz to 15 kHz

4.3.4 Measured variable , frequencies, and energy

Interrelationship between measured variables, frequencies, and energy

The following diagram shows how the amplitudes of the three vibration variables (displacement, velocity, and acceleration) develop as frequency rises. The diagram provides information about the frequencies up to which measurement and evaluation of a certain vibration variable can provide meaningful data.

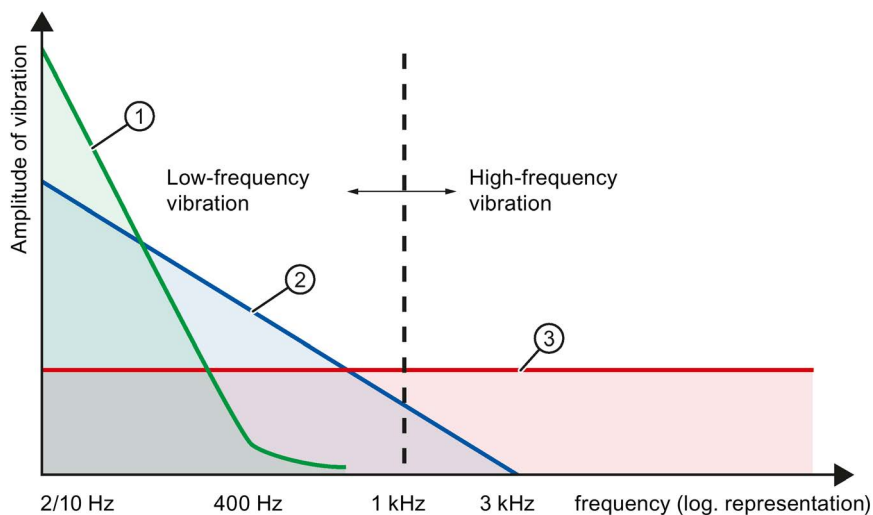

Item	Vibration variable	Causes of vibration and measurement limits
①	Vibration displacement (μm)	Shaft vibration 1 Hz to 0.4 kHz
②	Vibration velocity (mm/s)	Enclosure vibration 2 Hz / 10 Hz to 1 kHz
③	Vibration acceleration (m/s^2)	Gearbox, structure-borne noise 2 Hz / 10 Hz to 20 kHz

4.4 Method of fault detection and diagnostics

4.4.1 Overview of diagnostic methods

Method for condition monitoring

In machine monitoring, there are different ways of monitoring and diagnosing the machine condition. Only those methods are listed below that are implemented in SM 1281.

Characteristic value formation by vibration measurement in the time range

The condition of a machine is monitored by acquiring characteristic values with which the general vibration condition of the machine can be assessed. The trends of these variables indicate whether the condition is becoming worse, i.e. incipient damage.

- vRMS: Interval rms value of the vibration velocity for monitoring the general vibration condition
- aRMS: Interval rms value of the vibration acceleration for roller bearing monitoring

Vibration diagnostics by frequency analysis

In themselves, characteristic value measurements are not enough for precise defect location. For this purpose, the vibration pattern of the machine must be analyzed more precisely. Most types of damage are recognizable in the spectrum by the occurrence of typical damage frequencies or typical patterns of damage frequencies. The following spectra can be calculated for SM 1281 and used as a basis for vibration diagnosis and vibration monitoring:

- Vibration velocity spectrum
- Vibration acceleration spectrum
- Envelope spectrum

4.4.2 Types of defect and diagnostics

Diagnostics methods

The following table shows the most frequent types of errors, which are detected via the diagnostic procedure.

Fault type	Vibration measurement in the time range (characteristic value procedure)	Frequency analysis spectrum		
		Vibration velocity	Vibration acceleration	Envelope curve
Unbalance	RMS	Single rotation frequency f_n	-	-
Misalignment, coupling defect	RMS	Single rotation frequency f_n Double rotation frequency f_n	-	-
Mounting defect	RMS	Single rotation frequency f_n Double rotation frequency f_n Triple rotation frequency f_n	-	-
Blade passing frequency	RMS	$f_{SP} \leq 1 \text{ kHz}$	$f_{SP} > 1 \text{ kHz}$	-
Meshing defect	-	$f_z \leq 1 \text{ kHz}$	$f_z > 1 \text{ kHz}$	-
Belt defect	RMS	$f_R \leq 1 \text{ kHz}$	$f_R > 1 \text{ kHz}$	-
Resonance	RMS	Resonance frequency = rotation frequency f_n	-	-
Electrical stator faults	RMS	Double line frequency f_{line}	-	-
Electrical rotor faults	RMS	$f_{bar} \leq 1 \text{ kHz}$	$f_{bar} > 1 \text{ kHz}$	-
	RMS	Double line frequency f_{line} Modulation with slip frequency f_{slip}	--	-

4.5 Vibration diagnostics by characteristic value formation in the time range

4.5.1 Overview

Applications of vibration measurement in the time range

Wide-band vibration measurement in the time range provides information about the overall condition of a machine and the effectiveness of measures taken to suppress vibration.

The development of the machine condition can be checked by comparing up-to-date measurements with previous vibration levels or by comparing with published guidance values or manufacturers' data. With this trend analysis, worsening conditions can be detected in good time and appropriate measures planned and implemented.

Note

Detailed fault diagnostics is not possible or only possible to a limited degree for wide-band vibration measurement based on characteristic values.

Characteristics of vibration measurements in the time range

- The measurement methods and assessment of wide-band vibration measurements are defined and standardized in national and international guidelines and standards.
- The values of rms vibration velocity are measured and calculated over a defined frequency band.
- The range includes the frequencies 2 Hz or 10 Hz to 1000 Hz.
Depending on the speed, the measuring range starts either at 2 Hz (speeds from 120 to 600 rpm) or at 10 Hz (speeds greater than or equal to 600 rpm) according to the DIN ISO 10816 standard.

4.5.2 Standards and guidelines

Standards and guidelines

The following standards and guidelines are applicable to machine monitoring using wide-band characteristics:

Standards	EN 60034-14	Vibration measurement, acceptance measurements at the factory
	ISO 10816-1	Mechanical vibration - Evaluation of machine vibration by measurements on non-rotating parts - Part 1: General instructions
	ISO 10816-3	Mechanical vibration - Evaluation of machine vibration by measurements on non-rotating parts - Part 3: Industrial machines with nominal power above 15 kW and nominal speeds between 120 rpm and 15000 rpm when measured in situ
Guidelines	VDI 3832	Rolling element bearing condition, various procedures

4.5.3 Monitoring measured variable trends

Trend monitoring

The following diagram shows a typical trend curve obtained by measurement or calculation of characteristic values. Signs of an incipient fault are usually detectable long before failure, e.g. because the vibration value increases.

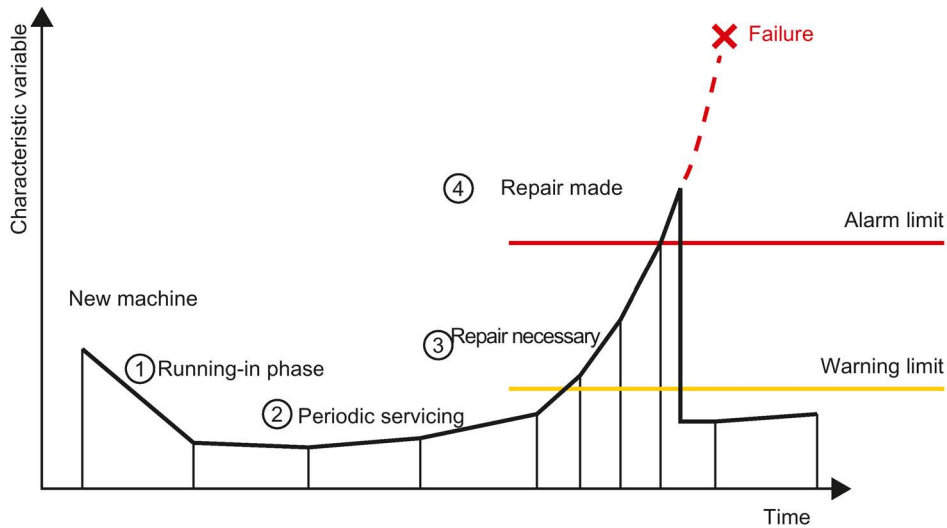

Image 4-1 Characteristic value trend

①	The characteristic values are initially somewhat higher during the start-up phase of a new machine. The characteristics variables then decline to the values that represent the fault-free condition of the machine.
②	The maintenance strategy may be periodic servicing, for example. By regular condition monitoring, developing damage can be detected as it occurs.
③	The characteristic value has exceeded a warning limit. Repair is necessary. However, the machine can still be used. Further measurements show a steep increase in the characteristic values. It is possible to extrapolate from the trend when major damage resulting in failure would occur.
④	The defined alarm limit is exceeded. The machine is now repaired. Measurements of the characteristic values again indicate the fault-free condition of the machine.

4.5.4 Evaluation of the machine condition via the vibration severity (RMS)

4.5.4.1 Description of the diagnostic method (RMS)

Characteristics SM 1281

Characteristic value	Frequency band	Monitorable
vRMS Root mean square - speed	2 / 10 Hz to 1 kHz ¹	Speed-dependent damage
aRMS Root mean square - acceleration	> 1 kHz	Bearing-dependent damage

¹ In the vibration frequency band 2 Hz / 10 Hz to 1 kHz, the interval rms value of the vibration velocity is the most meaningful analysis value. Typical excitation of machine vibrations at the frequency of rotation is in this frequency band.

Calculating / determining the RMS

The interval rms value of the vibration velocity is a wide-band vibration value. It is calculated as the arithmetic mean of all vibration events within a defined frequency band (e.g. 10 Hz to 1 kHz for the rms vibration velocity).

4.5.4.2 Application example machine analysis: Unbalance (RMS)

Application example

Machine vibration is frequently caused by misalignment, unbalance or frames mounted under stress.

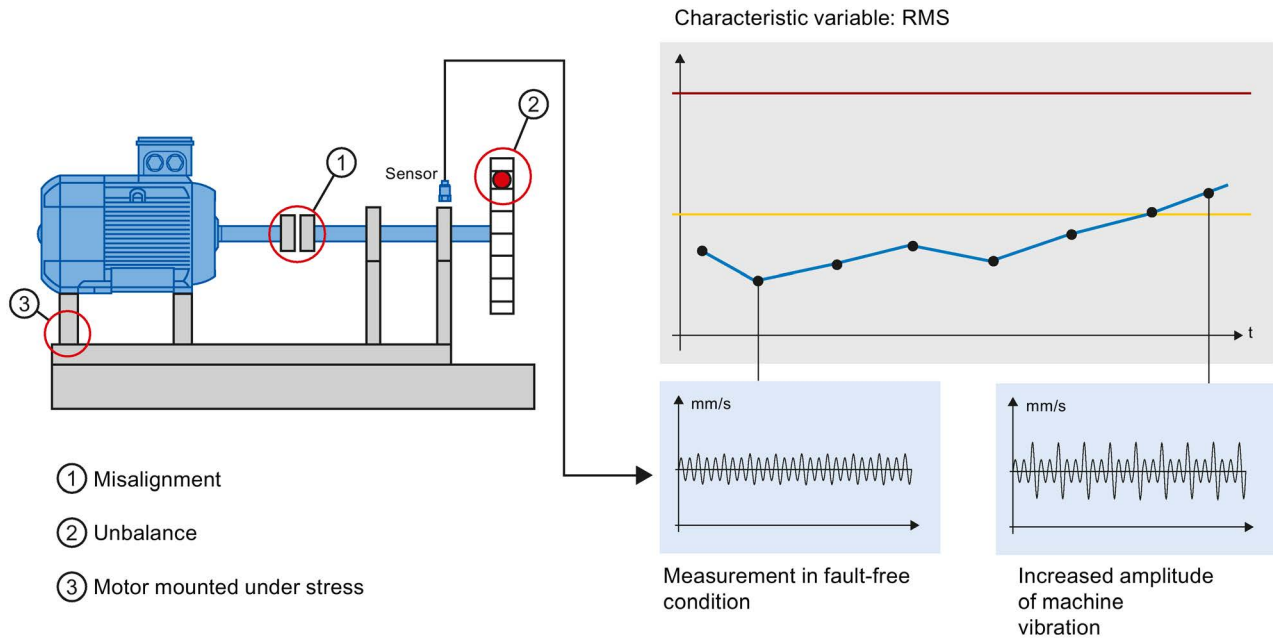

Image 4-2 Example of RMS

4.6 Vibration diagnostics by frequency analysis

4.6.1 Overview

The vibration diagnostics in the time range reaches its limits when it comes to examining the causes of wear more precisely. Frequency analysis is used as the diagnostic method for more detailed examination of vibrations.

It is the basis for diagnostic vibration measurement:

1. Analyze vibration signals
2. Locate the cause
3. Define remedial action

Frequency analysis

The principle of frequency analysis is to convert a signal from the time band into the frequency band by means of spectral analysis. One common mathematical method is the Fast Fourier Transform.

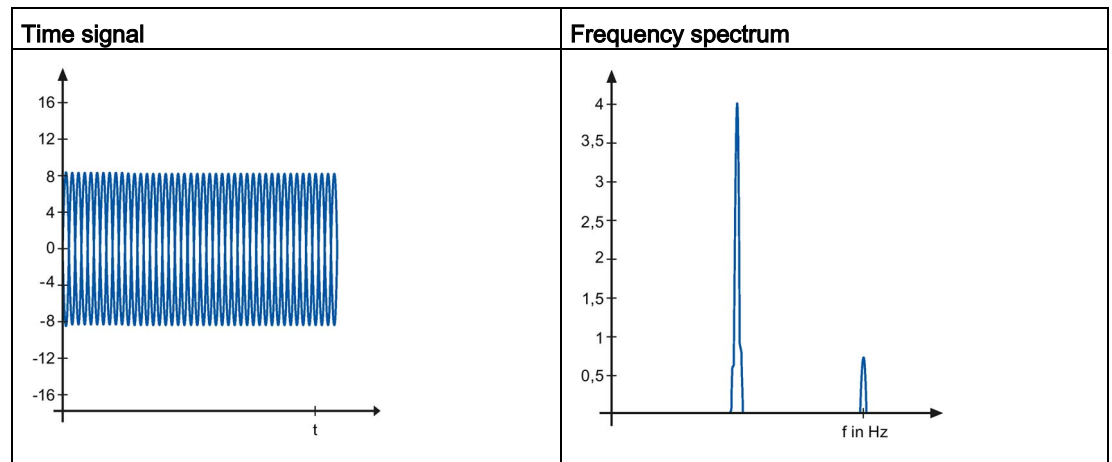

4.6.2 Vibration velocity spectrum

4.6.2.1 Description of the diagnostic method

Characteristics SM 1281

Spectrum	Frequency band	Resolution	Monitorable
Vibration velocity	2 Hz to 1 kHz	0.204 Hz	Any combination of speed-dependent and speed-independent monitoring functions.

Depending on the current velocity or the monitoring to be conducted, the SM 1281 automatically uses the appropriate frequency range.

Vibration velocity spectrum

The following figures shows the frequency band of the spectrum for the vibration velocity 2 Hz to 1 kHz and several examples of errors with their characteristic frequencies, which can be detected and revealed in this spectrum.

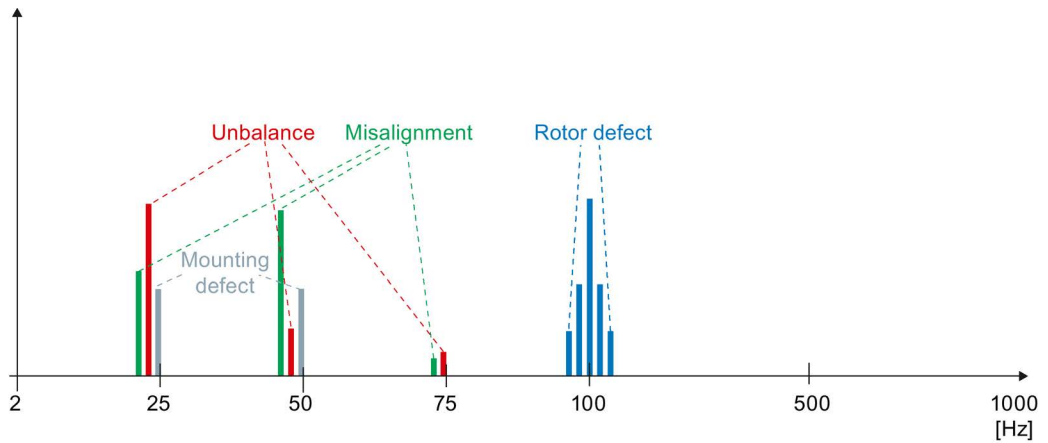

Image 4-3 Overall spectrum of vibration velocity

4.6.2.2 Application example: Unbalance

Example of unbalance

In the case of unbalance, the amplitude of the rotational frequency is very pronounced in both the horizontal and vertical directions of measurement.

The spectrum is calculated from the raw data.

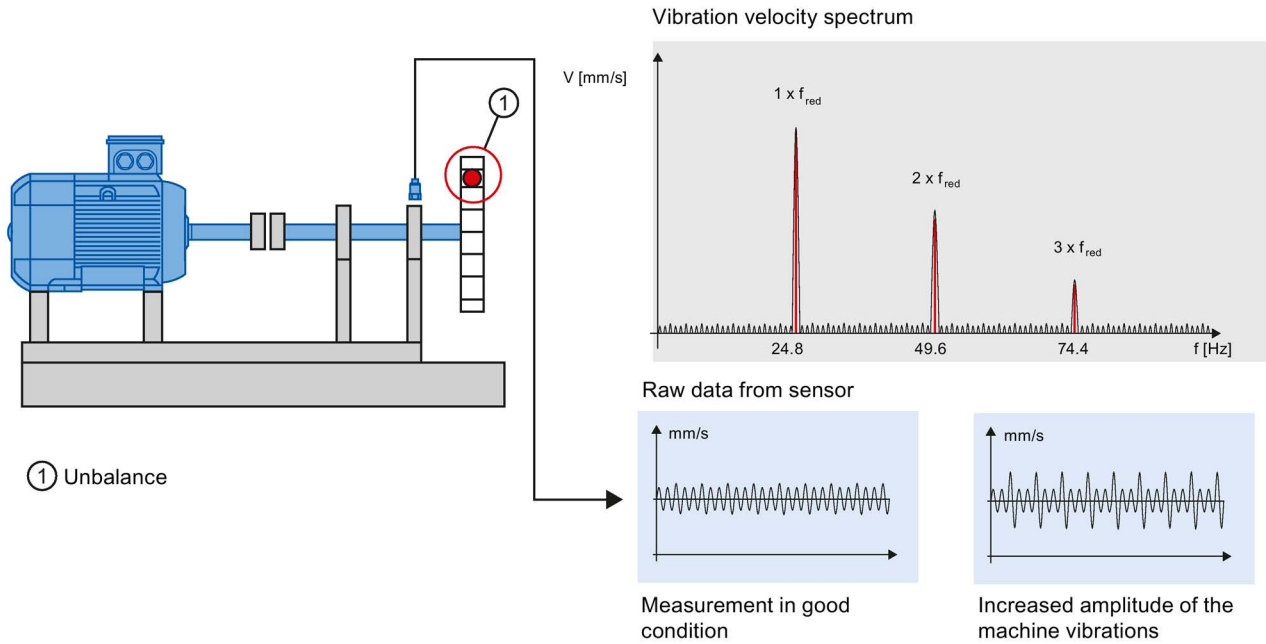

Image 4-4 Example of a spectrum of vibration velocity (unbalance)

4.6.3 Vibration acceleration spectrum

4.6.3.1 Description of the diagnostic method

Characteristics SM 1281

Spectrum	Frequency band	Resolution	Monitorable
Vibration acceleration	2 Hz to 10 kHz	2.86 Hz	Any combination of speed-dependent and speed-independent monitoring functions.

Vibration acceleration spectrum

The following figures shows the frequency band of the spectrum for the vibration acceleration 2 Hz to 10 kHz and several examples of errors with their characteristic frequencies, which can be detected and revealed in this spectrum.

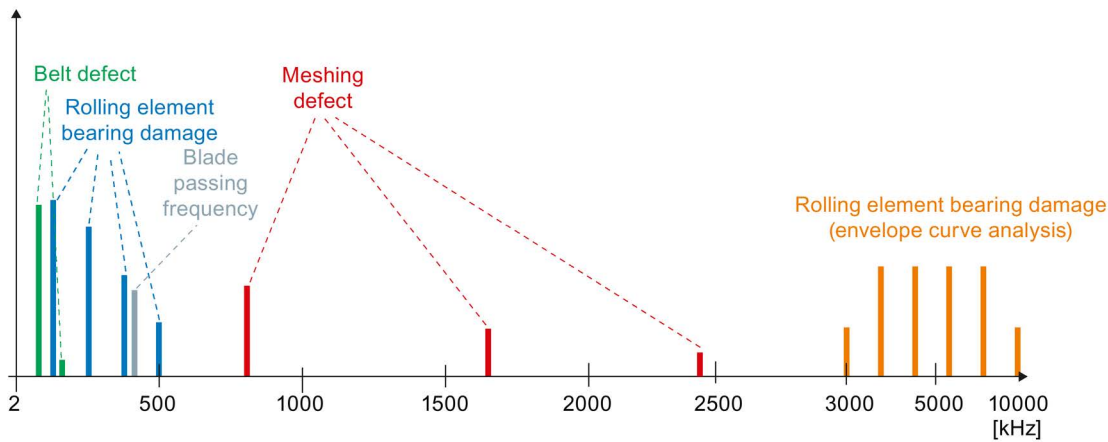

Image 4-5 Overall spectrum of vibration acceleration

4.6.3.2 Application example (rotor field fault)

Example rotor field fault

The causes of a defective rotor can be, for example, a broken or loose bar. The spectrum is calculated from the raw data.

Such faults can be detected, for example, by:

- Bar frequency with sidebands of twice the line frequency (see figure)
- Twice the line frequency with sidebands of the slip frequency (not shown here)

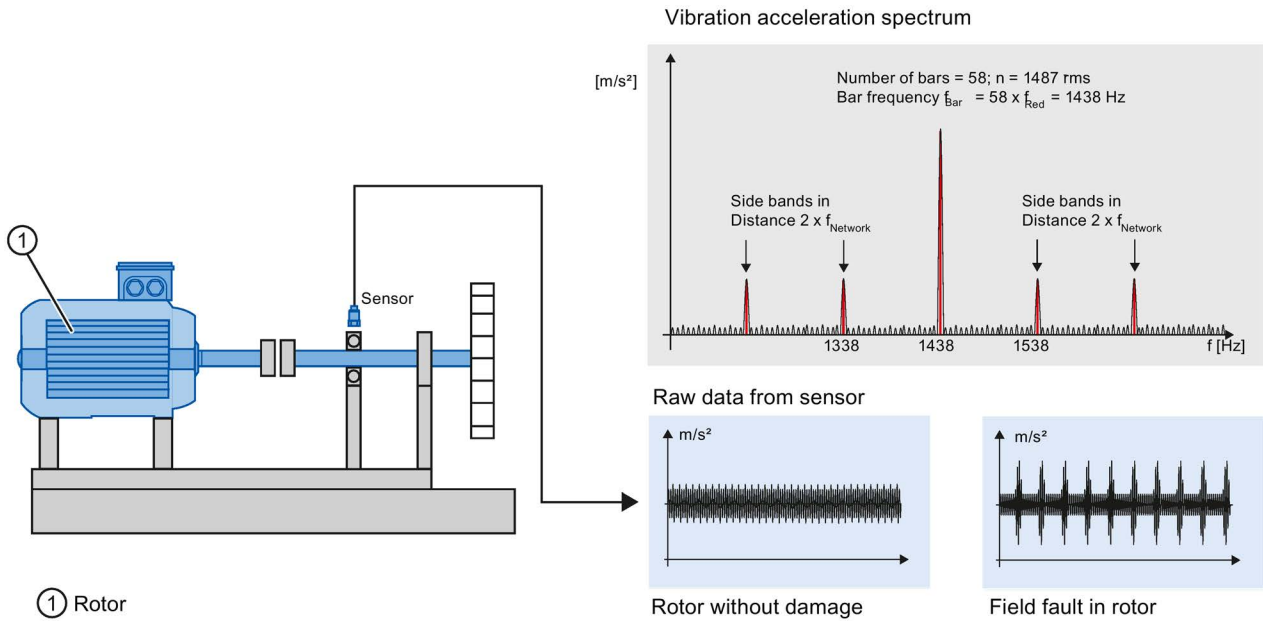

Image 4-6 Example: Spectrum of the vibration acceleration (rotor field fault)

4.6.4 Envelope spectrum

4.6.4.1 Description of the diagnostic method (envelope curve)

Characteristics SM 1281

Spectrum	Frequency band	Resolution	Monitorable
Envelope curve analysis	2 Hz to 1 kHz	0.2 Hz	Bearing damage frequencies and other speed-dependent monitoring functions

Depending on the current speed or the monitoring to be conducted, the SM 1281 automatically uses the most appropriate frequency range.

Method for envelope curve analysis

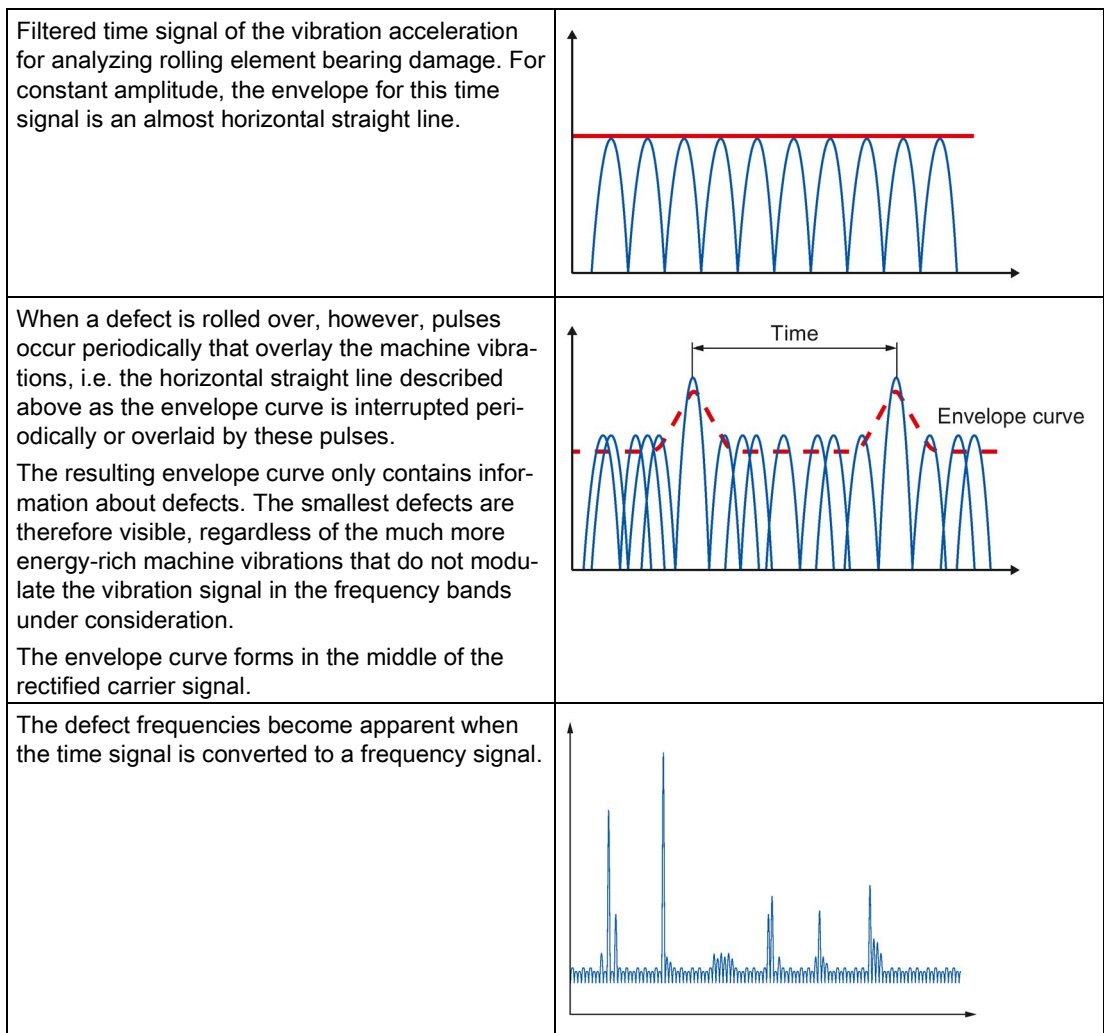

4.6.4.2 Application example bearing analysis: Rolling element bearing damage (envelope curve)

Example rolling element bearing damage

Damage frequently develops in the raceway of the outer race. Such damage can normally be detected using envelope curve analysis several months before a critical condition develops. The following example shows the envelope curve spectrum of the vibration acceleration. The spectrum is calculated from the raw data.

Damage frequency of the outer race in this example: 125 Hz

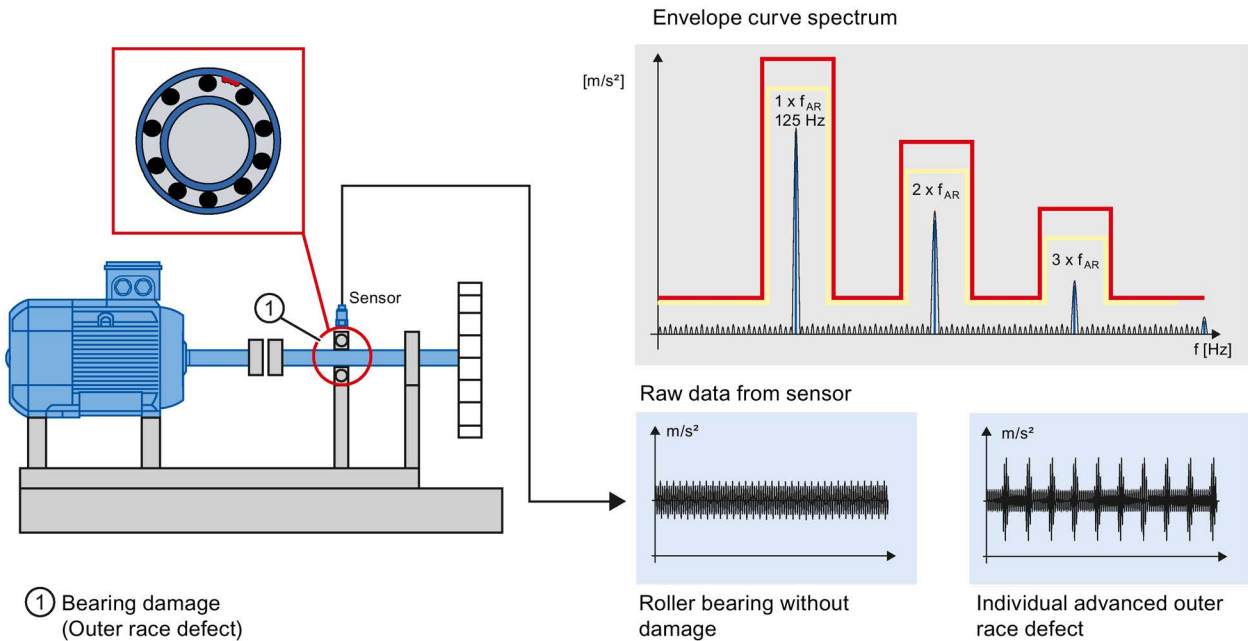

Image 4-7 Example of envelope curve analysis

4.6.5 Method of operation for spectrum monitoring

Combining different monitoring methods (speed-dependent / speed-independent) on one spectrum results in a single limit band for warning and alarm. The amplitude values of the spectrum are tested continuously against the limit band.

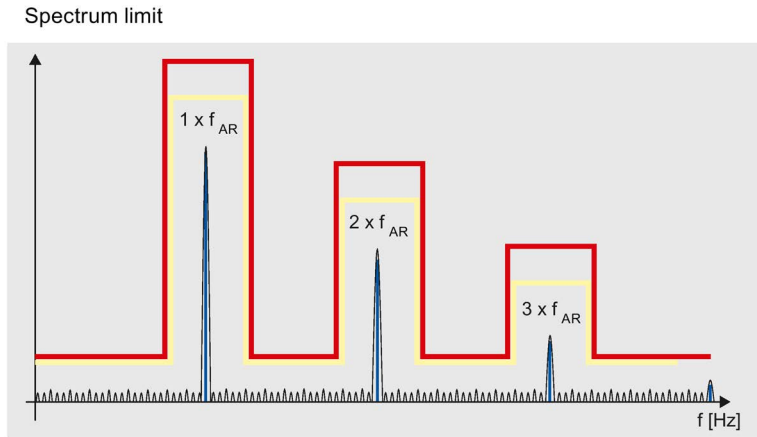

Image 4-8 Spectrum limit band, speed-dependent

With speed-independent monitoring, add-on units (e.g. fans on machines) can be included in the calculations.

System overview

5.1 Features

The SM 1281 is a module for use in combination with the SIMATIC S7-1200 automation system.

Using the SM 1281, you can continuously monitor the states of components subject to wear, e.g. motors, bearings, and critical machine components.

The SM 1281 can be used together with an S7-1200 CPU (FW 4.1 or higher) as a stand-alone monitoring system.

Other features

- 4 VIB sensor channels for vibration signal monitoring
- 1 digital input for speed measurement
- Direct integration in existing SIMATIC S7-1200 automation systems
- Problem-free integration into new and existing machines
- High sampling rates
- Synchronous data recording
- Vibration analysis within the SM 1281. The result of the analysis is transferred to the S7-1200 CPU via the backplane bus for further processing
- Processing of the results from the vibration analysis in the control program of the user
- Configuration of functions of the SM 1281 directly from the TIA Portal

5.2 Configuration (integration into networks)

Configuration

The following figure shows an example configuration with the SM 1281 together with a SIMATIC S7-1200 automation system.

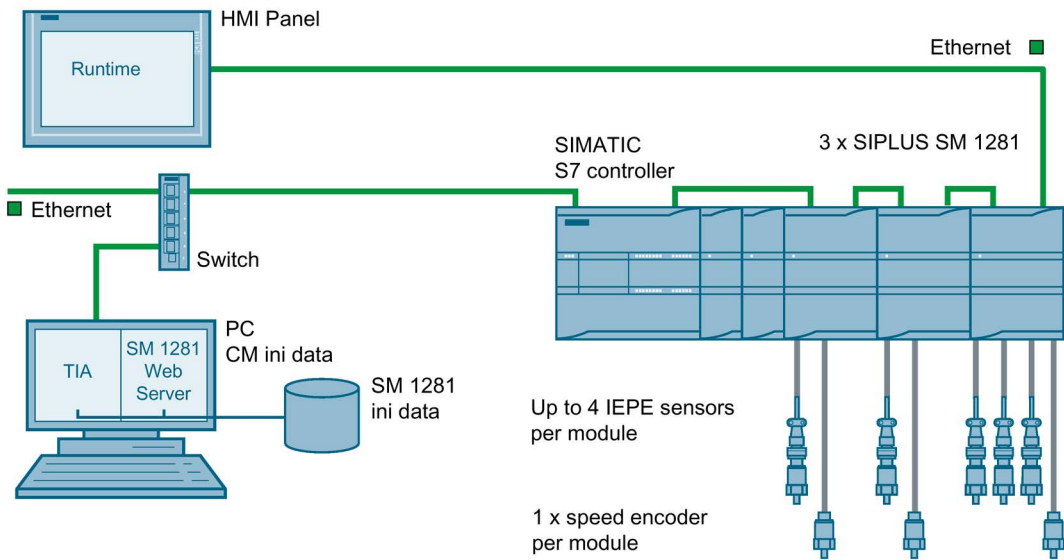
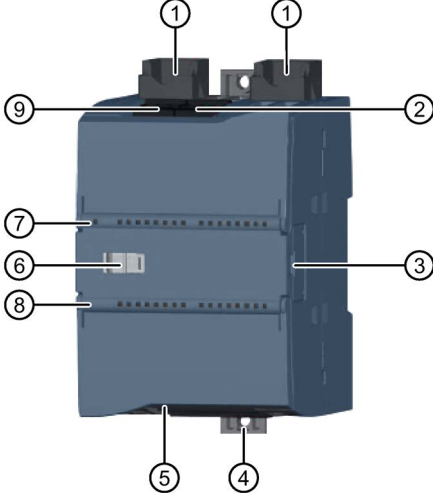

Image 5-1 Configuration

5.3 SM 1281 structure

SM 1281 structure

Table 5- 1 SM 1281 structure

Structure	
	① Ethernet connections
	② Connection for speed sensor
	③ Backplane connection "downstream"
	④ Mounting slide
	⑤ Connections for four IEPE vibration sensors
	⑥ Sliding lug for backplane bus connection "up-stream"
	⑦ LEDs <ul style="list-style-type: none"> • DIAG (red/green): S7 diagnostics display • MON (green): monitoring active; shows that the device is in the "RUN: Monitoring" mode.
	⑧ 4 x IEPE ERROR (red): shows the error status of the respective IEPE measurement channel.
	⑨ 24 V DC power supply connection (internal fuse T500 mA)

5.4 Ordering data

Table 5- 2 Ordering data

Product	Article number
SIPLUS CMS1200 SM 1281 Condition Monitoring	6AT8007-1AA10-0AA0
SM 1281 shield clamp set, comprised of two shield clamps and five terminal clamps for the EMC connection of signal lines and encoder lines to the SM 1281	6AT8007-1AA20-0AA0
SIPLUS CMS2000 connecting cable for connecting VIB sensors to MIL plugs; length 3 m	6AT8002-4AC03
SIPLUS CMS2000 connecting cable for connecting VIB sensors to MIL plugs; length 10 m	6AT8002-4AC10
SIPLUS CMS2000 VIB sensor (vibration sensor IEPE)	6AT8002-4AB00

Functions

6.1 Overview

The following display shows a functional overview of the SM 1281 and the exchange of data between the controller and SM 1281.

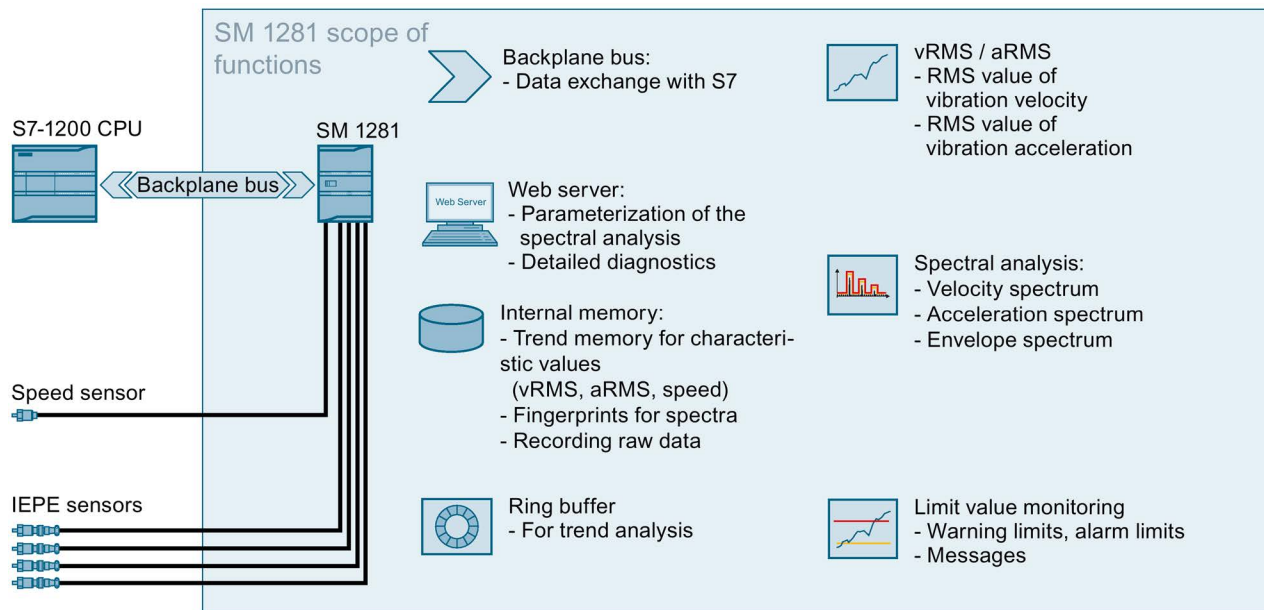

Information on the individual functions can be found in the following sections.

6.2 Operating modes

The SIPLUS SM 1281 Condition Monitoring System can assume different operating modes during operation.

In the following, you can see what modes the system can assume and when a change in status is initiated by a user request (①).

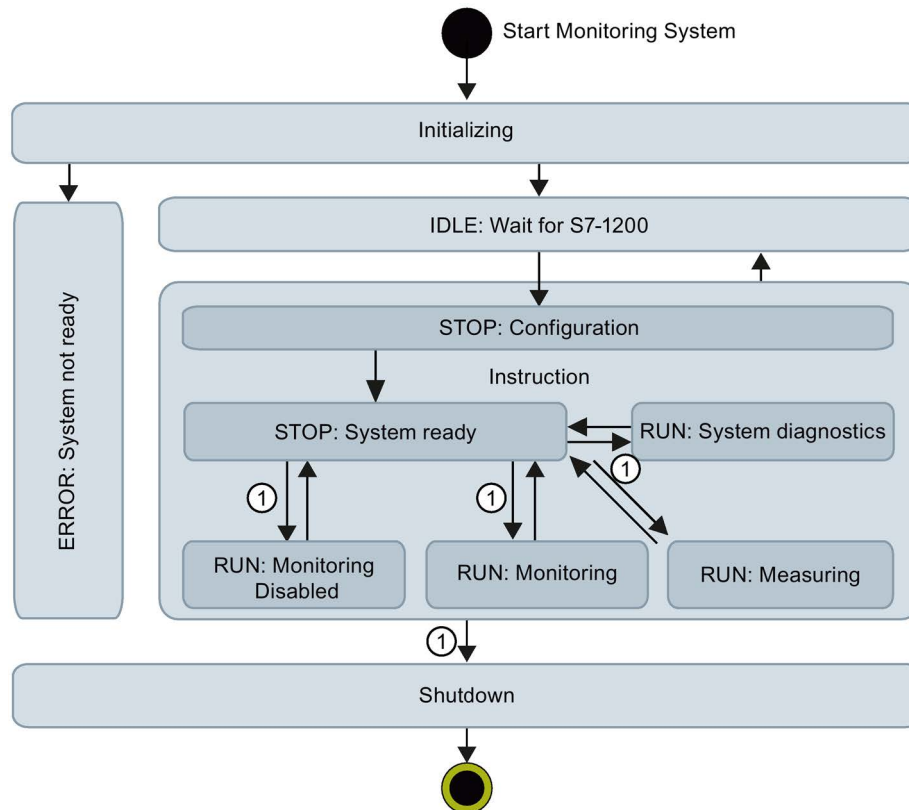

Initializing

After switching on, the device is in "Startup" mode. The startup takes approximately one minute and can take up to three minutes. Non-recurrent initial settings are made in this state. Steps are subsequently performed that prepare the device for operation. If an error occurs at this point, the system will switch to the operating mode "ERROR: System not ready".

IDLE: Wait for S7-1200

In this mode, the module waits for communication with the S7 backplane bus to be successfully established. During this mode, the SM 1281 web interface is not reachable, with the exception of the "Home" (Page 116) page. The fault is displayed on the "Home" (Page 116) page via the operating mode.

STOP: Configuration

The configuration starts. The module waits for "STOP: System ready".

STOP: System ready

When all initialization and preparation steps have been successfully completed, the "STOP: System ready" state is assumed. The device is now ready for operation, but not yet in an active operating mode. That is, no acquisition or monitoring of process measured variables is performed. In the "STOP: System ready" state you can perform the following actions:

- Erase, back-up and restore data
- Restart the device
- Reset the device to default settings
- Administrative tasks

Note

You have to actively control the changeover from STOP to an active operating mode and back by means of an explicit request via the web site or via the S7 program.

RUN: System diagnostics

This operating mode is used for the commissioning of the vibration acceleration sensors (Page 72). All of the parameterized vibration channels are measured. For all of the parameterized vibration channels, the respective direct current portion (also: DC offset, operating point) of the connected IEPE sensor is determined and transferred to the S7 controller. No further processing or monitoring of the vibration data takes place.

This operating state can only be activated by the S7 controller. The results are available in the global data block "SM1281_Status" (Page 93) as a `sensor_offset` parameter.

With knowledge of the sensor offset, the maximum measurable vibration acceleration of a vibration channel can be determined. The SM 1281 has a voltage measurement range at the IEPE inputs from 6.2 V to 15.0 V. If the operating point of a connected IEPE sensor is around 12 V, for example, wanted signals up to ± 3 V can be measured before a measuring range limit is reached. When a sensor with a typical sensor sensitivity of 100 mV/g is used, the module can measure vibration accelerations up to ± 30 g.

Switch to an active operating state ①

You can control the transition from the operating mode "STOP: System ready" to an active operating mode ("RUN: Monitoring" or "RUN: Measuring") via buttons on the websites (see Chapter Changing the operating mode (Page 113)) or via the S7 (see Select operating mode/CPU restart (Page 103)).

RUN: Measuring

In the mode "RUN: Measuring", the SM 1281 functions purely as a measuring device. The measured variables of the configured channels are recorded and displayed and transferred to the S7. The process data are recorded, but no monitoring is performed. Measuring mode is used for test purposes and supports commissioning procedures.

In measurement mode, the vRMS and aRMS characteristic values are determined and updated.

The user can also create fingerprints and record raw data in measuring mode.

RUN: Monitoring

In the mode "RUN: Monitoring", the device is in the actual monitoring mode, i.e. all the monitoring tasks parameterized by the user will be processed. The device acquires the measured values of the configured channels, evaluates them, records process data and triggers responses in the case of limit violations.

RUN: Monitoring inhibited

In the operating mode "RUN: Monitoring deactivated", all of the values continue to be recorded or calculated and are displayed accordingly on the Actual values (Page 118) page on the SM 1281 websites and in the S7. Monitoring no longer takes place, however (the actual values have a corresponding blue background on the SM 1281 websites). Pending messages for limit transgressions remain active, even if the measured or calculated values no longer exceed the limit. If thresholds are violated in "RUN: Monitoring inhibited" mode, no messages will be generated.

If the "RUN: Monitoring inhibited" mode is exited and there is no switchover to "STOP" or "RUN: Measuring" mode, monitoring is resumed and threshold violations will result in messages again (i.e. they will come and go in accordance with the monitored variables and their thresholds).

"RUN: Monitoring inhibited" allows temporary interruption of the monitoring function in SM 1281. It can be used to exclude transitory states (e.g. start-up or coast-down of a machine) of the monitored object from monitoring by SM 1281. This feature can be used to avoid unwanted messages from SM 1281 due to transitory states of the monitored object.

Example: When a machine is started up alongside the monitored equipment, the measured vibration signal is affected. To prevent unwanted messages, the unit can be switched to "RUN: Monitoring inhibited" mode during the start-up procedure.

Shutdown

Changeover to the "Shutdown" operating mode and therefore shutdown of the device is performed if:

- "Restart SM 1281" is called via the web interface (see Section General (Page 149))
- the "Reset to factory settings" function is called (see Section Cleanup (Page 154))

The device remains in "Shutdown" operating mode for approx. 2 seconds, allowing all active operations to be completed.

This is always followed by a warm restart of the system.

ERROR: System not ready

This is the error status of the monitoring system. In this state, the system itself does not operate. You can control the module to a limited extent, however, via the SM 1281 web interface. With the exception of a restart, a change of operating modes is not possible. Access via FTP and WebDAV is possible. For causes and remedies, see Section ERROR: System not ready (Page 173).

6.3 Measuring mode

Measurement mode is for test purposes and to support commissioning, in particular, to define the limits to be monitored.

In measurement mode, measured variables chosen by the user are measured, calculated and displayed as trend curves on selected channels. The measured variables are not measured during measurement mode.

Spectra can be saved as fingerprints and record of the current machine condition regarding vibration.

For subsequent analysis and evaluation, current raw data can also be stored by the user (see Section Recording raw data (Page 52)).

See "RUN: Measuring" in Section Operating modes (Page 39) and Changing the operating mode (Page 113).

6.4 Monitoring mode

In monitoring mode, all measured variables to be monitored are constantly measured, calculated and monitored for parameterized limits. If limit values are exceeded, relevant messages are output and the parameterized responses are executed.

The control program can access the messages via an FB.

The measured variables are recorded in a trend curve.

See "RUN: Monitoring" in Section Operating modes (Page 39) and Changing the operating mode (Page 113).

Frequency bands and speed ranges

The SM 1281 supports the following frequency bands and speed ranges for the monitoring procedures and the spectra:

Table 6- 1 Monitoring method

Monitoring method	Frequency band		Speed range
	fCutHigh (CutOffFreqHPF)	fCutLow (CutOffFreqLPF)	
aRMS / vRMS ¹	2 Hz / 1 kHz (adjustable)	1 / 3 / 10 kHz (adjustable)	120...600 rpm
	10 Hz / 1 kHz (adjustable)	1 / 3 / 10 kHz (adjustable)	600...16000 rpm
Low-frequency RMS monitoring (Page 47)	0.05 Hz	100 Hz	Speed-independent

¹ The standard values from the ISO 10816 only apply for vRMS:
 - from 2 Hz to 1 kHz for speeds from 120 to 600 rpm
 - from 10 Hz to 1 kHz for speeds > 600 rpm

Table 6- 2 Spectra

Spectra	Frequency band	Speed range
Velocity	2 Hz to 1 kHz	120...16000 rpm
Acceleration	2 Hz to 10 kHz	
Envelope curve	0.5 Hz...1 kHz	

6.4.1 Vibration/bearing monitoring (characteristic RMS values)

RMS monitoring

The SM 1281 permits the calculation of the characteristic values vRMS and aRMS:

- The vRMS is calculated based on the interval rms value of the vibration velocity.
- The aRMS is calculated based on the interval rms value of the vibration acceleration.

For each vibration channel, warning and alarm limits and hysteresis can be set for vRMS and aRMS.

Cycle-based hysteresis

Three values calculated consecutively must violate the specified thresholds before a monitoring response is triggered. Similarly, three consecutive limit undershoots must occur (including the absolute value hysteresis), before the warning or alarm is canceled again.

6.4.2 Frequency-selective monitoring (spectrum vibration velocity/acceleration)

Monitoring of spectra (velocity, acceleration)

The following methods can be combined to monitor the acceleration spectrum and the velocity spectrum. The sequence corresponds to the priority (descending order):

- Speed-independent peak monitoring of individual frequencies. For positioning in the spectrum, a factor is stated that is multiplied by the single rotational frequency. For the monitored frequency, a frequency tolerance band for monitoring can be set. It states the band around a certain frequency in the spectrum that will be monitored for limits.
- Speed-independent peak monitoring of absolute frequency bands (e.g. 100 to 500 Hz)
- Mask frequency band for monitoring the entire spectrum, on those frequencies that are not subject to peak monitoring.

Warning and alarm limits can be entered for the stated methods.

Three consecutive limit violations must occur before a warning or alarm is triggered. Similarly, three consecutive limit undershoots must occur (including the absolute value hysteresis), before the warning or alarm is canceled again.

6.4.3 Monitoring of envelope spectrum (roller bearing analysis)

Monitoring of envelope spectrum

In roller bearing analysis, the spectrum of the envelope curve is monitored via the vibration acceleration. The following methods can be combined:

- Speed-dependent peak monitoring of individual fault frequencies with settable frequency tolerance for monitoring.

The fault frequencies are determined from the bearing data entered.

- Mask frequency band for monitoring the entire spectrum, on those frequencies that are not subject to speed-dependent peak monitoring.

Where different methods overlap, the priority rule is:

- Speed-dependent monitoring functions interrupt the mask frequency band.

Warning and alarm limits can be entered for both methods.

The limit bands comprise warning and alarm limits for four types of damage:

- Outer race defect
- Inner race defect
- Ball damage
- Cage damage

These limits can be specified for up to five orders of magnitude (multiples of the respective fault frequencies).

Moreover, speed-dependent monitoring functions can be configured for any frequencies irrespective of the fault frequencies.

Operating principle of the roller bearing analysis

The four bearing components, outer race, inner race, ball, and cage, have different fault frequencies which are determined by the bearing geometry and speed. The fault frequency of each bearing component multiplied by the specified order gives the frequency to be monitored in the envelope spectrum in each case.

The frequency band considered for limit comparison around the determined frequencies can be set (typically ± 0.3 Hz).

Three consecutive limit violations must occur before a warning or alarm is triggered. Similarly, three consecutive limit undershoots must occur (including the absolute value hysteresis), before the warning or alarm is canceled again.

6.4.4 Hysteresis

Hysteresis

Hysteresis is used to reduce the number of alarms generated, especially when measured values fluctuate around parameterized limits.

For monitoring spectra, a hysteresis can be specified for each limit band.

With spectra, the hysteresis can be stated as an absolute value or as a percentage, that is, relative to the limit.

The hysteresis is always specified as an absolute value for vRMS and aRMS.

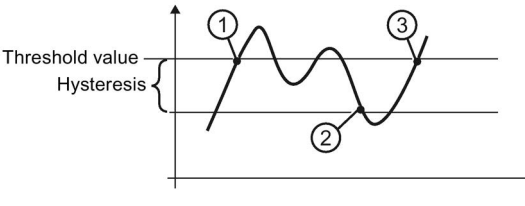
Working principle of hysteresis	Description
 <p>① Threshold value violation is detected ② Threshold value violation is cleared ③ New threshold value violation is detected</p>	<p>This hysteresis is a single-sided absolute value hysteresis that is only considered when the monitored value falls below the limit.</p> <p>The monitored value and the limit are directly compared to detect a violation ①.</p> <p>If a limit violation occurs, and the monitored value falls below the limit again, the value must fall below the limit minus the hysteresis before the limit violation can be canceled ②.</p>

Cyclic hysteresis

When monitoring vRMS, aRMS, and spectra, three consecutive limit violations must have occurred before a warning or an alarm is triggered. Similarly, three consecutive limit undershoots must occur (including the absolute value hysteresis), before the warning or alarm is canceled again.

6.4.5 Low-frequency RMS monitoring

To quantitatively evaluate and monitor low-frequency vibrations (e.g. for low speeds or tower vibrations), the SM 1281 can be set to "Low-frequency RMS monitoring" mode. This mode applies for all four vibration channels of the SM 1281.

To activate the mode, the device must be in the operating mode "RUN: Monitoring" and the parameter `ReducedSamplingRate` = 1 (true) must be set in the S7.

Function

- Calculation of characteristic values in the frequency range from 0.05 Hz to 100 Hz
- Calculation of characteristic values of the vibration velocity v_{RMS}
- Suitable for slowly rotating machines, tower vibration

This characteristic value is not suitable for monitoring bearing and gearbox damage.

The characteristic value a_{RMS} and the spectra are not calculated in this mode.

How it works

Note

If the parameter `ReducedSamplingRate` is set, a fixed value of 0.1 Hz is set instead of the entry in the parameter `CutOffFreqHPF_vRMS`.

The raw data of the sensor channels is recorded for the duration of one minute.

The speed is not considered here.

The rms value of the vibration speed is calculated, monitored, and represented as trend curve.

The evaluation of this trend curve is based exclusively on the experience of the analyst.

NOTICE
This characteristic value must not be viewed and evaluated as normative according to ISO 10816-3!

Recommendation

For the low-frequency RMS monitoring, select a sensor with a frequency range from 0.1 Hz and a sensor sensitivity of 500 or 1000 mV/g.

6.5 Speed measurement

The SM 1281 has two options for speed measurement:

- Via the S7-1200 (`SpeedSource = 1`)

The SIMATIC controller specifies the set speed via the backplane bus (`Speed`).

- Via the digital input of the SM 1281 (`SpeedSource = 2`)

Measurement via DI

0 to 16000 pulses/minute can be recorded via the digital input. You can set the number of pulses that your speed measurement can generate per revolution in the S7 at the `PulsesPerRevolution` parameter.

For one pulse per revolution, a maximum measurable speed of 16000 revolutions per minutes is the result. 1 to 100 pulses per revolution are possible. The more pulses per revolution, the lower the maximum measurable speed, but the more accurate the speed measurement.

At speeds <100 rpm, use a speed sensor with more than 1 pulse/revolution to achieve more accurate measurement results.

Minimum pulse duration:

- If an encoder provides positive speed pulses, they are reliably recorded beyond a length of 50 μ s.
- If an encoder provides negative speed pulses, they are reliably recorded beyond a length of 600 μ s.

Failure of the speed sensor

The following errors may occur during speed measurement:

- Cable break
- Short circuit of the sensor cable
- Sensor adjusted/installed incorrectly
- Sensor faulty

If an error occurs while measuring the speed, the last valid speed will be still be displayed up to one minute as the valid speed on the SM 1281 websites and in the S7. The actual speed may differ from the displayed speed during this time!

6.6 Message system

The message system of the SM 1281 logs events which occur in the system, device, or process. The following messages are displayed:

- Process messages: alarms, warnings
- System events: alarms, warnings, information

No alarms or warnings are pending in normal operation of the SM 1281.

Process messages

Process messages are triggered if limit values of IEPE channels are exceeded.

Example:

Date	Time	Type	Text	Action
2012-01-01	08:04:02	Alarm	VIB1 Bearing DE: vRMS alarm level violated (4.51 > 3.50 mm/s). Speed: 1001.9 rpm.	In
2012-01-01	08:04:02	Warning	VIB1 Bearing DE: vRMS warning level violated (4.51 > 2.50 mm/s). Speed: 1001.9 rpm.	In
2012-01-01	08:04:02	Warning	VIB1 Bearing DE: aRMS warning level violated (1.07 > 0.80 mm/s). Speed: 1001.9 rpm.	In

System messages

System messages are triggered by internal conditions or by faults in the system/device.

Example:

Date	Time	Type	Text	Action
2012-01-01	08:03:49	Info	Operating mode RUN-Monitoring (user command).	In

Message status

Messages can have the following states:

Message status	Description
Coming (active)	Example: A warning limit has been exceeded.
Going (inactive)	Example: A previously overshoot warning limit has been undershot again. A message can also be set to the "going" status automatically by the system, e.g. when entering STOP mode.

Viewing active messages

You can view messages that are currently pending on the "Pending messages" (Page 127) web page.

Viewing the message log

The process and system messages are stored in a message log and displayed on the "Message log" (Page 128) page.

The message log can hold approximately 50,000 entries. If more messages occur, the oldest data will automatically be overwritten.

The message log is also retained if the voltage is switched Off/On.

6.7 Status and actual displays

You can obtain information about the current state of the device/system/process as follows:

LEDs

The LEDs on the SM 1281 provide information about the current operating mode of the device and about the parts of the plant being monitored.

For information on the meaning of the LED displays, see section LED status display (Page 167).

S7 diagnostics alarms

The S7 controller displays important events or faults of the S7 system in the diagnostic buffer.

Information on this can be found in Chapter S7 diagnostics alarms (Page 168).

SM 1281 web pages

On the "Home page (Page 116)" and on the page "Pending messages (Page 127)", you will find up-to-date status information about the system and the process. You can view the current measured values of the system on the page "Actual values (Page 118)". The current operating state of the device is displayed in the header area of each Web site.

Status values

Important status information is also provided in the S7 in the DB SM1281_Status (Page 93).

6.8 Recording data

6.8.1 Recording data: Trends

Trend charts

Valid measured variables of vRMS, aRMS and speed are automatically stored as trends in RUN mode. Minimum, maximum, and average values are recorded for every measured variable.

The trend values are stored with time resolutions that are permanently stored in the system. For each time resolution, the data are stored in a circular buffer, that is, the oldest data are overwritten when the maximum size of the circular buffer has been reached.

More recent data are available to the user with a high time resolution; older data, with a lower time resolution.

Note

Trend data is only displayed for the selected time period if the duration in the RUN states is greater than the resolution of the selected time period.

The time periods are available for visualization with the following resolutions:

Maximum period	Resolution
Last day	1 minute
Last week	10 minutes
Last month	30 minutes
Last 6 months	3 hours
Last 10 years	24 hours

6.8.2 Recording data: Fingerprints

This function enables you to record the condition of a machine. For this purpose, the calculated spectra of an IEPE channel can be stored as "Fingerprint". Up to 100 fingerprints can be stored in the device.

Composition of a fingerprint

The stored fingerprint contains time-synchronous data. It is made up of the following data:

- Frequency spectrum
- Associated speed
- Further frequency spectra on the same IEPE channel; i.e. if available, all three frequency spectra that were calculated simultaneously - vibration velocity, vibration acceleration, and envelope of the IEPE channel - are stored
- RMS characteristic values calculated at the same time on the same IEPE channel (if present)

6.8.3 Recording raw data

The SM 1281 can save raw data in the form of WAV files. The raw data contains high-resolution recordings of the vibration inputs of the device and the speed. The recorded raw data contains the data of the last seconds before the initiating event. The duration of the recording can be set. You can use the raw data for further analyses, e.g. with SIPLUS CMS X-Tools.

- In principle, all of the configured vibration channels are recorded.
- The duration of raw data recording can be parameterized in the range 1 to 90 seconds for vibration channels. The setting applies for all of the configured channels.

You can parameterize the recording on the web page "General" (Page 149).

Note

If an encoder is connected to the digital input of the SM 1281, then the falling edge of the speed signal is displayed with an approximate 420 µs delay in the raw data recording.

Triggering raw data recording

Raw data recording can be triggered by three events:

- **A limit value violation:**

It can be determined for each channel or for each analysis method of a vibration channel whether a limit violation will result in the recording of raw data.

In this way, up to three raw data recordings are possible for each limit value and IEPE channel during a RUN phase. This serves to protect the internal flash memory, so that raw data recording is not performed continuously in the case of limit value violations that constantly come and go.

- **User command:**

On the web page "Actual values (Page 118)", you can start raw data recording directly using a button. All vibration channels, including speed, being acquired are recorded.

Note

Error message

If, after a switch of the operating mode from "STOP: System ready" to "RUN: Monitoring", you attempt too quickly to start raw data recording, the following error message appears: No or not enough raw data available to be recorded. Error code: 151".

- **Request via the S7 user program**

Recording starts after raw data recording has been triggered and ends after the parameterized duration.

The filename of the generated raw data file is automatically generated by the system and contains:

- Date and time
- Device name
- Recorded vibration channels

Raw data records are logged in the message log.

Downloading of raw data files

You can download the recorded raw data files in one of the following ways:

- via the web page Save and restore (Page 152)
- via WebDAV (see Chapter Data transfer over WebDAV (Page 55))
- via FTP (see Chapter Data exchange via FTP (Page 57))

6.9 Self-monitoring of the system

The SM 1281 has functions for self-monitoring that ensure a high level of reliability of the system in continuous operation.

Self-test

The SM 1281 performs a self-test during start-up. If an error occurs, the device will enter the Operating mode: "ERROR: System not ready" (Page 173).

Watchdog

The SM 1281 has a watchdog function that prevents the system from being in an undefined operating mode.

Note

In the event of an error, the system goes into a safe state, in which no measurements or monitoring tasks are carried out.

The Ethernet switch functionality is retained.

Measured value acquisition

To ensure that only meaningful and valid measured values are included in the evaluation, the following functions are implemented:

- Signal quality: Evaluation of the recorded vibration signals by the SM 1281. A system message is output if the signal quality is inadequate.
- Speed quality: If unstable or too high/too low speed repeatedly prevents vibration analysis, a system message is output.

If data acquisition is disturbed, monitoring is no longer performed on the affected channel.

6.10 Time keeping

The data and time are provided and managed automatically by the S7-1200 CPU.

The operating system of the SM 1281 contains its own time keeping, which is constantly synchronized by the S7. This time keeping is used for various functions, e.g. message system, trend recording.

You can make the time settings in the TIA Portal, see System Manual S7-1200 automation technology (<https://support.industry.siemens.com/cs/document/36932465/simatic-s7-s7-1200-programmable-controller?dti=0&dl=en&lc=de-WW>).

6.11 Data transfer over WebDAV

Functions

Exchanging data

Via WebDAV, files can be transferred to the device or downloaded from the device. Typical applications include:

- Download/delete the recorded raw data files (WAV files)
- Firmware updates
- Upload parameter settings or historic data to restore a backed-up stated.

It is not possible to download parameter settings and historical data via WebDAV. This is done using the functions on page Save and restore (Page 152).

Information on using WebDAV

Note

- Only import files that have been exported from an SM 1281 device or which are permitted for SM 1281. These files may only be copied into the WebDAV directories provided for this purpose.
 - Do not use WebDAV to change file names. This can cause error messages in the system.
 - Only use WebDAV for importing/exporting the files intended for WebDAV: configuration data, recording data, firmware update.
 - The system only imports data which you have loaded onto the SM 1281 via WebDAV after a restart.
 - A WebDAV access to an SM 1281 via a domain PC is not possible.
-

Adding WebDAV as drives

Proceed as follows under Windows:

1. Open Windows Explorer.
2. Under "Tools," click "Map Network Drive...".
The "Map Network Drive" window will open.
 - Select a free drive letter in the "Drive:" selection box.
 - Select the path that should be connected as a network drive in the "Folder:" selection box. Use a path from the table below.

Paths

Via WebDAV, you can access the following directories on the SM 1281:

Table 6- 3 Access via WebDAV

Contents	Path	Description
Parameters	\\<IP-Adresse>\config	All the parameter databases for the device are located here.
Historical data	\\<IP-Adresse>\history	The databases for historical data and messages are located here.
Directory for firmware update files	\\<IP-Adresse>\update	Firmware update files are copied to this location.
Directory for raw data	\\<IP-Adresse>\rawdata	Here, you will find the recorded raw data files

Access to an higher-level directory is not possible. Use access via FTP for this purpose.

Authentication

Importing of files to the device via WebDAV is secured by an additional authentication.

Table 6- 4 Authentication

User name	The user name is the standard login name "admin"
Password	The valid password is the one that was most recently set in the device administration on the " General" (Page 149) web page. If the password was not changed here, the default password "0000" (four times "zero") applies.

Error message "Network error"

If the authentication is rejected with the error message "Network error", then check whether the PC is in an Active Directory (AD) of a domain. A WebDAV access to an SM 1281 via a domain PC is not possible.

Constraints

Note

Note that you may only load files on the device in **STOP operating mode**.

You can also download raw data files in RUN mode.

NOTICE**Data exchange errors due to incorrect time setting**

WebDAV accesses always contain a file comparison. Therefore ensure the correct time setting on the device and on the PC used for accessing. Otherwise this can lead to undesirable effects on exchanging data. Older versions of files can be erroneously regarded as the current version. So the wrong files may be saved or read.

6.12 Data exchange via FTP

Instead of the WebDAV access (Page 55), you can alternatively access the SM 1281 via FTP (File Transfer Protocol).

Establishing a connection, and authentication

There are two methods for establishing a connection via FTP in the Windows Explorer:

"ftp://admin@<IP address><Path>"

Example: "ftp://admin@192.168.1.200/config"

Then a dialog appears for entering the password.

"ftp://admin:<Password>@<IP address><Path>"

Example: "ftp://admin:0000@192.168.1.200/config"

The password is already included here and permits immediate access to the device.

Note

Note that you may only load files on the device in **STOP operating mode**.

You can also download raw data files in RUN mode.

Paths

Via FTP, you can access the following directories on the SM 1281:

Table 6- 5 Access via FTP

Content	Path	Description
Parameter	/config	All the parameter databases for the device are located here.
Historical data	/history	The databases for historical data and messages are located here.
Directory for firmware update files	/update	Firmware update files are copied to this location.
Directory for raw data	/rawdata	Here, you will find the recorded raw data files

Application planning

7.1 Shipping

NOTICE**Damage to the device**

The device can be damaged by inappropriate shipping.

Transport the device, therefore, only in the original packaging. This will give it the necessary protection against shock and impact.

7.2 Storage

It is absolutely essential that the SM 1281 is stored in compliance with the storage conditions as described in Chapter Technical data (Page 174). In the event of ingress of dirt or liquid into the equipment, formation of condensation, damage or any other failures to comply with the prescribed storage conditions, the equipment must not be commissioned until the correct remedial procedure has been discussed with Siemens AG.

7.3 Scope of delivery

- SM 1281

Unpacking and checking the delivery

1. Unpack the device.
2. Make sure that the package is complete.
3. Check the device for transport damage by visual inspection.

Accessories for SM 1281 are not included in the scope of supply. You can order (Page 37) the accessories separately.

NOTICE**Damage to the system**

Damaged parts can result in damage to the system. Do not use any parts that show evidence of damage!

7.4 Installation location

The product is designed for use in an industrial environment.

The device is only suitable for indoor use.

Note

Installation in control cabinet/device connection box

The SM 1281 is intended for installation in a control cabinet or a device connection box.

- In these cases, the LEDs on the front of the device will remain visible and usable only during commissioning. Please take this into consideration for subsequent operation of the device.
 - It is important to note that installation in a control cabinet or a device connection box is essential for compliance with the UL regulations.
 - The control cabinet / device connection box must satisfy the regulations regarding fire-protection housing.
 - Ensure that all cables and leads that protrude externally are equipped with adequate strain relief.
-

Also note the installation guidelines in the System Manual S7-1200 automation technology (<https://support.industry.siemens.com/cs/document/36932465/simatic-s7-s7-1200-programmable-controller?dti=0&dl=en&lc=de-WW>).

Electromagnetic compatibility (EMC)

NOTICE
Damage to the device Inadequately dimensioned overvoltage protection can result in severe damage to the device. Therefore ensure that the overvoltage protection is adequate (see Chapter Technical data (Page 174)). To do this, use the shield clamp set (see Order data (Page 37)) or take comparable actions.

Selection of the installation site / mounting position

The device can be mounted in a standard mounting rail.

- Permitted mounting positions: horizontal or vertical
- Permissible ambient temperature:
 - Horizontal installation: -20 °C to 55 °C
 - Vertical installation: -20 °C to 45 °C

Maintain the minimum clearances from walls and other devices:

Sides 0 mm, top 40 mm, bottom 25 mm for ventilation

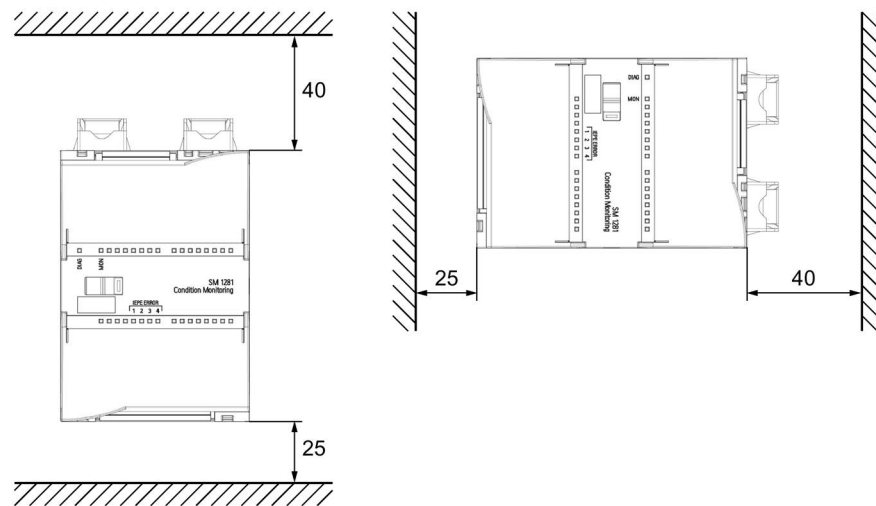

Image 7-1 Minimum clearances with horizontal and vertical installation

Note the following device dimensions in this regard:

Table 7- 1 Device dimensions

Dimensions	
Width	70 mm
Height	112 mm
Depth	75 mm

NOTICE
<p>Damage due to overheating</p> <p>You must comply with all the instructions regarding the installation location and mounting position. Otherwise the device may malfunction or incur permanent damage as a result of overheating.</p>

Mounting

8.1 Mounting the SM 1281

The SM 1281 can be mounted on a 35 mm standard mounting rail according to DIN EN 60715.

Permitted mounting positions: horizontal and vertical

Procedure

Instructions and guidelines for the installation and removal of modules can be found in the System Manual S7-1200 automation system

(<https://support.industry.siemens.com/cs/document/36932465/simatic-s7-s7-1200-programmable-controller?dti=0&dl=en&lc=de-WW>).

Note

For better handling, maintain a distance of 50 to 60 mm between the SM 1281 and the cable duct.

8.2 Mounting the shield clamps

SM 1281 shield clamp set

The shield clamp set is used for the EMC-compliant connection of signal and encoder cables to the SM 1281.

The set contains 2 shield clamps, five terminal clamps, and one copy of the Compact Hardware Installation Instructions. It can be ordered as accessory (6AT8007-1AA20-0AA0).

- Shield clamp top: Grounding of the cable shield for the speed sensor
- Shield clamp bottom: Grounding of the cable shields for the IEPE sensors

Note

Do not use the terminal clamps as strain relief!

Procedure

Screw the shield clamps to the mounting plate above and below the top-hat rail.

The permissible distance between the module and the shield clamp is a minimum of 30 mm and a maximum of 45 mm.

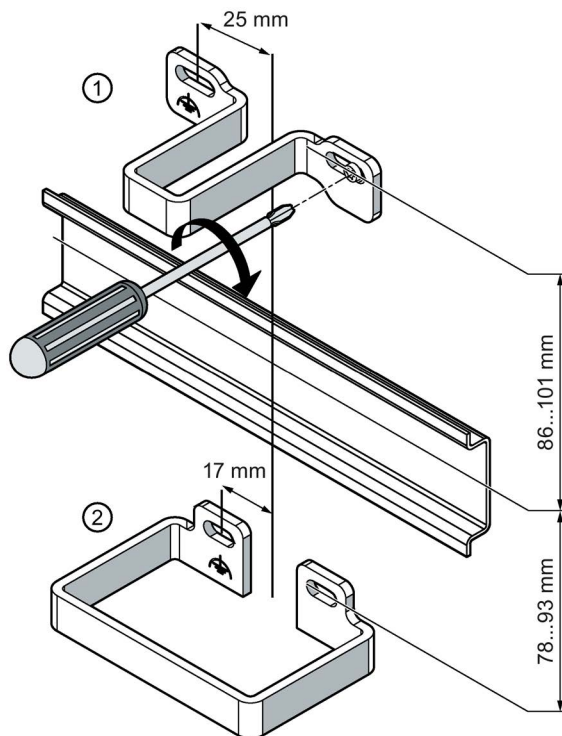

- ① Upper shield clamp for 1 speed sensor terminal clamp
- ② Shield clamp for 4 IEPE input terminal clamps

See also

Connecting to functional ground (Page 73)

Connection

9.1 Safety instructions and guidelines

Safety instructions

 CAUTION
Safe electrical isolation For the 24 V DC power supply, use only power supply units with safe electrical isolation in accordance with IEC 60364-4-41 or HD 384.04.41 (VDE 0100, Part 410), for example, in accordance with the PELV standard. The supply voltage must be within the specified voltage range. Otherwise, function failures on the device cannot be excluded. Applies to non-isolated system design: Connect the terminal for GND 24 V from the 24 V power supply output to equipotential bonding for uniform reference potential. Select a connection point that is as central as possible.

Wiring guidelines

General guidelines for the wiring of S7-1200 system components can be found in the S7-1200 Automation System System Manual (Page 10).

Cable routing and grounding

Note

Interference due to incorrect cable routing

Route all analog signals (VIB1 to VIB4) spatially isolated from other cables to ensure that the measurement signals can be transmitted without interference.

Maintain this spatial separation throughout the entire cable route. This is the only way to provide optimal EMC protection.

Note

Electromagnetic interference

Make sure that adequate equipotential bonding is implemented for all plants or systems in which the SM 1281 is installed. E.g. by means of a low-impedance connection to a ground potential.

Note

Securing the cable shielding

The permissible distance between the module and the shield clamp is a minimum of 30 mm and a maximum of 45 mm.

Use the shield clamp set, which is available as accessory.

Note

Strain relief

Ensure that all cables and leads that protrude externally are equipped with adequate strain relief.

Other requirements

NOTICE
Damaged cables <ul style="list-style-type: none">• The cables must be suitably dimensioned to ensure that they cannot be damaged. Make sure that the cables are suitable for the individual application.• Observe the bending radii.
 CAUTION
The cables must be specified for an ambient temperature of +75 °C. ATTENTION: Utiliser des fils d'alimentation qui conviennent à une température de +75 °C au-dessus de la température ambiante.

9.2 Terminal assignment

The figure below shows the connecting terminals of the device and the associated block diagram:

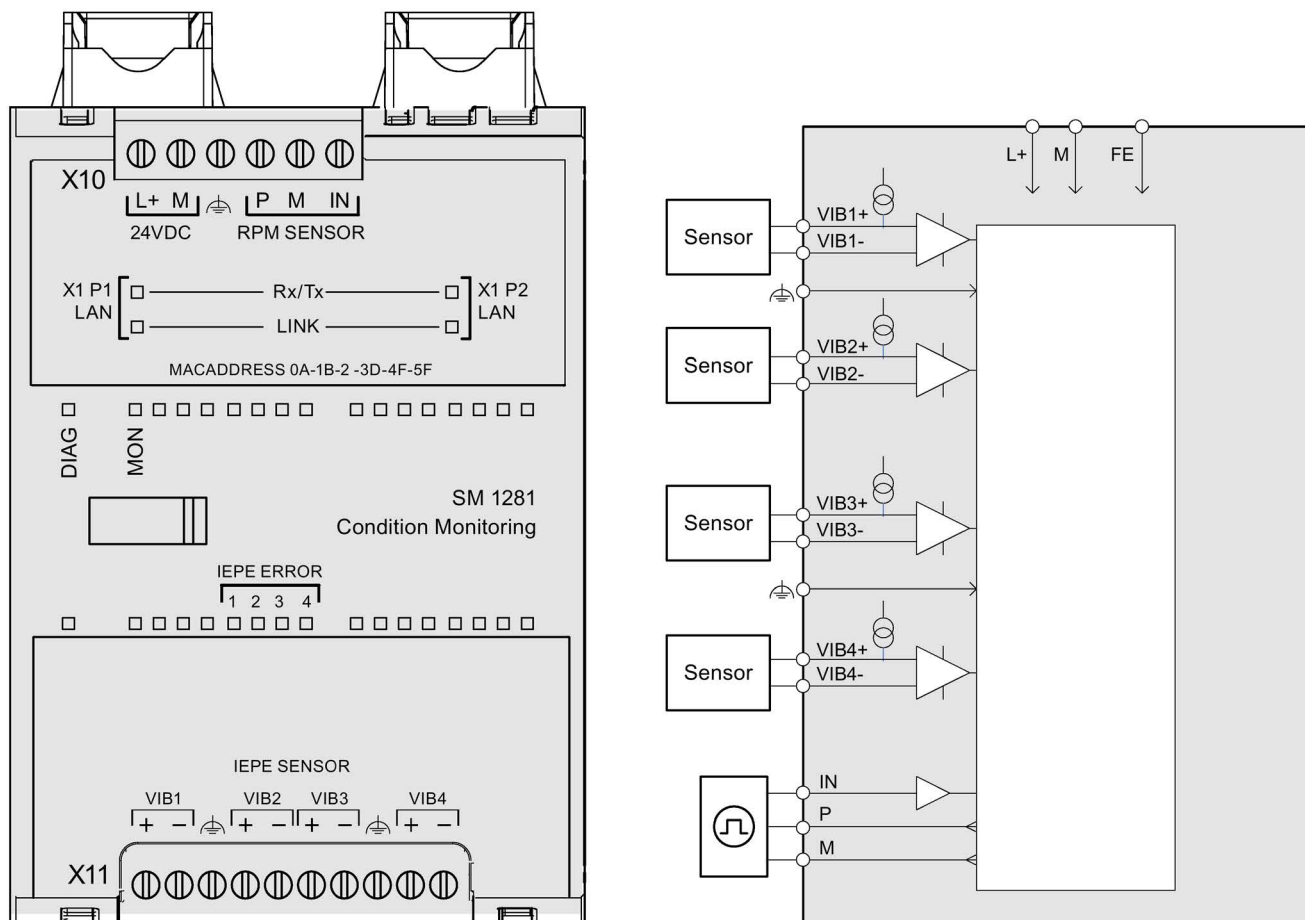

Image 9-1 Connection diagram and block diagram

Terminal assignment X10			
24 V DC power supply		RPM sensor (digital speed input)	
L+	24 V supply for SM 1281 (+)	P	24 V supply for speed sensor (+)
M	24 V supply for SM 1281 (-)	M	24 V supply for speed sensor (-)
PE	Functional grounding "Module"	IN	Digital input

Terminal assignment X11			
VIB1+	IEPE sensor input 1	VIB3+	IEPE sensor input 3
VIB1-	IEPE sensor input 1	VIB3-	IEPE sensor input 3
PE	Functional grounding VIB	PE	Functional grounding VIB
VIB2+	IEPE sensor input 2	VIB4+	IEPE sensor input 4
VIB2-	IEPE sensor input 2	VIB4-	IEPE sensor input 4

9.3 Attaching the cable shield

The following SM 1281 process signals must be connected via shielded cables:

- Speed sensor
- Sensor signals (VIB 1 to VIB 4)

The shields of the cables must be attached to the upper and/or lower shield clamps using the terminal connections. The shield clamp set can be ordered as an accessory (see Chapter Ordering data (Page 37)).

Proceed as follows:

1. Strip the cable.

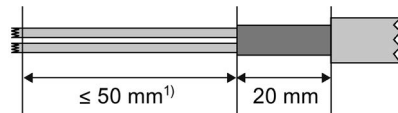

¹) The length depends on the distance between the shield clamp and the device.

2. Press the terminal clamps onto the protective braided shield of the cable.

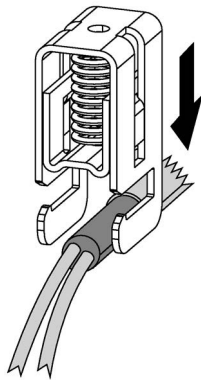

3. Slide the terminal clamps with cables onto the shield clamp.

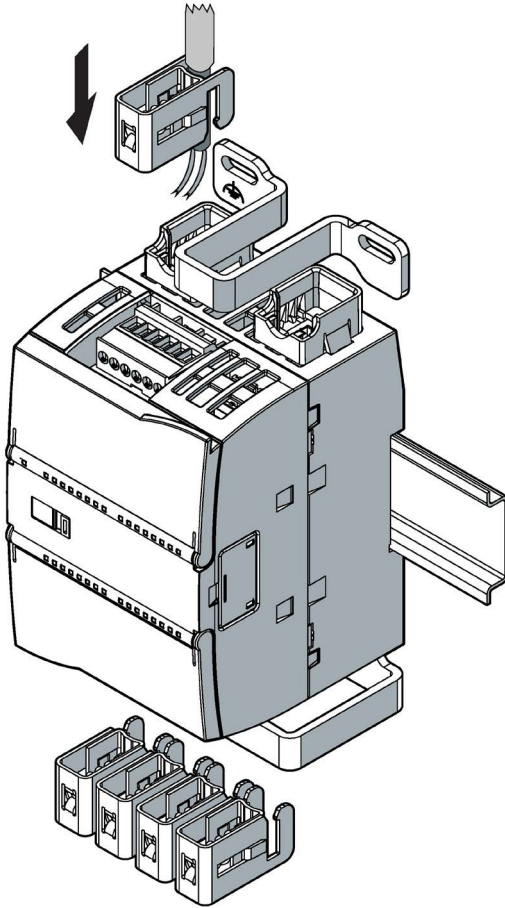

4. The result should look like this:

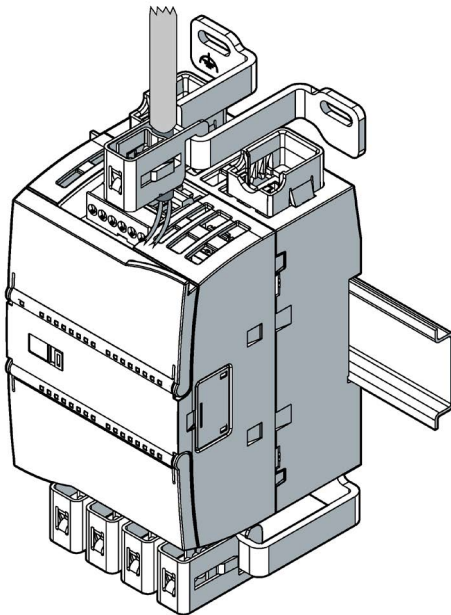

Setup with several SM 1281 modules

If you use several SM 1281 modules in your setup, then equivalent grounding of the cable shields is permitted, e.g. via a grounding rail.

9.4 24 V DC power supply

24 V DC power supply

An external 24 V DC power supply is connected to the SM 1281 via plug-in terminals. Purpose of the power supply:

- Power supply for the internal electronics of the SM 1281
- Constant power supply of the IEPE sensors
- Supply of the encoders for the digital speed input

The SIMATIC S7-1200 Power Supply PM1207 (6EP1332-1SH71) is suitable.

Safety instructions

 **CAUTION**

Safe electrical isolation

For the 24 V DC power supply, use only power supply units with safe electrical isolation in accordance with IEC 60364-4-41 or HD 384.04.41 (VDE 0100, Part 410), for example, in accordance with the PELV standard.

The supply voltage must be within the specified voltage range. Otherwise, function failures on the device cannot be excluded.



Applies to non-isolated system design:

Connect the terminal for GND 24 V from the 24 V power supply output to equipotential bonding for uniform reference potential. Select a connection point that is as central as possible.

Connector pin assignment

The following figure shows the assignment of the terminals for the 24 V DC power supply on X10.

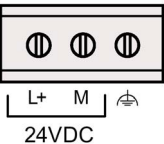
Table 9- 1 Terminal assignment for the 24 V DC power supply on X10

	L+	24 V supply for SM 1281 (+)
	M	24 V supply for SM 1281 (-)
		Functional grounding

9.5 Connecting sensors

<p>⚠ WARNING</p> <p>Voltage hazards</p> <p>May cause death or serious injury</p> <p>The inputs of the SM1281 feature functional electrical isolation up to 500 V.</p> <p>Only those sensors may be used that ensure safe electrical isolation up to the maximum level of the potentials configured for the plant.</p> <p>It is imperative that you observe the insulation values of the sensors used and take additional measures, if required, to ensure safe electrical isolation.</p>

<p>NOTICE</p> <p>Material damage</p> <p>Connecting sensors during operation can lead to damage to the sensors and the device.</p> <p>De-energize the system before you connect or replace sensors.</p>
--

9.5.1 IEPE sensors

You can use all IEPE sensors (Integrated Electronics Piezo-Electric) that fulfill the specification for the relevant sensor inputs VIB1 to VIB4. We recommend that you use sensors from the Siemens portfolio (see Section Ordering data (Page 37)).

NOTICE

The maximum allowable wire length for the connection of IEPE sensors is 30 m.

Connector pin assignment

The following figure shows the terminal assignment for IEPE sensors on X11.

Table 9-2 Terminal assignment for IEPE sensors on X11

	VIB1	IEPE sensor input 1
		Functional grounding
	VIB2	IEPE sensor input 2
	VIB3	IEPE sensor input 3
		Functional grounding
	VIB4	IEPE sensor input 4

Measuring principle

The sensors are supplied by a constant current and form an operation point from this constant current that is comparable to a fixed resistor. For the SM 1281, the basis of this constant current source is the external 24 V power supply.

A Piezo crystal in the IEPE sensor generates a voltage signal proportional to the vibration acceleration. The signal is modulated up to the operation point with a sensor-dependent amplification, comparable to a variable resistor. The supply current and the measured signal are transmitted via the measurement cables (2-wire connection).

Measuring range of the SM 1281

NOTICE

The measuring range of the SM 1281 is limited to the input voltage range of 6.2 V to 15.0 V. Values <6.2 V and values >15.0 V are flagged by the SM 1281 as invalid values and are not included in the evaluation.

You can check the operation point of the IEPE sensors you used with the aid of the operating mode "RUN: System diagnostics" (Page 39).

9.5.2 Speed sensors

Speed sensor

A speed sensor can be connected to the "RPM Sensor" terminal.

Connector pin assignment

The following figure shows the terminal assignment for the speed encoder on X10.

Table 9- 3 Terminal assignment for the speed encoder on X10

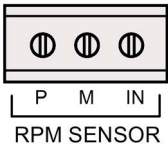
 <p>P M IN RPM SENSOR</p>	P	24 V supply for speed sensor (+)
	M	24 V supply for speed sensor (-)
	IN	Digital input

9.6 Connecting to functional ground

Prerequisites

- The mounting plate must not be painted in the contact area of the shield clamps and must be connected at low-impedance to the cabinet ground.
- The conductor cross-section must be 2 mm² (AWG14).
- Ensure that the cable for the functional grounding is as short as possible.
- The functional grounding (FE) must not be made using a green/yellow conductor.

Procedure

Connect all terminals with the symbol  (see Terminal assignment (Page 67)) to the screw connections of the shield clamps.

Use ring cable lugs for connecting the cables to the shield clamps.

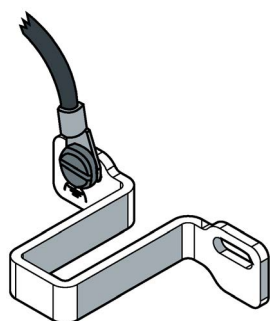

9.7 Connecting Ethernet

The SM 1281 is equipped with an integrated Ethernet switch with 2 ports. The connections are designed as RJ45 sockets.

For the increased mechanical and electrical stress in industrial applications, we recommend the SIMATIC NET Industrial Ethernet FastConnect Twisted Pair Standard Cable with Fast Connect connections.

To increase the mechanical stability, in the delivery condition, retaining collars for the two Ethernet ports are attached on the lower part of the enclosure of the SM 1281, which are optimized for the SIMATIC NET Fast Connect RJ45 connection plugs.

 CAUTION
Critical system state
The Ethernet switch that is built into the SM 1281 is only in operation after the module is started up. A restart of the SM 1281 interrupts the Ethernet switch function.
As a result, existing Ethernet connections via the switch are interrupted for the duration of the start-up of the SM 1281. This can lead to critical system states.

Pin assignment for Industrial Ethernet interfaces

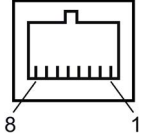
Industrial Ethernet	Pin	Pin assignment
	1	Transmit Data (+)
	2	Transmit Data (-)
	3	Receive Data (+)
	4	Terminated
	5	Terminated
	6	Receive Data (-)
	7	Terminated
	8	Terminated

Note

It is only permitted to connect shielded CAT5 cables (or cables of a higher standard) to the Ethernet socket.

Commissioning

10.1 Commissioning of SM 1281 Condition Monitoring

Prerequisites

- The SM 1281 is mounted and connected to the SIMATIC S7-1200 CPU via the bus connector (see S7-1200 Automation System System Manual (<http://w3.siemens.com/mcms/industrial-automation-systems-simatic/en/manual-overview/Pages/Default.aspx>)).
- The shield clamps are fitted (see Section Mounting the shield clamps (Page 64)).
- The sensors are installed.
- The SM 1281 and all other components are wired and connected.
- STEP 7 V13 SP1 Update 4 or higher is installed.

Basic commissioning procedure

After the commissioning of the hardware, carry out the additional steps for commissioning in the TIA Portal, in the S7 user program, and on the SM 1281 websites.

TIA Portal

1. Check in the TIA Portal whether the module "SM 1281" is available in the hardware catalog.
If required, download the HSP SM 1281 Condition Monitoring from the Siemens Service&Support area (<https://support.industry.siemens.com/cs/?lc=en-DE>) and install it.
 2. Integrating the SM 1281 library (Page 77) in STEP 7
 3. Creating a project
 4. Creating HW Config
 5. Linking function blocks from the SM 1281 library to the user program.
 6. Activate power supply
The SM 1281 starts up. The DIAG LED illuminates green and signals that the device is in the error-free operating state.
 7. Load project on the S7-1200 CPU
 8. Optional: Create HMI interface for the visualization and control of the vibration monitoring with SM 1281 (TIA Portal WinCC required. Recommended: visualization via Comfort Panels or PC Runtime).
- ⇒ The engineering in the TIA Portal is completed.

S7 user program

In the S7 user program, carry out the parameterization and start the monitoring:

1. Assign values to the module parameters, e.g. IP address, sensor sensitivity.
2. Assign values to the process parameters (RMS hysteresis).
3. Assign values to the dynamic process parameters (RMS limit values).
4. Transfer the parameters to the SM 1281 module via the `SetAllParameters` command.
5. Via the parameter `OpMode`, select the operating mode "RUN: Monitoring" and use the command `ActivateOpMode` command to switch the operating mode.

⇒ **The SM 1281 is in monitoring mode. It reports limit value violations of the process values `vRMS` and `aRMS` to the S7 controller.**

SM 1281 web pages

The SM 1281 web pages can only be selected via a supported browser with the set IP address:

1. Make (Page 129) settings for the frequency-selective monitoring.

⇒ **Parameterization has been completed.**

Result

The SM 1281 Condition Monitoring has been successfully put into operation.

Backup

Recommendation: Perform a data backup following commissioning:

1. Back up the limit values parameterized in the S7 user program, see Function blocks (Page 78).
2. Back up the CMS databases of the module, e.g. via download on the SM 1281 website "Save and restore" (Page 152).

Integrating functions with the SM 1281 library

11.1 Function of the SM 1281 library

The SM 1281 signal module comes with the library "SM1281_Library" with STEP 7 blocks. The library permits the easy integration of the SM 1281 functions into your control program.

With the STEP 7 blocks from the "SM1281_Library", you can parameterize, control, and diagnose the SM 1281 configured in the device configuration in the TIA Portal.

The blocks in the "SM1281_Library" provide the following functions:

- Parameterization of the SM 1281
- Output of status and traffic light information
- Changing the operating mode
- Request fingerprint and raw data recording and output status information about the recording
- Automatic backup of valid parameter sets

Depending on the S7-1200 CPU used, up to seven SM 1281 signal modules can be integrated in the control program with the help of the blocks.

11.2 Software and hardware requirements

To be able to use the functionality of the library, the following hardware and software requirements must be complied with:

Component	Article number	Number	Alternative
CPU S7-1215C Variant: DC/DC/DC	6ES7215-1AG40-0XB0	1	SIMATIC S7-1200 CPUs FW 4.1 or higher (exception: The S7-1211 does not support further signal modules)
SM 1281 Condition Monitoring	6AT8007-1AA10-0AA0	1 to 7	
SIMATIC STEP 7 Basic V13 SP1	6ES7822-0AA03-0YA5	1	SIMATIC STEP 7 Professional V13 SP1

Mixed operation with SM 1281 modules and S7-1200 modules is permissible.

11.3 Library resources

Blocks of the library "SM1281_Library"	Assignment in work memory
SM1281_Module	6450 bytes (+ 244 bytes per instance data block)
SM1281_Channel	3925 bytes
SM1281_Status	428 bytes (+ 320 bytes per additional module)
SM1281_Backup	284 bytes (+ 176 bytes per additional module)
Overall assignment	approx. 11.3 KB

11.4 Blocks

The "SM1281_Library" contains the following blocks:

Type	Symbol	Description
Function block	SM1281_Module (Page 79)	Using the FB SM 1281_Module, the general module settings can be made and the status messages of the module can be monitored.
Function	SM1281_Channel (Page 88)	The FC SM1281_Channel can be assigned to a channel of the SM 1281. It permits the parameter assignment and monitoring of the corresponding vibration channel.
Global data block	SM1281_Status (Page 92)	The DB SM1281_Status provides all of the feedback messages, status and traffic light information of the SM 1281 in a structured manner.
Global data block	SM1281_Backup (Page 95)	The DB SM1281_Backup serves as memory for the automatic backup of parameter sets.

Description

The blocks "SM1281_Module" and "SM1281_Channel" are absolutely essential for operating the SM 1281. They permits the parameter assignment and status monitoring of the module.

The parameters which are set via the blocks cannot be changed via the web server of the SM 1281.

The SM 1281 has module-specific and channel-specific settings and diagnostic information. The IP configuration, the selection and the feedback message about the current operating mode are module-specific, for example. The four vibration channels of the SM 1281, to which acceleration sensors for machine monitoring can be connected, are channel-specific.

11.4.1 FB SM1281_Module

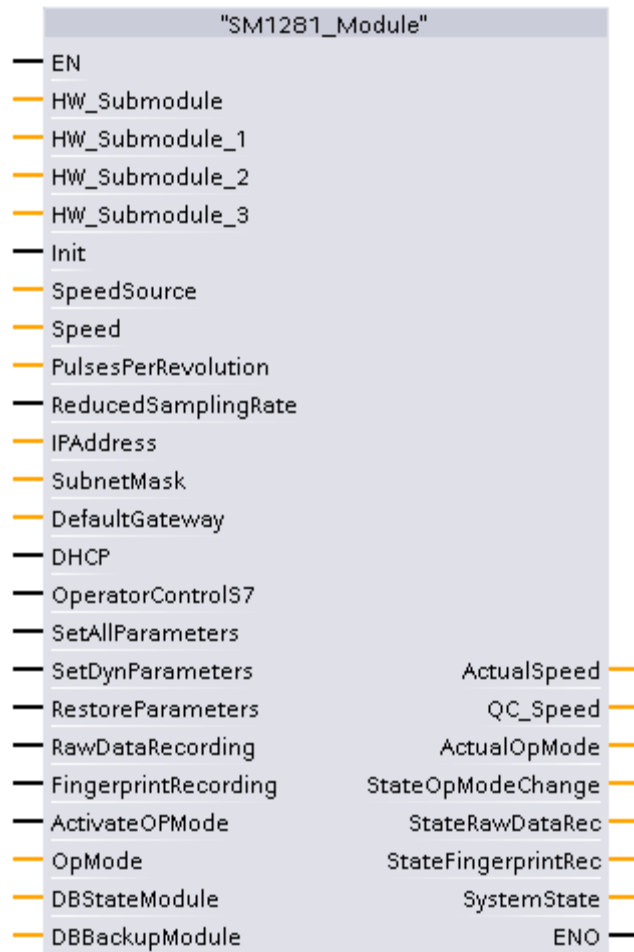

Image 11-1 FB SM1281_Module

Function

The "SM1281_Module" block offers the following functions:

- IP configuration of the SM 1281 module
- Speed configuration
- Transfer module and channel parameters to the SM 1281
- Request fingerprint and raw data recording
- Restore the parameter set
- Output module status and error information
- Select the operating mode of the SM 1281
- Switch the control priority between S7-1200 and SM 1281 webserver

NOTICE

Inconsistent data when transferring parameters

If the command `SetAllParameters` is interrupted by another command before it is successfully completed, inconsistencies may occur between the FB "SM1281_Module" and the DB "SM1281_Backup" due to the automatic operating mode switching.

Therefore, only execute one command at a time via the FB "SM1281_Module"!

References

The operation of the block is explained in Chapter Using blocks (Page 103) with the aid of use cases.

You can find the meanings of the parameters and of the error and status codes in the following tables.

11.4.1.1 FB SM1281_Module - Parameters

Input parameters

Table 11- 1 FB SM1281_Module - input parameters

Parameters	Data type	Description
HW_Submodule	HW_SUBMODULE	Assignment to the first submodule of the SM 1281 in the device configuration
HW_Submodule_1	HW_SUBMODULE	Assignment to the second submodule of the SM 1281 in the device configuration
HW_Submodule_2	HW_SUBMODULE	Assignment to the third submodule of the SM 1281 in the device configuration
HW_Submodule_3	HW_SUBMODULE	Assignment to the fourth submodule of the SM 1281 in the device configuration
Init	Bool	The SM 1281 is initialized via this input during the warm restart of the CPU. This input should be connected with the "FirstScan" system flag.
SpeedSource	Byte	Selection of the speed source: 1: S7-1200 2: DI - Digital input of the SM 1281
Speed	Real	Speed value (rms) from S7-1200 (when used, the parameter <code>SpeedSource</code> must be "1")
PulsesPerRevolution	UInt	Pulses per revolution if the DI of the SM 1281 is used as speed source. Then a value between 1 and 100 must be specified here.
ReducedSamplingRate	Bool	Use low-frequency RMS monitoring for all channels.
IPAddress	DWord	IP address of the SM 1281 (hex-coded) Example IP 192.168.0.1: Decimal 192 → Hex C0 Decimal 168 → Hex A8 Decimal 0 → Hex 00 Decimal 1 → Hex 01 ⇒ DWord <code>IPAddress</code> = C0A80001
SubnetMask	DWord	Subnet mask of the SM 1281 (hex-coded) Example subnet mask 255.255.255.0: Decimal 255 → Hex FF Decimal 255 → Hex FF Decimal 255 → Hex FF Decimal 0 → Hex 00 ⇒ DWord <code>SubnetMask</code> = FFFFFFF0
DefaultGateway	DWord	Default gateway of the SM 1281 (hex-coded) Example IP 192.168.0.1: Decimal 192 → Hex C0 Decimal 168 → Hex A8 Decimal 0 → Hex 00 Decimal 254 → Hex FE ⇒ DWord <code>DefaultGateway</code> = C0A800FE
DHCP	Bool	Use of a DHCP server (automatic assignment of the IP address and subnet mask)

11.4 Blocks

Parameters	Data type	Description
OperatorControlS7	Bool	Write protection web interface of the SM 1281. True: The S7-1200 has the control priority. Thus, the web interface can no longer be edited. The user who is currently logged on to the SM 1281 Web server is automatically logged off. He can no longer log in as long as this bit is set. False: No commands are transferred from the S7-1200 to the SM 1281. This means that the SM 1281 can no longer be controlled via the blocks. Status, diagnostic and error information is still output via the blocks, however. This parameter is cyclically transferred to the SM 1281. The transfer of the parameter via <code>SetAllParameters</code> is thus not required.
SetAllParameters	Bool	All module and channel parameters are transferred to the SM 1281 with a positive edge.
SetDynParameters	Bool	All dynamic parameters are transferred to the SM 1281 with a positive edge.
RestoreParameters	Bool	Restore the last valid parameter set with a positive edge and transfer to the SM 1281
RawDataRecording	Bool	Request the recording of raw data
FingerprintRecording	Bool	Request fingerprint recording
ActivateOpMode	Bool	Activate the operating mode selected in the <code>OpMode</code> parameter.
OpMode	USInt	Preselection of the desired operating mode of the SM 1281. 0: STOP: System ready 1: RUN: Monitoring 2: RUN: Monitoring deactivated 3: RUN: Measuring 4: RUN: System diagnostics Values >4 are interpreted as 0 (STOP: System ready)

Input/output parameters

Table 11- 2 FB SM1281_Module - input/output parameters

Parameters	Data type	Description
DBStateModule	Struct	Reference to the module structure in the DB "SM1281_Status"
DBBackupModule	SM1281_Type_Modu leparameters	Reference to the module parameter structure in the DB "SM1281_Backup"

Output parameters

Table 11- 3 FB SM1281_Module - output parameters

Parameters	Data type	Description
ActualSpeed	Real	Current speed in revolutions per minute
QC_Speed	USInt	Qualifier for speed, see table QC_Speed (Page 91)
ActualOpMode	USInt	Current operating mode of the SM 1281
StateOpModeChange	USInt	Status of operating mode change
StateRawDataRec	USInt	Status of raw data recording
StateFingerprintRec	USInt	Status of fingerprint recording
SystemState	DWord	System state

Status and error displays ActualOpMode

Table 11- 4 FB SM1281_Module - Status and error displays ActualOpMode

Status	Meaning
0	System not ready
1	Shutdown
2	Initializing
3	IDLE: Wait for S7-1200
4	Error: System not ready
5	STOP: Configuration
6	STOP: System ready
7	RUN: System diagnostics
8	RUN: Measuring
9	RUN: Monitoring inhibited
10	RUN: Monitoring

Status and error displays StateOpModeChange

Table 11- 5 FB SM1281_Module - Status and error displays StateOpModeChange

Status	Meaning	Remedy / notes
0	Last change successful	-
1	Change detected, attempt is made to execute	-
2	Error IP configuration	Check IP configuration
3	Error VIB1: Sensitivity of sensor	Invalid parameter assignment - check parameters and load in SM 1281 with <code>SetAllParameters</code>
4	Error VIB1: Speed ratio	Invalid parameter assignment - check parameters and load in SM 1281 with <code>SetAllParameters</code>
5	Error VIB2: Sensitivity of sensor	Invalid parameter assignment - check parameters and load in SM 1281 with <code>SetAllParameters</code>
6	Error VIB2: Speed ratio	Invalid parameter assignment - check parameters and load in SM 1281 with <code>SetAllParameters</code>
7	Error VIB3: Sensitivity of sensor	Invalid parameter assignment - check parameters and load in SM 1281 with <code>SetAllParameters</code>
8	Error VIB3: Speed ratio	Invalid parameter assignment - check parameters and load in SM 1281 with <code>SetAllParameters</code>
9	Error VIB4: Sensitivity of sensor	Invalid parameter assignment - check parameters and load in SM 1281 with <code>SetAllParameters</code>
10	Error VIB4: Speed ratio	Invalid parameter assignment - check parameters and load in SM 1281 with <code>SetAllParameters</code>
11	Error VIB1: Limit value vRMS	Invalid parameter assignment - check parameters and load in SM 1281 with <code>SetAllParameters</code> OR <code>SetDynParameters</code>
12	Error VIB1: Limit value aRMS	Invalid parameter assignment - check parameters and load in SM 1281 with <code>SetAllParameters</code> OR <code>SetDynParameters</code>
13	Error VIB2: Limit value vRMS	Invalid parameter assignment - check parameters and load in SM 1281 with <code>SetAllParameters</code> OR <code>SetDynParameters</code>
14	Error VIB2: Limit value aRMS	Invalid parameter assignment - check parameters and load in SM 1281 with <code>SetAllParameters</code> OR <code>SetDynParameters</code>
15	Error VIB3: Limit value vRMS	Invalid parameter assignment - check parameters and load in SM 1281 with <code>SetAllParameters</code> OR <code>SetDynParameters</code>
16	Error VIB3: Limit value aRMS	Invalid parameter assignment - check parameters and load in SM 1281 with <code>SetAllParameters</code> OR <code>SetDynParameters</code>
17	Error VIB4: Limit value v-RMS	Invalid parameter assignment - check parameters and load in SM 1281 with <code>SetAllParameters</code> OR <code>SetDynParameters</code>
18	Error VIB4: Limit value aRMS	Invalid parameter assignment - check parameters and load in SM 1281 with <code>SetAllParameters</code> OR <code>SetDynParameters</code>
19	Error VIB1: Hysteresis vRMS	Invalid parameter assignment - check parameters and load in SM 1281 with <code>SetAllParameters</code>
20	Error VIB1: Hysteresis aRMS	Invalid parameter assignment - check parameters and load in SM 1281 with <code>SetAllParameters</code>
21	Error VIB2: Hysteresis vRMS	Invalid parameter assignment - check parameters and load in SM 1281 with <code>SetAllParameters</code>
22	Error VIB2: Hysteresis aRMS	Invalid parameter assignment - check parameters and load in SM 1281 with <code>SetAllParameters</code>

Status	Meaning	Remedy / notes
23	Error VIB3: Hysteresis vRMS	Invalid parameter assignment - check parameters and load in SM 1281 with <code>SetAllParameters</code>
24	Error VIB3: Hysteresis aRMS	Invalid parameter assignment - check parameters and load in SM 1281 with <code>SetAllParameters</code>
25	Error VIB4: Hysteresis vRMS	Invalid parameter assignment - check parameters and load in SM 1281 with <code>SetAllParameters</code>
26	Error VIB4: Hysteresis aRMS	Invalid parameter assignment - check parameters and load in SM 1281 with <code>SetAllParameters</code>
27	Error speed configuration	Invalid parameter assignment - check parameters and load in SM 1281 with <code>SetAllParameters</code>
28	Not assigned	-
29	Control priority S7 not active	The Web server has the control priority, therefore S7 cannot change the state.
30	Error VIB1: Filter combination vRMS	Invalid parameter assignment - check parameters and load in SM 1281 with <code>SetAllParameters</code>
31	Error VIB1: Filter combination aRMS	Invalid parameter assignment - check parameters and load in SM 1281 with <code>SetAllParameters</code>
32	Error VIB2: Filter combination vRMS	Invalid parameter assignment - check parameters and load in SM 1281 with <code>SetAllParameters</code>
33	Error VIB2: Filter combination aRMS	Invalid parameter assignment - check parameters and load in SM 1281 with <code>SetAllParameters</code>
34	Error VIB3: Filter combination vRMS	Invalid parameter assignment - check parameters and load in SM 1281 with <code>SetAllParameters</code>
35	Error VIB3: Filter combination aRMS	Invalid parameter assignment - check parameters and load in SM 1281 with <code>SetAllParameters</code>
36	Error VIB4: Filter combination vRMS	Invalid parameter assignment - check parameters and load in SM 1281 with <code>SetAllParameters</code>
37	Error VIB4: Filter combination aRMS	Invalid parameter assignment - check parameters and load in SM 1281 with <code>SetAllParameters</code>
38-254	Not assigned	-
255	Error CMS internal	Restart the device. If the error occurs again contact Siemens Customer Support.

Status and error displays StateFingerprintRec

Table 11- 6 FB SM1281_Module - Status and error displays StateFingerprintRec

Status	Meaning	Remedy / notes
0	IDLE	Status at startup
1	Recording ongoing	-
2	Last recording was successful	-
3	Error in the last recording	This error occurs if the control priority is not with the S7-1200 CPU, for example.

Status and error displays StateRawDataRec

Table 11- 7 FB SM1281_Module - Status and error displays StateRawDataRec

Status	Meaning	Remedy / notes
0	IDLE	Status at startup
1	Recording ongoing	-
2	Last recording was successful	-
3	Error in the last recording	This error occurs if the control priority is not with the S7-1200 CPU, for example.

Status and error displays SystemState

Table 11- 8 FB SM1281_Module - Status and error displays SystemState

Status (bit no.)	Meaning	Remedy / notes
0	VIB1: aRMS monitoring failed	Monitoring was not possible over a long period of time.
1	VIB2: aRMS monitoring failed	Monitoring was not possible over a long period of time.
2	VIB3: aRMS monitoring failed	Monitoring was not possible over a long period of time.
3	VIB4: aRMS monitoring failed	Monitoring was not possible over a long period of time.
4	VIB1: vRMS monitoring failed	Monitoring was not possible over a long period of time.
5	VIB2: vRMS monitoring failed	Monitoring was not possible over a long period of time.
6	VIB3: vRMS monitoring failed	Monitoring was not possible over a long period of time.
7	VIB4: vRMS monitoring failed	Monitoring was not possible over a long period of time.
8	VIB1: Monitoring of the acceleration spectrum failed	Monitoring was not possible over a long period of time.
9	VIB2: Monitoring of the acceleration spectrum failed	Monitoring was not possible over a long period of time.
10	VIB3: Monitoring of the acceleration spectrum failed	Monitoring was not possible over a long period of time.
11	VIB4: Monitoring of the acceleration spectrum failed	Monitoring was not possible over a long period of time.

Status (bit no.)	Meaning	Remedy / notes
12	VIB1: Monitoring of the velocity spectrum failed	Monitoring was not possible over a long period of time.
13	VIB2: Monitoring of the velocity spectrum failed	Monitoring was not possible over a long period of time.
14	VIB3: Monitoring of the velocity spectrum failed	Monitoring was not possible over a long period of time.
15	VIB4: Monitoring of the velocity spectrum failed	Monitoring was not possible over a long period of time.
16	VIB1: Monitoring of the envelope spectrum failed	Monitoring was not possible over a long period of time.
17	VIB2: Monitoring of the envelope spectrum failed	Monitoring was not possible over a long period of time.
18	VIB3: Monitoring of the envelope spectrum failed	Monitoring was not possible over a long period of time.
19	VIB4: Monitoring of the envelope spectrum failed	Monitoring was not possible over a long period of time.
20	Speed measurement failed	The speed measurement has failed.
21	Memory space critical	The memory space on the internal Flash is >90% full.
31	Internal error	

See also

FC SM1281_Channel - Parameters (Page 89)

11.4.2 FC SM1281_Channel

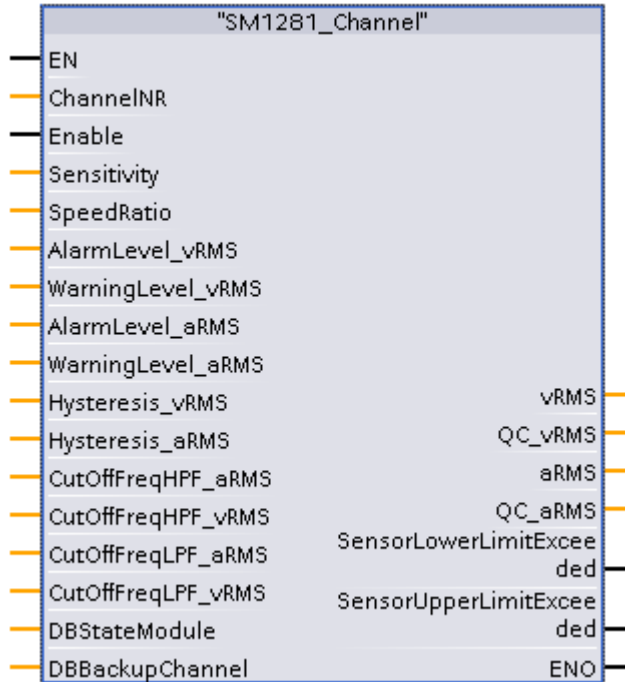

Image 11-2 FC SM1281_Channel

Function

The "SM1281_Channel" block offers the following functions:

- Channel-specific parameter setting
- Output of channel-specific status and error information

For each channel of the SM 1281 that is used, a call of the "SM1281_Channel" function is needed.

The assignment of the function call to the corresponding module is done via the input parameters `SM1281_Status` and `SM1281_Backup` (the data type instances of the respective module must be created there). The channel (number) to be configured is defined on the respective SM 1281 via the input parameter `ChannelNR`.

References

The operation of the block is explained in Chapter Using blocks (Page 103) with the aid of use cases.

You can find the meanings of the parameters and of the error and status codes in the following tables.

11.4.2.1 FC SM1281_Channel - Parameters

Input parameters

Table 11-9 FC SM1281_Channel - Input parameters

Parameters	Data type	Description
ChannelNR	USInt	Assignment to the channel of the SM 1281: Channel number 1-4 A channel number <1 is interpreted as Channel 1. A channel number >4 is interpreted as Channel 4.
Enable	Bool	Permits enabling and disabling of the channel.
Sensitivity	Real	Sensor sensitivity in mV/g (>0.001)
SpeedRatio	Real	Speed ratio (>0)
AlarmLevel_vRMS	Real	Limit value alarm vRMS in mm/s The value range is limited to 0.0...255.99609375 by an internal conversion to a 16-bit fixed point number! Values <0 are interpreted as 0, values >255.99609375 are interpreted as 255.99609375. 0: The limit value is not monitored.
WarningLevel_vRMS	Real	Limit value warning vRMS in mm/s The value range is limited to 0.0...255.99609375 by an internal conversion to a 16-bit fixed point number! Values <0 are interpreted as 0, values >255.99609375 are interpreted as 255.99609375. 0: The limit value is not monitored. <i>WarningLevel_vRMS must be less than the associated AlarmLevel_vRMS.</i>
AlarmLevel_aRMS	Real	Limit value alarm aRMS in m/s ² The value range is limited to 0.0...255.99609375 by an internal conversion to a 16-bit fixed point number! Values <0 are interpreted as 0, values >255.99609375 are interpreted as 255.99609375. 0: The limit value is not monitored.
WarningLevel_aRMS	Real	Limit value warning aRMS in m/s ² The value range is limited to 0.0...255.99609375 by an internal conversion to a 16-bit fixed point number! Values <0 are interpreted as 0, values >255.99609375 are interpreted as 255.99609375. 0: The limit value is not monitored. <i>WarningLevel_aRMS must be less than the associated AlarmLevel_aRMS.</i>
Hysteresis_vRMS	Real	Hysteresis vRMS in mm/s The value range is limited to 0.0...255.99609375 by an internal conversion to a 16-bit fixed point number! Values <0 are interpreted as 0, values >255.99609375 are interpreted as 255.99609375. <i>Hysteresis_vRMS must be less than the associated Hysteresis_vRMS.</i>

11.4 Blocks

Parameters	Data type	Description
Hysteresis_aRMS	Real	Hysteresis aRMS in m/s ² The value range is limited to 0.0...255.99609375 by an internal conversion to a 16-bit fixed point number! Values <0 are interpreted as 0, values >255.99609375 are interpreted as 255.99609375. Hysteresis_aRMS must be less than the associated Warning_Level_aRMS.
CutOffFreqHPF_aRMS	USInt	Preselection limit frequency high-pass filter aRMS: ¹ 0: 2 Hz / 10 Hz (speed-dependent) 1: 1 kHz
CutOffFreqHPF_vRMS	USInt	Preselection limit frequency high-pass filter vRMS: ¹ 0: 2 Hz / 10 Hz (speed-dependent) 1: 1 kHz Comment: If the parameter ReducedSamplingRate is set, a fixed value with 0.1 Hz is set instead of the entry in the parameter CutOffFreqHPF_vRMS.
CutOffFreqLPF_aRMS	USInt	Preselection low-pass filter limit frequency aRMS: ¹ 0: 1 kHz 1: 3 kHz 2: 10 kHz
CutOffFreqLPF_vRMS	USInt	Preselection low-pass filter limit frequency vRMS: ¹ 0: 1 kHz 1: 3 kHz 2: 10 kHz

¹ When an impermissible value is preselected via the output parameter StateOpModeChange on the "SM1281_Module" block, an error message is displayed.

Input/output parameters

Table 11- 10 FC SM1281_Channel - Input/output parameters

Parameters	Data type	Description
DBStateModule	Struct	Reference to the module structure (Page 93) in the DB "SM1281_Status". The assignment to the FB "SM1281_Module" or to the SM 1281 in the device configuration also takes place at this point.
DBBackupChannel	SM1281_Type_Channelparameters	Reference to the channel parameter structure (Page 95) in the DB "SM1281_Backup".

Output parameters

Table 11- 11 FC SM1281_Channel - Output parameters

Parameters	Data type	Description
vRMS	Real	Speed vRMS in mm/s
QC_vRMS	USInt	Qualifier speed vRMS (see table Status and error displays QC_vRMS)
aRMS	Real	Interval rms value of vibration acceleration aRMS in m/s ²
QC_aRMS	USInt	Qualifier interval rms value of vibration acceleration aRMS (see table Status and error displays QC_aRMS)
SensorLowerLimitExceeded	Bool	Sensor measuring range undershot
SensorUpperLimitExceeded	Bool	Sensor measuring range exceeded

Status and error displays QC

Table 11- 12 FC SM1281_Channel - Status and error displays QC_Speed

Status	Meaning
0	Do not evaluate (no function)
1	Good
2	Not calculated yet
3	Cannot be calculated

Status and error displays QC_vRMS

Table 11- 13 FC SM1281_Channel - Status and error displays QC_vRMS

Status	Meaning
0	Do not evaluate (no function)
1	Good
2	Not calculated yet
3	Cannot be calculated

Status and error displays QC_aRMS

Table 11- 14 FC SM1281_Channel - Status and error displays QC_aRMS

Status	Meaning
0	Do not evaluate (no function)
1	Good
2	Not calculated yet
3	Cannot be calculated

11.4.3 DB SM1281_Status

Function

The global data block "SM1281_Status" contains all status, traffic light and error information of the SM 1281. The data is stored structured by module and channel.

The data for an SM 1281 module is created in the data block. When more than one SM 1281 is used, the parameter "Module1" can be copied and pasted as "Module2". The names of the parameters "Module", "Channel_1", "Channel_2", "Channel_3", "Channel_4" can be renamed as required.

See also

Status and actual displays (Page 50)

11.4.3.1 DB SM1281_Status - Parameter

Parameters

Table 11- 15 DB SM1281_Status - Parameter

Parameters	Data type	Description
Module1	Struct	All status and actual values of the SM 1281 are stored in this PLC data type. When there are several SM 1281 modules, the parameter <code>Module1</code> can be copied and pasted as <code>Module2</code> in the DB "SM1281_Status".
Module	SM1281_Type_ModuleStatus	This structure contains module-specific status and actual values.
ActualSpeed	Real	Current speed in revolutions per minute
QC_Speed	USInt	Qualifier for speed (see table QC_Speed (Page 91))
ActualOpMode	USInt	Current operating mode of the SM 1281
StateOpModeChange	Word	Status of operating mode change
StateFingerprintRec	USInt	Status of raw data recording
StateRawDataRec	USInt	Status of fingerprint recording
SystemState	DWord	System state
InternalData	SM1281_Type_Moduleparameters	Internal data, not relevant for users
InternalData_1	Struct	Internal data, not relevant for users
Channel_1	SM1281_Type_ChannelStatus	All status and actual values of the first channel of the SM 1281 are stored in this structure.
vRMS	Real	Interval rms value of the vibration velocity vRMS in mm/s
aRMS	Real	Interval rms value of vibration acceleration aRMS in m/s ²
QC_vRMS	USInt	Qualifier interval rms value of the vibration velocity vRMS (see table QC_vRMS (Page 92))
QC_aRMS	USInt	Qualifier interval rms value of vibration acceleration aRMS (see table QC_aRMS (Page 92))
Sensor offset	Real	Sensor operating point
MonState_vRMS	Struct	Monitoring status vRMS
NotValid	Bool	Do not evaluate (status unknown)
Good	Bool	Good (green)
Warning	Bool	Warning (yellow)
Alarm	Bool	Alarm (red)
MonState_aRMS	Struct	Monitoring status aRMS
NotValid	Bool	Do not evaluate (status unknown)
Good	Bool	Good (green)
Warning	Bool	Warning (yellow)
Alarm	Bool	Alarm (red)
MonState_a(f)	Struct	Monitoring status acceleration spectrum
NotValid	Bool	Do not evaluate (status unknown)

11.4 Blocks

Parameters	Data type	Description
Good	Bool	Good (green)
Warning	Bool	Warning (yellow)
Alarm	Bool	Alarm (red)
MonState_v(f)	Struct	Monitoring status velocity spectrum
NotValid	Bool	Do not evaluate (status unknown)
Good	Bool	Good (green)
Warning	Bool	Warning (yellow)
Alarm	Bool	Alarm (red)
MonState_e(f)	Struct	Monitoring status envelope spectrum
NotValid	Bool	Do not evaluate (status unknown)
Good	Bool	Good (green)
Warning	Bool	Warning (yellow)
Alarm	Bool	Alarm (red)
MonState_e(f)_BPFO	Struct	Monitoring status envelope spectrum BPFO (ball passing frequency outer race)
NotValid	Bool	Do not evaluate (status unknown)
Good	Bool	Good (green)
Warning	Bool	Warning (yellow)
Alarm	Bool	Alarm (red)
MonState_e(f)_BPFI	Struct	Monitoring status envelope spectrum BPFI (ball passing frequency inner race)
NotValid	Bool	Do not evaluate (status unknown)
Good	Bool	Good (green)
Warning	Bool	Warning (yellow)
Alarm	Bool	Alarm (red)
MonState_e(f)_FTF	Struct	Monitoring status envelope spectrum FTF (fundamental train frequency)
NotValid	Bool	Do not evaluate (status unknown)
Good	Bool	Good (green)
Warning	Bool	Warning (yellow)
Alarm	Bool	Alarm (red)
MonState_e(f)_BSF	Struct	Monitoring status envelope spectrum BSF (ball spin frequency)
NotValid	Bool	Do not evaluate (status unknown)
Good	Bool	Good (green)
Warning	Bool	Warning (yellow)
Alarm	Bool	Alarm (red)
SensorState	Struct	Sensor state
NotValid	Bool	Do not evaluate (e.g. sensor is not parameterized)
Connected	Bool	Connected sensor
LowerLevelExeeded	Bool	Sensor measuring range undershot
UpperLevelExeeded	Bool	Sensor measuring range exceeded
InternalData	SM1281_Type_Channelparameters	Internal data, not relevant for users

Parameters	Data type	Description
Channel_2	SM1281_Type_ChannelStatus	All status and actual values of the second channel of the SM 1281 are stored in this structure.
Channel_3	SM1281_Type_ChannelStatus	All status and actual values of the third channel of the SM 1281 are stored in this structure.
Channel_4	SM1281_Type_ChannelStatus	All status and actual values of the fourth channel of the SM 1281 are stored in this structure.

See also

FC SM1281_Channel - Parameters (Page 89)

11.4.4 DB SM1281_Backup

Function

If all of the parameters have been successfully transferred to the SM 1281, they are backed up as a parameter set in the global and retentive data block "SM1281_Backup". The backed up parameters can be restored via the input parameter `RestoreParameters` of the "SM1281_Module" block.

11.4.4.1 DB SM1281_Backup - Parameter

Parameters

Table 11- 16 DB SM1281_Backup - Parameter

Parameters	Data type	Description
Module_1	Struct	
Module parameters	SM1281_Type_Moduleparameters	This structure contains the automatically backed up module parameters.
SpeedSource	Byte	Selection of the speed source: 1: S7-1200 2: DI - Digital input of the SM 1281
PulsesPerRevolution	UInt	Pulses per revolution if the DI of the SM 1281 is used as speed source. The value must be greater than 0.
ReducedSamplingRate	Bool	Use low-frequency RMS monitoring for all channels.
IPAddress	DWord	IP address of the SM 1281
SubnetMask	DWord	Subnet mask of the SM 1281
DefaultGateway	DWord	Default gateway of the SM 1281
DHCP	Bool	Use of a DHCP server (automatic assignment of the IP address and subnet mask)
Parameters_Channel_1	SM1281_Type_Channelparameters	This structure contains the automatically backed up parameters of channel 1.

11.4 Blocks

Parameters	Data type	Description
ChannelNr	USInt	Channel number
Enable	Bool	Specifies whether the channel is enabled or disabled.
Sensitivity	Real	Sensitivity of sensor
SpeedRatio	Real	Speed ratio
AlarmLevel_vRMS	Real	Limit value alarm vRMS in mm/s
WarningLevel_vRMS	Real	Limit value warning vRMS in mm/s
AlarmLevel_aRMS	Real	Limit value alarm aRMS in m/s ²
WarningLevel_aRMS	Real	Limit value warning aRMS in m/s ²
Hysteresis_vRMS	Real	Hysteresis vRMS in mm/s
Hysteresis_aRMS	Real	Hysteresis aRMS in m/s ²
CutOffFreqHPF_aRMS	USInt	Preselection limit frequency high-pass filter aRMS
CutOffFreqHPF_vRMS	USInt	Preselection limit frequency high-pass filter vRMS
CutOffFreqLPF_aRMS	USInt	Preselection low-pass filter limit frequency aRMS
CutOffFreqLPF_vRMS	USInt	Preselection low-pass filter limit frequency vRMS
Parameters_Channel_2	SM1281_Type_Channelparameters	This structure contains the automatically backed up parameters of channel 2.
Parameters_Channel_3	SM1281_Type_Channelparameters	This structure contains the automatically backed up parameters of channel 3.
Parameters_Channel_4	SM1281_Type_Channelparameters	This structure contains the automatically backed up parameters of channel 4.

11.5 Working with the library

11.5.1 Integrating the library in STEP 7

Requirement

A STEP 7 project with an S7-1200 CPU and at least one configured SM 1281 must be available.

Integrating the library in STEP 7

You can download the SM 1281 library via the Support (<https://support.industry.siemens.com/cs/?lc=en-DE>).

To integrate the library "SM1281_Library" in your STEP 7 project, proceed as described here:

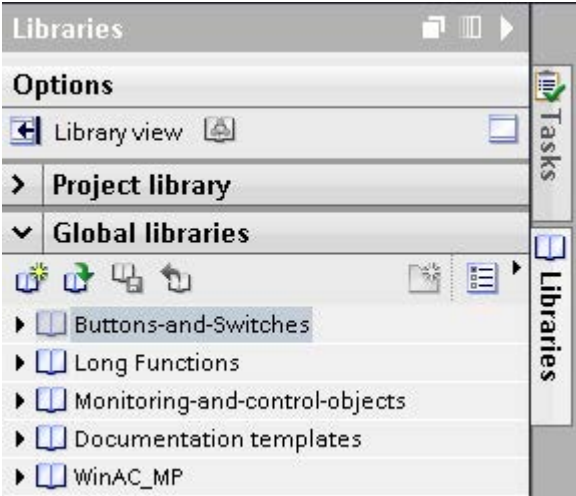
No.	Step	View in the TIA Portal
1	<p>The library is available as ZIP archive.</p> <p>Unzip the ZIP archive into a folder on your PC, from which you would like to open the global library.</p> <p>Choose "Options > Global libraries > Retrieve library" from the menu to do so.</p>	-
2	<p>Open the library.</p> <p>To do this, open the display of the global libraries on the right in the TIA Portal.</p> <p>In the display, you can open the library "SM1281_Library".</p> <p>To do this, press the button for opening a library, select the storage location with the unzipped ZIP archive and the library file, and press the "Open" button of the Open dialog.</p>	

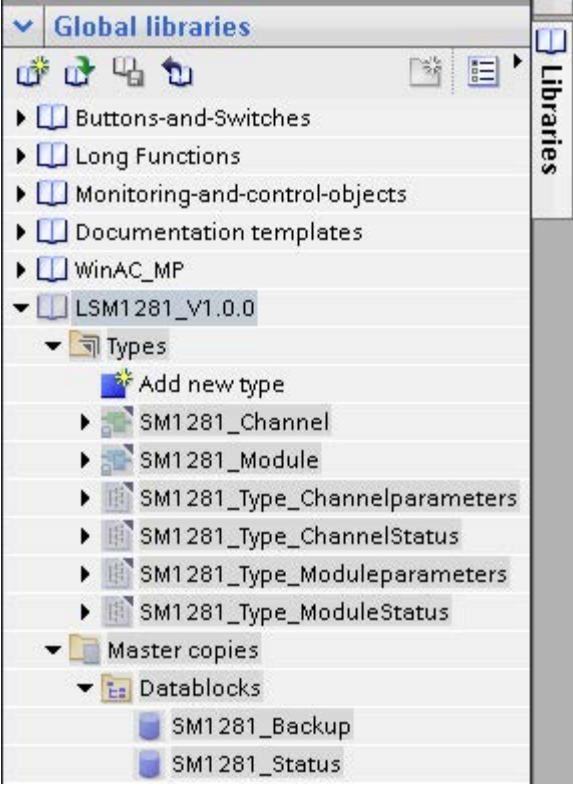
No.	Step	View in the TIA Portal
3	<p>In the opened global library, you see all of the components it contains.</p> <ul style="list-style-type: none"> • Types The needed PLC data types, the "SM1281_Channel" function, and the "SM1281_Module" function block are saved here. • Copy templates The two global data blocks are saved here. 	 <p>The screenshot shows the 'Global libraries' pane in the TIA Portal. The 'LSM1281_V1.0.0' library is expanded to show its contents:</p> <ul style="list-style-type: none"> Buttons-and-Switches Long Functions Monitoring-and-control-objects Documentation templates WinAC_MP LSM1281_V1.0.0 (expanded) <ul style="list-style-type: none"> Types (expanded) <ul style="list-style-type: none"> Add new type SM1281_Channel SM1281_Module SM1281_Type_Channelparameters SM1281_Type_ChannelStatus SM1281_Type_Moduleparameters SM1281_Type_ModuleStatus Master copies Datablocks <ul style="list-style-type: none"> SM1281_Backup SM1281_Status

Result



The library is integrated in STEP 7 and you can use the blocks of the library.

11.5.2 Integrating blocks in STEP 7

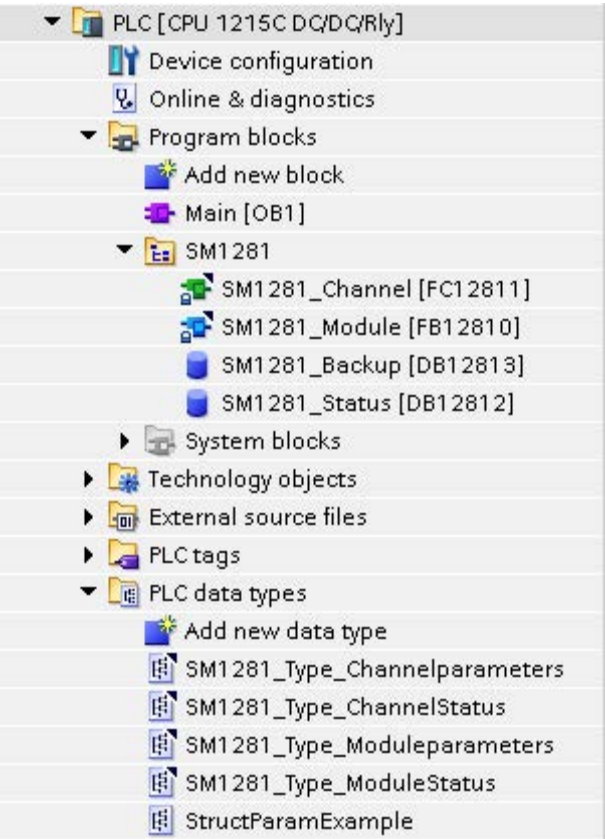
The steps for integrating the blocks of the "SM1281_Library" in your STEP 7 program are listed below

No.	Step	View in the TIA Portal
1	<p>To import the function block "SM1281_Module" and the function "SM1281_Channel" in your user program, drag and drop the function block and the function from the "Types" folder (from the global library) to the "Program blocks" folder of the S7-1200 CPU of your TIA Portal project.</p> <p>The PLC data types that are referenced in the blocks are automatically copied as well.</p> <p>Drag and drop the data blocks "SM1281_Status" and "SM1281_Backup" from the "Copy templates" folder (from the global library) to the "Program blocks" folder of the S7-1200 CPU of your TIA Portal project.</p> <p>Result: All of the needed blocks from the "SM1281_Library" are contained in your user program (see figure).</p>	 <p>The screenshot shows the project tree for a PLC [CPU 1215C DC/DC/Rly]. The tree is expanded to show the 'PLC data types' folder, which contains several data types imported from the SM1281 library: SM1281_Type_Channelparameters, SM1281_Type_ChannelStatus, SM1281_Type_Moduleparameters, SM1281_Type_ModuleStatus, and StructParamExample. Other folders visible include 'Program blocks' (containing SM1281_Channel [FC12811], SM1281_Module [FB12810], SM1281_Backup [DB12813], and SM1281_Status [DB12812]), 'System blocks', 'Technology objects', 'External source files', 'PLC tags', and 'PLC data types' (with an 'Add new data type' option).</p>
2	<p>Calling the "SM1281_Module" function block in the user program:</p> <p>To be able to use the function block in the user program, it must be opened in a cyclic organization block, e.g. in OB1 "Main".</p>	-

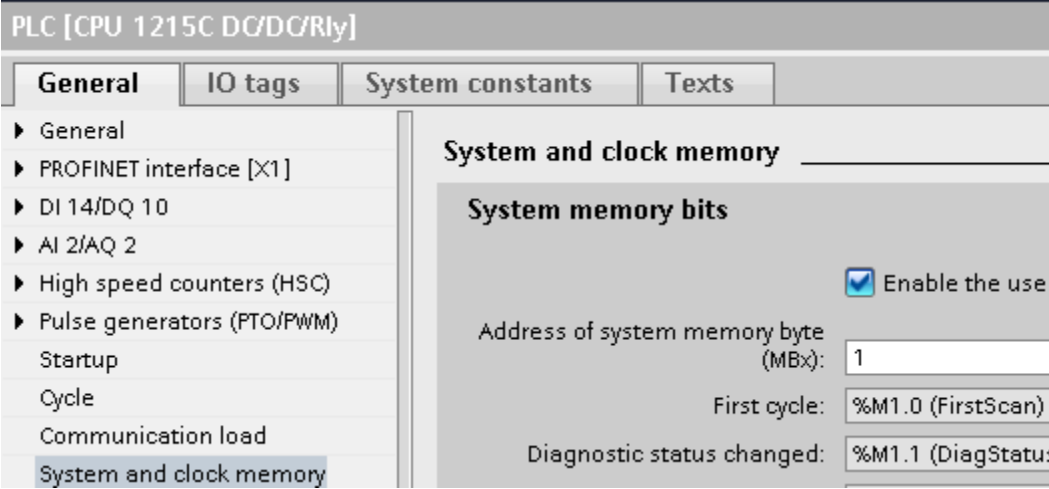
No.	Step	View in the TIA Portal
3	<p>After you have opened the block in a cyclic organizational block and have created an instance data block, assign an SM 1281 from the hardware configuration to the block.</p> <p>This is done via the four input parameters:</p> <ul style="list-style-type: none"> • HW_Submodule • HW_Submodule_1 • HW_Submodule_2 • HW_Submodule_3 <p>Double-clicking on the input field of one of the input parameters and clicking on the button causes a list of the available HW submodules to appear.</p> <p>At this point, select the respective HW submodule of the SM 1281 that belongs to the input parameter. The SM 1281 is divided into four HW submodules.</p>	
4	<p>After you have assigned an SM 1281 to the block, assign the system flag for the first cycle of your S7-1200 CPU to the input parameter <code>Init</code>.</p>	
	<p>If necessary, you must activate the system flag under the properties of the S7-1200 CPU in the device configuration beforehand.</p>	

No.	Step	View in the TIA Portal
		
5	<p>Assign the corresponding element from the data blocks "SM1281_Status" and "SM1281_Backup" to the input/output parameters DBStateModule and DBBackupModule.</p> <p>To do this, connect the input/output parameter DBStateModule to the variable "Module1" of the data type "Struct" from the "SM1281_Status" data block.</p> <p>Connect the input/output parameter DBBackupModule with the variable "Module parameters" of the data type "SM1281_Type_Moduleparameters" from the "Module1" structure in the "SM1281_Backup" data block.</p> <p>Result: After you have performed all of the steps, the block is connected (see figure).</p> <p>For each SM 1281, a call of the block "SM1281_Module" is necessary in the user program. When more than one SM 1281 is used, the data structures in the data blocks "SM1281_Status" and "SM1281_Backup" must be expanded by the necessary number of modules, e.g. by copying and pasting the module structure.</p>	

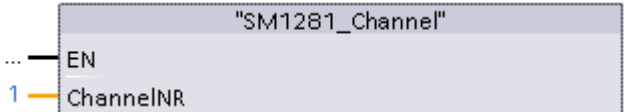
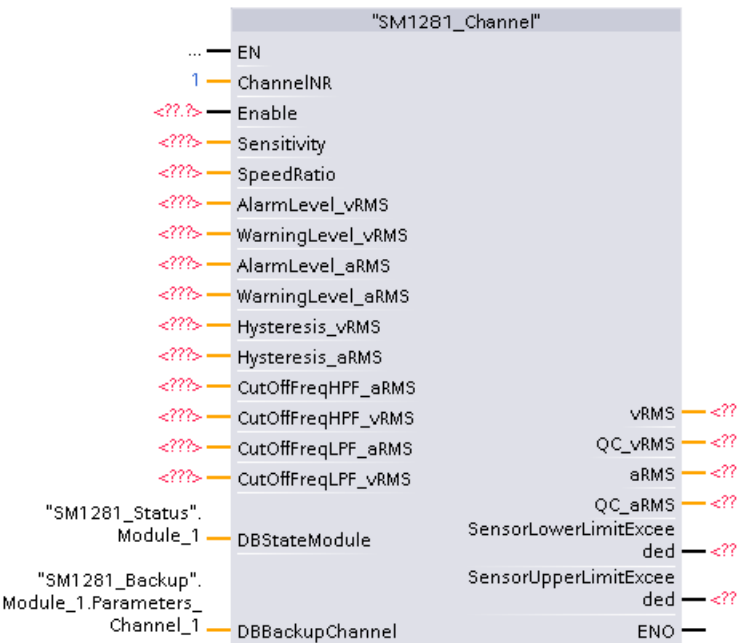
No.	Step	View in the TIA Portal
6	<p>Next, call the function "SM1281_Channel" in a cyclic organization block in the user program.</p> <p>For each channel of the SM 1281 that is used, a call of the "SM1281_Channel" function is needed. If you only use one channel, you also only need one call of the "SM1281_Channel".</p>	-
7	<p>Assign a channel of the SM 1281 to the function. This is done via the ChannelNR input parameter. The valid values at this point are integer numbers from 1 to 4.</p>	
8	<p>In the last step, assign the corresponding element from the data blocks "SM1281_Status" and "SM1281_Backup" to the input/output parameters DBStateModule and DBBackupChannel.</p> <p>To do this, connect the input/output parameter DBStateModule, as in Step 4, to the variable "Module1" of the data type "Struct" from the "SM1281_Status" data block.</p> <p>To do this, connect the input/output parameter DBBackupChannel with the variable "Parameters_Channel_1" of the data type "SM1281_Type_Channelparameters" from the "Module1" structure in the "SM1281_Backup" data block. For channel 2, the variable "Parameters_Channel_2" etc. accordingly.</p> <p>Result:</p> <p>After you have performed all of the steps, the block is connected (see figure).</p> <p>The remaining input and output parameters must still be connected to the user program.</p> <p>Repeat steps 6 to 8 for each additional channel and adapt the parameters to the channel accordingly.</p>	

11.5.3 Using blocks

Requirement

Note**Configure SM 1281**

The SM 1281 can only be operated and configured if it is ready.

The SM 1281 is ready if it is in the state "STOP: Configuration" in "STOP: System ready" or in one of the RUN operating modes. In all other cases, no operation of the module via the S7-1200 CPU is possible!

For the following use cases, the module and channel parameters must be assigned valid values.

The following describes use cases which are possible with the library blocks.

11.5.3.1 Select operating mode/CPU restart

The SM 1281 has the following operating modes:

- (0) STOP: System ready
- (1) RUN: Monitoring
- (2) RUN: Monitoring inhibited
- (3) RUN: Measuring
- (4) RUN: System diagnostics

The current operating mode is displayed on the output parameter `ActualOpMode` of the "SM1281_Module" block. This can differ from the selected operating mode in the following cases, for example:

- The selection of the operating mode failed (e.g. because invalid parameters were transferred to the module previously).
- The SM 1281 is not ready.
- The selected operating mode has not yet been confirmed via `ActivateOpMode`.

Selecting an operating mode

The following describes how to select an operating mode:

No.	Step	Note
1	Select the desired operating mode via the corresponding index at the input parameter- <i>OpMode</i> of the "SM1281_Module" block.	
2	Confirm selection with positive edge at the input parameter <i>ActivateMode</i> .	The SM 1281 now attempts to set the selected operating mode. This may take a few seconds. You can discern whether the selected operating mode has been successfully adopted via the error code at the output parameter <i>StateOpModeChange</i> . If the requested operating mode has not been successfully adopted, information about the cause is displayed here. The assignment of the error codes can be found in the Table (Page 84).

Note

If a new operating mode is selected, the feedback message "Last switchover successful" (0) is displayed during the switchover of the operating mode via the output parameter *StateOpModeChange*, before the selected operating mode is reached. The background for this is that the SM 1281 carries out several internal mode changes depending on the request.

Note

As long as a mode change is being carried out, no new operating mode be requested. A new selection is rejected in this case.

Behavior in the event of a CPU restart and failure of the SM 1281

For a CPU restart (warm restart), the parameters that are set on the blocks are automatically transferred to the SM 1281 and the operating mode selected at the input parameter *OpMode* is set. If there are invalid parameters at the block interfaces, the SM 1281 remains in the mode "STOP: Configuration" or "STOP: System ready" and an error message is output at the output parameter *StateOpModeChange*. If the parameterization is wrong, it must be corrected and reloaded. If the import is successful, the desired operating mode can then be set.

If the SM 1281 fails on its own, e.g. due to an interruption of the power supply, the operating mode that is selected at the input parameter *OpMode* is also automatically set after the restart of the module.

11.5.3.2 All parameters are transferred to the SM 1281

The parameters pending at the block interfaces are only transferred to the SM 1281 upon request.

All of the parameters which are present at the input parameters of the blocks "SM1281_Module" and "SM1281_Channel" are transferred via a positive edge at the input parameter `SetAllParameters`.

Depending on the current operating mode of the SM 1281, a switch of operating modes is automatically carried out.

Note

Interruption of the monitoring

The request "Transfer all parameters to the SM 1281" leads to the operating mode "STOP: Configuration".

This briefly interrupts any currently running monitoring.

This is necessary because the SM 1281 cannot import some parameters in RUN mode. After the successful import of the parameters in the SM 1281, the operating mode that was active before the transfer of the parameters is restored.

If the parameters were not successfully transferred, an error message is displayed at the output parameter `OpModeChangeStatus` if an operating mode changeover fails.

Note

As long as the transfer of the parameters has not completed, no new parameters can be transferred. A new request is rejected in this case.

11.5.3.3 Transferring dynamic parameters to the SM 1281

In addition to the capability of transferring all of the parameters to the SM 1281, you can also transfer only the dynamic parameters. This is only possible in the mode "RUN: Monitoring" or "RUN: Monitoring deactivated".

The SM 1281 does not carry out a change of operating modes to a STOP mode when importing dynamic parameters. This has the advantage that the measuring mode/monitoring mode is not interrupted in contrast to `SetAllParameters`.

The dynamic parameters, which are present at the input parameters of the block "SM1281_Channel", are transferred via a positive edge at the input parameter `SetDynParameters`.

The limit values listed below can be changed via this command. It is not possible, however, to activate or deactivate the limit value monitoring via this mechanism. To do this, it is necessary to transfer **all** of the parameters to the SM 1281.

Dynamic parameters

The four dynamic parameters serve as limit values of the vRMS and aRMS monitoring:

Parameters	Data type	Description
AlarmLevel_vRMS	Real	Limit value alarm vRMS in mm/s
WarningLevel_vRMS	Real	Limit value warning vRMS in mm/s
AlarmLevel_aRMS	Real	Limit value alarm aRMS in m/s ²
WarningLevel_aRMS	Real	Limit value warning aRMS in m/s ²

Note

As long as the transfer of the parameters has not completed, no new parameters can be transferred. A new request is rejected in this case.

11.5.3.4 Requesting fingerprint recording

A fingerprint, i.e. the current state of the machine, can be saved on the "SM1281_Module" block via the input parameter `FingerprintRecording`. A fingerprint is requested via a positive edge. Depending on the request, one fingerprint is saved in the fingerprint database for each active vibration channel on the SM 1281 module (maximum 100 fingerprints).

The status of the recording is displayed on the output parameter `StateFingerprintRec` (see status and error displays table (Page 86)).

Note

As long as recording is running, no new recording can be requested.

A new recording can only be requested when the current recording has been successfully completed or the recording could not be carried out due to an error!

See also

FB SM1281_Module - Parameters (Page 81)

11.5.3.5 Request recording of raw data

The SM 1281 is able to store raw data in the form of WAV files. The raw data contains high-resolution recordings of the vibration inputs of the device and the speed.

Such a recording can be requested via a positive edge at the input parameter `RawDataRecording` of the "SM1281_Module" block.

The status of the recording is displayed on the output parameter `StateRawDataRec` (see status and error displays table (Page 86)).

Note

As long as recording is running, no new recording can be requested. A new recording can only be requested when the current recording has been successfully completed or the recording could not be carried out due to an error!

See also

FB SM1281_Module - Parameters (Page 81)

11.5.3.6 Backing up and restoring parameters

For each successful transition to the operating mode "RUN: Monitoring", the last parameters transferred to the SM 1281 are automatically backed up in the retentive data block "SM1281_Backup". This ensures that all of the parameters which had previously been transferred to the SM 1281 are valid. If, for example, the SM 1281 is not set to a RUN state after an erroneous parameterization, the last successfully transferred parameters can be restored. In this way, the SM 1281 can then be set to the desired operating mode.

A valid parameter set can be restored by a positive edge at the input `RestoreParameters` on the "SM1281_Module" block. Basically, all of the parameters are transferred from the "SM1281_Backup" data block to the SM 1281. Depending on the operating mode, internal changes of operating mode are carried out to import the parameters.

After the parameters are successfully restored, the last operating mode of the SM 1281 is restored. After the parameters have been successfully restored, the desired operating mode can be set via `ActivateMode`.

Note

While the parameters are being restored, no commands can be set via the blocks.

11.6 Update library

Update library

You can find instructions on how to integrate a newer version of the library in your STEP 7 project or how to update the blocks in your project in the System Manual STEP 7 Professional V13.1 (<https://support.industry.siemens.com/cs/de/en/view/109011420>) under "Working with types in global libraries" and "Updating a project to the latest type versions".

Parameter assignment/configuring

12.1 Overview

The settings for the SM 1281 can be made via the TIA Portal and via the SM 1281 Web server:

Basic settings via the TIA Portal and in the S7 user program:

- Network settings
- Speed
- Limit values vRMS and aRMS
- Sensitivity of sensor

Expanded settings via the SM 1281 Web server:

- device name, language, password
- Channel name
- Settings for spectral analysis

12.2 Setting initialization data via the TIA Portal

The initialization data is transferred from the user program to the SM 1281 module. It is valid for a module or for a channel.

- You can set the following **module parameters** for an SM 1281:
 - `SpeedSource`.
 - `Speed`
 - `PulsesPerRevolution`
 - Use low-frequency RMS monitoring (`ReducedSamplingRate`)
 - IP configuration (`IPAddress`, etc.)
- You can set the following **channel parameters** per channel:
 - Channel active/inactive (`Enable`)
 - Sensitivity of sensor (`Sensitivity`)
 - Transformation ratio (`SpeedRatio`)
 - Alarm and warning limits vRMS and aRMS (`AlarmLevel_...`, `WarningLevel_...`)
 - Hysteresis vRMS and aRMS (`Hysteresis_...`)
 - Limit frequency filter for vRMS and aRMS (`CutOffFreq...`)

Note

The description of the parameters can be found in the SM 1281 library:

- Module parameters (Page 81)
 - Channel parameters (Page 89)
-

12.3 Parameterizing via the SM 1281 web user interface

The following chapters describe the web user interface with the full functional range for parameterizing and displaying data.

The website for HMI panels has a limited scope of functions. It is described in Chapter Website for HMI panels (Page 159).

12.3.1 Software and hardware requirements

Supported browsers

The web pages are designed to be used and displayed in the following browsers:

- Mozilla Firefox 31
- Internet Explorer 10
- Internet Explorer 11

Note

Display problems

If other browsers are used, display problems may occur.

Browser settings

The websites uses cookies. Accept the use of cookies in the browser settings. Otherwise unwanted effects may result.

Screen resolution

The web pages have been optimized for a screen resolution of 1280 x 1024 pixels.

12.3.2 General operation

12.3.2.1 Structure of the user interface

The web pages are structured as follows:

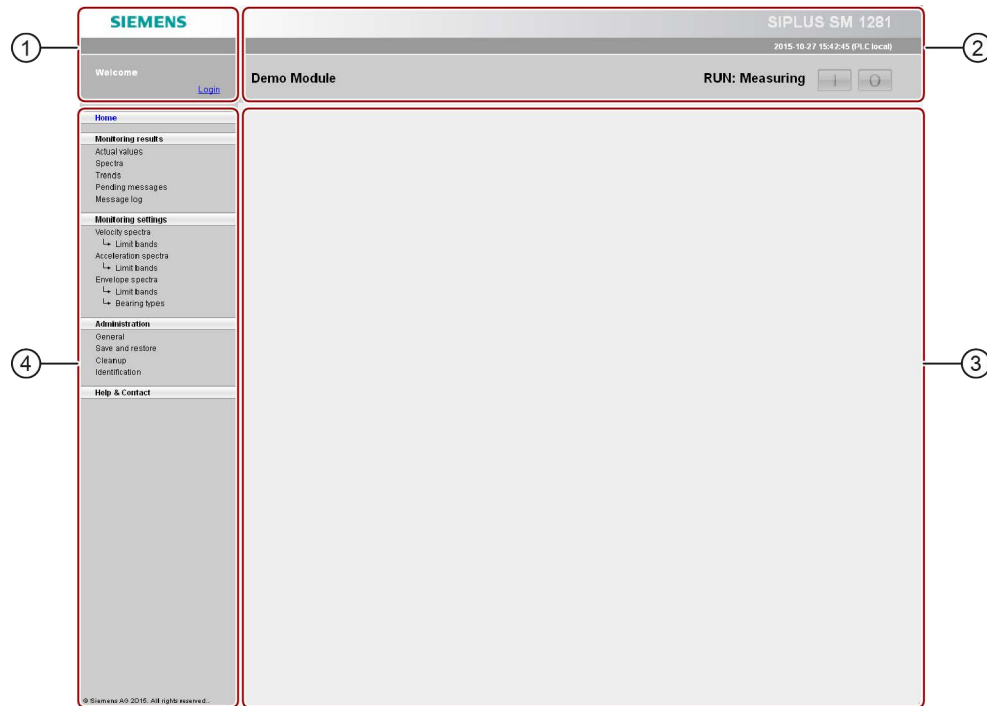

① Login area

This area contains:

- Name of the logged in user.
- Login/logoff function

② Module overview

This area contains:

- Device name
- Current operating mode, see Section Operating modes (Page 39)
- Button for switching to STOP if the device is in RUN
- Capability of switching to the device mode "RUN: Monitoring" or "RUN: Measuring" if the device is in STOP

③ Work area:

This area contains:

- Name of the page that was selected in the navigation area
- The selected web page with all the associated contents and parameters.

④ Navigation area

This area contains:

- Navigation tree that displays all the web pages that can be selected for the device
- Highlighting of the currently selected entry in the navigation tree

12.3.2.2 Logging in / logging out

Requirement

You have the operator authorization for the websites via the S7 user program.

Logging in / logging out

Before you can modify the device parameters, you must first log in. If you are not logged in, you will have read-only access to the SM 1281.

You can log in and log out on any selected web page.

To log in, click on "Login" in the log-in area. The following dialog appears:

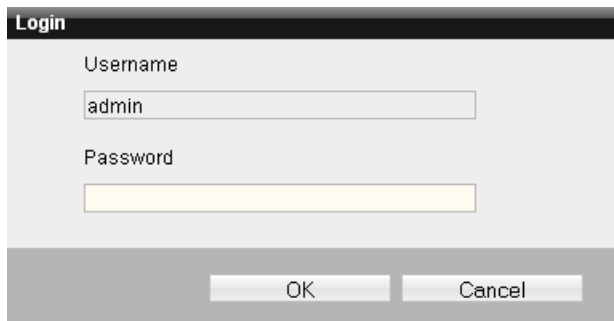

Enter the log-in data and confirm with OK.

- Default user name: admin
- Default password: 0000 (four times "zero")

Note

Change the default settings after the first logon under General (Page 149).

Note

Multiple simultaneous user sessions (web sessions) are possible in principle, i.e. more than one user can access the same SM 1281 via the website from different PCs. The device only permits one login at a time, i.e. after a user has logged in, the others will only have read access.

Note

If you are inactive for a longer period, there is no automatic log-off.

12.3.2.3 Setting the language for the device

The language for the web interface can be switched over between German and English. The language is set on the "Administration > "General" (Page 149) page.

Note

The language of the web interface is assigned to the SM 1281 device, not to the web session. This means that all users accessing at the same time will use the same language. If a user switches the language, all other users accessing at the same time will be affected by the language switchover.

12.3.2.4 Changing operating mode

Changing the operating mode

The current operating mode is displayed to the left of the buttons [I] / [O].

You can switch to STOP mode from any page using the buttons.

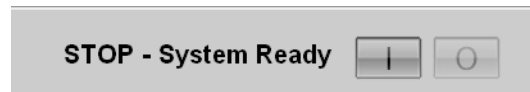

You can switch from STOP mode to the modes "RUN: Monitoring" or "RUN: Measuring".

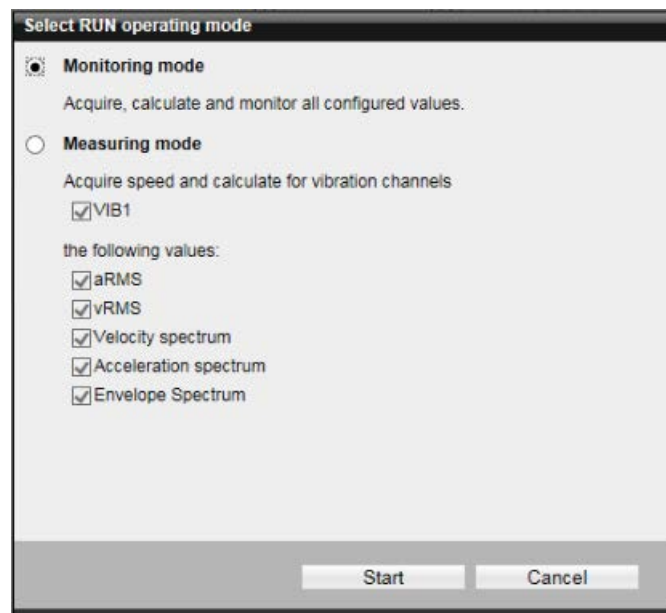

Monitoring mode

In the monitoring mode (RUN: Monitoring), all configured measured variables are constantly acquired or calculated, monitored, and recorded as trends.

Measuring mode

You can decide during any change to the measurement mode (RUN: Measuring) via a dialog, which IEPE channels will be used and which measured values (RMS, spectra) will be calculated.

The configuration chosen for measurement mode is automatically stored and will be offered next time you switch to measurement mode.

When switching to the operating mode "RUN: Measuring" via the S7 controller, all of the measured variables (RMS, spectra) are always calculated.

12.3.2.5 Editing and saving values and settings

Generally valid rules

- Only elements that you are allowed to modify can be edited.
- Only elements that you can use directly (in the current operating mode) can be edited.

Entering values

- Decimal places have already been appropriately defined for each input field. Rounding is performed automatically when you exit the input field.
- Decimal values must always be entered using a point ("."). This is the case regardless of which language is configured on the web pages (English or German).

Incorrect inputs

The input is automatically checked when you exit the input field.

- In the case of incorrect inputs, a tool tip will appear with the error message
- On multiple errors, all affected fields will be marked
- On saving, the values of an input field are either imported completely, if no error is found, or the data remains unchanged if an error is found on saving.

Saving data

Save the data using the "Save" button only. The "Save" button is offered if you have made changes on the web page.

12.3.2.6 Browser-specific operation

Browser-specific operation

- Multiple browser tabs or windows are supported. Changes made on one tab will not appear on other tabs until the changes have been saved and the other tabs have been reloaded.
- "Forward" and "Back" browser buttons are supported. If you have not saved the changes, the "Do you want to exit this page?" dialog appears. On confirming the dialog, the changes are lost, also if you go "Back", because the page is reloaded.
- Refresh (F5) using the browser is supported. The behavior here is identical to "Next"/"Back", i.e. the dialog "Do you want to leave this page?" appears and unsaved changes are lost.

12.3.2.7 Error messages

Error messages

If an error occurs during operation or a data request, or if an action is not possible, a dialog box will be opened in the workspace that describes the error in more detail.

Example:

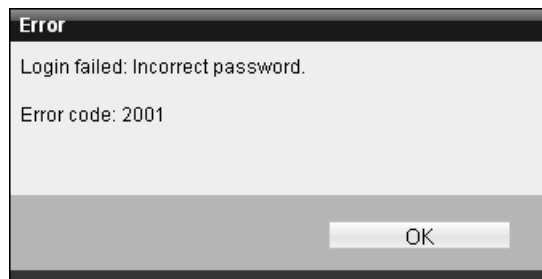

Image 12-1 Example of an error message

12.3.3 Home page

12.3.3.1 Home

On the home page, important system values are displayed.

To open the page, click "Home" in the navigation area.

Display data

The home page shows a figure of the device. An overview contains information about the device, the operating mode, and pending messages.

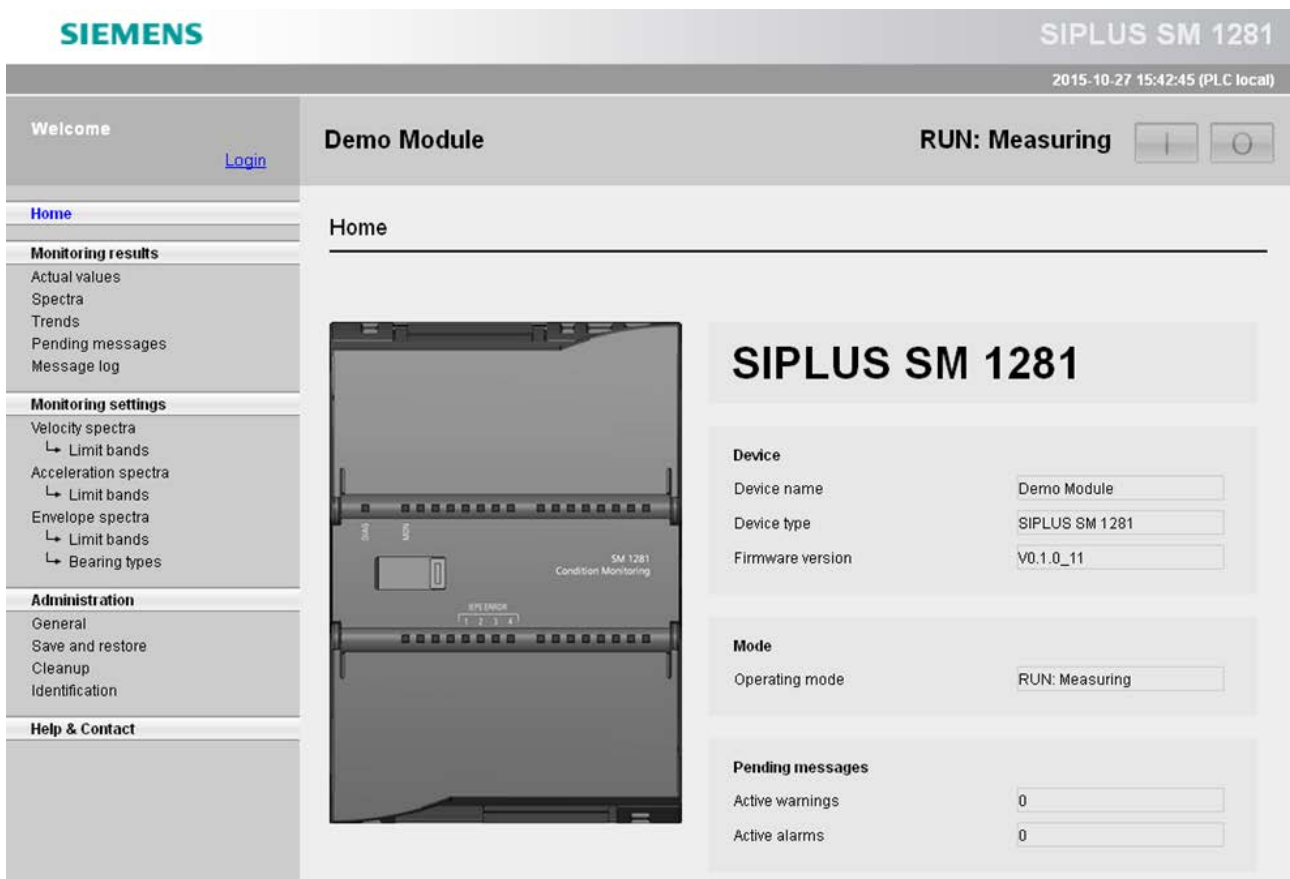

Device

Device name	The device name defined by the user is displayed here.
Device type	The device type is displayed here. This cannot be changed.
Firmware version	Installed firmware version.

Operating mode

Display of the current operating mode:

STOP: System ready	Device ready / no monitoring.
RUN: Measuring	Measured values are acquired / reference values are acquired / no monitoring.
RUN: Monitoring	Measured values are acquired and monitored
RUN: Monitoring inhibited	Measurements are performed / monitoring is suppressed.
RUN: System diagnostics	All of the parameterized vibration channels are measured. No further processing of the vibration data takes place.
Shutdown	Device is shutting down. A warm restart will be performed after a few seconds.
ERROR: System not ready	Device not ready

Pending messages

Active warnings	Number of active warnings.
Active alarms	Number of active alarms.

To obtain detailed information about the message, click on one of the output fields. You go directly to the website "Pending Messages" (Page 127).

12.3.4 Monitoring values

The **monitoring results** encompass the websites on which you can view and evaluate the monitoring responses.

The following monitoring results are available:

- Actual values (Page 118)
- Spectra (Page 121)
- Trends (Page 124)
- Pending messages (Page 127)
- Message log (Page 128)

12.3.4.1 Actual values

On the "Actual values" page, you can read the current measured values of the system. To open the web page, click "Monitoring results > Actual values" in the navigation area.

Vibration

The last calculated vRMS and aRMS values and their monitoring statuses and the monitoring statuses of the activated frequency-selective analysis methods are displayed here for all of the parameterized and activated vibration channels.

The calculated vRMS and aRMS values have colored backgrounds, depending on their respective monitoring state. The monitoring statuses of the activated frequency-specific analysis methods are displayed with stylized LEDs with colors that indicate the status (see table below).

Speed

The speed that is valid for the speed channel is displayed here.

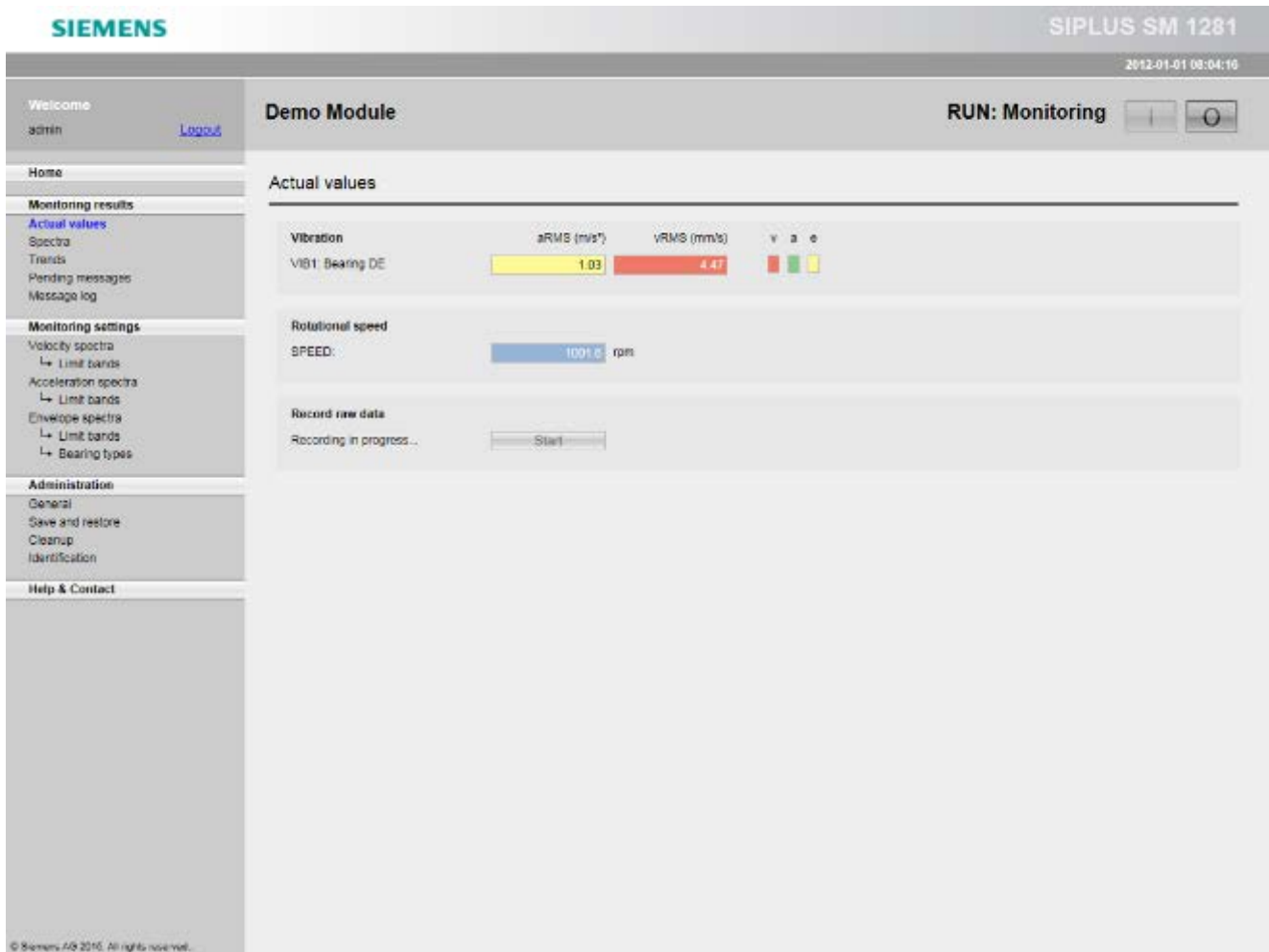

Display of values

Display of value	Meaning
???	The value is configured but not yet known, or the calculation has not yet finished. The sensor or connecting cable may be defective.
<Value>?	The value has been calculated, but the result is uncertain. An uncertain result can arise, for example, if the value is located in an implausible value range, or if the sensor or connecting cable is defective. This is indicated by the gray background to the display area.
<Value>	The value has been calculated and is judged to be correct. This is indicated by the green, yellow, red or blue background to the display area.

Color identification

Correctly calculated values are highlighted using different background colors to indicate any limit transgressions.

Color identification	Meaning
Gray	Measured value acquisition has not been performed or is faulty.
Light blue	Measured value acquisition is OK. Value is not being monitored, however.
Green	Measured value acquisition is OK. Value is being monitored. There has been no limit transgression.
Yellow	Measured value acquisition is OK, value is being monitored, and a warning limit has been transgressed.
Red	Measured value acquisition is OK, value is being monitored, and an alarm limit has been transgressed.

Display trends

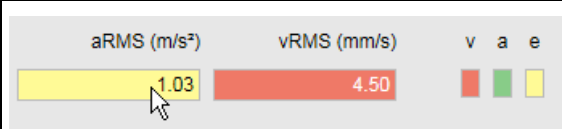
<p>Clicking one of the fields with the mouse will take you directly to the page with the associated trend.</p> <p>You can use the mouse to jump to a trend for:</p> <ul style="list-style-type: none"> • Speeds • vRMS, aRMS 	
--	--

Displaying spectra

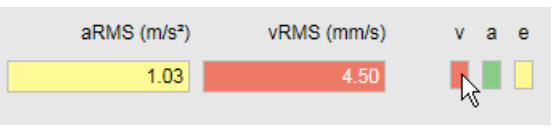
<p>Clicking one of the fields v, a, e with the mouse will take you directly to the page with the relevant type of spectrum.</p> <p>v = velocity spectrum $v(f)$ a = acceleration spectrum $a(f)$ e = envelope spectrum $env(f)$</p>	 <p>The screenshot shows a control panel with two RMS value displays and three selection buttons. The first display is labeled 'aRMS (m/s²)' and shows the value '1.03' in a yellow box. The second display is labeled 'vRMS (mm/s)' and shows the value '4.50' in a red box. To the right are three buttons labeled 'v', 'a', and 'e'. The 'v' button is red and has a mouse cursor over it, while the 'a' and 'e' buttons are green and yellow respectively.</p>
--	--

Recording raw data

With the "Start" button, you can save the current measured values as raw data in a file.

12.3.4.2 Spectra

On the "Spectra" web page, you can display spectra in a chart and save fingerprints of current spectra. One primary spectrum and up to three reference spectra can be displayed at the same time. The following types of spectrum can be displayed:

- Velocity spectrum
- Acceleration spectrum
- Envelope spectrum

To open the web page, click "Monitoring results > Spectra" in the navigation area.

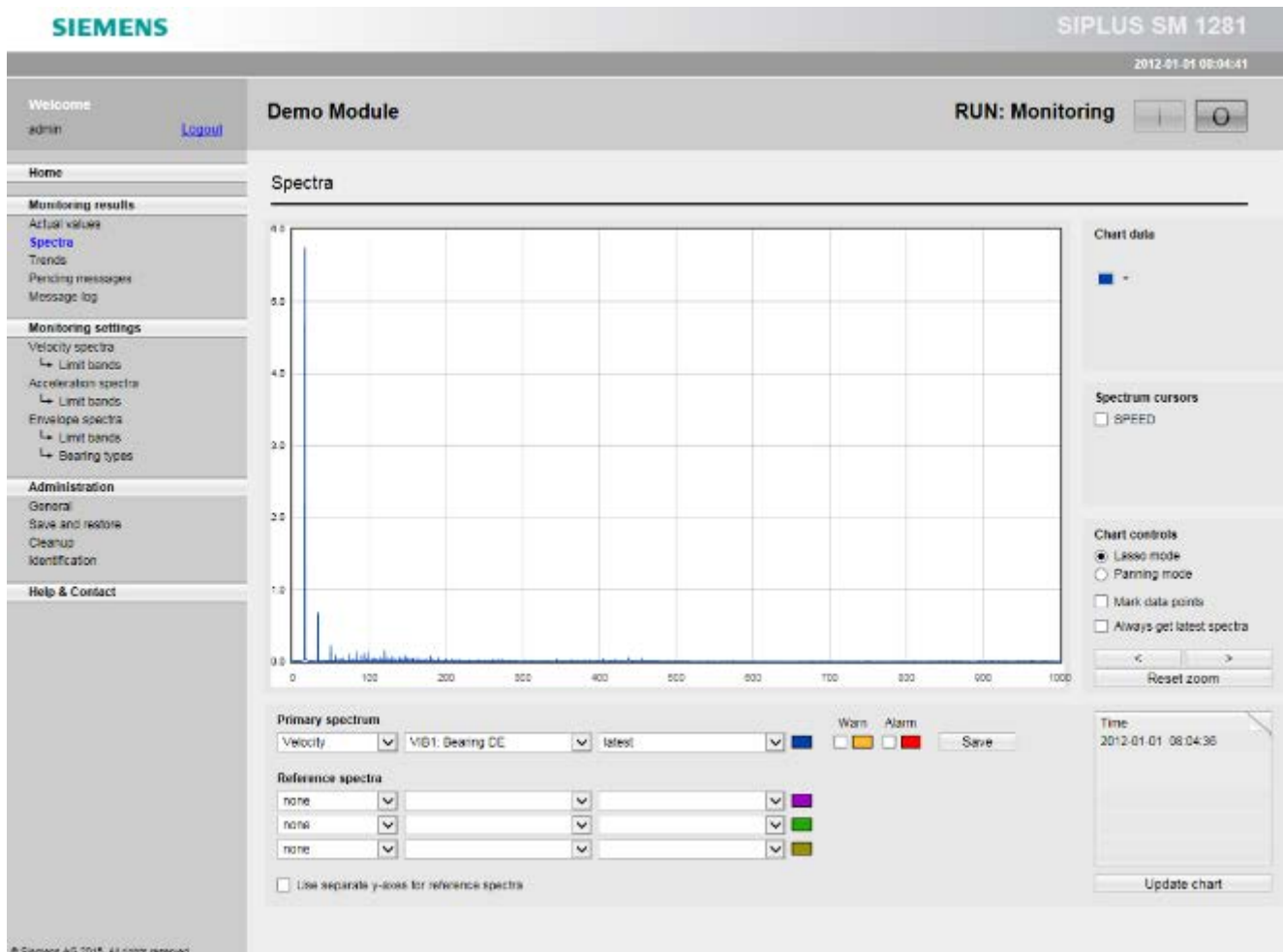

The x axis shows the frequency; the y axis, the amplitude.

Primary spectrum, reference spectra

To display spectra, choose one primary spectrum and up to three reference spectra.

To define a spectrum, select

- the type of spectrum: velocity, acceleration, envelope curve
- the IEPE channel: VIB1, VIB2...
- Either the current spectrum that was calculated last or a spectrum stored as a fingerprint

For the primary spectrum, you can additionally display the warning and alarm limits.

Clicking the "Update chart" button applies your settings and updates the chart display.

The color scheme for displaying the maximum of four curves is permanently defined.

You can define whether only the Y axis of the primary spectrum will be displayed or whether each reference spectrum will be displayed on a separate Y axis.

Note

Save settings

Your settings are only saved if the "Update chart" button has been pressed.

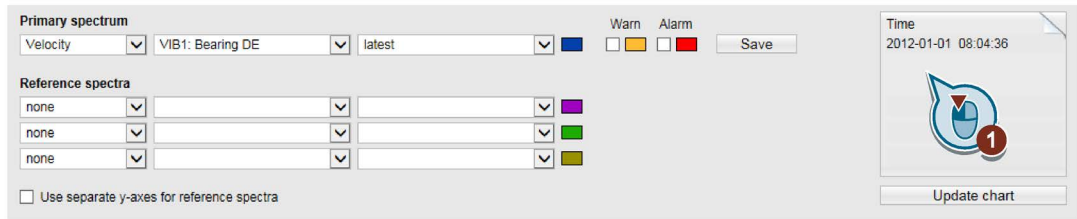

The current spectrum can only be displayed if the relevant IEPE channel has been configured and the spectrum has been calculated. Spectra from fingerprints, on the other hand, can be displayed irrespective of the current configuration and the current operating mode.

Saving a fingerprint

If a current frequency spectrum is displayed as the primary spectrum, you can save it with "Save" as a fingerprint with a freely selectable name.

Displaying other data

You can display further relevant data for each spectrum. Clicking the button (1) with the mouse pages through the following displays: Time stamp, aRMS, vRMS, speed.

Chart data

	<p>The frequency corresponding to the horizontal position of the mouse pointer is displayed.</p> <p>When you move the mouse pointer over the curves and limits displays, the associated values will be displayed.</p>
---	---

Cursor



	<p>For the selected primary spectrum, you can display markings in the charts based on the associated speed and the currently stored bearing type:</p> <ul style="list-style-type: none"> • For all spectra: Speed cursor (with multiples) • For envelope spectrum: Bearing fault frequencies (with multiples) <p>Meaning of the abbreviations: BPFO: Ball Passing Frequency Outer race BPFI: Ball Passing Frequency Inner race FTF: Fundamental Train Frequency (cage rotation) BSF: Ball Spin Frequency (rolling element rotation)</p>
---	---

Chart controls

	<p>Lasso mode: You show a magnified view of a specific section using the mouse wheel or lasso (drag the rectangle over the required area using the left mouse button).</p> <p>Panning mode: In this mode, you can pan the area of the screen being displayed holding the left mouse button down.</p> <p>Show data points: Highlight / hide curve interpolation points.</p> <p>Always get latest spectra: Active (checkbox selected): Cyclic updating of the displayed spectra Inactive (checkbox cleared): No cyclic updating of the displayed spectra. The current spectra available when this checkbox is cleared are retained until the checkbox is selected again.</p> <p>NOTE: Even if cyclic updating is not active, the current spectra are still calculated and monitoring for limit violations is performed. The monitoring results for the current spectra are displayed on the "Actual values" web page.</p>
	<p>With these buttons, you can horizontally shift the displayed frequency band.</p>
	<p>This button resets the display to the original time range.</p>
	<p>Apply settings and update chart display</p>

12.3.4.3 Trends

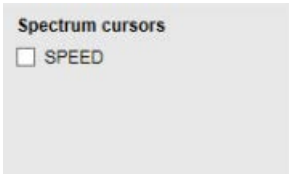
On the "Trends" web page, you can display characteristic values / measured values recorded by the system in a trend chart.

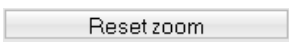
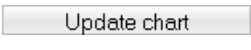
vRMS, aRMS and speed can be optionally displayed. The time interval can be selected.

To open the web page, click "Monitoring results"> Trends" in the navigation area.

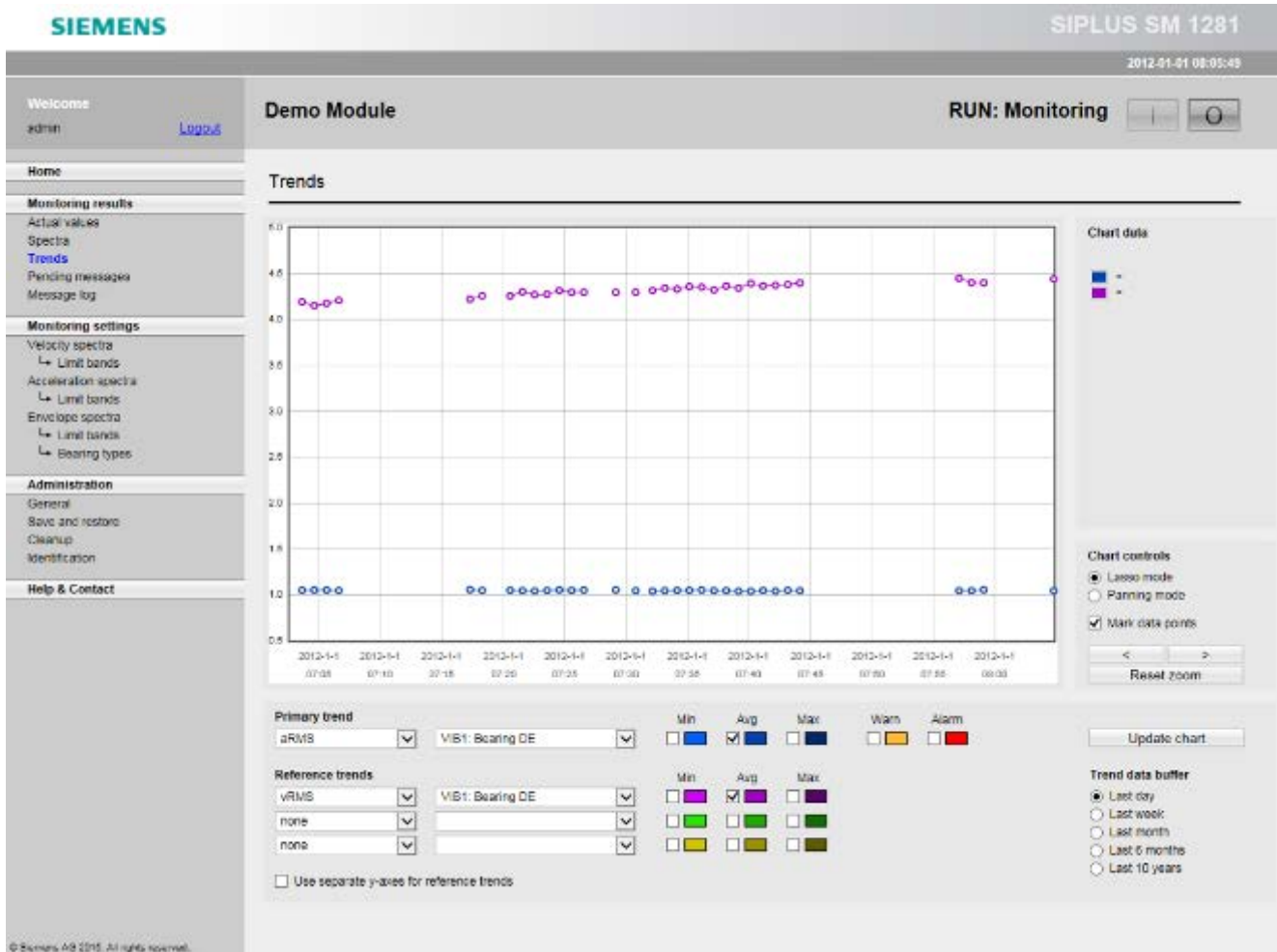

The x axis shows the time; the y axis the respective measured value in the appropriate units.

Note

Gaps in the display

Trend values are only entered into the archive and displayed in the trend chart if the SM 1281 is in the RUN mode. Gaps in the display (see figure) show that the module was not in the RUN mode.

Primary trend, reference trends

To display trend charts, you can choose

- any channel-related measured value as a primary value, e.g. aRMS on VIB1,
- up to three further channel-related values as reference values, e.g. vRMS on VIB2.

The screenshot shows a configuration panel for trend charts. It is divided into two main sections: 'Primary trend' and 'Reference trends'.
Primary trend: A dropdown menu is set to 'aRMS' and the channel is 'VIB1: Bearing DE'. There are checkboxes for 'Min' (blue), 'Avg' (checked, blue), and 'Max' (dark blue). There are also checkboxes for 'Warn' (yellow) and 'Alarm' (red).
Reference trends: Three dropdown menus are set to 'none'. The channel for all is 'VIB1: Bearing DE'. There are checkboxes for 'Min' (magenta), 'Avg' (checked, magenta), and 'Max' (purple).
Other options: A checkbox 'Use separate y-axes for reference trends' is unchecked. A 'Trend data buffer' section has radio buttons for 'Last day' (selected), 'Last week', 'Last month', 'Last 6 months', and 'Last 10 years'. An 'Update chart' button is on the right.

Up to 4 channel can be displayed at the same time. For each selected value, the minimum, maximum, and/or average value can be displayed. Up to 12 curves can be displayed in a fixed color scheme. For the "primary trend" you can additionally display the current warning and alarm limits specified by the S7.

You can define whether only the Y axis of the "primary trend" will be displayed or whether each "reference trend" will be displayed on a separate Y axis.

Chart controls

<p>The screenshot shows the 'Chart controls' panel with the following settings: - Lasso mode: Selected (radio button). - Panning mode: Inactive (radio button). - Mark data points: Checked (checkbox). - Navigation buttons: Left arrow, Right arrow, and a 'Reset zoom' button.</p>	<p>Lasso mode: A specific section can be magnified using the mouse wheel or lasso (drag the rectangle over the required area using the left mouse button). This zoom setting is retained if the chart is updated. NOTE: For zooming, fresh data is not fetched from the archive, i.e. a display that has been compressed due to the volume of data will not be displayed with a higher resolution through zooming. To do this, a smaller time interval must be selected.</p>
	<p>Panning mode: In this mode, the area of the screen being display can be shifted holding the left mouse button down. "Panning mode" can only be active if "Lasso mode" is inactive.</p>
	<p>Show data points: Highlight / hide curve interpolation points. NOTE: It is only appropriate to display the points if the display is already relatively detailed, i.e. when there are only a few curve points in the curve window.</p>
	<p>With these buttons, you can horizontally shift the displayed time range.</p>
	<p>This button resets the display to the original time range.</p>
	<p>Apply settings and update chart display.</p>

Trend data buffer

Trend data is only displayed for the selected time period if the duration in the RUN states is greater than the resolution of the selected time period.

<p>Trend data buffer</p> <p><input checked="" type="radio"/> Last day <input type="radio"/> Last week <input type="radio"/> Last month <input type="radio"/> Last 6 months <input type="radio"/> Last 10 years</p>	<p>Here, you can define which time range will be displayed from the trend data buffer. The smaller the time range chosen, the finer the time resolution of the data and therefore the greater the precision.</p> <ul style="list-style-type: none">• Last day: 1 minute (lowest resolution - high accuracy)• Last week: 10 minutes• Last month: 30 minutes• Last 6 months: 3 hours• Last 10 years: 24 hours (highest resolution - low accuracy)
---	---

Chart data

<p>Chart data</p> <p></p>	<p>The instant corresponding to the horizontal position of the mouse pointer is displayed. When you move the mouse pointer over the curves and limits displays, the associated numerical values will be displayed.</p>
---	--

12.3.4.4 Pending messages

All currently active messages are displayed on this website.

To open the page, click "Monitoring results > Pending messages" in the navigation area.

The screenshot shows the SIEMENS SIPLUS SM 1281 web user interface. The top navigation bar includes the SIEMENS logo, the title 'SIPLUS SM 1281', and the date '2012-01-01 08:06:01'. The main content area is titled 'Demo Module' and 'RUN: Monitoring'. The left sidebar contains navigation options: Welcome admin, Logout, Home, Monitoring results (Actual values, Spectra, Trends, Pending messages, Message log), Monitoring settings (Velocity spectra, Acceleration spectra, Envelope spectra), Administration (General, Save and restore, Cleanup, Identification), and Help & Contact. The 'Pending messages' section displays a table of active messages:

Active	Date	Time	Type	Text
Active	2012-01-01	08:04:08	Alarm	VIB1 Bearing DE: Alarm "Unbalance" on velocity spectrum. Limit violated at 16.8 Hz (5.748 > 5.300 mm/s). Speed: 1001.5 rpm.
Active	2012-01-01	08:04:08	Warning	VIB1 Bearing DE: Warning "Mask limit" on envelope spectrum. Limit violated at 16.6 Hz (0.262 > 0.200 m/s). Speed: 1001.5 rpm.
Active	2012-01-01	08:04:02	Alarm	VIB1 Bearing DE: vRMS alarm level violated (4.51 > 3.50 mm/s). Speed: 1001.9 rpm.
Active	2012-01-01	08:04:02	Warning	VIB1 Bearing DE: aRMS warning level violated (1.07 > 0.80 mm/s). Speed: 1001.9 rpm.

© Siemens AG 2015. All rights reserved.

The list of messages is sorted by the time of creation of the message, most recent first.

12.3.4.5 Message log

On this web page, you can view the message history.

To open the page, click "Monitoring results > Message log" in the navigation area.

The list of messages is sorted by the time of creation of the message, most recent first.

The screenshot shows the Siemens SIPLUS SM 1281 web interface. The main content area is titled "Message log" and displays a table of messages. The table has the following columns: Date, Time, Type, Text, and Action. The messages are sorted by time, with the most recent at the top. The types include Info, Alarm, and Warning.

Date	Time	Type	Text	Action
2012-01-01	08:04:16	Info	Recording of raw data initiated: trigger = event, duration = 10s, file = 20120101_040416_Demo Module_VIB1.wav.	In
2012-01-01	08:04:13	Info	Recording of raw data initiated: trigger = event, duration = 10s, file = 20120101_040413_Demo Module_VIB1.wav.	In
2012-01-01	08:04:08	Info	Recording of raw data initiated: trigger = event, duration = 10s, file = 20120101_040408_Demo Module_VIB1.wav.	In
2012-01-01	08:04:08	Alarm	VIB1 Bearing DE: Alarm "Unbalance" on velocity spectrum. Limit violated at 16.8 Hz (5.746 > 5.300 mm/s). Speed: 1001.5 rpm.	In
2012-01-01	08:04:08	Warning	VIB1 Bearing DE: Warning "Unbalance" on velocity spectrum. Limit violated at 16.8 Hz (5.746 > 4.100 mm/s). Speed: 1001.5 rpm.	In
2012-01-01	08:04:08	Warning	VIB1 Bearing DE: Warning "Mask limit" on envelope spectrum. Limit violated at 16.6 Hz (0.262 > 0.200 m/s). Speed: 1001.5 rpm.	In
2012-01-01	08:04:02	Alarm	VIB1 Bearing DE: vRMS alarm level violated (4.51 > 3.50 mm/s). Speed: 1001.9 rpm.	In
2012-01-01	08:04:02	Warning	VIB1 Bearing DE: vRMS warning level violated (4.51 > 2.50 mm/s). Speed: 1001.9 rpm.	In
2012-01-01	08:04:02	Warning	VIB1 Bearing DE: aRMS warning level violated (1.07 > 0.60 mm/s). Speed: 1001.9 rpm.	In
2012-01-01	08:03:49	Info	Operating mode RUN-Monitoring (user command).	In

Display filter

For displaying messages, you can use the following filters via a dropdown menu:

Filter	Meaning
Load all messages	Display All Messages
Load process messages	Only Display Process Messages
Load system messages	Only Display System Messages

After selecting an entry, this entry can be clicked.

Via a further selection box, you can select between 10 and 200 entries per page.

Displaying messages in the message log

Action	Description	Remarks
In	A message has arrived.	Example: A warning limit has been exceeded.
Out	A message has gone.	Example: The previously overshoot warning limit has been undershot again.
Out (cleanup)	A message has been automatically set to "Gone" by the system.	This is performed when the relevant channel can no longer be monitored, e.g. if data recording fails or the mode changes to STOP.

Navigating in the message log

<input type="button" value="<"/> <input type="button" value="<"/>	To the first item / one page back
<input type="button" value=">"/> <input type="button" value="> "/>	One page forward / to the last item
<input type="button" value="Goto date/time"/>	Opens a dialog box in which you state the time from which the entries will be displayed.

Navigating in the message log does not cause the most recent messages to be loaded. You can update the messages using the display filters (Load all messages, Load process, Load system).

12.3.5 Monitoring configuration

The **monitoring settings** encompass the websites which you need for setting the parameters for the monitoring algorithms and for defining the monitoring responses.

Three spectra are available for monitoring:

- Velocity spectrum (Page 130)
 - Velocity spectrum > Limit bands (Page 132)
- Acceleration spectrum (Page 135)
 - Acceleration spectrum > Limit bands (Page 137)
- Envelope spectrum (Page 141)
 - Envelope spectrum > Limit bands (Page 143)
 - Envelope spectrum > Bearing types (Page 146)

12.3.5.1 Velocity spectra

On the "Velocity spectra" page, you can activate the limits and define the associated limit bands. The settings refer exclusively to the vibration channels and the "velocity spectrum" monitoring method.

Note

You can only make changes in the operating mode "STOP: System ready".

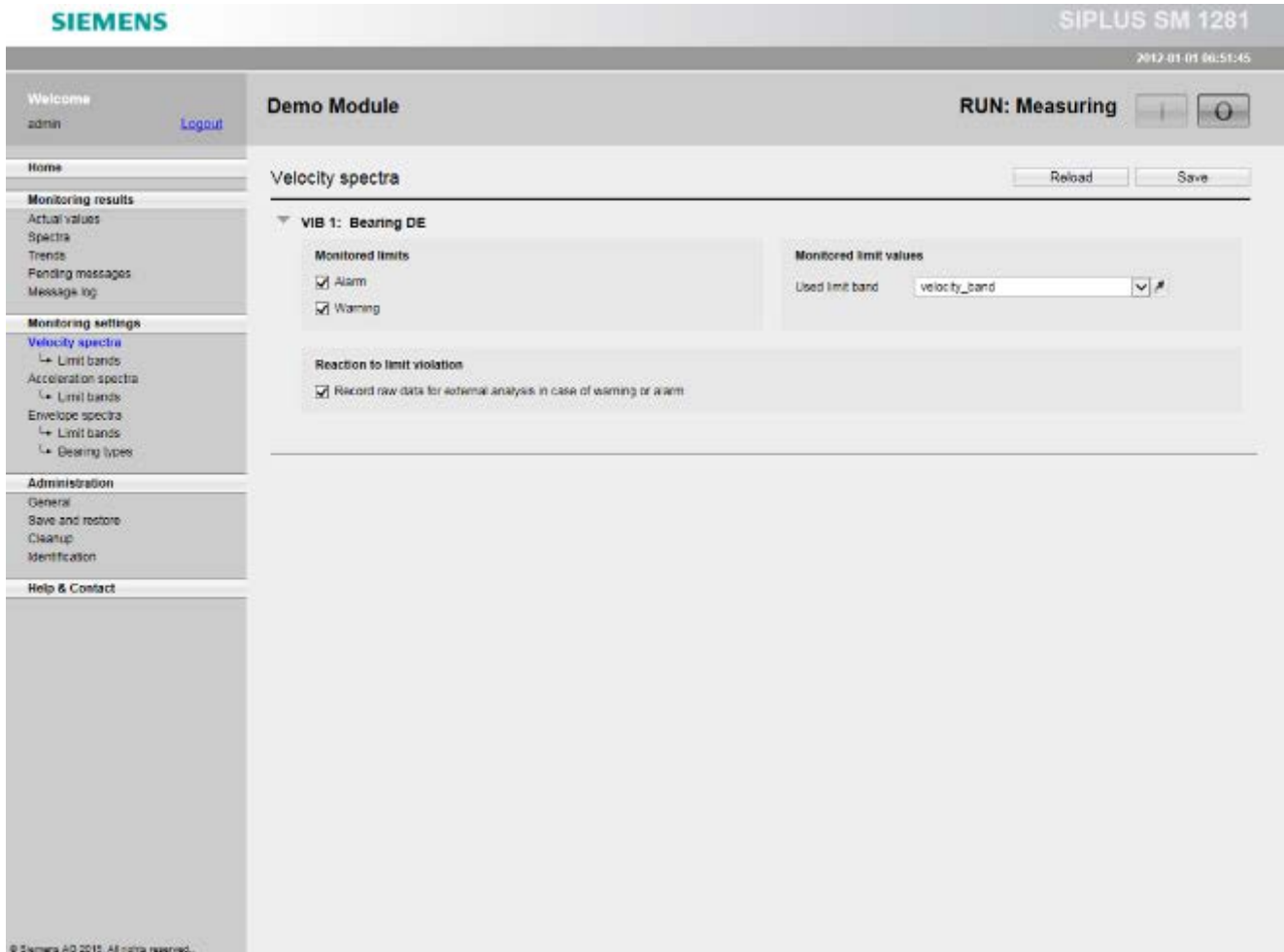



Monitored limits

Activate or deactivate monitoring of the warning / alarm limits for this channel.

Monitored limit band

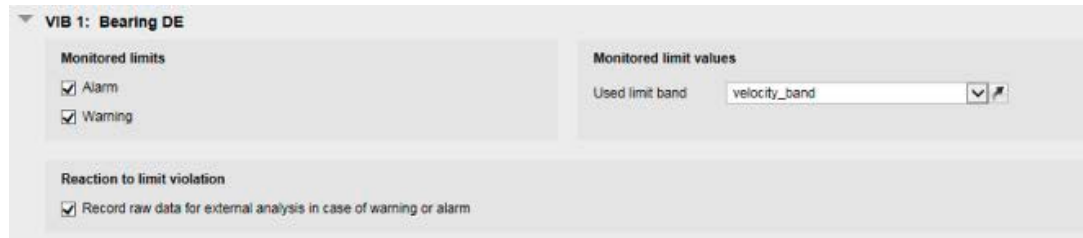
All of the previously created and saved limit bands can be selected via the selection box. You can assign a monitoring band from the list of the defined limit bands (Page 132). This band contains information as to which frequencies must be checked as well as the limits for the frequencies to be checked.



The icon  will take you directly to the page of the currently selected limit frequency band.

Reaction to limit violation

Here you activate the response to a limit violation.

- Start raw data recording

12.3.5.2 Velocity spectra > Limit bands

On the "Velocity spectrum band" page, you can create, modify and administer the limit bands for the velocity spectrum.

You can define speed-independent limits and speed-dependent limits.

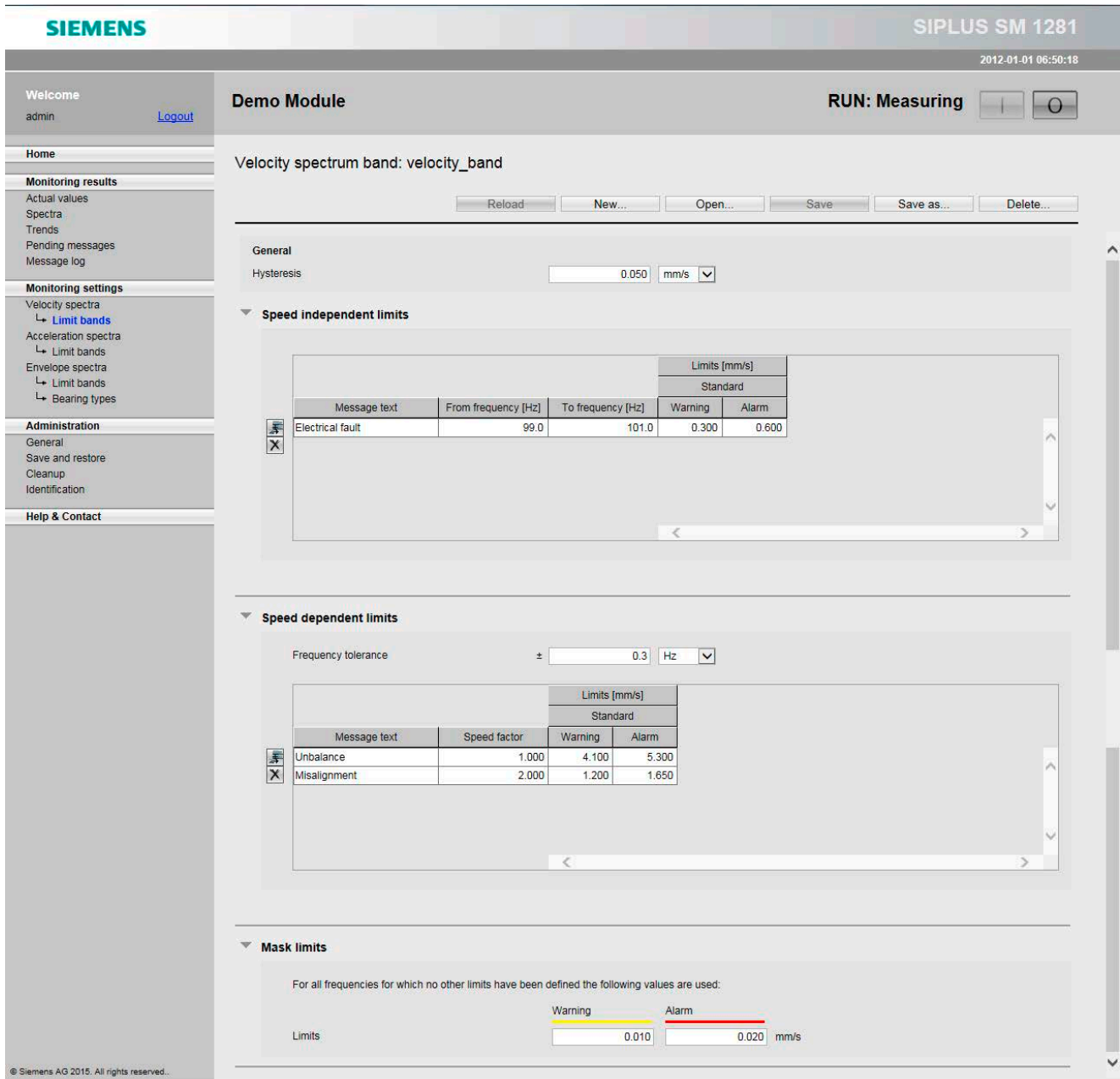

General

Here you define the hysteresis (Page 46) for the limit bands. This value applies to the entire limit band defined here.

You can specify the value in mm/s or as a percentage.

Speed-independent limits

Speed-independent peak monitoring of absolute frequency bands.

For each speed-independent monitoring function, you can specify a message text. This text will be included in the relevant process message to provide a clearer explanation when a limit is violated.

	Message text	From frequency [Hz]	To frequency [Hz]	Limits [mm/s]	
				Warning	Alarm
	Electrical fault	99.0	101.0	0.300	0.600

The warning limits and alarm limits in the tables do not have to be filled out completely. In this way, you can configure any part of the monitoring functions.

Speed-dependent limits

Speed-dependent peak monitoring of individual frequencies with settable frequency tolerance for monitoring.

For speed-dependent peak monitoring of individual frequencies, a frequency tolerance band for monitoring can be set.

The frequency tolerance can be specified absolutely in hertz or relatively as a percentage. It states the band around a certain frequency in the spectrum that will be monitored for limits. The default value for the frequency tolerance is ± 0.3 Hz.

For each speed-dependent monitoring function, you can specify a message text. This text will be included in the relevant process message to provide a clearer explanation when a limit is violated.

Frequency tolerance: \pm 0.3 Hz

	Message text	Speed factor	Limits [mm/s]	
			Warning	Alarm
	Unbalance	1.000	4.100	5.300
	Misalignment	2.000	1.200	1.650

The warning limits and alarm limits in the tables do not have to be filled out completely. In this way, you can configure any part of the monitoring functions.

Mask limits



Limits of the mask frequency band for monitoring remaining frequencies to cover the entire spectrum.

The mask frequency band covers the frequencies not yet monitored by one of the limits defined above.







Operating functions

Inserting/deleting rows

You can insert new rows and delete rows using the buttons to the left of the table.

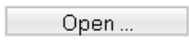
Button	Meaning
	Inserting a row A new row is always added at the end of the table.
	Deleting a row Selecting the row to be deleted

Creating, loading, saving, deleting limit bands

Button	Meaning
	All entries on the page are rejected and the previous values are displayed again.
	You can create a new band of limits using the "New ..." button. A window opens in which the name for the new limit band must be entered. After the "OK" button has been clicked, a new band is created with the specified name. Unsaved changes to existing bands are lost as a result. The new band of limits is not saved until the "Save" button is clicked.
	When the "Open ..." button is clicked, a window opens that contains a list of saved limit bands. After a list entry has been selected and the "OK" button has been clicked, the selected limit band is loaded and displayed.
	With the "Save" button, the changes of the currently loaded limit band will be saved.
	With the "Save as ..." button, an existing limit band can be saved with a new name. A window opens in which the new name can be entered. After the "OK" button has been clicked in the window, the limit band is saved with the new name and also displayed as the current limit band. Limit bands can be copied in this manner. After the copy has been edited, the changes must be saved by clicking the "Save" button.
	You can delete an existing limit band from the archive using the "Delete ..." button. A window opens that contains the name of the currently displayed limit band. After the "OK" button has been clicked, the limit band of this name will be deleted from the archive. The first limit band found in the archive will then be displayed as the current limit band.

12.3.5.3 Acceleration spectra

On the "Acceleration spectra" page, you can activate the limits and define the associated limit bands. The settings refer exclusively to the vibration channels and the "acceleration spectrum" monitoring method.

Note

You can only make changes in the operating mode "STOP: System ready".

The screenshot displays the SIEMENS SIPLUS SM 1281 web interface. The top navigation bar includes the SIEMENS logo, the device name 'SIPLUS SM 1281', and the date/time '2012-01-01 06:55:14'. The main content area is titled 'Demo Module' and shows the system is in 'RUN: Measuring' mode. The 'Acceleration spectra' page is active, showing configuration for 'VIB 1: Bearing DE'. Under 'Monitored limits', both 'Alarm' and 'Warning' are checked. The 'Monitored limit values' section shows 'Used limit band' set to 'acc_band'. Under 'Reaction to limit violation', 'Record raw data for external analysis in case of warning or alarm' is checked. The left sidebar contains navigation menus for 'Monitoring results', 'Monitoring settings', 'Administration', and 'Help & Contact'. A URL bar at the bottom shows 'http://192.168.1.200/isapi/server.dll?action=page&data=support'.

Monitored limits

Activate or deactivate monitoring of the warning / alarm limits for this channel.

Monitored limit band

All of the previously created and saved limit bands can be selected via the selection box. You can assign a monitoring band from the list of the defined limit bands (Page 137). This band contains information as to which frequencies must be checked as well as the limits for the frequencies to be checked.



The link icon will take you directly to the page of the currently selected limit frequency band.

Reaction to limit violation

Here you activate the response to a limit violation.

- Start raw data recording

12.3.5.4 Acceleration spectra > Limit bands

On the "Acceleration spectrum band" page, you can create, modify and administer the limit bands for the acceleration spectrum.

You can define speed-independent limits and speed-dependent limits.

The screenshot shows the SIPLUS SM 1281 web user interface. The top right corner displays 'SIPLUS SM 1281' and the date/time '2012-01-01 06:54:23'. The main header includes 'Welcome admin' with a 'Logout' link, 'Demo Module', and 'RUN: Measuring' with control buttons. The left sidebar contains navigation options: Home, Monitoring results (Actual values, Spectra, Trends, Pending messages, Message log), Monitoring settings (Velocity spectra, Acceleration spectra, Envelope spectra), Administration (General, Save and restore, Cleanup, Identification), and Help & Contact.

The main content area is titled 'Acceleration spectrum band: acc_band' and includes buttons for 'Reload', 'New...', 'Open...', 'Save', 'Save as...', and 'Delete...'. Below this are three sections:

- General:** Hysteresis is set to 0.000 m/s².
- Speed independent limits:** A table with columns: Message text, From frequency [Hz], To frequency [Hz], Warning, and Alarm. One entry is 'Bearing wear' with a warning limit of 0.150 and an alarm limit of 0.200.
- Speed dependent limits:** Frequency tolerance is set to ± 0.3 Hz. A table with columns: Message text, Speed factor, Warning, and Alarm. One entry is 'Meshing defect' with a warning limit of 0.320 and an alarm limit of 0.450.
- Mask limits:** A note states: 'For all frequencies for which no other limits have been defined the following values are used:'. Below this are input fields for Warning and Alarm limits in m/s².

© Siemens AG 2015. All rights reserved.

General

Here you define the hysteresis (Page 46) for the limit bands. The value applies to all the limit bands defined here.

You can specify the value in m/s² or as a percentage.

Speed-independent limits

The limits you create here are speed-independent. For each speed-independent monitoring function, you can specify a message text. This text will be included in the relevant process message to provide a clearer explanation when a limit is violated.

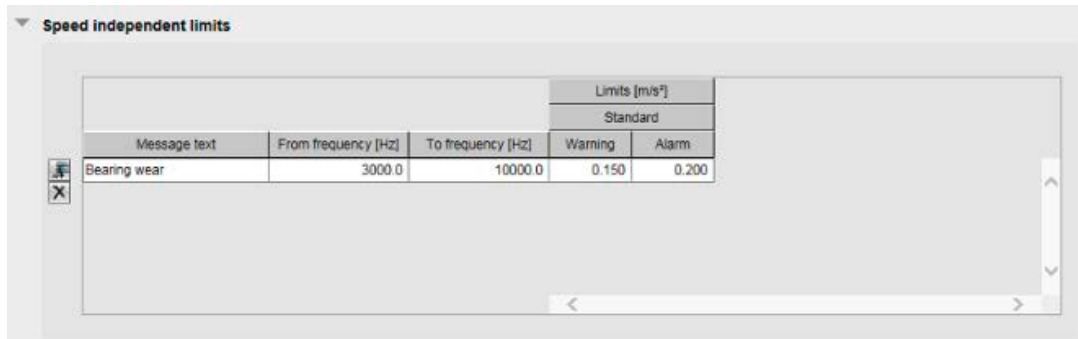

The warning limits and alarm limits in the tables do not have to be filled out completely. In this way, you can configure any part of the monitoring functions.

Speed-dependent limits

Speed-dependent peak monitoring of individual frequencies with settable frequency tolerance for monitoring.

For speed-dependent peak monitoring of individual frequencies, a frequency tolerance band for monitoring can be set.

The frequency tolerance can be specified absolutely in hertz or relatively as a percentage. It states the band around a certain frequency in the spectrum that will be monitored for limits. The default value for the frequency tolerance is ± 0.3 Hz.

For each speed-dependent monitoring function, you can specify a message text. This text will be included in the relevant process message to provide a clearer explanation when a limit is violated.

Speed dependent limits				
Frequency tolerance		± 0.3 Hz		
Message text	Speed factor	Limits [m/s ²]		
		Warning	Alarm	
Meshing defect	2.500	0.320	0.450	

The warning limits and alarm limits in the tables do not have to be filled out completely. In this way, you can configure any part of the monitoring functions.

The limit values for warning and alarm can be omitted. These limit values are then also not monitored.

Mask limits



Limits of the mask frequency band for monitoring remaining frequencies to cover the entire spectrum.

The mask frequency band covers the frequencies not yet monitored by one of the limits defined above.





Operating functions

Inserting/deleting rows

You can insert new rows and delete rows using the buttons to the left of the table.

Button	Meaning
	Inserting a row A new row is always added at the end of the table.
	Deleting a row Selecting the row to be deleted

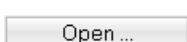
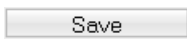
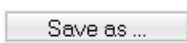
Creating, loading, saving, deleting limit bands

Button	Meaning
	All entries on the page are rejected and the previous values are displayed again.
	You can create a new band of limits using the "New ..." button. A window opens in which the name for the new limit band must be entered. After the "OK" button has been clicked, a new band is created with the specified name. Unsaved changes to existing bands are lost as a result. The new band of limits is not saved until the "Save" button is clicked.
	When the "Open ..." button is clicked, a window opens that contains a list of saved limit bands. After a list entry has been selected and the "OK" button has been clicked, the selected limit band is loaded and displayed.
	With the "Save" button, the changes of the currently loaded limit band will be saved.
	With the "Save as ..." button, an existing limit band can be saved with a new name. A window opens in which the new name can be entered. After the "OK" button has been clicked in the window, the limit band is saved with the new name and also displayed as the current limit band. Limit bands can be copied in this manner. After the copy has been edited, the changes must be saved by clicking the "Save" button.
	You can delete an existing limit band using the "Delete ..." button. A window opens that contains the name of the currently displayed limit band. After the "OK" button has been clicked, the limit band of this name will be deleted from the archive. The first limit band found in the archive will then be displayed as the current limit band.

12.3.5.5 Envelope spectra

On the "Envelope spectra" page, you can activate the limits and define the associated limit bands. The settings refer exclusively to the vibration channels and the "envelope spectrum" monitoring method.

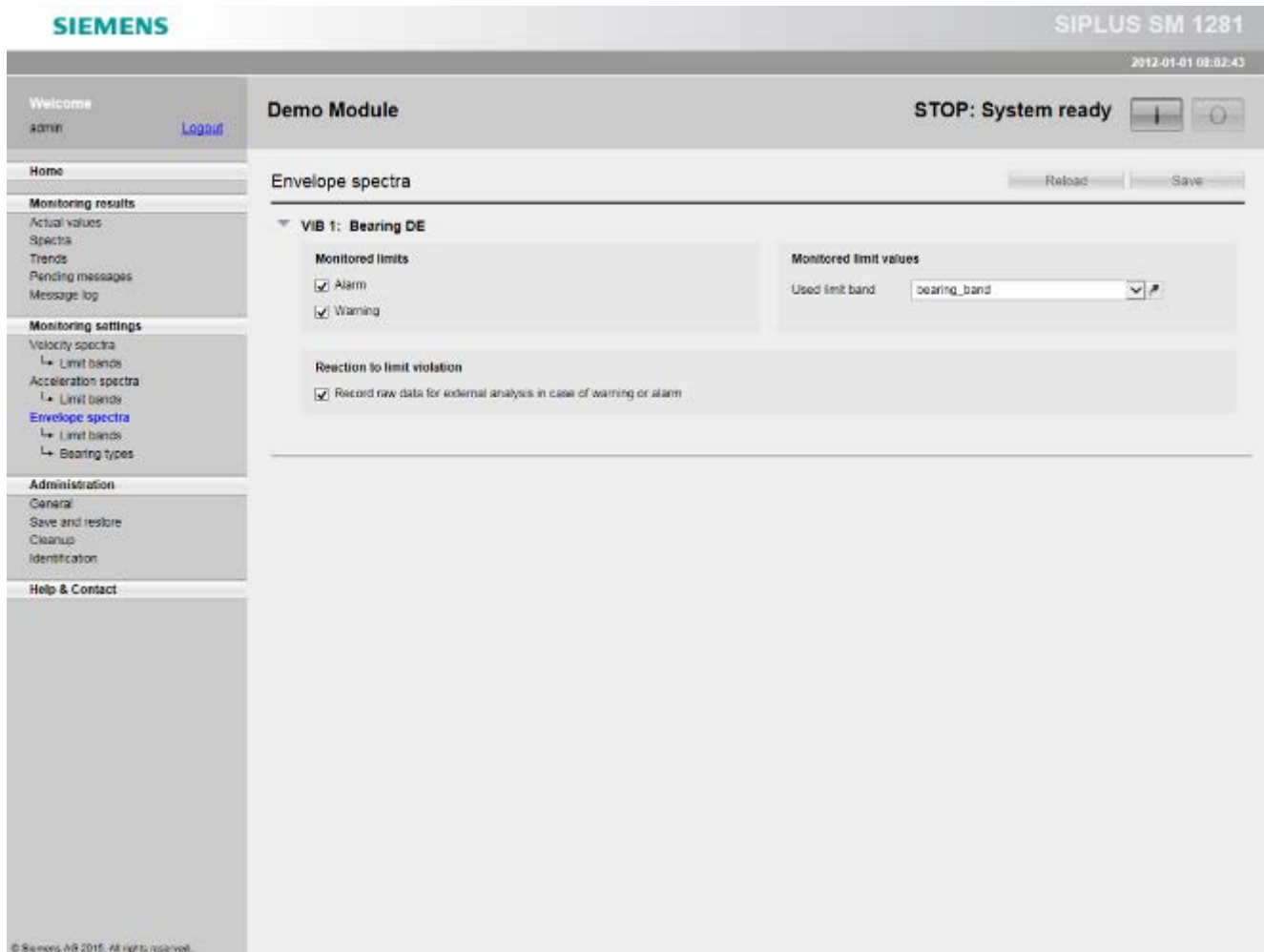

Monitored limits

Activate or deactivate monitoring of the warning / alarm limits for this channel.

Monitored limit band

All of the previously created and saved limit bands can be selected via the selection box. You can assign a monitoring band from the list of the defined limit bands (Page 143). This band contains information as to which frequencies must be checked as well as the limits for the frequencies to be checked.

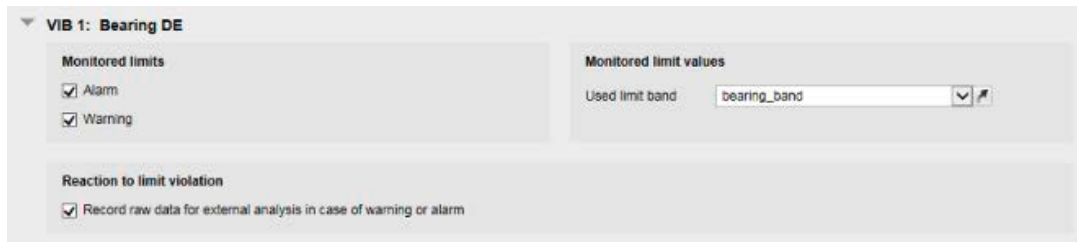

The screenshot shows a configuration panel for a monitored limit band. The panel is titled "VIB 1: Bearing DE". It is divided into three sections:

- Monitored limits:** Contains two checked checkboxes: "Alarm" and "Warning".
- Monitored limit values:** Contains a label "Used limit band" followed by a dropdown menu showing "bearing_band" and a small icon with a right-pointing arrow.
- Reaction to limit violation:** Contains one checked checkbox: "Record raw data for external analysis in case of warning or alarm".

The icon  will take you directly to the page of the currently selected limit frequency band.

Reaction to limit violation

Here you activate the response to a limit violation.

- Start raw data recording

12.3.5.6 Envelope spectra > Limit bands

On the "Envelope spectrum band" page, you can create, modify and administer the limit bands for the envelope spectrum.

You can define speed-dependent limits.

The screenshot shows the Siemens SIPLUS SM 1281 web user interface. The top bar displays the Siemens logo, the system name 'SIPLUS SM 1281', and the time '2012-01-01 00:00:35'. The main content area is titled 'Envelope spectrum band: bearing_band' and includes buttons for 'Reload', 'New...', 'Open...', 'Save', 'Save as...', and 'Delete...'. The configuration is divided into three sections:

- General:** Hysteresis is set to 10.000 %.
- Speed dependent limits:**
 - Used bearing type: bearing
 - Frequency tolerance: ± 0.3 Hz
 - A table defining limits for various defect types and speed factors.
- Mask limits:**
 - Warning limit: 0.200 m/s²
 - Alarm limit: 0.300 m/s²

Message text	Speed factor	Limits [m/s ²]	
		Warning	Alarm
Inner race defect	1st order	0.750	1.000
Inner race defect	2nd order	0.600	0.850
Inner race defect	3rd order	0.500	0.700
Outer race defect	1st order	0.800	1.200
Outer race defect	2nd order	0.600	0.900
Outer race defect	3rd order	0.400	0.600

General

Here you define the hysteresis (Page 46) for the limit bands. This value applies to the entire limit band defined here.

You can specify the value in m/s² or as a percentage.

Speed-dependent limits

Speed-dependent peak monitoring of individual frequencies with settable frequency tolerance for monitoring.

Select a bearing from the list of defined bearings. Bearings are defined on the website "Envelope spectra > Bearing types" (Page 146).

For speed-dependent monitoring of individual frequencies, a frequency tolerance band for monitoring can be set.

The frequency tolerance can be specified absolutely in hertz or relatively as a percentage. It states the band around a certain frequency in the spectrum that will be monitored for limits. The default value for the frequency tolerance is ± 0.3 Hz.

The message texts for the 4 types of damage are predefined and can be selected under "Message text".

This text will be included in the relevant process message to provide a clearer explanation when a limit is violated.

The thresholds can be specified for up to five orders of magnitude (multiples of the respective fault frequencies).

You can configure not only the predefined bearing frequencies but also any speed-dependent monitoring functions.

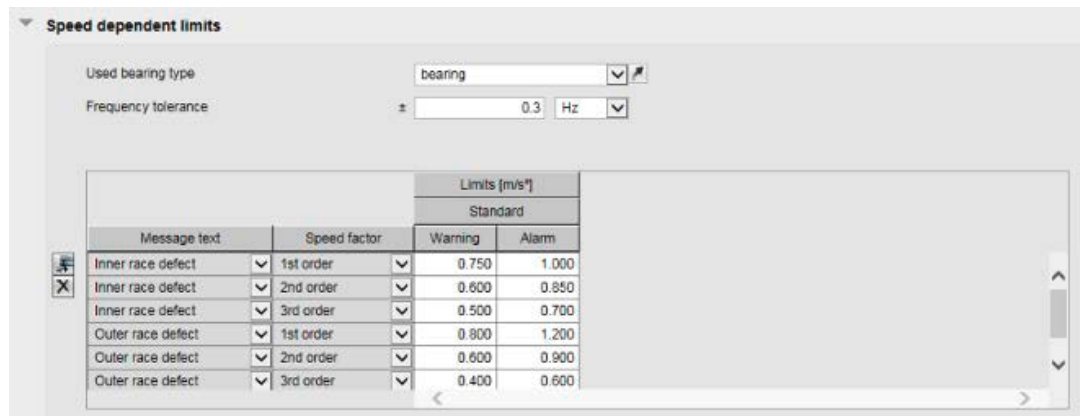

The warning limits and alarm limits in the tables do not have to be filled out completely. In this way, you can configure any part of the monitoring functions.

Mask limits



Limits of the mask frequency band for monitoring remaining frequencies to cover the entire spectrum.

The mask frequency band covers the frequencies not covered by the methods stated above.





Operating functions

Inserting/deleting rows

You can insert new rows and delete rows using the buttons to the left of the table.

Button	Meaning
	Inserting a row A new row is always added at the end of the table.
	Deleting a row Selecting the row to be deleted

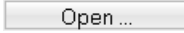
Creating, loading, saving, deleting limit bands

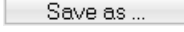
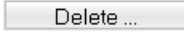
Button	Meaning
	All entries on the page are rejected and the previous values are displayed again.
	You can create a new band of limits using the "New ..." button. A window opens in which the name for the new limit band must be entered. After the "OK" button has been clicked, a new band is created with the specified name. Unsaved changes to existing bands are lost as a result. The new band of limits is not saved until the "Save" button is clicked.
	When the "Open ..." button is clicked, a window opens that contains a list of saved limit bands. After a list entry has been selected and the "OK" button has been clicked, the selected limit band is loaded and displayed.
	With the "Save" button, the changes of the currently loaded limit band will be saved.
	With the "Save as ..." button, an existing limit band can be saved with a new name. A window opens in which the new name can be entered. After the "OK" button has been clicked in the window, the limit band is saved with the new name and also displayed as the current limit band. Limit bands can be copied in this manner. After the copy has been edited, the changes must be saved by clicking the "Save" button.
	You can delete an existing limit band using the "Delete ..." button. A window opens that contains the name of the currently displayed limit band. After the "OK" button has been clicked, the limit band of this name will be deleted from the archive. The first limit band found in the archive will then be displayed as the current limit band.

12.3.5.7 Envelope spectra > Bearing types

On the "Bearing types" page, you can create, modify and administer the data for the different bearing types.

The data stored for each bearing type is used in the bearing analysis to determine the fault frequencies for the outer race, inner race, rolling elements (balls) and cage. The limit bands for bearing analysis contain limits in accordance with these fault frequencies.

To open the page, click "Monitoring settings > Envelope spectra > Bearing types" in the navigation area.

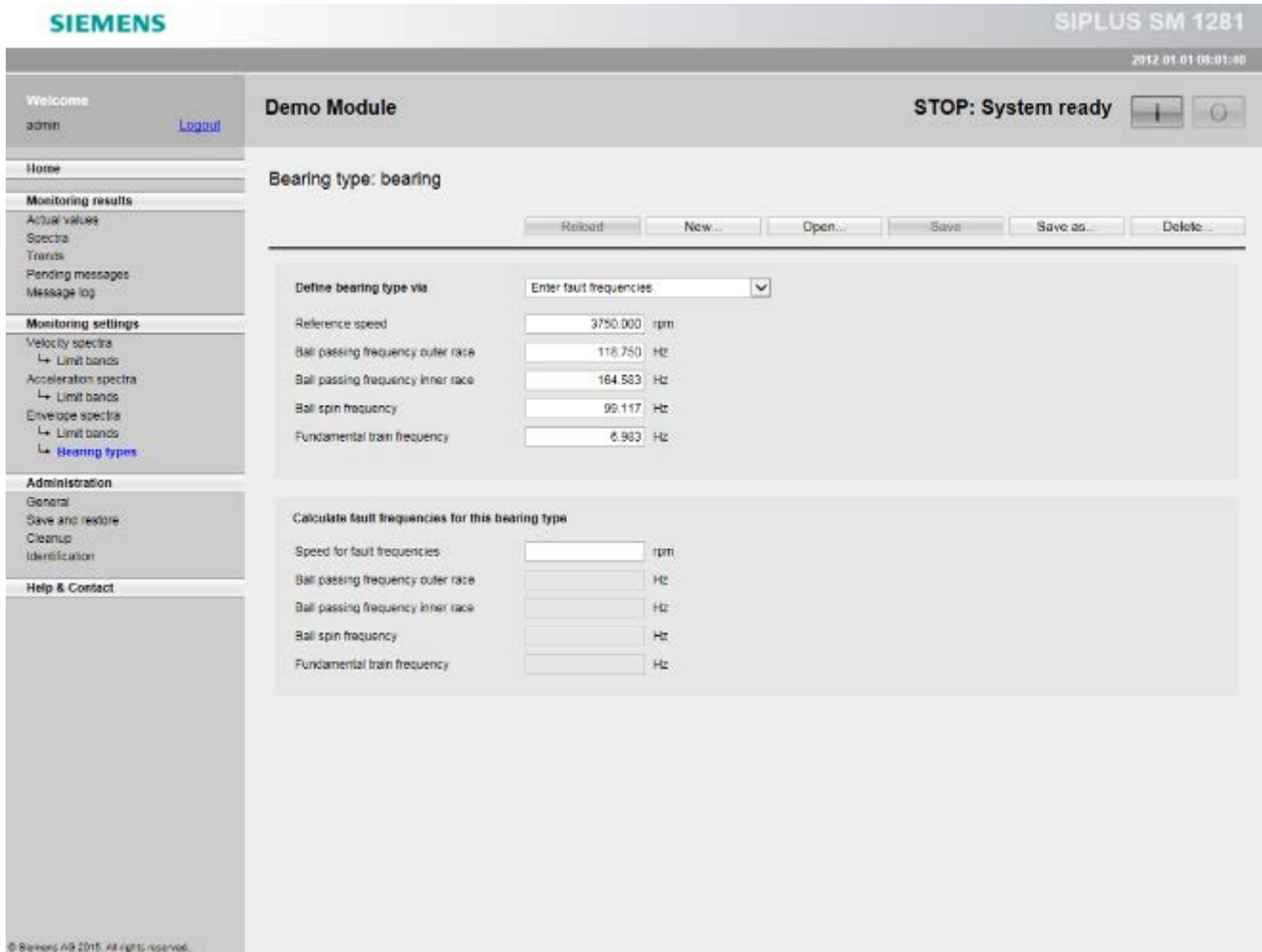

You can choose between the following two input modes for the bearing type parameter:

- Direct entry of the fault frequencies
- Input of the bearing geometry

Direct entry of the fault frequencies

Calculate fault frequencies for this bearing type

Speed for fault frequencies	<input type="text"/>	rpm
Ball passing frequency outer race	<input type="text"/>	Hz
Ball passing frequency inner race	<input type="text"/>	Hz
Ball spin frequency	<input type="text"/>	Hz
Fundamental train frequency	<input type="text"/>	Hz

For direct entry of the frequencies, you enter a speed as the reference value and the bearing fault frequencies for outer race, inner race, rolling element and cage. An incomplete entry of the fault frequencies is also accepted, but in this case you will be unable to activate monitoring of the bearing for a particular type of damage.

Input of the bearing geometry

Define bearing type via

Contact angle α	<input type="text" value="0.0"/>	°
Pitch circle diameter D_{pw}	<input type="text"/>	mm
Ball diameter D_w	<input type="text"/>	mm
Number of rolling elements Z	<input type="text"/>	

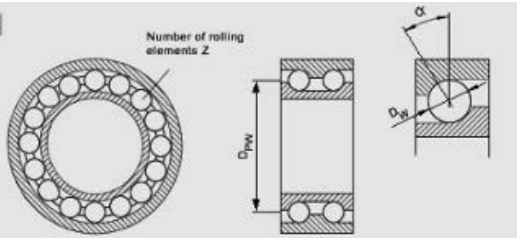

For entry of the bearing geometry, four geometric characteristic values are specified:

- Contact angle of the rolling element (ball) in the cage α
- Ball diameter D_{pw}
- Ball diameter D_w
- Number of balls Z

Fault frequency calculator

The "Bearing types" menu contains a fault frequency calculator. After a speed ("Speed for fault frequencies") has been entered, the bearing fault frequencies for outer race and inner race, the rolling element and cage are displayed immediately for the current bearing type.

12.3.6 Administration

Administration encompasses the websites on which you can manage the SM 1281 and the data:

- General (Page 149)
- Save and restore (Page 152)
- Cleanup (Page 154)
- Identification (Page 157)

Note

You can only make changes in the operating mode "STOP: System ready".

See also

Factory settings and default settings (Page 156)

12.3.6.1 General

You can make general administration settings on the "General" page: Click "Save" to save inputs.

To open the page, click "Administration > General" in the navigation area.

The screenshot displays the web interface for the SIPLUS SM 1281. The top header shows the SIEMENS logo on the left and the system name 'SIPLUS SM 1281' on the right, along with the date and time '2012-01-01 06:32:33'. Below the header, there is a navigation menu on the left with options like 'Welcome admin', 'Home', 'Monitoring results', 'Monitoring settings', 'Administration', and 'Help & Contact'. The main content area is titled 'Demo Module' and 'General'. It contains several sections: 'Raw data recording' with fields for 'Record duration' (set to 10) and 'Decimation factor' (set to 1); 'Settings for web interface' with a dropdown for 'Language on web interface' (set to English) and a warning 'Caution: Changing the device language causes logout'; 'Device name' (set to 'Demo Module'), and four input fields for 'Name of channel 1' through 'Name of channel 4' (the first is 'Bearing DE'); a 'Password' section with a 'Change password...' button; and a 'Restart SM 1281' section with a 'Restart' button. The bottom left corner of the page has the copyright notice '© Siemens AG 2015. All rights reserved.'

Recording raw data

- Recording time: You can enter 1 to 90 seconds.
- Decimation factor: The decimation reduces the scan rate and, as a result, the size of the raw data file. As a result, more raw data recordings are possible.

The maximum recording duration is independent of the decimation factor.

Web interface settings

- Device name: Here you enter the name of the device. It will appear in the title area and on the page Identification (Page 157).
- Device language: You can switch the language of the web interface between English and German.
A change of languages logs off the user.

Note

To be able to make entries, he must log in again after being logged off.

Password

To change the password stored in the device, click "Change password". The corresponding dialog box opens. Enter the old and new password, and repeat the new password. The password must have a length between 4 and 40 characters. The following characters are permissible:

- Uppercase and lowercase letters: a to z and A to Z, no umlauts
- Numbers: 0 to 9
- Special characters "-" and "_"

NOTICE
Safely keeping the password
Once the password is set, the configuration/parameterization cannot be changed without entering the password. The password also cannot be changed or reset. Therefore, keep your password safe!

Restarting SM 1281

A system restart can be performed by clicking the "Restart" button, for a firmware update.

Note

During the restart

During the restart, operation via the browser is not possible, because the connection to the device has been interrupted.

Note

After the restart

To be able to make entries, you must log in again after the restart.

CAUTION

Critical system state

The Ethernet switch that is built into the SM 1281 is only in operation after the module is started up. A restart of the SM 1281 interrupts the Ethernet switch function.

As a result, existing Ethernet connections via the switch are interrupted for the duration of the start-up of the SM 1281. This can lead to critical system states.

12.3.6.2 Save and restore

On the "Save and restore" page, you can download data that is stored in the device. This data can be used for the data exchange with a different SM 1281 device.

The raw data can be further processed using software that can read WAV files.

To open the page, click "Administration > Save and restore" in the navigation area.

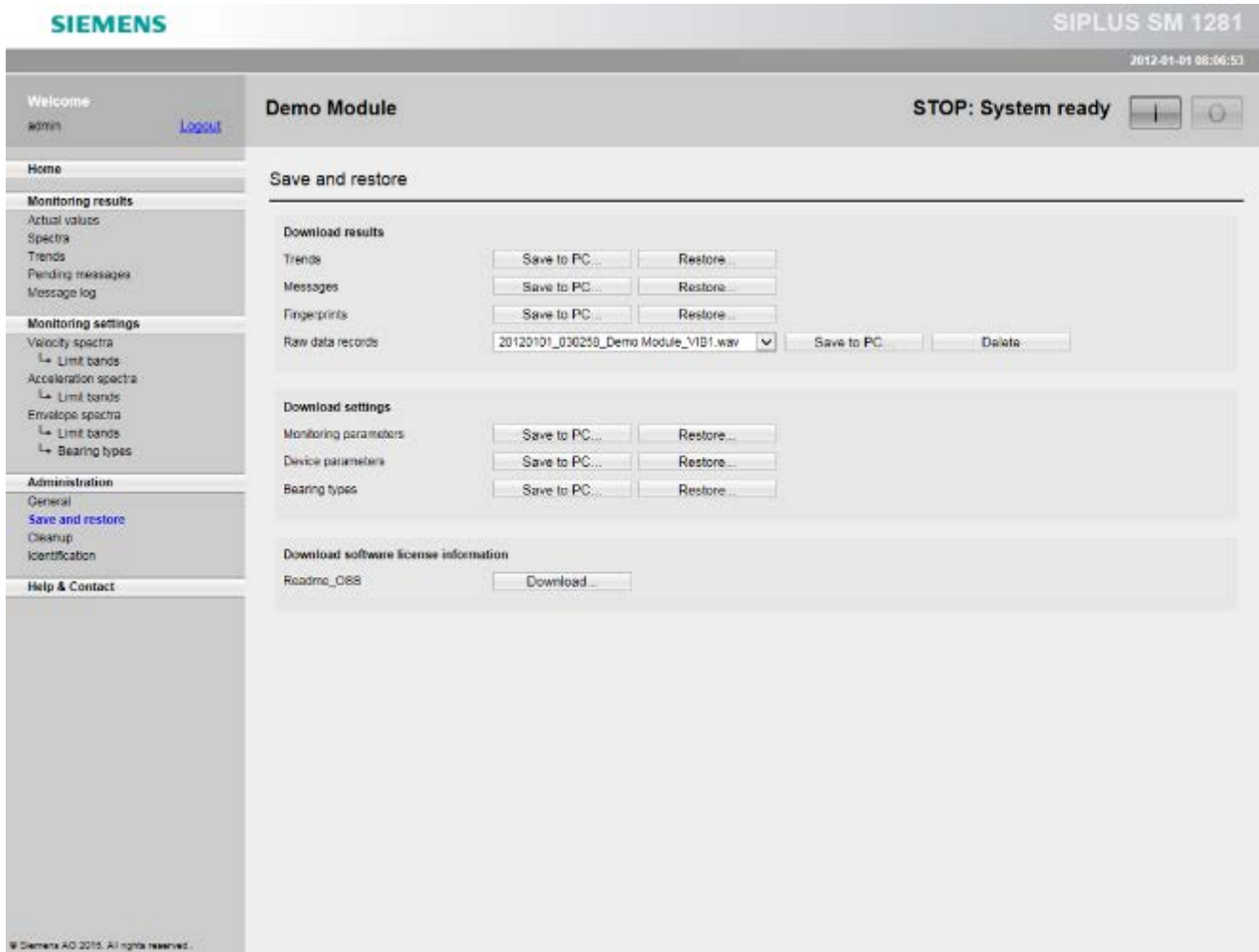

Uploading and downloading results

Trends	Trends are the measured variables stored in the various time resolutions.
Messages	Messages created based on events, e.g. limit value violations.
Fingerprints	All the "Fingerprints" are saved in this database file.
Raw data records	<p>Raw data are recorded in WAV files. A WAV file is generated for each recording of raw data.</p> <ul style="list-style-type: none"> • Downloading raw data: Select a file from the list of existing files and click the "Save to PC..." button next to it. • Deleting raw data: Select a file from the list of existing files and click the "Delete" button next to it.

Uploading and downloading settings

Download data	Description
Monitoring parameters	This file contains all monitoring parameters, e.g. limit bands, responses to limit violations.
Device parameters	This database file contains the device parameters.
Bearing types	This database file contains all the types of bearings that have been defined.

Password

Downloading of files from the device is secured by an additional authentication. The default login name must be entered as the default login name "admin". The password required is the one that was most recently set in the device administration on the appropriate web page. If the password was not changed here, the default password "0000" (four times zero) applies.

Download software license information

Here, you can download the license conditions of the open source software used in the SM 1281 system as a PDF file.

12.3.6.3 Cleanup

On the "Cleanup" page, you can delete unneeded data from the device or reset the device to the factory settings.

The following data can be deleted:

- Trends
- Messages
- Raw data records
- Fingerprints
- Monitoring parameters

Note

Deleted data cannot be restored.

To open the page, click "Administration > Cleanup" in the navigation area.

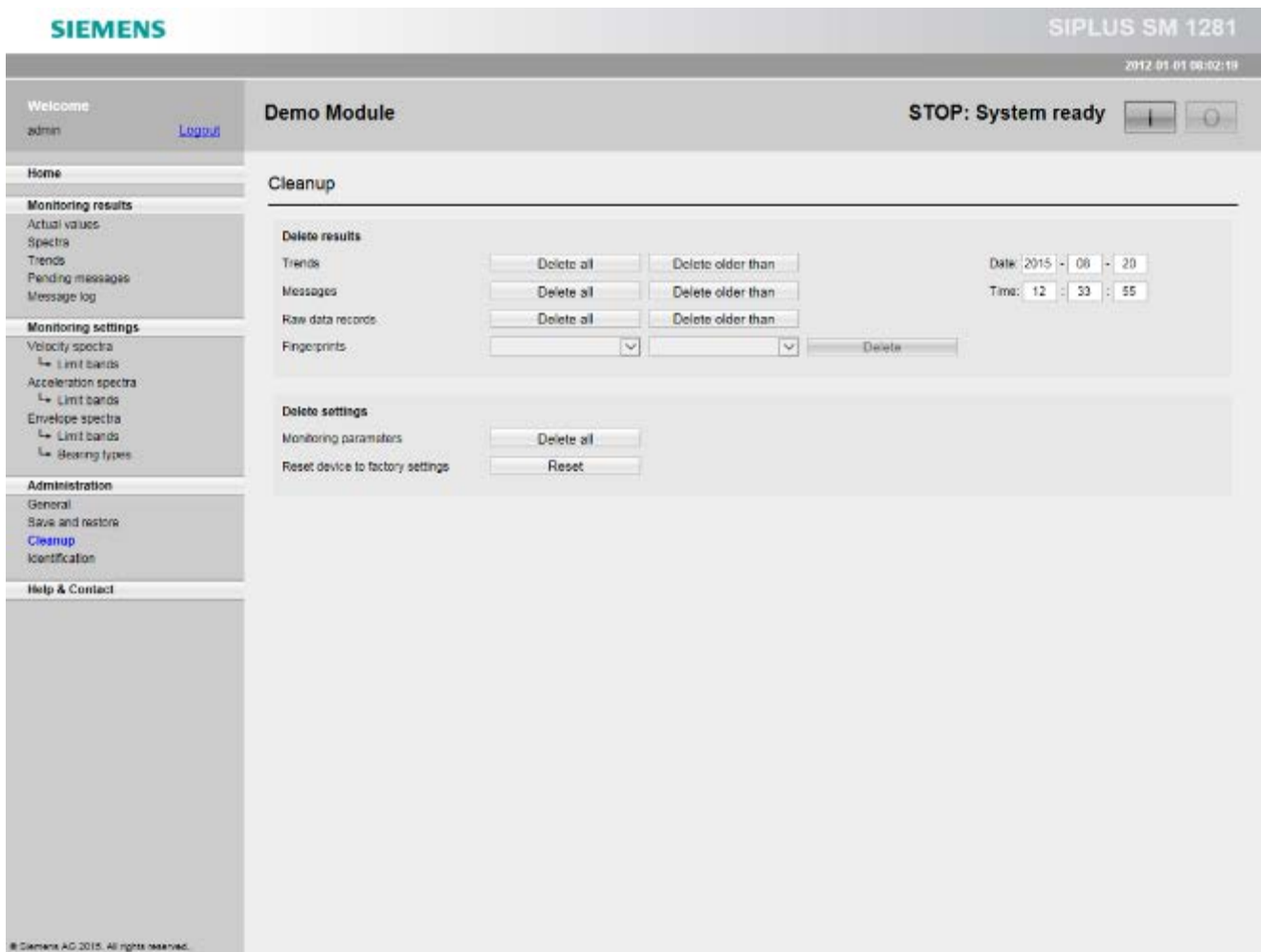

Requirement

In "RUN" mode, you can delete the "Fingerprints" and the "Raw data records." All other functions of the "Cleanup" page can only be performed in STOP mode.

Deleting trends, messages, raw data records

You have the following options for deleting trends, messages, and raw data records:

- Delete all data in one step
- Delete only data that are older than a set time

When you open the page, the current date and time are automatically entered as the default setting. Enter the required values for the time from which all values are to be deleted in the date and time fields.

Safety query: Clicking on the "Delete all" button or "Delete older than" button opens a dialog box, in which you must confirm the deletion. The data will only be deleted after confirming with "OK".

Deletion is performed in the background and, depending on the quantity of data, can take several minutes. If the cleanup procedure is not completed before the device is switched off, the data will not be deleted or only incompletely deleted.

Deleting fingerprints

Fingerprints are saved with a name with reference to the channel.

The names of all fingerprints saved are available in a dropdown list from which you select the fingerprint to be deleted. Delete the selected fingerprint with the "Delete" button. A dialog box opens in which you must confirm deletion.

Deleting monitoring parameters

The following time-dependent data is deleted or reset to default values:

- Monitored limits and monitored limit band for the frequency-selective analysis method
- Reaction to limit violation
- Limit bands

Note

The device is inoperable during the deletion process.

Resetting device to factory settings

The following actions are performed using the "Reset" button:

- Deletion of all recorded data (historical data, messages, raw data, fingerprints)
- Deletion of all monitoring parameters
- Resetting the device parameters
- Resetting the password

Note

Bearing data is excluded from this function. This is always retained.

Factory settings and default settings

The table shows the delivery state of the settings in the device. If a cleanup action is performed on the parameters, or if a database is deleted via WebDAV or FTP, the affected part of the system data is returned to this status or recreated with this status.

Table 12- 1 Default settings of the SM 1281

Parameter groups	Default
Device configuration [Factory settings]	Module name is " "
Diagnostic parameters [Factory settings] [Delete monitoring parameters]	All reactions for all channels are deactivated.
	All diagnostic methods for all vibration channels are deactivated.
	All reactions to diagnostic methods of the vibration channels are deactivated.
Threshold values of the vibration analysis procedures [Factory settings] [Delete monitoring parameters]	All alarm and warning limits are deactivated.
	All threshold values are 0.
	All hysteresis values are 0.
Limit bands [Factory settings] [Delete monitoring parameters]	No limit bands are available.
Bearing types	No bearing types exist in the delivery status.
	The bearing types are not affected by reset/delete operations.
	They must be deleted manually by the user.
Historical data [Factory settings]:	No messages, trends, and fingerprints are stored.
User account [Factory settings]	User name = "admin"
	Password = "0000 (four times "zero")

12.3.6.4 Identification

On the "Identification" page, you can display information about the system and the browser.

To open the page, click "Administration > Identification" in the navigation area.

The screenshot shows the SIEMENS SIPLUS SM 1281 web interface. The top navigation bar includes 'Welcome admin', 'Logout', 'Demo Module', and 'STOP: System ready'. The left sidebar contains navigation options like 'Home', 'Monitoring results', 'Monitoring settings', 'Administration', and 'Help & Contact'. The main content area is titled 'Identification' and displays the following information:

- Device name:** Name on web-interface: Demo Module
- Basic unit:** Firmware version: V0.1.0_07
- Browser on computer:** HTTP identification: Mozilla/5.0 (Windows NT 6.1; WOW64; Trident/7.0; SLCC2; .NET CLR 2.0.50727; .NET CLR 3.5.30729; .NET CLR 3.0.30729; Media Center PC 6.0; .NET4.0C; .NET4.0E; GWX-QUALIFIED; rv:11.0) like Gecko

Display parameters

Display parameters	Description
Device name	
Name on the web interface	The name of the system as it is displayed in the title of every webpage. This name can be changed on the General (Page 149) web page.
Basic unit	
Firmware version	Firmware version of the condition monitoring firmware SM 1281.
Browsers	
HTTP identification	Browser identification used with the Web server. The identification depends on the compatibility settings of the browser

12.3.7 Help and Contact

On this page, you can download the operating instructions for the SM 1281.

On this page, you will also find links to Support and the Condition Monitoring Systems for SIPLUS CMS.

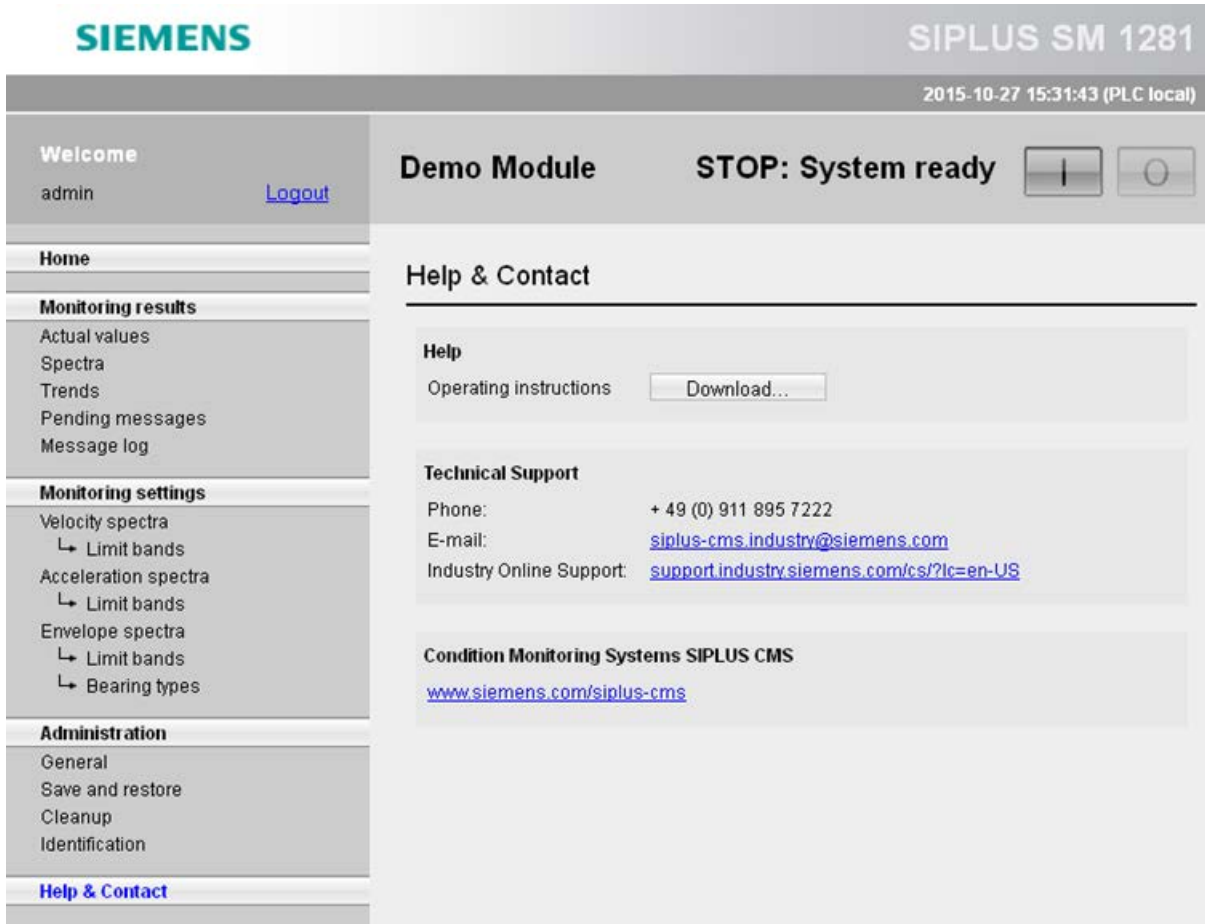

12.3.8 Website for HMI panels

The SM 1281 has an integrated website for HMI panels. The site allows you

- to back up parameter databases of the SM 1281 on the HMI panel
- to transfer backed up parameter databases from the HMI panel to the SM 1281

Characteristics

- The website is a stand-alone website. It is not linked to the "standard" pages.
- The websites are optimized for panels with at least 7 inches, e.g. for SIMATIC TP700 Comfort and larger panels from this series.
- The display requires the Pocket Internet Explorer 6.0, which is available outside of the Runtime environment.

Mobile website

You call the mobile website as follows: *<IP address>/hmi*

The screenshot shows the mobile website interface for the SIPLUS SM 1281. The header includes the SIEMENS logo and the text 'SIPLUS SM 1281'. The main content area is divided into three sections:

- Login and logout:** A section with a label 'Login and logout', a text input field labeled 'Enter password', and a 'Login' button.
- Save to panel:** A section with a label 'Save to panel' and three rows of controls:
 - 'Device parameters' with a 'Save as...' button.
 - 'Monitoring parameters' with a 'Save as...' button.
 - 'Bearing types' with a 'Save as..' button.
- Restore:** A section with a label 'Restore' and three rows of controls:
 - 'Device parameters' with an input field, a 'Browse...' button, and a 'Submit' button.
 - 'Monitoring parameters' with an input field, a 'Browse...' button, and a 'Submit' button.
 - 'Bearing types' with an input field, a 'Browse...' button, and a 'Submit' button.

Image 12-2 Mobile website SM 1281

Backing up and restoring parameter databases

Logging in and logging out

Enter the password which you have set on the regular web interface, confirm the entry with "Return", and click on the "Login" button. After the successful login, the input field is grayed out and the caption of the "Login" button changes to "Logout". Using this button, you can log off again.

Saving to the panel

Click on the "Save as..." buttons to download the corresponding database files of the device parameters, of the monitoring parameters, and of the bearing data from the module to the panel.

Restoring

Click on the "Browse..." buttons to select backed up database files via a file selection dialog. The text field shows the path and name of the selected file.

Click on the "Submit" buttons to upload the selected file to the module.

Authentication

The save action is secured via an additional authentication.

The default login name "admin" must be entered as the user name. The password required is the one that was most recently set in the device administration on the appropriate web page. If the password was not changed here, the default password "0000" applies.

Maintenance and servicing

13.1 Firmware installation

13.1.1 S7 firmware update

Carrying out a firmware update

Perform the update as described in the System Manual S7-1200 Automation System (<https://support.industry.siemens.com/cs/document/36932465/simatic-s7-s7-1200-programmable-controller?dti=0&dl=en&lc=de-WW>).

13.1.2 CM firmware update

The firmware for the device is supplied as the file "sm1281.cab" on request. Use the communication channels specified under Service & support (Page 179) to do this.

Back up the data before installing a firmware update

Before updating the firmware, back up all the parameters for the device, monitoring, and bearing type via the export function, see Chapter Save and restore (Page 152). When backing up, you can restore the original condition of the firmware and device.

The raw data recordings ("Raw data", files *.wav) do not have to be backed up.

Update the firmware

To update the firmware, proceed as follows:

1. Copy the file "sm1281.cab" to the update directory of the device.
To do this, use the upload options as described in the Chapters Data transfer over WebDAV (Page 55) or Data exchange via FTP (Page 57).
This copying process can take several minutes.
2. Start the device via the "Restart" button on the website "Administration > General" or by switching the power supply of the SM 1281 off and back on.

The new firmware will be automatically installed during the restart. This can also take several minutes.

Note

Make sure during the firmware update that the power supply is not interrupted since this could result in incomplete/inconsistent firmware in the device.

Update successful

You can recognize a successfully completed update procedure if the following three conditions occur:

- The DIAG LED changes to a steady green.
- The device can be reached again via the IP address, which is transferred from the S7 user program to the SM 1281.
- The new firmware version is displayed on the home page.

Note

If the original firmware version is still shown on the home page, this may be due to the caching mechanisms of your browser.

Remedy: Clear the browser cache and reload the home page.

Update unsuccessful

In the event of an error, the device goes to the operating mode "ERROR: System not ready (Page 173)".

In this case, perform the update procedure again.

13.1.3 Restarting SM 1281 via the website

Requirement

To restart the device via the website, the control priority must be passed on from the S7 to the websites (`OperatorControlS7 = false`). Thus, during the restart, no commands are transferred from the S7-1200 to the SM 1281. The SM 1281 can no longer be controlled via the blocks.

Startup behavior

Note

Restarting the device via web interface

If you restart the device via the website, this never automatically leads to the RUN state.

Establish the operating mode "STOP: System ready" by restarting the device via the website.

1. Log onto the SM 1281 websites.
2. Switch to the operating mode "STOP: System ready".
3. On the "Administration > General" website, select "Restart SM 1281".
 - ⇒ The SM 1281 restarts. It imports the device parameters currently present at the S7 blocks.
 - ⇒ The SM 1281 automatically switches to the operating mode "STOP: System ready".
 - ⇒ At the function block of the S7, the feedback message "Control priority S7 not active" is displayed (`OperatorControlS7 = false`).

13.2 Replace SM 1281

The principle steps for replacing the SM 1281 are described below.

Backing up initialization data

Before replacing the SM 1281, back up the CMS databases that are saved in the device. They are required for initializing the new device.

You can load the files onto your PC via the website "Save and restore" (Page 152).

Replacing the device

1. De-energize the S7 assembly, including the SM 1281.
2. Remove terminal blocks from the device (see System Manual S7-1200 Automation System (<https://support.industry.siemens.com/cs/document/36932465/simatic-s7-s7-1200-programmable-controller?dti=0&dl=en&lc=de-WW>)).
3. Disassembling the device from the DIN rail. Proceed in the reverse order to that described in Chapter Assembly (Page 63).
4. Installing and connecting the new device.
5. Restore (Page 152) the CMS databases on the device.

Additional information

Information that must be observed during repairs can be found in Chapter Safety instructions (Page 11).

13.3 Transferring backed-up initialization data to the SM 1281

Requirement

- The SM 1281 is connected to a PC via Ethernet.
- The back-up of the initialization data of the SM 1281 is available.

Transferring initialization data to the SM 1281

You must transfer the following databases to the SM 1281:

- Device.CMSDB
- Parameters.CMSDB
- BearingTypes.CMSDB

NOTICE
<p>Malfunctions due to impermissible files</p> <p>The transfer of impermissible files can lead to a malfunction of the device.</p> <p>Only transfer databases to the SM 1281 which have also been exported from an SM 1281 device.</p>

1. Transfer the backed-up databases on the SM 1281 to the directory "/config".
To do this, use WebDAV (Page 55) or FTP (Page 57) or the Save and restore (Page 152) website.
2. After the data is successfully transferred, restart the SM 1281.
You can initiate the restart by switching the supply voltage on/off or via the General (Page 149) website.

13.4 Recycling and disposal

The SM 1281 can be recycled due to its environmentally compatible components.

NOTICE
<ul style="list-style-type: none">• Disposal of the products described in this manual must be in accordance with the applicable statutory requirements.• For ecologically compatible recycling and disposal of your old device, contact only a certified disposal service for electronic scrap.

There is no provision for returning the device to Siemens.

For further questions regarding disposal and recycling, please contact your local Siemens contact. You will find the contact details in our database on the Internet at: <http://www.automation.siemens.com/partner>

Process and system messages, error handling

14.1 LED status display

LED display

The device has the following LEDs on the front:

LED	Meaning	LED status		Description
DIAG	S7 diagnostics display	Illuminated green	■	Correct operation
		Flashes red	☠	Fault
		Flashes green	☠	Initialization or firmware update
MON	Monitoring	Illuminated green	■	Operating mode RUN: Monitoring is active.
IEPE ERROR 1 to 4	<ul style="list-style-type: none"> Error state of the respective IEPE measurement channel (monitoring only in the RUN operating mode) Missing communication to the S7 CPU 	Off	■	<ul style="list-style-type: none"> Correct operation Channel deactivated
		Illuminated red	■	<ul style="list-style-type: none"> Vibration sensor of the respective channel faulted Short-circuit or interruption of the sensor line

14.2 S7 diagnostics alarms

Diagnostics alarms

The following diagnostics alarms are displayed in the diagnostic buffer of the S7 CPU:

Table 14- 1 S7 diagnostics alarms

Diagnostic interrupt	Cause	Measure
No supply voltage	24 V power supply at the SM 1281 module is not detected	Check the 24 V power supply.
High limit violated	Wire break in a sensor cable	Check the wiring of the connected sensor.
Lower limit violated	Short-circuit between the cores of a sensor cable	Check the wiring of the connected sensor.
Invalid/inconsistent firmware available	<ul style="list-style-type: none"> Version conflict between the two firmware components "S7 Firmware" and "CM Firmware". The update of the "CMFirmware" was not successful. 	<ul style="list-style-type: none"> Check the S7 firmware and the Web server update for consistency. Repeat the CM firmware update.

Error messages

The following error message is displayed in the TIA Portal:

Message	Meaning	Measure
SM1281_Invalid_Cpu_Fw	An SM 1281 module has been configured using an S7-1200 CPU with FW 4.0.	Use an S7-1200 CPU FW 4.1 or higher.

14.3 SM 1281 Web server messages

Error messages

The following error messages are displayed in the SM 1281 Web server:

Table 14- 2 Error messages

Message text	Cause	Measure
Client command response timeout.	A client command could not be executed within a defined period.	The device is temporarily overloaded. Wait and see whether the command is nevertheless executed. Otherwise, repeat the command.
Client command not possible in current application state.	A client command cannot be performed in the current operating mode. Deletion of data (cleanup), for example, is only possible in STOP state.	Change to the operating mode in which the command is permitted and then execute the command.
Database file missing: ***.cmsdb	The required database file is missing from the device.	Reboot the device. The missing file will be generated automatically. Then check your parameter assignment.
Database file corrupt: ***.cmsdb	A database file that is required is damaged on the device and cannot be used.	Delete the specified file via WebDAV or FTP and reboot the device.
Wrong order of warning and alarm levels for / in ...	The limits for warning and alarm are not plausible for the specification monitoring function.	It is important to note when setting parameters that alarm limits must be higher than warning limits when upper limits are monitored. Conversely, when monitoring lower limits, the alarm limits must lie below the warning limits.
Absolute hysteresis for ... greater than warning limit / alarm limit.	In the specified monitoring function, the value of a parameterized hysteresis is greater than the value of the associated limit.	When setting the parameters, ensure that the hysteresis values do not exceed the associated limits.
No limit band selected for velocity / acceleration / envelope spectrum monitoring.	No limit band has been selected for the specified spectrum monitoring function.	Select a limit band for each monitored vibration channel under "Velocity spectra / Acceleration spectra / Envelope curve spectra".
No bearing type selected for envelope spectrum monitoring.	No bearing type has been selected for bearing-related monitoring of the envelope curve spectrum.	Choose a bearing type under the limit band used.
Open driver <name> failed.	During device start-up, a driver could not be started.	Reboot the device. If the problem is not rectified, update the firmware.
System in STOP / no more raw data available for recording.	The system has been moved to the STOP state; an ongoing raw data recording could not be completed. The data recorded up to this point are rejected.	Change to the RUN state, if applicable, and carry out raw data recording via the Web page "Current Values".
Login failed	An incorrect password was entered.	Enter the correct password.
	The user is already logged in.	-
Firmware update failed. For details see update.log.	The last firmware update included errors, or was terminated prematurely by the system. Details can be found in "update.log".	Repeat the firmware update.

Message texts

Note

The messages below contain variable texts that are identified by pointed brackets (e.g. <Cause>). In the case of a fault, the cause is normally given; in the case of limit transgressions, the current measured value, limit, frequency (for vibration analyses) and the current speed is specified.

Table 14- 3 Message texts

Message text	Description	Remarks
System startup.	Start-up message from the device.	-
Operating mode RUN-Monitoring <cause>.	Change to RUN-Monitoring mode	-
Operating mode RUN-Measuring <cause>.	Change to RUN-Measuring mode	-
Operating mode RUN-Monitoring: inhibit <On/Off>.	Changeover between RUN-Monitoring and RUN-Monitoring inhibited	-
Operating mode STOP <cause>.	Change to STOP mode.	-
System shutdown <cause>.	Shutdown message of the device (followed by a restart)	-
System initialization failed (system not ready): <cause>.	The device is in the ERROR state. System not ready.	See Chapter Operating mode: "ERROR: System not ready" (Page 173)
Transition in RUN-Monitoring failed: <Cause>.	Change to RUN-Monitoring mode has failed.	-
Transition in RUN-Measuring failed: <Cause>.	Change to RUN-Measuring mode has failed.	-
Disk space for historical data critical! Memory utilization: <Memory utilization> (Available memory: <available memory> / Free memory: <free memory>)	The memory space for historical data is almost full (more than 90%).	-
Message jitter on: <Message text>	The specified message is alternately incoming and outgoing at very short intervals ("message jitter"). Entry of the message in the message log is temporarily suppressed to reduce the load on the system. This will not have a negative impact on the monitoring functions of the device.	Use hysteresis for monitoring process values against limits, where appropriate, to prevent a message avalanche.
Message jitter off: <Message text>	The specified message is no longer changing at very short intervals and is therefore quire normally entered in the message log.	See previous message "Message jitter on: <Message text>"
SPEED: Acquisition failed (<cause>).	Acquisition of speed has failed.	-

Message text	Description	Remarks
VIB<number><channel name>: Acquisition failed (<cause>).	Acquisition of the vibration on vibration channel <number> <channel name> has failed.	The cause "Value suspect" indicates failure of the 24 V process supply voltage.
<VIB channel>: vRMS warning limit violated (<actual value> > <threshold value>). Speed: <speed>.	The vRMS warning limit has been violated on the specified vibration channel.	The current vRMS value, the overshoot threshold value, and the current speed are specified.
<VIB channel>: vRMS alarm limit violated (<actual value> > <threshold value>). Speed: <speed>.	On the specified vibration channel, the vRMS alarm limit was violated.	The current vRMS value, the overshoot threshold value, and the current speed are specified.
<VIB channel>: aRMS warning limit violated (<actual value> > <threshold value>). Speed: <speed>.	On the specified vibration channel, the aRMS warning limit was violated.	The current aRMS value, the overshoot threshold value, and the current speed are specified.
<VIB channel>: aRMS alarm limit violated (<actual value> > <threshold value>). Speed: <speed>.	On the specified vibration channel, the aRMS alarm limit was violated.	The current aRMS value, the overshoot threshold value, and the current speed are specified.
<VIB channel>: Warning <message text> on acceleration spectrum. Limit violated at <frequency> (<actual value> > <limit>). Speed: <speed>.	On the specified vibration channel, a warning limit was violated on the acceleration spectrum.	The parameterized message text, the position (frequency) in the spectrum, the amplitude (actual value), the overshoot limit, and the current speed.
<VIB channel>: Alarm <message text> on acceleration spectrum. Limit violated at <frequency> (<actual value> > <limit>). Speed: <speed>.	On the specified vibration channel, an alarm limit was violated on the acceleration spectrum.	The parameterized message text, the position (frequency) in the spectrum, the amplitude (actual value), the overshoot limit, and the current speed.
<VIB channel>: Warning <message text> on velocity spectrum. Limit violated at <frequency> (<actual value> > <limit>). Speed: <speed>.	On the specified vibration channel, a warning limit was violated on the velocity spectrum.	The parameterized message text, the position (frequency) in the spectrum, the amplitude (actual value), the overshoot limit, and the current speed.
<VIB channel>: Alarm <message text> on velocity spectrum. Limit violated at <frequency> (<actual value> > <limit>). Speed: <speed>.	On the specified vibration channel, an alarm limit was violated on the acceleration spectrum.	The parameterized message text, the position (frequency) in the spectrum, the amplitude (actual value), the overshoot limit, and the current speed.
<VIB channel>: Warning <message text> on envelope spectrum. Limit violated at <frequency> (<actual value> > <limit>). Speed: <speed>.	On the specified vibration channel, a warning limit was violated on the envelope curve spectrum.	The parameterized message text, the position (frequency) in the spectrum, the amplitude (actual value), the overshoot limit, and the current speed.
<VIB channel>: Alarm <message text> on envelope spectrum. Limit violated at <frequency> (<actual value> > <limit>). Speed: <speed>.	On the specified vibration channel, an alarm limit was violated on the envelope curve spectrum.	The parameterized message text, the position (frequency) in the spectrum, the amplitude (actual value), the overshoot limit, and the current speed.
<VIB channel>: aRMS monitoring failed.	It was not possible to perform aRMS monitoring successfully on the specified vibration channel; monitoring is no longer performed.	Possible causes: - Speed not acquired - Speed unstable - Speed not in the range 120 - 16000 rpm (does not apply to reduced scan rate) - Vibration acquisition disturbed

14.3 SM 1281 Web server messages

Message text	Description	Remarks
<VIB channel>: vRMS monitoring failed.	It was not possible to perform vRMS monitoring successfully on the specified vibration channel; monitoring is no longer performed.	Possible causes: - Speed not acquired - Speed unstable - Speed not in the range 120 - 16000 rpm (does not apply to reduced scan rate) - Vibration acquisition disturbed
<VIB channel>: Monitoring of acceleration spectrum failed.	It was not possible to perform monitoring of the acceleration spectrum successfully on the specified vibration channel; monitoring is no longer performed.	Possible causes: - Speed not acquired - Speed unstable - Speed not in the range 120 - 16000 rpm - Vibration acquisition disturbed
<VIB channel>: Monitoring of velocity spectrum failed.	It was not possible to perform monitoring of the velocity spectrum successfully on the specified vibration channel; monitoring is no longer performed.	Possible causes: - Speed not acquired - Speed unstable - Speed not in the range 120 - 16000 rpm - Vibration acquisition disturbed
<VIB channel>: Monitoring of envelope spectrum failed.	It was not possible to perform monitoring of the envelope spectrum successfully on the specified vibration channel; monitoring is no longer performed.	Possible causes: - Speed not acquired - Speed unstable - Speed not in the range 120 - 16000 rpm - Vibration acquisition disturbed
Recording of raw data <Operation> <Further information>	Raw data recording was started, has failed, etc.	-
Recording of raw data started: trigger = <trigger>, duration = <recording duration>, file = <file name>	Recording of raw data in progress. The file name, recording duration [s], and trigger for recording are also stated.	This message shows whether raw data is being recorded or has already been completed.
The system will restart due to serious internal errors: <Cause>	The system will restart due to internal errors.	-
No or not enough raw data available to be recorded. Error code: 151.	After a switch of the operating mode from "STOP: System ready" to "RUN: Monitoring" an attempt to record raw data was made too quickly.	-

14.4 Operating mode: "ERROR: System not ready"

If the self-monitoring detects an error in the system, the device switches to the operating mode "ERROR: System not ready".

Remedy

You have the following options:

- If the SM 1281 webserver is available, call the page "Pending messages" (Page 127). The current error situation is explained in more detail here.
- In some instances, a firmware update may have to be performed, see Chapter CM firmware update (Page 161).
- The device can be restarted by a voltage reset.

Note

If the operating mode "ERROR: System not ready" is no longer exited after a manual restart of the SM 1281 module, including the S7 controller, contact Support (<https://support.industry.siemens.com/cs/?lc=en-DE>).

Technical data

15.1 Technical specifications

Technical specifications SM 1281

product brand name	SIPLUS
Product designation	CMS1200 SM 1281 Condition Monitoring
General technical data:	
Protection class IP	IP20
Browser software / required	Web browser Mozilla Firefox (ESR31) or Microsoft Internet Explorer (10/11)
Storage capacity / total	1 Gbyte
Scanning frequency / maximum	46 875 Hz
Material / of the enclosure	Plastic: Polycarbonate: Abbreviated PC GF10 FR
Hardware configuration	Modular, up to 7 modules per CPU
Vibration frequency measuring range	
• initial value	0.05 Hz
• Full-scale value	10 000 Hz
Power loss [W] / total / typical	6 W
Equipment marking / acc. to DIN EN 81346-2	P
Weight	260 g
Supply voltage:	
Supply voltage / 1 / at DC / rated value	24 V
Type of voltage / of the supply voltage	DC
Supply voltage / at DC / rated value	
• minimum	20.4 V
• maximum	28.8 V
Installation/ mounting/ dimensions:	
Mounting position	vertical, horizontal
Mounting position / recommended	horizontal
Mounting type	DIN rail or wall mounting
Width	70 mm
Height	112 mm
Depth	75 mm

Inputs/ Outputs:	
Number of sensor inputs / for IEPE sensors	4
Number of speed inputs	1
Product function / Bus communication	Yes
Product function / monitoring of sensor inputs	Yes
Input voltage / at speed input / DC 24 V digital	Yes
Display:	
Display version / for diagnostic function: status display digital input / LED green	No
design of display / as status display by LED / for status of Inputs	Yes
design of display / as status display by LED / for maintenance	Yes
Communication:	
Type of data transmission	Exporting of raw data as WAV file for further analyses (e.g. using SIPLUS CMS X-Tools) can be downloaded via browser
Design of the interface / Ethernet interface	Yes
Service / as web server / HTTP	Yes
Ambient conditions:	
Ambient temperature	
<ul style="list-style-type: none"> • during operation 	-20 ... +55 °C
<ul style="list-style-type: none"> • during storage 	-25 ... +85 °C
<ul style="list-style-type: none"> • during transport 	-25 ... +85 °C
Air pressure / during storage and transport	660 ... 1 080 hPa
Height of fall / maximum	0.3 m
Height of fall / maximum / Note	-
Options:	
Alert function / Diagnostics alarm	Yes
Type of electrical connection	screw-type terminals

15.2 Dimensional drawing

Dimensional drawings of the SM 1281 Condition Monitoring

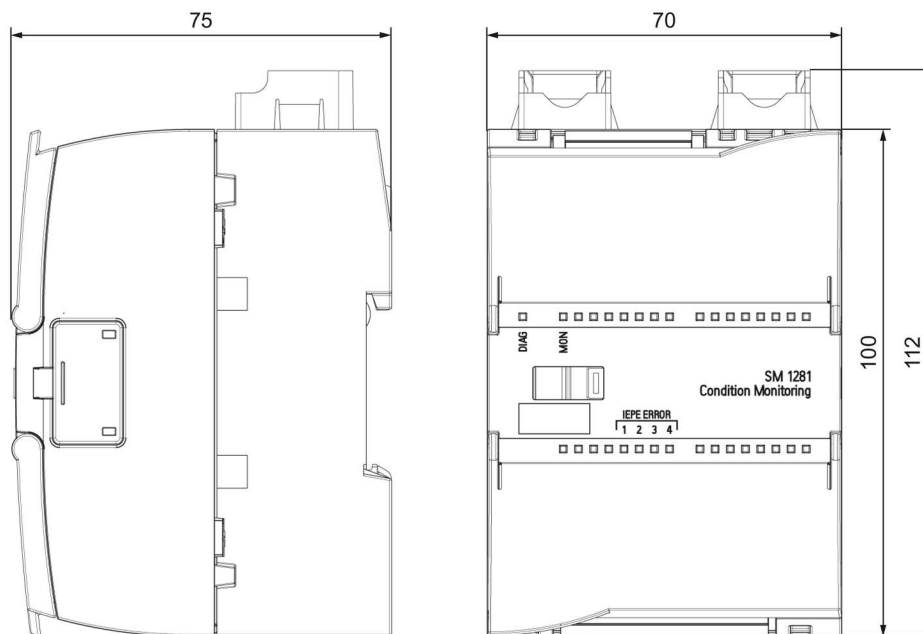

Image 15-1 Dimensional drawings SM 1281

Appendix

A.1 Certificates and approvals

Note

Approvals are only valid when marked on the product

The specified approvals apply only when the corresponding mark is printed on the product. You can check which of the following approvals have been granted for your product by the markings on the type plate.

CE marking

The SM 1281 Condition Monitoring device fulfills the requirements and safety objectives of the EC directives below.

Industrial environments

The product is designed for use in an industrial environment.

EMC requirements:

Field of application	Noise emission requirements	Interference immunity requirements
Industrial area	EN 61000-6-4	EN 61000-6-2

The product meets these requirements if you adhere to the installation guidelines and safety instructions described in these operating instructions and in the System Manual for the S7-1200 Automation System.

Declaration of Conformity

The EC Declaration of Conformity is kept available for the responsible authorities in accordance with the above-mentioned EC Directive at the following address:

SIEMENS AG
 DF FA SE R&D
 BRESLAUER STR. 5
 90766 FUERTH
 GERMANY

Approvals

- UL 508
- CSA C22.2 No. 14

Further applied standards

- IEC 61131-2 / 2007
- IEC 61010-1 / 2010 + C1 (2011) + C2 (2013)

A.2 Contact address

Contact address

SIEMENS AG
DF FA SE
Breslauer Strasse 5
90766 FÜRTH
GERMANY

A.3 Licenses

Use of open source software (OSS)

The SM 1281 Condition Monitoring product uses open source software modified by us or in its unmodified form. Mandatory licensing information and sources to be published are saved in the "SM1281_Readme_OSS.pdf" file. This file can be read out on the website "Save and restore" in the section "Downloading software licensing information" (Page 152).

Sources under the GNU General Public License are provided to you free of charge on request. Use the communication channels specified under Service & support (Page 179) to do this.

A.4 Service & support

Technical Support

You can access Technical Assistance as follows:

- Phone: + 49 (0) 911 895 7222
- E-mail (<mailto:siplus-cms.industry@siemens.com>)

Siemens Industry Online Support

You can find various services on the Support homepage (<http://support.automation.siemens.com>) on the Internet.

There you will find the following information, for example:

- The correct documents for you via product-related search functions
- Online support request form
- Your local representative
- Information about on-site service, repairs, and spare parts.
- A forum for global information exchange by users and specialists.
- Our newsletter containing up-to-date information on your products.

Online catalog and ordering system

The online catalog and the online ordering system can be found on the Industry Mall homepage (<https://mall.industry.siemens.com>).

SIPLUS CMS Condition Monitoring Systems on the Internet

Current information on SIPLUS CMS Condition Monitoring Systems are provided as part of our online presence (<http://www.siemens.com/siplus-cms>).

Glossary

Alarm limit

A threshold value can be set for each of the measured or calculated variables, e.g. vRMS, aRMS, speed. If this threshold value is exceeded, the device will trigger an alarm.

BPFI

Ball Passing Frequency Inner race

BPFO

Ball Passing Frequency Outer race

BSF

Ball Spin Frequency

CMS

Condition monitoring system for monitoring mechanical components as part of preventive maintenance.

Fault frequency

The fault frequency is the rate at which the ball of the bearing passes a damage location. The fault frequencies can either be determined from the bearing geometry and the speed, or they can be directly entered on the basis of a reference speed.

FE (functional grounding)

Low-impedance connection to ground potential

Fingerprint

A "Fingerprint" is created for the purpose of recording the current status of a monitored bearing. Characteristic values are either measured using configurable measuring procedures or calculated by averaging the measured values over a definable period, and saving them in the device.

FTF

Fundamental Train Frequency

FTP

File Transfer Protocol

High/low limit

Some measured values are monitored for overshooting a high limit (for both warning and alarm) as well as for undershooting a low limit (for both warning and alarm).

IEPE sensor

IEPE sensors are piezo-electric sensors with integrated electronics.

ISO 10816-3

Title: Mechanical vibration - Evaluation of machine vibration by measurements on non-rotating parts - Part 3: Industrial machines with nominal power above 15 kW and nominal speeds between 120 rpm and 15000 rpm when measured in situ (ISO 10816-3:2009)

Limit band

A limit band is a dataset that contains frequencies or frequency ranges (depending on the analysis technique selected) and the limits to be monitored in each case.

Raw data

The measured values acquired on the input channels of the device for further processing.

RMS

Root Mean Square

SIPLUS CMS

SIPLUS CMS is the name for the condition monitoring product family from Siemens. Mechanical wear, imbalance, damage to rolling contact bearings and other damage in machines can cause an unplanned plant stoppage. SIPLUS CMS detects such damage early and therefore ensures plant availability.

SM 1282 Condition Monitoring

Parameterizable condition monitoring system from the SIPLUS CMS product family from Siemens. With the SM 1282, visualization and parameterization is performed via a web browser or via the TIA Portal. Handling has therefore been considerably simplified for the service personnel, both locally as well as in remote operation.

SMTP

Simple Mail Transfer Protocol

Warning limit

A threshold value can be set for each of the measured or calculated variables, e.g. vRMS, aRMS. If this threshold value is exceeded, the device will trigger a warning.

Index

A

- Acceleration sensor
 - Mounting, 18
 - Mounting surfaces, 18
- Acceleration spectrum
 - Limit bands, 135, 137
- Actual data, 118
- Actual displays, 50
- Administration settings, 149
- Application example
 - Envelope curve analysis, 33
 - Field fault in rotor, 31
 - RMS, 26
 - Unbalance, 29
 - Vibration velocity spectrum, 29
- Approvals, 177, 177

B

- Ball damage, 45
- Bar break, 31
- Bar passing frequency, 31
- Bearing analysis, 45
- Bearing type parameters, 146
- Bearing types, 146
- Belt defect, 21
- Blade passing frequency, 21
- Browsers, 110

C

- Cable shield, 68
- Cables
 - Requirements, 66
- Cage damage, 45
- CE marking, 177
- Characteristic value formation, 20
- Check
 - Power supply, 12, 65, 70
- Circular buffer, 51
- Clock, 54
- Commissioning
 - Hardware, 75
- Connecting terminals
 - Assignment, 67

- Coupling defect, 21

D

- Damaged rolling element bearing, 33
 - Envelope curve analysis, 33
- Declaration of Conformity, 177
- Deleting
 - Data, 154
- Delivery
 - Unpacking, 59
- Device
 - Replacing, 164
- Direction of load, 17
- Documentation
 - Validity, 9
- Download
 - Download data, 153

E

- Electrical isolation, 12, 65, 70
- Electrical rotor faults, 21
- Electrical stator faults, 21
- EMC Directive, 177
- Enclosure vibration, 19
- Envelope curve analysis, 32
 - Frequency band, 32
- Envelope spectrum, 33
 - Limit bands, 141, 143
 - Monitoring, 45
- ERROR - System not ready, 173
- Error messages, 115, 127, 169
- Ethernet interface
 - Pin assignment, 74

F

- Factory settings, 156
- Fast Fourier Transform, 27
- Fault frequencies, 45
- Fault frequency calculator, 147
- Features
 - Product, 35
- Field fault in rotor, 31
- Fingerprints, 52
 - Composition, 52

Firmware, 161
Firmware update, 161
Frequency analysis, 20, 27
Frequency tolerance, 44, 45
Functional grounding, 73

G

General
 Change password, 150
 Device name, 150
 Restarting the device, 151
Grounding, 73
Guidelines, 23

H

Home page
 Display data, 116
Hysteresis, 46

I

Identification
 Display parameters, 157
IEPE sensors, 72
Incorrect inputs, 114
Inner race defect, 45
Installation
 Ambient conditions, 61
 Minimum spacing, 61
 Mounting position, 61
 Notes, 61
IT security, 13

L

LEDs, 50
License conditions, 178
Limit band, 34
Limit undershoot, 44
Logging in, 112
Logging out, 112

M

Machine monitoring
 Method, 20
Mask frequency band, 44, 45

Measured value acquisition, 54
 Signal quality, 54
 Speed quality, 54
Measurement axis, 17
Measurement path, 17
Measuring mode, 42
Measuring point, 17
Mechanical vibration, 14
 Causes, 15
 Severity, 15
 Transmission, 15
Meshing defect, 21
Message display, 129
Message history, 128
Message log, 50, 129
Message status, 49, 129
Message system, 49
Messages
 Pending, 127
 Unacknowledged, 127
Misalignment, 21, 26
Monitoring
 Acceleration spectrum, 44
 Speed-dependent, 44, 45
 Speed-independent, 44
Monitoring mode, 43
Mounting
 Shield clamp set, 64
 Shield support, 64
Mounting defect, 21

N

Non-isolated system configuration, 12, 65, 70
Note
 Shipping, 59
Notes
 Installation, 61

O

Open-source software, 178
Operating instructions, 158
Operating mode
 Changing, 113
 Measuring mode, 114
 Monitoring mode, 113
Operating modes, 39
Operation
 Web pages, 114
Outer race defect, 45

P

Password, 112
 PELV, 12, 65, 70
 Piezoelectric sensors, 16
 Frequency response, 16
 Pin assignment
 Industrial Ethernet, 74
 Power supply, 70
 Process messages, 49

R

Recording raw data, 52
 Duration, 52
 Triggering, 52
 Repairs, 12
 Requirements
 Cables, 66
 Resonance, 21
 RMS
 Calculation, 25
 RMS monitoring, 44
 RMS value of the vibration velocity, 25

S

Safe electrical isolation, 12, 65, 70
 Safety instructions
 General, 11
 Safety extra-low voltage, 12
 Scope of delivery, 59
 Screen resolution, 110
 Self-monitoring, 54
 Self-test, 54
 Shaft vibration, 19
 Shield support
 Mounting, 64
 Shielding, 68
 Shipping
 Note, 59
 SM 1281 structure, 37
 Spectra
 Displaying, 121
 Monitoring, 44
 Spectral analysis, 27
 Spectrum
 Limit band, 34
 Speed measurement, 48
 Speed sensor, 73
 Standards, 23
 Status information, 50

Storage, 59
 Storage conditions, 59
 Structure
 User interface, 111
 Structure-borne noise, 19
 System configuration
 non-isolated, 12, 65, 70
 System messages, 49

T

Target group, 9
 Technical Support, 179
 Terminal assignment, 67
 Trend monitoring, 24
 Characteristic values, 24
 Trends, 51, 51, 124
 Resolution, 51
 Saving, 51

U

Unbalance, 21, 26, 29
 Update
 Firmware, 161
 User interface
 Structure, 111

V

Values
 Color identification, 119
 Velocity spectrum, 130
 Limit bands, 130, 132
 Vibration acceleration, 19
 Vibration acceleration spectrum, 30
 Vibration diagnostics, 15, 20
 Vibration displacement, 19
 Vibration measurement, 20
 Vibration measurements
 in the time range, 22
 Vibration velocity, 19
 Vibration velocity spectrum, 28

W

Watchdog, 54
 WebDAV, 55
 Authentication, 56

Website

Screen resolution, 110