

SIEMENS



SIMATIC

S7-1500

CPU 1511-1 PN (6ES7511-1AK00-0AB0)

Manual

Edition

12/2014

Answers for industry.

SIEMENS

SIMATIC

S7-1500
CPU 1511-1 PN
(6ES7511-1AK00-0AB0)

Manual

Preface

Documentation guide

1

Product overview

2

Connecting up

3

Interrupts, error messages,
diagnostics and system
alarms

4

Technical specifications

5



Dimensional drawing

A

Legal information

Warning notice system

This manual contains notices you have to observe in order to ensure your personal safety, as well as to prevent damage to property. The notices referring to your personal safety are highlighted in the manual by a safety alert symbol, notices referring only to property damage have no safety alert symbol. These notices shown below are graded according to the degree of danger.

 DANGER
indicates that death or severe personal injury will result if proper precautions are not taken.
 WARNING
indicates that death or severe personal injury may result if proper precautions are not taken.
 CAUTION
indicates that minor personal injury can result if proper precautions are not taken.
NOTICE
indicates that property damage can result if proper precautions are not taken.

If more than one degree of danger is present, the warning notice representing the highest degree of danger will be used. A notice warning of injury to persons with a safety alert symbol may also include a warning relating to property damage.

Qualified Personnel

The product/system described in this documentation may be operated only by **personnel qualified** for the specific task in accordance with the relevant documentation, in particular its warning notices and safety instructions. Qualified personnel are those who, based on their training and experience, are capable of identifying risks and avoiding potential hazards when working with these products/systems.

Proper use of Siemens products

Note the following:

 WARNING
Siemens products may only be used for the applications described in the catalog and in the relevant technical documentation. If products and components from other manufacturers are used, these must be recommended or approved by Siemens. Proper transport, storage, installation, assembly, commissioning, operation and maintenance are required to ensure that the products operate safely and without any problems. The permissible ambient conditions must be complied with. The information in the relevant documentation must be observed.

Trademarks

All names identified by ® are registered trademarks of Siemens AG. The remaining trademarks in this publication may be trademarks whose use by third parties for their own purposes could violate the rights of the owner.

Disclaimer of Liability

We have reviewed the contents of this publication to ensure consistency with the hardware and software described. Since variance cannot be precluded entirely, we cannot guarantee full consistency. However, the information in this publication is reviewed regularly and any necessary corrections are included in subsequent editions.

Preface

Purpose of the documentation

This manual supplements the system manual of the S7-1500 automation system and the function manuals. All cross-system functions are described in the system manual and in the function manuals.

The information provided in this manual and the system manual allows you to commission the CPU 1511-1 PN.

Conventions

STEP 7: In this documentation, "STEP 7" is used as a synonym for all versions of the configuration and programming software "STEP 7 (TIA Portal)".

Also read the notes labeled as follows:

Note

A note contains important information on the product described in the documentation, on the handling of the product or on the section of the documentation to which particular attention should be paid.

Security information

Siemens provides products and solutions with industrial security functions that support the secure operation of plants, solutions, machines, equipment and/or networks. They are important components in a holistic industrial security concept. With this in mind, Siemens' products and solutions undergo continuous development. Siemens recommends strongly that you regularly check for product updates.

For the secure operation of Siemens products and solutions, it is necessary to take suitable preventive action (e.g. cell protection concept) and integrate each component into a holistic, state-of-the-art industrial security concept. Third-party products that may be in use should also be considered. You can find more information about industrial security on the Internet (<http://www.siemens.com/industrialsecurity>).

To stay informed about product updates as they occur, sign up for a product-specific newsletter. You can find more information on the Internet (<http://support.automation.siemens.com>).

Table of contents

	Preface	4
1	Documentation guide	6
2	Product overview	8
2.1	Application	8
2.2	How it works.....	10
2.3	Properties.....	11
2.4	Operating and display elements	14
2.4.1	Front view of the module with closed front panel	14
2.4.2	Front view of the module without front panel	16
2.4.3	Rear view of the module	17
2.5	Mode selector switch	17
2.6	Functions	18
2.6.1	PROFINET IO	18
2.6.2	PROFenergy	19
2.6.3	Memory reset	19
2.6.4	Restoring the factory settings of the CPU.....	21
3	Connecting up	24
4	Interrupts, error messages, diagnostics and system alarms	28
4.1	Status and error display of the CPU	28
5	Technical specifications	31
A	Dimensional drawing	40

Documentation guide

The documentation for the SIMATIC S7-1500 automation system and the SIMATIC ET 200MP distributed I/O system is arranged into three areas. This arrangement enables you to access the specific content you require.

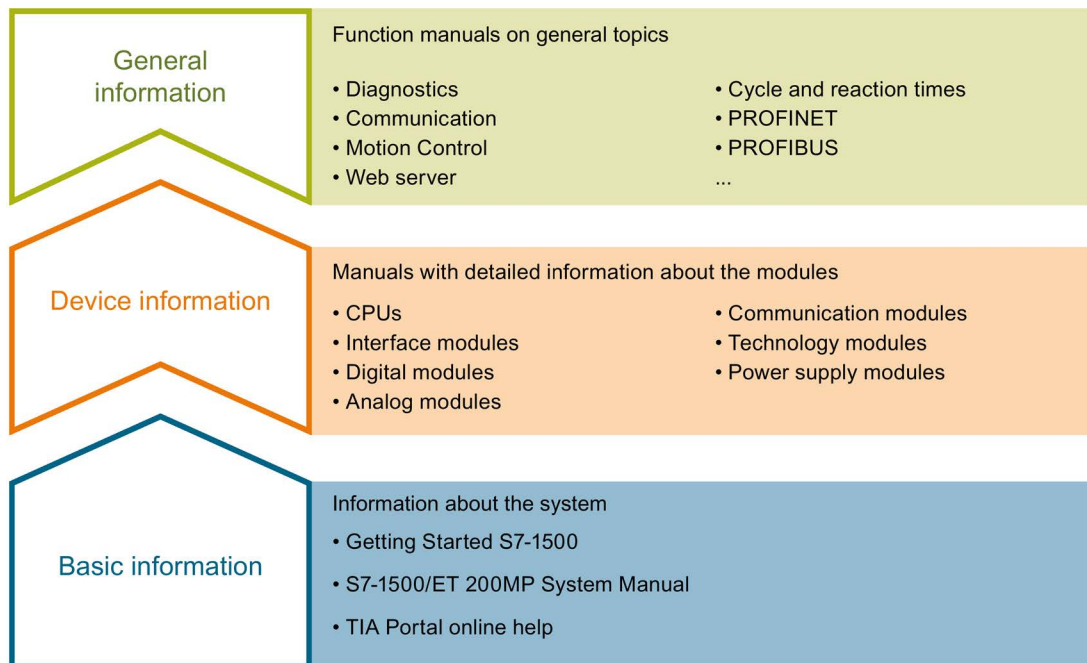

Basic information

System Manual and Getting Started describe in detail the configuration, installation, wiring and commissioning of the SIMATIC S7-1500 and ET 200MP systems. The STEP 7 online help supports you in the configuration and programming.

Device information

Product manuals contain a compact description of the module-specific information, such as properties, terminal diagrams, characteristics and technical specifications.

General information

The function manuals contain detailed descriptions on general topics regarding the SIMATIC S7-1500 and ET 200MP systems, e.g. diagnostics, communication, Motion Control, Web server.

You can download the documentation free of charge from the Internet (<http://www.automation.siemens.com/mcms/industrial-automation-systems-simatic/en/manual-overview/tech-doc-controllers/Pages/Default.aspx>).

Changes and supplements to the manuals are documented in a Product Information.

Manual Collection S7-1500/ET 200MP

The Manual Collection contains the complete documentation on the SIMATIC S7-1500 automation system and the ET 200MP distributed I/O system gathered together in one file.

You can find the Manual Collection on the Internet
(<http://support.automation.siemens.com/WW/view/en/86140384>).

My Documentation Manager

The My Documentation Manager is used to combine entire manuals or only parts of these to your own manual.

You can export the manual as PDF file or in a format that can be edited later.

You can find the My Documentation Manager on the Internet
(<http://support.automation.siemens.com/WW/view/en/38715968>).

Applications & Tools

Applications & Tools supports you with various tools and examples for solving your automation tasks. Solutions are shown in interplay with multiple components in the system - separated from the focus in individual products.

You can find Applications & Tools on the Internet
(<http://support.automation.siemens.com/WW/view/en/20208582>).

CAX Download Manager

The CAX Download Manager is used to access the current product data for your CAX or CAE systems.

You configure your own download package with a few clicks.

In doing so you can select:

- Product images, 2D dimension drawings, 3D models, internal circuit diagrams, EPLAN macro files
- Manuals, characteristics, operating manuals, certificates
- Product master data

You can find the CAX Download Manager on the Internet
(<http://support.automation.siemens.com/WW/view/en/42455541>).

TIA Selection Tool

With the TIA Selection Tool, you can select, configure and order devices for Totally Integrated Automation (TIA).

This tool is the successor of the SIMATIC Selection Tool and combines the known configurators for automation technology into one tool.

With the TIA Selection Tool, you can generate a complete order list from your product selection or product configuration.

You can find the TIA Selection Tool on the Internet
(<http://w3.siemens.com/mcms/topics/en/simatic/tia-selection-tool>).

Product overview

2.1 Application

The CPUs of the SIMATIC S7-1500 controller family offer best possible performance combined with excellent usability. With their integrated PROFINET/PROFIBUS interfaces, the Web server and integrated functionalities, such as Motion Control, PID controller and temperature controller, trace support, the CPUs are predestined for numerous applications in automation engineering.

Performance segments

The CPUs can be used for smaller and mid-range applications, as well as for the high-end area of machine and plant automation.

CPU	Performance segment	PROFIBUS interfaces	PROFINET interfaces	Work memory	Processing time for bit operations
CPU 1511-1 PN	Standard CPU for smaller to mid-range applications	--	1	1.15 MB	60 ns
CPU 1511F-1 PN	Fail-safe CPU for smaller to mid-range applications	--	1	1.23 MB	60 ns
CPU 1513-1 PN	Standard CPU for mid-range applications	--	1	1.8 MB	40 ns
CPU 1513F-1 PN	Fail-safe CPU for mid-range applications	--	1	1.95 MB	40 ns
CPU 1515-2 PN	Standard CPU for mid-range to large applications	--	2	3.5 MB	30 ns
CPU 1515F-2 PN	Fail-safe CPU for mid-range to large applications	--	2	3.75 MB	30 ns
CPU 1516-3 PN/DP	Standard CPU for high-end applications and communication tasks	1	2	6 MB	10 ns
CPU 1516F-3 PN/DP	Fail-safe CPU for high-end applications and communication tasks	1	2	6.5 MB	10 ns
CPU 1517-3 PN/DP	Standard CPU for demanding applications and communication tasks	1	2	10 MB	2 ns
CPU 1517F-3 PN/DP	Fail-safe CPU for demanding applications and communication tasks	1	2	11 MB	2 ns
CPU 1518-4 PN/DP	Standard CPU for high-performance applications, demanding communication tasks and very short reaction times	1	3	24 MB	1 ns
CPU 1518F-4 PN/DP	Fail-safe CPU for high-performance applications, demanding communication tasks and very short reaction times	1	3	26 MB	1 ns

Integrated technology functions

The CPUs of the SIMATIC S7-1500 family support Motion Control functions. STEP 7 offers PLCopen standardized blocks for configuring and connecting a drive to the CPU. Motion Control supports speed, positioning and synchronous axes, as well as external encoders.

For effective commissioning, diagnostics and fast optimization of drives and controls, the SIMATIC S7-1500 controller family offers extensive trace functions for all CPU tags.

In addition to drive integration, the SIMATIC S7-1500 has extensive control functionalities, such as easy-to-configure blocks for automatic optimization of the controller parameters for optimized control quality.

Technology modules also implement functions such as high-speed counting, position detection and measuring functions for 24 V signals up to 200 kHz.

Due to the integrated technology function, the CPUs are suitable, for example, for pumps, fans, mixers, conveyor belts, lifting platforms, gate control systems, building management systems, synchronized axes, cross cutters, etc.

Security Integrated

The CPUs are aimed at users that require the maximum possible plant security.

In combination with STEP 7, each CPU offers password-based know-how protection against unauthorized reading or modifying of the program blocks.

The copy protection provides high-performance protection against unauthorized reproduction of program blocks. The copy protection can be used to link individual blocks on the SIMATIC memory card with their serial numbers. The block can only be executed if the configured memory card is inserted in the CPU.

In addition, four different authorization levels in the CPUs can be used to assign different access right to various user groups.

Improved manipulation protection allows the CPUs to detect changed or unauthorized transfers of the engineering data.

Safety Integrated

The fail-safe CPUs are aimed at users that want to implement demanding standard and fail-safe applications in both a centralized and a distributed manner.

These fail-safe CPUs allow the processing of standard and safety programs on a single CPU. This allows fail-safe data to be evaluated in the standard user program. This integration thus provides the system advantages and the extensive functionality of SIMATIC also for fail-safe applications.

The fail-safe CPUs are certified for use in safety mode up to:

- Safety class (Safety Integrity Level) SIL 3 according to IEC 61508:2010
- Performance Level (PL) e and Category 4 according to ISO 13849-1:2006 or according to EN ISO 13849-1:2008

Additional password protection for F-configuration and F-program is set up for IT security.

Design and handling

The design and handling of the CPUs is very straightforward and offers the greatest possible user friendliness. All CPUs have a display. The display provides information on order numbers, firmware version and serial numbers of all connected modules. The IP address of the CPU and other network settings can be set directly on site, without a programming device. The display shows occurring errors messages directly as plain text multi-lingual messages and helps you to reduce downtimes.

System diagnostics

Integrated system diagnostics is activated by default for the CPUs. The different diagnostic types are configured instead of programmed. System diagnostics information is shown uniformly and in plain text on the display of the CPU, in STEP 7, on the HMI and on the Web server, even for alarms related to drives. This information is available in RUN mode, but also in STOP mode of the CPU. An automatic update of the diagnostics information is performed when you configure new hardware components.

2.2 How it works

The CPU contains the operating system and executes the user program. The user program is located on the SIMATIC memory card and is processed in the work memory of the CPU.

The PROFINET interfaces on the CPU allow simultaneous communication with PROFINET devices, PROFINET controllers, HMI devices, programming devices, other controllers and other systems. CPU 1511-1 PN supports operation as an IO controller and I-device.

IO controller

As an IO controller, CPU 1511-1 PN sends and receives data and signals from the connected IO devices within a PROFINET IO system. You can operate the CPU with a maximum of 128 IO devices, of which a maximum of 64 may be IRT (Isochronous Realtime) devices.

I-device

In the "I-device" (intelligent IO device) function, CPU 1511-1 PN not only controls its own central modules, but also acts as an I-device, exchanging data with a higher-level IO controller. CPU 1511-1 PN thus fulfills the role of an intelligent pre-processing unit for sub-processes.

2.3 Properties

Article number

6ES7511-1AK00-0AB0

View of the module

The following figure shows a CPU 1511-1 PN.



Figure 2-1 CPU 1511-1 PN

Note

Protective film

Note that a protective film is attached to the display of the CPU when shipped from the factory. Remove the protective film if necessary.

Properties

The CPU 1511-1 PN has the following technical properties:

- Communication:

- Interfaces

The CPU 1511-1 PN has a PROFINET interface (X1) with two ports (P1R and P2R). It supports PROFINET basic functionality, PROFINET IO RT (real-time) and IRT (isochronous real-time), which means you can configure PROFINET IO communication or real-time settings at the interface. Port 1 and port 2 can also be used as ring ports for the configuration of redundant ring structures in Ethernet (media redundancy).

PROFINET basic functionality supports HMI communication, communication with the configuration system, communication with a higher-level network (backbone, router, Internet) and communication with another machine or automation cell.

- Integrated Web server:

The CPU is accessible via an integrated Web server for diagnostic purposes. You can read the following information with the Web server:

- Start page with general CPU information
 - Identification information
 - Contents of the diagnostics buffer
 - Querying module information
 - Alarms (without acknowledgment option)
 - Information about communication
 - PROFINET topology
 - Tag status
 - Watch tables
 - Memory usage
 - Data logs (if used)

- Trace functionality:

- All CPUs of the S7-1500 automation system support trace functionality. Trace functionality supports you in troubleshooting and optimizing the user program, especially for motion control or closed-loop control applications.

- Integrated technology:
 - Motion Control
PLC-Open blocks for programming motion functionality using PROFINET IO IRT with the PROFIdrive interface.
The functionality supports speed-controlled axes, positioning axes, synchronous axes and external encoders.
 - Integrated closed-loop control functionality
 - Universal PID controller and 3-point controller with integrated tuning
 - Integrated temperature controller
- Integrated system diagnostics:
 - The alarms for the system diagnostics are automatically created by the system and displayed on a PG/PC, HMI device, Web server or the integrated display. System diagnostics information is also available when the CPU is in STOP mode.
- Integrated security:
 - Know-how protection
The know-how protection protects user blocks against unauthorized access and modifications.
 - Copy protection
Copy protection links user blocks to the serial number of the SIMATIC memory card or to the serial number of the CPU. User programs cannot run without the corresponding SIMATIC memory card or CPU.
 - Access protection
Extended access protection provides high-quality protection against unauthorized configuration changes. You can use authorization levels to assign separate rights to different user groups.
 - Integrity protection
The system protects the data transferred to the CPU against manipulation. The CPU detects erroneous or manipulated engineering data.
- The CPU 1511-1 PN supports the following additional functions:
 - Firmware update
 - PROFIenergy
 - Shared device
 - Configuration control
 - Isochronous mode

Reference

You will find additional information on the topic of "Integrated security/Access protection" in the S7-1500, ET 200MP system manual (<http://support.automation.siemens.com/WW/view/en/59191792>).

2.4 Operating and display elements

2.4.1 Front view of the module with closed front panel

The following figure shows the front view of the CPU 1511-1 PN.

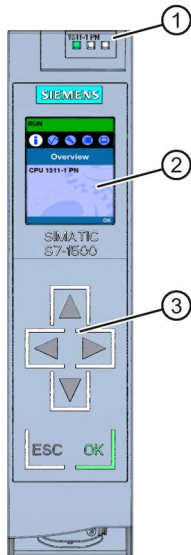

- ① LEDs for the current operating mode and diagnostic status of the CPU
- ② Display
- ③ Operator control buttons

Figure 2-2 View of the CPU 1511-1 PN (with front panel) - front

Note

Temperature range for display

To increase the service life of the display, the display switches itself off when the permitted operating temperature is exceeded. When the display cools down again, it automatically switches itself on again. When the display is switched off, the LEDs continue to show the status of the CPU.

For more information on the temperatures at which the display switches itself on and off, refer to the Technical specifications (Page 31).

Pulling and plugging the front panel with display

You can pull and plug the front panel with display during operation.

▲ WARNING
Personal injury and damage to property may occur
If you pull or plug the front panel of an S7-1500 automation system during operation, personal injury or damage to property can occur in zone 2 hazardous areas.
Always disconnect the S7-1500 automation system from the power supply before you pull or plug the front panel in zone 2 hazardous areas.

Locking the front panel

You can lock the front panel to protect your CPU against unauthorized access.

You can attach a security seal or a padlock with a diameter of 3 mm to the front panel.

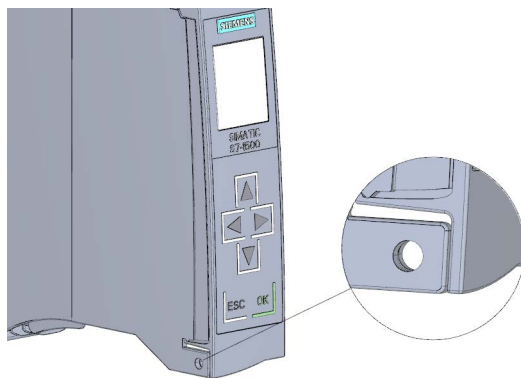

Figure 2-3 Locking latch on the CPU

In addition to the mechanical lock, you can also block access to a password-protected CPU on the display (local lock). You can find additional information on the display, configurable protection levels and local locks in the S7-1500, ET 200MP (<http://support.automation.siemens.com/WW/view/en/59191792>) system manual.

Reference

You will find detailed information on the individual display options, a training course and a simulation of the available menu commands in the SIMATIC S7-1500 Display Simulator (http://www.automation.siemens.com/salesmaterial-as/interactive-manuals/getting-started_simatic-s7-1500/disp_tool/start_en.html).

2.4.2 Front view of the module without front panel

The following figure shows the operator controls and connection elements of the CPU 1511-1 PN.

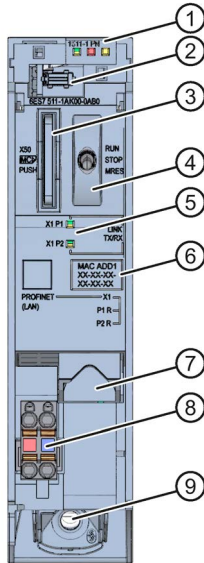

- ① LEDs for the current operating mode and diagnostic status of the CPU
- ② Display connector
- ③ Slot for the SIMATIC memory card
- ④ Mode selector
- ⑤ LEDs for the 2 ports of the PROFINET interface X1
- ⑥ MAC address
- ⑦ PROFINET interface (X1) with 2 ports
- ⑧ Connector for power supply
- ⑨ Fixing screw

Figure 2-4 View of the CPU 1511-1 PN (without front panel) - front

2.4.3 Rear view of the module

The following figure shows the connection elements on the back of the CPU 1511-1 PN.

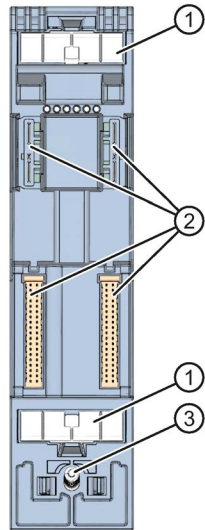

- ① Shield contact surface
- ② Backplane bus connector
- ③ Fixing screw

Figure 2-5 View of the CPU 1511-1 PN - back

2.5 Mode selector switch

Use the mode selector to set the CPU operating mode.

The following table shows the position of the switch and the corresponding meaning.

Table 2- 1 Mode selector settings

Position	Meaning	Explanation
RUN	RUN mode	The CPU is executing the user program.
STOP	STOP mode	The user program is not being executed.
MRES	Memory reset	Position for CPU memory reset.

2.6 Functions

2.6.1 PROFINET IO

PROFINET is a fieldbus standard of the PROFIBUS user organization that defines a cross-vendor communications and engineering model.

As part of PROFINET, PROFINET IO is a communication concept that is used to implement modular, distributed applications. PROFINET IO IRT allows defined response times and highly precise plant behavior.

A PROFINET IO system consists of the following PROFINET devices:

- IO controller
Device used to address the connected IO devices.
- IO device
A distributed field device that is assigned to an IO controller.

The PROFINET IO controller operating mode allows direct access to IO devices via Industrial Ethernet.

The PROFINET IO device operating mode enables you to operate S7 stations or distributed I/O systems with a CPU as "intelligent" IO devices on Industrial Ethernet.

General properties of PROFINET IO

PROFINET IO provides the following properties and functions:

- Real-time communication (RT)
- Isochronous real-time communication (IRT)
- Media redundancy
- Prioritized startup
- Device replacement without exchangeable medium
- I-device
- IO controller
- Shared device
- Isochronous mode

Reference

You will find additional information on "PROFINET IO" in the STEP 7 online help and in the PROFINET System Description (<http://support.automation.siemens.com/WW/view/en/19292127>) manual.

2.6.2 PROFlenergy

PROFlenergy

PROFlenergy is a PROFINET-based data interface for switching off consumers centrally and in a coordinated manner during pause times regardless of the manufacturer or device type. Through this, the process should only be provided with the energy that is absolutely required. The majority of the energy is saved by the process; the PROFINET device itself only contributes a few watts of savings potential.

Additional information

- PROFINET (<http://support.automation.siemens.com/WW/view/en/68039307>) function manual
- You will find more information on PROFlenergy in the PROFINET specification on the Internet (<http://www.profibus.com>).

2.6.3 Memory reset

Apart from a few exceptions, a "memory reset" involves clearing all internal memories and then reading in the data on the SIMATIC memory card.

Options

You have the following options for resetting the memory of the CPU:

- Using the mode selector
- Using the display
- Using STEP 7

Procedure using the mode selector

To perform a memory reset of the CPU using the mode selector, follow these steps:

1. Set the mode selector to STOP.
Result: The RUN/STOP LED lights up yellow.
2. Set the mode selector to the MRES position. Hold the selector in this position until the RUN/STOP LED lights up yellow for the 2nd time and remains lit (this takes three seconds). After this, Release the selector.
3. Within the next three seconds, return the mode selector to the MRES position, and then back to STOP.

Result: The CPU performs a memory reset. During the memory reset, the RUN/STOP LED flashes yellow. The RUN/STOP LED lights yellow when the CPU has completed the memory reset.

Procedure using the display

To reach the desired menu command, "Memory reset", select the following sequence of menu commands. Confirm with "OK" after each selection.

- Settings → Reset → Memory reset

Result: The CPU performs a memory reset.

Procedure using STEP 7

To perform a memory reset of the CPU via STEP 7, follow these steps:

1. Open the "Online Tools" task card of the CPU.
2. Click the "MRES" button in the "CPU control panel" pane.
3. Click "OK" to confirm the security prompt.

Result: The CPU is in STOP mode and performs a memory reset.

Response of the memory objects to the memory reset

The following table provides an overview of which memory objects are retained and which are initialized when you reset memory.

Table 2- 2 Retentive characteristics of the memory objects

Memory object	Contents
Actual values of the data blocks, instance data blocks	Initialized
Bit memories, timers and counters	Initialized
Retentive tags of technology objects (for example, calibration values of absolute encoders)*	Retained
Diagnostics buffer entries (retentive area)	Retained
Diagnostics buffer entries (non-retentive area)	Initialized
IP address	Retained
Counter readings of the operating hours counters	Retained
Time	Retained

* The retentive tags of technology objects are retained, but the contents of certain tags are partially re-initialized.

Reference

You will find more information about "Memory reset" in the Memory reset section in the S7-1500, ET 200MP (<http://support.automation.siemens.com/WW/view/en/59191792>) system manual.

2.6.4 Restoring the factory settings of the CPU

The reset to factory settings function restores the CPU to the factory settings. The function deletes all information that was stored internally on the CPU.

Note

If you want to remove a PROFINET CPU and use it elsewhere with a different program or put it into storage, we recommend that you reset the CPU to its factory settings. Remember that the Reset to factory settings function also deletes the IP address parameters.

Options

You have the following options for returning the CPU to the factory settings:

- Using the mode selector
- Using the display
- Using STEP 7

Procedure using the mode selector

Make sure that there is no SIMATIC memory card in the CPU and that the CPU is in STOP mode (RUN/STOP LED lights up yellow).

Perform a reset to factory settings as follows:

1. Set the mode selector to STOP.
Intermediate result: The RUN/STOP LED lights up yellow.
2. Set the mode selector to the MRES position. Hold the mode selector in this position until the RUN/STOP LED lights up yellow for the 2nd time and remains lit (this takes three seconds). After this, Release the selector.
3. Within the next three seconds, return the mode selector to the MRES position, and then back to STOP.

Result: The CPU executes the reset to factory settings, during which time the RUN/STOP LED flashes yellow. The RUN/STOP LED lit yellow indicates that the CPU has been reset to the factory settings and is in STOP mode. The "Reset to factory setting" event is entered in the diagnostics buffer.

Procedure using the display

Make sure that the CPU is in STOP mode (RUN/STOP LED lit yellow).

You can reach the "Factory settings" menu command by selecting the following menu commands one after the other and confirming each selection with "OK".

- Settings → Reset → Factory settings

Result: The CPU executes the reset to factory settings, during which time the RUN/STOP LED flashes yellow. The RUN/STOP LED lit yellow indicates that the CPU has been reset to the factory settings and is in STOP mode. The "Reset to factory setting" event is entered in the diagnostics buffer.

Procedure using STEP 7

Make sure that there is an online connection to the CPU that is to be reset to the factory settings.

1. Open the Online and Diagnostics view of the CPU.
2. In the "Functions" folder, select the "Reset to factory settings" group.
3. Select the option button "Retain IP address" if you want to keep the IP address. Select the option button "Delete IP address" if you want to delete the IP address.
4. Click "Reset".
5. Click "OK" to confirm the security prompt.

Result: The CPU is set to STOP mode and is reset to the factory settings.

Behavior of the memory objects with a reset to factory settings

The properties of the CPU are set to the following values:

Table 2- 3 Properties of the CPU objects in the factory settings

Memory object	Contents
Actual values of the data blocks, instance data blocks	Initialized
Bit memories, timers and counters	Initialized
Certain retentive tags from technology objects (for example, calibration values of absolute encoders)	Initialized
Diagnostics buffer entries (retentive area)	Initialized
Diagnostics buffer entries (non-retentive area)	Initialized
IP address	Depends on the procedure: <ul style="list-style-type: none"> • Using mode selector: is deleted • Using display: is deleted • Using STEP 7: Depending on the setting of the "Retain IP address"/"Delete IP address" option buttons
Counter readings of the operating hours counters	Initialized
Time	Initialized

Reference

You can find more information about the topic of "Reset to factory settings" in the function manual Structure and Use of the CPU Memory (<http://support.automation.siemens.com/WW/view/en/59193101>) as well as in the STEP 7 online help.

Connecting up

This section provides information on the terminal assignment of the individual interfaces and the block diagram of the CPU 1511-1 PN.

24 V DC supply voltage (X80)

The connector for the power supply is plugged in when the CPU ships from the factory.

The following table shows the terminal assignment for a 24 V DC power supply.

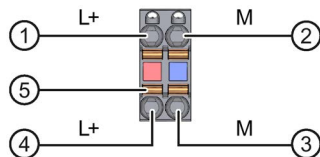

- ① +24 V DC of the supply voltage
- ② Ground of the supply voltage
- ③ Ground of the supply voltage for loop-through (current limited to 10 A)
- ④ +24 V DC of the supply voltage for loop-through (current limited to 10 A)
- ⑤ Spring opener (one spring opener per terminal)

Bridged internally:

- ① and ⑤
- ② and ③

Figure 3-1 Supply voltage connection

If the CPU is supplied by a system power supply, it is not necessary to connect the 24 V supply.

PROFINET interface X1 with 2-port switch (X1 P1 R and X1 P2 R)

The following table shows the terminal assignment for the PROFINET interface with 2-port switch. The assignment corresponds to the Ethernet standard for an RJ45 plug.

Table 3- 1 Terminal assignment of the PROFINET interface with 2-port switch

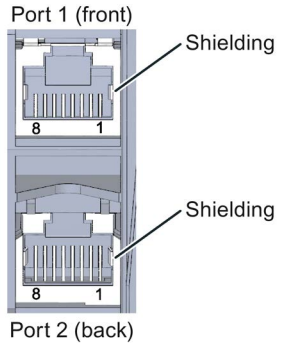
View	Signal name		Pin assignment
 <p>Port 1 (front)</p> <p>Shielding</p> <p>8 1</p> <p>Shielding</p> <p>8 1</p> <p>Port 2 (back)</p>	1	TD	Transmit data +
	2	TD_N	Transmit data -
	3	RD	Receive data +
	4	GND	Ground
	5	GND	Ground
	6	RD_N	Receive data -
	7	GND	Ground
	8	GND	Ground

Reference

You can find additional information on the topics of "Connecting the CPU" and "Accessories/spare parts" in the S7-1500, ET 200MP (<http://support.automation.siemens.com/WW/view/en/59191792>) system manual.

Assignment of the MAC addresses

The CPU 1511-1 PN has a PROFINET interface with two ports. The PROFINET interface itself has a MAC address, and each of the two PROFINET ports has its own MAC address. The CPU 1511-1 PN therefore has three MAC addresses in total.

The MAC addresses of the PROFINET ports are needed for the LLDP protocol, for example for the neighborhood discovery function.

The number range of the MAC addresses is sequential. The first and last MAC address are lasered on the rating plate on the right side of each CPU 1511-1 PN.

The table below shows how the MAC addresses are assigned.

Table 3- 2 Assignment of the MAC addresses

	Assignment	Labeling
MAC address 1	PROFINET interface X1 (visible in STEP 7 for accessible devices)	<ul style="list-style-type: none"> • Front, lasered • Right side, lasered (start of number range)
MAC address 2	Port X1 P1 R (required for LLDP, for example)	<ul style="list-style-type: none"> • Front and right side, not lasered
MAC address 3	Port X1 P2 R (required for LLDP, for example)	<ul style="list-style-type: none"> • Front, not lasered • Right side, lasered (end of number range)

Block diagram

The following figure shows the block diagram of the CPU 1511-1 PN.

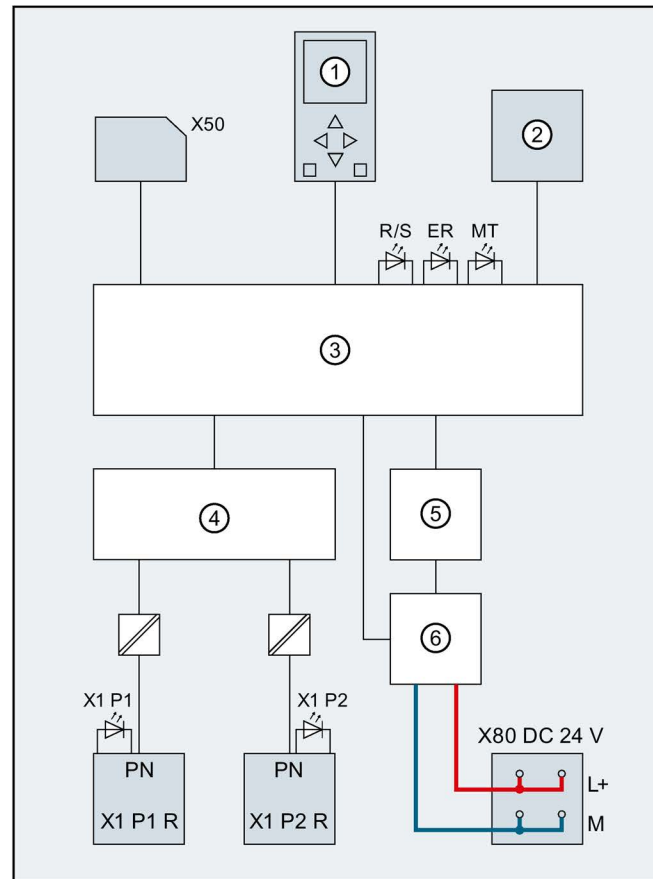

①	Display	PN X1 P1 R	PROFINET interface X1 Port 1
②	RUN/STOP/MRES mode selector	PN X1 P2 R	PROFINET interface X1 Port 2
③	Electronics	L+	24 V DC supply voltage
④	Switch	M	Ground
⑤	Backplane bus interface	R/S	RUN/STOP LED (yellow/green)
⑥	Internal supply voltage	ER	ERROR LED (red)
X50	SIMATIC memory card	MT	MAINT LED (yellow)
X80 24 V DC	Infeed of supply voltage	X1 P1, X1 P2	LED Link TX/RX

Figure 3-2 Block diagram of the CPU 1511-1 PN

Interrupts, error messages, diagnostics and system alarms

4

The status and error displays of the CPU 1511-1 PN are described below.

You will find additional information on "Interrupts" in the STEP 7 online help.

You can find additional information on the topics of "Diagnostics" and "System alarms" in the Diagnostics (<http://support.automation.siemens.com/WW/view/en/59192926>) function manual.

4.1 Status and error display of the CPU

LED display

The figure below shows the CPU 1511-1 PN LEDs.

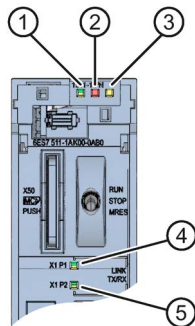





































- ① RUN/STOP LED (yellow/green LED)
- ② ERROR LED (red LED)
- ③ MAINT LED (yellow LED)
- ④ LINK RX/TX LED for port X1 P1 (yellow/green LED)
- ⑤ LINK RX/TX LED for port X1 P2 (yellow/green LED)

Figure 4-1 LED display of the CPU 1511-1 PN (without front panel)

Meaning of the RUN/STOP, ERROR and MAINT LED

The CPU 1511-1 PN has three LEDs to signal the current operating status and diagnostics status. The following table shows the meaning of the various combinations of colors for the RUN/STOP, ERROR and MAINT LEDs.

Table 4- 1 Meaning of the LEDs





RUN/STOP LED	ERROR LED	MAINT LED	Meaning
 LED off	 LED off	 LED off	Missing or insufficient power supply on the CPU.
 LED off	 LED flashes red	 LED off	An error has occurred.
 LED lit green	 LED off	 LED off	CPU is in RUN mode.
 LED lit green	 LED flashes red	 LED off	A diagnostics event is pending.
 LED lit green	 LED off	 LED lit yellow	Maintenance demanded for the plant. The affected hardware must be checked/replaced within a short period of time.
			Active Force job
			PROFenergy pause
 LED lit green	 LED off	 LED flashes yellow	Maintenance required for the plant. The affected hardware must be checked/replaced within a foreseeable period of time.
			Bad configuration
 LED lit yellow	 LED off	 LED flashes yellow	Firmware update successfully completed.
 LED lit yellow	 LED off	 LED off	CPU is in STOP mode.
 LED lit yellow	 LED flashes red	 LED flashes yellow	The program on the SIMATIC memory card is causing an error.
			CPU defective
 LED flashes yellow	 LED off	 LED off	CPU is performing internal activities during STOP, e.g. startup after STOP.
			Download of the user program from the SIMATIC memory card
 LED flashes yellow/green	 LED off	 LED off	Startup (transition from RUN → STOP)
 LED flashes yellow/green	 LED flashes red	 LED flashes yellow	Startup (CPU booting)
			Test of LEDs during startup, inserting a module.
			LED flashing test

4.1 Status and error display of the CPU

Meaning of LINK RX/TX LED

Each port has a LINK RX/TX LED. The table below shows the various "LED scenarios" of ports for the CPU 1511-1 PN.

Table 4- 2 Meaning of the LED

LINK TX/RX LED	Meaning
 LED off	There is no Ethernet connection between the PROFINET interface of the PROFINET device and the communication partner. No data is currently being sent/received via the PROFINET interface. There is no LINK connection.
 LED flashes green	The "LED flashing test" is being performed.
 LED lit green	There is an Ethernet connection between the PROFINET interface of your PROFINET device and a communication partner.
 LED flickers yellow	Data is currently being received from or sent to a communications partner on Ethernet via the PROFINET interface of the PROFINET device.

Technical specifications

	6ES7511-1AK00-0AB0
Product type designation	CPU 1511-1 PN
General information	
Hardware product version	FS06
Firmware version	V1.7
Engineering with	
STEP 7 TIA Portal can be configured/integrated as of version	V13 SP1
Display	
Screen diagonal (cm)	3.45 cm
Operator controls	
Number of buttons	6
Mode selector	1
Supply voltage	
Type of supply voltage	24 V DC
Low limit of permitted range (DC)	19.2 V
High limit of permitted range (DC)	28.8 V
Reverse polarity protection	Yes
Power and voltage failure backup	
Power/voltage failure backup time	5 ms
Input current	
Current consumption (rated value)	0.7 A
Inrush current, max.	1.9 A; rated value
I^2t	0.02 A ² s
Power	
Power consumption from the backplane bus (balanced)	5.5 W
Incoming power to the backplane bus	10 W
Power loss	
Power loss, typ.	5.7 W
Memory	
SIMATIC memory card required	Yes
Work memory	
Integrated (for program)	150 KB
Integrated (for data)	1 MB
Load memory	
Plug-in (SIMATIC memory card), max.	32 GB
Buffering	
maintenance-free	Yes

6ES7511-1AK00-0AB0	
CPU processing time	
For bit operations, typ.	60 ns
For word operations, typ.	72 ns
For fixed-point arithmetic, typ.	96 ns
For floating-point arithmetic, typ.	384 ns
CPU blocks	
Number of elements (total)	2000; elements can be taken to mean blocks such as DBs, FBs and FCs, as well as UDTs, global constants etc.
DB	
Number range	1 to 65535
Size, max.	1 MB; the maximum size of the DB is 64 KB with non-tuned block access
FB	
Number range	1 to 65535
Size, max.	150 KB
FC	
Number range	1 to 65535
Size, max.	150 KB
OB	
Size, max.	150 KB
Number of free-cycle OBs	100
Number of time-of-day interrupt OBs	20
Number of time-delay interrupt OBs	20
Number of cyclic interrupt OBs	20
Number of hardware interrupt OBs	50
Number of DPV1 interrupt OBs	3
Number of isochronous mode OBs	1
Number of technology synchronization interrupt OBs	2
Number of restart OBs	100
Number of asynchronous error OBs	4
Number of synchronous error OBs	2
Number of diagnostic interrupt OBs	1
Nesting depth	
Per priority class	24
Timers/counters and their retentivity	
S7 counters	
Quantity	2048
Retentivity	Yes
• Adjustable	

	6ES7511-1AK00-0AB0
IEC counters	
Quantity	Unlimited (limited only by work memory)
Retentivity	
• Adjustable	Yes
S7 timers	
Quantity	2048
Retentivity	
• Adjustable	Yes
IEC timers	
Quantity	Unlimited (limited only by work memory)
Retentivity	
• Adjustable	Yes
Data areas and their retentivity	
Total retentive data area (including timers, counters, bit memories), max.	128 KB; in total; for bit memories, timers, counters, DBs and technological data (axes), usable retentive memory: 88 KB
Bit memory	
Number, max.	16 KB
Number of clock memory bits	8; 8 clock memory bits, grouped in one clock memory byte
Data blocks	
Retentivity adjustable	Yes
Retentivity preset	No
Local data	
Per priority class, max.	64 KB max. 16 KB per block
Address area	
Number of I/O modules	1024; max. number of modules/submodules
I/O address area	
Inputs	32 KB; all inputs are in the process image
Outputs	32 KB; all outputs are in the process image
Of which per integrated IO subsystem	
• Inputs (volume)	8 KB
• Outputs (volume)	8 KB
Of which per CM/CP	
• Inputs (volume)	8 KB
• Outputs (volume)	8 KB
Process image partitions	
Number of process image partitions, max.	32

6ES7511-1AK00-0AB0	
Hardware configuration	
Number of hierarchical IO systems	20
Number of DP masters	
Via CM	4; a maximum of 4 CMs/CPs (PROFIBUS, PROFINET, Ethernet) can be inserted in total
Number of IO controllers	
Integrated	1
Via CM	4; a maximum of 4 CMs/CPs (PROFIBUS, PROFINET, Ethernet) can be inserted in total
Rack	
Modules per rack, max.	32; CPU + 31 modules
Rack, number of rows, max.	1
PtP CM	
Number of PtP CMs	The number of PtP CMs you can connect is only limited by the available slots
Time	
Clock	
Type	Hardware clock
Deviation per day, max.	10 s; typ.: 2 s
Buffered period	6 wk; at 40 °C ambient temperature, typ.
Operating hours counter	
Quantity	16
Time-of-day synchronization	
Supported	Yes
in AS, Master	Yes
in AS, Slave	Yes
On Ethernet via NTP	Yes
Interfaces	
Number of PROFINET interfaces	1
1. Interface	
Interface hardware	
• Number of ports	2
• Integrated switch	Yes
• RJ-45 (Ethernet)	Yes; X1
Protocols	
• PROFINET IO controller	Yes
• PROFINET IO device	Yes
• SIMATIC communication	Yes
• Open IE communication	Yes
• Web server	Yes
• Media redundancy	Yes

6ES7511-1AK00-0AB0	
Interface hardware	
RJ-45 (Ethernet)	
100 Mbps	Yes
Autonegotiation	Yes
Autocrossing	Yes
Industrial Ethernet status LED	Yes
Protocols	
Number of connections	
Number of connections, max.	96; via integrated interfaces of the CPU and connected CPs/CMs
Number of connections reserved for ES/HMI/Web	10
Number of connections via integrated interfaces	64
Number of S7 routing connections	16
PROFINET IO controller	
Services	
<ul style="list-style-type: none"> • PG/OP communication • S7 routing • Isochronous mode • Open IE communication • IRT • MRP • PROFIenergy • Prioritized startup • Number of connectable I/O devices, max. • Of which IO devices with IRT and the "high performance" option, max. • Number of IO devices that you can connect for RT, max. • Of which are in line, max. • Number of IO devices that can be activated/deactivated simultaneously, max. • Number of IO devices per tool changer, max. • Update times 	<ul style="list-style-type: none"> Yes Yes Yes Yes Yes Yes; as MRP redundancy manager and/or MRP client; max. number of devices in the ring: 50 Yes Yes; max. 32 PROFINET devices 128; a maximum of 256 distributed I/O devices can be connected by means of PROFIBUS or PROFINET. 64 128 128 8 8 The minimum value of the update time also depends on the communication component set for PROFINET IO, on the number of IO devices, and on the quantity of configured user data.

	6ES7511-1AK00-0AB0
With RT	
• for send clock of 250 µs	250 µs to 128 ms
• for send clock of 500 µs	500 µs to 256 ms
• for send clock of 1 ms	1 ms to 512 ms
• for send clock of 2 ms	2 ms to 512 ms
• for send clock of 4 ms	4 ms to 512 ms
With IRT and the "high performance" option	
• for send clock of 250 µs	250 µs to 4 ms
• for send clock of 500 µs	500 µs to 8 ms
• for send clock of 1 ms	1 ms to 16 ms
• for send clock of 2 ms	2 ms to 32 ms
• for send clock of 4 ms	4 ms to 64 ms
• For IRT with the "high performance" option and parameter assignment for so-called "odd-numbered" send clocks	Update time = set "odd-numbered" send clock (any multiple of 125 µs: 375 µs, 625 µs ... 3 875 µs)
PROFINET IO device	
Services	
• PG/OP communication	Yes
• S7 routing	Yes
• Isochronous mode	No
• Open IE communication	Yes
• IRT, supported	Yes
• MRP, supported	Yes
• PROFinergy	Yes
• Shared device	Yes
• Number of IO controllers with Shared Device, max.	4
SIMATIC communication	
S7 communication, as server	Yes
S7 communication, as client	Yes
User data per job, max.	See online help (S7 communication, user data size)
Open IE communication	
TCP/IP	
• Data length, max.	64 KB
• Several passive connections per port, supported	Yes

6ES7511-1AK00-0AB0	
ISO-on-TCP (RFC1006)	Yes
• Data length, max.	64 KB
UDP	Yes
• Data length, max.	1472 bytes
DHCP	No
SNMP	Yes
DCP	Yes
LLDP	Yes
Web server	
HTTP	Yes; standard and user-defined pages
HTTPS	Yes; standard and user-defined pages
Further protocols	
MODBUS	Yes; MODBUS TCP
Media redundancy	
Changeover time on line interruption, typ.	200 ms
Number of ring nodes, max.	50
Isochronous mode	
Isochronous mode (application synchronized up to terminal)	Yes; with minimum OB 6x cycle of 625 µs
Constant bus cycle time	Yes
S7 signaling functions	
Number of stations that can be logged in for signaling functions, max.	32
Block-related alarms	Yes
Number of configurable interrupts, max.	5000
Number of simultaneously active interrupts in interrupt pool	
• Number of reserved user interrupts	300
• Number of reserved interrupts for system diagnostics	100
• Number of reserved interrupts for motion technology objects	80
Test/commissioning functions	
Joint commissioning (Team Engineering)	Yes; parallel online access possible for up to 5 engineering systems
Status block	Yes; up to 8 simultaneously (in total from all ES clients)
Single-step	No

6ES7511-1AK00-0AB0	
Status/modify	
Status/modify tag	Yes
Tags	Inputs, outputs, bit memories, DBs, timers, counters
Of which are status tags, max.	200; per job
Of which are modify tags, max.	200; per job
Force	
Forcing, tags	Inputs, outputs
Number of tags, max.	200
Diagnostics buffer	
Available	Yes
No. of entries, max.	1000
<ul style="list-style-type: none"> • Of which are power failure-proof 	500
Traces	
Number of configurable traces	4; up to 512 KB data possible per trace
Interrupts/diagnostics/status information	
Diagnostic indicator LED	
RUN/STOP LED	Yes
ERROR LED	Yes
MAINT LED	Yes
Connection display LINK TX/RX	Yes
Supported technology objects	
Motion	Yes
<ul style="list-style-type: none"> • Speed-controlled axis <ul style="list-style-type: none"> – Number of speed-controlled axes, max. 	6; Requirement: no other motion technology objects have been created
<ul style="list-style-type: none"> • Positioning axis <ul style="list-style-type: none"> – Number of positioning axes, max. 	6; Requirement: no other motion technology objects have been created
<ul style="list-style-type: none"> • Synchronous axes (relative gearing) <ul style="list-style-type: none"> – Number of axes, max. 	3; Requirement: no other motion technology objects have been created
<ul style="list-style-type: none"> • External encoder <ul style="list-style-type: none"> – Number of external encoders, max. 	6; Requirement: no other motion technology objects have been created
Controller	
<ul style="list-style-type: none"> • PID_Compact 	Yes; universal PID controller with integrated optimization
<ul style="list-style-type: none"> • PID_3Step 	Yes; PID controller with integrated optimization for valves
<ul style="list-style-type: none"> • PID temp 	Yes; PID controller with integrated optimization for temperature

6ES7511-1AK00-0AB0	
Counting and measuring	
<ul style="list-style-type: none"> • High-speed counter 	Yes
Ambient conditions	
Ambient temperature in operation	
Horizontal installation, min.	0 °C
Horizontal installation, max.	60 °C; display: 50 °C, the display is switched off at an operating temperature of typically 50 °C
Vertical installation, min.	0 °C
Vertical installation, max.	40 °C; display: 40 °C, the display is switched off at an operating temperature of typically 40 °C
Configuring	
Programming	
Programming language	
<ul style="list-style-type: none"> • LAD • FBD • STL • SCL • GRAPH 	Yes Yes Yes Yes Yes
Know-how protection	
User program protection	Yes
Copy protection	Yes
Block protection	Yes
Access protection	
Password for display	Yes
Protection level: Write protection	Yes
Protection level: Read/write protection	Yes
Protection level: Complete protection	Yes
Cycle-time monitoring	
Low limit	Adjustable minimum cycle time
High limit	Adjustable maximum cycle time
Dimensions	
Width	35 mm
Height	147 mm
Depth	129 mm
Weights	
Weight, approx.	430 g

General technical specifications

You can find information on the general technical specifications, such as standards and approvals, electromagnetic compatibility, protection class, etc., in the S7-1500, ET 200MP (<http://support.automation.siemens.com/WW/view/en/59191792>) system manual.

Dimensional drawing

This section includes a dimensional drawing of the module on a mounting rail and a dimensional drawing with the front panel open. Always observe the specified dimensions for installation in cabinets, control rooms, etc.

Dimensional drawings for CPU 1511-1 PN

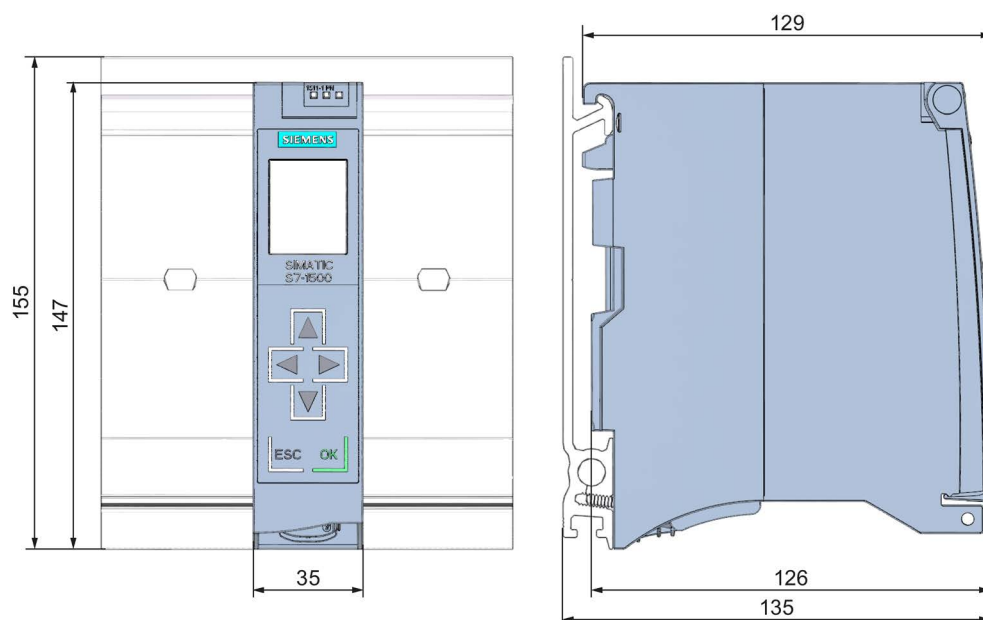

Figure A-1 Dimensional drawing of CPU 1511-1 PN, front and side views

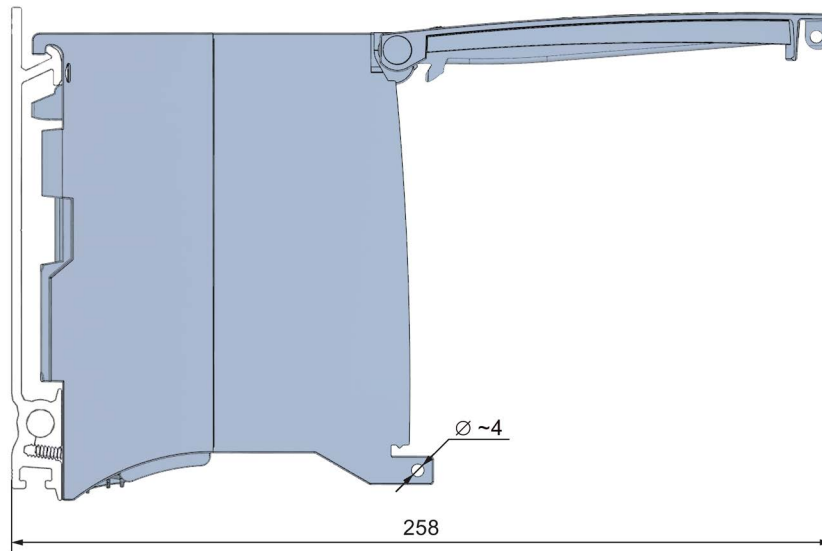

Figure A-2 Dimensional drawing of CPU 1511-1 PN, side view with front panel open