

SIMATIC NET

S7-CPs for Industrial Ethernet

Manual Part B3S

CP 343-1

6GK7 343-1EX21-0XE0

Version 1 or higher (Firmware Version V1.1)

for SIMATIC S7-300 / C7-300

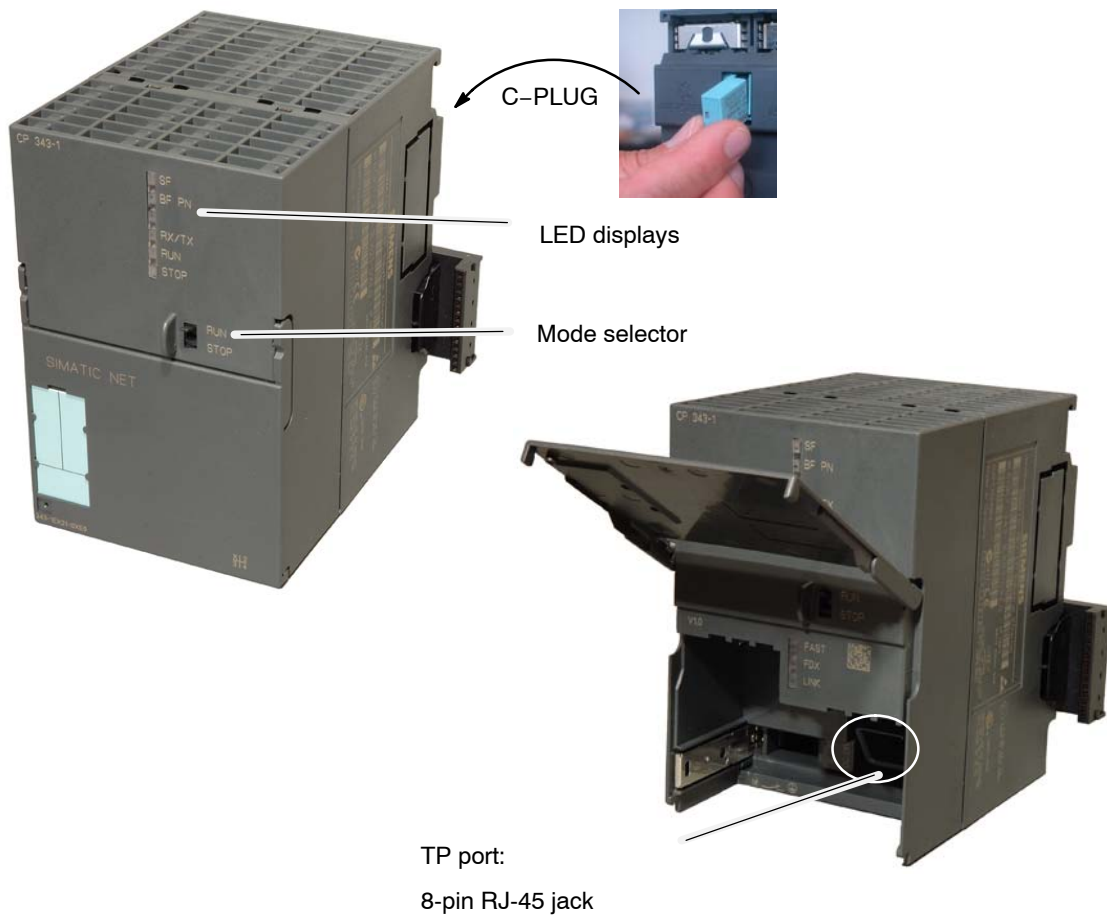

Notes on the Product

Product Names

This description contains information on the following product

- CP 343-1

Note

In this document, the term CP or CP 343-1 is used instead of the full product name.

Printed Product Information Supplied with the Product

Note

All the notices in the **Product Information Bulletin** shipped with this device are valid and must be adhered to.

Compatibility with the Previous Version

Note

Due to the **increased functionality and restrictions**, pay particular attention to the notes in Chapter 8 of this manual.

Address label: Unique MAC address preset for the CP

The CP ships with a factory-set MAC address.

To ensure a unique address assignment, we recommend that you use this factory set MAC address when configuring the module!



Contents

Contents – Part A

Ethernet CPs – General Information	See General Part
---	-------------------------

Note

Please remember that Part A of the manual also belongs to the description of the CP. Among other things, it contains explanations of the safety notices, the references to literature, and general information that applies to all S7 CPs for Industrial Ethernet.

The version of the General belonging to this Part B of the manual is version 1/2005.

You can also obtain the current Part A from the Internet:

<http://www4.ad.siemens.de/WW/news/de/8777865>

Contents – Part B3S

1 Properties / Services	B3S–5
2 Requirements for Use	B3S–9
3 Installation and Commissioning	B3S–11
3.1 Procedure / Steps	B3S–11
3.2 C–PLUG (Configuration Plug)	B3S–14
3.3 Module Replacement without PG	B3S–18
4 Displays and Mode Selector	B3S–20
5 Performance Data	B3S–23
5.1 General Characteristic Data	B3S–23
5.2 Characteristic Data for S7 Communication	B3S–23
5.3 Characteristics of the SEND/RECEIVE Interface	B3S–25
5.4 Characteristic Data for PROFINET IO	B3S–26
5.5 Characteristic Data for PROFINET CBA	B3S–27
5.6 Characteristics of the C–PLUG	B3S–30
5.7 Memory Organization	B3S–31
6 Using the CP 343–1 for PROFINET IO	B3S–32
6.1 Configuring the CP 343–1 as a PROFINET IO Controller	B3S–32
6.2 Operating PROFINET IO Alongside other Services	B3S–33

6.3	PROFINET IO Interface in the User Program: FCs	B3S-34
7	Using the CP 343-1 with PROFINET CBA	B3S-35
7.1	CBA Interface in the User Program with FB88	B3S-35
7.2	Preparing for Configuration with STEP 7	B3S-35
7.3	PROFINET Configuration with SIMATIC iMap	B3S-36
7.4	Using PROFINET CBA Communication and Standard Communication at the same Time	B3S-39
8	Compatibility with the Predecessor Product	B3S-41
8.1	Extended Functionality	B3S-41
8.2	Replacing Older Modules / Replacing Faulty Modules	B3S-42
9	Further Notes on Operation	B3S-44
9.1	Memory Reset	B3S-44
9.2	Working with Fast Ethernet – automatic switchover	B3S-46
9.3	SNMP Agent	B3S-47
9.4	Possible Security Gaps on Standard IT Interfaces / Preventing Illegal Access	B3S-48
9.5	Influence of MPI on Connections via Industrial Ethernet	B3S-49
9.6	Special Features of IP Configuration	B3S-49
9.7	Reserved Port Numbers	B3S-49
9.8	Restart after Detection of a Duplicate IP Address in the Network	B3S-50
9.9	Obtaining the IP Address over DHCP – CP STOP on Expiry of the Lease	B3S-50
9.10	IP Access Protection over the IP Access Control List in PROFINET IO	B3S-51
9.11	Additional Condition Codes in the Diagnostic Buffer	B3S-51
9.12	Setting the CPU Time of Day by the CP	B3S-51
9.13	Other information available about the CP	B3S-51
10	How to Load New Firmware	B3S-52
11	Technical Specifications	B3S-54

1 Properties / Services

Application

The CP 343-1 communications processor is designed for operation in an S7-300 programmable logic controller. It allows the S7-300 to be attached to Industrial Ethernet.

Services

The CP 343-1 supports the following communication services:

- PROFINET IO Controller
PROFINET IO allows direct access to IO devices over Ind. Ethernet.
- PROFINET CBA
Use of a SIMATIC S7-300 for Component based Automation based on the new PROFINET Standard of the PNO. This standard allows:
 - Component technology in automation
 - Graphic configuration of communication between intelligent devices instead of laborious programming
 - Vendor-independent, plant-wide engineering

Component based Automation allows access to the variables of PROFINET components from all standard PC applications with the OPC client interface, for example, visualization systems. Over the OPC server, objects can be selected directly from a variable selection list of the selected PROFINET component.
- S7 communication and PG/OP communication
 - PG functions (including routing)
 - Operator control and monitoring functions (HMI) multiplexing TD/OP connections
 - Client and server for data exchange using communication blocks ¹⁾ on S7 connections configured at both ends
 - Server for data exchange on S7 connections configured at one end only without communication blocks on the S7-300 / C7-300 station

1)

Blocks for S7 communication (see also STEP 7 online help or manual

“System Software for S7-300/400 System and Standard Functions”):

BSEND	FB12
BRCV	FB13
PUT	FB14
GET	FB15
USEND	FB8
URCV	FB9
C_CNTRL	FC62

- S5 compatible communication with
 - SEND/RECEIVE interface over ISO transport connections, ISO-on-TCP, TCP and UDP connections
 - Multicast over UDP connection

The multicast mode is made possible by selecting a suitable IP address when configuring connections.
 - FETCH/WRITE services (server; corresponding to S5 protocol) via ISO transport connections, ISO-on-TCP connections and TCP connections;

The addressing mode can be configured for FETCH/WRITE access as the S7 or S5 addressing mode.
 - LOCK/UNLOCK with FETCH/WRITE services;
- Time-of-day synchronization over Industrial Ethernet using the following configurable modes:
 - SIMATIC mode

The CP receives MMS time frames and synchronizes its local time and the time of the CPU (accuracy approx. +/- 1 second);

or
 - NTP mode (NTP: Network Time Protocol)

The CP sends time-of-day queries at regular intervals to an NTP server and synchronizes its local time of day and the time of the CPU (accuracy approx. +/- 1 second).
- Can be addressed using a factory-set MAC address

The CP can be reached using the default or configured MAC address to allow IP address assignment; the CP supports the PST function (Primary Setup Tool).
- SNMP Agent

The CP supports data queries over SNMP in version V1 (**S**imple **N**etwork **M**anagement **P**rotocol) according to the MIB II standard.
- IP access protection (IP-ACL)

Using IP access protection gives you the opportunity of restricting communication over the CP of the local S7 station to partners with specific IP addresses.
- IP configuration

You can configure how and with which method the CP is assigned the IP address, the subnet mask and the address of a default router.

It is also possible, as an alternative, to assign the connection configuration to the CP using STEP 7 or using a block interface in the user program (FB55: IP_CONFIG) (see /Part A).

Note: Does not apply to S7 connections.

Configuration

You can configure the CP 343-1 over MPI or LAN/Industrial Ethernet. You require STEP 7 with NCM S7 for Industrial Ethernet with the following version:

Table 1-1

Version STEP 7 / NCM IE	Functions of the CP 343-1
V5.3 Service Pack 2 or higher *)	Prerequisite for configuring all functions of the CP 343-1.

*) for use with V5.3 Service Pack 2, there is a hardware update that can be downloaded.

Project engineering for the use of PROFINET CBA

To be able to work in the PROFINET environment, you require the SIMATIC iMap engineering tool.

SIMATIC iMap requires a connection over Industrial Ethernet (TCP/IP protocol).

The following SIMATIC iMap project engineering software is required:

Table 1-2

Version of SIMATIC iMap	Functions of the CP 343-1
V2.0 + SP1	The full functionality of the device can be used as of hardware version 1 and firmware version V1.1.

To operate PROFINET CBA, you require the current service packs of SIMATIC iMap containing the current FB88 V1.5 function block:

SIMATIC iMap V2.0 – Download Service Pack 1:

<http://www4.ad.siemens.de/WW/view/en/19762802>

SIMATIC iMap STEP 7 Add-on V2.0 – Download Service Pack 3:

<http://www4.ad.siemens.de/WW/view/en/21981502>

Programming – Using Blocks

For some communications services, there are pre-programmed blocks (FCs/FBs) available as the interface in your STEP 7 user program.

You will find a detailed description of these blocks in the NCM S7 for Ethernet manuals.

Notice

We recommend that you always use the latest block versions for all module types.

You will find information on the latest block version and links to download the current blocks in our Customer Support on the Internet:

<http://www4.ad.siemens.de/WW/news/en/8797900>

If you are using older block types, this recommendation only applies if you also have the latest firmware version.

You will find further information and Internet addresses in the Preface of the General Part of this manual.

Notice

The FCs for PROFINET IO services are not yet supplied with STEP 7 Version V5.3 Service Pack 2. Please use the download address above to obtain the current versions of the FCs PNIO_SEND and PNIO_RECV.

These FCs are supplied with STEP 7 Version V5.3 Service Pack 3.

2 Requirements for Use

General Operation

The CP can be operated in the following device families:

- S7-300 stations with the CPU types
 - Standard
 - Compact
 - Modular
- C7 control systems in C7 packaging system

The following tables show the devices with which the CP 343-1 can be operated with this range of functions:

Notice

The tables list the CPUs and devices approved at the time of printing this manual. S7-300 CPUs or C7 or C7 control systems approved later and not listed in the table also support the range of functions described here.

Table 2-1 Use of the CP with S7-300

CPU	Order Number
CPU 312C	6ES7312-5BD01-0AB0
CPU 313C	6ES7313-5BE01-0AB0
CPU 313C PtP	6ES7313-6BE01-0AB0
CPU 313C-2DP	6ES7313-6CE01-0AB0
CPU 314C PtP	6ES7314-6BF01-0AB0
CPU 314C PtP	6ES7314-6BF02-0AB0
CPU 314C-2DP	6ES7314-6CF01-0AB0
CPU 314C-2DP	6ES7314-6CF02-0AB0
CPU 312	6ES7312-1AD10-0AB0
CPU 314	6ES7314-1AF10-0AB0
CPU 314	6ES7314-1AF11-0AB0
CPU 315-2 DP	6ES7315-2AG10-0AB0
CPU 315-2PN/DP ¹⁾	6ES7 315-2EG10-0AB0
CPU 317-2 DP	6ES7317-2AJ10-0AB0
CPU 317-2PN/DP ¹⁾	6ES7317-2EJ10-0AB0
CPU 317T-2 DP	6ES7317-6TJ10-0AB0
CPU 318-2 DP	6ES7318-2AJ00-0AB0

Table 2-1 Use of the CP with S7-300, continued

CPU	Order Number
CPU 315F-2DP	6ES7315-6FF01-0AB0
CPU 317F-2DP	6ES7317-6FF00-0AB0

1) Note: When using the CPU315/317-2PN/DP, PROFINET CBA can only be configured and used over the CPU (not over the CP).

Table 2-2 Use of the CP in C7 Control Systems

C7 control system	Order Number
C7-613	6ES7 613-1CA01-0AE3
C7-633 /P	6ES7 633-1DF02-0AE3
C7-633 DP	6ES7 633-2BF02-0AE3
C7-635 Touch	6ES7 635-2EB01-0AE3
C7-635 Key	6ES7 635-2EC01-0AE3
C7-636 Touch 10"	6ES7 636-2EB00-0AE3
C7-636 Key	6ES7 636-2EC00-0AE3

Table 2-3 Using the CP with SINUMERIK

Device / CPU
NCU57x.3: PLC 315-2DP M/S 2AF03
NCU57x.4: PLC 314C-2DP
NCU57x.5: PLC 317-2DP 2AJ10

3 Installation and Commissioning

3.1 Procedure / Steps

Step	Explanation / Meaning
1. Install the CP on the S7 standard rail. 2. Establish the connection via the enclosed bus connector to the backplane bus. Notes <ul style="list-style-type: none"> • The CP cannot be used in an extension rack that is connected via the IM 365! • If you want to use the CP with PROFINET CBA, a C-PLUG must be inserted. 	Slots 4 to 11 are permitted for the CP in racks 0 to 3 (connected by IM 360/361). Proceed as in the sections dealing with setup and wiring, described in detail in /1/.
3. Connect the CP to the power supply. Notes <ul style="list-style-type: none"> • The CPU, CP and IM (if one exists) must be connected to the same power supply. • Only wire up the S7-300 / C7-300 with the power switched off! 	Follow the steps as described in detail in /1/ when wiring between the power supply and the CPU.
4. Attach the CP to Industrial Ethernet.	
5. The remaining steps in commissioning involve downloading the project engineering data.	You can connect the PG when configuring the CP as follows: <ul style="list-style-type: none"> • via MPI • via Industrial Ethernet For further details, refer to the general Part A of this manual: <ul style="list-style-type: none"> – addressing the first time (IP address assignment / node initialization); – downloading the defined configuration The PG/PC requires a LAN attachment, for example via a CP 1613 or CP 1612 and must have the necessary software (for example the S7-1613 package or SOFTNET IE). The TCP/IP protocol or ISO protocol must be installed. The protocol used must then be applied to the S7ONLINE access point.

Step	Explanation / Meaning
6. User diagnostics for commissioning and to analyze problems.	The following options are available: <ul style="list-style-type: none">• Hardware diagnostics and troubleshooting with STEP 7• Communication diagnostics with STEP 7 / NCM Diagnostics• Standard information using HW Config
7. Optional when using with PROFINET CBA: Download PROFINET CBA component	If the S7 station in which the CP is operated is used as a PROFINET CBA component, the interconnections are downloaded using SIMATIC iMap; for more detailed information, refer to the topic "Using the CP with PROFINET CBA".

Notice

- The hinged front panel must be kept closed during operation.
- The module must be installed so that its upper and lower ventilation slits are not covered, allowing adequate ventilation.

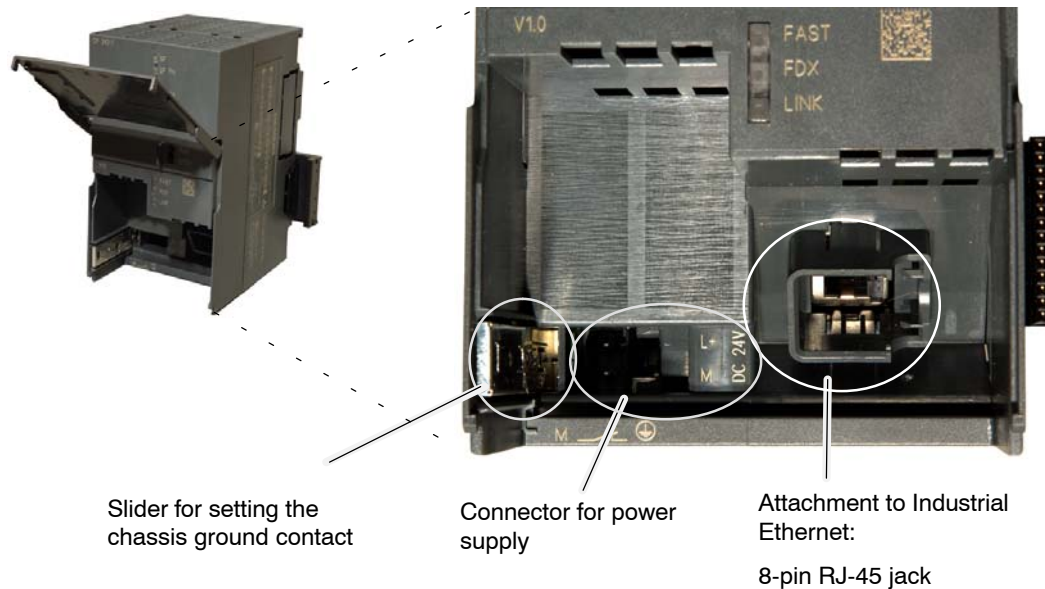

Figure 3-1 Connectors with Front Panel Opened

Ground/Chassis Ground Concept**Notice**

Please keep to the instructions on the grounding and chassis concept in the installation instructions for the SIMATIC S7-300/S7-400 /1/.

Behind the hinged panel on the left of the device, you will see a slider with which you can connect or disconnect the chassis ground of the 24 V power supply with reference ground.

- Slider pushed in: chassis and reference ground connected (note: the slider must be felt to lock in place).
- Slider pulled out: No connection between chassis and reference ground.

When shipped: Slider pushed in

Use a screwdriver to set the slider.

Configuration

To initialize the CP for communication services, use the configuration tool STEP 7 / NCM S7. Refer to Chapter 1 of this manual.

3.2 C-PLUG (Configuration Plug)

Exchangeable C-PLUG

The CP has a receptacle for an optional configuration plug (known as a C-PLUG). This can store up to 32 MB of data in nonvolatile memory.

Area of Application

The C-PLUG is an exchangeable medium for storing configuration and project engineering data of the basic device (CP 343-1). This means that configuration data remains available if the basic device is replaced. It is possible to replace the module without a PG.

We always recommend that you store the project engineering data on the CPU. In cases in which the project engineering data storage of the CPU is not adequate (large PROFINET IO configurations), the project engineering data can be stored in optional C-PLUGs inserted in the CP.

The retentively stored parameters include the complete configuration data:

- IP address and IP parameters
- A newly set MAC address
- LAN settings
- SNMP Variables (modifiable)
- Interconnection information for PROFINET CBA (C-PLUG necessary)

Notice

The PROFINET CBA function is available only when a C-PLUG is inserted.

Principle

The power is supplied by the basic device. When powered down, the C-PLUG retains all data permanently.

Flash components are used in the C-PLUG in which the number of write operations is limited.

This must be taken into account when using blocks in the user program that write data to the C-PLUG (for example FB55 with changing IP parameters). Refer to the information in Section 5.6.

Inserting in the C-PLUG Slot

The slot for the C-PLUG is on the rear panel of the device.

The C-PLUG is inserted in the receptacle.

Notice

The C-PLUG must be inserted or removed only when the power is off!



Figure 3-2 Fitting the C-PLUG and Removing It from the CP with a Screwdriver

Function

If the C-PLUG has not yet been written to (as shipped), when the device starts up, all the configuration data of the CP is saved automatically on it. Modifications to the configuration during operation are also saved on the C-PLUG without any action by the user being necessary.

If the C-PLUG is inserted, the basic device automatically uses the configuration data of the C-PLUG. This assumes that the data was written by a compatible device type.

If a fault occurs, the basic device can then be replaced much faster and more simply. If a device needs to be replaced, the C-PLUG is simply taken from the failed component and inserted in the replacement. As soon as it starts up, the replacement automatically has the same device configuration as the failed device.

Working with and without a C-PLUG

The following table provides you an overview of how data is transferred to the C-PLUG. The following situations must be distinguished:

- As shipped – operation without C-PLUG
- A C-PLUG is inserted in a module in the status as shipped
- A C-PLUG is inserted in an already installed module

Table 3-1 Working with and without a C-PLUG

Progress / status	Behavior during data transmission	Result after startup
As shipped – operation without C-PLUG		
<ul style="list-style-type: none"> • Flash memory empty • C-PLUG not inserted. 	The project engineering data is transferred from the STEP 7 project.	The CP starts up with the project engineering data that was transferred to the flash memory.
A C-PLUG is inserted in a module in the status as shipped		
<ul style="list-style-type: none"> • Flash memory empty • Empty C-PLUG is inserted. 	The project engineering data is transferred from the STEP 7 project.	The following must be distinguished depending on the configuration: <ul style="list-style-type: none"> • Data storage on the CP: The CP starts up with the project engineering data that was transferred to the C-PLUG. • Data storage on the CPU (recommended mode) The retentive parameters are located on the C-PLUG.
<ul style="list-style-type: none"> • Flash memory empty • C-PLUG with project engineering data is inserted. Requirement: The project engineering data must be valid for the CP 1)	Project engineering data on the C-PLUG is recognized as valid. 1)	The CP starts up with the project engineering data on the C-PLUG.

Table 3-1 Working with and without a C-PLUG, continued

Progress / status	Behavior during data transmission	Result after startup
A C-PLUG is inserted in an already installed module		
<ul style="list-style-type: none"> Flash memory with project engineering data Empty C-PLUG is inserted. 	<p>When the CP starts up, the project engineering data are loaded on the C-PLUG from flash memory</p> <p>The project engineering data in flash memory is deleted.</p>	<p>The CP starts up with the project engineering data transferred to the C-PLUG from flash memory.</p>
<ul style="list-style-type: none"> Flash memory with project engineering data. C-PLUG with project engineering data is inserted. <p>Requirement: The project engineering data must be valid for the CP. 1)</p>	<p>As long as the C-PLUG contains valid project engineering data for the CP, this project engineering data is used; The data in flash memory is ignored.</p> <p>During the next startup, the internal flash memory is reset. 2)</p>	<p>Result: The CP starts up with the project engineering data stored on the C-PLUG.</p>

1) Note: If the C-PLUG does not contain any project engineering data for the CP, the device will not start up! In this case, use the NCM diagnostics to clarify the situation and, if necessary, format the C-PLUG.

2) Reason: When necessary, this gives you the opportunity of transferring the data from flash memory to the C-PLUG. The data on the C-PLUG is accepted as valid only during the next startup.

C-PLUG Formatting

Use only C-PLUGs that are formatted for the CP 343-1. C-PLUGs that have already been used and formatted in other device types must first be formatted for the CP 343-1 device type.

You do this with STEP 7 / NCM Diagnostics. For more detailed information, refer to the online help in the topic "General Diagnostics Functions – C-PLUG Diagnostics Object".

After formatting, all data areas are deleted on the C-PLUG. Project engineering is adopted by the CPU only after reloading or after turning on the power supply again(see Table 3-1).

Removing the C-PLUG

It is only necessary to remove the C-PLUG if a fault occurs on the basic device (see Figure 3-2).

Notice

The C-PLUG must be removed only when the power is off!

Diagnostics

Inserting a C-PLUG containing the configuration of an incompatible device type, accidentally removing the C-PLUG or general malfunctions of a C-PLUG are signaled by the diagnostic mechanisms of the host device (SF-LED red).

3.3 Module Replacement without PG

General Procedure

The project engineering data for the CP 343-1 is stored optionally on the CPU or on the CP or in the C-PLUG of the CP; this means that the module can be replaced with the module of the same type (identical order number) without a PG.

This option can be selected in the properties dialog of the CP (in "Replace Module without PG"). We always recommend that you store the project engineering data on the CPU. In cases in which the project engineering data storage of the CPU is not adequate (large PROFINET IO configurations), the project engineering data can be stored in optional C-PLUGs inserted in the CP.

For information on replacing previous modules, please refer to the section "Compatibility".

Module replacement: Special feature with PROFINET CBA

For PROFINET CBA, the interconnection information is stored on the C-PLUG. The following must therefore be distinguished when replacing a module:

- C-PLUG of the previous module is used

In this case, the interconnection information is available directly on the C-PLUG.

- A new C-PLUG is used

In this case, download the interconnection information again with SIMATIC iMap.

Module replacement: Special feature of IP address assignment from a DHCP server

During configuration of the CP you can specify the IP configuration in the properties dialog; one option is to obtain the IP address from a DHCP server.

Notice

When replacing modules, remember that the factory-set MAC address of the new module is different from the previous module. When the factory-set MAC address of the new module is sent to the DHCP server, this will return either a different or no IP address.

Ideally, you should therefore configure IP as follows:

Always configure a client ID if you want to obtain the same IP address from the DHCP server after replacing the module.

If you have configured a new MAC address instead of the factory-set MAC address (generally the exception), the DHCP server always receives the configured MAC address and the CP obtains the same IP address as the replaced module.





































4 Displays and Mode Selector





Along with the five LEDs on the front panel that are used to indicate the mode, there is an additional display with two LEDs (on the CP 343-1 located beside the RJ-45 jack hidden by the front panel) to indicate the communication status.



Front panel:		SF BF PN RX/TX RUN STOP
Beneath the front panel:		FAST FD LINK

LEDs Displaying the Status

The different combinations of the LEDs on the front panel indicate the status:

SF(red)	BF PN (red)	RUN(green)	STOP(yellow)	CP Operating Mode
				Starting up (STOP->RUN)
				Running (RUN)
				Stopping (RUN->STOP)
				Ready for firmware loading (this mode is active for ten seconds following power up when the mode selector is set to STOP)
				RUN with external error; Diagnostic information from one or more IO devices is available.
				Waiting for firmware update (CP currently has an incomplete or incorrect firmware version)
				Stopped (STOP) In the STOP mode configuring and performing diagnostics on the CP remain possible.
				Stopped (STOP) with errors In this state, the CPU or intelligent modules in the rack remain accessible using PG functions.
				RUN with external error One or more IO devices are not obtainable.

SF(red)	BF PN (red)	RUN(green)	STOP(yellow)	CP Operating Mode
				Module fault / system error

Legend:  on  off  flashing (0.5 Hz)

CP Communication State

In addition to the LEDs that signal the CP state, behind the front panel there are also LEDs that provide information about the status of the CP interface to Industrial Ethernet.

Table 4-1

LED	Meaning (LED on)
LINK LED (green)	Indicates an established connection to Ethernet:
RX/TX LED (green)	Flashing: The CP is sending/receiving over Ethernet
FAST LED (green)	Signals an existing connection to TP at 100 Mbps (Fast Ethernet)
FD LED (green)	Signals an existing full duplex connection

Controlling the Operating Mode

There are different ways in which you can control the mode of the CP, as follows:

- Mode selector
- SIMATIC Manager in STEP 7

To control the mode from STEP 7 / NCM S7, the mode selector must be set to RUN.

Mode selector

With the mode selector, you can set the following modes:

- Switch from STOP to RUN:

The CP reads the configured and/or modified data into the work memory and then changes to the RUN mode.

Note

The modes can only be controlled using NCM S7 or the SIMATIC Manager when the selector is set to RUN.

- Switch from RUN to STOP:

The CP changes to STOP with the following results:

- Established connections (ISO transport, ISO-on-TCP, TCP connections) are terminated (this transition phase is signaled by the LEDs with the “Stopping” state).

The reaction is as follows in STOP:

- All connections are terminated
- The configuration and diagnostics of the CP remains possible (system connections for configuration, diagnostics, and PG channel routing are retained);
- The routing function is active
- The time of day is not forwarded
- PROFINET IO is disabled
- PROFINET CBA is disabled

Note

Please read the explanations in the General Part A of this manual on the topic of downloading project engineering data to the CP.

5 Performance Data

5.1 General Characteristic Data

Table 5-1

Characteristic	Explanation / Values
Number of simultaneous connections in total over Industrial Ethernet	48 maximum

Example of Maximum Load

You can operate:

- 32 S7 connections
- 2 ISO-on-TCP connections
- 8 TCP connections
- 6 UDP connections

5.2 Characteristic Data for S7 Communication

Table 5-2

Characteristic	Explanation / Values
Number of connections for S7 communication on Industrial Ethernet	in each case, up to <ul style="list-style-type: none"> • 16 Operator control and monitoring functions (HMI) • 16 S7 connections configured at one end • 16 S7 connections configured at both ends The number depends on the CPU type being used. Please refer to /1/ for the values for your CPU.
LAN interface – data field length generated by CP per protocol data unit <ul style="list-style-type: none"> • sending • receiving 	240 bytes / PDU 240 bytes / PDU

Execution Times of the SFBs for S7 Connections

To calculate the CPU cycle times (OB1) with S7 connections, the execution time for the system function blocks (SFBs PUT, GET, USEND, URCV, BSEND, BRCV) required for processing on the S7-300 / C7-300 CPU is the decisive factor.

Table 5-3

Block type	Execution time on the CPU per block call					
	PUT	GET	USEND	URCV	BSEND	BRCV
Data length	<=160 bytes			<=16 K bytes		
CPU 314C-2DP (6ES7 314-6CF00-0AB0)	<4.9 ms	<4.6 ms	<4.4 ms	<4.8 ms	<4.7 ms	<4.9 ms
CPU 317-2PN/DP (6ES7 317-2EJ10-0AB0)	<1.1 ms	<1.4 ms	<1.3 ms	<1.5 ms	<1.4 ms	<1.9 ms

5.3 Characteristics of the SEND/RECEIVE Interface

Table 5-4

Characteristic	Explanation / Values
Total number of ISO transport connections + ISO-on-TCP connections + TCP connections + UDP connections	Maximum 16 Notes: <ul style="list-style-type: none"> All UDP connections are also possible in the multicast mode
Max. data length for blocks AG_SEND (V4.0 and higher) and AG_RECV (V4.0 and higher)	AG_SEND and AG_RECV allow the transfer of data fields of between 1 and 240 bytes. <ul style="list-style-type: none"> 1 to 8192 bytes for ISO transport, ISO-on-TCP, TCP; 1 to 2048 bytes for UDP
Restrictions for UDP <ul style="list-style-type: none"> Transfer is not confirmed Data field length No reception of UDP broadcast 	<p>The transmission of UDP frames is unconfirmed, in other words the loss of messages is not detected or displayed by the send blocks (AG_SEND).</p> <p>The maximum length of the data fields is 2048 bytes.</p> <p>To avoid overload resulting from a high broadcast load, the CP does not permit reception of UDP broadcast.</p>

Execution Times of the FCs AG_SEND / AG_RECV

To calculate the CPU cycle times (OB1) with SEND/RECEIVE connections, the execution time for the FCs (FC AG_SEND, FC AG_RECV) required for processing on the S7-300 / C7-300 CPU is the decisive factor.

Table 5-5

Component	Explanation / Values	
Execution time on the CPU 315-2DP (6ES7 315-2EG10-0AB0)	per AG_SEND block call: <ul style="list-style-type: none"> <1.6 ms at <=240 bytes 	per AG_RECV block call: <ul style="list-style-type: none"> <2.2 ms at <=240 bytes
Execution time on the CPU 317-2PN/DP (6ES7 317-2EJ10-0AB0)	per AG_SEND block call: <ul style="list-style-type: none"> <1.3 ms at <=240 bytes 	per AG_RECV block call: <ul style="list-style-type: none"> <1.9 ms at <=240 bytes

5.4 Characteristic Data for PROFINET IO

The CP supports the following maximum configuration as a PROFINET IO controller:

Table 5-6

Characteristic	Explanation / Values
Number of possible PROFINET IO devices How many PROFINET IO devices can be operated depends on the memory areas used for data storage. <ul style="list-style-type: none"> • Operation with C-PLUG / data storage on the CP • Data storage on the CPU The limit values shown (examples) reduce depending on the system resources taken up by the communication services! 	maximum of 125 *) Examples of limit values: CPU 315: to 128
Size the input area over all PROFINET IO devices	2160 bytes max.
Size the output area over all PROFINET IO devices	2160 bytes max.
Size of the IO data area per submodule of a module in an IO device <ul style="list-style-type: none"> • Inputs • Outputs 	128 bytes 128 bytes
Size of the consistency area for a submodule	128 bytes
Number of CP 343-1 modules that can be operated as PROFINET IO controllers within an S7-300 station.	1

*) The specified maximum value can be achieved when using a C-PLUG.

5.5 Characteristic Data for PROFINET CBA

The CP supports PROFINET CBA interconnections between PROFINET CBA components. A C-PLUG must be inserted.

The "typical" values specified below are values that cause the SIMATIC iMap configuration tool to generate a warning if they are exceeded; it is nevertheless possible that the configuration can be operated.

If one of the limit values specified for the interconnections is exceeded, they cannot be downloaded to the module. When the interconnections are downloaded, the SIMATIC iMap configuration tool generates an error message to this effect. If a limit value relating to the number or size of components is exceeded, the CPU will not change to RUN!

Table 5-7 Characteristic Data for PROFINET CBA Communication

Characteristic	Typical value	Limit value
PROFINET CBA		
Number of remote interconnection partners	32	64
Total of all I/Os	600	1000
Data length of all incoming I/Os	2048 bytes	8192 bytes
Data length of all outgoing I/Os	2048 bytes	8192 bytes
Data length for arrays and structures (acyclic interconnections), maximum	2048 bytes	8192 bytes
Data length for arrays and structures (cyclic interconnections), maximum	450 bytes	450 bytes
Data length for arrays and structures (local interconnections), maximum	–	2400 bytes
Remote interconnections with acyclic transmission		
Sampling frequency: sampling interval, min. Possible values: 100, 200, 500, and 1000 ms	Fast value: 20% Medium value: 40% Slow value: 40%	100 ms minimum
Number of incoming interconnections	50	128 maximum
Number of outgoing interconnections	50	128 maximum
Data length of all incoming interconnections	2048 bytes	8192 bytes
Data length of all outgoing interconnections	2048 bytes	8192 bytes
Remote interconnections with cyclic transmission		
Transmission frequency: transmission interval, min. Possible values: 10, 20, 50, 100, 200, 500, and 1000 ms	Fast value: 20% Medium value: 40% Slow value: 40%	10 ms minimum
Number of incoming interconnections	125	200
Number of outgoing interconnections	125	200
Data length of all incoming interconnections	1000 bytes	2000 bytes
Data length of all outgoing interconnections	1000 bytes	2000 bytes

Table 5-7 Characteristic Data for PROFINET CBA Communication, Fortsetzung

Characteristic	Typical value	Limit value
HMI variables over PROFINET (acyclic)		
Number of stations that can register for HMI variables (PN OPC/iMap)	–	3 (Stations are 2 x PN OPC and 1 x SIMATIC iMap)
HMI variable update	–	500 ms minimum
Number of HMI variables	–	200 maximum
Data length of all HMI variables	1600 *)	8192 bytes
Device–internal interconnections		
Number of device–internal interconnections	50	256
Data length of all device–internal interconnections	400 bytes	2400 bytes
Interconnections with constants		
Number of interconnections with constants	100	200 maximum
Data width of all interconnections with constants	1024	4096
PROFIBUS proxy functionality		
Supported	No	No
Access to S7extended variables		
Maximum number of S7 connections for access to variables with the PROFINET attribute “s7extended”.	16 (not checked by iMap)	32 maximum Note: You should also keep in mind the maximum number of connections according to Section 7.3
Note: The PROFINET attribute “s7extended” is used only by OPC applications over the OPC server; variables with this attribute can only be used with OPC applications.		

*) The value is not checked by iMap.

Note

For information on the data length and data type in PROFINET CBA communication, refer to the online help on SIMATIC iMap, the “Creating PROFINET Components” manual and the “Configuring Plants with SIMATIC iMap” manual.

Reaction times for PROFINET CBA

The achievable reaction times for PROFINET CBA communication depend on the following factors:

- Type of interconnection (cyclic or acyclic) and the transmission frequency or scanning frequency
- The size of the configuration on the component interface (interface DB of the PROFINET CBA function block (FB88/FB90))
- CPU cycle time

As a result, the reaction times for cyclic PROFINET CBA interconnections may exceed the configured value for the update time. You should therefore check the achievable reaction time during commissioning.

Since reaction times < 50 ms cannot be guaranteed, you should not set a transmission frequency ≤ 50 ms for cyclic interconnections.

Reaction times of 50 ms can be achieved at CPU cycle times of < 5 ms and with the following configuration limits:

- < 200 bytes inputs and at the same time
- < 200 bytes outputs
- maximum of 200 interconnection distributed on 32 partners

With higher CPU cycle times, the PROFINET CBA function block (FB88) should be called more often in the user program.

Note

The values of the utilization parameters displayed by SIMATIC iMap with the "Edit / Check utilization" function relate to the data exchange as far as the CP. They do not apply to data access from the user program.

Execution times of the PN_InOut (FB88) function block

To calculate the CPU cycle times (OB1) in CBA operation, the execution time for the FB PN_InOut (FB88) required for processing on the S7-300 / C7-300 CPU is the decisive factor.

Table 5-8

Duration	length of the interface DB / bytes			
	512	1024	2048	4096
minimum / μs	122	123	123	123
maximum / μs	2330	2330	2400	2400
typical / μs	1100	1270	1400	1435

From the table, you can see that the OB1 cycle is extended by at least 122 μs and by a maximum of 2400 μs .

5.6 Characteristics of the C-PLUG

The flash area allows a limited number of write cycles.

- Number of write cycles: approx. 100 000

Recommendation: You should therefore avoid writing data cyclically.

5.7 Memory Organization

The data areas on the CP 343-1 are organized as follows when using a C-PLUG (C-PLUG is optional):

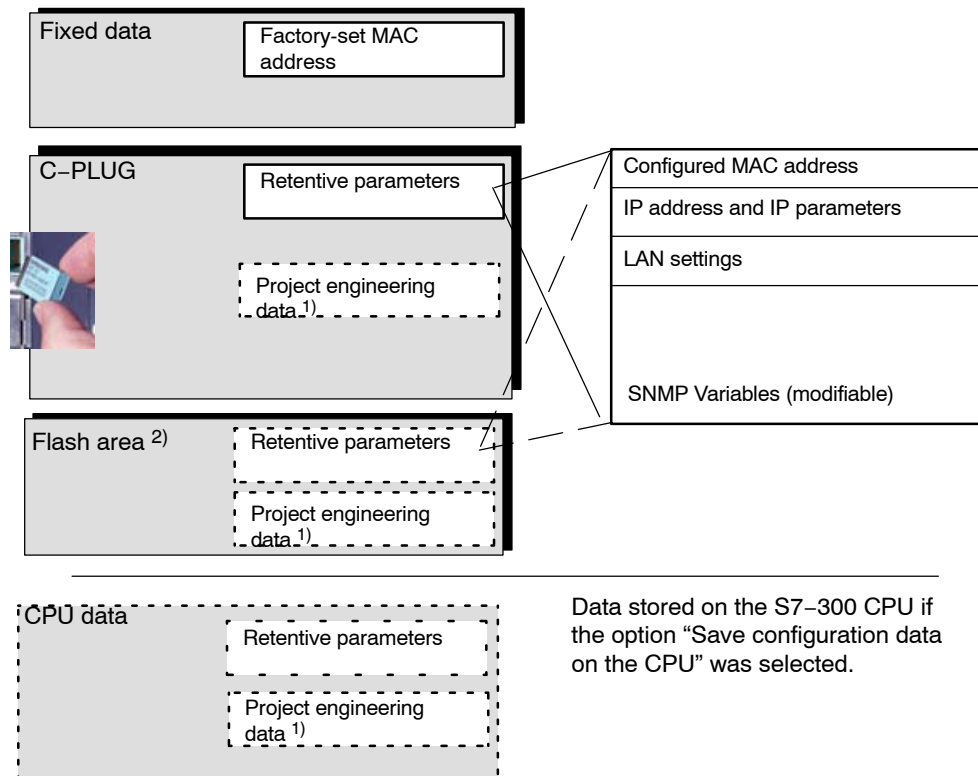

Legend:

1)
The configuration data can be stored on the CPU or on the CP. This option can be selected in the properties dialog of the CP (in "Replace Module without PG" - "Options" tab). We always recommend that you store the configuration data on the CPU. In cases in which the project engineering data storage of the CPU is not adequate (large PROFINET IO configurations), the project engineering data can be stored in optional C-PLUGs inserted in the CP.

2)
The internal flash area on the CP is used if no C-PLUG is inserted.

6 Using the CP 343-1 for PROFINET IO

PROFINET IO allows direct access to PROFINET IO devices over Ind. Ethernet.

To access the field devices connected to PROFIBUS DP, there are gateways available that are used as PROFINET IO proxies (IE/PB Link).

6.1 Configuring the CP 343-1 as a PROFINET IO Controller

PN IO System in STEP 7

In principle, you configure for PROFINET IO as follows:

To be able to use the CP as a PROFINET IO controller, create a PROFINET IO system in STEP 7 / HW Config. You can either assign an existing or a new Ethernet subnet to the CP as the PROFINET IO system.

Then add the PROFINET IO devices to the PROFINET IO system. STEP 7 automatically assigns addresses that you can modify if necessary. The address information is stored in the database of the CP. When the system starts up, the PROFINET IO controller (CP) no transfers this address information to the IO devices (Note: The I/O and diagnostic addresses remain on the IO controller).

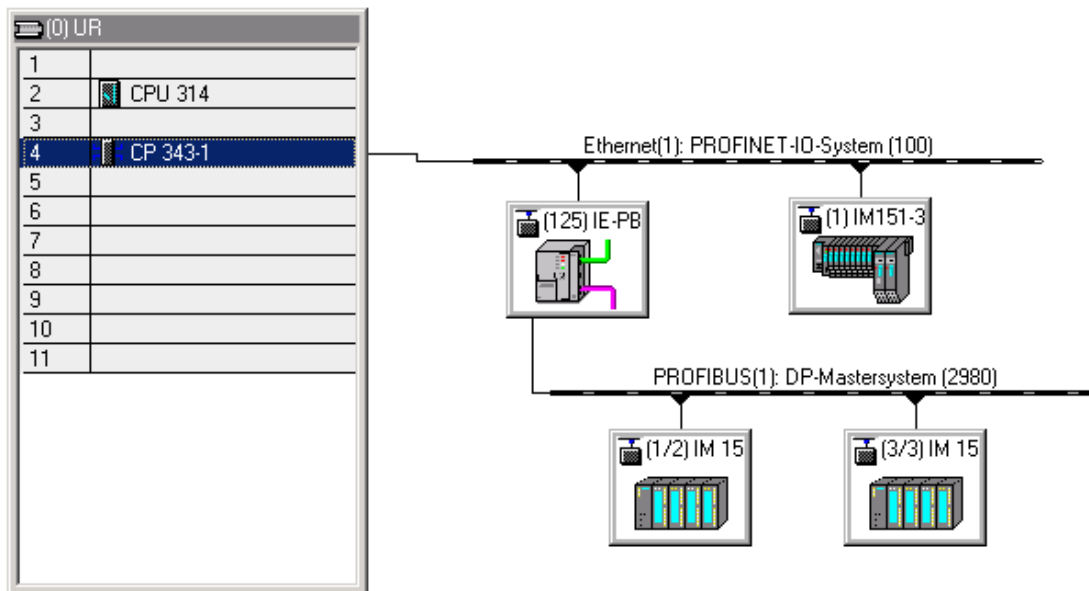

Figure 6-1 Example of the CP 343-1 as PROFINET IO Controller with a PN IO System

How PROFINET IO devices start up with a large operational configuration

When operating the module with a large configuration (up to 32 communication connections and up to 125 PROFINET IO devices), it may take several minutes when the station starts up before all PROFINET IO devices have received configuration data from the PROFINET IO controller. The IE/PB Link operating as PROFINET IO device is particularly affected by this.

To ensure that the CPU does not interrupt the distribution of project engineering data in this situation, the parameter assignment monitoring time must be increased on the CPU.

Possible remedy: Reduce the size of the configuration (for example, distribution on several CPs).

6.2 Operating PROFINET IO Alongside other Services

Reduce the communication share reserved for PROFINET IO when operating alongside other services.

If cyclic data exchange over PROFINET IO is operating at the same time on the same Ethernet subnet, set the parameter "Communication component for PROFINET IO" in the properties dialog of the PROFINET IO system to a value <100%.

Reason:

At the (default) setting 100%, the communication time is reserved primarily for PROFINET IO data exchange. Reducing the communication component for PROFINET IO increases the system-wide update time for PROFINET IO and creates additional time on the CP for processing other communication services.

Sporadically used services

Please remember the following when you use functions that affect the configuration of the mode alongside PROFINET IO (FB55; Primary Setup Tool, STEP 7, NCM Diagnostics, Start-Stop with mode selector) :

These functions can influence operation with PROFINET IO to such an extent that an interruption of the cyclic I/O data exchange of the PROFINET IO devices lasting several seconds may result.

6.3 PROFINET IO Interface in the User Program: FCs

No special FCs are necessary for PROFINET IO operation.

- PNIO_SEND (FC11)
Send process data
- PNIO_RECV (FC12)
Receive process data

These FCs are described in detail in the general part of this manual.

PROFINET IO interface – optimized data transmission after failure of an IO device

On the PROFINET IO interface, you can optimize data transmission by calling FC PNIO_SEND (FC11) with a length (LEN parameter) shorter than the configured total length of the IO data on the PNIO chain.

If you do not follow the recommendation in the manual to transfer the total length of the configured IO data in certain cycles, the following situation may arise:

- Following a device failure and hot restart, an IO device does not output any process data.

Reason:

An IO device on which only part of the output data is updated due to the optimized transfer, only outputs data again following a device failure after the IO controller (here the CP) has transferred the entire output data area!

Further Information on PROFINET IO

When setting up a PROFINET IO system, please read the comprehensive system documentation:

- For PROFIBUS DP to PROFINET IO
Programming Manual Siemens AG
- PROFINET System Description



The documents listed here are also on the Manual Collection CD supplied with every S7-CP.

7 Using the CP 343–1 with PROFINET CBA

To be able to use the CP 343–1 with PROFINET CBA, you must create your user program with STEP 7 and configure the S7–300 station.

You then configure the interconnections between the PROFINET CBA components with SIMATIC iMap.

7.1 CBA Interface in the User Program with FB88

PN_InOut (FB88) and Interface DB

The interface to the user program is the interface DB for PROFINET CBA. The PN_InOut (FB88) function block is responsible for transferring data from the interface DB to the CP and from the CP to the interface DB.

Please refer to the documentation of the blocks in the online help of STEP 7 or in the general part of this manual.

7.2 Preparing for Configuration with STEP 7

Before you can use the CP 343–1 under PROFINET, you must first configure the S7–300 station with STEP 7.

Remember to make the following preparations for the later use of the module with PROFINET:

- Configure the modules for the S7–300 station in HW Config
Create one CP 343–1 (and one only) in an S7–300 station.
- Configuring the Ethernet Interface

When you later configure the Ethernet interface, make the following settings:

- Activate the “IP address is being used” option.
- Disable the “Set MAC address / use ISO protocol” option;

For more detailed information on adopting configuration data in the SIMATIC iMap engineering tool, please refer to the /19/ manual.

7.3 PROFINET Configuration with SIMATIC iMap

Functionality in PROFINET

The CP 343-1 is a PROFINET-compliant device. An S7-300 station equipped with this CP can be interconnected in SIMATIC iMap as a PROFINET component.

You configure the interconnections between the PROFINET components in the plant view of SIMATIC iMap.

Representation in SIMATIC iMap

- Network View in SIMATIC iMap

In the network view of SIMATIC iMap, the following graphic shows how a CP 343-1 in an S7-300 station establishes the connection between DP slaves on PROFIBUS-DP and an S7-300 station on Industrial Ethernet over an IE/PB Link.

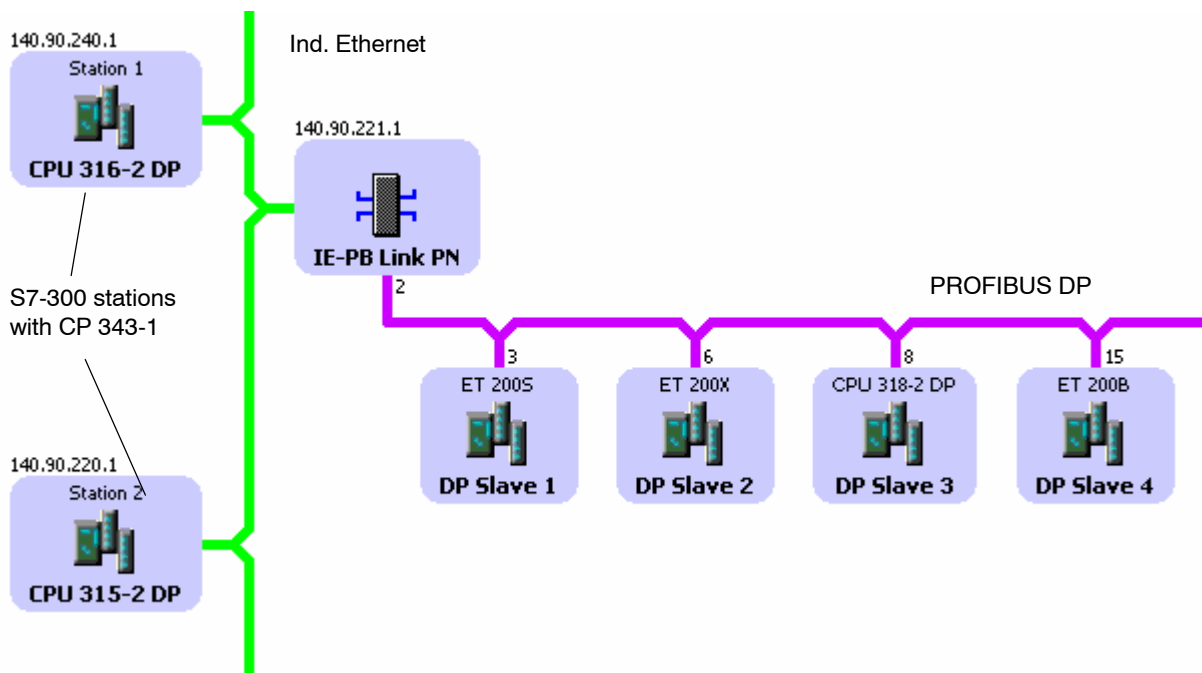

- Plant view in SIMATIC iMap

In the plant view, the interconnection of inputs and outputs over the CP 343-1 is visible.

Here, you can only see the PROFINET components with their interconnections to the process inputs and process outputs.

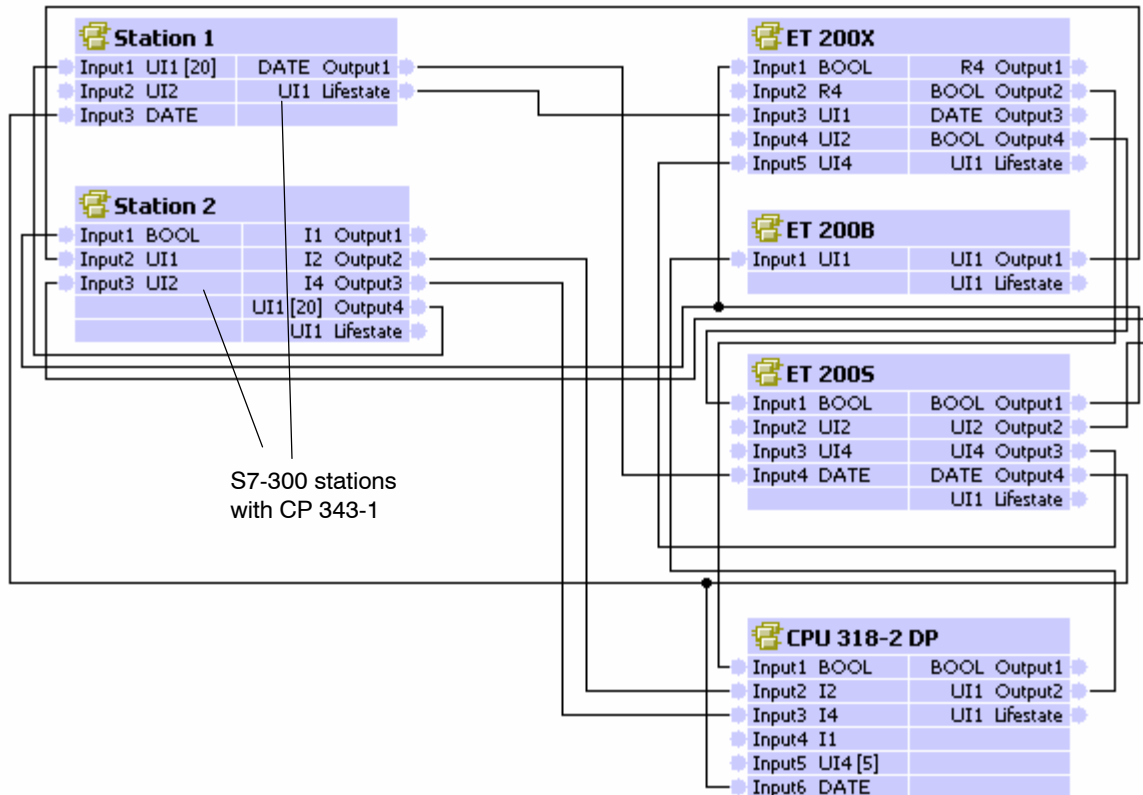

Assigning Addresses and Properties in SIMATIC iMap

Notice

Please remember that you must assign an address for the CP 343-1 once in STEP 7; this is described in the general Part A of the manual:

By selecting the component with the CP 343-1 in the network view, you can set new IP addresses providing the station is a standard component.

You can also enter management information (technological names).

Downloading Configuration Data

Using SIMATIC iMap, you download the configuration data with information about the interconnections of the process inputs and process outputs to the PROFINET components via the Ethernet port.

Vorsicht

If problems occur while downloading interconnections from SIMATIC iMap, for example power down on the target station, it is not always possible to download the interconnections again when the power returns.

If this error occurs, SIMATIC iMap reports the station as being unreachable.

Remedy:

Using the module switch or the PG command, change the CP 343-1 from STOP to RUN to bring the target station back an operational status and to allow the interconnections to be downloaded again from SIMATIC iMap.

Device Diagnostics in SIMATIC iMap

In online view of SIMATIC iMap, you can use diagnostic functions and, for example, read out device and functional information.

Note

For more detailed information on adopting the configuration from STEP 7 and use with PROFINET CBA and the SIMATIC iMap engineering tool, refer to the documentation on SIMATIC iMap.

Service Packs Required for SIMATIC iMap

To operate PROFINET CBA, you require the current service packs of SIMATIC iMap containing the current FB88 V1.5 function block:

SIMATIC iMap V2.0 – Download Service Pack 1:

<http://www4.ad.siemens.de/WW/view/en/19762802>

SIMATIC iMap STEP 7 Addon V2.0 – Download Service Pack 3:

<http://www4.ad.siemens.de/WW/view/en/19850011>

7.4 Using PROFINET CBA Communication and Standard Communication at the same Time

Overview

Parallel operation of PROFINET CBA communication and standard communication with the S7 communication and S5-compatible communication services is possible with the CP.

This mode is important for your application when, for example, you want to implement communication between existing "conventional" SIMATIC devices and PROFINET CBA devices in an existing system.

The special feature is that the configuration of the communication for PROFINET CBA devices is only possible in SIMATIC iMap. Communication with conventional devices, on the other hand, requires that the connections are configured in STEP 7.

Recommended Procedure

Here, we would like to give you a few tips and recommendations.

For communication between a PROFINET CBA device and a conventional device, use S7 or TCP or ISO-on-TCP connections.

Configure the S7 and TCP connections in STEP 7 as follows:

- for S7 communication
 - PROFINET CBA device:
single-ended, passive (partner unspecified)
(no configuration is necessary if the device involved in S7 communication is operated simply as a server).
 - conventional device: single-ended, active
- for S5-compatible communication (TCP / ISO-on-TCP connections)
 - PROFINET CBA device and specified, passive
 - conventional device: unspecified, active

This achieves the following:

- You can specify the connection partner for the conventional devices at any time with STEP 7.
- You can use the PROFINET devices in SIMATIC iMap (in other words connect them) without having to change the connection configuration again in STEP 7; the devices are always ready to send and receive on the configured connections (connection is established by the active partner).

For the PROFINET CBA device, this means the following procedure:

Step	Action / Meaning ¹⁾
1.	First configure unspecified connections in STEP 7 (only with TCP – see above).
2.	Create suitable user programs in STEP 7 to handle communication with the conventional devices.
3.	Then generate the PROFINET CBA components in STEP 7 and enter these in the SIMATIC iMap library.
4.	Interconnect the PROFINET CBA component in SIMATIC iMap.
5.	Download the user program and configuration data to the S7-300 station with STEP 7.
6.	Downloading the interconnection information of the process inputs and process outputs to the PROFINET CBA components over the Ethernet port with SIMATIC iMap.

1) Note: The activities depend on whether a standard or singleton component is involved! The table applies only to singleton components !

8 Compatibility with the Predecessor Product

8.1 Extended Functionality

What's New? Extended functionality compared with 6GK7 343-1EX20-0XE0

The following services and functions are new:

- PROFINET IO Controller
- ISO transport protocol
- Optional exchangeable C-PLUG memory medium
- PROFINET CBA
- FC10 (AG_CNTRL) is supported

8.2 Replacing Older Modules / Replacing Faulty Modules

The 6GK7 343-1EX21-0XE0 described here can be used as a replacement for the following predecessor products:

CP 343-1EX20 (6GK7 343-1EX20-0XE0)

CP 343-1 (6GK7 343-1EX11-0XE0) *)

*) Please note that there is no longer an AUI interface as was available in these device types.

Interface in the User Program



Danger

Please remember that if you use this module as a replacement, you should only use the blocks on the SEND/RECEIVE interface that are permitted for the CP type used! We recommend that you always use the latest block versions.

If you use the module described here as a replacement for one of the modules listed below, make sure that you use the block versions listed after the modules:

- 6GK7 343-1EX10-0XE0
- 6GK7 343-1EX11-0XE0 configured as 6GK7 343-1EX10-0XE0

Block versions:

AG_SEND (V4.2 and higher)

AG_RECV (V4.7 and higher)

AG_LOCK (V4.0 and higher)

AG_UNLOCK (V4.0 and higher)

Notice

For new user programs, please make sure that you always use the latest block versions. You will find information on the latest block version and links to download the current blocks on the Internet:

<http://www4.ad.siemens.de/WW/news/en/8797900>

Module Replacement

When replacing an older module with the module described here, please keep to the steps outlined below:

Table 8-1

Originally configured module	Configuration Steps
6GK7 343-1EX20-0XE0 6GK7 343-1EX11-0XE0 6GK7 343-1EX10-0XE0 *) **)	<p>Case a: Configuration unchanged</p> <p>If you do not have any new requirements compared with the previous CP (numbers of connections etc.), no modification of the project engineering is necessary.</p> <p>When putting the module into operation, note the following difference:</p> <ul style="list-style-type: none"> • If the option of storing the configuration data on the CPU was selected for the CP you are replacing, when the CP starts up, the configuration data will be transferred automatically from the CPU to the CP. • Otherwise, download the configuration data to the CP from your PG/PC again. <p>Case b: Adapted project engineering data</p> <p>If you want to use the extended functionality of the new CP, follow the steps below:</p> <ol style="list-style-type: none"> 1. In STEP 7 / HW Config, replace the previously configured CP 343-1 with the new module from the hardware catalog. 2. Extend the configuration to meet your requirements, for example in the connection configuration. 3. Save, compile and download the configuration data to the CPU or CP again.

Notice

Please read the following notes on the module types listed in Table 8-1:

*)

If you replace a module, you must download the adapted project engineering data to the new module types using STEP 7. The procedure is therefore possible only with "Case b / adapted configuration".

**)

If you replace a module, you must update the communication blocks to the latest version.

9 Further Notes on Operation

9.1 Memory Reset

Available Functions

The CP has a two-level function available for resetting memory:

- Clear / reset

Following this memory reset, the CP retains the preset MAC address and the retentive parameters. The CP is therefore immediately ready for downloads using the IP address.

The retentive parameters include:

- IP address and IP parameters
- LAN settings
- PROFINET CBA interconnections

- Resetting to factory settings

After this memory reset, the CP retains only the factory-set MAC address (as shipped).

Note

If you store the configuration data on the CPU, please read the note below.

Using the functions described here to reset the memory, you do not modify the configuration data on the CPU!

If you subsequently upload the configuration data from the CPU to a PG you will always obtain the configuration data that were previously on the CP (with parameters, connections, IP address). Exception: PROFINET CBA interconnections.

How to Use the Function

You can start the memory reset functions in STEP 7.

- Clear / reset

In STEP 7 / HW Config with **PLC ▶ Clear/Reset**

or

In STEP 7 / NCM Diagnostics with **Operating Mode ▶ Clear/Reset Module**

- Factory defaults reset

In STEP 7 / NCM Diagnostics with **Operating Mode ▶ Reset to Factory Defaults**

Behavior after Memory Reset

The CPU in the S7 station does not recognize that the CP memory was reset. The CP therefore changes to the “stopped with error” state (see Chapter 4).

The configuration data must then be reloaded.

if the configuration data are stored on the CPU, you can start a download with power down/up.

The data in the file system of the C-PLUG (flash area) is retained, the retentive parameters are deleted.

9.2 Working with Fast Ethernet – automatic switchover

How Autosensing and Autonegotiation Work

The CP has a 10/100 Mbps full duplex interface with autosensing and autonegotiation of the network settings. After turning on the CP, these functions work as explained below:

- The CP attempts to detect the transmission rate used by the partner.
- If detection is not possible, no connection is established.
- If detection is possible, the CP attempts to negotiate an optimum duplex mode with the partner.
- If no negotiation is possible, the CP uses the previously detected transmission rate and half duplex.

Time required: 2 seconds

Automatic Setting or Individual Network Settings

As default, the CP is configured for automatic detection. As soon as you define a configuration manually when configuring the CP with STEP 7/HW Config (in the properties dialog of the CP – "Options" tab), the automatic switchover is no longer effective.

Notice

When operating with PROFINET IO, a transmission rate of 100 Mbps full duplex is necessary.

Further Notes:

- 10/100 Mbps network components without “Autonegotiation”
If you use 10/100 Mbps network components that do not support “Autonegotiation”, you may have to set the mode manually during CP configuration using STEP 7 / HW Config (in the properties dialog of the CP). As default, the CP is configured for automatic detection.
- Forcing a specific mode instead of “Autonegotiation”
If your application requires a fixed mode instead of “Autonegotiation”, you will need to match up the partner devices.
- No reaction to Autonegotiation query with manual configuration
Remember that if you configure the CP manually, it will not react to an autonegotiation query! As a result, a connected partner will not be able to set the required mode and communication will not be ideal.
Example:
If, for example, the CP is set to “100 Mbps – full duplex”, a CP connected as partner will set “100 Mbps – half duplex”. Reason: Due to the fixed setting, no autonegotiation response is possible; the connected partner recognizes the 100 Mbps with autosensing but nevertheless remains in half duplex.

STEP 7 / NCM Diagnostics displays the mode

You will find more information about the currently used network settings in NCM diagnostics in the diagnostic object “Industrial Ethernet” in the Section “Network Attachment”.

9.3 SNMP Agent

SNMP (Simple Network Management Protocol)

The CP 343-1 supports data queries over SNMP in version 1.

SNMP is protocol language for managing networks and is easy to handle. To transmit data, SNMP uses the connectionless UDP protocol.

The information on the properties of SNMP-compliant devices is entered in MIB files (MIB = Managed Information Base). For more detailed information on working with MIB files, refer to the documentation of the SNMP client you are using (example of an SNMP client: SNMP OPC Server from SIMATIC NET).

Supported MIB Objects

The CP supports all MIB objects of the standard MIB according to MIB II (RFC 1213).

Exceptions / restrictions:

- Write access is permitted only for the following MIB objects:
sysContact, sysLocation and sysName;
For security reasons, only read access is permitted for all other MIB objects.
- Traps are not supported by the CP.

Access Permissions using Community Name

The CP uses the following community names for assigning permissions:

- For read access: "public"
- for read and write access: "private"

(note the use of lower-case letters!)

9.4 Possible Security Gaps on Standard IT Interfaces / Preventing Illegal Access

With various SIMATIC NET components, such as OSs/ESMs, a wide range of parameter assignment and diagnostic functions (for example, Web servers, network management) are available over open protocols and interfaces. The possibility of unauthorized misuse of these open protocols and interfaces by third parties, for example to manipulate data, cannot be entirely excluded.

When using the functions listed above and these open interfaces and protocols (for example, **SNMP**, HTTP), you should take suitable security measures to prevent unauthorized access to the components and the network particularly from within the WAN/Internet.

Notice

We expressly point out that automation networks must be isolated from the rest of the company network by suitable gateways (for example using tried and tested firewall systems). We do not accept any liability whatsoever, whatever the legal justification, for damage resulting from non-adherence to this notice.

If you have questions on the use of firewall systems and IT security, please contact your local Siemens office or representative. You will find the address in the SIMATIC NET Catalog IK PI or on the Internet at <http://www.siemens.de/simatic-net>

9.5 Influence of MPI on Connections via Industrial Ethernet

If a station on **MPI** is added or removed, for example because a service PG has been connected or disconnected, it is possible that active communication connections on the communications bus are aborted. This has the following effects on the communication connections on Industrial Ethernet:

- All S7 connections are temporarily aborted (does not apply when using the CPU 318 or CPU 317).
- The connections on which a job on the communication bus with a data length > 240 bytes is being processed are aborted temporarily.
- FETCH/WRITE connections are temporarily aborted.

The return values must be handled accordingly on the FC interface in the user program.

9.6 Special Features of IP Configuration

Configured S7 connections cannot be operated if the IP address is assigned over DHCP

Notice

If you obtain the IP address over DHCP, any S7 connections you may have configured will not work. Reason: The configured IP address is replaced by the address obtained over DHCP during operation.

9.7 Reserved Port Numbers

The following local port numbers are reserved; You should not use these for other purposes in the connection configuration.

Table 9-1 Reserved Port Numbers

Protocol	Port number	Service
TCP	20, 21	FTP
TCP	25	SMTP
TCP	80	HTTP
TCP	102	RFC1006
TCP	135	RPC-DCOM

Table 9-1 Reserved Port Numbers, continued

Protocol	Port number	Service
UDP	161	SNMP_REQUEST
UDP	34964	PN IO
UDP	65532	NTP
UDP	65533	NTP
UDP	65534	NTP
UDP	65535	NTP

9.8 Restart after Detection of a Duplicate IP Address in the Network

To save you time-consuming troubleshooting in the network, the CP detects double addressing in the network.

When you eliminate the cause by removing the device with the same IP address or changing its address, you must then restart the CP.

Change the mode selector to STOP and then back to RUN.

9.9 Obtaining the IP Address over DHCP – CP STOP on Expiry of the Lease

If you have configured "Obtain IP address from a DHCP server", when the CP starts up, it is assigned a valid IP address by the DHCP server for a restricted time (period of the lease).

When the lease expires the reaction of the CP is as follows:

The CP changes to STOP and loses the previously assigned IP address if the DHCP server does not assign a new IP address on expiry of the lease. All communication connections are terminated.

9.10 IP Access Protection over the IP Access Control List in PROFINET IO

Please note the following CP response if IP access protection is activated:

- PROFINET IO is not used

If PROFINET IO is not configured, frames from unauthorized partners are rejected (response as with the CP 343-1 GX20).

- PROFINET IO is used

When using PROFINET IO, the authorization check is at a higher program level on the CP. As a result, the CP is visible again for example with a PING command regardless of the configured IP access protection. Connection requests are accepted again and rejected only by the next higher connection layer. As a result, attacks on the CP cause more processor usage.

9.11 Additional Condition Codes in the Diagnostic Buffer

The following condition code can occur in the diagnostic buffer:

- Error code 9B01 H /9B02H:

Cause:

During configuration, there was an overlap of the I/O addresses of the IO devices (diagnostics) with the address of the CP. Change the configured address space so that this overlapping is avoided.

9.12 Setting the CPU Time of Day by the CP

The CP updates the time of day of the CPU at intervals of 1 minute.

If the CP receives time-of-day frames at intervals of 1 second, the CP still only synchronizes the time on the CPU once every minute. This means that the time value on the CPU jumps less often.

9.13 Other information available about the CP

You will find detailed information (FAQs) on using the CP described here on the Internet under the following entry number:

<http://www4.ad.siemens.de/WW/news/en/10806025>

10 How to Load New Firmware

Requirements

Requirements for Downloading

- To download firmware, you require an Industrial Ethernet CP module in the PG/PC (for example, CP 1613) or a normal Ethernet module with the "Softnet" software package.
- The S7-ONLINE interface must be set to the "ISO – Industrial Ethernet" protocol. It is not possible to download using TCP/IP (and therefore not to other networks).

How to Download New Firmware

You download new firmware to a SIMATIC NET CP using the firmware loader shipped with STEP 7 / NCM S7 for Industrial Ethernet.

Depending on the status you initiate for the download, the following applies to the MAC address:

- Status: "Ready for firmware loading" (this mode is active for ten seconds following power up when the mode selector is set to STOP)

Use the factory-set MAC address.

- Starting in other statuses

Use the configured MAC address.

During the download, the RUN LED flashes.

What to do if a Download is Interrupted

Disturbances or collisions on the network can lead to packets being lost. In such cases, this can lead to an interruption of the firmware download. The firmware loader then signals a timeout or negative response from the module being loaded.

Repeat the download as explained below:

Notice

The emergency address 00.AF.FE.AF.FE.00 is no longer used with the module described here.

If you cannot start the download again following an aborted attempt, follow the steps below:

1. Turn off the power supply.
2. Set the mode selector to STOP.
3. Turn on the power again, the STOP LED flashes for approximately 10 seconds ("Ready for firmware loading").
4. Start the firmware load again during this time. Use the factory-set MAC address in this situation.

11 Technical Specifications

Transmission rate	10 Mbps and 100 Mbps Note: To operate with PROFINET IO and PROFINET CBA, the transmission rate of 100 Mbps full duplex is an absolute necessity.
Interfaces Connection to Ethernet	RJ-45 jack
C-PLUG (memory submodule) • Number of write cycles:	approx. 100 000
Power supply	+24 V DC (+/-5%)
Current consumption • from the S7-300 / C7-300 backplane bus • from external 24 V DC	200 mA typical 200 mA maximum
Power loss approx.	5.8 W
Permitted ambient conditions • Operating temperature • Transportation/storage temperature • Relative humidity max. • Altitude	0 °C to +60 °C -40 °C to +70 °C 95% at +25 °C up to 2000 m above sea level
Design • Module format • Dimensions (W x H x D) in mm • Weight approx.	Compact module S7-300; double width 80 x 125 x 120 600 g

All the information in /1/ in the Section "General Technical Specifications" regarding the following topics also applies to the CP 343-1:

- Electromagnetic compatibility
- Transportation and storage conditions
- Mechanical and climatic ambient conditions
- Insulation tests, class of protection and degree of protection