

# SIEMENS

## SIMATIC

### ET 200SP Digital input module F-DI 8x24VDC HF (6ES7136-6BA00-0CA0) Manual



|                                         |          |
|-----------------------------------------|----------|
| <u>Preface</u>                          |          |
| <u>Documentation guide</u>              | <b>1</b> |
| <u>Product overview</u>                 | <b>2</b> |
| <u>Connecting</u>                       | <b>3</b> |
| <u>Parameters/address space</u>         | <b>4</b> |
| <u>Applications of the F-I/O module</u> | <b>5</b> |
| <u>Interrupts/diagnostic messages</u>   | <b>6</b> |
| <u>Technical specifications</u>         | <b>7</b> |
| <u>Response times</u>                   | <b>A</b> |

Translation of original operating instructions

## Legal information

### Warning notice system

This manual contains notices you have to observe in order to ensure your personal safety, as well as to prevent damage to property. The notices referring to your personal safety are highlighted in the manual by a safety alert symbol, notices referring only to property damage have no safety alert symbol. These notices shown below are graded according to the degree of danger.

|                                                                                                        |
|--------------------------------------------------------------------------------------------------------|
|  <b>DANGER</b>        |
| indicates that death or severe personal injury <b>will</b> result if proper precautions are not taken. |
|  <b>WARNING</b>       |
| indicates that death or severe personal injury <b>may</b> result if proper precautions are not taken.  |
|  <b>CAUTION</b>       |
| indicates that minor personal injury can result if proper precautions are not taken.                   |
| <b>NOTICE</b>                                                                                          |
| indicates that property damage can result if proper precautions are not taken.                         |

If more than one degree of danger is present, the warning notice representing the highest degree of danger will be used. A notice warning of injury to persons with a safety alert symbol may also include a warning relating to property damage.

### Qualified Personnel

The product/system described in this documentation may be operated only by **personnel qualified** for the specific task in accordance with the relevant documentation, in particular its warning notices and safety instructions. Qualified personnel are those who, based on their training and experience, are capable of identifying risks and avoiding potential hazards when working with these products/systems.

### Proper use of Siemens products

Note the following:

|                                                                                                                                                                                                                                                                                                                                                                                                                                                                                                                                                      |
|------------------------------------------------------------------------------------------------------------------------------------------------------------------------------------------------------------------------------------------------------------------------------------------------------------------------------------------------------------------------------------------------------------------------------------------------------------------------------------------------------------------------------------------------------|
|  <b>WARNING</b>                                                                                                                                                                                                                                                                                                                                                                                                                                                   |
| Siemens products may only be used for the applications described in the catalog and in the relevant technical documentation. If products and components from other manufacturers are used, these must be recommended or approved by Siemens. Proper transport, storage, installation, assembly, commissioning, operation and maintenance are required to ensure that the products operate safely and without any problems. The permissible ambient conditions must be complied with. The information in the relevant documentation must be observed. |

### Trademarks

All names identified by ® are registered trademarks of Siemens AG. The remaining trademarks in this publication may be trademarks whose use by third parties for their own purposes could violate the rights of the owner.

### Disclaimer of Liability

We have reviewed the contents of this publication to ensure consistency with the hardware and software described. Since variance cannot be precluded entirely, we cannot guarantee full consistency. However, the information in this publication is reviewed regularly and any necessary corrections are included in subsequent editions.

# Preface

## Purpose of the documentation

This device manual complements the system manual ET 200SP distributed I/O system. General functions of the ET 200SP are described in the system manual ET 200SP distributed I/O system (<http://support.automation.siemens.com/WW/view/en/58649293>).

The information provided in this device manual and the system manual enables you to commission the ET 200SP distributed I/O system.

## Conventions

Note the following identified notes:

---

### Note

A note includes important information on the product described in the documentation, on handling the product or on the part of the documentation to which you ought to pay special attention.

---

## Security information

Siemens provides automation and drive products with industrial security functions that support the secure operation of plants or machines. They are an important component in a holistic industrial security concept. With this in mind, our products undergo continuous development. We therefore recommend that you keep yourself informed with respect to our product updates. Please find further information and newsletters on this subject at: (<http://www.siemens.com/industrialsecurity>)

To ensure the secure operation of a plant or machine it is also necessary to take suitable preventive action (e.g. cell protection concept) and to integrate the automation and drive components into a state-of-the-art holistic industrial security concept for the entire plant or machine. Any third-party products that may be in use must also be taken into account. Please find further information at: (<http://support.automation.siemens.com>)



# Table of contents

|          |                                                                        |           |
|----------|------------------------------------------------------------------------|-----------|
|          | <b>Preface</b> .....                                                   | <b>3</b>  |
| <b>1</b> | <b>Documentation guide</b> .....                                       | <b>7</b>  |
| 1.1      | Documentation guide for the F-DI 8x24VDC HF digital input module ..... | 7         |
| <b>2</b> | <b>Product overview</b> .....                                          | <b>9</b>  |
| 2.1      | Properties of the F-DI 8x24VDC HF .....                                | 9         |
| <b>3</b> | <b>Connecting</b> .....                                                | <b>13</b> |
| 3.1      | Terminal assignment.....                                               | 13        |
| 3.2      | Block diagram .....                                                    | 14        |
| <b>4</b> | <b>Parameters/address space</b> .....                                  | <b>15</b> |
| 4.1      | Parameters.....                                                        | 15        |
| 4.2      | Explanation of parameters .....                                        | 18        |
| 4.2.1    | F-parameters.....                                                      | 18        |
| 4.2.2    | Parameters of the sensor supply .....                                  | 18        |
| 4.2.2.1  | Short circuit test .....                                               | 18        |
| 4.2.2.2  | Time for short circuit test.....                                       | 19        |
| 4.2.2.3  | Startup time of sensors after short circuit test .....                 | 19        |
| 4.2.3    | Parameters of the channel pairs .....                                  | 20        |
| 4.2.3.1  | Activated .....                                                        | 20        |
| 4.2.3.2  | Sensor evaluation .....                                                | 20        |
| 4.2.3.3  | Discrepancy behavior .....                                             | 21        |
| 4.2.3.4  | Discrepancy time.....                                                  | 22        |
| 4.2.3.5  | Reintegration after discrepancy error.....                             | 23        |
| 4.2.4    | Parameters of the channels .....                                       | 24        |
| 4.2.4.1  | Sensor supply .....                                                    | 24        |
| 4.2.4.2  | Input delay.....                                                       | 24        |
| 4.2.4.3  | Pulse extension.....                                                   | 25        |
| 4.2.4.4  | Chatter monitoring .....                                               | 25        |
| 4.2.4.5  | Monitoring window .....                                                | 26        |
| 4.3      | Address space .....                                                    | 27        |
| <b>5</b> | <b>Applications of the F-I/O module</b> .....                          | <b>29</b> |
| 5.1      | Applications of the electronic module .....                            | 29        |
| 5.2      | Application 1: Safety mode SIL3/Cat.3/PLd.....                         | 31        |
| 5.3      | Application 2: Safety mode SIL3/Cat.3/PLe.....                         | 34        |
| 5.4      | Application 3: Safety mode SIL3/Cat.4/PLe.....                         | 36        |
| 5.4.1    | Use case 3.1 (SIL3/Cat.4/PLe) .....                                    | 38        |
| 5.4.2    | Use case 3.2 (SIL3/Cat.4/PLe) .....                                    | 40        |

|          |                                             |           |
|----------|---------------------------------------------|-----------|
| <b>6</b> | <b>Interrupts/diagnostic messages</b> ..... | <b>43</b> |
| 6.1      | Status and error display .....              | 43        |
| 6.2      | Interrupts .....                            | 45        |
| 6.3      | Diagnostic messages .....                   | 47        |
| 6.4      | Value status .....                          | 52        |
| <b>7</b> | <b>Technical specifications</b> .....       | <b>53</b> |
| <b>A</b> | <b>Response times</b> .....                 | <b>57</b> |

# Documentation guide

## 1.1 Documentation guide for the F-DI 8x24VDC HF digital input module

### Introduction

The documentation of the SIMATIC products has a modular design and includes topics concerning your automation system.

The complete documentation of the ET 200SP system consists of different modules divided into system manuals, function manuals and manuals.

The STEP 7 (online help) information system supports you in configuring and programming your automation system.

### Overview of documentation for the fail-safe digital input module F-DI 8x24VDC HF

The table below lists additional documents that complement this description of the fail-safe digital input module F-DI 8x24VDC HF and are available on the Internet.

Table 1- 1 Documentation for the fail-safe digital input module F-DI 8x24VDC HF

| Topic                                      | Documentation                                                                                                                                                                                                          | Most important contents                                                                                                                                                                         |
|--------------------------------------------|------------------------------------------------------------------------------------------------------------------------------------------------------------------------------------------------------------------------|-------------------------------------------------------------------------------------------------------------------------------------------------------------------------------------------------|
| Description of the system                  | System manual ET 200SP distributed I/O system<br>( <a href="http://support.automation.siemens.com/WW/view/en/58649293">http://support.automation.siemens.com/WW/view/en/58649293</a> )                                 | <ul style="list-style-type: none"> <li>• Application planning</li> <li>• Installation</li> <li>• Connecting</li> <li>• Commissioning</li> <li>• Approvals</li> <li>• TÜV certificate</li> </ul> |
| BaseUnits                                  | Manual ET 200SP BaseUnits<br>( <a href="http://support.automation.siemens.com/WW/view/en/58532597/133300">http://support.automation.siemens.com/WW/view/en/58532597/133300</a> )                                       | Technical specifications                                                                                                                                                                        |
| Description of the SIMATIC Safety F-system | Programming and operating manual SIMATIC Safety - Configuring and Programming<br>( <a href="http://support.automation.siemens.com/WW/view/en/54110126">http://support.automation.siemens.com/WW/view/en/54110126</a> ) | <ul style="list-style-type: none"> <li>• Configuring</li> <li>• Programming</li> <li>• Approvals</li> </ul>                                                                                     |

### SIMATIC manuals

The latest manuals for SIMATIC products are available on the Internet (<http://www.siemens.com/automation/service&support>) for free download.

## **Functional Safety Services**

Siemens Functional Safety Services support you with a comprehensive package of services from risk assessment to verification all the way to plant commissioning and modernization. We also offer consultation on the use of fail-safe and fault-tolerant SIMATIC S7 automation systems.

You will find more detailed information on the Internet (<http://www.siemens.com/safety-services>).

Please send your questions to us by e-mail (<mailto:safety-services.industry@siemens.com>).



## Product overview

### 2.1 Properties of the F-DI 8x24VDC HF

#### Order number

6ES7136-6BA00-0CA0

#### View of the module

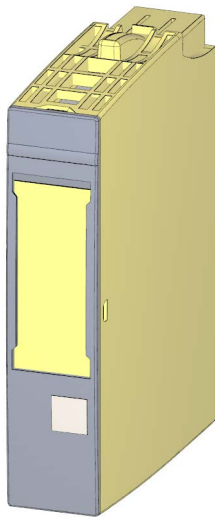

Figure 2-1 View of the F-DI 8x24VDC HF module

## Properties

- Technical properties
  - Fail-safe digital module
  - 8 inputs (SIL3/Cat.4/PLe)
  - 8 outputs for sensor supply
  - Use of various interconnection types (1oo1, 1oo2) is possible
  - Supply voltage L+
  - Sink input (P-reading)
  - Suitable for connection of 3/4-wire sensors according to IEC 61131, type 1
  - Channel-specific assignable input delay 0.4 ms to 20 ms
  - Internal short circuit proof sensor supplies for each input
  - External sensor supply possible
  - Diagnostic display (DIAG red/green LED)
  - Status display for each input (green LED)
  - Error display for each input (red LED)
  - Diagnostics, e.g., short circuit/wire break, channel-specific
  - Diagnostics, e.g., load voltage missing, module-specific
  - Channel-specific or passivation throughout the module
- Supported functions
  - Firmware update
  - I&M identification data
  - PROFIsafe

 **WARNING**

The fail-safe performance characteristics in the technical specifications apply to a proof-test interval of 20 years and a mean time to repair of 100 hours. If a repair within 100 hours is not possible, remove the respective module from the BaseUnit or switch off its supply voltage before 100 hours expires. The module switches off independently after the 100 hours have expired.

Follow the repair procedure described in section Diagnostic messages (Page 47).

## Accessories

The following accessories, which are not included in the product package of the F-module, can be used with the F-module:

- Labeling strips
- Color identification labels
- Reference identification labels
- Shield connection

Additional information on accessories can be found in the ET 200SP Distributed I/O System System Manual (<http://support.automation.siemens.com/WW/view/en/58649293>).



# Connecting

## 3.1 Terminal assignment

### General terminal assignment

Table 3- 1 Terminal assignment for F-DI 8×24VDC HF

| Terminal assignment for F-DI 8×24VDC HF (6ES7136-6BA00-0CA0) |                 |          |                 |                                                                                                                                                      |                       |                                                                                                                    |
|--------------------------------------------------------------|-----------------|----------|-----------------|------------------------------------------------------------------------------------------------------------------------------------------------------|-----------------------|--------------------------------------------------------------------------------------------------------------------|
| Ter-<br>minal                                                | Assign-<br>ment | Terminal | Assign-<br>ment | Description                                                                                                                                          | BaseUnit <sup>1</sup> | Color identification label<br>(terminals 1 to 16)                                                                  |
| 1                                                            | DI <sub>0</sub> | 2        | DI <sub>1</sub> | <ul style="list-style-type: none"> <li>DI<sub>n</sub>: Input signal, channel n</li> <li>VS<sub>n</sub>: Internal sensor supply, channel n</li> </ul> | A0                    | <br>CC01<br>6ES7193-6CP01-2MA0 |
| 3                                                            | DI <sub>2</sub> | 4        | DI <sub>3</sub> |                                                                                                                                                      |                       |                                                                                                                    |
| 5                                                            | DI <sub>4</sub> | 6        | DI <sub>5</sub> |                                                                                                                                                      |                       |                                                                                                                    |
| 7                                                            | DI <sub>6</sub> | 8        | DI <sub>7</sub> |                                                                                                                                                      |                       |                                                                                                                    |
| 9                                                            | VS <sub>0</sub> | 10       | VS <sub>1</sub> |                                                                                                                                                      |                       |                                                                                                                    |
| 11                                                           | VS <sub>2</sub> | 12       | VS <sub>3</sub> |                                                                                                                                                      |                       |                                                                                                                    |
| 13                                                           | VS <sub>4</sub> | 14       | VS <sub>5</sub> |                                                                                                                                                      |                       |                                                                                                                    |
| 15                                                           | VS <sub>6</sub> | 16       | VS <sub>7</sub> |                                                                                                                                                      |                       |                                                                                                                    |
| L+                                                           | DC24V           | M        | M               |                                                                                                                                                      |                       |                                                                                                                    |

<sup>1</sup> Usable BaseUnit types can be identified by the last two digits of their order number. See also *ET 200SP Distributed I/O System* manual

---

#### Note

The first BaseUnit must be a light BaseUnit.

---

#### Note

Make sure that you only use digital modules with BaseUnit type A0 during commissioning.

---

### See also

ET 200SP distributed I/O system

(<http://support.automation.siemens.com/WW/view/en/58649293>)

### 3.2 Block diagram

#### Block diagram

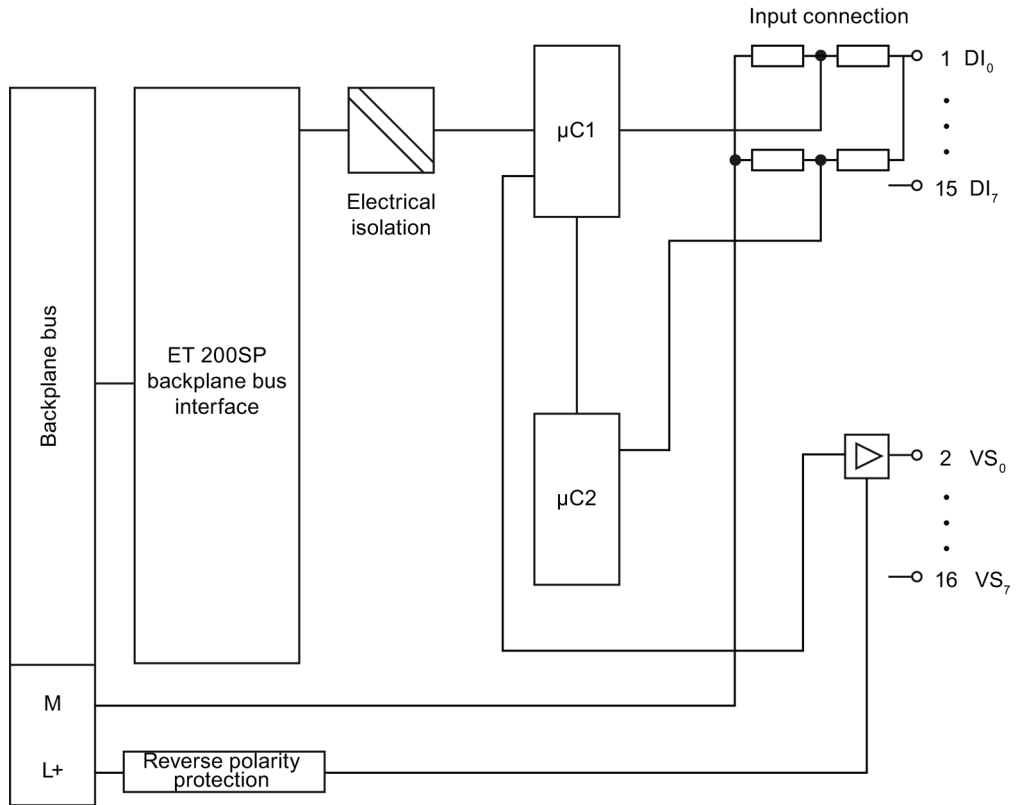

Figure 3-1 Block diagram of the F-DI 8x24VDC HF

## Parameters/address space

### 4.1 Parameters

#### Parameters

|                                                                                                  |
|--------------------------------------------------------------------------------------------------|
|  <b>WARNING</b> |
| Diagnostic functions should be activated or deactivated in accordance with the application.      |

Table 4- 1 Parameters for F-DI 8×24VDC HF

| Parameter                                            | Value range                                                                                              | Parameter reassignment in RUN | Scope   |
|------------------------------------------------------|----------------------------------------------------------------------------------------------------------|-------------------------------|---------|
| <b>F-parameters:</b>                                 |                                                                                                          |                               |         |
| Manual assignment of the F-monitoring time           | <ul style="list-style-type: none"> <li>• disable</li> <li>• enable</li> </ul>                            | no                            | Module  |
| F-monitoring time                                    | 1 to 65535 ms                                                                                            | no                            | Module  |
| F-source address                                     | 1 to 65534                                                                                               | no                            | Module  |
| F-destination address                                | 1 to 65534                                                                                               | no                            | Module  |
| F-parameter signature (without address)              | 0 to 65535                                                                                               | no                            | Module  |
| Behavior after channel faults                        | <ul style="list-style-type: none"> <li>• Passivate entire module</li> <li>• Passivate channel</li> </ul> | no                            | Module  |
| F-I/O DB manual number assignment                    | <ul style="list-style-type: none"> <li>• disable</li> <li>• enable</li> </ul>                            | no                            | Module  |
| F-I/O DB number                                      | —                                                                                                        | no                            | Module  |
| F-I/O DB name                                        | —                                                                                                        | no                            | Module  |
| <b>DI parameters:</b>                                |                                                                                                          |                               |         |
| <b>Sensor supply</b>                                 |                                                                                                          |                               |         |
| Short circuit test                                   | <ul style="list-style-type: none"> <li>• disable</li> <li>• enable</li> </ul>                            | no                            | Channel |
| Time for short circuit test                          | 0.5 ms to 2 s                                                                                            | no                            | Channel |
| Startup time of the sensors after short circuit test | 0.5 ms to 2 s                                                                                            | no                            | Channel |

## 4.1 Parameters

| Parameter                             | Value range                                                                                                                                                                                                                                                                                  | Parameter reassignment in RUN | Scope        |
|---------------------------------------|----------------------------------------------------------------------------------------------------------------------------------------------------------------------------------------------------------------------------------------------------------------------------------------------|-------------------------------|--------------|
| <b>Channel parameters</b>             |                                                                                                                                                                                                                                                                                              |                               |              |
| <b>Channel n, n+4</b>                 |                                                                                                                                                                                                                                                                                              |                               |              |
| Sensor evaluation                     | <ul style="list-style-type: none"> <li>• 1oo1 evaluation</li> <li>• 1oo2 evaluation, equivalent</li> <li>• 1oo2 evaluation, non equivalent</li> </ul>                                                                                                                                        | no                            | Channel pair |
| Discrepancy behavior                  | <ul style="list-style-type: none"> <li>• Supply 0 value</li> <li>• Supply last valid value</li> </ul>                                                                                                                                                                                        | no                            | Channel pair |
| Discrepancy time                      | 5 ms to 30 s                                                                                                                                                                                                                                                                                 | no                            | Channel pair |
| Reintegration after discrepancy error | <ul style="list-style-type: none"> <li>• Test 0-signal not necessary</li> <li>• Test 0-signal necessary</li> </ul>                                                                                                                                                                           | no                            | Channel pair |
| <b>Channel n</b>                      |                                                                                                                                                                                                                                                                                              |                               |              |
| Activated                             | <ul style="list-style-type: none"> <li>• enable</li> <li>• disable</li> </ul>                                                                                                                                                                                                                | no                            | Channel      |
| Sensor supply                         | <ul style="list-style-type: none"> <li>• Sensor supply 0 to 7</li> <li>• External sensor supply</li> </ul>                                                                                                                                                                                   | no                            | Channel      |
| Input delay                           | <ul style="list-style-type: none"> <li>• 0.4 ms</li> <li>• 0.8 ms</li> <li>• 1.6 ms</li> <li>• 3.2 ms</li> <li>• 6.4 ms</li> <li>• 10.0 ms</li> <li>• 12.8 ms</li> <li>• 20 ms</li> </ul> <p>The provided value range depends on the parameter assignment of the employed sensor supply.</p> | no                            | Channel      |
| Pulse extension                       | <ul style="list-style-type: none"> <li>• —</li> <li>• 0.5 s</li> <li>• 1 s</li> <li>• 2 s</li> </ul>                                                                                                                                                                                         | no                            | Channel      |



| Parameter                    | Value range                                                                | Parameter reassignment in RUN | Scope   |
|------------------------------|----------------------------------------------------------------------------|-------------------------------|---------|
| Chatter monitoring activated | <ul style="list-style-type: none"><li>• disable</li><li>• enable</li></ul> | no                            | Channel |
| Number of signal changes     | 2 to 31                                                                    | no                            | Channel |
| Monitoring window            | 0 to 100 s<br>(If 0 s is configured, the monitoring window is 0.5 s long.) | no                            | Channel |

## 4.2 Explanation of parameters

### 4.2.1 F-parameters

#### F-parameters

Information on F-parameters is available in the SIMATIC Safety - Configuring and Programming (<http://support.automation.siemens.com/WW/view/en/54110126>) manual.

### 4.2.2 Parameters of the sensor supply

#### 4.2.2.1 Short circuit test

Here you enable the short-circuit detection for the channels of the F-module for which "Internal sensor supply" is set.

The short-circuit test is only useful if you are using simple switches that do not have their own power supply. For switches with power supply, for example, 3/4-wire proximity switches, a short-circuit test is not possible.

The short-circuit detection switches off the sensor supply briefly. The length of the deactivation period is equivalent to the configured "Time for sensor test".

If a short-circuit is detected, the F-module triggers a diagnostic interrupt and the input is passivated.

The following short-circuits are detected:

- Short-circuit of input to L+
- Short-circuit of the input of another channel when it has a 1 signal
- Short-circuit between the input and sensor supply of another channel
- Short-circuit between the sensor supply and the sensor supply of another channel

If the short-circuit test is disabled, you must make your wiring short-circuit and cross-circuit proof or select a connection type (discrepancy, non-equivalent) which also detect the cross-circuits using discrepancy.

During the execution time (Time for sensor test + Startup time of sensor after sensor test) of the short circuit test, the last valid value of the input before the start of the short circuit test is passed to the F-CPU. The activation of the short-circuit test thus affects the response time of the respective channel or channel pair.

#### 4.2.2.2 Time for short circuit test

##### Function

When the short-circuit test is enabled, the corresponding sensor supply is switched off for the configured time. If the module does not detect a "0" signal at the input within the assigned time, a diagnostic message is generated.

When assigning parameters, note that

- If the channel is passivated, this may be due to too high capacitance between sensor supply and input. This consists of the capacitance per unit length of the cable and the capacitance of the employed sensor. If the connected capacitance does not discharge within the assigned time, you need to adjust the "Time for sensor test" parameter.
- The values available for the input delay depend on the "Ramp-up time of the sensor after short-circuit test" and the "Time for short-circuit test" of the configured sensor supply.

#### 4.2.2.3 Startup time of sensors after short circuit test

##### Function

In addition to the off time ("Time for sensor test"), a startup time must be specified for performing the short circuit test. You use this parameter to notify the module how long the utilized sensor needs to start up after connecting the sensor supply. This prevents an undefined input state due to transient reactions in the sensor.

When assigning parameters, note that

- This parameter must be greater than the transient recovery time of the employed sensor.
- Because the assigned time affects the response time of the module, we recommend that you set the time as short as possible but long enough so that your sensor can settle safely.
- The values available for the input delay depend on the "Ramp-up time of the sensor after short-circuit test" and the "Time for short-circuit test" of the configured sensor supply.

##### Requirement

The short circuit test is enabled.

### 4.2.3 Parameters of the channel pairs

#### 4.2.3.1 Activated

You hereby enable the corresponding channel for signal processing in the safety program.

#### 4.2.3.2 Sensor evaluation

##### Overview

Select the type of sensor evaluation with the "Evaluation of the sensors" parameter:

- 1oo1 evaluation
- 1oo2 evaluation, equivalent
- 1oo2 evaluation, non-equivalent

##### 1oo1 evaluation

The sensor is available once for 1oo1 evaluation.

##### 1oo2 evaluation, equivalent/non-equivalent

With a 1oo2 evaluation equivalent/non-equivalent, two input channels are occupied by:

- One two-channel sensor
- Two single-channel sensors
- One non-equivalent sensor

The input signals are compared internally for equivalence or non equivalence.

Note that in 1oo2 evaluation, two channels are combined into a channel pair. The number of available process signals of the F-module is reduced accordingly.

##### Discrepancy analysis

When using a two-channel sensor or two single-channel sensors which measure the same process variable, the sensors interact with a slight time delay due to the limited precision of their arrangement.

The discrepancy analysis for equivalence/non equivalence is used for fail-safe applications to prevent errors from time differences between two signals for the same function. The discrepancy analysis is initiated when different levels are detected in two associated input signals (when testing for non equivalence: the same levels). A check is made to determine whether the difference in levels (when testing for non equivalence: the same levels) has disappeared after an assignable time period, the so-called discrepancy time. If not, this means that a discrepancy error exists.

### 4.2.3.3 Discrepancy behavior

#### Function

For the "Discrepancy behavior", you assign the value that is supplied to the safety program in the F-CPU during a discrepancy between two relevant input channels, which means while discrepancy time is running. You assign the discrepancy behavior as follows:

- "Supply last valid value"
- "Supply value 0"

#### Requirements

You have assigned the following:

- "Evaluation of the sensors": "1oo2 evaluation, equivalent" or "1oo2 evaluation, non-equivalent"

#### "Supply last valid value"

The most recent valid value (old value) before the discrepancy occurred is made available to the safety program in the F-CPU as soon as a discrepancy is detected between the signals of the two affected input channels. This value is supplied until the discrepancy disappears or the discrepancy time expires and a discrepancy error is detected. The sensor-actuator response time is correspondingly increased by this time.

This means the discrepancy time of connected sensors with 1oo2 evaluation must be adjusted to fast response times. It makes no sense, for example, if connected sensors with a discrepancy time of 500 ms trigger a time-critical shutdown.. In the worst-case scenario, the sensor-actuator response time is extended by an amount approximately equal to the discrepancy time:

- For this reason, position the sensors in the process in such a way as to **minimize discrepancy**.
- Then select the **shortest possible** discrepancy time which is also sufficient to compensate for faulty triggering of discrepancy errors.

#### "Supply value 0"

As soon as a discrepancy between the signals of the two relevant input channels is detected, the value "0" is made available to the safety program in the F-CPU.

If you have set "Supply value 0", the sensor-actuator response time is not affected by the discrepancy time.

#### 4.2.3.4 Discrepancy time

##### Function

You can set the discrepancy time for each channel pair.

##### Requirements

You have assigned the following:

- "Evaluation of the sensors": "1oo2 evaluation, equivalent" or "1oo2 evaluation, non-equivalent"

In most cases, a discrepancy time is started, but does not fully expire because the signal differences are cleared within a short time.

Set the discrepancy time high enough that in the error-free case the difference between the two signals (when testing for non equivalence: the same levels) has always disappeared before the discrepancy time has expired.

##### Behavior while discrepancy time is running

While the programmed discrepancy time is running internally on the module, either the **last valid value** or "**0**" is returned to the safety program on the F-CPU by the input channels involved, depending on the parameter settings for the behavior at discrepancy.

##### Behavior after expiration of the discrepancy time

If no agreement (when checking for non equivalence: inequality) of the input signals exists once the assigned discrepancy time expires, for example, due to a break in a sensor wire, a discrepancy error is detected and the "Discrepancy error" diagnostic message containing information on which channels are faulty is generated.

### 4.2.3.5 Reintegration after discrepancy error

#### Function

This parameter specifies the criteria for when a discrepancy error is regarded as corrected, thus enabling reintegration of the relevant input channels. The following parameter assignment options are available:

- "Test 0-signal necessary"
- "Test 0-signal not necessary"

#### Requirements

You have assigned the following:

- "Sensor evaluation": "1oo2 evaluation, equivalent" or "1oo2 evaluation, non equivalent"

#### "Test 0-signal necessary"

If you have assigned "Test 0-signal necessary", a discrepancy error is not regarded as corrected until a 0-signal is present at both of the relevant input channels.

If you are using non equivalent sensors, which means you have set "Sensor evaluation" to "1oo2 evaluation, non equivalent", a 0-signal must be present again at the low order channel of the channel pair.

#### "Test 0-signal not necessary"

If you have assigned "Test 0-Signal not necessary", a discrepancy error is regarded as corrected when a discrepancy no longer exists at both of the relevant input channels.

## 4.2.4 Parameters of the channels

### 4.2.4.1 Sensor supply

Here you select one of the internal sensor supplies  $VS_0$  to  $VS_n$  or an external sensor supply. The selection of an internal sensor supply is required for using the short circuit test.

#### See also

Time for short circuit test (Page 19)

### 4.2.4.2 Input delay

#### Function

To suppress stray interference, you can set an input delay for the entire channel or channel pair.

Interference pulses whose pulse time is less than the set input delay (in ms) are suppressed. Suppressed interference pulses are invisible in the PII.

A high input delay suppresses longer interference pulses, but results in a longer response time.

The values available for the input delay depend on the "Startup time of sensors after short circuit test" and the "Time for short circuit test" of the configured sensor supply.

---

#### Note

Due to the physical properties, there is a possibility of crosstalk between signals in the case of long, unshielded signal lines (see section "Electromagnetic compatibility" in the system manual ET 200SP distributed I/O system (<http://support.automation.siemens.com/WW/view/en/58649293>)).

Adapt the input delay or use shielded signal lines in order to prevent possible passivation of the fail-safe digital inputs and switch-off of the sensor supply.

---

#### See also

Technical specifications (Page 53)

Response times (Page 57)



#### **4.2.4.3 Pulse extension**

##### **Function**

Pulse extension is a function to change a digital input signal. A pulse on a digital input is extended to at least the assigned length. If the input pulse is already longer than the assigned length, the pulse is not changed.

The fail-safe electronic module only lengthens pulses with the value "0" because the basis of the safety concept is that there is a safe state for all process variables. For digital F-I/O, this is the value "0", which applies to sensors as well as to actuators.

With 1oo2 evaluation, the result of the evaluation of both sensors is used for the pulse extension.

#### **4.2.4.4 Chatter monitoring**

##### **Function**

Chatter monitoring is a process control function for digital input signals. It detects and reports unusual signal sequences in the process with 1oo1 evaluation, for example, an input signal fluctuating between "0" and "1" too frequently. The occurrence of such signal characteristics is an indication of faulty sensors or process control instability.

##### **Recognizing unusual signal patterns**

An assigned monitoring window is available for each input channel. The monitoring window starts with the first signal change of the input signal. If the input signal changes within the monitoring window at least as often as the assigned "Number of signal changes", a chatter error is detected. If no chatter error is detected within the monitoring window, the next signal change restarts the monitoring window.

If a chatter error is detected, a diagnostic is signaled. If the chatter error does not occur for the monitoring window for three times the configured period, the diagnostic is reset.

### Principle

The figure below shows the principle of chatter monitoring as a graphic.

Parameter for number of signal changes = 8

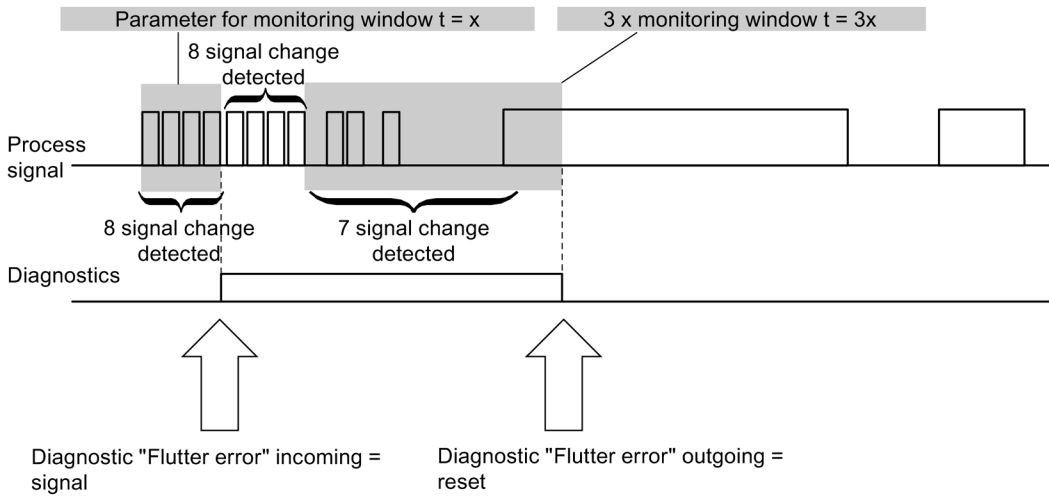

Figure 4-1 Figure chatter monitoring

### Number of signal changes

Sets the number of signal changes after which a chatter error should be reported.

#### 4.2.4.5 Monitoring window

Sets the time for the monitoring window of flutter monitoring.

You can set times of 1 s to 100 s in whole seconds for the monitoring window.

You can configure a monitoring window of 0.5 s when you set 0 s.

## 4.3 Address space

### Address assignment of the digital input module F-DI 8×24VDC HF

The digital input module F-DI 8×24VDC HF occupies the following address areas in the F-CPU:

Table 4- 2 Address assignment in the F-CPU

| Occupied bytes in the F-CPU: |                 |
|------------------------------|-----------------|
| In input range               | In output range |
| x + 0 to x + 5               | x + 0 to x + 3  |

x = Module start address

### Address assignment of the user data and the value status of digital input module F-DI 8×24VDC HF

The user data occupy the following addresses in the F-CPU out of all the assigned addresses of the digital input module F-DI 8×24VDC HF:

Table 4- 3 Address assignment through user data

| Byte in the F-CPU | Assigned bits in F-CPU per F-module: |                                  |                                  |                                  |                                  |                                  |                                  |                                  |
|-------------------|--------------------------------------|----------------------------------|----------------------------------|----------------------------------|----------------------------------|----------------------------------|----------------------------------|----------------------------------|
|                   | 7                                    | 6                                | 5                                | 4                                | 3                                | 2                                | 1                                | 0                                |
| x + 0             | DI <sub>7</sub>                      | DI <sub>6</sub>                  | DI <sub>5</sub>                  | DI <sub>4</sub>                  | DI <sub>3</sub>                  | DI <sub>2</sub>                  | DI <sub>1</sub>                  | DI <sub>0</sub>                  |
| x + 1             | Value status for DI <sub>7</sub>     | Value status for DI <sub>6</sub> | Value status for DI <sub>5</sub> | Value status for DI <sub>4</sub> | Value status for DI <sub>3</sub> | Value status for DI <sub>2</sub> | Value status for DI <sub>1</sub> | Value status for DI <sub>0</sub> |

x = Module start address

#### Note

You may only access the addresses occupied by user data and value status.

The other address areas occupied by the F-modules are assigned for functions including safety-related communication between the F-modules and F-CPU in accordance with PROFIsafe.

1oo2 evaluation of the sensors combines the two channels. With 1oo2 evaluation of the sensors you may only access the low order channel in the safety program.

### **Additional information**

For detailed information about F-I/O access, refer to the SIMATIC Safety – Configuring and Programming (<http://support.automation.siemens.com/WW/view/en/54110126>) manual.

### **See also**

Value status (Page 52)

## Applications of the F-I/O module

### 5.1 Applications of the electronic module

#### Selecting the application

The diagram below supports you in selecting the application that suits your fail-safe requirements. In the following sections, you will learn how to wire the F-module, the specific parameters you must assign in STEP 7 Safety and the errors that are detected.

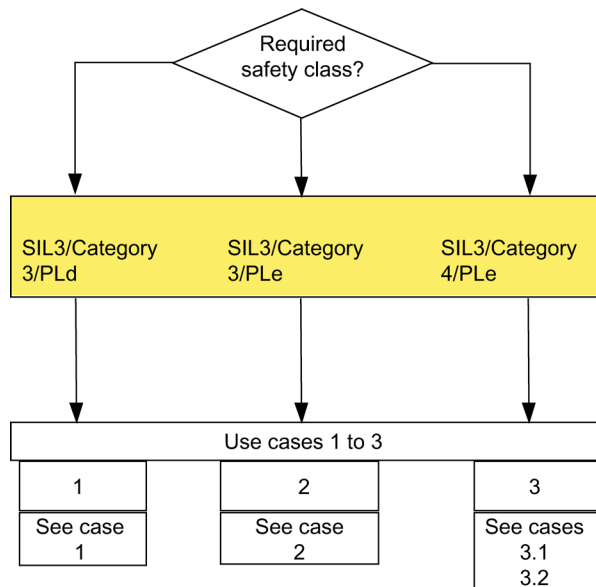



Figure 5-1 Selecting the application – digital input module F-DI 8x24VDC HF

|                                                                                                                                                                                                                                                                                                               |
|---------------------------------------------------------------------------------------------------------------------------------------------------------------------------------------------------------------------------------------------------------------------------------------------------------------|
|  <b>WARNING</b>                                                                                                                                                                                                            |
| The achievable safety class depends on the quality of the sensor and the duration of the proof-test interval in accordance with IEC 61508:2010. If the quality of the sensor is lower than the quality required by the safety class, redundant sensors connected via two channels must be used and evaluated. |

### Conditions for achieving SIL/Cat./PL

The table below lists the conditions which have to be met for achieving at least the corresponding safety requirements.

Table 5- 1 Conditions for achieving SIL/Cat./PL

| Application | Sensor evaluation   | Sensor supply                              | Achievable SIL/Cat./PL |
|-------------|---------------------|--------------------------------------------|------------------------|
| 1           | 1oo1                | Any                                        | 3 / 3 / d              |
| 2           | 1oo2 equivalent     | Internal, without short circuit test       | 3 / 3 / e              |
|             |                     | External                                   |                        |
| 3.1         | 1oo2 equivalent     | Internal, with short circuit test          | 3 / 4 / e              |
| 3.2         | 1oo2 non-equivalent | External/internal, with short circuit test |                        |

#### Note

You can operate the various inputs of an F-DI module simultaneously in SIL3/Cat.3/PLd and in SIL3/Cat.3 or Cat.4/PLe. You only have to interconnect the inputs and assign parameters as described in the following sections.

### Sensor requirements

Information on safety-related use of sensors is available in the section Requirements for sensors and actuators for fail-safe modules in the ET 200SP distributed I/O system (<http://support.automation.siemens.com/WW/view/en/58649293>) system manual.

## 5.2 Application 1: Safety mode SIL3/Cat.3/PLd

### Wiring

The wiring is carried out on the matching BaseUnit (Page 13).

### Sensor supply

The sensor supply can be powered internally or externally.

### Wiring diagram – connecting one sensor via one channel

One sensor is connected via one channel (1oo1 evaluation) for each process signal. Any sensor supply of the module can be assigned to each input.

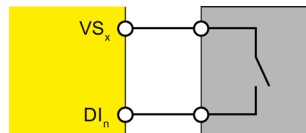

Figure 5-2 One sensor connected via one channel, internal sensor supply

You can also supply the sensor by means of an external sensor supply.

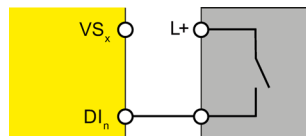

Figure 5-3 One sensor connected via one channel, external sensor supply

### WARNING

To achieve SIL3/Cat.3/PLd using this wiring, you must use a qualified sensor.

### Parameter assignment

Assign the following parameters for the corresponding channel:

Table 5- 2 Parameter assignment

| Parameter          | Channel with internal sensor supply                                                                | Channel with external sensor supply |
|--------------------|----------------------------------------------------------------------------------------------------|-------------------------------------|
| Sensor evaluation  | 1oo1 evaluation                                                                                    |                                     |
| Short circuit test | <ul style="list-style-type: none"><li>• disable</li><li>• enable</li></ul>                         | disable                             |
| Sensor supply      | <ul style="list-style-type: none"><li>• Sensor supply n</li><li>• External sensor supply</li></ul> | External sensor supply*             |

\*) Otherwise a diagnostic message will be generated when short circuit test is activated.



## Fault detection

The following table presents fault detection according to the sensor supply and the parameter assignment for the short circuit test:

Table 5- 3 Fault detection

| Fault                                                                                                                                                              | Fault detection                                         |                                                           |                        |
|--------------------------------------------------------------------------------------------------------------------------------------------------------------------|---------------------------------------------------------|-----------------------------------------------------------|------------------------|
|                                                                                                                                                                    | Internal sensor supply and short circuit test activated | Internal sensor supply and short circuit test deactivated | External sensor supply |
| Short circuit of the input with other channels or other sensor supplies (short circuit with other channels is detected only if they use a different sensor supply) | yes*                                                    | no                                                        | no                     |
| Short circuit with L+ to DI <sub>n</sub>                                                                                                                           | yes                                                     | no                                                        | no                     |
| Short circuit with M to DI <sub>n</sub>                                                                                                                            | yes*                                                    | yes*                                                      | no                     |
| Discrepancy error                                                                                                                                                  | —                                                       | —                                                         | —                      |
| Short circuit with L+ to VS <sub>n</sub>                                                                                                                           | yes                                                     | no                                                        | —                      |
| Short circuit with M to VS <sub>n</sub> or defective                                                                                                               | yes                                                     | yes                                                       | —                      |

\*) Fault detection only if signals are corrupted. That is, the read signal differs from the sensor signal. If there is no signal corruption with respect to the sensor signal, fault detection is not possible and is not required from a safety standpoint.

|                                                                                                                                                                     |
|---------------------------------------------------------------------------------------------------------------------------------------------------------------------|
|  <b>WARNING</b>                                                                  |
| If the short circuit test is not activated or the sensor supply to digital inputs is set to "External sensor supply", the cable must be routed short circuit proof. |

## 5.3 Application 2: Safety mode SIL3/Cat.3/PLe

### Assigning inputs to each other

The digital input module F-DI 8x24VDC HF has 8 fail-safe inputs, DI<sub>0</sub> to DI<sub>7</sub> (SIL3). You can combine two of these inputs each to one input.

You can combine the following inputs:

- DI<sub>0</sub> and DI<sub>4</sub>
- DI<sub>1</sub> and DI<sub>5</sub>
- DI<sub>2</sub> and DI<sub>6</sub>
- DI<sub>3</sub> and DI<sub>7</sub>

The process signals are provided by channels DI<sub>0</sub>, DI<sub>1</sub>, DI<sub>2</sub> and DI<sub>3</sub>.

### Wiring

The wiring is carried out on the matching BaseUnit (Page 13).

### Sensor supply

The sensor supply can be powered internally or externally.

### Wiring diagram – connecting a two-channel sensor equivalent

A two-channel sensor is connected equivalent to two inputs of the F-module for each process signal (1oo2 evaluation).

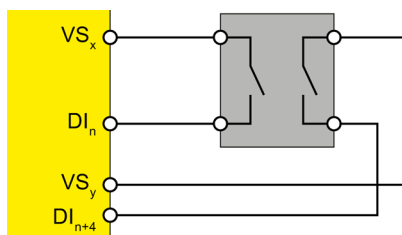

Figure 5-4 One two-channel sensor connected via two channels, internal sensor supply

You can also supply the sensor by means of an external sensor supply.

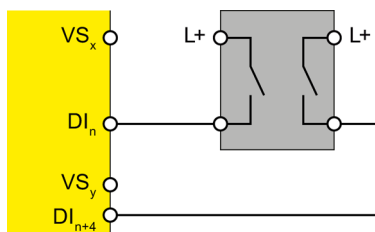

Figure 5-5 One two-channel sensor connected via two channels, external sensor supply

**Wiring diagram – connecting two single-channel sensors via two channels**

Two single-channel sensors that capture the same process value are connected to two inputs of the F-module for each process signal (1oo2 evaluation).

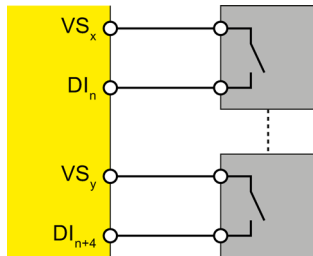

Figure 5-6 Two single-channel sensors connected via two channels, internal sensor supply

You can also supply the sensors by means of an external sensor supply.

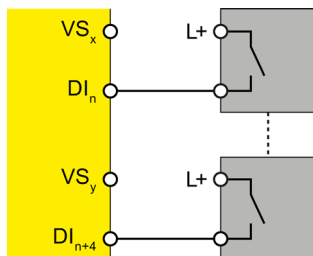

Figure 5-7 Two single-channel sensors connected via two channels, external sensor supply

|                                                                               |                |
|-------------------------------------------------------------------------------|----------------|
|                                                                               | <b>WARNING</b> |
| To achieve SIL3/Cat.3/PLe using this wiring, you must use a qualified sensor. |                |

**Parameter assignment**

Assign the following parameters for the corresponding channel:

Table 5- 4 Parameter assignment

| Parameter          | Channel with internal sensor supply                                           | Channel with external sensor supply |
|--------------------|-------------------------------------------------------------------------------|-------------------------------------|
| Sensor evaluation  | 1oo2 evaluation, equivalent                                                   |                                     |
| Short circuit test | <ul style="list-style-type: none"> <li>• disable</li> <li>• enable</li> </ul> | disable                             |

## Fault detection

The following table presents fault detection according to the sensor supply and the parameter assignment for the short circuit test:

Table 5- 5 Fault detection

| Fault                                                      | Fault detection                                           |                        |
|------------------------------------------------------------|-----------------------------------------------------------|------------------------|
|                                                            | Internal sensor supply and short circuit test deactivated | External sensor supply |
| Short circuit within the channel pair                      | no                                                        | no                     |
| Short circuit with other channels or other sensor supplies | yes*                                                      | yes                    |
| Short circuit with L+ to DI <sub>n</sub>                   | yes*                                                      | yes*                   |
| Short circuit with M to DI <sub>n</sub>                    | yes*                                                      | yes*                   |
| Discrepancy error                                          | yes                                                       | yes                    |
| Short circuit with L+ to VS <sub>n</sub>                   | no                                                        | no                     |
| Short circuit with M to VS <sub>n</sub> or defective       | yes                                                       | —                      |

\*) Fault detection only if signals are corrupted. That is, the read signal differs from the sensor signal (discrepancy error). If there is no signal corruption with respect to the sensor signal, fault detection is not possible and is not required from a safety standpoint.

## 5.4 Application 3: Safety mode SIL3/Cat.4/PLe

### Assigning inputs to each other

The digital input module F-DI 8x24VDC HF has 8 fail-safe inputs, DI<sub>0</sub> to DI<sub>7</sub> (SIL3). You can combine two of these inputs each to one input.

You can combine the following inputs:

- DI<sub>0</sub> with DI<sub>4</sub>
- DI<sub>1</sub> with DI<sub>5</sub>
- DI<sub>2</sub> with DI<sub>6</sub>
- DI<sub>3</sub> with DI<sub>7</sub>

The process signals are provided by channels DI<sub>0</sub>, DI<sub>1</sub>, DI<sub>2</sub> and DI<sub>3</sub>.

### Wiring

The wiring is carried out on the matching BaseUnit (Page 13).

## **Sensor supply**

The sensor must be supplied internally by at least one channel for application 3.1.

The sensor can be supplied internally or externally for application 3.2.

## **Requirements for applications in machine protection with Cat.4**

Both conditions must be met for applications in machine protection with Cat.4:

- The wiring between sensors and automation system and between automation system and actuators must be designed to state-of-the-art engineering and standards to prevent short circuits.
- The actuators must be wired as seen in sections Use case 3.1 (SIL3/Cat.4/PLe) (Page 38) or Use case 3.2 (SIL3/Cat.4/PLe) (Page 40). You only need to detect **one** short circuit because two faults are required to generate it. This means both signal cables in short circuit have an isolation fault. A multiple short circuit analysis is not required.

Procedures for locating all short circuits are also permitted if single short circuits are not located. One of the two conditions must be met for this purpose:

- Short circuits may not corrupt the read signals compared to the sensor signals.
- Short circuits cause a corruption of the read signals compared to sensor signals in the direction that ensures safety.

### 5.4.1 Use case 3.1 (SIL3/Cat.4/PLe)

#### Wiring diagram – connecting a two-channel sensor via two channels

A two-channel sensor is connected to two inputs of the F-module for each process signal (1oo2 evaluation).

Supply the sensors from two different sensor supplies.

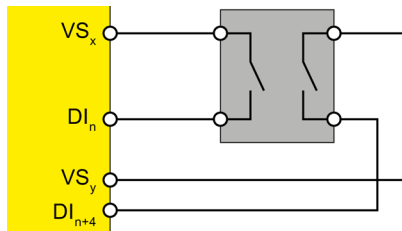

Figure 5-8 One two-channel sensor connected via two channels, internal sensor supply

You can also connect two single-channel sensors via two channels. In this case, the same process variable is acquired with two mechanically separate sensors.

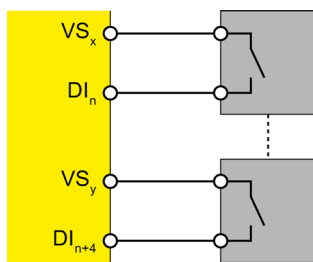

Figure 5-9 Two single-channel sensors connected via two channels, internal sensor supply

|                                                                                        |                |
|----------------------------------------------------------------------------------------|----------------|
|                                                                                        | <b>WARNING</b> |
| To achieve SIL3/Cat.4/PLe using this wiring, you must use a suitably qualified sensor. |                |

#### Parameter assignment

Assign the following parameters for the corresponding channel:

Table 5-6 Parameter assignment

| Parameter          |                                                                                                                              |
|--------------------|------------------------------------------------------------------------------------------------------------------------------|
| Sensor evaluation  | 1oo2 evaluation, equivalent                                                                                                  |
| Short circuit test | enable                                                                                                                       |
| Sensor supply      | <ul style="list-style-type: none"> <li>• Sensor supply n (internally by at least one channel)</li> <li>• External</li> </ul> |

## Fault detection

The following table presents fault detection according to the sensor supply and the parameter assignment for the short circuit test:

Table 5- 7 Fault detection

| Fault                                                                               | Fault detection                                                |
|-------------------------------------------------------------------------------------|----------------------------------------------------------------|
| Short circuit within the channel pair, with other channels or other sensor supplies | yes*                                                           |
| Short circuit with L+ to DI <sub>n</sub>                                            | yes* / yes (for channel whose short circuit test is activated) |
| Short circuit with M to DI <sub>n</sub>                                             | yes*                                                           |
| Discrepancy error                                                                   | yes                                                            |
| Short circuit with L+ to VS <sub>n</sub>                                            | yes                                                            |
| Short circuit with M to VS <sub>n</sub> or defective                                | yes                                                            |

\*) Fault detection only if signals are corrupted. That is, the read signal differs from the sensor signal (discrepancy error). If there is no signal corruption with respect to the sensor signal, fault detection is not possible and is not required from a safety standpoint.

### 5.4.2 Use case 3.2 (SIL3/Cat.4/PLe)

#### Wiring diagram – connecting a nonequivalent sensor

A nonequivalent sensor is connected to two inputs of the F-module for each process signal (1oo2 evaluation, non equivalent).

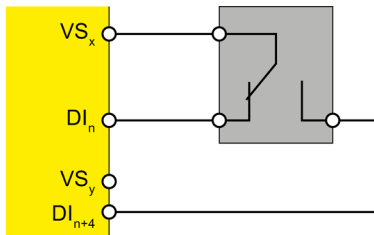

Figure 5-10 Nonequivalent sensor connected, internal sensor supply

You can also supply the sensor by means of an external sensor supply.

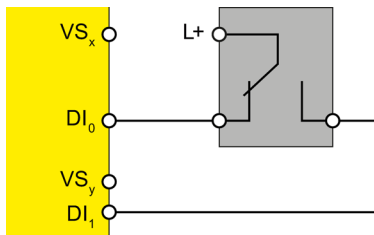



Figure 5-11 Nonequivalent sensor connected, external sensor supply

|                                                                                                    |
|----------------------------------------------------------------------------------------------------|
|  <b>WARNING</b> |
| To achieve SIL3/Cat.4/PLe using this wiring, you must use a suitably qualified sensor.             |



### Wiring diagram – connecting two single-channel sensors nonequivalent

Two single-channel sensors are connected nonequivalent to two inputs of the F-module for each process signal (1oo2 evaluation).

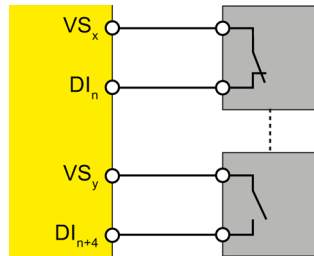

Figure 5-12 Two single-channel sensors connected nonequivalent, internal sensor supply

You can also supply the sensors by means of an external sensor supply.

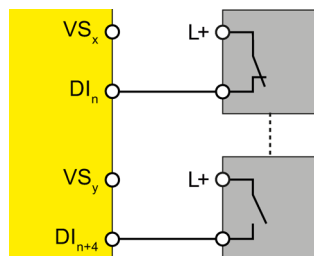

Figure 5-13 Two single-channel sensors connected nonequivalent, external sensor supply

|                                                                                        |                |
|----------------------------------------------------------------------------------------|----------------|
|                                                                                        | <b>WARNING</b> |
| To achieve SIL3/Cat.4/PLe using this wiring, you must use a suitably qualified sensor. |                |

### Parameter assignment

Assign the following parameters for the corresponding channel:

Table 5- 8 Parameter assignment

| Parameter          |                                                                                                       |
|--------------------|-------------------------------------------------------------------------------------------------------|
| Sensor evaluation  | 1oo2 evaluation, non equivalent                                                                       |
| Short circuit test | <ul style="list-style-type: none"> <li>• disable</li> <li>• enable</li> </ul>                         |
| Sensor supply      | <ul style="list-style-type: none"> <li>• Sensor supply n</li> <li>• External sensor supply</li> </ul> |

### Fault detection

The following table presents fault detection according to the sensor supply and the parameter assignment for the short circuit test:

Table 5- 9 Fault detection

| Fault                                                                               | Fault detection                                                |
|-------------------------------------------------------------------------------------|----------------------------------------------------------------|
| Short circuit within the channel pair, with other channels or other sensor supplies | yes                                                            |
| Short circuit with L+ to DI <sub>n</sub>                                            | yes* / yes (for channel whose short circuit test is activated) |
| Short circuit with M to DI <sub>n</sub>                                             | yes*                                                           |
| Discrepancy error                                                                   | yes                                                            |
| Short circuit with L+ to VS <sub>n</sub>                                            | yes, if used                                                   |
| Short circuit with M to VS <sub>n</sub> or defective                                | yes, if sensor supply is activated                             |

\*) Fault detection only if signals are corrupted. That is, the read signal differs from the sensor signal (discrepancy error). If there is no signal corruption with respect to the sensor signal, fault detection is not possible and is not required from a safety standpoint.

## Interrupts/diagnostic messages

### 6.1 Status and error display

#### LED display

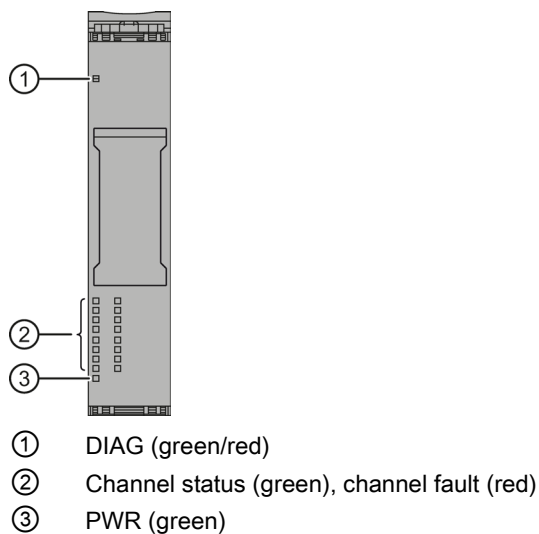

Figure 6-1 LED display

#### Meaning of the LED displays



The following tables explain the meaning of the status and error displays. Remedies for diagnostic messages can be found in section Diagnostic messages (Page 47).

#### **⚠ WARNING**

The DIAG LED and the channel status and channel fault LEDs of the inputs are not designed as safety-related LEDs and therefore may not be evaluated for safety-related activities.





**PWR LED**

Table 6- 1 Meaning of the PWR LED

| PWR                                                                                      | Meaning                     |
|------------------------------------------------------------------------------------------|-----------------------------|
| <br>Off | Supply voltage L+ missing   |
| <br>On  | Supply voltage L+ available |







**DIAG LED**

Table 6- 2 Meaning of the DIAG LED

| DIAG                                                                                            | Meaning                                                |
|-------------------------------------------------------------------------------------------------|--------------------------------------------------------|
| <br>Off        | Backplane bus supply of the ET 200SP not okay          |
| <br>Flashing   | Module parameters not configured                       |
| <br>On       | Module parameters configured and no module diagnostics |
| <br>Flashing | Module parameters configured and module diagnostics    |

**Channel status/channel fault LED**

Table 6- 3 Meaning of the channel status/channel fault LED

| Channel status                                                                                              | Channel fault                                                                              | Meaning                                       |
|-------------------------------------------------------------------------------------------------------------|--------------------------------------------------------------------------------------------|-----------------------------------------------|
| <br>Off                  | <br>Off | Process signal = 0 and no channel diagnostics |
| <br>On                   | <br>Off | Process signal = 1 and no channel diagnostics |
| <br>Off                  | <br>On  | Process signal = 0 and channel diagnostics    |
| <br>Alternately flashing |                                                                                            | Channel waiting for user acknowledgment       |

## Channel status/DIAG/channel fault LED

Table 6- 4 Meaning of the channel status/DIAG/channel fault LED

| Channel status | DIAG          | Channel fault | Meaning                                                               |
|----------------|---------------|---------------|-----------------------------------------------------------------------|
| □<br>Off       | ⚡<br>Flashing | ■<br>All On   | The PROFIsafe address does not match the configured PROFIsafe address |
| ⚡<br>Flashing  | ⚡<br>Flashing | □<br>Off      | Identification of the F-module when assigning the PROFIsafe address   |

## 6.2 Interrupts

### Introduction

The F-DI 8×24VDC HF fail-safe digital input module supports diagnostic interrupts.

### Diagnostic interrupt

The F-module generates a diagnostic interrupt for each diagnostic message described in section Diagnostic messages (Page 47).

The table below provides an overview of the diagnostic interrupts of the F-module . The diagnostic interrupts are assigned either to one channel or the entire F-module.

Table 6- 5 Diagnostic interrupts of the F-DI 8×24VDC HF

| Diagnostic interrupt                                      | Fault code      | Signaled in application | Scope of diagnostic interrupt | Configurable |
|-----------------------------------------------------------|-----------------|-------------------------|-------------------------------|--------------|
| Overtemperature                                           | 5 <sub>D</sub>  | 1, 2, 3                 | F-module                      | No           |
| Parameter assignment error                                | 16 <sub>D</sub> |                         |                               |              |
| Load voltage missing                                      | 17 <sub>D</sub> |                         |                               |              |
| Access to retentive storage of F-address not possible     | 30 <sub>D</sub> |                         |                               |              |
| Different destination address (F_Dest_Add)                | 64 <sub>D</sub> |                         |                               |              |
| Invalid destination address (F_Dest_Add)                  | 65 <sub>D</sub> |                         |                               |              |
| Invalid source address (F_Source_Add)                     | 66 <sub>D</sub> |                         |                               |              |
| Watchdog time is 0 ms (F_WD_Time or F_WD_Time2)           | 67 <sub>D</sub> |                         |                               |              |
| "F_SIL" parameter exceeds the application-specific SIL    | 68 <sub>D</sub> |                         |                               |              |
| "F_CRC_Length" parameter does not match the generated CRC | 69 <sub>D</sub> |                         |                               |              |

6.2 Interrupts

| Diagnostic interrupt                                              | Fault code       | Signaled in application | Scope of diagnostic interrupt | Configurable |
|-------------------------------------------------------------------|------------------|-------------------------|-------------------------------|--------------|
| Incorrect F-parameter version or F_Block_ID                       | 70 <sub>D</sub>  |                         |                               |              |
| CRC1 error                                                        | 71 <sub>D</sub>  |                         |                               |              |
| Inconsistent iParameters (iParCRC error)                          | 75 <sub>D</sub>  |                         |                               |              |
| F_Block_ID not supported                                          | 76 <sub>D</sub>  |                         |                               |              |
| Internal error                                                    | 256 <sub>D</sub> |                         |                               |              |
| Time monitoring activated                                         | 259 <sub>D</sub> |                         |                               |              |
| Internal supply voltage of the module failed                      | 260 <sub>D</sub> |                         |                               |              |
| Incorrect/inconsistent firmware present. Firmware update required | 283 <sub>D</sub> |                         |                               |              |
| Discrepancy error, channel status 0/0                             | 768 <sub>D</sub> | 2, 3                    | Channel                       |              |
| Discrepancy error, channel status 0/1                             | 769 <sub>D</sub> |                         |                               |              |
| Discrepancy error, channel status 1/0                             | 770 <sub>D</sub> |                         |                               |              |
| Discrepancy error, channel status 1/1                             | 771 <sub>D</sub> |                         |                               |              |
| Input signal could not be clearly detected                        | 773 <sub>D</sub> | 1, 2, 3                 |                               |              |
| Short circuit of internal sensor supply to L+                     | 774 <sub>D</sub> |                         |                               |              |
| Overload or short circuit of internal sensor supply to ground     | 775 <sub>D</sub> |                         |                               |              |
| No pulse detected                                                 | 778 <sub>D</sub> | 1                       |                               |              |
| Sensor signal chatters                                            | 784 <sub>D</sub> |                         |                               |              |
| Switching frequency too high                                      | 785 <sub>D</sub> |                         |                               | No           |
| Undertemperature                                                  | 786 <sub>D</sub> |                         |                               |              |
| Fault in input circuit                                            | 787 <sub>D</sub> |                         |                               |              |
| PROFIsafe communication error (timeout)                           | 792 <sub>D</sub> |                         |                               |              |
| PROFIsafe communication error (CRC)                               | 793 <sub>D</sub> |                         |                               |              |
| PROFIsafe address assignment error                                | 794 <sub>D</sub> |                         |                               |              |
| Input short-circuited to L+                                       | 796 <sub>D</sub> |                         |                               |              |
| Supply voltage too high                                           | 803 <sub>D</sub> |                         |                               |              |
| Supply voltage too low                                            | 804 <sub>D</sub> |                         |                               |              |
|                                                                   |                  |                         |                               |              |
|                                                                   |                  |                         | Channel                       |              |
|                                                                   |                  |                         | F-module                      |              |
|                                                                   |                  |                         | Channel                       | Yes          |
|                                                                   |                  |                         | F-module                      | No           |

## 6.3 Diagnostic messages

### Diagnostic messages

Module faults are indicated as diagnostics (module status).

Once the fault is eliminated, the F-module must be reintegrated in the safety program. For additional information on passivation and reintegration of F-I/O, refer to the SIMATIC Safety – Configuring and Programming

(<http://support.automation.siemens.com/WW/view/en/54110126>) manual.

Table 6- 6 Diagnostic messages of the F-DI 8x24VDC HF

| Diagnostic message                                        | Fault code | Meaning                                                                                                                                                                                                                        | Remedy                                                                                                                                                                                                                  |
|-----------------------------------------------------------|------------|--------------------------------------------------------------------------------------------------------------------------------------------------------------------------------------------------------------------------------|-------------------------------------------------------------------------------------------------------------------------------------------------------------------------------------------------------------------------|
| Overtemperature                                           | 5D         | An excessively high temperature was measured in the F-module.                                                                                                                                                                  | Operate the F-module within the specified temperature range. (see Technical specifications (Page 53))<br>Once the fault has been eliminated, the F-module must be removed and inserted or the power switched OFF and ON |
| Parameter assignment error                                | 16D        | Parameter assignment errors include: <ul style="list-style-type: none"> <li>The F-module cannot use the parameters (unknown, invalid combination, etc.).</li> <li>The F-module parameters have not been configured.</li> </ul> | Correct the parameter assignment.                                                                                                                                                                                       |
| Load voltage missing                                      | 17D        | Missing or insufficient supply voltage L+                                                                                                                                                                                      | <ul style="list-style-type: none"> <li>Check supply voltage L+ at BaseUnit</li> <li>Check BaseUnit type</li> </ul>                                                                                                      |
| Access to retentive storage of F-address not possible     | 30D        | The F-destination address stored in the coding element cannot be accessed.                                                                                                                                                     | Verify that the coding element is present or replace the coding element.                                                                                                                                                |
| Different destination address (F_Dest_Add)                | 64D        | The PROFIsafe driver has detected a different F-destination address.                                                                                                                                                           | Check the parameter assignment of the PROFIsafe driver and the address setting of the F-module.                                                                                                                         |
| Invalid destination address (F_Dest_Add)                  | 65D        | The PROFIsafe driver has detected an invalid F-destination address.                                                                                                                                                            | Check the parameter assignment of the PROFIsafe driver.                                                                                                                                                                 |
| Invalid source address (F_Source_Add)                     | 66D        | The PROFIsafe driver has detected an invalid F-source address.                                                                                                                                                                 |                                                                                                                                                                                                                         |
| Watchdog time is 0 ms (F_WD_Time or F_WD_Time2)           | 67D        | The PROFIsafe driver has detected an invalid watchdog time.                                                                                                                                                                    |                                                                                                                                                                                                                         |
| "F_SIL" parameter exceeds the application-specific SIL    | 68D        | The PROFIsafe driver has detected a discrepancy between the SIL setting of the communication and the application.                                                                                                              |                                                                                                                                                                                                                         |
| "F_CRC_Length" parameter does not match the generated CRC | 69D        | The PROFIsafe driver has detected a discrepancy in the CRC length.                                                                                                                                                             |                                                                                                                                                                                                                         |

6.3 Diagnostic messages

| Diagnostic message                                                | Fault code       | Meaning                                                                                                                                                                                                                                                                                                                                                                                                                      | Remedy                                                                                                                                                                                                       |
|-------------------------------------------------------------------|------------------|------------------------------------------------------------------------------------------------------------------------------------------------------------------------------------------------------------------------------------------------------------------------------------------------------------------------------------------------------------------------------------------------------------------------------|--------------------------------------------------------------------------------------------------------------------------------------------------------------------------------------------------------------|
| Incorrect F-parameter version or F_Block_ID                       | 70 <sub>D</sub>  | The PROFIsafe driver has detected an incorrect version of the F-parameters or an invalid F_Block_ID.                                                                                                                                                                                                                                                                                                                         |                                                                                                                                                                                                              |
| CRC1 error                                                        | 71 <sub>D</sub>  | The PROFIsafe driver has detected inconsistent F-parameters.                                                                                                                                                                                                                                                                                                                                                                 |                                                                                                                                                                                                              |
| Inconsistent iParameters (iParCRC error)                          | 75 <sub>D</sub>  | The PROFIsafe driver has detected inconsistent iParameters.                                                                                                                                                                                                                                                                                                                                                                  | Check the parameter assignment.                                                                                                                                                                              |
| F_Block_ID not supported                                          | 76 <sub>D</sub>  | The PROFIsafe driver has detected an incorrect Block ID.                                                                                                                                                                                                                                                                                                                                                                     | Check the parameter assignment of the PROFIsafe driver.                                                                                                                                                      |
| Internal error                                                    | 256 <sub>D</sub> | Possible causes: <ul style="list-style-type: none"> <li>Impermissibly high electromagnetic interference is present.</li> <li>The F-module is defective.</li> </ul>                                                                                                                                                                                                                                                           | <ul style="list-style-type: none"> <li>Eliminate the interference. The module must then be pulled and plugged, or the power switched OFF and ON</li> <li>Replace the F-module.</li> </ul>                    |
| Internal supply voltage of the module failed                      | 260 <sub>D</sub> | Possible causes: <ul style="list-style-type: none"> <li>Impermissibly high electromagnetic interference is present.</li> <li>The F-module is defective.</li> </ul>                                                                                                                                                                                                                                                           | <ul style="list-style-type: none"> <li>Eliminate the electromagnetic interference. The module must then be pulled and plugged, or the power switched OFF and ON</li> <li>Replace the F-module.</li> </ul>    |
| Incorrect/inconsistent firmware present. Firmware update required | 283 <sub>D</sub> | The firmware is incomplete and/or firmware added to the F-module is incompatible. This leads to errors or functional limitations when operating the F-module.                                                                                                                                                                                                                                                                | <ul style="list-style-type: none"> <li>Perform a firmware update for all parts of the F-module and note any error messages.</li> <li>Use only firmware versions released for this F-module.</li> </ul>       |
| Discrepancy error, channel status 0/0                             | 768 <sub>D</sub> | Possible causes: <ul style="list-style-type: none"> <li>The process signal is faulty.</li> <li>The sensor is defective.</li> <li>The configured discrepancy time is too low.</li> <li>There is a short circuit between an unconnected sensor cable and the sensor supply cable.</li> <li>Wire break in connected sensor cable or the sensor supply cable</li> <li>An error occurred during the discrepancy check.</li> </ul> | <ul style="list-style-type: none"> <li>Check the process signal.</li> <li>Replace the sensor.</li> <li>Check the parameter assignment of the discrepancy time.</li> <li>Check the process wiring.</li> </ul> |
| Discrepancy error, channel status 0/1                             | 769 <sub>D</sub> |                                                                                                                                                                                                                                                                                                                                                                                                                              |                                                                                                                                                                                                              |
| Discrepancy error, channel status 1/0                             | 770 <sub>D</sub> |                                                                                                                                                                                                                                                                                                                                                                                                                              |                                                                                                                                                                                                              |
| Discrepancy error, channel status 1/1                             | 771 <sub>D</sub> |                                                                                                                                                                                                                                                                                                                                                                                                                              |                                                                                                                                                                                                              |



| Diagnostic message                                            | Fault code       | Meaning                                                                                                                                                                                                                                                                                                                                                                                                                                                                                                                                                                                                                                                                                                                                  | Remedy                                                                                                                                                                                                                                                  |
|---------------------------------------------------------------|------------------|------------------------------------------------------------------------------------------------------------------------------------------------------------------------------------------------------------------------------------------------------------------------------------------------------------------------------------------------------------------------------------------------------------------------------------------------------------------------------------------------------------------------------------------------------------------------------------------------------------------------------------------------------------------------------------------------------------------------------------------|---------------------------------------------------------------------------------------------------------------------------------------------------------------------------------------------------------------------------------------------------------|
| Input signal could not be clearly detected                    | 773 <sub>D</sub> | <p>An error occurred in the plausibility check of the input signal between the processors. You must eliminate the error within 100 hours. If you do not eliminate the error within 100 hours, the F-module will become inoperative.</p> <p>Possible causes:</p> <ul style="list-style-type: none"> <li>• The input signal is faulty, e.g., as a result of impermissibly high electromagnetic interference.</li> <li>• A high-frequency input signal is present, e.g., due to mutual interference of sensors or the signal being above the sampling frequency of the input signal.</li> <li>• A momentary interruption/short circuit of the sensor cable (loose contact) is present.</li> <li>• The sensor/switch is bouncing.</li> </ul> | <ul style="list-style-type: none"> <li>• Use shielded cables to reduce the EMC effects.</li> <li>• Reduce the input frequency.</li> <li>• Check the wiring of the sensor.</li> </ul>                                                                    |
| Short circuit of internal sensor supply to L+                 | 774 <sub>D</sub> | <p>Possible causes:</p> <ul style="list-style-type: none"> <li>• There is a short circuit of the internal sensor supply with L+.</li> <li>• There is a short circuit of two sensor supplies.</li> <li>• The capacitance of the connected sensor for the configured test time is too high.</li> <li>• The sensor is defective.</li> </ul>                                                                                                                                                                                                                                                                                                                                                                                                 | <ul style="list-style-type: none"> <li>• Eliminate the short circuit in the process wiring.</li> <li>• Check the configured test time and the process wiring.</li> <li>• Replace the sensor.</li> </ul>                                                 |
| Overload or short circuit of internal sensor supply to ground | 775 <sub>D</sub> | <p>Possible causes:</p> <ul style="list-style-type: none"> <li>• The internal sensor supply is short-circuited to ground.</li> <li>• Impermissibly high electromagnetic interference is present.</li> </ul>                                                                                                                                                                                                                                                                                                                                                                                                                                                                                                                              | <ul style="list-style-type: none"> <li>• Eliminate the overload.</li> <li>• Eliminate the short circuit in the process wiring.</li> <li>• Check the "Sensor supply" parameter.</li> <li>• Eliminate/reduce the electromagnetic interference.</li> </ul> |

6.3 Diagnostic messages

| Diagnostic message                      | Fault code       | Meaning                                                                                                                                                                                                                                                                                                                                                                                                                                                                                                                                                   | Remedy                                                                                                                                                                                                                                                                                    |
|-----------------------------------------|------------------|-----------------------------------------------------------------------------------------------------------------------------------------------------------------------------------------------------------------------------------------------------------------------------------------------------------------------------------------------------------------------------------------------------------------------------------------------------------------------------------------------------------------------------------------------------------|-------------------------------------------------------------------------------------------------------------------------------------------------------------------------------------------------------------------------------------------------------------------------------------------|
| No pulse detected                       | 778 <sub>D</sub> | <p>A pulse with a length greater than or equal to "Minimum pulse time" has not occurred within the time configured with the "Pulse monitoring window" parameter.</p> <p>Possible causes:</p> <ul style="list-style-type: none"> <li>• The "Pulse monitoring window" parameter setting is too high.</li> <li>• The "Minimum pulse time" parameter setting is too low.</li> <li>• There is a wire break in the process wiring.</li> </ul>                                                                                                                   | <ul style="list-style-type: none"> <li>• Check the "Pulse monitoring window" parameter.</li> <li>• Check the "Minimum pulse time" parameter.</li> <li>• Check the process wiring.</li> </ul>                                                                                              |
| Sensor signal chatters                  | 784 <sub>D</sub> | <p>Too many signal changes have occurred within the time configured with the "Monitoring window" parameter.</p> <ul style="list-style-type: none"> <li>• The "Monitoring window" parameter setting is too high.</li> <li>• The "Number of signal changes" parameter setting is too low.</li> <li>• A momentary interruption/short circuit of the sensor cable (loose contact) is present.</li> <li>• Impermissibly high electromagnetic interference is present.</li> <li>• The sensor/switch is bouncing.</li> <li>• The sensor is defective.</li> </ul> | <ul style="list-style-type: none"> <li>• Check the "Monitoring window" parameter.</li> <li>• Check the "Number of signal changes" parameter.</li> <li>• Check the process wiring.</li> <li>• Eliminate/reduce the electromagnetic interference.</li> <li>• Replace the sensor.</li> </ul> |
| Switching frequency too high            | 785 <sub>D</sub> | The maximum switching frequency of the F-module has been exceeded.                                                                                                                                                                                                                                                                                                                                                                                                                                                                                        | Reduce the switching frequency. (see Technical specifications (Page 53))                                                                                                                                                                                                                  |
| Undertemperature                        | 786 <sub>D</sub> | The minimum permissible temperature limit has been violated.                                                                                                                                                                                                                                                                                                                                                                                                                                                                                              | Operate the F-module within the specified temperature range. (see Technical specifications (Page 53))                                                                                                                                                                                     |
| Fault in input circuit                  | 787 <sub>D</sub> | <p>The F-module has detected an internal error.</p> <p>Possible causes:</p> <ul style="list-style-type: none"> <li>• Impermissibly high electromagnetic interference is present.</li> <li>• The F-module is defective.</li> </ul>                                                                                                                                                                                                                                                                                                                         | <ul style="list-style-type: none"> <li>• Eliminate/reduce the electromagnetic interference.</li> <li>• Replace the F-module.</li> </ul>                                                                                                                                                   |
| PROFIsafe communication error (timeout) | 792 <sub>D</sub> | <p>The PROFIsafe driver has detected a timeout.</p> <p>Possible causes:</p> <ul style="list-style-type: none"> <li>• The F-monitoring time is set incorrectly.</li> <li>• Bus faults are present.</li> </ul>                                                                                                                                                                                                                                                                                                                                              | <ul style="list-style-type: none"> <li>• Check the parameter assignment.</li> <li>• Ensure that communication is functioning correctly.</li> </ul>                                                                                                                                        |

| Diagnostic message                  | Fault code       | Meaning                                                                                                                                                                                                                                                                                                             | Remedy                                                                                                                                                                    |
|-------------------------------------|------------------|---------------------------------------------------------------------------------------------------------------------------------------------------------------------------------------------------------------------------------------------------------------------------------------------------------------------|---------------------------------------------------------------------------------------------------------------------------------------------------------------------------|
| PROFIsafe communication error (CRC) | 793 <sub>D</sub> | The PROFIsafe driver has detected a CRC error.<br>Possible causes: <ul style="list-style-type: none"> <li>The communication between the F-CPU and F-module is disturbed.</li> <li>Impermissibly high electromagnetic interference is present.</li> <li>An error occurred in the sign-of-life monitoring.</li> </ul> | <ul style="list-style-type: none"> <li>Check the communication connection between the F-module and F-CPU.</li> <li>Eliminate the electromagnetic interference.</li> </ul> |
| PROFIsafe address assignment error  | 794 <sub>D</sub> | An error occurred during the automatic PROFIsafe address assignment.                                                                                                                                                                                                                                                | Check the configuration.                                                                                                                                                  |
| Input short-circuited to L+         | 796 <sub>D</sub> | The input signal is short-circuited to L+.                                                                                                                                                                                                                                                                          | Eliminate the short circuit.                                                                                                                                              |
| Supply voltage too high             | 802 <sub>D</sub> | The supply voltage is too high.                                                                                                                                                                                                                                                                                     | Check the supply voltage.                                                                                                                                                 |
| Supply voltage too low              | 803 <sub>D</sub> | The supply voltage is too low.                                                                                                                                                                                                                                                                                      | Check the supply voltage.                                                                                                                                                 |

### Supply voltage outside the nominal range

If the supply voltage L+ is outside the specified value range, the DIAG LED flashes and the module is passivated.

When the voltage has recovered (level must remain above the specified value for at least 1 minute (see Technical specifications (Page 53) Voltages, Currents, Potentials)), the DIAG LED stops flashing. The module remains passivated.

### Behavior in case of cross circuit/short circuit to the sensor supply

When internal sensor supply is specified and short circuit test is deactivated, short circuits to ground at the sensor supplies are detected. Channels for which the relevant sensor supply is configured will be passivated.

When internal sensor supply is specified and short circuit test is enabled, short circuits to ground and potential at the sensor supply are detected. Channels for which the relevant sensor supply is configured will be passivated.

### Special features for fault detection

The detection of certain faults (short-circuits or discrepancy errors, for example) depends on the application, the wiring, and the parameter assignment of the short circuit test and the sensor power supply. For this reason, tables on fault detection for the applications are presented under Applications of the F-I/O module (Page 29).

### Generally applicable information on diagnostics

Information on diagnostics that pertains to all F-modules (for example, readout of diagnostics functions or passivation of channels) is available in the SIMATIC Safety – Configuring and Programming (<http://support.automation.siemens.com/WW/view/en/54110126>) manual.

## 6.4 Value status

### Properties

In addition to the diagnostic messages and the status and error display, the F-module makes available information about the validity of each input and output signal – the value status. The value status is entered in the process image along with the input signal.

### Value status for digital input and output modules

The value status is additional binary information of a digital input or output signal. It is entered in the process image of the inputs (PII) at the same time as the process signal. It provides information about the validity of the input or output signal.

The value status is influenced by the wire break check, short-circuit, chatter monitoring, pulse extension, and plausibility check.

- 1<sub>B</sub>: A valid process value is output for the channel.
- 0<sub>B</sub>: A fail-safe value is output for the channel, or the channel is deactivated.

### Assignment of inputs and outputs for the value status in the PII

Each channel of the F-module is assigned a value status in the process image of the inputs. You can find the assignment in section Address space (Page 27).

### Reference

A detailed description of the evaluation and processing of the value status can be found in the SIMATIC Safety – Configuring and Programming (<http://support.automation.siemens.com/WW/view/en/54110126>) manual.

## Technical specifications

### Technical specifications of F-DI 8x24VDC HF

| <b>6ES7136-6BA00-0CA0</b>                               |                                                     |
|---------------------------------------------------------|-----------------------------------------------------|
| Product type designation                                | F-DI 8x24VDC HF                                     |
| <b>General information</b>                              |                                                     |
| Hardware product version                                | 01                                                  |
| Firmware version                                        | V1.0.0                                              |
| <b>Product function</b>                                 |                                                     |
| I&M data                                                | Yes; IM0 to IM3                                     |
| <b>Engineering with</b>                                 |                                                     |
| STEP 7 TIA Portal configurable/integrated as of version | V12.0                                               |
| STEP 7 configurable/integrated as of version            | as of V5.5 SP3 / -                                  |
| PROFINET as of GSD version/GSD revision                 | V2.31                                               |
| <b>Supply voltage</b>                                   |                                                     |
| Type of supply voltage                                  | 24 V DC                                             |
| Rated value (DC)                                        | 24 V                                                |
| Low limit of permissible range (DC)                     | 20.4 V                                              |
| High limit of permissible range (DC)                    | 28.8 V                                              |
| Reverse polarity protection                             | Yes                                                 |
| <b>Input current</b>                                    |                                                     |
| Current consumption (rated value)                       | 75 mA; without load                                 |
| Current consumption, max.                               | 21 mA; from backplane bus                           |
| <b>Sensor supply</b>                                    |                                                     |
| Number of outputs                                       | 8                                                   |
| <b>Output current</b>                                   |                                                     |
| Up to 60 °C, max.                                       | 0.3 A                                               |
| Short circuit protection                                | Yes; electronic (response threshold 0.7 A to 1.8 A) |
| <b>24 V sensor supply</b>                               |                                                     |
| 24 V                                                    | Yes; min. L+ (-1.5 V)                               |
| Short circuit protection                                | Yes                                                 |
| Output current, max.                                    | 800 mA; total current of all sensors                |
| <b>Power</b>                                            |                                                     |
| Power consumption from the backplane bus                | 70 mW                                               |
| <b>Power loss</b>                                       |                                                     |
| Power loss, typ.                                        | 4 W                                                 |

|                                                                          | 6ES7136-6BA00-0CA0                                              |
|--------------------------------------------------------------------------|-----------------------------------------------------------------|
| <b>Address space</b>                                                     |                                                                 |
| <b>Address space per module</b>                                          |                                                                 |
| Input                                                                    | 6 bytes                                                         |
| Output                                                                   | 4 bytes                                                         |
| <b>Digital inputs</b>                                                    |                                                                 |
| Number of inputs                                                         | 8                                                               |
| m/p-reading                                                              | Yes; p-reading                                                  |
| Input characteristic curve according to IEC 61131, Type 1                | Yes                                                             |
| <b>Input voltage</b>                                                     |                                                                 |
| Type of input voltage                                                    | DC                                                              |
| Rated value, DC                                                          | 24 V                                                            |
| For "0" signal                                                           | -30 to +5 V                                                     |
| For "1" signal                                                           | +15 to +30 V                                                    |
| <b>Input current</b>                                                     |                                                                 |
| For "1" signal, typ.                                                     | 3.7 mA                                                          |
| <b>Input delay (for rated value of input voltage)</b>                    |                                                                 |
| For standard inputs                                                      |                                                                 |
| <ul style="list-style-type: none"> <li>• Assignable</li> </ul>           | Yes                                                             |
| <ul style="list-style-type: none"> <li>• For "0" to "1", min.</li> </ul> | 0.4 ms                                                          |
| <ul style="list-style-type: none"> <li>• For "0" to "1", max.</li> </ul> | 20 ms                                                           |
| <ul style="list-style-type: none"> <li>• For "1" to "0", min.</li> </ul> | 0.4 ms                                                          |
| <ul style="list-style-type: none"> <li>• For "1" to "0", max.</li> </ul> | 20 ms                                                           |
| For counter/technological functions                                      |                                                                 |
| <ul style="list-style-type: none"> <li>• Assignable</li> </ul>           | No                                                              |
| <b>Length of cable</b>                                                   |                                                                 |
| Cable length, shielded, max.                                             | 1000 m                                                          |
| Cable length unshielded, max.                                            | 500 m                                                           |
| <b>Interrupts/diagnostics/status information</b>                         |                                                                 |
| <b>Interrupts</b>                                                        |                                                                 |
| Diagnostic interrupt                                                     | Yes                                                             |
| Hardware interrupt                                                       | No                                                              |
| <b>Diagnostic messages</b>                                               |                                                                 |
| Diagnostics                                                              | Yes, see section "Interrupts/diagnostic messages" in the manual |
| <b>Diagnostics display LED</b>                                           |                                                                 |
| RUN LED                                                                  | Yes; green LED                                                  |
| ERROR LED                                                                | Yes; red LED                                                    |
| Monitoring of supply voltage                                             | Yes; green PWR LED                                              |
| Channel status display                                                   | Yes; green LED                                                  |
| For channel diagnostics                                                  | Yes; red LED                                                    |
| For module diagnostics                                                   | Yes; green/red DIAG LED                                         |

| <b>6ES7136-6BA00-0CA0</b>                                      |                      |
|----------------------------------------------------------------|----------------------|
| <b>Electrical isolation</b>                                    |                      |
| <b>Electrical isolation channels</b>                           |                      |
| Between channels                                               | No                   |
| Between the channels and the backplane bus                     | Yes                  |
| Between the channels and the supply voltage of the electronics | No                   |
| <b>Permitted potential difference</b>                          |                      |
| Between different circuits                                     | 75 V DC / 60 V AC    |
| <b>Isolation</b>                                               |                      |
| Isolation test voltage                                         | 707 V DC (type test) |
| <b>Standards, approvals, certificates</b>                      |                      |
| SIL acc. to IEC 61508                                          | SIL 3                |
| Suitable for safety functions                                  | Yes                  |
| <b>Maximum achievable safety class in safety mode</b>          |                      |
| Performance level according to EN ISO 13849-1                  | PLe                  |
| Low demand (PFD) acc. to SIL3                                  | < 2.00E-05 1/h       |
| High demand (PFH) acc. to SIL3                                 | < 1.00E-09 1/h       |
| <b>Environmental conditions</b>                                |                      |
| <b>Operating temperature</b>                                   |                      |
| Min.                                                           | 0 °C                 |
| Max.                                                           | 60 °C                |
| Horizontal installation, min.                                  | 0 °C                 |
| Horizontal installation, max.                                  | 60 °C                |
| Vertical installation, min.                                    | 0 °C                 |
| Vertical installation, max.                                    | 50 °C                |
| <b>Storage/transport temperature</b>                           |                      |
| Min.                                                           | -40 °C               |
| Max.                                                           | 70 °C                |
| <b>Dimensions</b>                                              |                      |
| Width                                                          | 15 mm                |
| <b>Weights</b>                                                 |                      |
| Weight, approx.                                                | 49 g                 |

## Dimension drawing

See ET 200SP BaseUnits

(<http://support.automation.siemens.com/WW/view/en/58532597/133300>) manual





## Response times

### Introduction

The next section shows the response times of the digital input module F-DI 8×24VDC HF. The response time of the digital input module F-DI 8×24VDC HF is included in the calculation of the F-system response time.

### Definition of response time for fail-safe digital inputs

The response time represents the interval between a signal change at the digital input and reliable availability of the safety frame on the backplane bus.

### Times required for the calculation

Maximum internal processing time:  $T_{\max.} = 20 \text{ ms}$

Maximum cycle time:  $T_{\text{cycle}} = 11.5 \text{ ms}$

Short circuit test time for the sensor supply configured for the channel = "Time for short circuit test" + "Startup time after short circuit test"

The input delay, short circuit test times, and discrepancy time are configured in STEP 7.

If you have configured "Supply value 0", the sensor-actuator response time is not affected by the discrepancy time.

### Maximum response time in the error-free case with 1oo1 evaluation

Maximum response time =  $T_{\max}$  + Input delay + Short circuit test time for the sensor supply configured for the channel

### Maximum response time in the error-free case with 1oo2 evaluation

Maximum response time =  $T_{\max}$  + Input delay + Maximum (short circuit test time for the sensor supply configured for channel n, short circuit test time for the sensor supply configured for channel n+4)

### Maximum response time with external short circuits

Maximum response time = input delay +  $(n \times T_{\text{cycle}})$  + sum ("Time for short circuit test" + "Startup time after short circuit test" for sensor with activated short circuit test)

n = Number of sensor supplies with activated short circuit test

**Maximum response time with discrepancy error and 1oo2 evaluation**

Maximum response time =  $T_{\max}$  + Input delay + Discrepancy time + 2 × Maximum (short circuit test time for the sensor supply configured for channel n, short circuit test time for the sensor supply configured for channel n+4)