

**SIEMENS**

*Ingenuity for life*

*Industry Online Support*

Home

# Length and Speed Measurement using High-Speed Counters (HSC)

SIMATIC S7-1200 from firmware V4.2

<https://support.industry.siemens.com/cs/ww/en/view/109754525>

Siemens  
Industry  
Online  
Support



## Legal information

### Use of application examples

Application examples illustrate the solution of automation tasks through an interaction of several components in the form of text, graphics and/or software modules. The application examples are a free service by Siemens AG and/or a subsidiary of Siemens AG ("Siemens"). They are non-binding and make no claim to completeness or functionality regarding configuration and equipment. The application examples merely offer help with typical tasks; they do not constitute customer-specific solutions. You yourself are responsible for the proper and safe operation of the products in accordance with applicable regulations and must also check the function of the respective application example and customize it for your system.

Siemens grants you the non-exclusive, non-sublicensable and non-transferable right to have the application examples used by technically trained personnel. Any change to the application examples is your responsibility. Sharing the application examples with third parties or copying the application examples or excerpts thereof is permitted only in combination with your own products. The application examples are not required to undergo the customary tests and quality inspections of a chargeable product; they may have functional and performance defects as well as errors. It is your responsibility to use them in such a manner that any malfunctions that may occur do not result in property damage or injury to persons.

### Disclaimer of liability

Siemens shall not assume any liability, for any legal reason whatsoever, including, without limitation, liability for the usability, availability, completeness and freedom from defects of the application examples as well as for related information, configuration and performance data and any damage caused thereby. This shall not apply in cases of mandatory liability, for example under the German Product Liability Act, or in cases of intent, gross negligence, or culpable loss of life, bodily injury or damage to health, non-compliance with a guarantee, fraudulent non-disclosure of a defect, or culpable breach of material contractual obligations. Claims for damages arising from a breach of material contractual obligations shall however be limited to the foreseeable damage typical of the type of agreement, unless liability arises from intent or gross negligence or is based on loss of life, bodily injury or damage to health. The foregoing provisions do not imply any change in the burden of proof to your detriment. You shall indemnify Siemens against existing or future claims of third parties in this connection except where Siemens is mandatorily liable.

By using the application examples you acknowledge that Siemens cannot be held liable for any damage beyond the liability provisions described.

### Other information

Siemens reserves the right to make changes to the application examples at any time without notice. In case of discrepancies between the suggestions in the application examples and other Siemens publications such as catalogs, the content of the other documentation shall have precedence.

The Siemens terms of use (<https://support.industry.siemens.com>) shall also apply.

### Security information

Siemens provides products and solutions with industrial security functions that support the secure operation of plants, systems, machines and networks.

In order to protect plants, systems, machines and networks against cyber threats, it is necessary to implement – and continuously maintain – a holistic, state-of-the-art industrial security concept. Siemens' products and solutions constitute one element of such a concept.

Customers are responsible for preventing unauthorized access to their plants, systems, machines and networks. Such systems, machines and components should only be connected to an enterprise network or the Internet if and to the extent such a connection is necessary and only when appropriate security measures (e.g. firewalls and/or network segmentation) are in place.

For additional information on industrial security measures that may be implemented, please visit <https://www.siemens.com/industrialsecurity>.

Siemens' products and solutions undergo continuous development to make them more secure. Siemens strongly recommends that product updates are applied as soon as they are available and that the latest product versions are used. Use of product versions that are no longer supported, and failure to apply the latest updates may increase customer's exposure to cyber threats.

To stay informed about product updates, subscribe to the Siemens Industrial Security RSS Feed at: <https://www.siemens.com/industrialsecurity>.

# Table of contents

<b>Legal information</b> .....	<b>2</b>
<b>1 Introduction</b> .....	<b>4</b>
1.1 Overview .....	4
1.2 Mode of operation .....	5
1.3 Components used .....	5
<b>2 Engineering</b> .....	<b>7</b>
2.1 Hardware configuration .....	7
2.1.1 Resistance calculation .....	8
2.2 Configuration .....	8
2.2.1 Configuring pulse generators .....	8
2.2.2 Configuring a high-speed counter .....	10
2.2.3 Configuring a digital input .....	12
2.3 Interface description .....	13
2.3.1 Retrieve hardware ID .....	14
2.4 Operation .....	16
2.4.1 Watch table .....	17
2.4.2 HMI .....	17
2.5 Errorconsideration .....	19
2.5.1 Inclined plane .....	19
2.5.2 Eddy current brake .....	19
2.5.3 Acceleration by tensioning device .....	20
<b>3 Useful information</b> .....	<b>21</b>
3.1 Details on functionality .....	21
3.1.1 Dimensions .....	21
3.1.2 Strip board assembly .....	22
3.2 Basics .....	22
3.2.1 High-speed counters .....	22
3.2.2 PWM (Pulse Width Modulation) .....	25
<b>4 Appendix</b> .....	<b>26</b>
4.1 Links and Literature .....	27
4.2 Change documentation .....	27

# 1 Introduction

## 1.1 Overview

The SIMATIC S7-1200 offers integrated functions such as pulse generators and high-speed counters.

In most cases, high-speed counters are used in conjunction with a rotary encoder to measure motor speed or the distance or length of workpieces on a conveyor belt.

Using the example of the "pencil slingshot", the length and speed measurement is shown strikingly by the high-speed counters, by the simplest means, such as the integrated PWM generator of the S7-1200 and light barriers. You can find a video about this Application Example at:

<https://www.youtube.com/watch?v=eB-k6HW58xA>

Figure 1-1

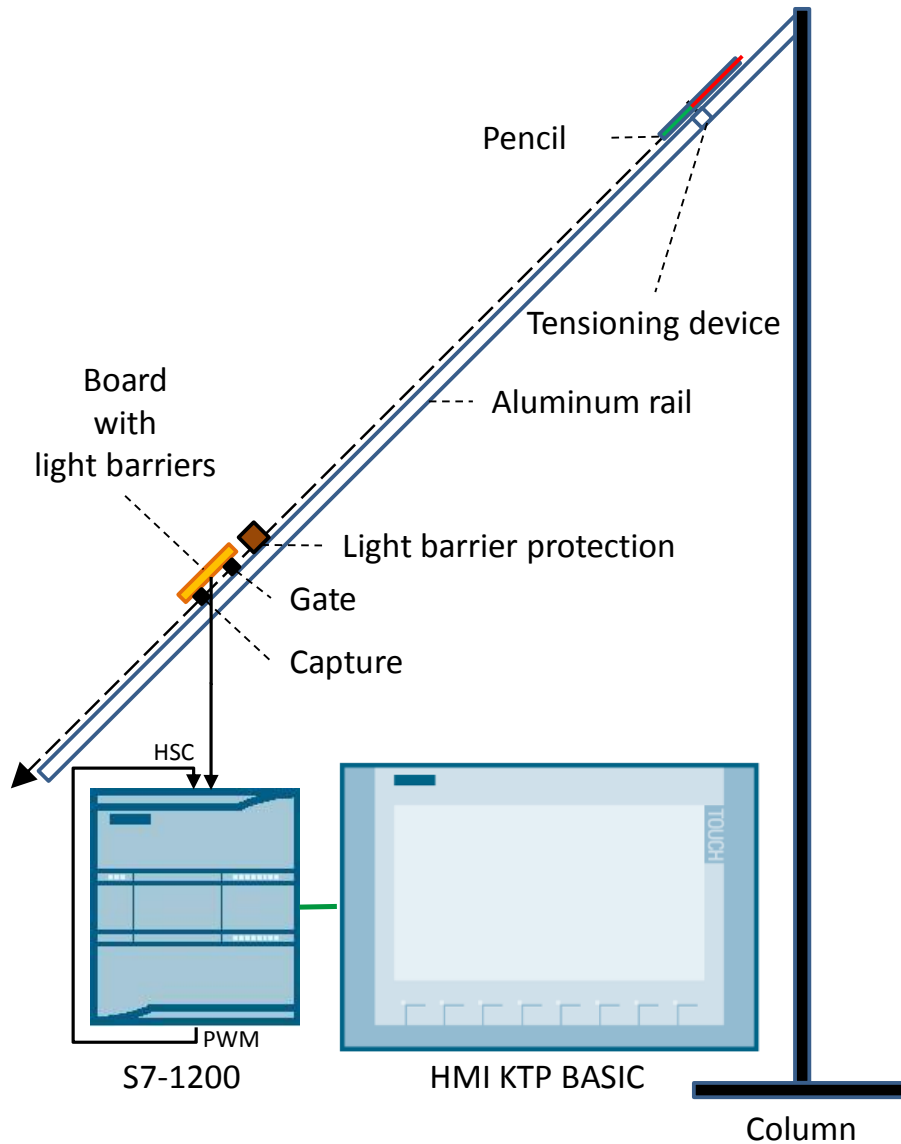

## 1.2 Mode of operation

The device is a sloping aluminum rail on which a pencil is passed through two light barriers (mounted on a board). The light barriers are connected to the digital inputs of the S7-1200. A pulse generator of the S7-1200 outputs constant digital time pulses via pulse width modulation (PWM). The pulse output is fed back to the digital input of the high-speed counter (HSC). When the first light barrier (gate) is darkened, the high-speed counter measures the number of pulses. A second light barrier (capture), at a known distance from the gate light barrier, detects the speed of the pencil. The length of the pencil can be determined from the speed and time of darkening and displayed on an HMI panel.

The pencil is accelerated by the inclined plane and can also be decelerated by a magnet (principle: eddy current brake) or can be re-accelerated with a tensioning device (principle: bow and arrow). A cardboard tunnel is mounted directly in front of the board to guide the pencil and protect the light barriers.

## 1.3 Components used

The following hardware and software components were used to create this Application Example:

Table 1-1

Component	Number	Article number	Note
CPU 1211C DC/DC/DC	1	6ES7211-1AE40-0XB0	Alternatively, any other CPU of the S7-1200 product family with firmware V4.2.1 ( <a href="#">V7</a> ) and transistor outputs (DC) can be used.
Pencils (if possible, coated to minimize friction)	3		Minimum length: Distance between the light barriers
Aluminum profile to guide the pencils	1	Length: 1.5 m	Profile 20x20 mm B-type groove width 6 mm Groove depth 5.5 mm
Cross struts for the tensioning device	2	Length: 0.35 m	The correct size for the aluminum profile
Angle fasteners for the tensioning device	2		The correct size for the aluminum profile
M5 screws to tension the rubber	2		Length 1-1.5 cm
Threaded plate for screws	2		B-type groove 6 [M5]
Strip board with copper lamination (grid 2.54 mm x 2.54 mm)	1		for light barrier mounting
Forked light barrier	2		Manufacturer: Optek Designation: OPB815L e.g. <a href="#">V8</a>

## 1 Introduction

Component	Number	Article number	Note
Series resistance light barrier	2		1.8 kOhm +/- 1%; 0.6 W
Load resistance for PWM signal improvement	1		560 ohms +/- 5%; 0.5 W
Round magnet for eddy current braking of a pencil	1		Diameter: 4 mm Length: 1-1.5 cm
Rubber sealing rings	2		To accelerate the pencils
Cord	1		Length: approx. 25 cm
Roll of adhesive tape	1		To mount the light barrier board and light barrier protection
Silicone spray for spraying the aluminum rail	1		To minimize friction
SIMATIC HMI KTP700 BASIC	1	6AV2123-2GB03-0AX0	To display the measurement results (can also be simulated in the TIA Portal)
POWER SUPPLY S7-1200 PM1207	1	6EP1332-1SH71	24V power supply of the S7-1200 CPU
STEP 7 Basic V15	1	6ES7822-0a.05-..	With Update 1 ( <a href="#">V6</a> ) -Also contains WinCC Basic V15 for HMI usage

This Application Example consists of the following components:

Table 1-2

Component	File name	Note
Documentation	109754525_S71200_HSC_CalcVeloLength_DOC_V10_de.pdf	
STEP 7 project	109754525_S71200_HSC_CalcVeloLength_TiaV15_PROJ_V10.zip	

# 2 Engineering

## 2.1 Hardware configuration

Figure 2-1

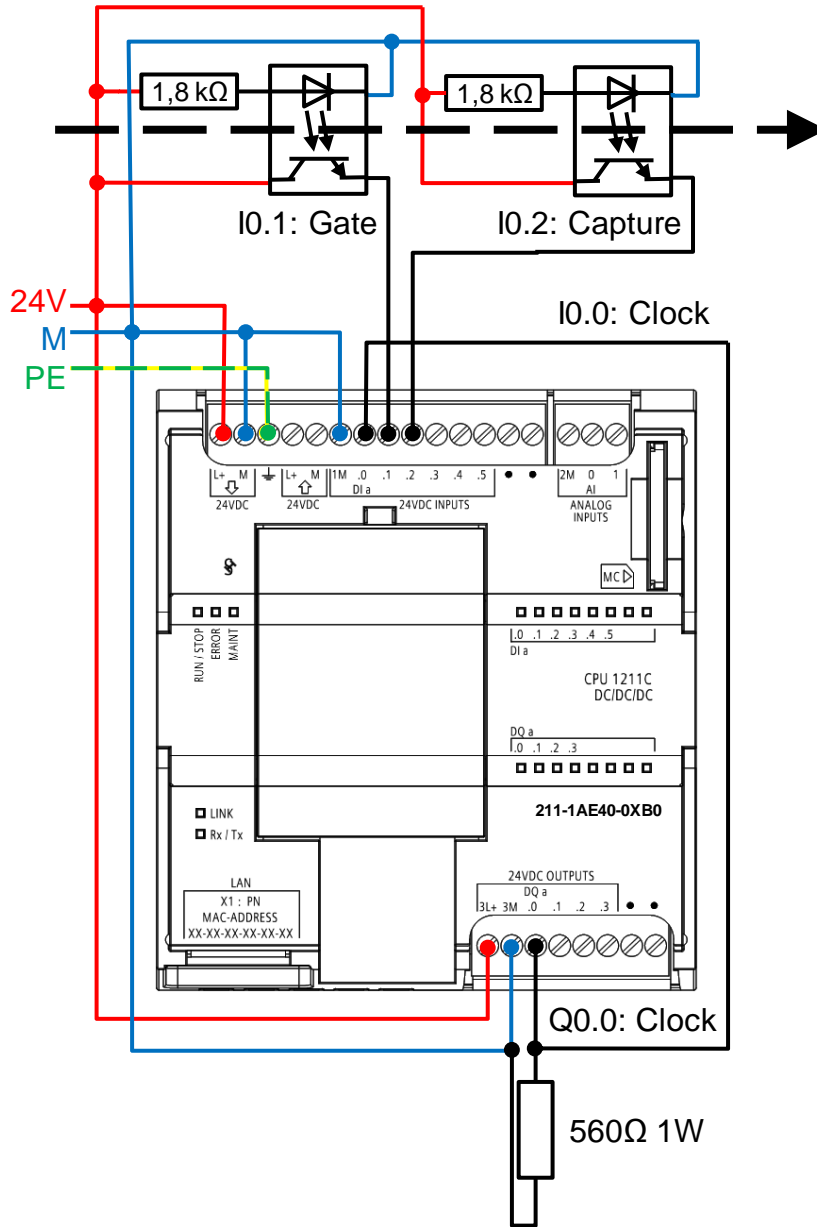

### 2.1.1 Resistance calculation

#### Series resistance for the light barrier

The data sheet of the forked light barrier is used to calculate the series resistance for the infrared LED of the light barrier. This is available under the following link:

<https://docs-emea.rs-online.com/webdocs/0099/0900766b800999df.pdf>

$$R_{LED} = U_{L+} / I_F = 24V / 20mA = 1.2 \text{ k}\Omega \approx 1.8 \text{ k}\Omega$$

The test setup was successfully tested with a series resistance of 1.8 k $\Omega$ .

#### Load resistance for the PWM output

**Note** Depending on the pulse receiver and cable, additional load resistance (at least 10% of the rated current) may improve the quality of the pulse signals and resistance to interference.

$$R_{Load} = U_{L+} / (10\% * I_N) = 24V / (10\% * 0.5A) = 480\Omega \approx 560\Omega$$

$$P_{Loss} = U * I = U * U/R = U^2 / R = 1.03 \text{ W} \approx 1W$$

**Note** Since the duty cycle of the PWM signal is 50%, half the dissipation of the load resistance is sufficient (i.e. 0.5W).

## 2.2 Configuration

### 2.2.1 Configuring pulse generators

The maximum frequency of the digital inputs (Ea.0 to Ea.5) of the S7-1200 is 100 kHz. This corresponds to a period duration (cycle time) of 10  $\mu$ s.

To configure a pulse generator (PWM) with a cycle time of 10  $\mu$ s and a duty cycle of 50%, proceed as follows:

1. Select an S7-1200 CPU in the device or network view.
2. In the Inspector window, under "Properties> General> Pulse generators (PTO/PWM)", click on "PTO1/PWM1".
3. Activate the pulse generator in the parameter group "General" with the corresponding check box. In "Project information", you can enter a name and a comment for the pulse generator.



Figure 2-2: Activate pulse generators

The screenshot shows a software window titled 'General'. Under the 'Enable' section, there is a checked checkbox labeled 'Enable this pulse generator'. Below this, the 'Project information' section contains a 'Name' field with the value 'Pulse\_1' and a 'Comment' field which is currently empty.

4. Define the pulse options of the pulse generator in the parameter group "Parameter assignment" as follows:
  - "Signal type": "PWM"
  - "Time base": "Microseconds"
  - "Pulse duration format": "Hundredths"
  - "Cycle time": 10  $\mu$ s
  - "Initial pulse duration": 50 "hundredths"
  - Activate the "Allow runtime modification of the cycle time" option to output the cycle time via the output addresses ([Figure 2-5](#)).

Figure 2-3: Defining pulse generator pulse options

The screenshot shows a software window titled 'Parameter assignment'. Under the 'Pulse options' section, the following settings are visible:

- Signal type: PWM (dropdown menu)
- Time base: Microseconds (dropdown menu)
- Pulse duration format: Hundredths (dropdown menu)
- Cycle time: 10  $\mu$ s (spin box)
- Initial pulse duration: 50 Hundredths (spin box)
- Allow runtime modification of the cycle time: checked checkbox

**Note** The smaller the cycle time, the more accurately the speed can be determined.

5. In the parameter group "Hardware outputs", for the "Pulse output", enter the hardware output "% Q0.0":

Figure 2-4: Hardware outputs

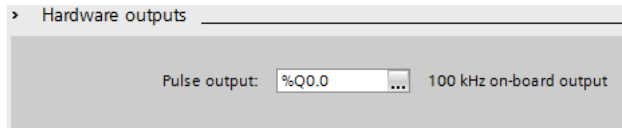

6. In the "I/O addresses" area, you set the parameters of the output addresses.

Figure 2-5: Parameters for output addresses.

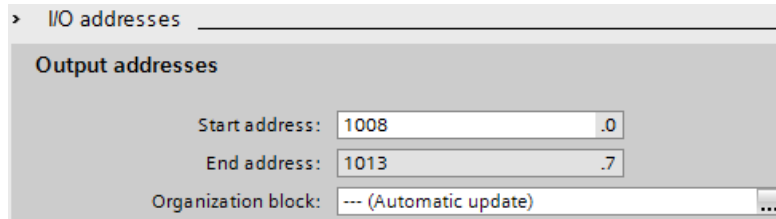

The output addresses allow you to read (or set) the following parameters -> see [Figure 2-17](#):

- QW1008: Pulse duration
- QD1010: Cycle time

### 2.2.2 Configuring a high-speed counter

To configure a high-speed counter, follow these steps:

1. Select an S7-1200 CPU in the device or network view.
2. In the Inspector window, under "Properties> General> High speed counters (HSC)", click on the high-speed counter "HSC1".
3. Activate the high-speed counter in the "General" parameter group with the corresponding check box. In "Project information", you can enter a name and a comment for the counter.

Figure 2-6: Activating the HSC

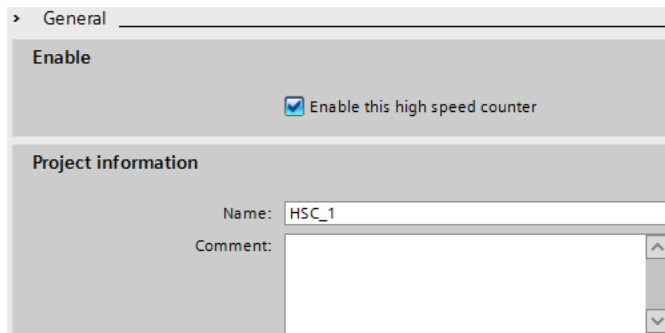

4. Define the function of the counter in the "Function" parameter group as follows:
  - "Type of counting": "Count"
  - "Operating phase": "Single phase"
  - "Counting direction is specified by": "User program (internal direction control)"
  - "Initial counting direction": "Count up"

Figure 2-7: Defining the HSC function

The screenshot shows the 'Function' parameter group with the following settings:

- Type of counting: Count
- Operating phase: Single phase
- Counting direction is specified by: User program (internal direction control)
- Initial counting direction: Count up
- Frequency measuring period: +/- sec

5. Activate the check box "Use external input to capture current count" in the parameter group "Capture input". In the "Start condition for recording the input" drop-down list, select the "Falling edge" option.

Figure 2-8: Activating the capture input

The screenshot shows the 'Capture input' parameter group with the following settings:

- Use external input to capture current count
- Start condition for recording the input: Falling edge

6. Activate the check box "Use external gate input" in the parameter group "Gate input". Since we wish to measure the time at which the light barrier signal is interrupted, from the drop-down list "Signal level 11 of the hardware gate", select the option "Active low".

Figure 2-9: Activating the hardware gate

The screenshot shows the 'Gate input' parameter group with the following settings:

- Use external gate input
- Signal level of the hardware gate: Active low

7. Enter the following hardware inputs in the "Hardware inputs" parameter group:
  - "Clock generator input": "%I0.0"
  - "Gate input": "%I0.1"
  - "Capture input": "%I0.2"

Figure 2-10: Hardware inputs

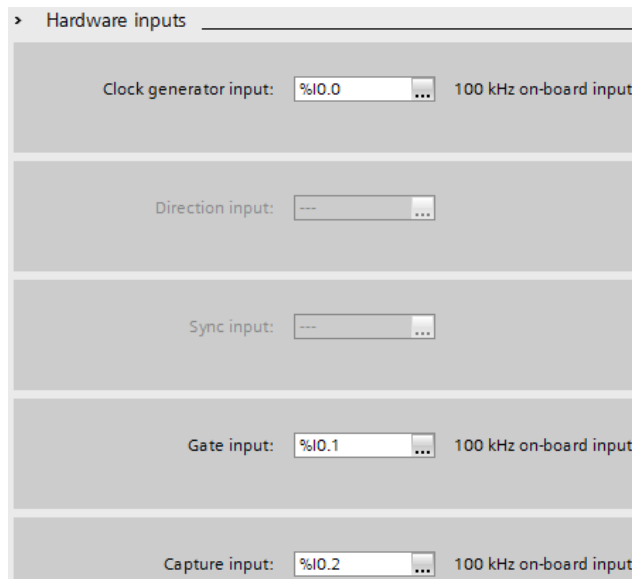

- In the "I/O addresses" area, you can set the parameters of the input addresses.

Figure 2-11: Parameters for input addresses.

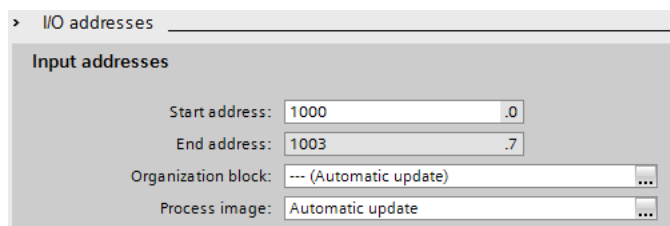

**Note**

The S7-1200 saves the current value of the HSC as DINT in the input address specified under "Start address". You can call up the value, for example, in the watch table via ED1000 (see Chapter 2.4.1) or you can use the count value of the system data type in conjunction with the instruction "CTRL\_HSC\_EXT" (see Table 2-2).

**2.2.3 Configuring a digital input**

To safely detect the pulses of the inputs to the clock generator and the gate input, you must set the filter time of the digital inputs at a lower value than the duration of the input signal.

$$F = 100 \text{ KHz} \rightarrow T = 10 \mu\text{s}$$

$$\text{Input filter} < T/2 = 5 \mu\text{s}$$

The filter time is set as follows:

- Select an S7-1200 CPU in the device or network view.
- In the Inspector window, under "Properties > General > DI 6/DQ 4 > Digital inputs", click on "Channel0".
- Set the "Input filter" to e.g. "3.2 microsec".

Figure 2-12: Input filter for clock generator

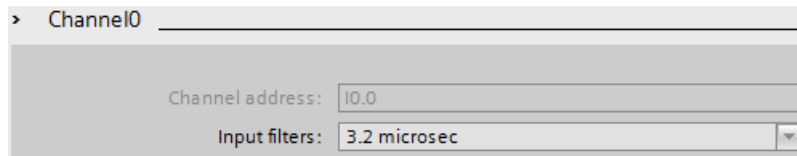

- Repeat the setting of the "Input filter" of "3.2 microsec" for Channels 1 and 2.

**Note**

With smaller filter times, double signals may occur due to the simple light barriers (without Schmitt trigger). Ensure EMC-compliant cable routing. For high-speed counters, it is essential that the input filters are set correctly!

## 2.3 Interface description

The "CalcVeloLength" FB calculates the speed and length of an object via the high-speed counters of the S7-1200. In this case, a pulse generator is configured for PWM generation and fed back to a digital input. In addition to the clock generator input, the HighSpeedCounter uses the gate input and the capture input.

Figure 2-13 FB "CalcVeloLength"

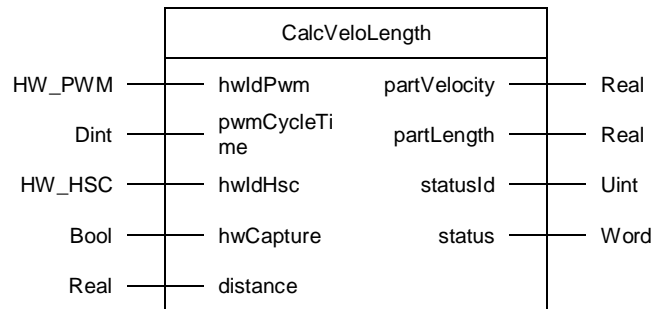

Table 2-1: Parameters of FB "CalcVeloLength"

Name	P-Type	Data type	Comment
hwldPwm	IN	HW_PWM	Hardware ID of the configured PWM pulse generator (see Chapter <a href="#">2.3.1</a> )
pwmCycleTime	IN	Dint	Cycle time of the PWM signal in $\mu\text{s}$ (as long as you do not change the time basis in <a href="#">Figure 2-3</a> , you can transfer QD1010 from <a href="#">Figure 2-5</a> here)
hwldHsc	IN	HW_HSC	Hardware ID of the configured high-speed counter (see Chapter <a href="#">2.3.1</a> )
hwCapture	IN	Bool	Hardware input of the capture signal (see <a href="#">Figure 2-10</a> )
distance	IN	Real	Distance between the light barriers [mm]
partVelocity	OUT	Real	Calculated speed of the object
partLength	OUT	Real	Calculated length of the object
statusID	OUT	Uint	Status flag: 0=No error 1 = Error calling instruction " <a href="#">CTRL_PWM</a> " 2 = Error calling instruction " <a href="#">CTRL_HSC_EXT</a> "

Name	P-Type	Data type	Comment
status	OUT	Word	Status of the faulty instruction (see "statusId")

### 2.3.1 Retrieve hardware ID

The pulse generator and high-speed counter hardware identifiers can be found by displaying all PLC variables. In the "System constants" tab, you will find the name of the configured pulse generator (see [Figure 2-2](#)) or high-speed counter (see [Figure 2-6](#)) with the prefix "Local~". You can transfer the absolute value or the symbolic name to the respective interface parameter in [Table 2-1](#).

Figure 2-14

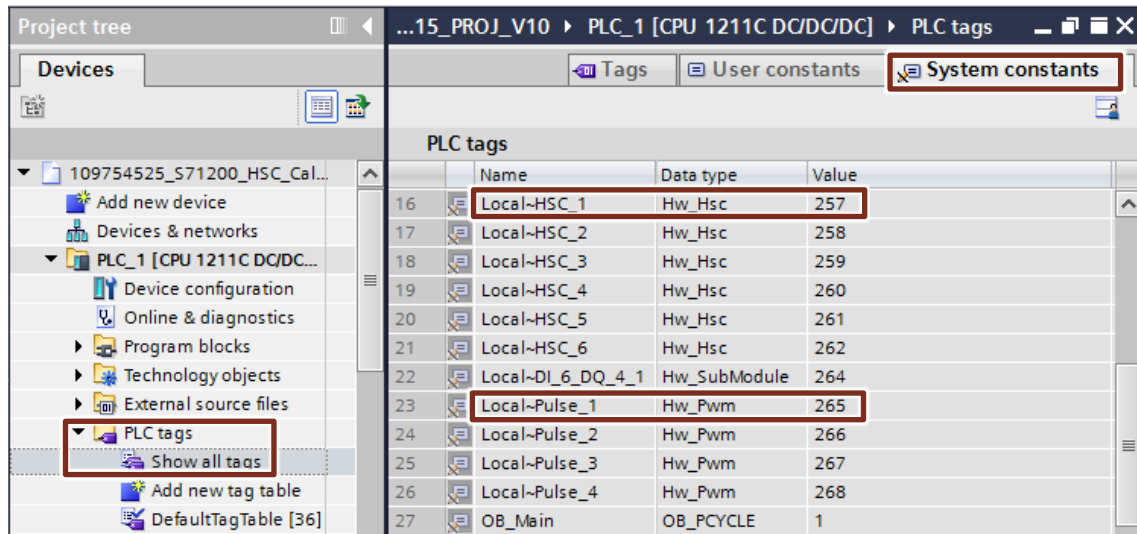
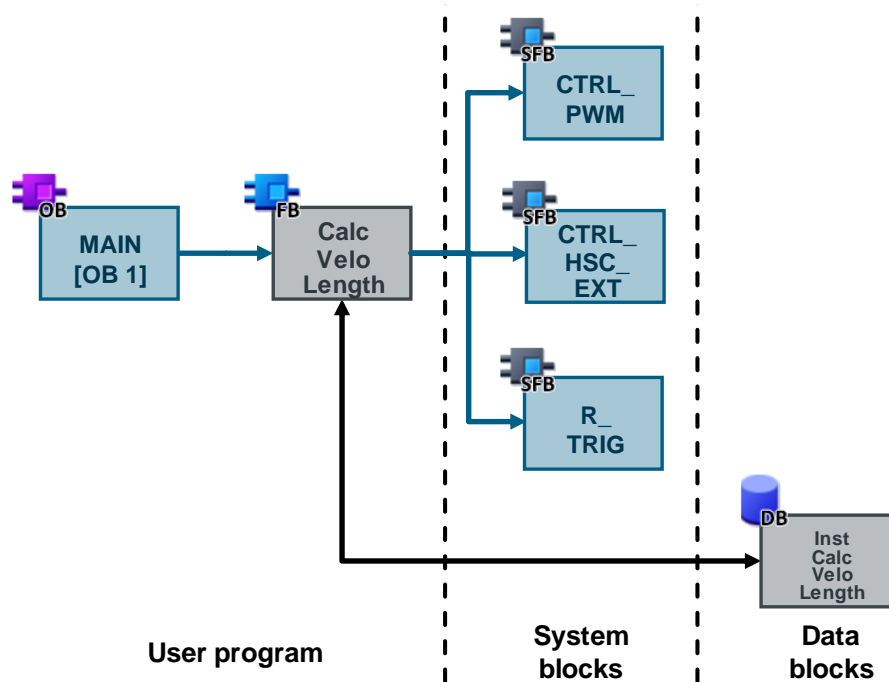

Figure 2-15



The "CalcVeloLength" FB is called up in the cyclic organization block. It calls up the following system blocks:

- [CTRL\\_PWM](#) to perform pulse duration modulation
- [CTRL\\_HSC\\_EXT](#) to control the high-speed counter
- [R\\_TRIG](#) for positive edge evaluation of the capture input

The instance data block "InstCalcVeloLength" of the FB "CalcVeloLength" is also a multi-instance for the system FBs.

Depending on the configuration of the high-speed counter, one of the following system data types (SDT) is transferred to the "CTRL" interface of FB "CTRL\_HSC\_EXT":

- HSC\_Count for "Count" mode
- HSC\_Period for "Period" mode
- HSC\_Frequency for "Frequency" mode

For the "Count" operating mode, the following static variables of the SDT "statHscCount" in the "CalcVeloLength" FBs are decisive:

Table 2-2: important parameters of the SDT "HSC\_Count" (FB "CalcVeloLength.statHscCount")

Name	Data type	Default value	Comment
CurrentCount	Dint	0	Outputs the current HSC value
CapturedCount	Dint	0	Outputs the counter value acquired at the specified input event
EnHSC	Bool	true	Must be true for the HSC to count pulses
EnCapture	Bool	true	Must be true in order for the "Capture" input to be evaluated
EnCV	Bool	false	Needed to set "CurrentCount" to "NewCurrentCount"

Name	Data type	Default value	Comment
			after evaluation
NewCurrentCount	Dint	0	Must be '0' to reset (synchronize) "CurrentCount" after evaluation

## 2.4 Operation

The Application Example is operated automatically via light barrier detection. For explanation, the following trace capture is used:

Figure 2-16

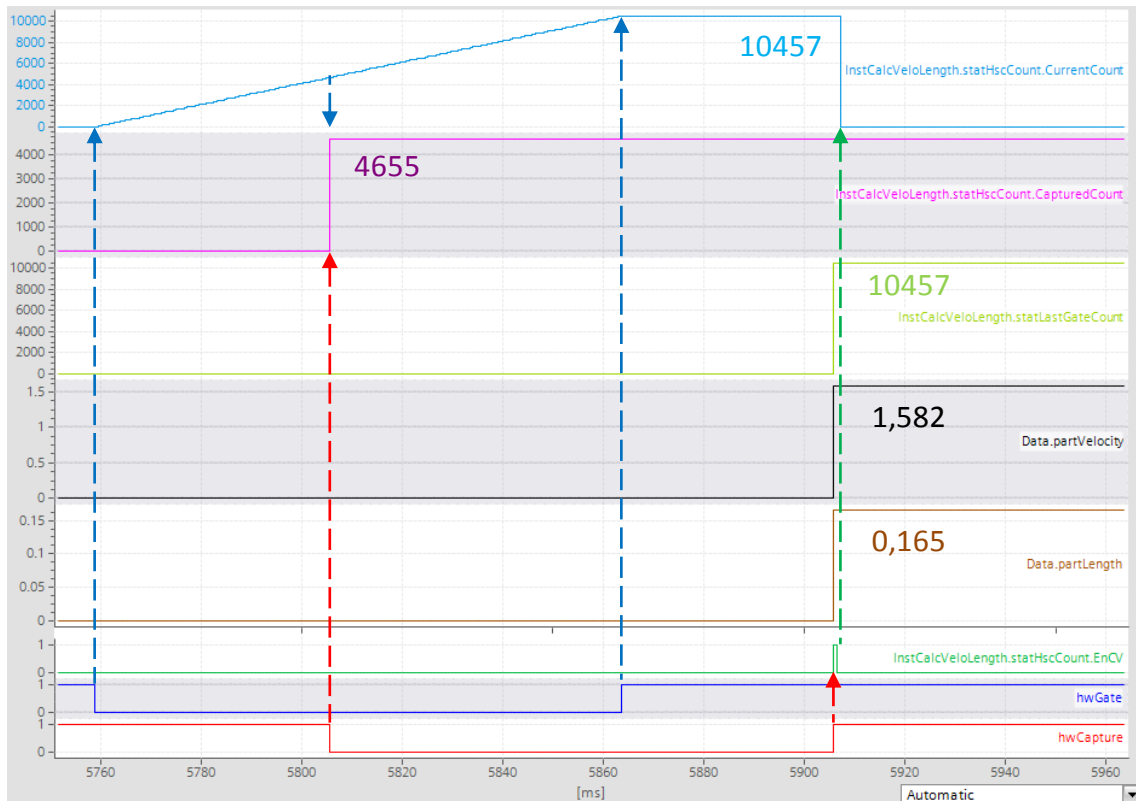

© Siemens AG 2018 All rights reserved

The light barriers are light-switching. If there is a negative edge at the "hwGate" gate input, the pulses are counted by means of a high-speed counter at "InstCalcVeloLength.statHscCount.CurrentCount". When the capture light barrier "hwCapture" is reached, the current counter value is stored in "InstCalcVeloLength.statHscCount.CaptureCount" (here 4655).

When the light barrier "hwGate" is exited, the count value "CurrentCount" is stopped (here 10457). If the object also leaves the second light barrier "hwCapture", the count is copied into the variable "InstCalcVeloLength.statLastGateCount" and the speed and the length of the object are calculated:

$$\text{Data.partVelocity} = \text{distance} / (\text{captureCount} * \text{pwmCycleTime})$$

$$\text{Data.partVelocity} = 73.66 \text{ mm} / (4655 * 10 \text{ } \mu\text{s}) \approx 1.582 \text{ m/s}$$

$$\text{Data.partLength} = \text{partVelocity} * \text{gateCount} * \text{pwmCycleTime}$$

$$\text{Data.partLength} = 1.582 \text{ m/s} * 10457 * 10 \text{ } \mu\text{s} \approx 0.165 \text{ m/s}$$



Finally, for synchronization, the bit "InstCalcVeloLength.statHscCount.EnCV" is set for one cycle. Then the count value "CurrentCount" of the high-speed counter is set to 0 and the next item can be measured.

### 2.4.1 Watch table

The "WatchTable" shows you all required data of the Application Example.

Figure 2-17

	i	Name	Address	Display format	Monitor value
1		// PWM			
2		"pwm1PulseDuration"	%QW1008	DEC	50
3		"pwm1CycleTime"	%QD1010	DEC	10
4		"pwm1Out"	%Q0.0	Bool	<input type="checkbox"/> FALSE
5		// HSC			
6		"clockInput"	%I0.0	Bool	<input type="checkbox"/> FALSE
7		"hwGate"	%I0.1	Bool	<input checked="" type="checkbox"/> TRUE
8		"hwCapture"	%I0.2	Bool	<input checked="" type="checkbox"/> TRUE
9		"hsc1CountValue"	%ID1000	DEC	0
10		"InstCalcVeloLength".statHscCount.CurrentCount		DEC	0
11		"InstCalcVeloLength".statHscCount.CapturedCount		DEC	4621
12		"InstCalcVeloLength".statHscCount.EnHSC		Bool	<input checked="" type="checkbox"/> TRUE
13		"InstCalcVeloLength".statHscCount.EnCapture		Bool	<input checked="" type="checkbox"/> TRUE
14		"InstCalcVeloLength".statHscCount.EnCV		Bool	<input type="checkbox"/> FALSE
15		"InstCalcVeloLength".statHscCount.NewCurrentCount		DEC	0
16		// Calculation			
17		"Data".lightBarrierDistance		Floating-point number	73.66
18		"InstCalcVeloLength".statLengthPerPulse		Floating-point number	0.01594027
19		"InstCalcVeloLength".statLastGateCount		DEC	10137
20		"Data".partVelocity		Floating-point number	1.594027
21		"Data".partLength		Floating-point number	0.1615866
22		// Status			
23		"Data".statusID		DEC	0
24		"Data".status		Hex	16#0000
25		// OB1 "Main" cycle time			
26		"Data".slowDownSwitch		Bool	<input type="checkbox"/> FALSE
27		"Data".lastTime		Floating-point number	16#0000_000A_D1EF_66FC
28		"Data".lastCycleTime		Floating-point number	1.16024

© Siemens AG 2018 All rights reserved

### 2.4.2 HMI

You can display the measured values using the SIMATIC HMI KTP 700 Basic PN or its simulation in the TIA Portal.

**Note**

For simulation in the TIA Portal, you must set the PC/PC interface (Set PC/PC Interface (32-bit)) in the Windows Control Panel as follows:

- Access point of the application: "S7ONLINE (STEP 7)"
- Interface Parameter Assignment Used: <Your network card> (Parameter assignment of your NDIS-CP with TCP/IP protocol (RFC-1006)) (Parameter assignment of your NDIS-CP with TCP/IP protocol (RFC-1006))

Figure 2-18

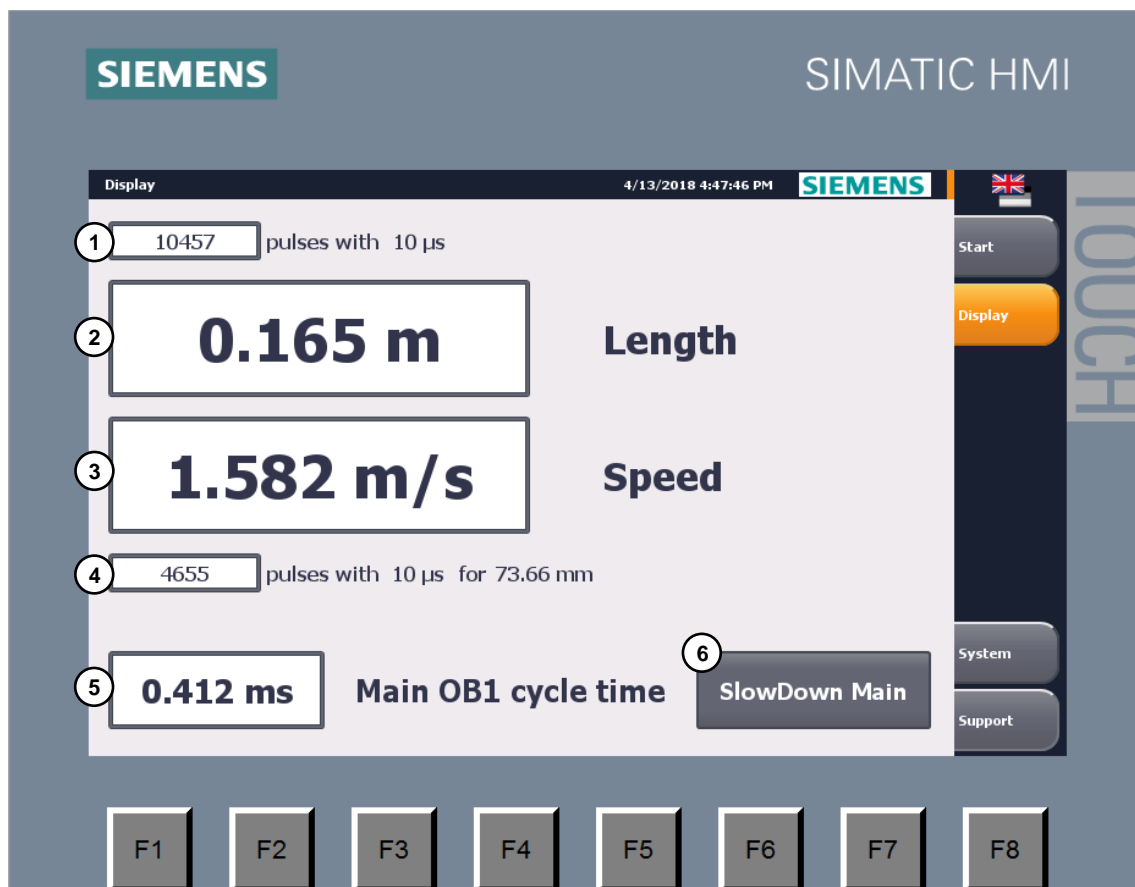

In addition to the calculated length and velocity of the pencil, the number of pulses over a period of  $10 \mu\text{s}$  is displayed.

The following variables are displayed:

1. Measured number of pulses during the darkening of the "Gate" light barrier over a period of  $10 \mu\text{s}$  (see PWM signal configuration -> Chapter [2.2.1](#))
2. Pencil length
3. Pencil speed
4. Measured number of pulses for the path ("distance" parameter -> Chapter [2.3](#)) from the "Gate" light barrier to the "Capture" light barrier over a period of  $10 \mu\text{s}$  (see PWM signal configuration -> Chapter [2.2.1](#)) to calculate the speed
5. Cycle time of the calling OB1 "Main"
6. Button for extending the cycle time of the OB1 "Main" (as proof that the configured events of the high-speed counter function independently of the cycle time of the calling organization block)

## 2.5 Errorconsideration

### 2.5.1 Inclined plane

The pencil is accelerated evenly on the inclined plane. Therefore, the measured speed when the pencil tip reaches the capture light barrier ( $t_1$ ) is lower than when the gate light barrier is exited ( $t_2$ ). Thus, the measured length of the pencil is less than the actual length ( $l = v * t$ ).

Figure 2-19

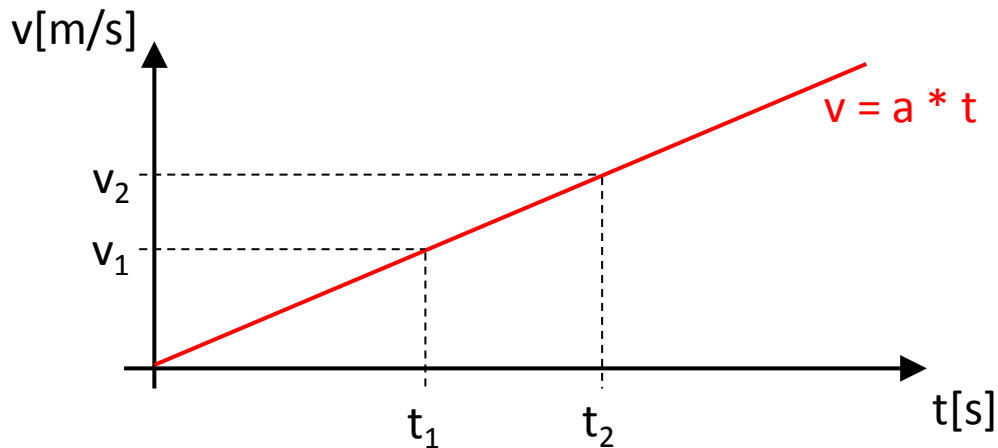

### 2.5.2 Eddy current brake

An eddy current brake is suitable for maintaining a constant speed of the pencil on the inclined plane. For this purpose, a small magnet is stuck to the pencil with adhesive tape. The magnet must fit in the guide of the aluminum rail, but does not touch it. The polar alignment (north-south) of the magnet is parallel to the guide in the direction of movement.

Figure 2-20

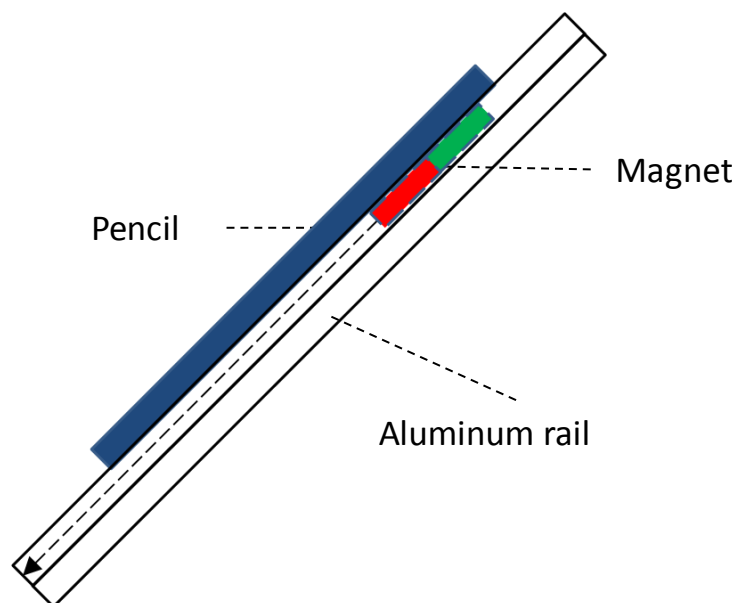

If the magnet is moved along the aluminum profile, a magnetic field is generated in the electrically conductive aluminum in accordance with Lenz's law, which counteracts that of the magnet. This results in an approximately constant speed of the pencil ([9](#)).

### 2.5.3 Acceleration by tensioning device

The tensioning device consists of a cross brace with two screws at the ends. A cord with two rubber sealing rings is tightened across the two screws. In this "bow", the slotted round wood peg is pulled like an "arrow" and converts the potential tension energy of the rubbers into kinetic energy upon release. This achieves a much higher speed of the pencil. The proportionate gravitational acceleration which also acts here has only a smaller influence on the speed measurement of the pencil due to the higher speed.

### 3 Useful information

#### 3.1 Details on functionality

##### 3.1.1 Dimensions

Figure 3-1

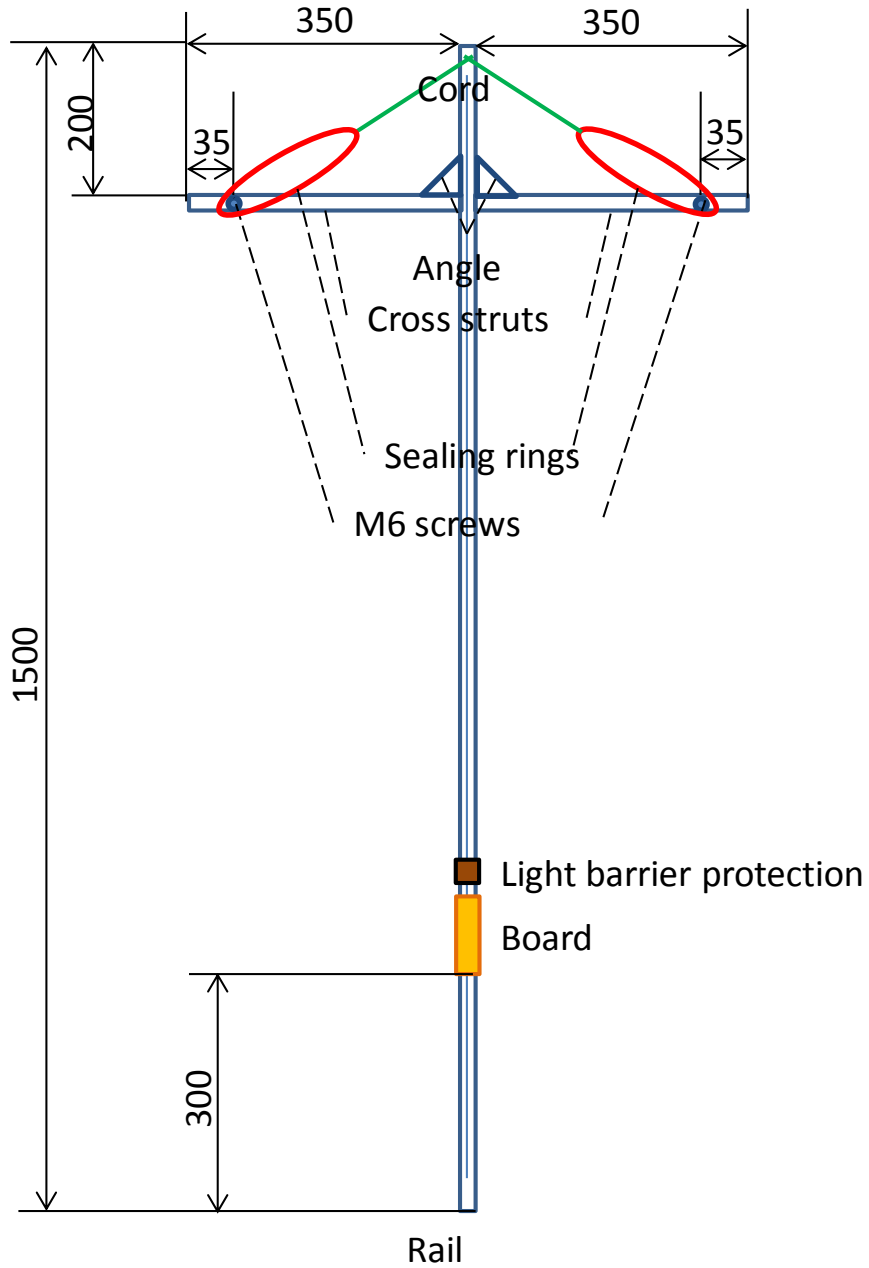

### 3.1.2 Strip board assembly

Figure 3-2

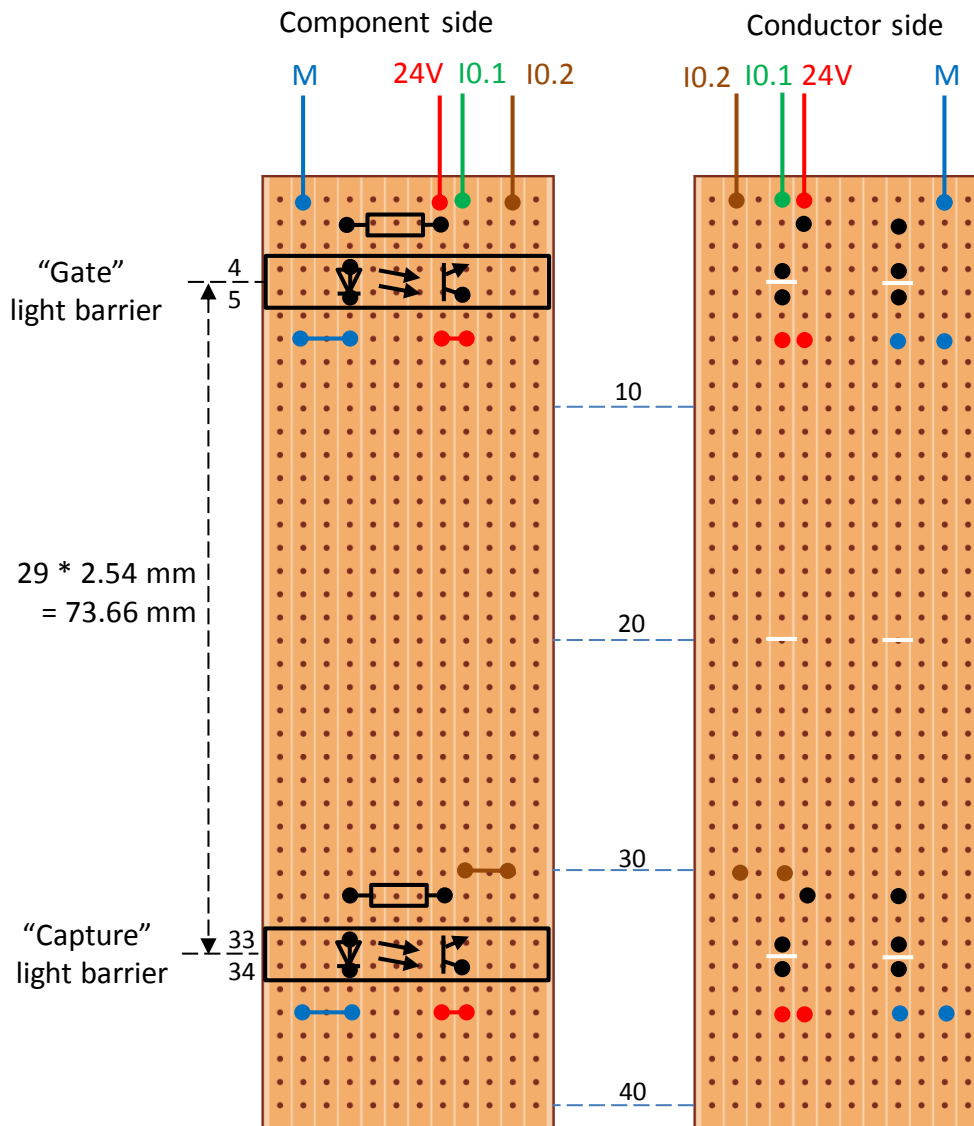

© Siemens AG 2018 All rights reserved

## 3.2 Basics

### 3.2.1 High-speed counters



The high-speed counters are internal hardware counters and thus much faster than software counters. The speed is limited by the inputs used.

#### Inputs

The SIMATIC S7-1200 offers the following inputs for the acquisition of signals via six configurable high-speed counters:

### 3 Useful information

Table 3-1

Max. counting frequency	Inputs	Screen
1 MHz	Differential inputs (RS422/RS485) of the CPU 1217C (Eb.2 to Eb.5)	
200 kHz	Signal board inputs SB 1221 4DI 24V 200KHz SB 1221 4DI 5V 200KHz SB 1223 2DI/2DQ 24V 200KHz SB 1223 2DI/2DQ 5V 200KHz	
100 kHz*	Internal onboard inputs of all CPUs (Ea.0 to Ea.5)	
30 kHz	Other onboard inputs of CPUs 1212C to 1217C (from Ea.6 to max Eb.5)	

\* Selected variant

#### Note

An [introduction to the S7-1200](#) can be found in the "SIMATIC S7 S7-1200 Automation System" manual ([\3](#)).

#### Gate

The gate input enables the high-speed counter. Depending on the configuration, the gate input can block or enable counting. Pulses arriving at the count entrance are counted only when the gate is open.

Figure 3-3

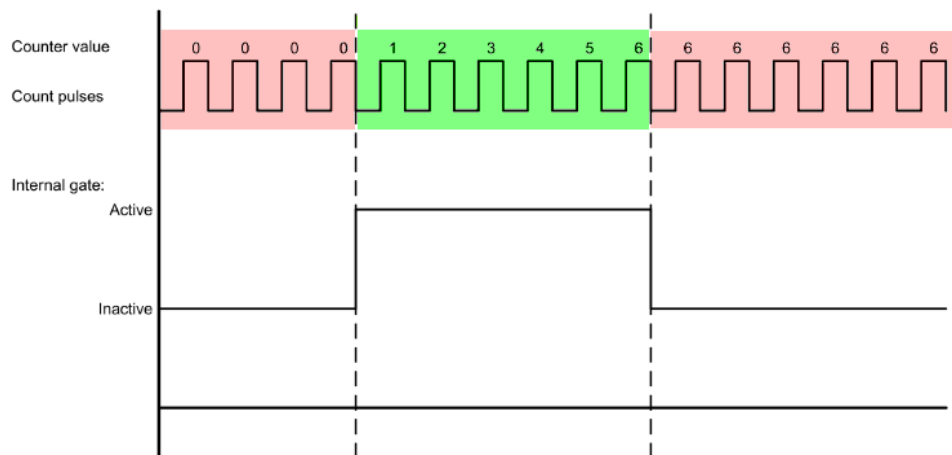

**Application Example: Length measurement of objects on a conveyor belt**

The pulses of an incremental encoder are counted as long as a light barrier (or a proximity switch) detects an object. From the number of pulses, the length of an object is calculated using a known travel length per pulse.

Figure 3-4: Determining length with HW gate

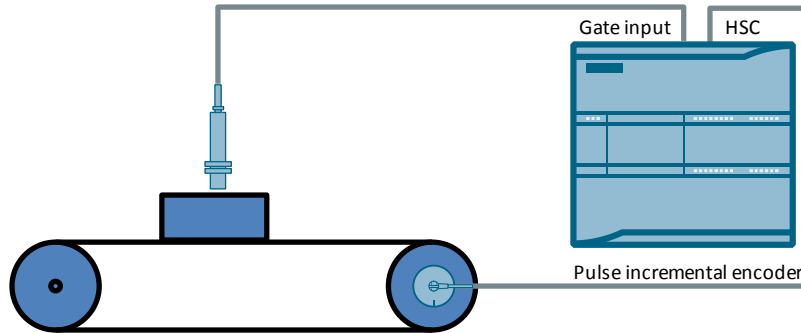

**Note**

This use case is presented in detail in the [Application Examples for High-Speed Counters \(HSC\) of the S7-1200 \(4\)](#).

**Capture**

The capture input "Capture" saves the current counter value. Thus, while the gate is open, the continuous counter value can be recorded and written in "HSC\_Count.CapturedCount" in the event of an external input edge. Evaluation can then be done separately and be temporally decoupled in the cyclic organization block.

**Application Example: Speed and length measurement of objects**

In addition to the detection of the length via the gate input, the speed is determined using the detection input and the distance of the light barriers.

Figure 3-5: Determine length and speed with HW-Gate and HW-Capture

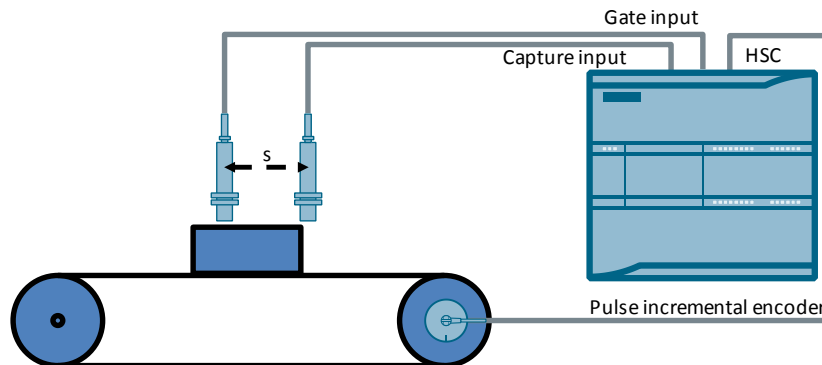

$$v = s / t_{\text{Capture}}$$

$$t_{\text{Capture}} = n_{\text{Capture}} * T_{\text{Pulse}}$$

$$v = s / (n_{\text{Capture}} * T_{\text{Pulse}})$$
  

$$l = v * t_{\text{Gate}}$$

$$t_{\text{Gate}} = n_{\text{Gate}} * T_{\text{Pulse}}$$

$$l = v * n_{\text{Gate}} * T_{\text{Pulse}}$$

$$l = s * n_{\text{Gate}} / n_{\text{Capture}}$$



**Note** The prerequisite for this is a constant speed of movement and the length of the object must be at least equal to the distance between the light barriers!

### 3.2.2 PWM (Pulse Width Modulation)

The SIMATIC S7-1200 has four configurable pulse generators that can output the following:





- Pulse trains (fixed duty cycle, varying period) or
- PWM signals (fixed period, varying duty cycle)

The speed is limited by the outputs used.

#### Outputs

The SIMATIC S7-1200 offers the following DC outputs for pulse generation:

Table 3-2

Max. pulse rate	Inputs	Screen
1 MHz	Differential outputs (RS422/RS485) of the CPU 1217C (Aa.0 to Aa.3)	
200 kHz	Signal board outputs SB 1222 4DQ 24V 200KHz SB 1222 4DQ 5V 200KHz SB 1223 2DI/2DQ 24V 200KHz SB 1223 2DI/2DQ 5V 200KHz	
100 kHz*	Onboard outputs of <ul style="list-style-type: none"> <li>• CPUs 1211C – 1215C (Aa.0 to Aa.3)</li> <li>• CPU 1217C (Aa.4 to Ab.1)</li> </ul>	
20 kHz	Onboard outputs of <ul style="list-style-type: none"> <li>• CPU 1212C (Aa.4 to Aa.5)</li> <li>• CPUs 1214C – 1215C (Aa.4 to Ab.1)</li> </ul>	

\* Selected variant

**Note** An [introduction to the S7-1200](#) can be found in the "SIMATIC S7 S7-1200 Automation System" manual ([\3](#)).

For CPU versions with relay outputs, you must install a digital signal board (SB) to use the pulse outputs.

## 4 Appendix

### Industry Online Support

Do you have any questions or need assistance?

Siemens Industry Online Support offers round the clock access to our entire service and support know-how and portfolio.

The Industry Online Support is the central address for information about our products, solutions and services.

Product information, manuals, downloads, FAQs, application examples and videos – all information is accessible with just a few mouse clicks:

<https://support.industry.siemens.com>

### Technical Support

The Technical Support of Siemens Industry provides you fast and competent support regarding all technical queries with numerous tailor-made offers – ranging from basic support to individual support contracts. Please send queries to Technical Support via Web form:

[www.siemens.com/industry/supportrequest](http://www.siemens.com/industry/supportrequest)

### SITRAIN – Training for Industry

We support you with our globally available training courses for industry with practical experience, innovative learning methods and a concept that's tailored to the customer's specific needs.

For more information on our offered trainings and courses, as well as their locations and dates, refer to our web page:

[www.siemens.com/sitrain](http://www.siemens.com/sitrain)

### Service offer

Our range of services includes the following:

- Plant data services
- Spare parts services
- Repair services
- On-site and maintenance services
- Retrofitting and modernization services
- Service programs and contracts

You can find detailed information on our range of services in the service catalog web page:

<https://support.industry.siemens.com/cs/sc>

### Industry Online Support app

You will receive optimum support wherever you are with the "Siemens Industry Online Support" app. The app is available for Apple iOS, Android and Windows Phone:

<https://support.industry.siemens.com/cs/ww/en/sc/2067>

## 4.1 Links and Literature

Table 4-1

No.	Topic
\1\	Siemens Industry Online Support <a href="https://support.industry.siemens.com">https://support.industry.siemens.com</a>
\2\	Link to the entry page for the Application Example <a href="https://support.industry.siemens.com/cs/ww/en/view/109754525">https://support.industry.siemens.com/cs/ww/en/view/109754525</a>
\3\	SIMATIC S7-1200 Automation System System Manual <a href="https://support.industry.siemens.com/cs/ww/en/view/109741593">https://support.industry.siemens.com/cs/ww/en/view/109741593</a>
\4\	S7-1200: Application Examples for high-speed counter <a href="https://support.industry.siemens.com/cs/ww/en/view/109742346">https://support.industry.siemens.com/cs/ww/en/view/109742346</a>
\5\	Basic Controller: Technology Integrated Measuring length and speed with SIMATIC S7-1200 <a href="https://www.youtube.com/watch?v=eB-k6HW58xA">https://www.youtube.com/watch?v=eB-k6HW58xA</a>
\6\	Updates for STEP 7 V15 and WinCC V15 <a href="https://support.industry.siemens.com/cs/ww/en/view/109755826">https://support.industry.siemens.com/cs/ww/en/view/109755826</a>
\7\	Firmware update for CPU 1211C, DC/DC/DC, 6DI/4DO/2AI <a href="https://support.industry.siemens.com/cs/ww/en/view/107247170">https://support.industry.siemens.com/cs/ww/en/view/107247170</a>
\8\	Optek forked light barrier OPB815L, phototransistor output, screw mounting, 4 pin <a href="https://de.rs-online.com/web/p/gabel-lichtschranke/1944024/">https://de.rs-online.com/web/p/gabel-lichtschranke/1944024/</a>
\9\	WIKIPEDIA: Lenz's law <a href="https://en.wikipedia.org/wiki/Lenz%27s_law">https://en.wikipedia.org/wiki/Lenz%27s_law</a>

## 4.2 Change documentation

Table 4-2

Version	Date	Change
V1.0	06/2018	First edition