

SIEMENS

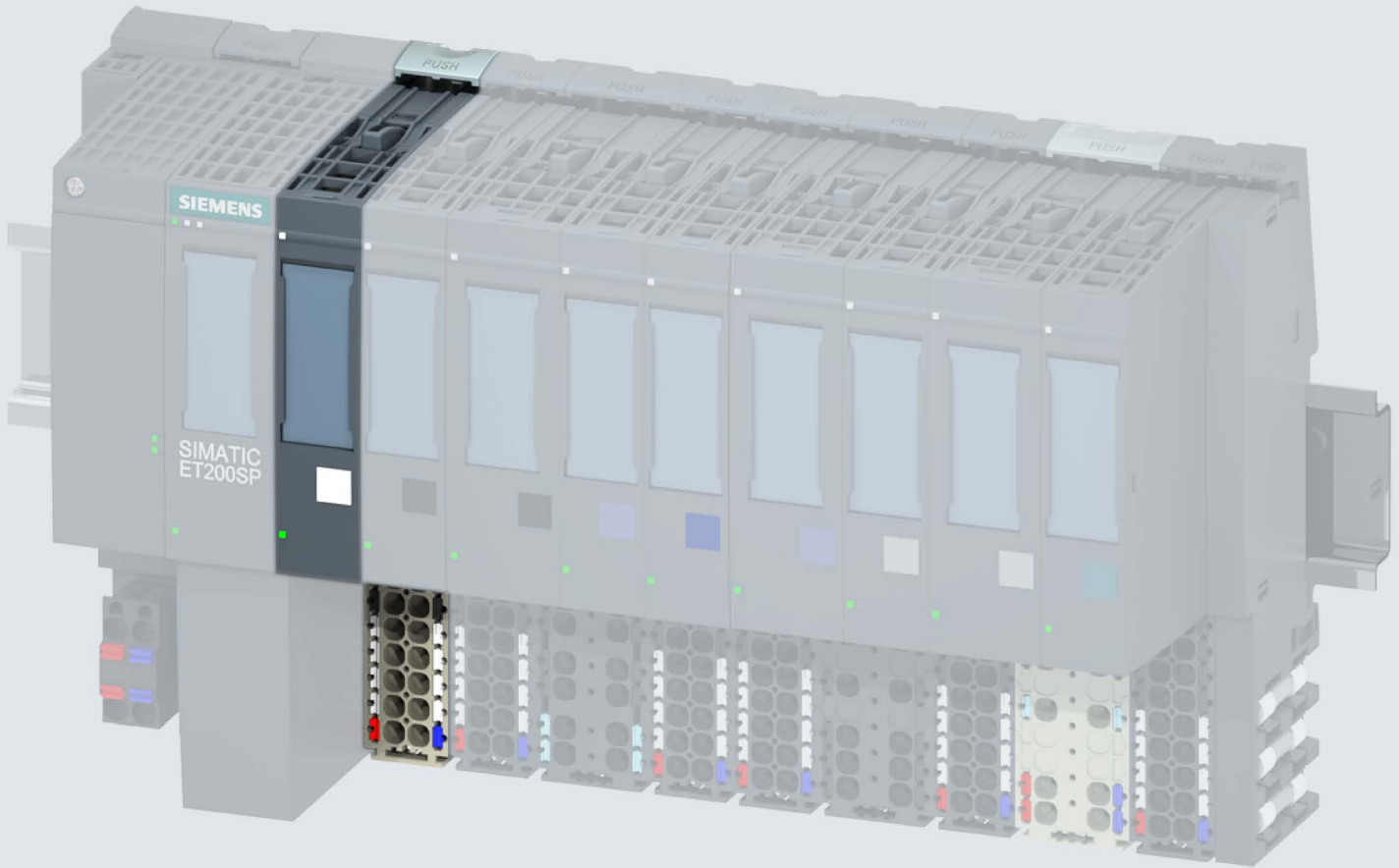

Manual

SIMATIC

ET 200SP

Digital input module
DI 16x24VDC ST (6ES7131-6BH01-0BA0)

Edition

02/2019

support.industry.siemens.com

SIEMENS

SIMATIC

ET 200SP
Digital input module
DI 16x24VDC ST
(6ES7131-6BH01-0BA0)

Manual

Preface

Documentation guide

1

Product overview

2

Connecting

3

Parameters/address space

4

Interrupts/diagnostic alarms

5

Technical specifications

6



Parameter data record

A

Legal information

Warning notice system

This manual contains notices you have to observe in order to ensure your personal safety, as well as to prevent damage to property. The notices referring to your personal safety are highlighted in the manual by a safety alert symbol, notices referring only to property damage have no safety alert symbol. These notices shown below are graded according to the degree of danger.

 DANGER
indicates that death or severe personal injury will result if proper precautions are not taken.
 WARNING
indicates that death or severe personal injury may result if proper precautions are not taken.
 CAUTION
indicates that minor personal injury can result if proper precautions are not taken.
NOTICE
indicates that property damage can result if proper precautions are not taken.

If more than one degree of danger is present, the warning notice representing the highest degree of danger will be used. A notice warning of injury to persons with a safety alert symbol may also include a warning relating to property damage.

Qualified Personnel

The product/system described in this documentation may be operated only by **personnel qualified** for the specific task in accordance with the relevant documentation, in particular its warning notices and safety instructions. Qualified personnel are those who, based on their training and experience, are capable of identifying risks and avoiding potential hazards when working with these products/systems.

Proper use of Siemens products

Note the following:

 WARNING
Siemens products may only be used for the applications described in the catalog and in the relevant technical documentation. If products and components from other manufacturers are used, these must be recommended or approved by Siemens. Proper transport, storage, installation, assembly, commissioning, operation and maintenance are required to ensure that the products operate safely and without any problems. The permissible ambient conditions must be complied with. The information in the relevant documentation must be observed.

Trademarks

All names identified by ® are registered trademarks of Siemens AG. The remaining trademarks in this publication may be trademarks whose use by third parties for their own purposes could violate the rights of the owner.

Disclaimer of Liability

We have reviewed the contents of this publication to ensure consistency with the hardware and software described. Since variance cannot be precluded entirely, we cannot guarantee full consistency. However, the information in this publication is reviewed regularly and any necessary corrections are included in subsequent editions.

Preface

Purpose of the documentation

This manual supplements the system manual ET 200SP distributed I/O system (<http://support.automation.siemens.com/WW/view/en/58649293>).

Functions that generally relate to the system are described in this manual.

The information provided in this manual and in the system/function manuals supports you in commissioning the system.

Changes compared to previous version

Compared to the previous version, this manual contains the following change:

Technical specifications: Ambient temperature in horizontal and vertical mounting position, extended to min. -30 °C.

Conventions

CPU: When the term "CPU" is used in this manual, it applies to the CPUs of the S7-1500 automation system as well as to the CPUs/interface modules of the distributed I/O system ET 200SP.

STEP 7: In this documentation, "STEP 7" is used as a synonym for all versions of the configuration and programming software "STEP 7 (TIA Portal)".

Please also observe notes marked as follows:

Note

A note contains important information on the product described in the documentation, on the handling of the product or on the section of the documentation to which particular attention should be paid.

Security information

Siemens provides products and solutions with industrial security functions that support the secure operation of plants, systems, machines and networks.

In order to protect plants, systems, machines and networks against cyber threats, it is necessary to implement – and continuously maintain – a holistic, state-of-the-art industrial security concept. Siemens' products and solutions constitute one element of such a concept.

Customers are responsible for preventing unauthorized access to their plants, systems, machines and networks. Such systems, machines and components should only be connected to an enterprise network or the internet if and to the extent such a connection is necessary and only when appropriate security measures (e.g. firewalls and/or network segmentation) are in place.

For additional information on industrial security measures that can be implemented, please visit (<http://www.siemens.com/industrialsecurity>).

Siemens' products and solutions undergo continuous development to make them more secure. Siemens strongly recommends that product updates are applied as soon as they are available and that the latest product versions are used. Use of product versions that are no longer supported, and failure to apply the latest updates may increase customers' exposure to cyber threats.

To stay informed about product updates, subscribe to the Siemens Industrial Security RSS Feed visit (<http://www.siemens.com/industrialsecurity>).

Table of contents

	Preface	3
1	Documentation guide	6
2	Product overview	11
	2.1 Properties	11
3	Connecting	13
	3.1 Wiring and block diagram	13
4	Parameters/address space	16
	4.1 Parameters	16
	4.2 Declaration of parameters	18
	4.3 Address space	19
5	Interrupts/diagnostic alarms	21
	5.1 Status and error display	21
	5.2 Interrupts	23
	5.3 Diagnostic messages	23
6	Technical specifications	24
	6.1 Technical specifications	24
A	Parameter data record	28
	A.1 Parameter assignment and structure of parameter data record	28

Documentation guide

The documentation for the SIMATIC ET 200SP distributed I/O system is arranged into three areas.

This arrangement enables you to access the specific content you require.

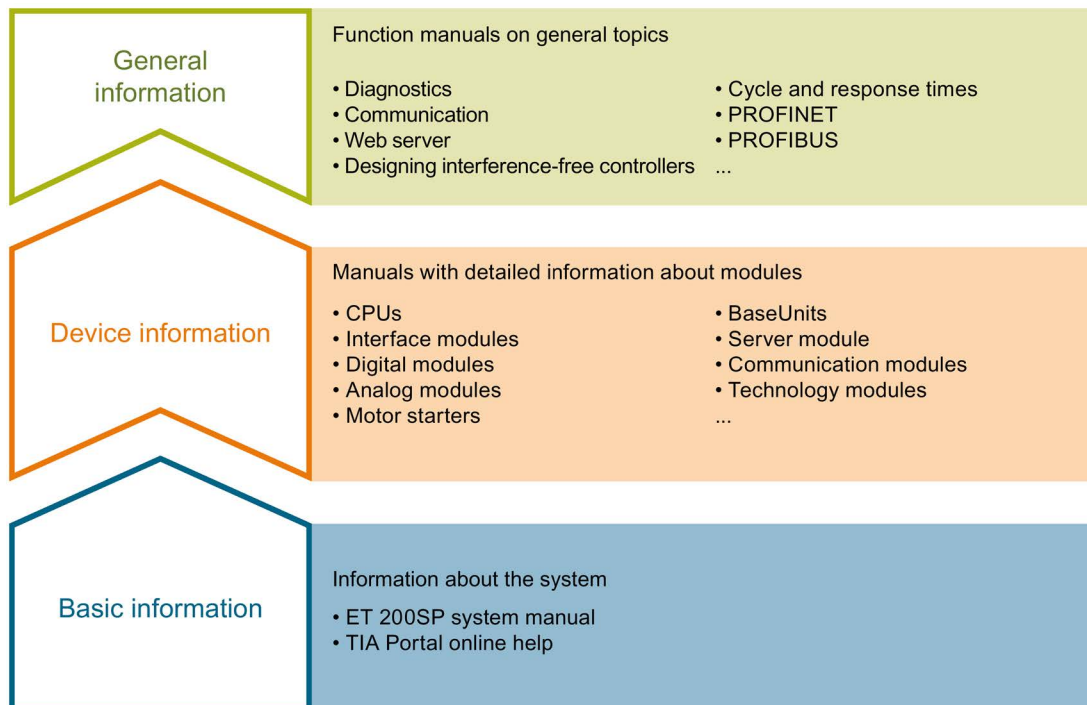

Basic information

The system manual describes in detail the configuration, installation, wiring and commissioning of the SIMATIC ET 200SP. distributed I/O system. The STEP 7 online help supports you in the configuration and programming.

Device information

Product manuals contain a compact description of the module-specific information, such as properties, wiring diagrams, characteristics and technical specifications.

General information

The function manuals contain detailed descriptions on general topics regarding the SIMATIC ET 200SP distributed I/O system, e.g. diagnostics, communication, Web server, motion control and OPC UA.

You can download the documentation free of charge from the Internet (<https://support.industry.siemens.com/cs/ww/en/view/109742709>).

Changes and supplements to the manuals are documented in a Product Information.

You can download the product information free of charge from the Internet (<https://support.industry.siemens.com/cs/us/en/view/73021864>).

Manual Collection ET 200SP

The Manual Collection contains the complete documentation on the SIMATIC ET 200SP distributed I/O system gathered together in one file.

You can find the Manual Collection on the Internet (<https://support.automation.siemens.com/WWW/view/en/84133942>).

"mySupport"

With "mySupport", your personal workspace, you make the most of your Industry Online Support.

In "mySupport" you can store filters, favorites and tags, request CAx data and put together your personal library in the Documentation area. Furthermore, your data is automatically filled into support requests and you always have an overview of your current requests.

You need to register once to use the full functionality of "mySupport".

You can find "mySupport" in the Internet (<https://support.industry.siemens.com/My/ww/en>).

"mySupport" - Documentation

In the Documentation area of "mySupport", you have the possibility to combine complete manuals or parts of them to make your own manual.

You can export the manual in PDF format or in an editable format.

You can find "mySupport" - Documentation in the Internet (<https://support.industry.siemens.com/My/ww/en/documentation>).

"mySupport" - CAx Data

In the CAx Data area of "mySupport", you can have access the latest product data for your CAx or CAe system.

You configure your own download package with a few clicks.

In doing so you can select:

- Product images, 2D dimension drawings, 3D models, internal circuit diagrams, EPLAN macro files
- Manuals, characteristics, operating manuals, certificates
- Product master data

You can find "mySupport" - CAx Data in the Internet (<https://support.industry.siemens.com/my/ww/en/CAxOnline>).

Application examples

The application examples support you with various tools and examples for solving your automation tasks. Solutions are shown in interplay with multiple components in the system - separated from the focus in individual products.

You can find the application examples on the Internet (<https://support.industry.siemens.com/sc/ww/en/sc/2054>).

TIA Selection Tool

With the TIA Selection Tool, you can select, configure and order devices for Totally Integrated Automation (TIA).

This tool is the successor of the SIMATIC Selection Tool and combines the known configurators for automation technology into one tool.

With the TIA Selection Tool, you can generate a complete order list from your product selection or product configuration.

You can find the TIA Selection Tool on the Internet (<https://w3.siemens.com/mcms/topics/en/simatic/tia-selection-tool>).

SIMATIC Automation Tool

You can use the SIMATIC Automation Tool to run commissioning and maintenance activities simultaneously on various SIMATIC S7 stations as a bulk operation independently of the TIA Portal.

The SIMATIC Automation Tool provides a multitude of functions:

- Scanning of a PROFINET/Ethernet network and identification of all connected CPUs
- Address assignment (IP, subnet, gateway) and station name (PROFINET device) to a CPU
- Transfer of the data and the programming device/PC time converted to UTC time to the module
- Program download to CPU
- Operating mode switchover RUN/STOP
- Localization of the CPU by means of LED flashing
- Reading out CPU error information
- Reading the CPU diagnostic buffer
- Reset to factory settings
- Updating the firmware of the CPU and connected modules

You can find the SIMATIC Automation Tool on the Internet (<https://support.industry.siemens.com/cs/ww/en/view/98161300>).

PRONETA

With SIEMENS PRONETA (PROFINET network analysis), you analyze the plant network during commissioning. PRONETA features two core functions:

- The topology overview independently scans PROFINET and all connected components.
- The IO check is a fast test of the wiring and the module configuration of a system.

You can find SIEMENS PRONETA on the Internet (<https://support.industry.siemens.com/cs/ww/en/view/67460624>).

SINETPLAN

SINETPLAN, the Siemens Network Planner, supports you in planning automation systems and networks based on PROFINET. The tool facilitates professional and predictive dimensioning of your PROFINET installation as early as in the planning stage. In addition, SINETPLAN supports you during network optimization and helps you to exploit network resources optimally and to plan reserves. This helps to prevent problems in commissioning or failures during productive operation even in advance of a planned operation. This increases the availability of the production plant and helps improve operational safety.

The advantages at a glance

- Network optimization thanks to port-specific calculation of the network load
- Increased production availability thanks to online scan and verification of existing systems
- Transparency before commissioning through importing and simulation of existing STEP 7 projects
- Efficiency through securing existing investments in the long term and optimal exploitation of resources

You can find SINETPLAN on the Internet (<https://www.siemens.com/sinetplan>).

Product overview

2.1 Properties

Article number

6ES7131-6BH01-0BA0 (number in package unit: 1 unit)

6ES7131-6BH01-2BA0 (number in package unit: 10 units)

View of the module

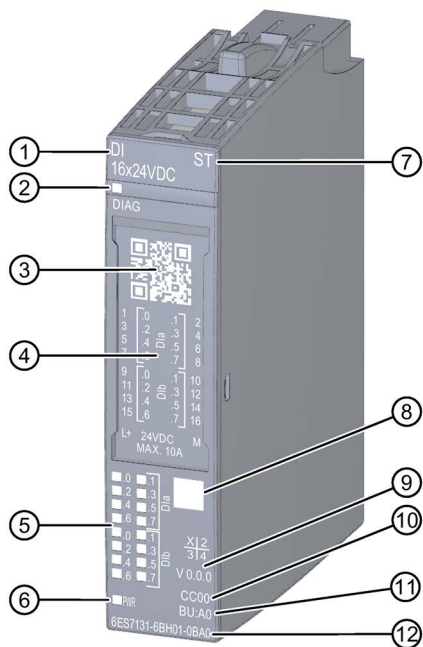

- | | |
|---------------------------|--|
| ① Module type and name | ⑦ Function class |
| ② LED for diagnostics | ⑧ Color coding module type |
| ③ 2D matrix code | ⑨ Function and firmware version |
| ④ Wiring diagram | ⑩ Color code for selecting the color identification labels |
| ⑤ LEDs for channel status | ⑪ BU type |
| ⑥ LED for supply voltage | ⑫ Article number |

Figure 2-1 View of the module DI 16×24VDC ST

Properties

The module has the following technical properties:

- Digital input module with 16 inputs
- Sink input, (PNP, P-reading)
- Supply voltage L+
- Configurable input delay 0.05 to 20 ms (per channel)
- Configurable diagnostics (per module)
- Suitable for connection of switches and 2-wire sensors in accordance with IEC 61131, type 3

The module supports the following functions:

Table 2- 1 Version dependencies of the functions

Function	HW version	FW version	STEP 7		GSD file	
			TIA Portal	V5.x	PROFINET IO	PROFIBUS DP
Identification data I&M0 to I&M3	FS01	V0.0.0 and higher	V14 or higher with HSP 0222	V5.5 SP3 or higher with HSP 0229 V7.0	X	X
Configuration in RUN	FS01	V0.0.0 and higher	V14 or higher with HSP 0222	V5.5 SP3 or higher with HSP 0229 V7.0	X	X
Value status	FS01	V0.0.0 and higher	V14 or higher with HSP 0222	V5.5 SP3 or higher with HSP 0229 V7.0	X	X

Accessories

The following accessories must be ordered separately:

- Labeling strips
- Color identification labels
- Reference identification label
- Shield connector

See also

You can find additional information on the accessories in the system manual ET 200SP distributed I/O system (<http://support.automation.siemens.com/WW/view/en/58649293>).

Connecting

3.1 Wiring and block diagram

This section includes the block diagram of the DI 16x24VDC ST module with the terminal assignments for a 1-wire connection.

Information on wiring the BaseUnit can be found in the system manual ET 200SP distributed I/O system (<http://support.automation.siemens.com/WW/view/en/58649293>).

Note

The load group of the module must begin with a light-colored BaseUnit. Keep this in mind also during the configuration.

Note

Make sure that you only use digital modules with BaseUnit type A0 during commissioning.

Wiring: 1-wire connection

The following figure shows the block diagram and an example of the terminal assignment of the digital input module DI 16x24VDC ST on the BaseUnit BU type A0 without AUX terminals (1-wire connection).

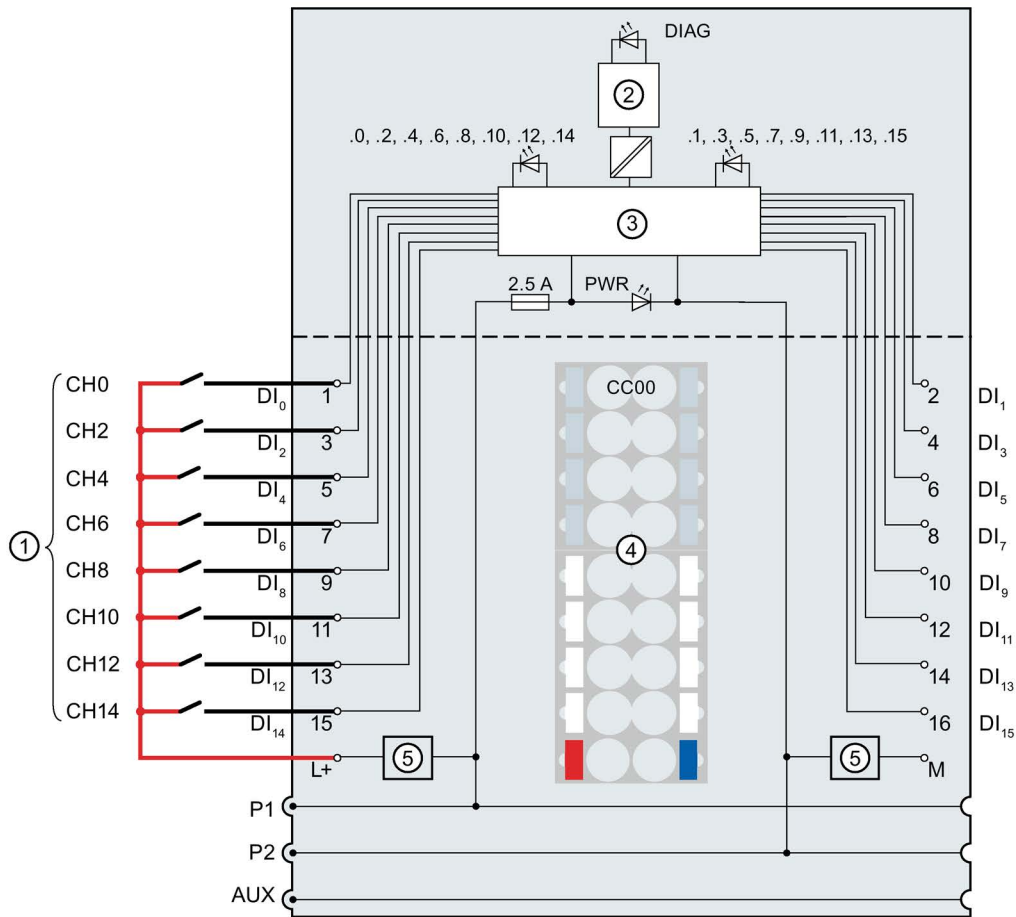

①	1-wire connection	DI _n	Input signal, channel n
②	Backplane bus interface	L+	24 V DC (infeed only with light-colored BaseUnit)
③	Input electronics	M	Ground
④	Color-coded label with color code CC00 (optional)	DIAG	Error or diagnostics LED (green, red)
⑤	Filter connection supply voltage (only when light-colored BaseUnit is present)	.0 to .15	Channel status LED (green)
P1, P2, AUX	Internal self-assembling voltage buses Connection to left (dark-colored BaseUnit) Connection to left interrupted (light-colored BaseUnit)	PWR	Power LED (green)

Figure 3-1 Wiring and block diagram for 1-wire connection of transducers

Wire-break detection

When wire-break detection is configured the module requires a low quiescent current at the digital input in case of "0" signal for the monitoring. The parallel connection of a resistor with 25 k Ω to 45 k Ω is required in order that this quiescent current can flow when mechanical transducer contacts are open.

If wire-break detection is disabled in the configuration, no parallel connection of the resistor is required.

If wire-break detection is configured, connect a resistor with 25 k Ω to 45 k Ω parallel to each mechanical transducer contact.

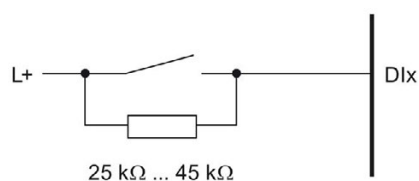

Figure 3-2 Connect mechanical transducer contact with resistor

Parameters/address space

4.1 Parameters

Parameters for DI 16x24VDC ST

Specify the module properties with the various parameters in the course of your STEP 7 configuration. The following table lists the configurable parameters. The effective range of the configurable parameters depends on the type of configuration.

The following configurations are possible:

- Central operation with an ET 200SP CPU
- Distributed operation on PROFINET IO in an ET 200SP system
- Distributed operation with PROFIBUS DP in an ET 200SP system

When assigning parameters in the user program, use the "WRREC" instruction to transfer the parameters to the module using the data records; refer to section Parameter assignment and structure of parameter data record (Page 28).

The following parameter settings are possible:

Table 4- 1 Configurable parameters and their defaults (GSD file)

Parameters	Range of values	Default	Parameter reassignment in RUN	Scope with configuration software, e.g. STEP 7 (TIA Portal)	
				GSD file PROFINET IO	GSD file PROFIBUS DP
Diagnostics: No supply voltage L+	<ul style="list-style-type: none"> • Disable • Enable 	Disable	Yes	Module	Module
Diagnostics Wire break	<ul style="list-style-type: none"> • Disable • Enable 	Disable	Yes	Module	Module
Channel activated	<ul style="list-style-type: none"> • Disable • Enable 	Enable	Yes	Channel	Channel

Parameters	Range of values	Default	Parameter reassignment in RUN	Scope with configuration software, e.g. STEP 7 (TIA Portal)	
				GSD file PROFINET IO	GSD file PROFIBUS DP
Input delay	<ul style="list-style-type: none"> • None • 0.05 ms • 0.1 ms • 0.4 ms • 0.8 ms • 1.6 ms • 3.2 ms • 12.8 ms • 20 ms 	3.2 ms	Yes	Channel	Module ¹
Potential group	<ul style="list-style-type: none"> • Use potential group of the left module (module plugged into a dark-colored BaseUnit) • Enable new potential group (module plugged into light-colored BaseUnit) 	Use potential group of the left module	No	Module	Module

² Due to the limited number of parameters of a maximum of 244 bytes per ET 200SP station with a PROFIBUS GSD configuration, the parameter assignment options are restricted. The parameter length of the I/O module is 4 bytes with PROFIBUS GSD configuration. If necessary, you can set this parameter by using the data record 128, see the appendix "Parameter data record".

4.2 Declaration of parameters

Diagnostics: No supply voltage L+

Enabling of the diagnostics for no or insufficient supply voltage L+.

Diagnostics: Wire break

Enabling diagnostics if the line to the encoder is interrupted.

Channel activated

Determines whether a channel is activated or deactivated.

Input delay

This parameter can be used to suppress signal interference. Changes to the signal are only detected if they are constantly pending longer than the set input delay time.

Potential group

A potential group consists of a group of directly adjacent I/O modules within an ET 200SP station, which are supplied via a common supply voltage.

A potential group begins with a light-colored BaseUnit through which the required voltage is supplied for all modules of the potential group. The light-colored BaseUnit interrupts the three self-assembling voltage buses P1, P2 and AUX to the left neighbor.

All additional I/O modules of this potential group are plugged into dark-colored BaseUnits. You take the potential of the self-assembling voltage buses P1, P2 and AUX from the left neighbor.

A potential group ends with the dark-colored BaseUnit, which follows a light-colored BaseUnit or server module in the station configuration.

4.3 Address space

The module can be configured differently in STEP 7; see following table. Depending on the configuration, additional/different addresses are assigned in the process image input.

Configuration options of DI 16x24VDC ST

You can configure the module with STEP 7 (TIA Portal) or with a GSD file. If you configure the module by means of a GSD file, the configurations are available under various short designations/module names; see the table below. The following configurations are possible:

Table 4- 2 Configuration options with GSD file

Configuration	Short designation/module name in the GSD file	Configuration software, e.g. with STEP 7 (TIA Portal)		
		Integrated in hardware catalog STEP 7	GSD file PROFINET IO	GSD file PROFIBUS DP
1 x 16-channel without value status	DI 16x24VDC ST V0.0	V14, SP1 or higher with HSP 0222	X	X
1 x 16-channel with value status	DI 16x24VDC ST V0.0, QI	V14, SP1 or higher with HSP 0222	X	---

Evaluating the value status

An additional two bytes are allocated in the input address space if you enable the value status for the digital module. Bits 0 to 15 in these bytes are assigned to a channel. They provide information about the validity of the digital value.

Bit = 1: No fault is present on the channel.

Bit = 0: Channel is deactivated or there is a fault on the module.

If a fault occurs on a channel with this module, the value status for all channels is 0.

4.3 Address space

Address space

The following figure shows the assignment of the address space for the DI 16x24VDC ST with value status (Quality Information (QI)). The addresses for the value status are only available if the value status is enabled.

Assignment in the process image input (PII)

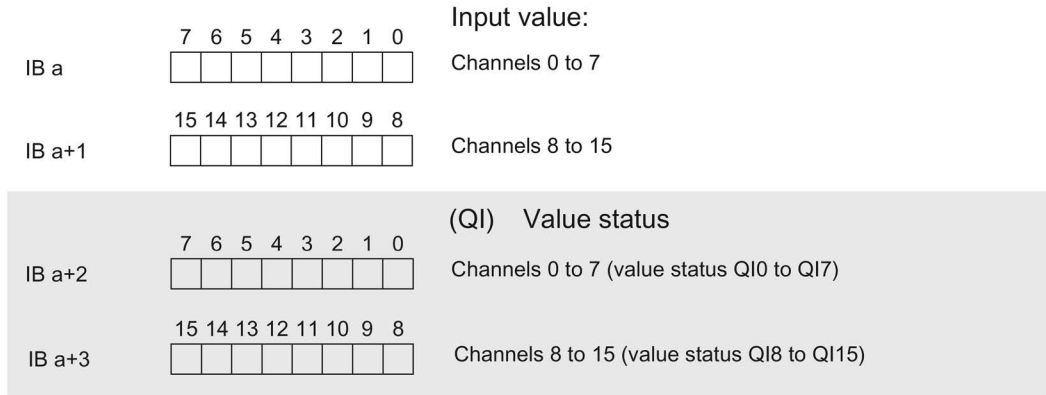

Figure 4-1 Address space of the DI 16x24VDC ST with value status

Interrupts/diagnostic alarms

5.1 Status and error display

LED display

The figure below shows the LED displays (status and error displays) of the DI 16x24VDC ST.

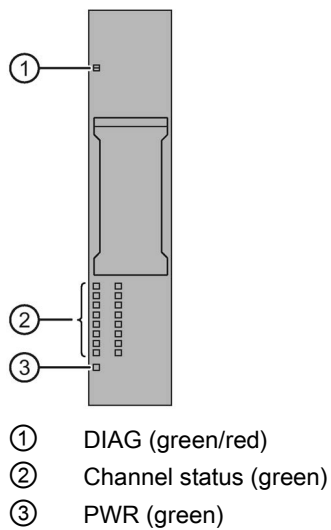





Figure 5-1 LED display

Meaning of the LEDs

The following tables show the meaning of the status and error displays. Corrective measures for diagnostics alarms can be found in section Diagnostic messages (Page 23).

DIAG LED

Table 5- 1 Error display of the DIAG LED

DIAG LED	Meaning
 Off	Backplane bus supply of the ET 200SP not OK
 Flashes	Module parameters not assigned
 On	Module parameters assigned
 Flashes	Module diagnostics is available



Channel status LED

Table 5- 2 Status display of the channel status LED

Channel status LED	Meaning
 Off	Process signal = 0
 On	Process signal = 1

PWR LED

Table 5- 3 Status display of the PWR LED

PWR LED	Meaning
 Off	Missing supply voltage L+
 On	Supply voltage L+ present

5.2 Interrupts

The DI 16x24VDC ST digital input module supports diagnostic interrupts.

Diagnostics interrupts

The module generates a diagnostic interrupt at the following events:

- Wire break
- Parameter assignment error
- Supply voltage missing

5.3 Diagnostic messages

A diagnostics alarm is generated and the DIAG-LED flashes on the module for each diagnostics event. You can read out the diagnostics alarms, for example, in the diagnostics buffer of the CPU. You can evaluate the error codes with the user program.

Table 5- 4 Diagnostics alarms, their meaning and corrective measures

Diagnosics alarm	Error code	Meaning	Solution
Wire break	6H	Impedance of transducer circuit too high.	Use a different transducer type or modify the wiring, for example, use cables with larger cross-section
		Wire break between the module and sensor	Connect the cable
		Channel not connected (open)	<ul style="list-style-type: none"> • Disable diagnostics • Connect a resistor of 25 kilohms to 45 kilohms to the transducer contacts
Parameter assignment error	10H	<ul style="list-style-type: none"> • The module cannot evaluate parameters for the channel. • Incorrect parameter assignment. 	Correct the parameter assignment
Supply voltage missing	11H	Missing or insufficient supply voltage L+	<ul style="list-style-type: none"> • Check supply voltage L+ on the BaseUnit • Check BaseUnit type

Technical specifications

6.1 Technical specifications

Technical specifications of the DI 16x24VDC ST

The following table shows the technical specifications as of 02/2019. You will find a data sheet including daily updated technical specifications on the Internet (<https://support.industry.siemens.com/cs/ww/en/pv/6ES7131-6BH01-0BA0/td?dl=en>).

Article number	6ES7131-6BH01-0BA0
General information	
Product type designation	DI 16x24VDC ST
HW functional status	From FS02
Firmware version	V0.0
<ul style="list-style-type: none"> FW update possible 	No
usable BaseUnits	BU type A0
Color code for module-specific color identification plate	CC00
Product function	
<ul style="list-style-type: none"> I&M data 	Yes; I&M0 to I&M3
Engineering with	
<ul style="list-style-type: none"> STEP 7 TIA Portal configurable/integrated as of version 	V14
<ul style="list-style-type: none"> STEP 7 configurable/integrated as of version 	V5.5 SP3
<ul style="list-style-type: none"> PCS 7 configurable/integrated as of version 	V8.1 SP1
<ul style="list-style-type: none"> PROFIBUS as of GSD version/GSD revision 	One GSD file each, Revision 3 and 5 and higher
<ul style="list-style-type: none"> PROFINET as of GSD version/GSD revision 	GSDML V2.3
Operating mode	
<ul style="list-style-type: none"> DI 	Yes
<ul style="list-style-type: none"> Counter 	No
<ul style="list-style-type: none"> Oversampling 	No
<ul style="list-style-type: none"> MSI 	No

Article number	6ES7131-6BH01-0BA0
Supply voltage	
Rated value (DC)	24 V
permissible range, lower limit (DC)	19.2 V
permissible range, upper limit (DC)	28.8 V
Reverse polarity protection	Yes
Input current	
Current consumption, max.	90 mA
24 V encoder supply	
• 24 V	No
Power loss	
Power loss, typ.	1.7 W
Address area	
Address space per module	
• Inputs	2 byte; + 2 bytes for QI information
Hardware configuration	
Automatic encoding	Yes
• Mechanical coding element	Yes
Selection of BaseUnit for connection variants	
• 1-wire connection	BU type A0
• 2-wire connection	BU type A0 + Potential isolation module
• 3-wire connection	BU type A0 + Potential isolation module
• 4-wire connection	BU type A0 + Potential isolation module
Digital inputs	
Number of digital inputs	16
Digital inputs, parameterizable	Yes
Source/sink input	P-reading
Input characteristic curve in accordance with IEC 61131, type 3	Yes
Input voltage	
• Rated value (DC)	24 V
• for signal "0"	-30 to +5V
• for signal "1"	+11 to +30V
Input current	
• for signal "1", typ.	2.5 mA

Article number	6ES7131-6BH01-0BA0
Input delay (for rated value of input voltage) for standard inputs	
<ul style="list-style-type: none"> - parameterizable 	Yes; 0.05 / 0.1 / 0.4 / 0.8 / 1.6 / 3.2 / 12.8 / 20 ms (in each case + delay of 30 to 500 µs, depending on line length)
<ul style="list-style-type: none"> - at "0" to "1", min. 	0.05 ms
<ul style="list-style-type: none"> - at "0" to "1", max. 	20 ms
<ul style="list-style-type: none"> - at "1" to "0", min. 	0.05 ms
<ul style="list-style-type: none"> - at "1" to "0", max. 	20 ms
Cable length	
<ul style="list-style-type: none"> • shielded, max. 	1 000 m
<ul style="list-style-type: none"> • unshielded, max. 	600 m
Encoder	
Connectable encoders	
<ul style="list-style-type: none"> • 2-wire sensor 	Yes
<ul style="list-style-type: none"> - permissible quiescent current (2-wire sensor), max. 	1.5 mA
Isochronous mode	
Isochronous operation (application synchronized up to terminal)	No
Interrupts/diagnostics/status information	
Diagnostics function	Yes
Alarms	
<ul style="list-style-type: none"> • Diagnostic alarm 	Yes
Diagnostic messages	
<ul style="list-style-type: none"> • Diagnostic information readable 	Yes
<ul style="list-style-type: none"> • Monitoring the supply voltage 	Yes
<ul style="list-style-type: none"> - parameterizable 	Yes
<ul style="list-style-type: none"> • Monitoring of encoder power supply 	No
<ul style="list-style-type: none"> • Wire-break 	Yes; Module-by-module, optional protective circuit for preventing wire-break diagnostics in the case of simple encoder contacts: 25 kOhm to 45 kOhm
<ul style="list-style-type: none"> • Short-circuit 	No
<ul style="list-style-type: none"> • Group error 	Yes
Diagnostics indication LED	
<ul style="list-style-type: none"> • Monitoring of the supply voltage (PWR-LED) 	Yes; green PWR LED
<ul style="list-style-type: none"> • Channel status display 	Yes; Green LED
<ul style="list-style-type: none"> • for channel diagnostics 	No
<ul style="list-style-type: none"> • for module diagnostics 	Yes; green/red DIAG LED

Article number	6ES7131-6BH01-0BA0
Potential separation	
Potential separation channels	
<ul style="list-style-type: none"> • between the channels • between the channels and backplane bus • between the channels and the power supply of the electronics 	<p>No</p> <p>Yes</p> <p>No</p>
Isolation	
Isolation tested with	707 V DC (type test)
Ambient conditions	
Ambient temperature during operation	
<ul style="list-style-type: none"> • horizontal installation, min. • horizontal installation, max. • vertical installation, min. • vertical installation, max. 	<p>-30 °C</p> <p>60 °C</p> <p>-30 °C</p> <p>50 °C</p>
Altitude during operation relating to sea level	
<ul style="list-style-type: none"> • Installation altitude above sea level, max. 	2 000 m; On request: Installation altitudes greater than 2 000 m
Dimensions	
Width	15 mm
Height	73 mm
Depth	58 mm
Weights	
Weight, approx.	28 g

Dimension drawing

See manual ET 200SP BaseUnits
(<http://support.automation.siemens.com/WW/view/en/59753521>)

Parameter data record

A.1 Parameter assignment and structure of parameter data record

The data record of the module has an identical structure, regardless of whether you configure the module with PROFIBUS DP or PROFINET IO. With data record 128, you can reconfigure the module in your user program regardless of your programming. This means that you can use all the functions of the module even if you configured it via PROFIBUS-GSD.

Parameter assignment in the user program

The module parameters can be re-assigned in RUN (for example, the input delay of selected channels can be edited in RUN without having an effect on the other channels).

Changing parameters in RUN

The "WRREC" instruction is used to transfer the parameters to the module using data record 128. The parameters set in STEP 7 are not changed in the CPU, which means that the parameters set in STEP 7 will be valid again after a restart.

Output parameter STATUS

If errors occur when transferring parameters with the "WRREC" instruction, the module continues operation with the previous parameter assignment. The STATUS output parameter contains a corresponding error code.

You will find a description of the "WRREC" instruction and the error codes in the STEP 7 online help.

Structure of data record 128

Note

Channel 0 includes the diagnostics enable for the entire module.

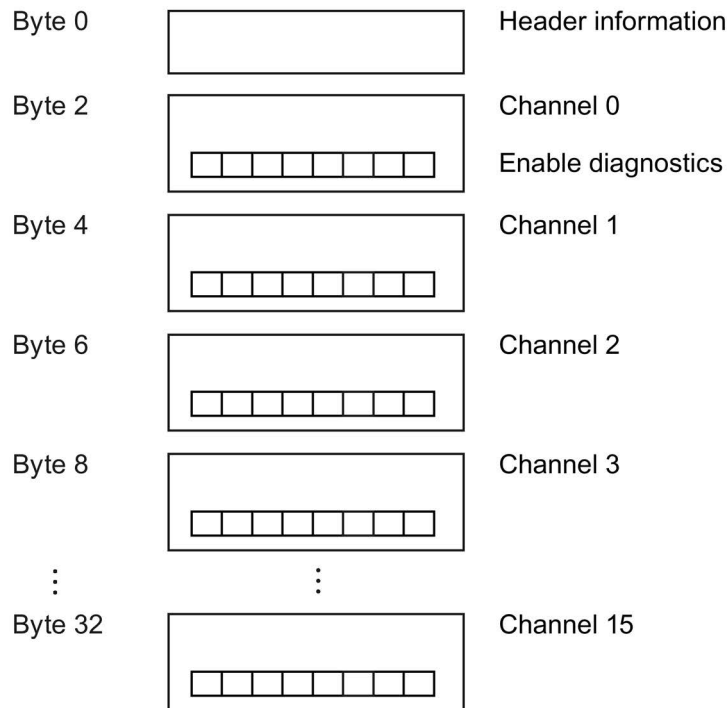

Figure A-1 Structure of data record 128

Header information

The figure below shows the structure of the header information.

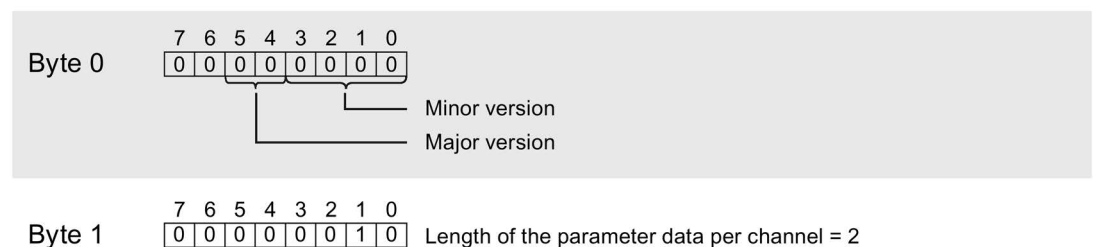
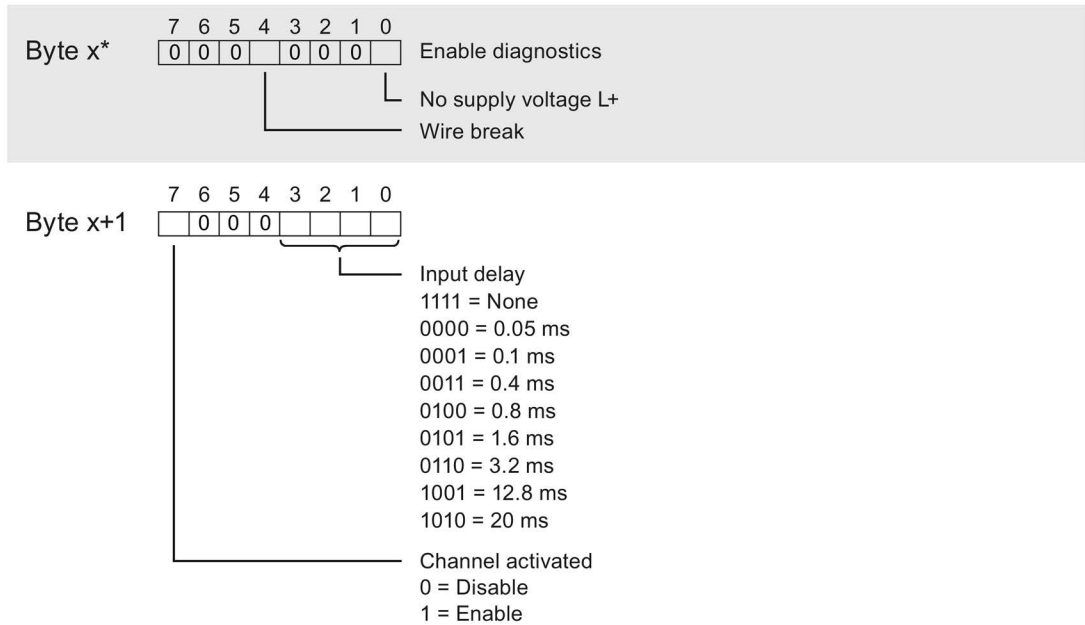

Figure A-2 Header information

Parameters

The figure below shows the structure of the parameters for channels 0 to 15. You enable a parameter by setting the corresponding bit to "1".



* $x = 2 + (\text{channel number} \times 2)$; channel number = 0 to 15

Figure A-3 Structure byte x to x+1 for the channels 0 to 15

Error transferring the data record

The module always checks all the values of the transferred data record. Only if all the values were transferred without errors does the module apply the values from the data record.

The WRREC instruction for writing data records returns corresponding error codes when errors occur in the STATUS parameter, see also the description of the "STATUS" parameter in the STEP 7 online help).

The following table shows the module-specific error codes and their meaning for the parameter data record 128.

Error code in STATUS parameter (hexadecimal)				Meaning	Solution
Byte 0	Byte 1	Byte 2	Byte 3		
DF	80	B0	xx	Number of the data record unknown.	Enter a valid number for the data record.
DF	80	B1	xx	Length of the data record incorrect.	Enter a valid value for the data record length.
DF	80	B2	xx	Slot invalid or cannot be accessed.	<ul style="list-style-type: none"> • Check the station whether the module is plugged or drawn. • Check the assigned values for the parameters of the WRREC instruction.
DF	80	E0	xx	Wrong version or error in the header information.	Correct the version, length and number of parameter blocks.
DF	80	E1	07	Invalid coding for input filter time.	Check the parameters of the module.