

Making the transition from S7-200 to S7-1200

Start

Devices &
Networks

PLC
Programming

Visualization

Online &
Diagnostics

Notes are available to supplement this presentation. To view the notes, select View > Notes Page or print the presentation with the Print > Print what: > Notes Pages option.

© Siemens AG 11/2009. All Rights Reserved.

S7-1200 and STEP 7 Basic

- The S7-1200 is the successor of the S7-200 and is available in June 2009. It is designed for and will be sold in the world wide market place.
- The S7-200 will remain an active Siemens product.
- STEP 7 Basic v10.5 programming package (ordered separately) is used with the S7-1200
 - Supports LAD and FBD. STL is not supported.
 - Includes WinCC Basic for configuring HMI Basic panels.
 - No separate USB license stick is required. The software is automatically activated when installed.
- An export-import function for an S7-1200 project is not available in the initial release. To move project files from one PC to another PC, use the Windows explorer and PKZIP to copy the project files directory structure.

S7-1200 Approvals

- S7-1200 hardware has the necessary approvals for the US and European market.
- The S7-1200 has FM approval for hazardous location:
The Factory Mutual Research (FM): Approval Standard Class Number 3600 and 3611
Approved for use in:
 - Class I, Division 2, Gas Group A, B, C, D, Temperature Class 40° C
 - Class I, Zone 2, IIC, Temperature Class T4 Ta = 40° C
- The S7-1200 hardware has UL and CE approvals.

System Expandability

- Hardware
- Communication
- HMI
- Memory
- Block concept
- Instruction set
- New data types
- Timers
- Counters
- Technology
- Resources

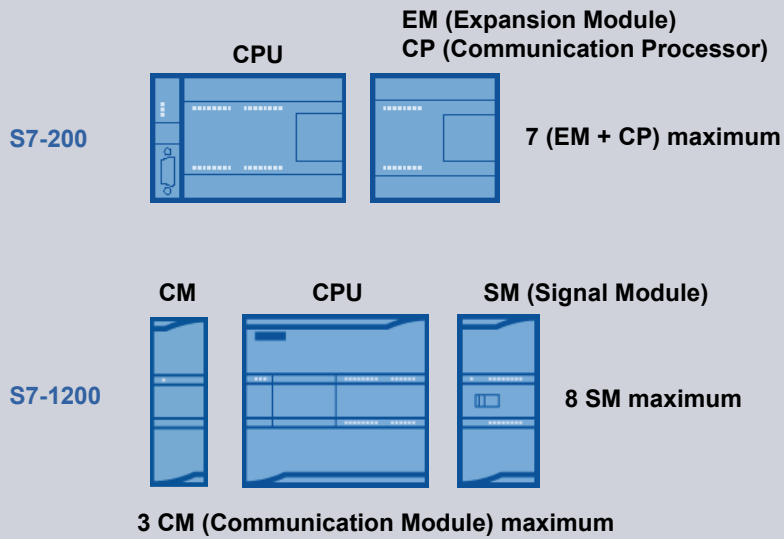

S7-1200 CPU	CPU Digital I/O	CPU Analog IN	Power, Signal IN, Signal OUT
CPU 1211C	6 IN - 4 OUT	2 IN (0-10V)	CPU 1211C DC/DC/DC
			CPU 1211C AC/DC/Relay
			CPU 1211C DC/DC/Relay
CPU 1212C	8 IN – 6 OUT	2 IN (0-10V)	CPU 1212C DC/DC/DC
			CPU 1212C AC/DC/Relay
			CPU 1212C DC/DC/Relay
CPU 1214C	14 IN -10 OUT	2 IN (0-10V)	CPU 1214C DC/DC/DC
			CPU 1214C AC/DC/Relay
			CPU 1214C DC/DC/Relay

S7-1200 Signal Modules and Signal Boards	
Signal Modules	SM 1221 8 x 24 VDC Input
	SM 1221 16 x 24 VDC Input
	SM 1222 8 x 24 VDC Output
	SM 1222 16 x 24 VDC Output
	SM 1222 8 x Relay Output
	SM 1222 16 x Relay Output
	SM 1223 8 x 24 VDC Input / 8 x 24 VDC Output
	SM 1223 16 x 24 VDC Input / 16 x 24 VDC Output
	SM 1223 8 x 24 VDC Input / 8 x Relay Output
	SM 1223 16 x 24 VDC Input / 16 x Relay Output
	SM 1231 4 x Analog Input
	SM 1232 2 x Analog Output
	SM 1234 4 x Analog Input / 2 x Analog Output
Signal Boards	SB 1223 2 x 24 VDC Input / 2 x 24 VDC Output
	SB 1232 1 Analog Output

S7-1200 Communication Modules	
CM 1241 RS232	
CM 1241 RS485	

CPU on-board I/O and SB (Signal Board) I/O

Hardware

Communication

HMI

Memory

Block concept

Instruction set

New data types

Timers

Counters

Technology

Resources

		S7-200 CPU 224XP	S7-1200 CPU 1214C
DI	Digital Input	14	14+ (2 on SB)
DO	Digital Output	10	10+ (2 on SB)
AI	Analog Input	2	2
AO	Analog Output	1	1 on SB
PWM / PTO			
	Pulse Width Modulation	2	2
	Pulse Train Output		
HSC	High Speed Counter	6	6
PID	Closed loop controller	8	16

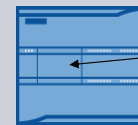

1 optional Signal Board (SB) can be inserted in the front of the CPU

The Signal Board expands the S7-1200 CPU I/O without increasing the CPU footprint size

The initial release on the STEP 7 Basic V10.5 software and S7-1200 hardware set does not include the S7-200 expansion module types shown below. To use the S7-1200 CPU for an S7-200 application that uses these modules, you must use a different method to replace the function of these I/O modules. For example, there is no S7-1200 RTD or Thermocouple module. However, you can use standard analog modules with temperature sensors. The user program can perform a linearization of the sensor output.

S7-200 module types with no equivalent S7-1200 module (for initial S7-1200 hardware release)
EM 221 Digital 8 AC Inputs (8 x 120/230 VAC)
EM 222 Digital 8 AC Outputs (8 x 120/230 VAC)
EM 222 Digital Output (4 x Relays 10A)
EM231 Analog Input, 8 Inputs
EM231 Analog Output, 4 Outputs
EM 231 Analog Input RTD, 2 Inputs
EM 231 Analog Input RTD, 4 Inputs
EM 231 Analog Input RTD, 8 Inputs
EM 231 Analog Input Thermocouple, 4 Inputs
EM 231 Analog Input Thermocouple, 8 Inputs
EM 241 Modem module
EM 253 Position module
EM 277 PROFIBUS DP module
SIWAREX MS Micro Scale module
CP 243-2 ASi master module
CP 243-1 IT Internet module
SIMATIC TD (RS485 connection Text Display) TD 100C, TD 200, TD 200C, TD400C, OP73micro, TP177micro

Hardware configuration S7-200

- Hardware
- Communication
- HMI
- Memory
- Block concept
- Instruction set
- New data types
- Timers
- Counters
- Technology
- Resources

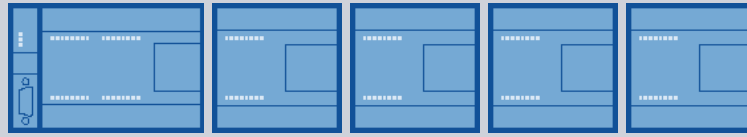

- Expansion modules are automatically recognized when connected and powered
- STEP 7-Micro/WIN "SET PG/PC Interface" window configures the communication driver
- STEP 7-Micro/WIN "Communications" uses the selected driver to scan and connect CPU stations
- STEP 7-Micro/WIN "System Block" window configures CPU parameters
- A System Block download operation transfers the new hardware configuration into the target CPU

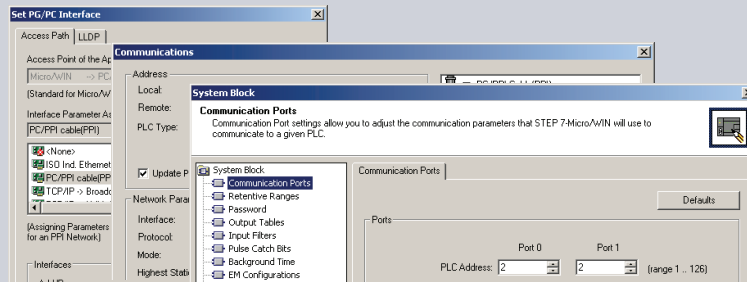

Hardware configuration S7-1200

Hardware

Communication

HMI

Memory

Block concept

Instruction set

New data types

Timers

Counters

Technology

Resources

- STEP 7 Basic uses a visual configuration where you create an image of your actual hardware set
- Hardware modules are selected from a hardware catalog tree and dragged into a rack image
- After your system hardware image is assembled, use a mouse click on an item in the system image to set the configuration "Properties" page for the selected hardware item
- Select the CPU PROFINET connector on the CPU image to set the IP address properties
- Use the Download command to transfer the new hardware configuration to the target CPU. When prompted, select a network interface and CPU.

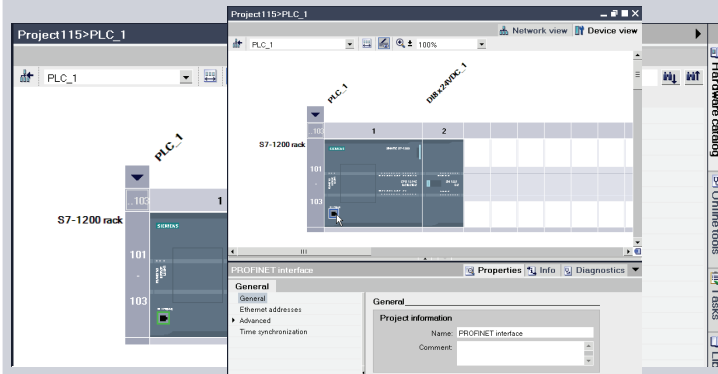

Page 5/48

S7-1200 Transition Manual
A5E02486860-01

© Siemens AG 11/2009. All Rights Reserved.
Industry Sector

Password protection

- S7-1200 Off-line project block password provides Know-How protection to prevent unauthorized access to one or more of your code blocks (OB, FB, FC, or DB).
- S7-1200 On-line CPU password protection provides 3 levels of security for restricting access to CPU functions.

I/O address assignment

- S7-200: I/O addresses automatically fixed by CPU operating system according to module location.
- S7-1200: Default I/O assignment can be modified by Device configuration properties.

Serial communication for S7-200 and S7-1200

- Hardware
- Communication**
- HMI
- Memory
- Block concept
- Instruction set
- New data types
- Timers
- Counters
- Technology
- Resources

S7-1200 CPU communication via RS232 and RS485 connections

- ASCII protocol (character based serial communication) uses STEP 7 Basic point-to-point (PtP) instructions
- USS Drive protocol is programmed with STEP 7 Basic USS Library instructions
- MODBUS protocol is programmed with STEP 7 Basic MODBUS Library instructions

S7-200 CPUs have 1 or 2 on-board RS485 serial connections

S7-1200 CPUs have 1 on-board PROFINET (ETHERNET) connection. Use the RS232 and RS485 modules for PtP communication

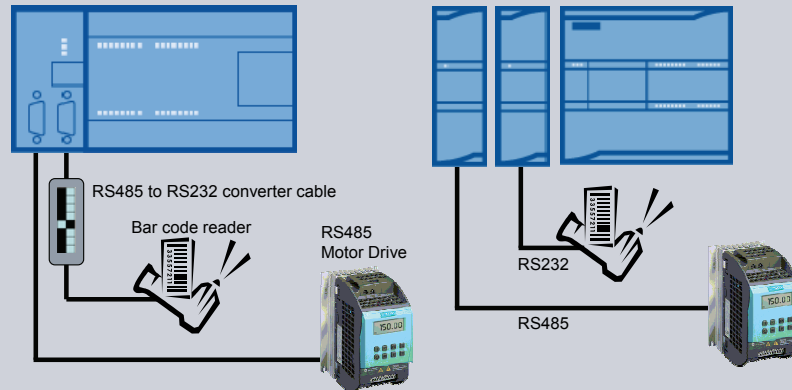

- PROFIBUS master (RS485 connection): The PROFIBUS master/slave functionality is not available in the initial S7-1200 product release.
- MODBUS RTU is possible on both the RS485 and RS232 signal modules.
- USS library is supported on the RS485 port. The libraries are included with STEP 7 Basic.
- S7-1200 SINAUT: You can create an S7-1200 RTU application using the RS232 module, PtP communication, and the existing SINAUT MD720-3 GSM/GPRS wireless modem. A new SINAUT solution and teleservice adapter are planned for the next S7-1200 hardware release.
- The RS232 module supports handshaking.
- The S7-1200 RS232 and RS485 modules have electrically isolated ports.

S7-1200 Communication Modules
CM 1241 RS232
CM 1241 RS485



S7-1200 integrated PROFINET (Ethernet) - interface

- Hardware
- Communication
- HMI
- Memory
- Block concept
- Instruction set
- New data types
- Timers
- Counters
- Technology
- Resources

Communication with the STEP 7 Basic software

- CPU hardware configuration
- Project download
- Run-time variable monitoring / modifying
- Run-time Force I/O states
- Diagnostics

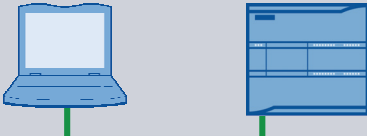

Communication with HMI panels

- Data from / to CPU
- System Diagnostics



Communication from CPU to CPU

- Open communication with TSEND / TRCV instructions
- Supported Protocols
 - TCP/IP native
 - ISO on TCP
- S7-communication (PUT / GET) server only



Page 7/48

S7-1200 Transition Manual
A5E02486860-01

© Siemens AG 11/2009. All Rights Reserved.
Industry Sector

- The PROFINET port on the CPU supports simultaneous communication connections:
 - 3 connections for HMI to CPU communication
 - 1 connection for programming device (PG) to CPU communication
 - 8 connections for S7-1200 program communication using the T-block instructions (TSEND_C, TRCV_C, TCON, TDISCON, TSEND TRCV)
 - 3 connections for a passive S7-1200 CPU communicating with an active S7 CPU. The active S7 CPU uses GET and PUT instructions (S7-300 and S7-400) or ETHx_XFER instructions (S7-200). An active S7-1200 communication connection is only possible with the T-block instructions.
- MODBUS-TCP is not available for the initial S7-1200 release. However, the S7-1200 has "Native" Ethernet TCP/IP protocol available (T-block instructions) for custom development.
- OPC server (Object Linking and Embedding – OLE) for Process Control server
OPC functionality is possible using the SIMATIC NET OPC Server.
- PROFINET functionality including controller, device, and CBA is not available for the initial release of the S7-1200.
- The S7-1200 Ethernet interfaces are designated as PROFINET. The S7-1200 will not support PROFINET I/O in the initial release, but this functionality is planned for a future release.
- Communication with Omron and Mitsubishi controllers via the Ethernet. The S7-1200 has "Native" Ethernet TCP/IP protocol available ("FreePort" for Ethernet) for custom development of this functionality. It is possible to communicate with 3rd party PLCs as long as they support the same open Ethernet connectivity as the S7-1200.

S7-1200 CPUs use a PROFINET connection to STEP 7 Basic, S7-1200 CPUs, and HMI panels



- Hardware
- Communication
- HMI
- Memory
- Block concept
- Instruction set
- New data types
- Timers
- Counters
- Technology
- Resources

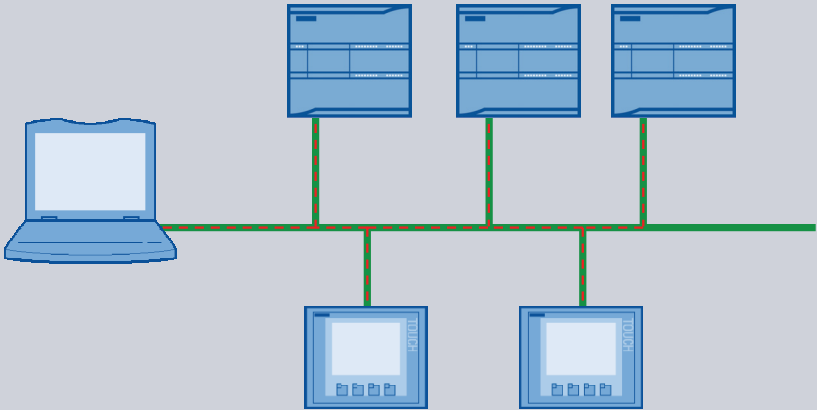

S7-200 CPUs use an RS485 connection to a PPI network of CPUs and HMI panels. An expansion Ethernet module must be added for Ethernet communication.

Page 8/48

S7-1200 Transition Manual
A5E02486860-01

© Siemens AG 11/2009. All Rights Reserved.
Industry Sector

HMI general

- The HMI Basic Panel in the context of the S7-1200 can communicate with up to 4 CPUs.
- Text Displays for the S7-1200 are planned in a future release.
- Compatibility with current HMI Ethernet devices
At present, only the Basic Panels have been system-tested and released in conjunction with WinCC Basic and the S7-1200. However, other panels can also be connected to the S7-1200 in the context of WinCC flexible.
- MP277 and 377 panels will talk with the S7-1200. Use WinCC flexible for programming and select the S7-300 communication channel (Rack 0 - Slot 0) at the start.

HMI update rate

- S7-200: HMI data update occurs at end of the program scan and is scan rate limited.
- S7-1200: HMI data update occurs asynchronously during program scan. Therefore, insure that data variables are buffered from change, during a program scan.

Totally Integrated Automation Portal integrates control logic and HMI configuration programming

SIEMENS

Hardware
Communication
HMI
Memory
Block concept
Instruction set
New data types
Timers
Counters
Technology
Resources

SIMATIC S7-1200



SIMATIC HMI Basic Panels

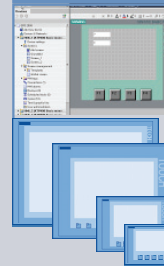

The Totally Integrated Automation Portal, version 10.5 contains SIMATIC STEP 7 Basic version 10.5, and SIMATIC WinCC Basic version 10.5.

SIMATIC WinCC Basic can configure the operation of the SIMATIC Basic HMI panels: Monochrome - KTP400 and KTP600, and Color - KTP600, KTP1000, and TP 1500

STEP 7-Micro/WIN and the S7-200 use the TD wizard, TD Keypad Designer, and WinCC Flexible Micro to configure the HMI panels (TD 100C, TD 200, TD 200C, TD400C, OP 73, TP177).

Page 9/48

S7-1200 Transition Manual
A5E02486860-01

© Siemens AG 11/2009. All Rights Reserved.
Industry Sector

- HMI Basic panels require a PC for download. They do not have memory cards
- Variable tags on HMI basic panels. The number of variable tags cannot be increased at this time. There are plans to increase the number of default tags available on these units
- WinCC Flexible Micro will be available as long as HMI Micro panels (for the S7-200) are sold. At this time there are no plans for discontinuing the micro panel.
- Library graphics are created in WinCC Flexible

It is not possible to migrate any library items directly from WinCC Flexible to WinCC Basic. However, you can copy all the elements from the library to an HMI screen in a project and then migrate the resulting project into WinCC Basic.

■ Changing from WinCC flexible to WinCC Basic. A firmware update is not necessary in the case of WinCC flexible 2008 and WinCC Basic.

■ Sm@rtAccess/Sm@rtService

The S7-1200 does not support Sm@RtAccess or Sm@rtService

The Totally Integrated Automation Portal provides the tools for managing and configuring all of the devices in your project, such as PLCs and HMI devices. As a component of the TIA Portal, STEP 7 Basic provides two programming languages (LAD and FBD). The TIA Portal also provides the tools for creating and configuring the HMI devices in your project.

S7-1200 HMI devices
KTP400 Basic mono PN, 3.8" STN Gray scale Touch-Display, 4 Function keys, Ethernet interface
KTP600 Basic mono PN, 5.7" STN Gray scale Touch-Display, 6 Function keys, Ethernet interface
KTP600 Basic color DP and Basic color PN, 5.7" TFT color Touch-Display, 6 Function keys, PROFIBUS-DP / MPI-interface or Ethernet interface
KTP1000 Basic color DP and Basic color PN, 10.4" TFT color Touch-Display, 8 Function keys, PROFIBUS -DP / MPI-interface or Ethernet interface
TP1500 Basic color PN, 15.0" TFT color Touch-Display, Ethernet interface

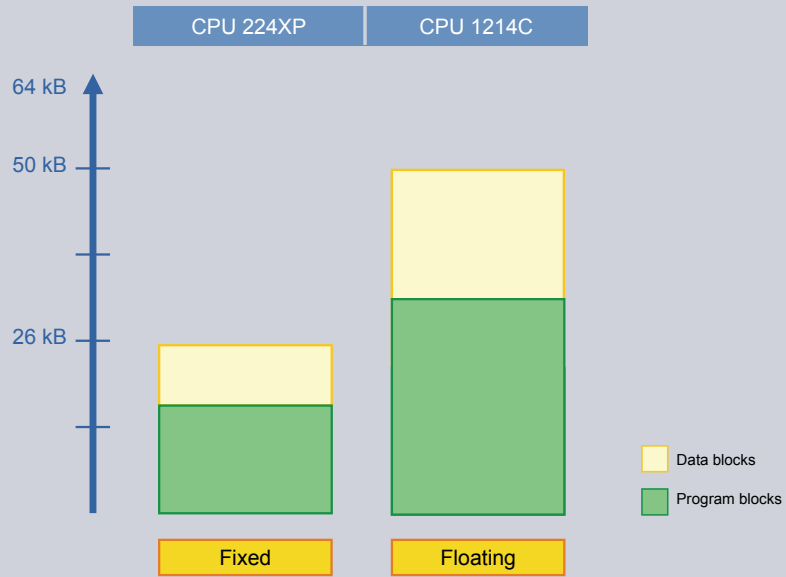

CPU work memory size

- Hardware
- Communication
- HMI
- Memory**
- Block concept
- Instruction set
- New data types
- Timers
- Counters
- Technology
- Resources



STEP 7 Basic program objects in S7-1200 CPU memory

SIEMENS

	S7-200	S7-1200
<p>Hardware</p> <p>Communication</p> <p>HMI</p> <p>Memory</p> <p>Block concept</p> <p>Instruction set</p> <p>New data types</p> <p>Timers</p> <p>Counters</p> <p>Technology</p> <p>Resources</p>	<p>Size of the load memory</p> <div style="border: 1px solid yellow; padding: 5px; text-align: center;"> <p>Not published</p>  <p>Program blocks</p> <p>✗ Tag names</p> <p>✗ Comments</p> </div>	<p>1 / 2 MB (internal)</p>  <div style="border: 1px solid yellow; padding: 5px; text-align: center;"> <p>Program blocks</p> <p>✓ Tag names</p> <p>✓ Comments</p> </div>

Program Tag names and comments are stored in S7-1200 CPU memory and are available on-line. For STEP 7-Micro/WIN and the S7-200, you must have the original project files to match symbolic tag names and comments with the on-line program logic.

Page 11/48 S7-1200 Transition Manual A5E02486860-01 © Siemens AG 11/2009. All Rights Reserved. Industry Sector

All tags, block comments, network comments, and instruction comments are downloaded to the S7-1200 controller. This makes it possible to go online with a controller and debug it without the original project.

Step 7 Basic can optimize a Data Block size

- Hardware
- Communication
- HMI
- Memory**
- Block concept
- Instruction set
- New data types
- Timers
- Counters
- Technology
- Resources

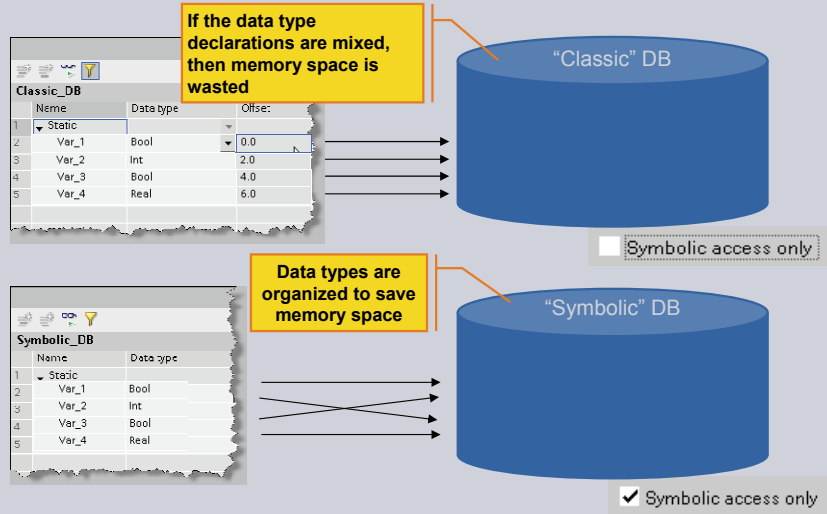

When a Data Block is created, you can select the optimized format by checking the “Symbolic access only” box. The “Classic” data format is also supported for compatibility with legacy code.

Retentive memory assignments preserve data during CPU power interruptions



PLC Tag table button can assign a range of M memory as retentive (2048 byte maximum)

- Hardware
- Communication
- HMI
- Memory**
- Block concept
- Instruction set
- New data types
- Timers
- Counters
- Technology
- Resources

S7-200

Range	Data Area	Offset	Number of Element
Range 0	vB	0	10240
Range 1	VB	0	0
Range 2	T	0	32
Range 3	T	64	32
Range 4	C	0	256
Range 5	MB	14	18

S7-1200

Retain memory

Number of memory bytes starting at MB0: 0

Available retentive memory (Bytes): 2048

OK Cancel

Name	Data type	Initial value	Retain
Static			<input type="checkbox"/>
Symbol name 1	Byte	0	<input checked="" type="checkbox"/>
Symbol name 2	Byte	0	<input type="checkbox"/>
Symbol name 3	Real	3.141592654	<input checked="" type="checkbox"/>

Name	Data type	Offset	Initial value	Retain
Static				<input type="checkbox"/>
Symbol name 3	Byte	0.0	0	<input checked="" type="checkbox"/>
Symbol name 4	Byte	1.0	0	<input checked="" type="checkbox"/>
Symbol name 5	Real	2.0	3.141592654	<input checked="" type="checkbox"/>

System block settings can assign 6 retentive ranges in V, T and C actual values, or M

A "Symbolic access only" DB can select individual data elements for retention. If "Symbolic access only" is not selected, then a block of DB data can be retentive. The 2048 byte total is shared between M and DB memory.

The S7-1200 CPU automatically stores retained data in internal flash memory. The S7-200 uses a supercap, optional battery cartridge, or programmed writes to a flash memory cartridge to retain memory data.

Memory Card - Memory size

- Hardware
- Communication
- HMI
- Memory**
- Block concept
- Instruction set
- New data types
- Timers
- Counters
- Technology
- Resources

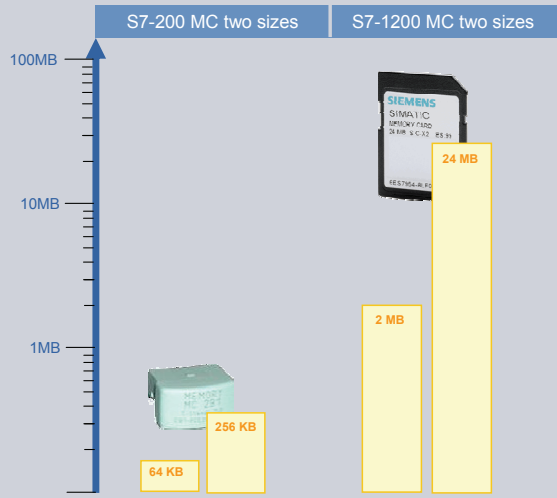

What can be stored on the Memory Card?

- Hardware
- Communication
- HMI
- Memory**
- Block concept
- Instruction set
- New data types
- Timers
- Counters
- Technology
- Resources

	S7-200	S7-1200
Program	✓	✓
Data	✓	✓
System data	✓	✓
Recipes	✓	planned
Data Log	✓	planned
Files	✓	✓
Projects	✓	✓

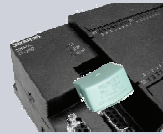

**MC
optional**



**SIMATIC MC
optional**

SIMATIC memory cards have a Windows file system and comply with the necessary industrial requirements. The memory card can be written to and read in any PC and then also used again for operation in the CPUs.

How can the S7-1200 use the pre-formatted SIMATIC MC?

SIEMENS

Hardware
Communication
HMI
Memory
Block concept
Instruction set
New data types
Timers
Counters
Technology
Resources

- You can create a “Program” card that functions as CPU memory. If you remove the “Program” card from the CPU, the CPU loses all project memory.
- You can create a “Transfer” card that can copy your project (and updates) to multiple CPUs.



You can create a “Transfer” card using STEP 7 Basic on a PC with a standard SD card reader/writer.

Page 16/48

S7-1200 Transition Manual
A5E02486860-01

© Siemens AG 11/2009. All Rights Reserved.
Industry Sector

Memory card usage

- Before programming a memory card, be sure there is a valid network configuration in your project so that it can connect to the PLC after installing the card.
- SIMATIC memory cards are pre-formatted with a SIMATIC memory format that must be preserved. Do not use a PC to delete the two hidden files `__log__` (system file) and `crdinfo.bin` (bin file). Do not use a PC to reformat the memory card or the card will become unusable.
- Refer to the S7-1200 Programmable controller system Manual 11/2009 version for details on how to create and use a “Program” card and “Transfer” card.

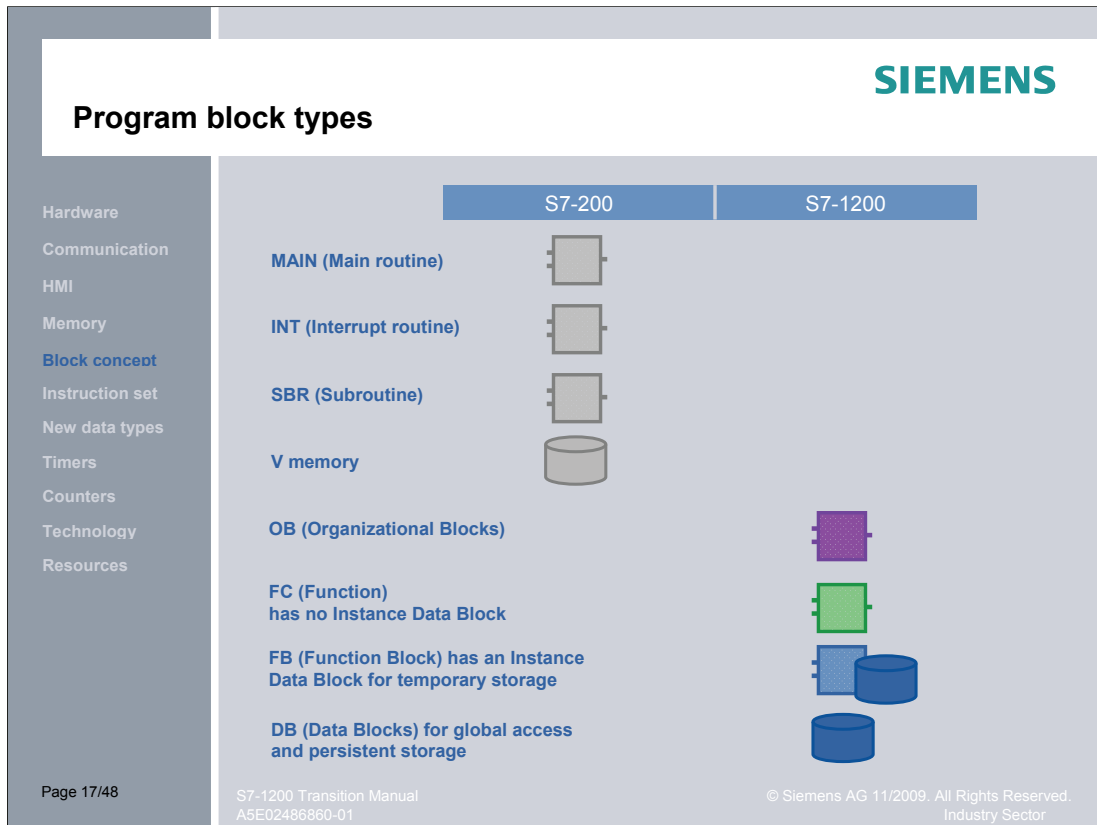

S7-1200 Organization Block (OB) Types:

- Program Cycle OB1
- Startup OB100 series
- Time delay interrupt OB200 series
- Cyclic interrupt OB200 series
- Hardware interrupt OB200 series
- Time error interrupt OB80
- Diagnostic error interrupt OB82

Non-fatal error handling

- S7-200: By default, continue RUN mode
- S7-1200: By default, go to STOP mode
If OB80 or OB82 error OB blocks exist in your program, then continue RUN mode.
OB80 and OB82 may be empty or contain your programmed error reaction

STEP 7 Basic programming methods not supported initial V 10.5 release

- Hot keys
- Indirect addressing
- Run-time edit

S7-200 program structure in STEP 7-Micro/WIN

- Hardware
- Communication
- HMI
- Memory
- Block concept**
- Instruction set
- New data types
- Timers
- Counters
- Technology
- Resources

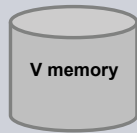

MAIN, SBR, and INT routines have read/write access to V memory

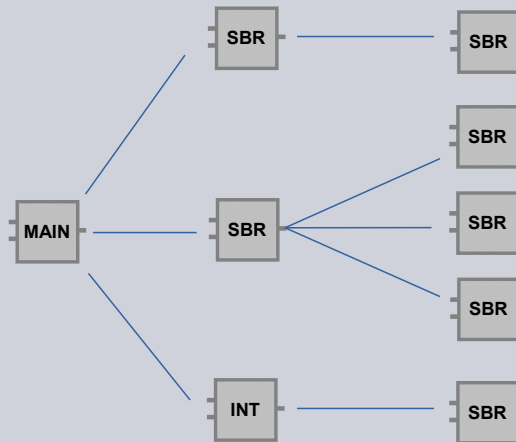

The maximum nesting depth for subroutines from the Main is 8, and from an Interrupt routine is 1.

S7-1200 program structure in STEP 7 Basic

- Hardware
- Communication
- HMI
- Memory
- Block concept**
- Instruction set
- New data types
- Timers
- Counters
- Technology
- Resources

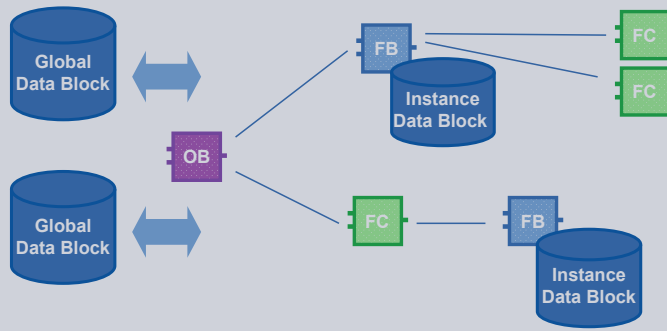

The maximum nesting depth is 16

STEP 7 Basic has the same block architecture used by the S7-300

- Modularization and reuse is easier
- Technology objects (for example, PID control) can be standardized and called multiple times
- Symbolic reference is possible

S7-1200 Instance Data Block types

- Hardware
- Communication
- HMI
- Memory
- Block concept**
- Instruction set
- New data types
- Timers
- Counters
- Technology
- Resources

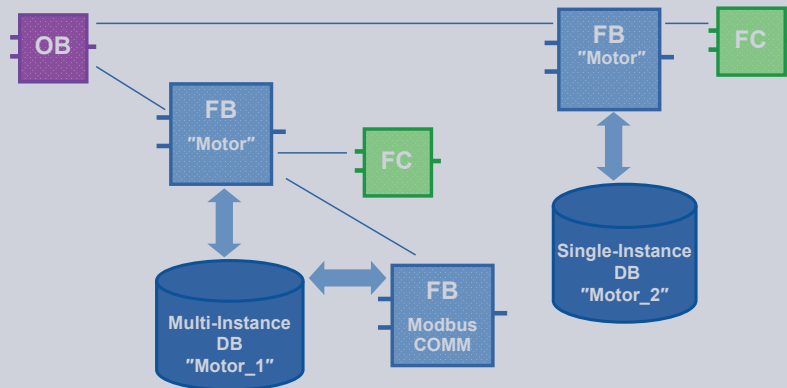

STEP 7 Basic can use single-instance and multi-instance Data Blocks

- A function block (FB) can be called multiple times
- One FB type (for example, FB "Motor") can control several drives
- The actual data of the different drives can be stored in different single-instance or multi-instance DBs
- Two FBs can share a multi-instance DB for more efficient memory usage

Interrupt structure S7-200

- Hardware
- Communication
- HMI
- Memory
- Block concept**
- Instruction set
- New data types
- Timers
- Counters
- Technology
- Resources

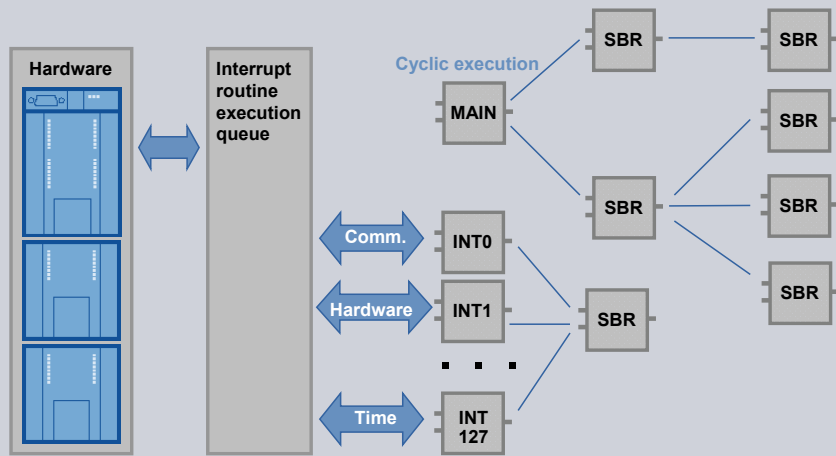

Interrupt events are attached and detached to interrupt routines at program run-time only

Interrupt structure S7-1200

- Hardware
- Communication
- HMI
- Memory
- Block concept
- Instruction set
- New data types
- Timers
- Counters
- Technology
- Resources

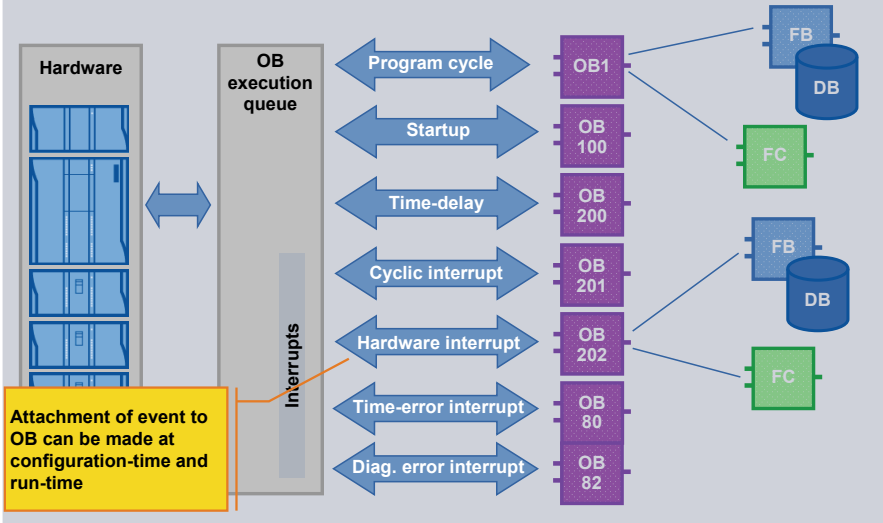

Several optional Startup and Time-delay OBs may be used

Timer instructions

- Hardware
- Communication
- HMI
- Memory
- Block concept
- Instruction set**
- New data types
- Timers
- Counters
- Technology
- Resources

What's new?

TP (Pulse timer) and TONR (On-delay retentive) are now in the same group.

What's different?

▪ S7-200: A timer number selection sets a 1ms, 10ms, or 100ms time resolution that is multiplied by the WORD size time current value for preset and elapsed times.

▪ S7-1200: All timers are 1ms timers that use a new DWORD size Time data type for the preset and elapsed time values.

▪ S7-200: STEP 7-Micro/WIN has a SIMATIC and IEC programming mode. In SIMATIC mode, a T-bit and T-current value corresponding to the timer number are used to signal the timeout condition and the current value (elapsed time).

▪ S7-1200: In STEP 7 Basic, all timers are IEC style timers that have a Q output bit that signals the timeout condition and an ET output that gives the elapsed time.

▪ S7-200: BGN_ITIME (Begin Interval Time), CAL_ITIME (Calculate Interval Time)

▪ S7-1200: Use Clock instructions RD_SYS_T (read system time) and T_SUB (time difference) to calculate time intervals.

Timers

S7-200

S7-1200

SIMATIC mode

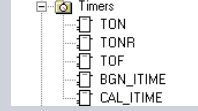

IEC mode

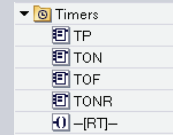
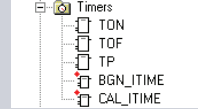

Counter instructions

- Hardware
- Communication
- HMI
- Memory
- Block concept
- Instruction set**
- New data types
- Timers
- Counters
- Technology
- Resources

What's different?

Counter instructions

- S7-200: STEP 7-Micro/WIN has a SIMATIC and IEC programming mode. In SIMATIC mode, a C-bit and C-current value corresponding to the counter number are used to signal the count condition and the current count value.
- S7-1200: In STEP 7 Basic, all counters are IEC style counters that have a Q output bit that signals the count condition and a CV output that gives the current count value.

S7-200 Counters

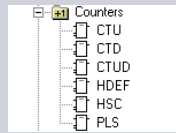

S7-1200 Counters

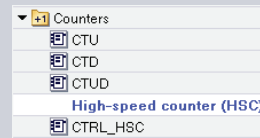

High-Speed Counter instructions

- S7-200: HDEF (High-Speed Counter Definition) HSC (High-Speed Counter)
- S7-1200: CTRL_HSC
- S7-200: Special memory assignments (SM addresses) are used to set the high-speed counter configuration and operating parameters.
- S7-1200 High-speed counters are set up in the PLC Device configuration properties. The operating parameters are available as inputs and outputs of the CTRL_HSC instruction.

Compare instructions

- Hardware
- Communication
- HMI
- Memory
- Block concept
- Instruction set**
- New data types
- Timers
- Counters
- Technology
- Resources

What's new?

The Compare instructions now support the 64 bit LREAL data type.

Compare instructions:

- IN_RANGE tests whether an input value is in a specified value range.
- OUT_RANGE tests whether an input value is out of a specified value range.
- |OK| tests whether an input data reference is a real number.
- |NOT_OK| instruction tests whether an input data reference is not a real number.

What's different?

- S7-200: The instruction name determines the data type.
- S7-1200: The data type is selected after placing the instruction.

Compare

S7-200

- [-] Compare
- I |==B|
- I |<>B|
- I |>B|
- I |<=B|
- I |>R|
- I |<=R|
- I |==I|
- I |<>I|
- I |>I|
- I |<=I|
- I |>D|
- I |<=D|
- I |>S|
- I |<=S|
- I |>S|

S7-1200

- [-] Compare
- [+] |CMP ==
- [+] |CMP <>
- [+] |CMP >
- [+] |CMP >=
- [+] |CMP <=
- [+] |CMP >
- [+] |CMP <
- [+] |IN_RANGE
- [+] |OUT_RANGE
- [+] |-|OK|-
- [+] |-|NOT_OK|-

Math instructions

- Hardware
- Communication
- HMI
- Memory
- Block concept
- Instruction set**
- New data types
- Timers
- Counters
- Technology
- Resources

What's new?

The S7-1200 Floating Point Math instructions now support the 64 bit LREAL data type.

What's different?

Math instructions

- S7-200: The instruction selection determines the data type.
- S7-1200: The data type is selected after placing the instruction.

Math

S7-200

- Integer Math
 - ADD_I
 - ADD_DI
 - SUB_I
 - SUB_DI
 - MUL
 - MUL_I
 - MUL_DI
 - DIV
 - DIV_I
 - DIV_DI
 - INC_B
 - INC_W
 - INC_DW
 - DEC_B
 - DEC_W
 - DEC_DW

Floating-Point Math

- ADD_R
- SUB_R
- MUL_R
- DIV_R
- SQRT
- SIN
- COS
- TAN
- LN
- EXP
- PID

S7-1200

- Math
 - ADD
 - SUB
 - MUL
 - DIV
 - MOD
 - NEG
 - INC
 - DEC
 - ABS
 - MIN
 - MAX
 - LIMIT
 - SQR
 - SQRT
 - LN
 - EXP
 - SIN
 - COS
 - TAN
 - ASIN
 - ACOS
 - ATAN
 - FRAC
 - EXPT

Move instructions

- Hardware
- Communication
- HMI
- Memory
- Block concept
- Instruction set**
- New data types
- Timers
- Counters
- Technology
- Resources

What's new?

The MOVE instructions now support the 64 bit LREAL data type.

New Move instructions

- UMOVE_BLK (uninterruptible move block)
- UFILL_BLK (uninterruptible fill block)

What's different?

Move instructions

- S7-200: The instruction name determines the data type.
- S7-1200: The data type is selected after placing the instruction.

Move

S7-200

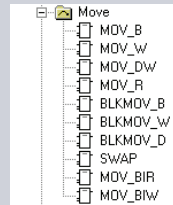

S7-1200

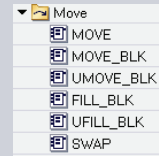

Convert instructions

- Hardware
- Communication
- HMI
- Memory
- Block concept
- Instruction set**
- New data types
- Timers
- Counters
- Technology
- Resources

What's new?

The Convert instructions (except SCALE_X and NORM_X) now support the 64 bit LREAL data type.

New Convert instructions

- CEIL (ceiling) converts a real number to the next higher integer
- FLOOR converts a real number to the next lower integer
- SCALE_X scales a normalized real parameter value
- NORM_X normalizes a parameter value

What's different?

- S7-200: The instruction name determines the data type.
- S7-1200: The data type is selected after placing the instruction.

String Convert instructions

- S7-200: S_I, S_DI, S_R, I_S, DI_S, R_S, ITA, DTA, and RTA
- S7-1200: S_CONV, STRG_VAL, VAL_STRG

- S7-200 conversions instructions ATH, HTA, and SEG are not supported by the S7-1200.

Convert

S7-200

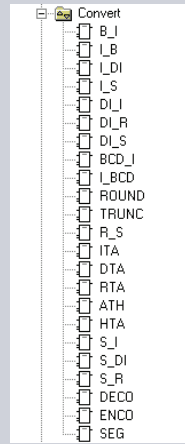

S7-1200

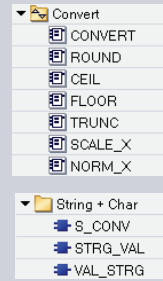

Program Control instructions

- Hardware
- Communication
- HMI
- Memory
- Block concept
- Instruction set**
- New data types
- Timers
- Counters
- Technology
- Resources

What's new?

- JMPN: Jump if no power flow to a JMP coil
- GetError: Get information about program block execution errors
- GetErrorID: Get the ID of an execution error

What's different?

Re-Trigger Cycle Time Monitoring

- S7-200: WDR Watchdog reset
- S7-1200: RE_TRIGR

Terminate execution of current block

- S7-200: END/RET
- S7-1200: RET

Execution control

- S7-200 FOR-NEXT loop instructions are not supported on the S7-1200. This function must be created from Jump, Add, and Compare instructions.
- Sequence Control Relay instructions (SCR, SCRT, SCRE) are not supported in the S7-1200.
- The DIAG_LED Diagnostic LED instruction is not supported in the S7-1200.

Program Control

<p>S7-200</p> <ul style="list-style-type: none"> Program Control <ul style="list-style-type: none"> FOR → {NEXT} → {JMP} LBL SCR → {SCRT} → {SCRE} → {RET} → {END} → {STOP} → {WDR} DIAG_LED 	<p>S7-1200</p> <ul style="list-style-type: none"> Program control <ul style="list-style-type: none"> { } → {JMP} { } → {JMPN} Label { } → {RET} Program control <ul style="list-style-type: none"> RE_TRIGR STP GetError GetErrorID
---	--

Logical operation instructions

- Hardware
- Communication
- HMI
- Memory
- Block concept
- Instruction set**
- New data types
- Timers
- Counters
- Technology
- Resources

What's new?

- SEL select instruction selects one of two inputs
- MUX multiplex instruction selects one of multiple inputs

What's different?

- S7-200: The instruction selection determines the data type.
- S7-1200: The data type is selected after placing the instruction.

AND instruction

- S7-200: WAND_B, WAND_W, WAND_DW
- S7-1200: AND

OR instruction

- S7-200: WOR_B, WOR_W, WOR_DW
- S7-1200: OR

XOR instructions

- S7-200: WXOR_B, WXOR_W, WXOR_DW
- S7-1200: XOR

Invert instruction

- S7-200: INV_B, INV_W, INV_DW
- S7-1200: INVERT

Logical Operations

S7-200	S7-1200
Logical Operations	Logical operations
INV_B	AND
INV_W	OR
INV_DW	XOR
WAND_B	INVERT
WAND_W	DECO
WAND_DW	ENCO
WOR_B	SEL
WOR_W	MUX
WOR_DW	
WXOR_B	
WXOR_W	
WXOR_DW	

Shift + Rotate instructions

- Hardware
- Communication
- HMI
- Memory
- Block concept
- Instruction set**
- New data types
- Timers
- Counters
- Technology
- Resources

What's different?

- * S7-200: The instruction selection determines the data type.
- * S7-1200: The data type is selected after placing the instruction.

Shift Right instruction

- * S7-200: SHR_B, SHR_W, SHR_DW
- * S7-1200: SHR

Shift Left instruction

- * S7-200: SHL_B, SHL_W, SHL_DW
- * S7-1200: SHL

Rotate Right instructions

- * S7-200: ROR_B, ROR_W, ROR_DW
- * S7-1200: ROR

Rotate Left instructions

- * S7-200: ROL_B, ROL_W, ROL_DW
- * S7-1200: ROL

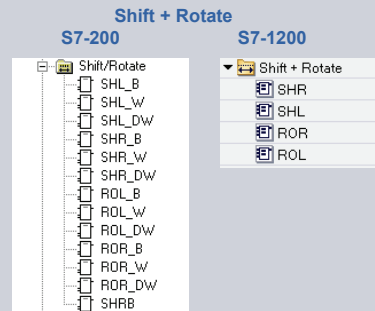

Clock instructions

- Hardware
- Communication
- HMI
- Memory
- Block concept
- Instruction set**
- New data types
- Timers
- Counters
- Technology
- Resources

What's new?

New TIME and DTL (Date and time long) data types

- T_CONV converts data type of time value
- T_ADD adds TIME and DTL values
- T_SUB subtracts TIME and DTL values
- T_DIFF provides difference
- RD_LOC_T read local time

What's different?

Write system time instructions

- S7-200: SET_RTC, SET_RTCX
- S7-1200: WR_SYS_T (write system time)

Read system time instructions

- S7-200: READ_RTC, READ_RTCX
- S7-1200: RD_SYS_T (read system time)

Clock + Calendar S7-200

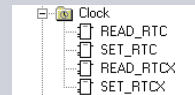

S7-1200

<ul style="list-style-type: none"> Clock + Calendar <ul style="list-style-type: none"> ▪ T_CONV ▪ T_ADD ▪ T_SUB ▪ T_DIFF Clock functions <ul style="list-style-type: none"> ▪ WR_SYS_T ▪ RD_SYS_T ▪ RD_LOC_T

String instructions

- Hardware
- Communication
- HMI
- Memory
- Block concept
- Instruction set**
- New data types
- Timers
- Counters
- Technology
- Resources

What's new?

String data format

- S7-200: Length byte followed by character bytes
- S7-1200: Maximum length byte followed by the actual length byte and character bytes

New String operations

LEFT, RIGHT, DELETE, INSERT, REPLACE, VAL_STRG, STRG_VAL, and S_CONV

What's different?

- S7-200: STR_LEN, STR_CAT, SSTR_CPY
- S7-1200: LEN, CONCAT, MID

FIND substring or character in string

- S7-200: STR_FIND, CHR_FIND
- S7-1200: FIND

Copy string

- S7-200: STR_CPY
- S7-1200: S_CONV (string convert) can have a STRING data type as input and output to "copy" the string.

String + Char

S7-200

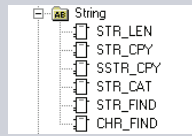

S7-1200



Communications instructions

- Hardware
- Communication
- HMI
- Memory
- Block concept
- Instruction set**
- New data types
- Timers
- Counters
- Technology
- Resources

What's different?

PPI network communication

- S7-200: The integrated PPI network RS485 port is programmed with the NETR, NETW, GET_ADDR, and SET_ADDR instructions.
- S7-1200: The integrated CPU port is now an Ethernet connection. The S7-200 PPI network instructions are not supported in STEP 7 Basic version 10.5.

Point-to-Point (PTP) instructions (Freepoint communications)

- S7-200: XMT, RCV
- S7-1200: PORT_CFG, SEND_CFG, RCV_CFG, SEND_PTP, RCV_PTP, RCV_RST, SGN_GET, and SGN_SET.

Ethernet communication

- S7-200: The Ethernet wizard generates subroutines that operate the Ethernet module.
- The S7-1200 CPU has an integrated PROFINET (Ethernet) port and uses T-BLOCK instructions (for example, TSEND_C, TRCV_C) for network communication.

Valid Ethernet program to program communication paths

- An S7-200 executes ETH0_CTRL / ETH0_XFR subroutines to read from or write to a passive S7-1200
- An S7-300/S7-400 executes GET/PUT to read from or write to a passive S7-1200
- For an S7-1200 connected to a multiple S7-1200/S7-300/S7-400 network, all partner programs can execute T-block instructions to read from and write to each other.

Communications

S7-200	S7-1200

Interrupt instructions

- Hardware
- Communication
- HMI
- Memory
- Block concept
- Instruction set**
- New data types
- Timers
- Counters
- Technology
- Resources

What's different?

Event Interrupt

- S7-200: ATCH and DTCH events 0-7
- S7-1200: Device configuration property assignment

Time Delay Interrupt

- S7-200: ATCH and DTCH (time delay interrupt events 21 and 22)
- S7-1200: SRT_DINT, CAN_DINT

Asynchronous Interrupt Control

- S7-200: ENI and DISI
- S7-1200: DIS_AIRT, EN_AIRT

Terminate Execution of current interrupt block

- S7-200: RETI
- S7-1200: RET

Clear queued Interrupt events

- S7-200: CLR_EVENT
- S7-1200: Current and queued events are cleared by the DETACH instruction.

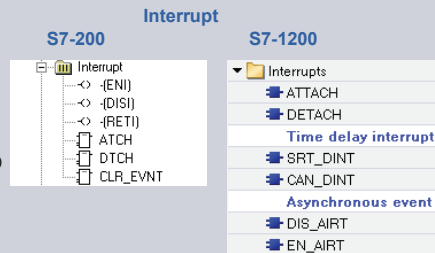

Table and PID Loop control instructions

- Hardware
- Communication
- HMI
- Memory
- Block concept
- Instruction set**
- New data types
- Timers
- Counters
- Technology
- Resources

What's different?

PID instructions

- S7-200: The PID instruction is usually operated with code generated by the STEP 7-Micro/WIN PID wizard.
- S7-1200: PID_Compact smart instruction

Table instructions

- The S7-200 table instructions are not supported in STEP 7 Basic version 10.5.

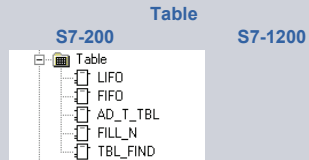

Basic Motion and Pulse instructions

- Hardware
- Communication
- HMI
- Memory
- Block concept
- Instruction set**
- New data types
- Timers
- Counters
- Technology
- Resources

What's different?

Motion control instructions

- S7-200: The EM253 Position module wizard creates subroutines that can be called from your program.
- S7-1200: PLC Open motion control instructions

- S7-200: The motion subroutines are level triggered. An extra edge instruction is required for the trigger signal, if called from the multi-scan Main routine instead of from a single-scan interrupt routine.
- S7-1200: The motion instructions are internally rising edge-triggered. This is not a problem for a multi-scan program block (OB1 for example). However, if a motion instruction is placed in a single-scan interrupt OB, then the instruction must be executed twice in succession to provide an edge signal. If an external motion event triggers a single-scan interrupt block, then execute the motion instruction once with the enable request parameter assigned a constant "1" and once with a constant "0".

Pulse instructions

- S7-200: The PTO/PWM wizard creates subroutines that can be called from your program. Special memory assignments (SM addresses) are used to set the pulse generator configuration and operating parameters.
- S7-1200: Pulse generators are set up in the PLC Device configuration properties. The operating parameters are available as outputs as defined in the configuration properties. The CTRL_PWM instruction starts and stops the pulse generator.

Basic Motion control

EM253 Position wizard subroutines

POSx_CTRL
 POSx_MAN
 POSx_GOTO
 POSx_RUN
 POSx_RSEEK
 POSx_LDPOFF
 POSx_LDPOS
 POSx_SRATE
 POSx_DIS
 POSx_CLR
 POSx_CFG

<ul style="list-style-type: none"> ▼ Motion Control Motion Control MC_Power MC_Reset MC_Home MC_Halt MC_MoveAbsolute MC_MoveRelative MC_MoveVelocity MC_MoveJog
--

Pulse control

PTO/PWM wizard subroutines

PTOx_CTRL
 PTOx_RUN
 PTOx_MAN
 PTOx_LDPOS
 PTOx_ADV
 PWMx_RUN

<ul style="list-style-type: none"> ▼ Pulse CTRL_PWM

Modbus library instructions

- Hardware
- Communication
- HMI
- Memory
- Block concept
- Instruction set**
- New data types
- Timers
- Counters
- Technology
- Resources

What's different?

S7-1200 Modbus library simplified

- MB_COMM_LOAD provides first pass initialization for master and slave operations.
- MB_MASTER and MB_SLAVE control the message and port assignment.

Modbus library

S7-200

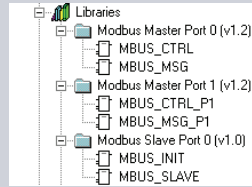

S7-1200

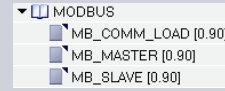

USS drive library instructions

- Hardware
- Communication
- HMI
- Memory
- Block concept
- Instruction set**
- New data types
- Timers
- Counters
- Technology
- Resources

What's different?

- USS_DRV and USS_PORT replace USS_INT and USS_CTRL.
- S7-200: Two fixed PZD parameters (control and speed)
- S7-1200: Added up to eight user-defined PZD parameters
- S7-200: Update rate fixed (as fast as possible)
- S7-1200: Place in a cyclic interrupt OB for user-defined update rate.

One Read instruction

- S7-200: USS_RPM_W_P1
USS_RPM_D_P1
USS_RPM_R_P1
- S7-1200: USS_RPM

One Write instruction

- S7-200: USS_WPM_W_P1
USS_WPM_D_P1
USS_WPM_R_P1
- S7-1200: USS_WPM

USS drive library

S7-200

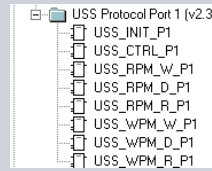

S7-1200

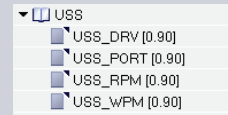

New elementary data types for the S7-1200

- Hardware
- Communication
- HMI
- Memory
- Block concept
- Instruction set
- New data types**
- Timers
- Counters
- Technology
- Resources

Short integer data types can save resources

- **SInt** - Byte size (-128 to 127)

Unsigned data types increase the positive range

- **USInt** - Byte size (0 to 255)
- **UInt** - Word size (0 to 65,535)
- **UDint** - Dword size (0 to 4,294,967,295)

Long Real for greater floating-point precision

- **LReal** - 64 bit size
 $+/-2.2250738585072020 \times 10^{-308}$
to $+/-1.7976931348623157 \times 10^{308}$

Time data type has new entry format and range

- **Time** Dword size
T# -24d_20h_31m_23s_648ms to T# 24d_20h_31m_23s_647ms
stored as -2,147,483,648 ms to +2,147,483,647 ms

ex. T#50ms
T#5m_30s
T#1d_2h_15m_30s_45ms

STEP 7 Basic uses drop list data type selectors

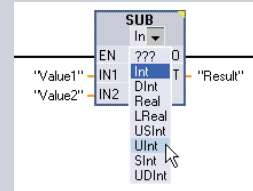

New complex data types for the S7-1200

- Hardware
- Communication
- HMI
- Memory
- Block concept
- Instruction set
- New data types**
- Timers
- Counters
- Technology
- Resources

Array

DTL (Date and Time Long)

Data_block_1			
Name	Data type	Initial value	
1	Static		
2	Byte array test	Array [0 .. 10] of byte	
3	Byte array test[0]	Byte	B#16#00
4	Byte array test[1]	Byte	B#16#00
5	Byte array test[2]	Byte	B#16#00
6	Byte array test[3]	Byte	B#16#00
7	Byte array test[4]	Byte	B#16#00
8	Byte array test[5]	Byte	B#16#00
9	Byte array test[6]	Byte	B#16#00
10	Byte array test[7]	Byte	B#16#00
11	Byte array test[8]	Byte	B#16#00
12	Byte array test[9]	Byte	B#16#00
13	Byte array test[10]	Byte	B#16#00

```

MOVE
EN      ENO
IN      OUT1
"Data_block_1" - IN      OUT1 - # "Byte array target"
    
```

Data_block_1			
Name	Data type	Initial value	
1	Static		
2	Byte array test	Array [0 .. 10] of byte	
3	System Time stamp	DTL	DTL#1970-1-1-0:0:0.0
4	YEAR	USInt	1970
5	MONTH	USInt	1
6	DAY	USInt	1
7	WEEKDAY	USInt	5
8	HOUR	USInt	0
9	MINUTE	USInt	0
10	SECOND	USInt	0
11	NANOSECOND	UDInt	0

```

RD_SYS_T
DTL
EN      ENO
RET_VAL = 3MW2 "Return value"
OUT     "Data_block_1"
        "System Time stamp"
    
```

Symbolic access is available to all elements of an Array or DTL structure

Timer operation S7-200 and S7-1200

SIEMENS

- Hardware
- Communication
- HMI
- Memory
- Block concept
- Instruction set
- New data types
- Timers**
- Counters
- Technology
- Resources

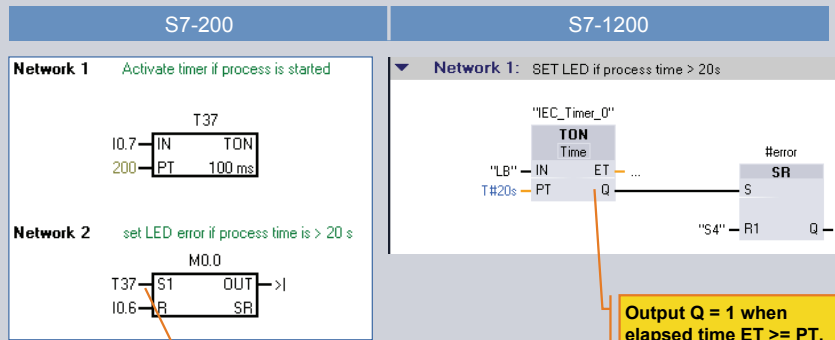

Output Q = 1 when elapsed time ET >= PT.

Timer bit T37 = 1 when current value >= PT.

For STEP 7 Basic, all timers are 1 ms and the time value can be entered directly.
For STEP 7-Micro/WIN, the preset time and current time are entered as a number to be multiplied by a time base (1 / 10 / 100 ms) that depends on the selected timer number.

Counter operation S7-200 and S7-1200



- Hardware
- Communication
- HMI
- Memory
- Block concept
- Instruction set
- New data types
- Timers
- Counters**
- Technology
- Resources

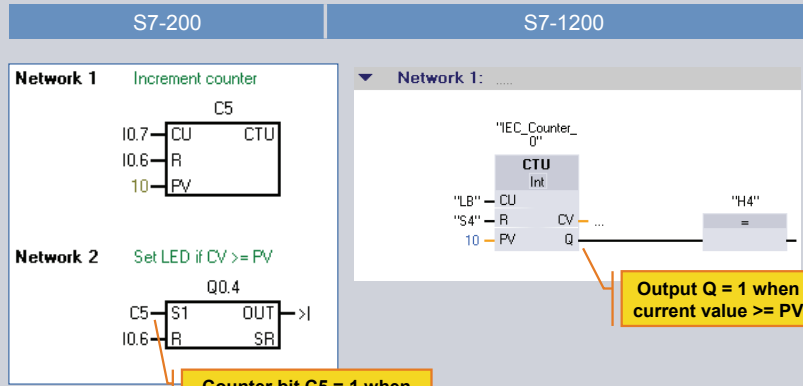

Counter bit C5 = 1 when current value >= PV

Output Q = 1 when current value >= PV

S7-200

- SIMATIC type counter
- Range: 0 – 32767

S7-1200

- IEC type counter
- Range: selectable data type from SINT to UDINT

Count and measure with high-speed counters (HSC)

- Hardware
- Communication
- HMI
- Memory
- Block concept
- Instruction set
- New data types
- Timers
- Counters**
- Technology
- Resources

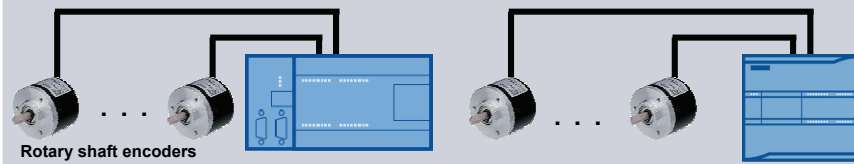

	S7-200 CPU 224XP	S7-1200 CPU 1214C
HSC devices total	6 single-phase or 4 two-phase	6
100kHz. max. single-phase or 80kHz. max. two-phase	2 or 1	3
30kHz. max. single-phase or 20kHz. max. two-phase	4 or 3	3

The two-phase or quadrature encoder is the most widely used of all rotary encoders due to better precision

S7-1200 Axis Technology Object

- Hardware
- Communication
- HMI
- Memory
- Block concept
- Instruction set
- New data types
- Timers
- Counters
- Technology**
- Resources

- S7-200 and STEP 7-Micro/WIN use a Position module and motion control wizard for motion control. You must rerun the wizard to make configuration changes.
- S7-1200 and STEP 7 Basic use integrated pulse outputs and Axis Technology Object configuration for control of stepper motors and servo drives. PLCOpen standard instructions are then placed in your program.

MC_Power	MC_Reset	MC_Home	MC_Halt
EN _____ END _____	EN _____ END _____	EN _____ END _____	EN _____ END _____
Axis _____ Status _____	Axis _____ Done _____	Axis _____ Done _____	Axis _____ Done _____
Enable _____ Error _____	Execute _____ Error _____	Execute _____ Error _____	Execute _____ Error _____
StopMode _____		Position _____	
		Mode _____	

MC_MoveAbsolute	MC_MoveRelative	MC_MoveVelocity	MC_MoveJog
EN _____ END _____	EN _____ END _____	EN _____ END _____	EN _____ END _____
Axis _____ Done _____	Axis _____ Done _____	Axis _____ InVelocity _____	Axis _____ InVelocity _____
Execute _____ Error _____	Execute _____ Error _____	Execute _____ Error _____	JogForward _____ Error _____
Position _____	Distance _____	Velocity _____	JogBackward _____
Velocity _____	Velocity _____	Current _____	Velocity _____

S7-1200 PID controller Technology Object

- Hardware
- Communication
- HMI
- Memory
- Block concept
- Instruction set
- New data types
- Timers
- Counters
- Technology**
- Resources

- S7-200 and STEP 7-Micro/WIN use a PID wizard and PID tune control panel tool for controlling up to eight PID loops.
- S7-1200 and STEP 7 Basic use the PID controller Technology Object configuration for up to 16 PID control loops. The PID_Compact instruction is then placed in your program.

The screenshot displays the STEP 7 software interface. On the left, the project tree shows the 'PID_Compact' instruction under 'Technological Objects'. A context menu is open over the 'PID_Compact' instruction, listing parameters: EN, Setpoint, Input, Input_PER, ENO, Output, Output_PER, Output_PWM, and Error. The main window shows a 'PID_Compact' configuration panel with a 'Sample time' of 300 ms. Below the configuration is a monitoring window with a graph showing 'Segment (Input)' and 'Output (%)' over time. The graph shows a step change in the input signal. The 'Current values' section shows 'Setpoint (%)' at 0, 'Input (%)' at 0, and 'Output (%)' at 0. The 'Optimization' section has radio buttons for 'Startup tuning', 'Tuning in run', and 'Abort tuning', with 'Startup tuning' selected. There is also a 'manual' checkbox.

SIMATIC resources

Hardware
Communication
HMI
Memory
Block concept
Instruction set
New data types
Timers
Counters
Technology
Resources

Refer to the SIMATIC S7-1200 and S7-200 documentation on the Internet at:

<http://www.siemens.com/automation/service&support>

Contact your Siemens distributor or sales office for assistance in answering any technical questions, for training, or for ordering S7 products.