

**SIEMENS**

Catalog  
Extract  
LV 10

Edition  
04/2022

SENTRON • SIVACON • ALPHA

# Low-Voltage Power Distribution and Electrical Installation Technology

Measuring Devices, Power Monitoring and  
Digitalization Solutions

[siemens.com/lowvoltage](https://www.siemens.com/lowvoltage)

# Innovative solutions for industrial controls and power distribution

In ensuring smooth operation of digital production environments and in the construction and operation of industrial or commercial buildings, the underlying power distribution and industrial controls are decisive:

SIRIUS, SENTRON, SIVACON and ALPHA provide a broad portfolio of systems and components for this purpose that can be used for standard-compliant, requirement-based electrification.

Efficient engineering tools and cloud-based solutions are part of the portfolio, which you can flexibly adapt to your specific requirements over the entire value-added process.

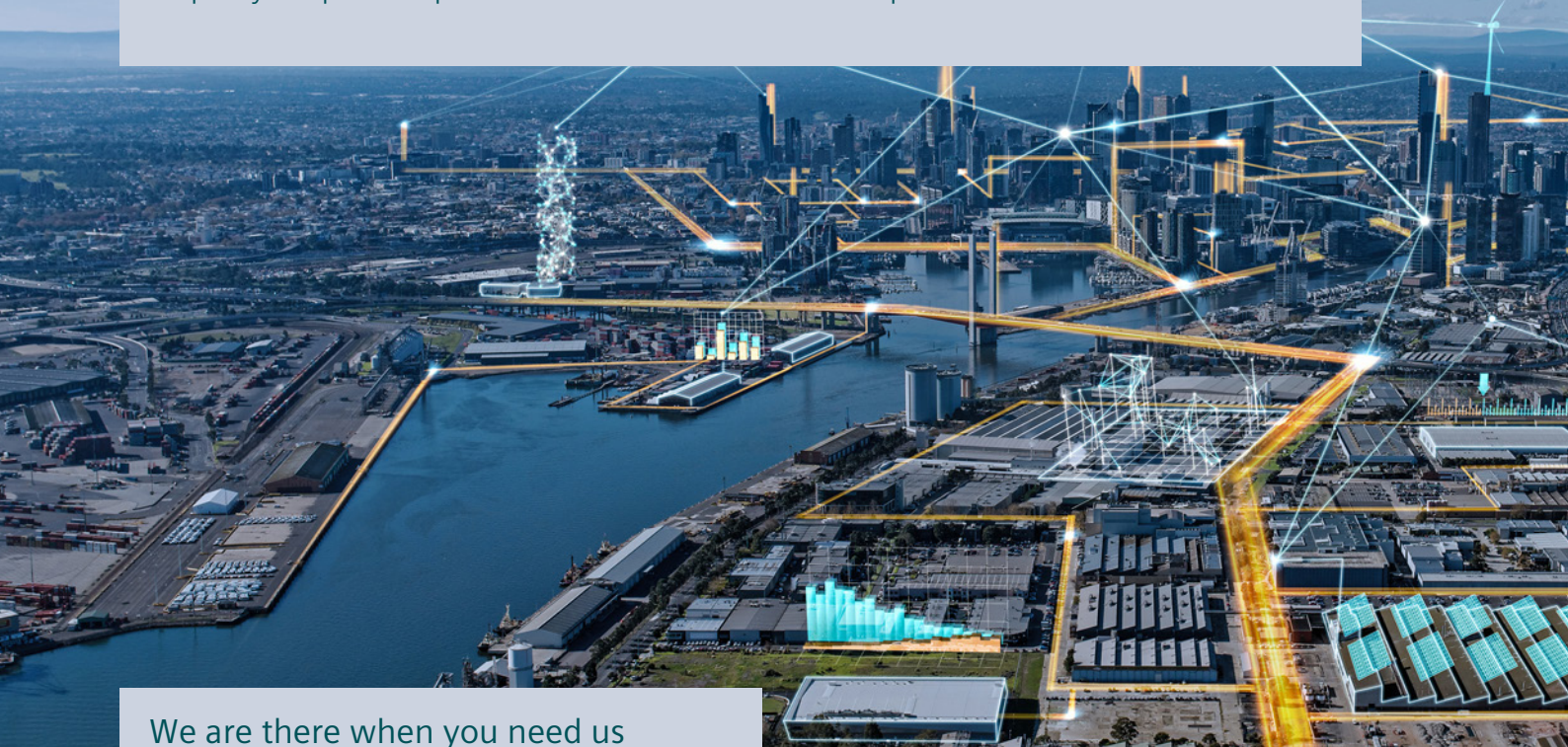

## We are there when you need us

Your personal contact can be found at  
[www.siemens.de/lowvoltage/kontakt](http://www.siemens.de/lowvoltage/kontakt)

## Catalog LV 10 · 04/2022

You will find the latest edition and all future editions in the Siemens Industry Online Support at  
[www.siemens.com/lowvoltage/catalogs](http://www.siemens.com/lowvoltage/catalogs)

Refer to the Industry Mall for current prices  
[www.siemens.de/lowvoltage/mall](http://www.siemens.de/lowvoltage/mall)



The products and systems described in this catalog are manufactured/distributed under application of a certified quality management system in accordance with EN ISO 9001 (for the Certified Registration Nos., see [www.siemens.com/system-certificates/ep](http://www.siemens.com/system-certificates/ep)). The certificate is recognized by all IQNet countries.

### Technical specifications

The technical specifications are for general information purposes only. Always heed the operating instructions and notices on individual products during assembly, operation and maintenance.

All illustrations are not binding.

© Siemens 2022

# Low-Voltage Power Distribution and Electrical Installation Technology

	Introduction	II/2
Protecting	Air Circuit Breakers	1/1
	Molded Case Circuit Breakers	2/1
	Miniature Circuit Breakers	3/1
	Residual Current Protective Devices/Arc Fault Detection Devices (AFDDs)	4/1
	Switching Devices	5/1
	Overvoltage Protection Devices	6/1
	Fuse Systems	7/1
Protecting, Switching and Isolating	Switch Disconnectors	8/1
Switching and Isolating	Transfer Switching Equipment and Load Transfer Switches	9/1
<b>Measuring and Monitoring</b>	<b>Measuring Devices, Power Monitoring and Digitalization Solutions</b>	<b>10/1</b>
	Monitoring Devices	11/1
Distribution	Transformers, Power Supply Units and Socket Outlets	12/1
	Busbar Systems	13/1
	Terminal Blocks	14/1
	Power Distribution Boards, Motor Control Centers and Distribution Boards	15/1
	Busbar Trunking Systems	16/1
	System Cubicles, System Lighting and System Air-Conditioning	17/1
	Appendix	A/1

I

1

2

3

4

5

6

7

8

9

10

11

12

13

14

15

16

17

A



## Easy, reliable, cost-efficient

There are many advantages to be had from keeping a watchful eye on your energy consumption: in addition to cost savings through optimized consumption, you ensure increased resilience with the monitoring of power supply systems and network quality in infrastructure and industrial plants.

At the same time, systematic power monitoring increases your awareness of actual energy consumption, making it a key prerequisite for greater energy efficiency.

Integration into open IoT operating systems such as MindSphere results in even greater optimization potential.

What is more, with a power monitoring system you lay the foundation for regular energy audits and a corporate energy management system according to ISO 50001 and ISO 50003.



# Measuring Devices, Power Monitoring and Digitalization Solutions



All the information you need	10/2
Quick selection guide	10/4
Power monitoring	10/4
Hardware components	10/6
Accessories	10/10
Software and digitalization solutions	10/12
SENTRON powerconfig	10/12
SENTRON powermanager	10/14
7KN Powercenter	10/18
SENTRON powermind	10/20
SIMATIC Energy Suite	10/22
SIMATIC Modbus/TCP SENTRON PAC	10/22
PAC/3WL/3VA SIMATIC PCS 7 library	10/23
Measuring devices	10/24
7KM PAC measuring devices	10/24
7KT PAC measuring devices	10/28
SEM3 multichannel current measuring system	10/30
SEM3T multichannel temperature measuring system <b>new</b>	10/32
Time and pulse counters	10/34
Current transformers	10/36

# A multitude of additional information ...

## Information + ordering

### All the important things at a glance

For information about measuring devices, power monitoring and digitalization solutions, please visit our websites

[www.siemens.com/powermonitoring](http://www.siemens.com/powermonitoring)  
[www.siemens.com/sentron-digital](http://www.siemens.com/sentron-digital)

### Your product in detail

The Siemens Industry Online Support (SIOS) provides comprehensive information

[www.siemens.com/lowvoltage/product-support](http://www.siemens.com/lowvoltage/product-support)

- Technical basic information
  - SENTRON power monitoring and digital solutions [\(109769851\)](#)
- Brochure
  - Reliable, sustainable, and efficient – TÜV-certified power monitoring system in accordance with ISO 50001 [\(109744679\)](#)
  - SENTRON portfolio for power monitoring [\(109744725\)](#)
  - SENTRON powermanager – update and benefit [\(109805178\)](#)

The relevant tender specifications can be found at [www.siemens.com/lowvoltage/tenderspecifications](http://www.siemens.com/lowvoltage/tenderspecifications)

### Siemens YouTube channel

- Power monitoring (general) [bit.ly/2IZ9QqC](https://bit.ly/2IZ9QqC)

### Everything you need for your order

Refer to the Industry Mall for an overview of your products

- Measuring devices and power monitoring [sie.ag/2kTH9Lz](http://sie.ag/2kTH9Lz)
- Digitalization solutions [sie.ag/2olliNi](http://sie.ag/2olliNi)
- Library for SIMATIC [sie.ag/2kpbwcs](http://sie.ag/2kpbwcs)
- SENTRON powermanager/SENTRON powerconfig [sie.ag/2kTJjuF](http://sie.ag/2kTJjuF)

Direct forwarding to the individual products in the Industry Mall by clicking on the article number in the catalog or by entering this web address incl. article number [www.siemens.com/product?Article No.](http://www.siemens.com/product?Article No.)

### The fast track to the experts

#### Contact persons in your region

We offer a comprehensive portfolio of services. You can find your local contacts at

[www.siemens.com/lowvoltage/components/contact](http://www.siemens.com/lowvoltage/components/contact)

You can find further information on services at [www.siemens.com/service-catalog](http://www.siemens.com/service-catalog)

Competent expert advice on technical questions with a wide range of demand-optimized services for all our products and systems.

Assistance with technical queries is provided at [www.siemens.com/support-request](http://www.siemens.com/support-request)

# ... can be found in our online services

## Commissioning + operation

### Your product in detail

The Siemens Industry Online Support (SIOS) provides detailed technical information  
[www.siemens.com/lowvoltage/product-support](http://www.siemens.com/lowvoltage/product-support)

- Operating instructions
- Certificates

Comprehensive mobile support via the Siemens Industry Online Support app available for download from the [App Store](#) and [Play Store](#)

You will find further information under:  
[www.siemens.com/support-app](http://www.siemens.com/support-app)

Provision of 3D data (step and u3d data formats)

- Siemens Industry Mall  
[www.siemens.com/lowvoltage/mall](http://www.siemens.com/lowvoltage/mall)
- Image database  
[www.siemens.com/lowvoltage/picturedb](http://www.siemens.com/lowvoltage/picturedb)

Engineering data for CAD or CAE systems are available in the CAx Download Manager at  
[www.siemens.com/cax](http://www.siemens.com/cax)

### Face-to-face or online training

Our training courses can be found at  
[www.siemens.com/sitrain-lowvoltage](http://www.siemens.com/sitrain-lowvoltage)

- SENTRON circuit protection devices with measuring and communication function (WT-LVBCOM)
- Power Monitoring with SENTRON (WT-LVAEM)
- Energy Management with Powermanager 5.x – User training (LV-PM5)
- Energy Management with Powermanager 5.x including graphic module – User training (LV-PM5-G)
- Communication with SENTRON components (LV-COM)

### SENTRON powerconfig

The combined commissioning and service tool SENTRON powerconfig for communication-capable measuring devices, circuit protection devices and circuit breakers.

Free download SENTRON powerconfig via  
[www.siemens.com/powerconfig](http://www.siemens.com/powerconfig)

Free download SENTRON powerconfig mobile via [App Store](#) and [Play Store](#)

### Manuals

Manuals are available for downloading in Siemens Industry Online Support at  
[www.siemens.com/lowvoltage/manuals](http://www.siemens.com/lowvoltage/manuals)

- Configuration manual
  - Measuring devices and power monitoring (45315973)
- Equipment manual
  - 7KT PAC1600 energy meter (109759827)
  - 7KT PAC1600 multimeter (109760293)
  - PAC2200 measuring device (109746835)
  - 7KM Power Monitoring Device PAC2200CLP (109783220)
  - SENTRON PAC3200 power monitoring device (26504150)
  - PAC3200T measuring device (109746833)
  - PAC3100 measuring device (37881976)
  - SENTRON PAC5100/5200 7KM5212/5412 (109477872)
  - 7KM PAC3120 and 7KM PAC3220 (109767307)
  - 7KN POWERCENTER 3000 (109763838)
- System manual
  - 7KT multichannel current measuring system (109483442)
  - SENTRON PAC4200 power monitoring devices (34261595)
  - Circuit protection devices with communication and measuring function (109791806)
- Communication manual
  - SENTRON PAC5100/5200 7KM5212/5412 (109477870)
  - 3VA molded case circuit breakers with IEC and UL certification (98746267)
- SEM3™
  - Embedded Micro Metering Module™ (109748928)
- Quick Installation Guide
  - 7KN POWERCENTER 3000 (109766001)
- Installation manual
  - Circuit protection devices with communication and measuring function (109791805)

### Technical overview – Measuring devices, power monitoring and digitalization solutions



#### The fast way to get you to our online services

This page provides you with comprehensive information and links on measuring devices, power monitoring and digitalization solutions

[www.siemens.com/lowvoltage/product-support](http://www.siemens.com/lowvoltage/product-support) (109764480)

# Power monitoring

## Software

### Local monitoring systems

#### Web



Web interface integrated

#### Mobile App



SENTRON powerconfig

### Functions for power monitoring

Commissioning of measuring devices and circuit breakers	–	■
Displaying current data	■	■
Displaying/evaluating current/historical values	■	■
Prepared analyses/reports	–	–
Customized reporting	–	–
Data analysis in the cloud	–	–

### Additionally for energy management

Switching loads on and off

–

–

### Operating environment

Use

Free of charge

Free of charge

System requirements

Browser

Android, iOS

Suitable according to ISO 50001

–

–

Connection of non-Siemens devices

–

–

Integrated cloud interface

–

–

More information

From page 10/12

## Measuring devices, circuit breakers and circuit protection devices

### Measuring devices for industrial applications



7KM PAC1020

–

–

7KM PAC2200/PAC2200 CLP

■

■<sup>1) 2)</sup>

7KM PAC3200T

■

■<sup>1)</sup>

7KM PAC3120

–

■<sup>2)</sup>

7KM PAC3220

■

■

7KM PAC4200

■

■

7KM PAC5200

■

–

### Measuring devices for buildings and infrastructure



7KT PAC1200

■

–

7KT PAC1600

–

–

SEM3/SEM3T **new**

■

–

### Circuit breakers



3WA

–

■

3WL

–

■

3WL10/3VA27

–

–

3VA ETU5/8

–

■

### Communication-capable circuit protection device



7KN Powercenter 1000/

–

■

5ST3 COM AS+FC/

5SL6 COM MCB/

5SV6 COM AFDD/

3NA COM Fuse

### Other Modbus devices

–

–

■ Function available

– Function not available

<sup>1)</sup> Via WiFi

<sup>2)</sup> Via gateway (PAC4200)

<sup>3)</sup> Incl. module for Desigo CC building management

<sup>4)</sup> Via XML/JSON

<sup>5)</sup> Via SPP2000



PC-based			Cloud	World of SIMATIC	
SENTRON powerconfig	SENTRON powermanager <sup>3)</sup>	7KN Powercenter 3000	SENTRON powermind (MindSphere)	TIA Portal	
				SIMATIC TIA Portal integrated	SIMATIC TIA Portal capable
■	-	-	-	■	-
■	■	■	■	■	■
■	■	■	■	■	■
-	■	-	■	■	-
-	■	-	-	-	-
-	-	-	■	-	-
-	■	-	-	■	■
Free of charge	License and trial license	-	Subscription	-	-
Windows X64	Windows X64	-	Browser	-	-
-	■ (TÜV)	■	■	-	-
-	■	■	■	-	-
-	■	■	■	-	-
From page 10/12	From page 10/14	From page 10/18	From page 10/20		
■	■ <sup>4)</sup>	■	■	-	-
■	■	■	■	-	■ <sup>5)</sup>
■	■	■	■	-	■ <sup>5)</sup>
■	■	■	■	-	-
■	■	■	■	■	■
■	■	■	■	■	■
■	■	-	-	-	-
■	■	■	-	-	-
■	■	■	-	-	-
-	■/■ <sup>4)</sup>	-	-	-	-
■	■	■	■	-	■
■	■	■	■	■	■
■	■	-	-	-	■
■	■	■	■	■	■
■	■ <sup>4)</sup>	■	■	-	-
■	■	■	■	-	-

# Hardware components



Type of mounting	7KM PAC1020	7KM PAC2200	7KM PAC2200 CLP	7KM PAC3200T	7KM PAC3120	7KM PAC3220
Front mounting   DIN rail   Screw mounting	■   -   -	-   ■   -	-   ■   -	-   ■   -	■   -   -	■   -   -
Withdrawable   Fixed-mounted	-   -	-   -	-   -	-   -	-   -	-   -
<b>Measuring connection</b>						
Direct measurement	-	■	■	-	-	-
Transformer measurement	■	■	■	■	■	■
Multichannel measuring system	-	-	-	-	-	-
<b>Suitable transformers</b>						
Window-type current transformers	■	■	■	■	■	■
Folding transformer	■	■	■	■	■	■
Integrated transformer	-	-	-	-	-	-
<b>Commissioning</b>						
MID version	-   -	■   -	■   ■	-   -	-   -	-   -
Max. input voltage L-L/L-N	400 V/230 V	400 V/230 V	400 V/230 V	400 V/230 V	690 V/400 V	690 V/400 V
Transformer connection version	x/1 A or x/5 A	x/1 A or x/5 A	x/1 A or x/5 A	x/1 A or x/5 A	x/1 A or x/5 A	x/1 A or x/5 A
Direct connection version	-	65 A	65 A	-	-	-
DC power supply unit with extra-low voltage version	-	-	-	-	24 ... 60 V DC ±20 %	24 ... 60 V DC ±20 %
1-phase counter version	-	■	■	-	-	-
Electrically isolated voltage inputs	-	-	-	-	-	-
Version without display (for web interface)	-	-	-	■	-	-
<b>Evaluation</b>						
<b>Measured quantities</b>						
Average value of measured values	-	■	■	■	■	■
Voltage, current, frequency	■	■	■	■	■	■
Power, power factor	■	■	■	■	■	■
<b>Energy measurement</b>						
Daily energy storage	-	60 days	60 days	60 days	60 days	60 days
Apparent   Active   Reactive energy   p.f.	-   ■   ■   -	■   ■   ■   -	■   ■   ■   -	■   ■   ■   -	■   ■   ■   ■	■   ■   ■   ■
Distortion factor THD (voltage, current)	-	-	-	■	■	■
Harmonics (voltage, current)	-	-	-	-	-	-
Phase angle/phase chart	-	-	-	-	-	-
Load profile recording	-	-	■	-	-	-
Flicker acc. to IEC 61000-4-15	-	-	-	-	-	-
<b>Monitoring functions</b>						
Operating hours counter	-	-	-	■	■	■
Limit monitoring	-	-	-	■	■	■
Logic functions	-	-	-	■	■	■
Event log	-	-	-	-	-	-
Gateway function	-	-	-	-	-	-
Reporting acc. to EN 50160	-	-	-	-	-	-
Integrated fault recorder	-	-	-	-	-	-
<b>Integrated communication interfaces</b>						
Digital inputs/digital outputs	1/1	1/1	1/1	1/1	2/2	2/2
SO interface	■	■	■	■	■	■
M-Bus	-	■	-	-	-	-
RS485 (Modbus RTU)	■	■	-	-	■	-
Ethernet with Modbus TCP	-	■	■	■	-	■
BACnet	-	-	-	-	-	-
<b>More information</b>						
	See page 10/24	See page 10/24	See page 10/24	See page 10/24	See page 10/24	See page 10/24

Industry

Buildings and infrastructure

Circuit breakers



7KM  
PAC4200

7KM  
PAC5200

7KT  
PAC1200

7KT  
PAC1600

SEM3

3WA

3WL

3WL10/  
3VA27

3VA ETU8

■ - -	■ ■ -	- ■ -	- ■ -	- - ■	- - -	- - -	- - -	- - -
- -	- -	- -	- -	- -	■ ■	■ ■	■ ■	- ■
-	-	■	■	-	-	-	-	-
■	■	■	■	-	■	■	■	■
-	-	■	-	■	-	-	-	-
■	■	■	■	■	-	-	-	-
■	■	■	■	■	-	-	-	-
-	-	■	-	■	■	■	■	■
- -	- -	- -	■ -	- -	- -	- -	- -	- -
690 V/400 V x/1 A or x/5 A	690 V/400 V x/1 A or x/5 A	400 V/230 V x/5 A 40/63 A	400 V/230 V x/5 A 63/80 A	480 V/277 V 50...1200 A/0.1 A	1000 V/577 V integrated	690 V/400 V integrated	690 V/400 V integrated	690 V/400 V integrated
-	-	-	-	-	-	-	-	-
22 ... 65 V DC	-	-	-	-	24 V DC	24 V DC	24 V DC	24 V DC
-	-	■	■	■	-	-	-	-
-	■	-	-	-	-	-	-	-
-	■	■	-	■	-	-	-	-
■	-	-	-	-	■	■	-	-
■	■	■	■	■	■	■	■	■
■	■	■	■	■	■	■	■	■
-	-	-	-	-	-	-	-	-
■ ■ ■ ■ ■	■ ■ ■ ■ ■	- ■ ■ ■ ■	■ ■ ■ ■ ■	■ ■ ■ ■ ■	■ ■ ■ ■ ■	■ ■ ■ ■ ■	■ ■ ■ ■ ■	■ ■ ■ ■ ■
■	■	-	-	-	■	■	-	■
2nd to 64th	2nd to 40th	-	-	-	2nd to 31st	2nd to 29th	-	-
■	■	-	-	-	-	-	-	-
■	■	-	-	-	■	■	■	■
-	■	-	-	-	-	-	-	-
■	-	-	■	-	■	■	-	■
■	■	-	■	-	-	■	■	■
■	■	-	-	■	-	-	-	-
>4000 events	■	-	-	■	-	■	■	■
■	■	-	-	-	-	-	-	-
■	■	-	-	-	-	-	-	-
2/2	0/2	-	1/1	2/1	■	■	■	■
■	-	-	■	-	■	-	■	■
-	-	-	■	-	-	-	-	-
-	-	-	■	-	-	■	■	■
■	■	■	-	■	■	■	■	■
-	-	-	-	■	-	-	-	-

See page 10/24   See page 10/24   See page 10/29   See page 10/28   See page 10/30   See page 1/4   Siehe Seite 1/56   Siehe Seite 1/56  
See page 2/6   See page 2/6

# Hardware components

## Circuit protection devices



7KN Powercenter 1000

5ST3 COM auxiliary  
switches and fault  
signal contacts

5SV6 COM AFDD/MCB

### Communication interfaces

Wireless	■	■	■
Modbus TCP	■	-	-
Bluetooth	■	-	-
Gateway function	■	-	-

### Type of mounting

DIN rail	■	■	■
Busbars	-	-	-

### Evaluation

Temperatures	-	■	■
Current	-	-	■
Voltage	-	-	■
Frequency	-	-	■
Apparent, reactive and active power, power factor	-	-	■
Reactive and active energy	-	-	■

### Monitoring functions

Operating hours counter	■	■	■
Operating hours counter with load current	-	-	■
Operating cycle counter	-	■	■
Trip counter	-	■	■
Short-circuit trip counter	-	-	■
Alarms for limit monitoring	■	■	■
Detection of overload and short circuit	-	-	■
Detection of arcing faults	-	-	■

### More information

See page 10/19

See page 3/50 and 4/62

See page 4/54

<sup>1)</sup> Protection function provided, but tripping is not communicated

## Circuit protection devices



**5SL6 COM miniature circuit breakers**

**3NA COM fuses**

5SL6 COM miniature circuit breakers	3NA COM fuses
■	■
-	-
-	-
-	-
■	-
-	■
■	■
■	■
■	-
■	-
■	-
■	-
■	-
■	-
■	■
■	■
■	-
■	-
■	-
■	■
■	- <sup>1)</sup>
-	-
See page 3/38	See page 7/50

# Accessories

## Communication modules











**7KM Switched Ethernet  
PROFINET/Modbus TCP**

**7KM  
PROFIBUS DP**



**7KM RS485  
Modbus RTU**

**SETRON PROFINET  
Proxy SPP2000 new**



### Industry

	7KM PAC1020	-	-	-	-
	7KM PAC2200	-	-	-	■
	7KM PAC2200 CLP	-	-	-	■
	7KM PAC3200T	-	-	-	■
	7KM PAC3120	-	-	-	-
	7KM PAC3220	■	■	■	-
	7KM PAC4200	■	■	■	-
	7KM PAC5200	-	-	-	-

### Buildings and infrastructure

	7KT PAC1200	-	-	-	-
	7KT PAC1600	-	-	-	-
	SEM3	-	-	-	-

### Circuit breakers

	3WA/3WL	-	-	-	-
	3WL10/3VA27	-	-	-	-
	3VA ETU5/8	■	■	■	-

Expansion modules



Current transformers



**7KM PAC  
4DI/2DO**

**7KM PAC  
I(N), I(Diff), analog**

**4NC**

**7KT**

**3NJ calibrated**

-	-	■	■	■
-	-	■	■	■
-	-	-	-	■
-	-	■	■	■
-	-	■	■	■
■	■	■	■	■
■	■	■	■	■
-	-	■	■	■
-	-	-	-	-
-	-	■	■	■
-	-	-	-	-
-	-	-	-	-
-	-	-	-	-
-	-	-	-	-

# SENTRON powerconfig

## Configuration software for commissioning and maintenance

SENTRON powerconfig is available free of charge at [www.siemens.com/powerconfig](http://www.siemens.com/powerconfig)

You can find more information on the Internet at [www.siemens.com/sentron](http://www.siemens.com/sentron)

Free download SENTRON powerconfig mobile via:



App Store



Play Store

- Software tool for the efficient commissioning and diagnostics of communication-capable SENTRON components
- Supports all electronic SENTRON devices, e.g. 3WA, 3WL, 3VA, 7KN Powercenter 3000 and 7KN Powercenter 1000, with 5ST3 AS+FC COM, 5SL6 MCB COM, 5SV6 AFDD COM and 3NA Fuse COM
- General range of functions:
  - User-friendly parameter assignment even for complex devices such as the 3WA
  - Fast, optical detection of communication and metering-capable circuit protection devices, such as 7KN Powercenter 1000
  - Saving and printing of device settings
  - Monitoring, saving and printing of instantaneous measured quantities
  - Execution of specific device functions, such as resetting of devices and setting of energy counters
- Service functions:
  - Detection of devices and acquisition of measured quantities and status information via different networks, e.g. via Ethernet
  - Device and status acquisition via local interfaces, such as Bluetooth and USB
  - Acquisition and archiving of historic records, such as load profiles and events
  - Firmware updates
  - Switching of language packs for 7KM PAC measuring devices
- Cooperative interaction between powerconfig mobile and powerconfig on the PC:
  - powerconfig mobile offers a high degree of mobile versatility, e.g. to scan codes on the circuit protection devices
  - powerconfig on the PC can be used for subsequent editing and archiving of the system configuration



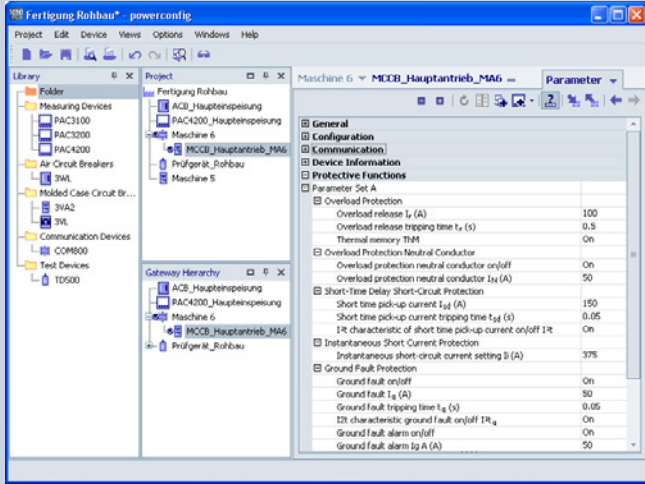

Setting of parameter values

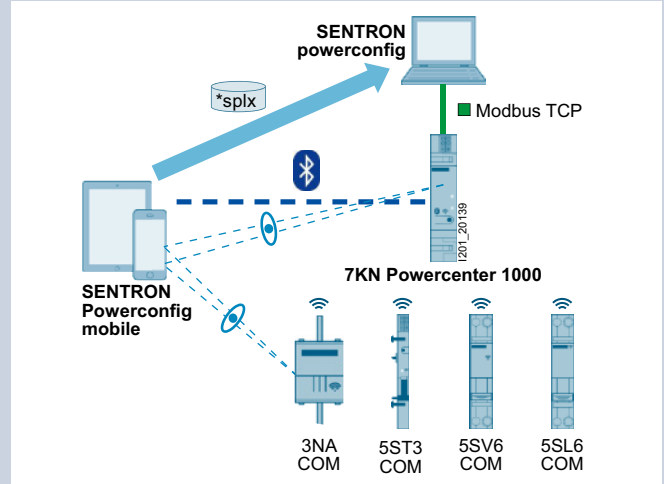

Scanning of circuit protection devices

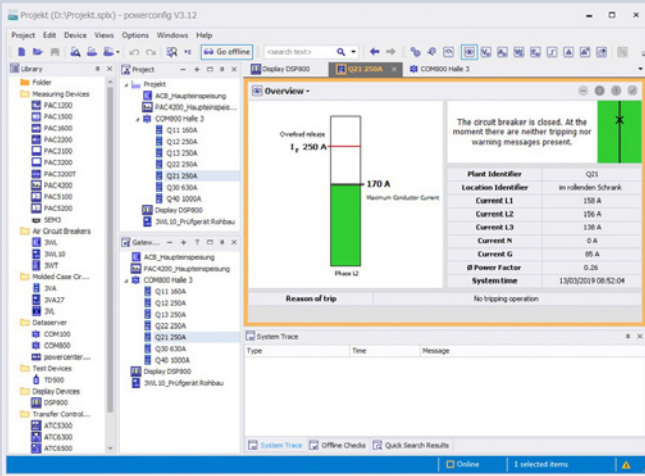

Display of the circuit breaker status

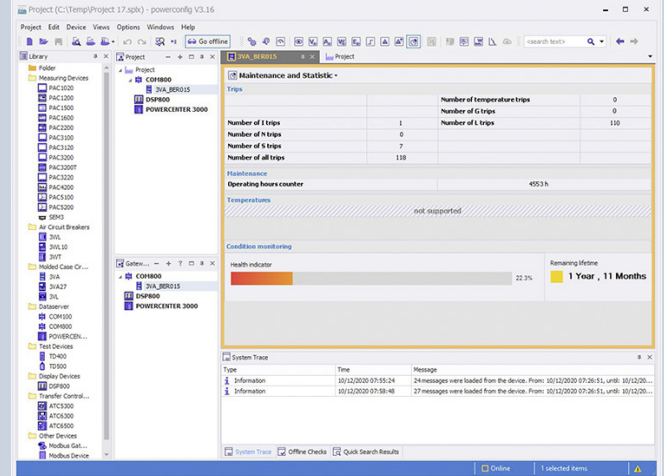

Display of the state of health of the 3VA

10

# SENTRON powermanager

## PC-based power monitoring software



### SENTRON powermanager

SENTRON powermanager is based on the modern Desigo CC platform with advanced graphical capabilities and a standard SQL database. The workflows for setting up the system, creating devices, graphically displaying the device data and processing it in reports have been fundamentally revised.

You can find the latest download and change information in the SIOS portal at

[www.siemens.com/lowvoltage/product-support](http://www.siemens.com/lowvoltage/product-support) (109771760)

Updates and upgrades of version 4.x or higher are based on the SUS/SUR principles.

You can find more information in the brochure – SENTRON powermanager – update and benefit

[www.siemens.com/lowvoltage/product-support](http://www.siemens.com/lowvoltage/product-support) (109805178)

If you wish to migrate from classic powermanager (3.6) to the current version, please get in touch with your local Siemens contact.

The „Trial“ license gives customers the opportunity to gain initial experience with SENTRON powermanager during a 60-day test phase. The application can still be used by purchasing a regular license.

You can find more information on the Internet at

[www.siemens.com/powermanager](http://www.siemens.com/powermanager)

You can find training courses on the Internet at

[www.siemens.com/sittrain-lowvoltage](http://www.siemens.com/sittrain-lowvoltage)

Version	Description	Article No.
<b>powermanager</b>		
Extended Package	Full product license for up to 10 devices, installation for client/server, web access	7KN2710-2CE40-0YC0
Trial license	Full product license limited to 60 days for up to 10 devices, incl. all functions; software download via SIOS Portal <a href="http://www.siemens.com/lowvoltage/product-support">www.siemens.com/lowvoltage/product-support</a> (109771760)  A free license for one-time use (limited to 60 days) must also be requested via <a href="mailto:powermanagerlicence.de@siemens.com">powermanagerlicence.de@siemens.com</a>	
<b>Device expansions</b>		
Device Pack (20)	Device expansion license for up to 20 devices	7KN2711-1CE40-0YC0
Device Pack (50)	Device expansion license for up to 50 devices	7KN2711-2CE40-0YC0
Device Pack (100)	Device expansion license for up to 100 devices	7KN2711-3CE40-0YC0
Device Pack (200)	Device expansion license for up to 200 devices	7KN2711-4CE40-0YC0
Device Pack (500)	Device expansion license for up to 500 devices	7KN2711-5CE40-0YC0
Device Pack (1000)	Device expansion license for up to 1000 devices	7KN2711-6CE40-0YC0
<b>Option packs</b>		
"Graphics Editor 60 Days" option pack	Option for creating any number of freely configured graphics, validity period limited to 60 days	7KN2712-0CE40-0YC0
"Graphics Editor Unlimited" option pack	Option for creating custom-made SENTRON powermanager applications, e.g. graphics; especially suitable for partners such as Solution Providers, control cabinet builders, etc.	7KN2712-0CE40-0YC1
"Client (2)" option pack	Expansion for up to 2 clients	7KN2712-1CE40-0YC0
"Client (5)" option pack	Expansion for up to 5 clients	7KN2712-2CE40-0YC0
"powermanager Server" option pack	Additionally, powermanager server license for distributed systems without devices, web, etc.	7KN2712-4CE40-0YC0
Powermanager SUR-Unit	Update – Extend subscription period by 12 months	7KN2713-7CE40-0YC0 <b>new</b>
Powermanager SUS-Unit	Update – Start new 12-month subscription period	7KN2713-8CE40-0YC0 <b>new</b>
<b>System packages</b>		
System 1	Package comprising 1× powermanager Extended 1× PAC4200 1× PAC3120 1× RS485 modules	7KN2715-1CE40-0YC0
System 3	Package comprising 1× powermanager Extended 3× PAC3220	7KN2715-3CE40-0YC0
System 4	Package comprising 1× powermanager Extended 1× PAC4200 4× PAC1600 1× RS485 module	7KN2715-4CE40-0YC0
System 5	Package comprising 1× powermanager Extended 5× PAC2200 transformer measurement Modbus TCP	7KN2715-5CE40-0YC0



powermanager – Measuring device diagram

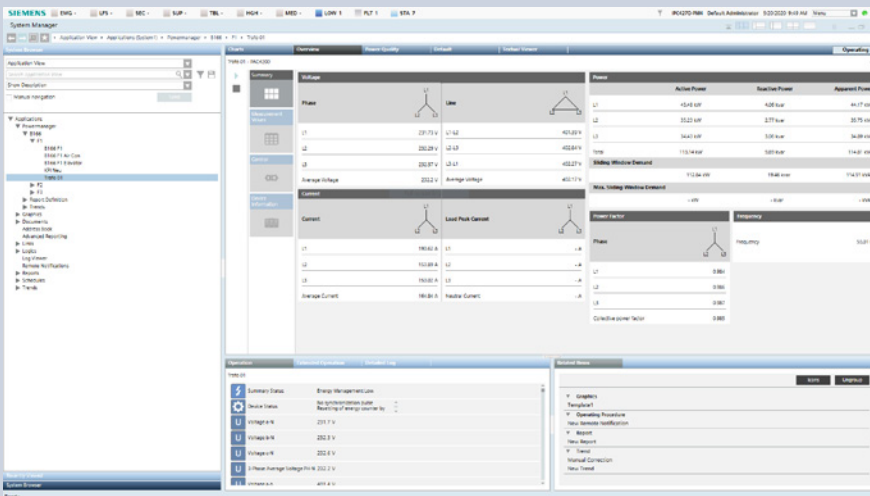

powermanager – Overview of measuring devices

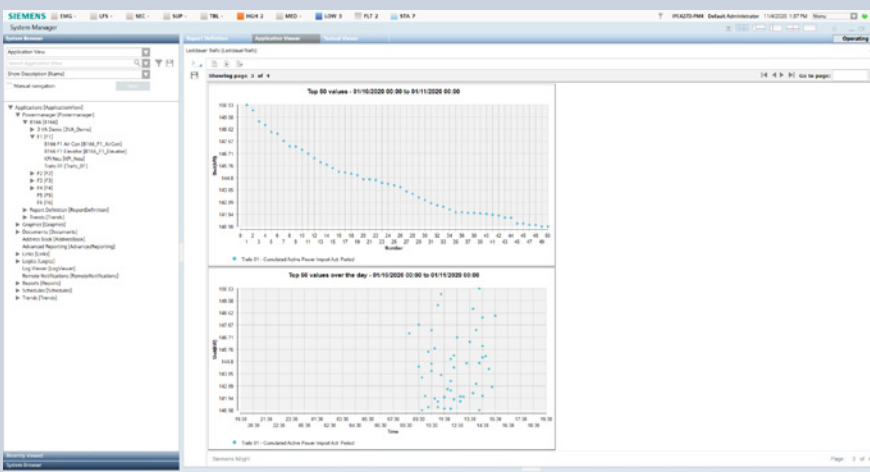

powermanager – Load duration report

10

# SENTRON powermanager

PC-based power monitoring software

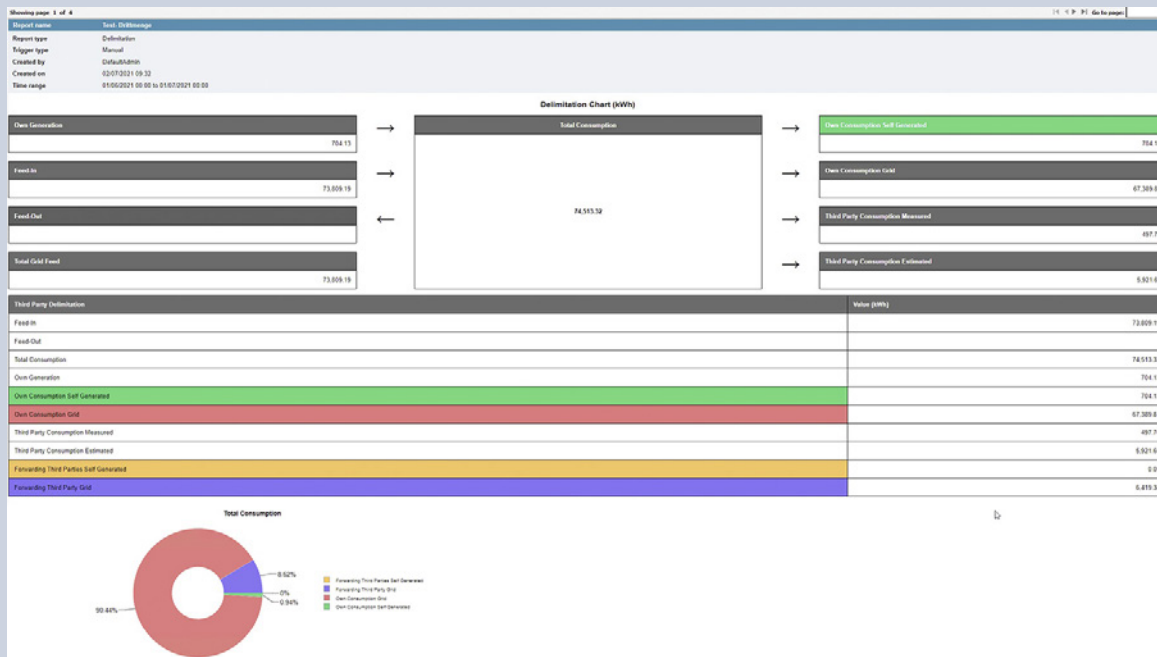

10

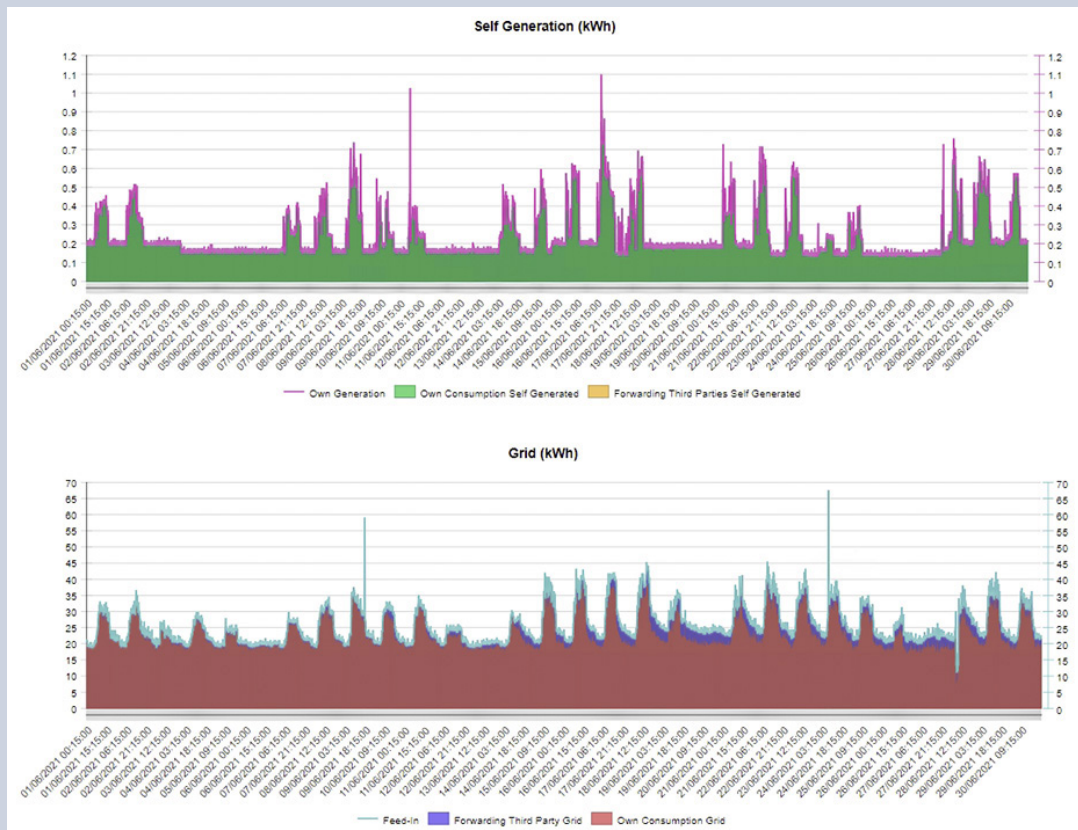

Third-party quantity report

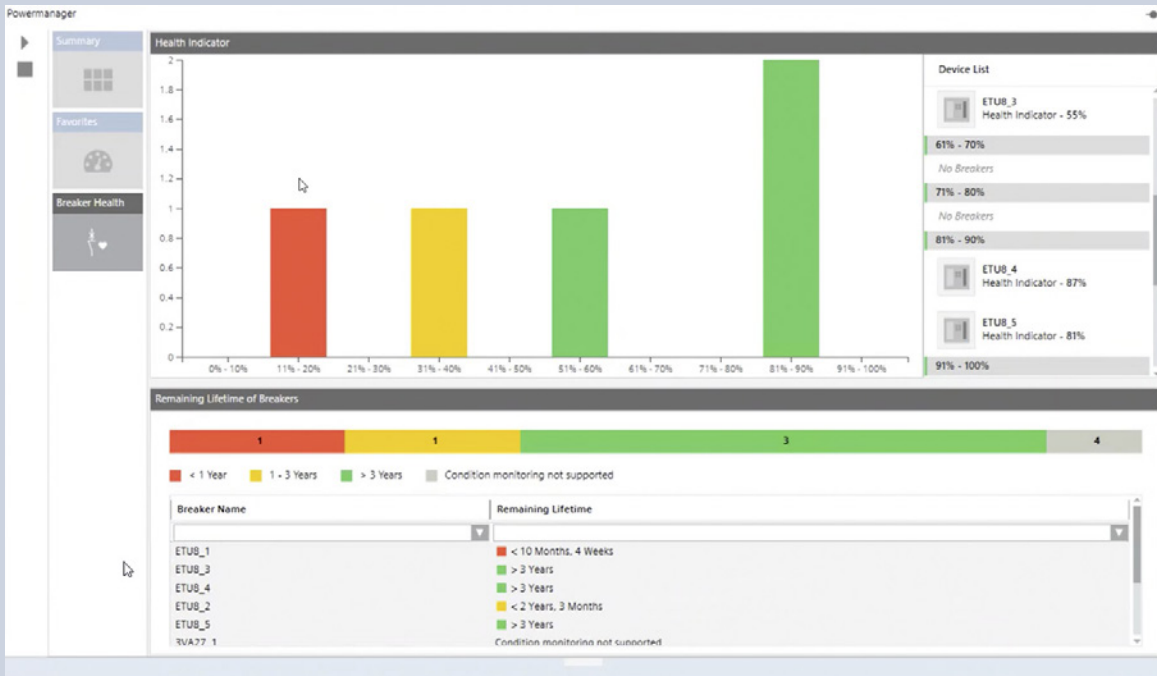

Health Dashboard

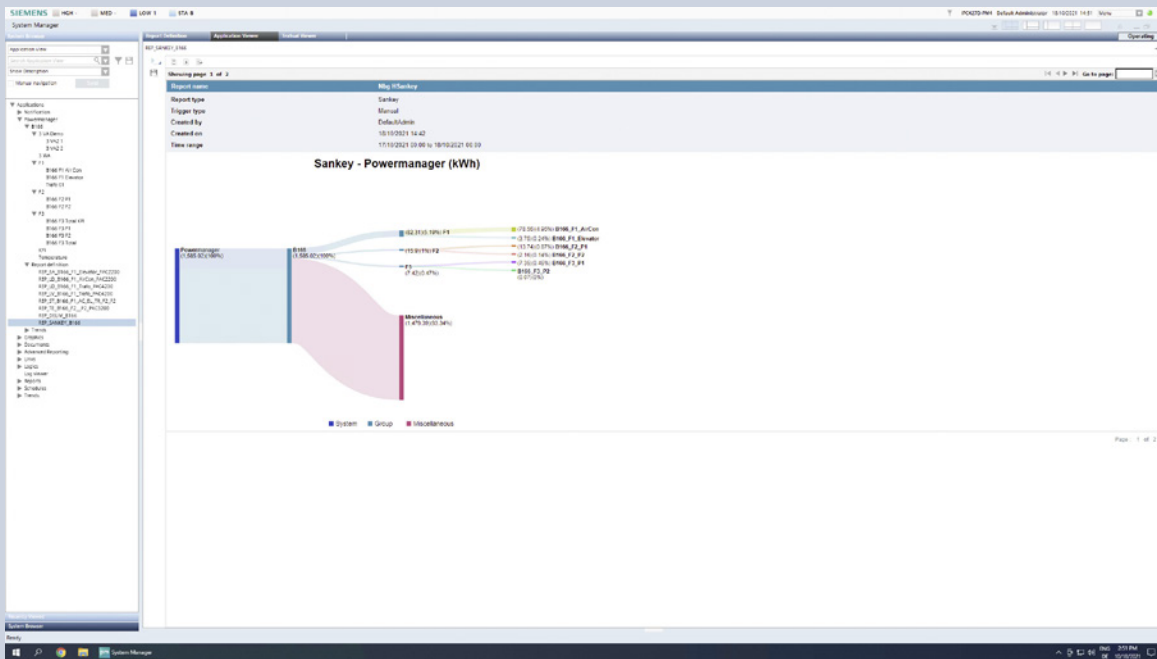

Sankey Report

# 7KN Powercenter

## Edge/IoT-based data acquisition and visualization for low-voltage power distribution

### 7KN Powercenter 3000

#### Areas of use and applications

- Basis for certified energy management according to ISO 50001 to improve energy efficiency and optimize maintenance management
- Transparency and fault localization in single and distributed locations
- Future-proof foundation for expanding data analysis from on-site analysis to cloud-based analysis

#### Features

- Data acquisition/provision
  - All key data of lower-level devices
  - 15-minute energy values as a basis for ISO 50001
  - Export in form of CSV file (once, periodically)
- Visualization/data analysis
  - On the web interface (for all devices or for each device individually)
  - Analysis of data in graphical form, e.g. lines, bars, heatmap, Sankey diagram
  - Can also be output as a report
- Interfaces for the digitalization of low-voltage
  - Integrated and easy-to-configure communication with SENTRON powermind (see separate section)
  - To other cloud applications, e.g. based on AWS, Azure, AliCloud, etc.

– Via Modbus TCP for other applications, e.g. SENTRON powermanager

#### General:

- Easy commissioning using powerconfig
- Compact design, 24 V DC supply
- Web interface in 10 languages
- Flexible IT security features for protection against unauthorized access

More information: [www.siemens.com/powermonitoring](http://www.siemens.com/powermonitoring)

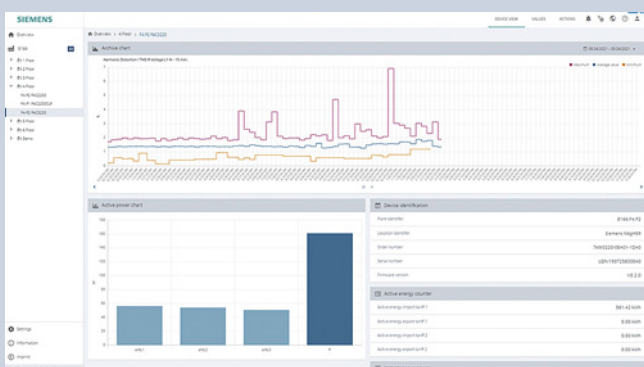

Data visualization based on the example of a measuring device

Mounting	Interfaces	Protocols	Article No.
DIN-rail mounting	2x Ethernet	Modbus TCP, http, MindSphere	7KN1310-0MC00-0AA8

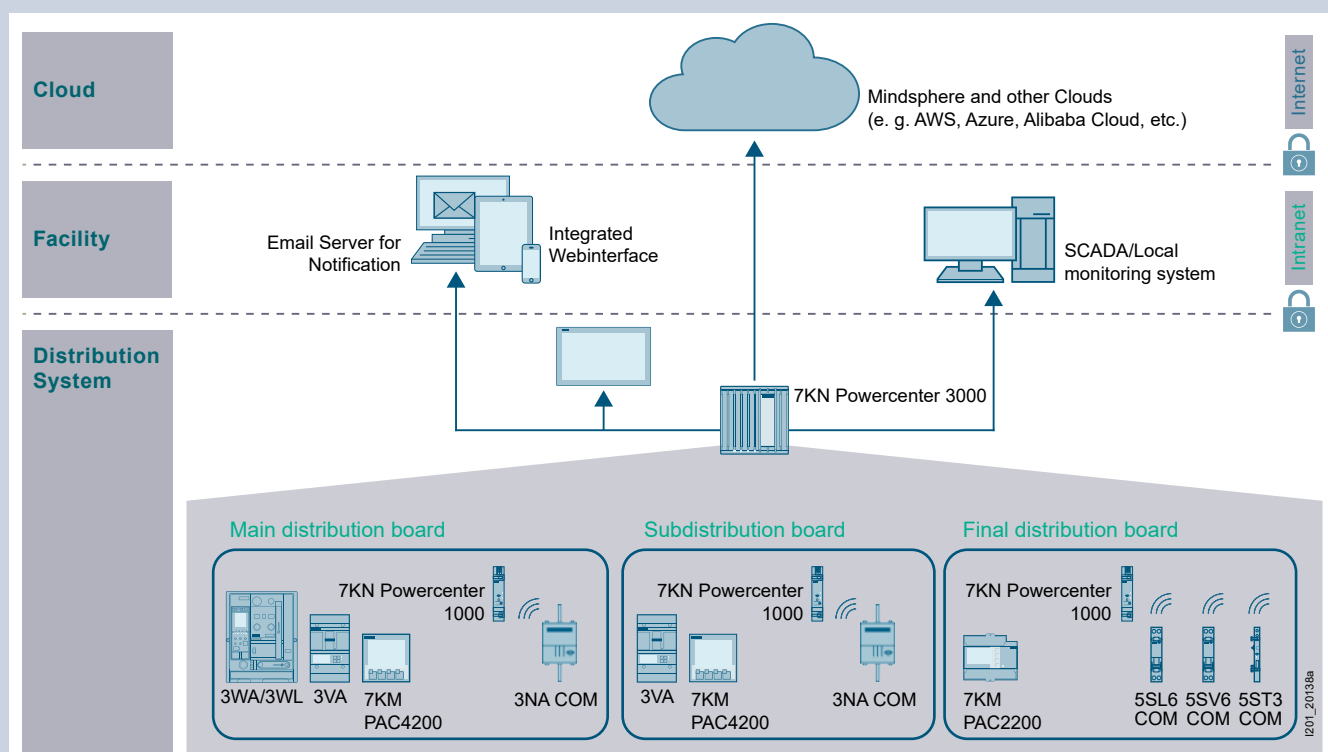

Areas of use and applications for 7KN Powercenter 3000

## Wireless data acquisition and visualization in the final circuit

### 7KN Powercenter 1000

The 7KN Powercenter 1000 data transceiver is designed to enable comprehensive data acquisition of communication and metering-capable circuit protection devices. This increases transparency in the final circuit, through which optimization measures can be derived to increase system availability.

Up to 24 devices can communicate wirelessly with 7KN Powercenter 1000 via radio link. This means that no increased installation effort is required for communication. Selected measured values of the circuit protection devices are stored in the data transceiver for up to 30 days. These can be visualized to ensure extensive data availability.

The compact design of the 7KN Powercenter 1000, in a single modular width, results in an extremely small footprint in the distribution board so as to enable wireless, comprehensive data acquisition.

This is complemented by easy mounting on a 35 mm DIN rail and plug-in terminals for a 24 V DC power supply, which can be immediately looped through (daisy chain) to supply other devices.

The integrated Bluetooth interface enables simple on-site communication and commissioning via the SENTRON powerconfig mobile app. Connection to various configuration or power monitoring systems, such as SENTRON powerconfig, SENTRON powermanager or customized solutions, is ensured via the Modbus TCP interface. Furthermore, this interface also enables a connection via e.g. 7KN Powercenter 3000 or via LOGO! to cloud applications.

Mounting	Power supply	Devices that can be connected	Interfaces	Article No.
DIN-rail mounting	24 V DC SELV	24 circuit protection devices via radio link	1× Ethernet (Modbus TCP) 1× Bluetooth	7KN1110-0MC00

**Note:**  
Please note the country-specific radio licenses of the products in SIOS:  
[www.siemens.com/lowvoltage/certificates](http://www.siemens.com/lowvoltage/certificates) (109801197)

### 7KN Powercenter 1000 data transceiver

- Acquisition and storage of data and measured values from up to 24 communication-capable circuit protection devices via radio link
- Parameterization, visualization and further processing of the data in higher-level applications via Bluetooth and Modbus TCP

You will find further information under:  
[www.siemens.com/lowvoltage/manuals](http://www.siemens.com/lowvoltage/manuals)

Installation manual – Circuit protection devices with communication and measuring function (109791805)

System manual – Circuit protection devices with communication and measuring function (109791806)

# SENTRON powermind

## Cloud-based solution for data visualization and analysis in power distribution systems



SENTRON powermind is aimed equally at energy managers, facility managers and/or operators. For energy managers, predefined, automated representations and analyses of energy data are available, such as:

- Analysis of data in graphical form, e.g. lines, bars, heatmap, Sankey diagram (Can also be output as a report)
- Comparison of energy consumption on weekdays versus weekends with percentage day-by-day representation of the distribution of energy consumption to identify unnecessary energy consumption
- Comparison of energy consumption and power import during a selected period as compared with a reference period to assess the effectiveness of energy efficiency measures
- Day-by-day representation of the 15 min power demand, incl. min and max values to assess power peaks

SENTRON powermind offers operators and facility managers the following information and analyses:

- Status of the switching and protection devices, such as 3VA, 3WA and 3WL
- Display of the maximum current value of an individual phase in relation to  $I_n$
- Condition monitoring information about the condition of the contact system of each circuit breaker and also as an overview of all circuit breakers
- The following devices are supported:  
PAC1020, PAC2200/PAC2200CLP, PAC3100/PAC3120, PAC3200/PAC3200T/PAC3220, PAC4200 measuring devices,  
3VA, 3WA and 3WL circuit breakers

You can find more information on the MindSphere Store at

[www.dex.siemens.com/mindsphere/applications](http://www.dex.siemens.com/mindsphere/applications)

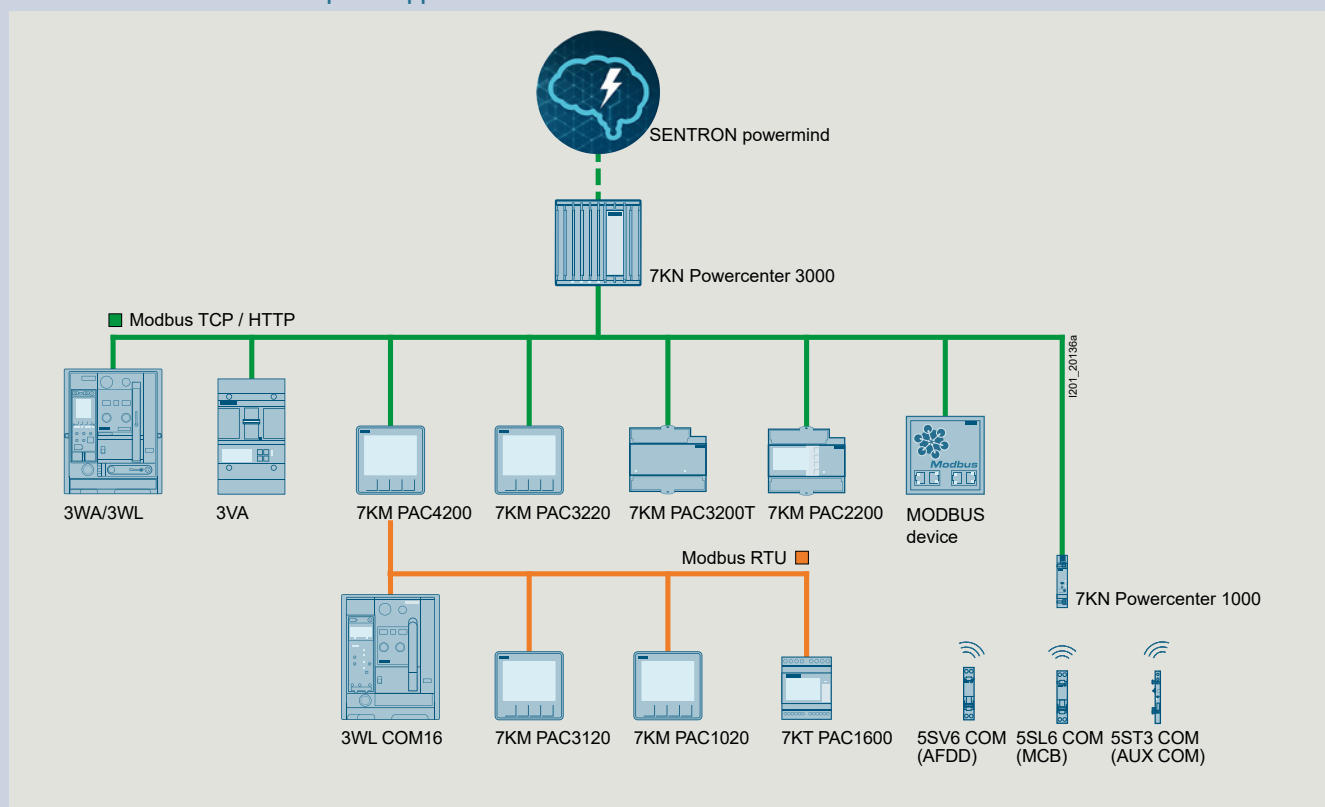

A large number of devices transmit data via SENTRON Powercenter 3000 or SENTRON powermanager to SENTRON powermind

SENTRON powermind processes data from SENTRON Powercenter 3000. No complex configuration or parameterization is required, as the necessary information is exchanged using files. This also prevents possible incorrect entries or write errors. An error-free connection can thus be easily established in just a few minutes.



The examples show some of the functions of SENTRON powermind, which are aimed at different customer groups, such as energy managers and maintenance personnel, but also electricians. All information is available via a web browser on a standard PC, but also on mobile devices, such as tablets and smartphones. The information is therefore available both on-site (locally) and off-site (remotely).

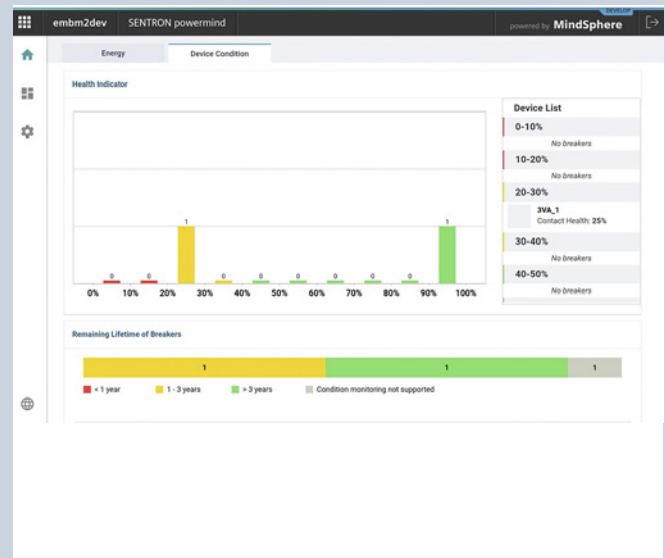
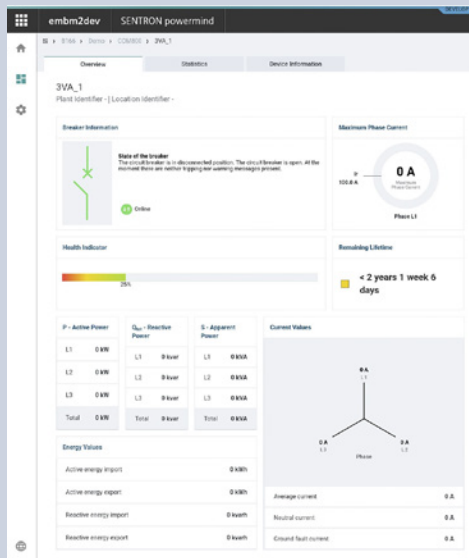

### Creating transparency

- Representation of the device status, e.g. open, closed, tripped and relevant measured quantities, such as maximum phase current, total power ...
- Information about the state of health of the device to take action proactively

### Overview of the circuit breaker status

- Overview of the state of the health of all circuit breakers in the switchboard
- Assignment to a maintenance cycle (< 1 year; between 1 and 3 years; > 3 years)
- Display of circuit breakers in list form as well as link to the respective circuit breaker dashboard

10

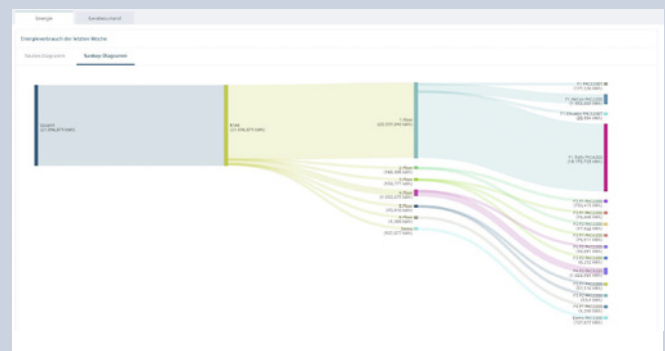
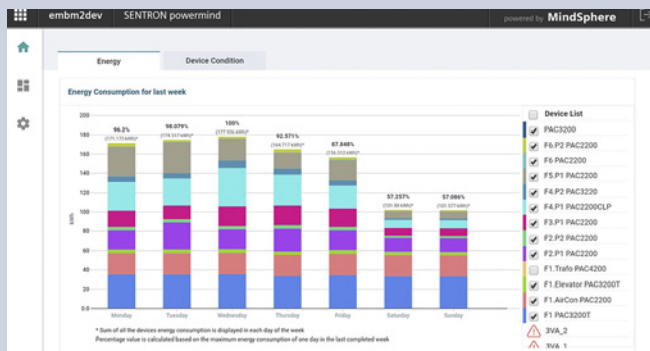

### Creating transparency

- Representation of the power flow/power import in various parts of the power distribution system
- Comparison of the weekly energy consumption (percentage distribution of weekdays in comparison to weekend) to identify unusual energy consumption patterns and to check energy-saving measures in the form of a bar chart or Sankey diagram



### Energy management

- Comparison of the energy consumption of two periods, for example, to assess the effectiveness of energy saving measures
- Representation of the active power as mean and min/max values in a line diagram or heatmap

# SIMATIC Energy Suite

For integrated energy management

## Highlights

- Simple and intuitive configuration instead of programming
- Automatic generation of the PLC energy program
- Convenient integration of measuring components from the Siemens portfolio and from other manufacturers
- Integrated into the TIA Portal and the automation system
- Archiving in WinCC Professional or PLC
- Seamless interfacing to Energy Manager PRO and Energy
- Analytics

Additional information on the SIMATIC Energy Suite:

[www.siemens.com/energysuite](http://www.siemens.com/energysuite)

# SIMATIC Modbus/TCP SENTRON PAC

For 7KM PAC3200/4200 measuring devices

Use and version	Valid for	Type	Article No.
Communication via the integrated PN interface for reading values out of PAC 3200 and PAC PAC 4200 devices, single license	1 CPU and up to 20 SENTRON PACs	Modbus/TCP 20 SENTRON PAC	6AV6676-6MA30-0AX0
	1 CPU and up to 100 SENTRON PACs	Modbus/TCP 100 SENTRON PAC	6AV6676-6MA30-1AX0
	1 CPU and up to 512 SENTRON PACs	Modbus/TCP 512 SENTRON PAC	6AV6676-6MA30-2AX0

# PAC/3WL/3VA SIMATIC PCS 7 library

For 7KM PAC3200/3220/4200 measuring devices and 3WL/3VA/3VL circuit breakers

Use	Version	Type of delivery	Article No.
<b>PAC/3WL/3VA SIMATIC PCS 7 library</b> <ul style="list-style-type: none"> <li>AS blocks and faceplates for integrating the 3WL/3VA/3VL circuit breakers into SIMATIC PCS 7, V8.x, V9.0 SP2 or V9.1</li> <li>For each SIMATIC PCS 7 Operator Station of the single station/server version, a license containing the following is required:                             <ul style="list-style-type: none"> <li>Engineering license for one SIMATIC PCS 7 Operator Station of the single station/server version</li> <li>Runtime license for one automation system (1 required per automation system, further AS runtime licenses can be ordered separately)</li> </ul> </li> </ul>	Engineering and runtime software, software class A, 2-language (English, German), single license for one installation	Software and electronic documentation as a software download, engineering and runtime license as Certificate of License	3ZS2787-1CC30-0YGO
<b>AS runtime license for PAC/3WL/3VA library for SIMATIC PCS 7</b> License for one automation system in each case	Runtime software, software class A, 2-language (English, German), single license for one installation	Runtime license as Certificate of License without software and documentation	3ZS2787-1CC30-6YH0

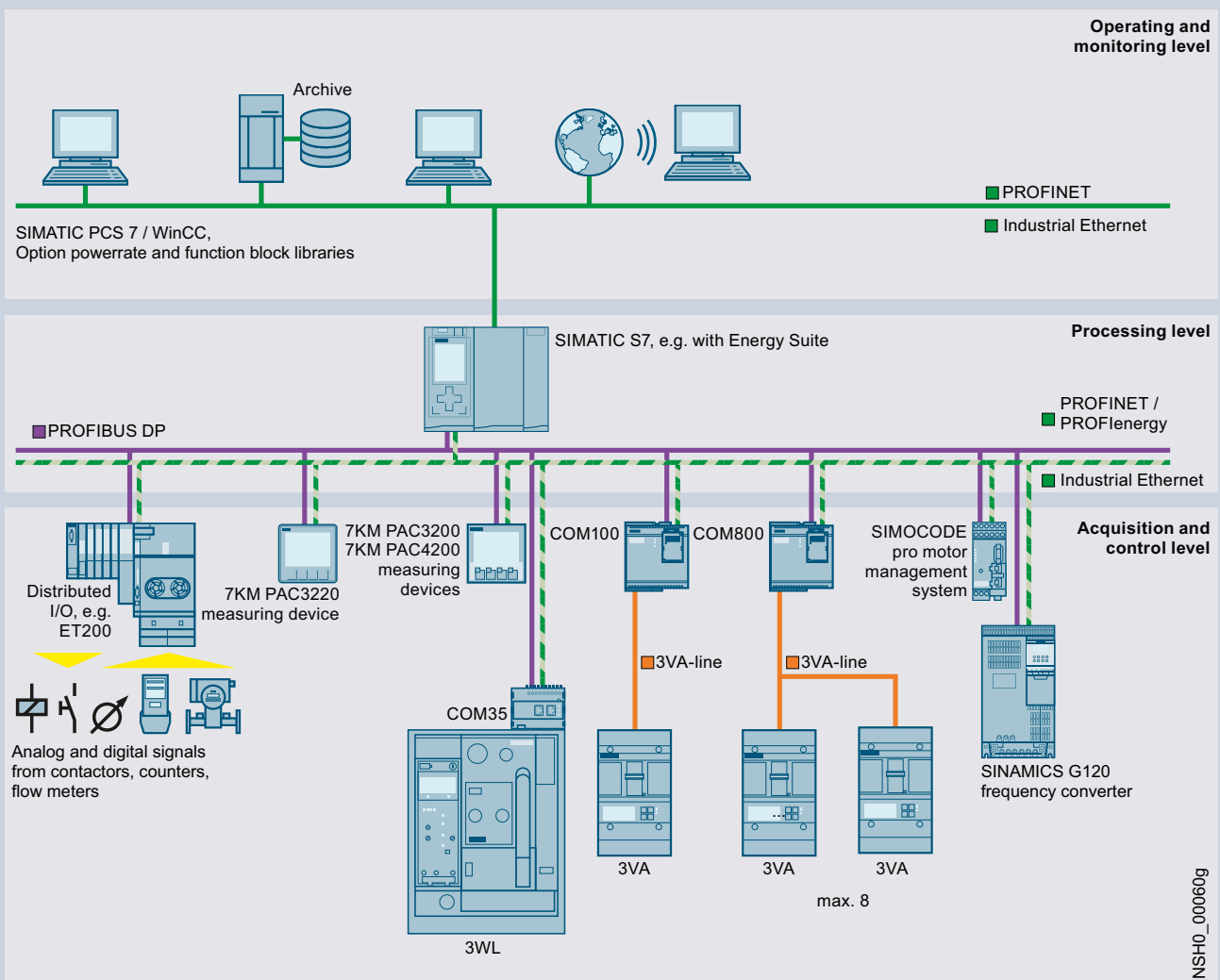

NSHO\_00060g

# 7KM PAC measuring devices

## Basic units



Connections	Power supply	Display	Interface	MID	PTB-A50.7	7KM PAC1020	7KM PAC2200/PAC2200 CLP	7KM PAC3200T
<b>Transformer measurement</b>								
Screw terminals	Self-powered	With	M-Bus	With	Without	–	7KM2200-2EA30-1GA1	–
				Without	Without	–	7KM2200-2EA30-1CA1	–
				With	Without	–	7KM2200-2EA30-1HA1	–
				Without	Without	–	7KM2200-2EA30-1DA1	–
				Without	Without	–	7KM2200-2EA30-1EA1	–
			Modbus RTU	With	Without	7KM1020-0BA01-1DA0	–	–
				Without	Without	–	–	–
				Without	Without	–	–	7KM3200-0CA01-1AA0
				Without	Without	–	–	–
				Without	Without	–	–	–
AC/DC wide-voltage power supply unit	With	Modbus TCP	Without	Without	–	–	–	
		Modbus RTU	Without	Without	–	–	–	
DC power supply unit with extra-low voltage	With	Modbus TCP	Without	Without	–	–	–	
		Modbus RTU	Without	Without	–	–	–	
Ring cable lug connection	AC/DC wide-voltage power supply unit	With	Modbus TCP	Without	Without	–	–	–
<b>Direct measurement</b>								
Screw terminals	Self-powered	With	M-Bus	With	Without	–	7KM2200-2EA40-1GA1	–
				Without	Without	–	7KM2200-2EA40-1CA1	–
				With	Without	–	7KM2200-2EA40-1HA1	–
				Without	Without	–	7KM2200-2EA40-1DA1	–
				Without	Without	–	7KM2200-2EA40-1EA1	–
			Modbus RTU	With	With	–	7KM2200-2EA40-1JB1	–
				Without	Without	–	7KM2200-2EA40-1JA1	–
				Without	Without	–	7KM2200-2EA40-1EA1	–
				Without	Without	–	7KM2200-2EA40-1EA1	–
				Without	Without	–	7KM2200-2EA40-1EA1	–

### Further technical specifications

	7KM1020-..	7KM2200-..	7KM3200-..	7KM3120-0..	7KM3120-1..
<b>Basic data</b>					
Installation	Front mounting	DIN rail		Front mounting	
Modular width	–	6 MW		–	
Control panel instrument	96 × 96 mm	–		96 × 96 mm	
External auxiliary voltage	50/60 Hz AC	100 ... 250 V	–	90 ... 276 V	100 ... 250 V ±10%
	DC	110 ... 250 V ±10%	–	110 ... 275 V	110 ... 250 V ±10%
					24 ... 60 V ±20%
<b>Measuring inputs</b>					
Transformer connection	Secondary input current $I_e$	x/1 A or x/5 A	x/1 A or x/5 A		x/1 A or x/5 A
Direct connection	Input voltage $U_e$ 3 AC 50/60 Hz	400/230 V		690/400 V	
	Rated current $I_n$	–	65 A	–	







7KM PAC3120	7KM PAC3220	7KM PAC4200	7KM PAC5200
-	-	-	-
-	-	-	-
-	-	-	-
-	-	-	-
-	-	-	-
-	-	-	-
-	-	-	-
-	-	-	-
7KM3120-0BA01-1DA0	-	-	-
-	7KM3220-0BA01-1DA0	7KM4212-0BA00-3AA0	7KM5412-6BA00-1EA2
-	-	-	7KM5412-6CA00-1EA8
-	7KM3220-1BA01-1EA0	7KM4211-1BA00-3AA0	-
7KM3120-1BA01-1EA0	-	-	-
-	-	7KM4212-0BA00-2AA0	-
-	-	-	-
-	-	-	-
-	-	-	-
-	-	-	-
-	-	-	-
-	-	-	-
-	-	-	-

10

7KM3220-0..	7KM3220-1..	7KM4212-..	7KM4211-..	7KM5412-..
Front mounting			Front mounting/DIN rail	
-				
96 × 96 mm				
100 ... 250 V ±10%	-	95 ... 240 V ±10%	-	110 ... 230 V ±10%
100 ... 250 V ±10%	24 ... 60 V ±20%	110 ... 340 V ±10%	22 ... 65 V ±10%	24 ... 250 V ±10%
x/1 A or x/5 A				
690/400 V			500/289 V	690/400 V
-				

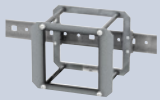
# 7KM PAC measuring devices

## Accessories

	7KM PAC1020	7KM PAC3120 7KM PAC3220 7KM PAC4200
<b>7KM PAC TMP2 DIN-rail adapter</b>  <ul style="list-style-type: none"> <li>Two-tier adapter for mounting a measuring device on a DIN rail</li> <li>Front display</li> <li>For manual intervention</li> </ul>		
		7KM9900-0XA00-0AA0
<b>7KM PAC TMP mounting plate</b>  <ul style="list-style-type: none"> <li>Adapter for mounting a measuring device on DIN rail</li> <li>Display faces backwards towards DIN rail</li> <li>Readout and evaluation of measurements solely via mains operation</li> </ul>		
		7KM9900-0YA00-0AA0
<b>Compact holder</b>  <ul style="list-style-type: none"> <li>Device holder for 7KM PAC1020/3100/3120/3200/3220/4200</li> <li>10 holders for 5 PAC devices</li> <li>For seamless side-by-side mounting of the devices (without spaces)</li> </ul>		
		7KM9900-0GA00-0AA0
<b>Spare parts for 7KM PAC</b>  <ul style="list-style-type: none"> <li>Spare parts comprising:           <ul style="list-style-type: none"> <li>Device holders for panel mounting (2X)</li> <li>Screw terminal for connection of voltage inputs</li> <li>Screw terminal for connection of current inputs</li> <li>Terminal block inputs/outputs for 7KM PAC3100/4200</li> <li>Terminal block inputs/outputs for 7KM PAC3200</li> <li>RS485 terminal blocks for 7KM PAC3100</li> </ul> </li> </ul>		
		7KM9900-0SA00-0AA0

10

	7KM PAC2200 7KM PAC2200 CLP 7KM PAC2200 MID	7KM PAC300T
<b>SETRON PROFINET Proxy SPP2000 <span style="color: orange;">new</span></b>  <ul style="list-style-type: none"> <li>Proxy for transition from Modbus TCP-capable measuring devices to PROFINET IO. Connection of up to 8 devices from the PAC2200, PAC2200 CLP, PAC2200 MID and PAC3200T product ranges</li> <li>PROFINET Conformance Class C</li> <li>Two switched ports</li> <li>Integration in TIA by means of GSDML file</li> </ul>		
		7KM9300-0PP20-0AA0

## Expansion and communication modules

	7KM PAC3220 7KM PAC4200	COM100/800 (3VA)
<b>7KM Switched Ethernet PROFINET communication module</b>		
 <ul style="list-style-type: none"> <li>• Latest PROFINET switching properties</li> <li>• S2 system redundancy for operation in H systems</li> <li>• CIR Configuration in Run</li> <li>• Firmware update via the modules for PAC4200 and PAC3220</li> </ul>		
		7KM9300-0AE02-0AA0
<b>7KM PROFIBUS DP communication module</b>		
		
		7KM9300-0AB01-0AA0
<b>7KM RS485 communication module</b>		
		
		7KM9300-0AM00-0AA0 <sup>1)</sup>
<b>7KM PAC 4DI/2DO expansion module</b>		
		
	7KM9200-0AB00-0AA0	–
<b>7KM PAC I(N), I(Diff), analog expansion module</b>		
 <ul style="list-style-type: none"> <li>• To add the following functions to the measuring inputs:                             <ul style="list-style-type: none"> <li>– N conductor measurement</li> <li>– Two analog inputs, also for measuring non-electrical quantities such as temperature, water or air pressure</li> <li>– Residual current measurement via type A or type B summation current transformers</li> </ul> </li> </ul>		
	7KM9200-0AD00-0AA0	–

<sup>1)</sup> Suitable for 7KM PAC4200 (especially for the Modbus TCP/RTU Gateway)

Residual-current transformers for 7KM PAC I(N), I(Diff), analog expansion module, [from page 11/1 onwards](#)

# 7KT PAC measuring devices

## PAC1600 basic unit



Connections	Version	Power supply	Display	Interface	MID	7KT PAC1600	
<b>Transformer measurement</b>							
Screw terminals	3-phase	Self-powered	With	Modbus RTU	Without	7KT1661	
					With	7KT1662	
				M-Bus	Without	7KT1663	
					With	7KT1664	
				SO interface	Without	7KT1672	
					With	7KT1673	
	3-phase, universal	Auxiliary power: 100 ... 240 V AC, 110 ... 250 V DC 50/60Hz	With	–	Without	7KT1681	
				Modbus RTU	Without	7KT1682	
	<b>Direct measurement</b>						
	Screw terminals	1-phase	Self-powered	With	Modbus RTU	Without	7KT1651
With						7KT1652	
M-Bus					Without	7KT1653	
					With	7KT1654	
SO interface					Without	7KT1655	
					With	7KT1656	
3-phase		Self-powered	With	Modbus RTU	Without	7KT1665	
					With	7KT1666	
				M-Bus	Without	7KT1667	
					With	7KT1668	
				SO interface	Without	7KT1670	
					With	7KT1671	



## PAC1200 multichannel current measuring system



Connections	Version	Power supply	Display	Interface	MID	7KT PAC1200
<b>Direct measurement</b>						
Screw terminals	3-phase	Self-powered	Without	Modbus TCP	Without	7KT1260

### PAC1200

7KT PAC1200

#### Data manager with 7KT1260, sensor bars

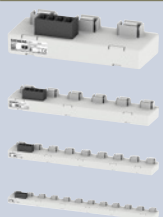

Number of connections	Article No.
3	7KT1233
6	7KT1236
9	7KT1238
12	7KT1242

#### Data manager with 7KT1260, sensors



Current $I_e$	Article No.
40 A	7KT1254
63 A	7KT1255

10

## PAC1200 Bundles



Data manager	Sensor bars	Sensors	18 bundle	24 bundle
1× data manager 7KT1260	2× 9-sensor bar 7KT1238	18× sensors 40 A 7KT1254	7KT1222	–
	2× 12-sensor bar 7KT1242	24× sensors 40 A 7KT1254	–	7KT1223

# SEM3 multichannel current measuring system

## Data manager



Connections	Version	Power supply	Display	Interface	MID	
<b>Transformer measurement</b>						
Screw terminals	3-phase	Self-powered	Without	Modbus TCP RS485 Modbus RTU	Without	US2:SEM3CONTROLLER

## Further technical specifications

SEM3

<b>Basic data</b>	
Installation	Screw mounting
<b>Measuring inputs</b>	
Max. input voltage 50/60 Hz AC	480 V/277 V
Standard current transformers	50 ... 1200 A/0.1 A
Folding transformer	50 ... 2000 A/0.1 A

## Accessories

### Metering modules



- For recording measured values
- Accuracy of 0.2% or 1% for the entire measurement including current transformer
- Simple setting of phase configuration by means of slide switch
- Connection of a current transformer for measuring a phase
- Metering module is plugged into meter rack

Measuring accuracy	Article No.
0.2%	US2:SEM3PHAMETER
1%	US2:SEM3PLAMETER

### Meter racks

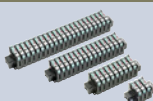

Version	Article No.
For 3 metering modules	US2:SEM3RACK3
For 9 metering modules	US2:SEM3RACK9
For 15 metering modules	US2:SEM3RACK15
For 21 metering modules	US2:SEM3RACK21

### Connecting cables



- 600 V insulated special cable for connecting meter racks to the data manager

Length	Article No.
0.3 m	US2:SEM3CAB12INCH
0.6 m	US2:SEM3CAB24INCH
0.9 m	US2:SEM3CAB36INCH

### Standard current transformers



- Standard power cable brown and yellow, 1.82 m long
- Can be extended up to 100 m while still maintaining accuracy
- Transformer configuration is carried out in the data manager

Output signal	Transformer transmission ratio	Article No.
100 mA	50 : 0.1	US2:SEM3SCCT50
	125 : 0.1	US2:SEM3SCCT125
	250 : 0.1	US2:SEM3SCCT250
	400 : 0.1	US2:SEM3SCCT400
	600 : 0.1	US2:SEM3SCCT600
	800 : 0.1	US2:SEM3SCCT800
	1200 : 0.1	US2:SEM3SCCT1200

### Folding transformers

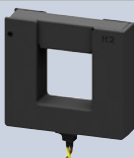

- Standard power cable brown and yellow, 1.82 m long
- Can be extended up to 100 m while still maintaining accuracy
- Transformer configuration is carried out in the data manager

Output signal	Transformer transmission ratio	Article No.
100 mA	50 : 0.1	7KT1280-5MA00
	125 : 0.1	7KT1280-5MA01
	250 : 0.1	7KT1280-5MA02
	400 : 0.1	7KT1280-5MA03
	600 : 0.1	7KT1280-5MA04
	800 : 0.1	7KT1280-5MA05
	1200 : 0.1	7KT1280-5MA06
	1600 : 0.1	7KT1280-5MA07
	2000 : 0.1	7KT1280-5MA08

### DIN-rail adapters



- 5 adapters for snapping onto DIN rail
- 1 adapter each for data manager and for meter racks with 3, 9, 15 and 21 metering modules
- Adapters are screwed onto the data manager or the meter racks

Article No.
US2:SEM3DINKIT

# SEM3T multichannel temperature measuring system **new**

Data manager for thermal monitoring in electrical systems



Connections	Version	Power supply	Display	Interface	
Plug-in connectors	Temperature measurement	24 V DC	Without	Modbus TCP	7KT1281-0AA00
				Modbus TCP/Wi-Fi	7KT1281-0AA10

## Further technical specifications

SEM3T

Basic data	
Installation	DIN-rail mounting
Measuring inputs	
Temperature sensors	0 to 130°C

## Accessories

### Metering module



- For recording measured values
- No configuration necessary for modules
- Connection of a temperature sensor
- Metering module is plugged into meter rack

Article No.
7KT1281-1AA00

### Meter racks

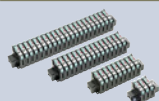

Version	Article No.
For 3 metering modules	US2:SEM3RACK3
For 9 metering modules	US2:SEM3RACK9
For 15 metering modules	US2:SEM3RACK15
For 21 metering modules	US2:SEM3RACK21

### Connecting cables



- 600 V insulated special cable for connecting meter racks to the data manager

Length	Article No.
0.3 m	US2:SEM3CAB12INCH
0.6 m	US2:SEM3CAB24INCH
0.9 m	US2:SEM3CAB36INCH

### Temperature sensors

- Standard connection cable, brown and yellow, 3 m long
- Can be extended up to 15 m while still maintaining accuracy
- Configuration is carried out in the data manager



Version	Size	Article No.
Sensors with ring terminal lugs	Sensor 1/4"	7KT1281-2SA00
	Sensor 5/16"	7KT1281-2SA01
	Sensor 3/8"	7KT1281-2SA02
	Sensor 1/2"	7KT1281-2SA03
Cylindrical sensor		7KT1281-2CA00

# Time and pulse counters

## Mechanical counting mechanisms



Display	Resetting	Rated frequency	Rated control supply voltage $U_c$	48 × 48 mm	72 × 72 mm	–
<b>Time counter</b>						
00000.00 h	Without	–	10 ... 80 V DC	7KT5500	–	–
			10 ... 50 V DC	–	7KT5600	–
			12 ... 24 V DC	–	–	7KT5801
		50 Hz	24 V AC	7KT5505	–	7KT5802
			115 V AC	7KT5501	7KT5601	7KT5803
			230 V AC	7KT5502	7KT5602	7KT5804
		60 Hz	115 V AC	7KT5503	7KT5603	7KT5806
			230 V AC	7KT5504	7KT5604	7KT5807
<b>Pulse counter</b>						
0000000	Without	–	12 ... 24 V DC	–	–	7KT5811
		50/60 Hz	24 V AC	–	–	7KT5812
			230 V AC	–	–	7KT5814

### Further technical specifications

	7KT55..	7KT56..	7KT58..
<b>Basic data</b>			
Installation	Front mounting		DIN rail
Modular width	–		2 MW
Front frame	48 × 48 mm	72 × 72 mm	–
Display	Drum-type register		
Version	–	With narrow frame according to DIN 43700	–

### Accessories

	7KT55..	7KT56..	7KT58..
<b>Cover</b>			
Size	Article No.	Article No.	Article No.
55 × 55 mm	7KT9020	–	–
<b>Sealing ring for cover</b>			
Degree of protection	Scope of supply	Article No.	Article No.
IP43 (in switchboards with smooth surfaces)	1 set = 5 units	7KT9000	–
<b>Terminal cover</b>			
Degree of protection	Article No.	Article No.	Article No.
IP20 (with connected conductors)	–	7KT9021	–

## Electronic counting mechanisms



Display	Resetting	Rated frequency	Rated control supply voltage $U_c$	
<b>Time counter</b>				
000000.0 h	Without	50/60 Hz	24 ... 240 V AC, 12 ... 150 V DC	7KT5821
	Electrical	50/60 Hz	24 ... 240 V AC, 12 ... 150 V DC	7KT5822
	Electrical and mechanical	50/60 Hz	24 ... 240 V AC, 12 ... 150 V DC	7KT5823
<b>Pulse counter</b>				
0000000	Electrical and mechanical	50/60 Hz	24 ... 240 V AC, 12 ... 150 V DC	7KT5833

### Further technical specifications

7KT58..

<b>Basic data</b>	
Installation	DIN rail
Modular width	2 MW
Display	LCD display

# Current transformers

For measuring purposes

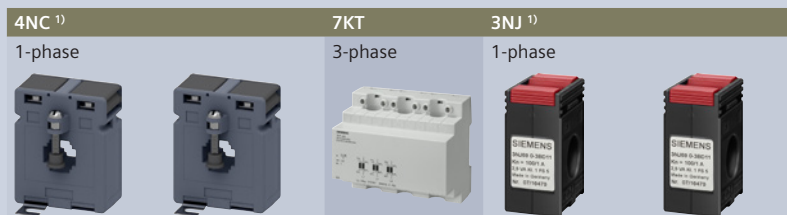

Size	Insulation level $U_m$	Rated primary current $I_{pr}$	Rated power $P_n$	$I_{sr} = 5 A$	$I_{sr} = 1 A$	$I_{sr} = 5 A$	$I_{sr} = 5 A$	$I_{sr} = 1 A$
<b>Accuracy class 0.2s</b>								
1	720 V	150 A	1 VA	4NC5121-2FA21	–	–	–	–
		200 A	2.5 VA	4NC5122-2FC21	–	–	–	–
		250 A	2.5 VA	4NC5123-2FC21	–	–	–	–
		300 A	5 VA	4NC5124-2FE21	–	–	–	–
		400 A	5 VA	4NC5125-2FE21	–	–	–	–
5	720 V	500 A	5 VA	4NC5126-2FE21	–	–	–	–
		600 A	5 VA	4NC5227-2FE21	–	–	–	–
		700 A	5 VA	4NC5228-2FE21	–	–	–	–
		800 A	5 VA	4NC5231-2FE21	–	–	–	–
		1000 A	5 VA	4NC5232-2FE21	–	–	–	–
<b>Accuracy class 0.5</b>								
1	720 V	100 A	1 VA	4NC5117-2DA21	4NC5117-0DA21	–	–	–
		150 A	2.5 VA	4NC5121-2DC21	4NC5121-0DC21	–	–	–
		200 A	5 VA	4NC5122-2DE21	4NC5122-0DE21	–	–	–
		250 A	5 VA	4NC5123-2DE21	4NC5123-0DE21	–	–	–
2	720 V	200 A	5 VA	4NC5222-2DE21	4NC5222-0DE21	–	–	–
		250 A	5 VA	4NC5223-2DE21	4NC5223-0DE21	–	–	–
		300 A	5 VA	4NC5224-2DE21	4NC5224-0DE21	–	–	–
		400 A	5 VA	4NC5225-2DE21	4NC5225-0DE21	–	–	–
3	720 V	400 A	5 VA	4NC5325-2DE21	4NC5325-0DE21	–	–	–
		500 A	5 VA	4NC5326-2DE21	4NC5326-0DE21	–	–	–
		600 A	5 VA	4NC5327-2DE21	4NC5327-0DE21	–	–	–
		750 A	5 VA	4NC5330-2DE21	4NC5330-0DE21	–	–	–
4	720 V	800 A	5 VA	4NC5331-2DE21	–	–	–	–
		800 A	10 VA	4NC5431-2DH21	4NC5431-0DH21	–	–	–
		1000 A	10 VA	4NC5432-2DH21	4NC5432-0DH21	–	–	–
		1200 A	10 VA	4NC5433-2DH21	4NC5433-0DH21	–	–	–
		1500 A	10 VA	4NC5435-2DH21	4NC5435-0DH21	–	–	–
		1600 A	15 VA	4NC5436-2DK21	–	–	–	–
		2000 A	20 VA	4NC5438-2DL21	–	–	–	–
		2500 A	25 VA	4NC5440-2DM21	–	–	–	–
		3000 A	30 VA	4NC5441-2DN21	–	–	–	–
<b>Accuracy class 0.5 calibrated</b>								
–	720 V	100 A	1.5 VA	–	–	–	3NJ6920-3BD23	3NJ6920-3BD13
		150 A	2.5 VA	–	–	–	3NJ6920-3BE23	3NJ6920-3BE13
		300 A	5 VA	–	–	–	3NJ6940-3BH23	3NJ6940-3BH13
		400 A	5 VA	–	–	–	3NJ6940-3BJ23	3NJ6940-3BJ13
		500 A	5 VA	–	–	–	3NJ6940-3BK23	3NJ6940-3BK13
		600 A	5 VA	–	–	–	3NJ6940-3BL23	3NJ6940-3BL23

<sup>1)</sup> Overcurrent limiting factor FS5



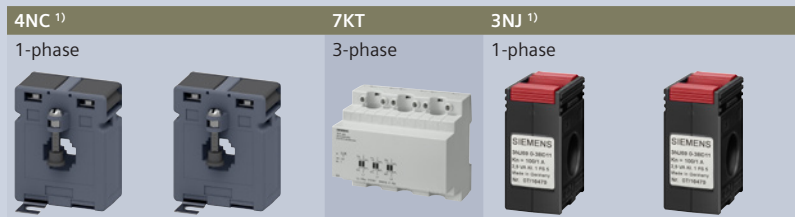

Size	Insulation level $U_m$	Rated primary current $I_{pr}$	Rated power $P_n$	4NC 1)		7KT	3NJ 1)	
				$I_{sr} = 5 A$	$I_{sr} = 1 A$	3-phase	1-phase	$I_{sr} = 1 A$
<b>Accuracy class 1.0</b>								
1	720 V	50 A	1.2 VA	4NC5112-2CB21	4NC5112-0CB21	–	–	–
		60 A	1.2 VA	4NC5113-2CB21	4NC5113-0CB21	–	–	–
			1.25 VA	–	–	7KT1200	–	–
		75 A	2.5 VA	4NC5115-2CC21	4NC5115-0CC21	–	–	–
		100 A	2.5 VA	4NC5117-2CC21	4NC5117-0CC21	7KT1201	–	–
		150 A	2.5 VA	4NC5121-2CC21	4NC5121-0CC21	–	–	–
			3.75 VA	–	–	7KT1202	–	–
		200 A	5 VA	4NC5122-2CE21	4NC5122-0CE21	–	–	–
2	720 V	250 A	5 VA	4NC5123-2CE21	4NC5123-0CE21	–	–	–
		200 A	5 VA	4NC5222-2CE21	4NC5222-0CE21	–	–	–
		250 A	5 VA	4NC5223-2CE21	4NC5223-0CE21	–	–	–
		300 A	5 VA	4NC5224-2CE21	4NC5224-0CE21	–	–	–
3	720 V	400 A	5 VA	4NC5225-2CE21	4NC5225-0CE21	–	–	–
		400 A	5 VA	4NC5325-2CE21	4NC5325-0CE21	–	–	–
		500 A	5 VA	4NC5326-2CE21	4NC5326-0CE21	–	–	–
		600 A	5 VA	4NC5327-2CE21	4NC5327-0CE21	–	–	–
4	720 V	750 A	5 VA	4NC5330-2CE21	4NC5330-0CE21	–	–	–
		800 A	10 VA	4NC5431-2CH21	4NC5431-0CH21	–	–	–
		1000 A	10 VA	4NC5432-2CH21	4NC5432-0CH21	–	–	–
		1250 A	10 VA	4NC5434-2CH21	4NC5434-0CH21	–	–	–
	10 VA	4NC5435-2CH21	4NC5435-0CH21	–	–	–		
2000 A	12.5 VA	4NC5438-2CJ21	4NC5438-0CJ21	–	–	–		
2500 A	12.5 VA	4NC5440-2CJ21	4NC5440-0CJ21	–	–	–		
3000 A	30 VA	4NC5441-2CN21	–	–	–	–		

10

### Accessories

#### DIN-rail mounting



For transformer size	Article No.	Article No.	Article No.	Article No.	Article No.
1 and 5	4NC5923-5LT21	4NC5923-5LT21	–	–	–
2	4NC5925-5LT21	4NC5925-5LT21	–	–	–
3	4NC5930-5LT21	4NC5930-5LT21	–	–	–
4	4NC5940-5LT21	4NC5940-5LT21	–	–	–



# Appendix



Conditions of sale and delivery \_\_\_\_\_ A/2

Link directory \_\_\_\_\_ A/4

# Conditions of sale and delivery

## 1. General Provisions

By using this catalog you can purchase products (hardware, software and services) described therein from Siemens Aktiengesellschaft subject to the following Terms and Conditions of Sale and Delivery (hereinafter referred to as „T&C“). Please note that the scope, the quality and the conditions for supplies and services, including software products, by any Siemens entity having a registered office outside Germany, shall be subject exclusively to the General Terms and Conditions of the respective Siemens entity. The following T&C apply exclusively for orders placed with Siemens Aktiengesellschaft, Germany.

### 1.1 For customers with a seat or registered office in European Union

For customers with a seat or registered office in European Union, the following terms and conditions apply subordinate to T&C:

- for products, which include specific terms and conditions in the description text, these specific terms and conditions shall apply and subordinate thereto,
- for stand-alone software products and software products forming a part of a product or project, the „General License Conditions for Software Products for Automation and Drives for Customers with a Seat or registered Office in Germany“<sup>1)</sup> and/or
- for consulting services the „Allgemeine Geschäftsbedingungen für Beratungsleistungen der Division DF – Deutschland“ (available only in German) and/or
- for other services, the „Supplementary Terms and Conditions for Services (‘BL’)<sup>1)</sup> and/or
- for other supplies the „General Conditions for the Supply of Products and Services of the Electrical and Electronics Industry“<sup>1)</sup>.

In case such supplies should contain Open Source Software, the conditions of which shall prevail over the „General Conditions for the Supply of Products and Services of the Electrical and Electronics Industry“<sup>1)</sup>, a notice will be contained in the scope of delivery in which the applicable conditions for Open Source Software are specified. This shall apply mutatis mutandis for notices referring to other third party software components.

### 1.2 For customers with a seat or registered office outside European Union

For customers with a seat or registered office outside European Union, the following terms and conditions apply subordinate to T&C:

- for products, which include specific terms and conditions in the description text, these specific terms and conditions shall apply and subordinate thereto,
- for consulting services the „Standard Terms and Conditions for Consulting Services of the Division DF for Customers with a Seat or Registered Office Outside of Germany“<sup>1)</sup> and/or
- for other services the „International Terms & Conditions for Services“<sup>1)</sup> supplemented by „Software Licensing Conditions“<sup>1)</sup> and/or
- for other supplies of hard- and software the „International Terms & Conditions for Products“<sup>1)</sup> supplemented by „Software Licensing Conditions“<sup>1)</sup>

### 1.3 For customers with master or framework agreement

To the extent our supplies and/or services offered are covered by an existing master or framework agreement, the terms and conditions of that agreement shall apply instead of T&C.

## 2. Additional Terms and Conditions

The dimensions are in mm. In Germany, according to the German law on units in measuring technology, data in inches apply only to devices for export.

Illustrations are not binding.

Insofar as there are no remarks on the individual pages of this catalog – especially with regard to data, dimensions and weights given – these are subject to change without prior notice.

<sup>1)</sup> The text of the Terms and Conditions of Siemens AG can be downloaded at [https://mall.industry.siemens.com/legal/ww/en/terms\\_of\\_trade\\_en.pdf](https://mall.industry.siemens.com/legal/ww/en/terms_of_trade_en.pdf)

### 3. Export Regulations

We shall not be obligated to fulfill any agreement if such fulfillment is prevented by any impediments arising out of national or international foreign trade or customs requirements or any embargoes and/or other sanctions.

Export may be subject to license. We shall indicate in the delivery details whether licenses are required under German, European and US export lists.

Our products are controlled by the U.S. Government (when labeled with „ECCN“ unequal „N“) and authorized for export only to the country of ultimate destination for use by the ultimate consignee or end-user(s) herein identified. They may not be resold, transferred, or otherwise disposed of, to any other country or to any person other than the authorized ultimate consignee or end-user(s), either in their original form or after being incorporated into other items, without first obtaining approval from the U.S. Government or as otherwise authorized by U.S. law and regulations. Products labeled with „AL“ unequal „N“ are subject to European/national export authorization.

The export indications can be viewed in advance in the description of the respective goods on the Industry Mall, our online catalog system. Only the export labels „AL“ and „ECCN“ indicated on order confirmations, delivery notes and invoices are authoritative.

Products without label, with label „AL:N“/„ECCN:N“, or label „AL:9X9999“/„ECCN: 9X9999“ may require authorization from responsible authorities depending on the final end-use, or the destination.

If you transfer goods (hardware and/or software and/or technology as well as corresponding documentation, regardless of the mode of provision) delivered by us or works and services (including all kinds of technical support) performed by us to a third party worldwide, you shall comply with all applicable national and international (re-)export control regulations. In any event of such transfer of goods, works and services you shall comply with the (re-) export control regulations of the Federal Republic of Germany, of the European Union and of the United States of America.

Prior to any transfer of goods, works and services provided by us to a third party you shall in particular check and guarantee by appropriate measures that

- there will be no infringement of an embargo imposed by the European Union, by the United States of America and/or by the United Nations by such transfer, by brokering of contracts concerning those goods, works and services or by provision of other economic resources in connection with those goods, works and services, also considering the limitations of domestic business and prohibitions of by-passing those embargos;
- such goods, works and services are not intended for use in connection with armaments, nuclear technology or weapons, if and to the extent such use is subject to prohibition or authorization, unless required authorization is provided;
- the regulations of all applicable Sanctioned Party Lists of the European Union and the United States of America concerning the trading with entities, persons and organizations listed therein are considered.

If required to enable authorities or us to conduct export control checks, you, upon request by us, shall promptly provide us with all information pertaining to the particular end customer, the particular destination and the particular intended use of goods, works and services provided by us, as well as any export control restrictions existing.

You acknowledge that under the EU embargo regulations against Iran, Syria and Russia respectively the sale of certain listed goods and related services is subject to authorization by the competent export control authorities of the European Union. If (1) the goods or services ordered by you are destined for Iran, Syria or Russia, and (2) the contract for our supplies and/or services is subject to prior authorization of the competent export control authorities of the European Union, the contract between you and us shall come into force in this respect only upon granting of such authorization.

The products listed in this catalog may be subject to European/ German and/or US export regulations. Any export requiring approval is therefore subject to authorization by the relevant authorities. Errors excepted and subject to change without prior notice.

# Link directory

## Catalog LV 10

### General information

Information on low-voltage power distribution and electrical installation technology	<a href="http://www.siemens.com/lowvoltage">www.siemens.com/lowvoltage</a>
Tender specifications	<a href="http://www.siemens.com/lowvoltage/tenderspecifications">www.siemens.com/lowvoltage/tenderspecifications</a>
Conversion tool	<a href="http://www.siemens.com/conversion-tool">www.siemens.com/conversion-tool</a>
Image database	<a href="http://www.siemens.com/lowvoltage/picturedb">www.siemens.com/lowvoltage/picturedb</a>
CAX download manager	<a href="http://www.siemens.com/cax">www.siemens.com/cax</a>
Newsletter system	<a href="http://www.siemens.com/lowvoltage/newsletter">www.siemens.com/lowvoltage/newsletter</a>
Siemens YouTube channel	<a href="http://www.youtube.com/Siemens">www.youtube.com/Siemens</a>
Catalogue LV 10	<a href="http://www.siemens.com/lv10">www.siemens.com/lv10</a>
Catalogue LV 18	<a href="http://www.siemens.com/lv18">www.siemens.com/lv18</a>
Brochures/catalogs	<a href="http://www.siemens.com/lowvoltage/catalogs">www.siemens.com/lowvoltage/catalogs</a>
Operating instructions/manuals	<a href="http://www.siemens.com/lowvoltage/manuals">www.siemens.com/lowvoltage/manuals</a>
Siemens Industry Online Support (SIOS)	<a href="http://www.siemens.com/lowvoltage/product-support">www.siemens.com/lowvoltage/product-support</a>
Siemens Industry Online Support app	<a href="http://www.siemens.com/support-app">www.siemens.com/support-app</a>
My Documentation Manager (MDM)	<a href="http://www.siemens.com/lowvoltage/mdm">www.siemens.com/lowvoltage/mdm</a>
Configurators	<a href="http://www.siemens.com/lowvoltage/configurators">www.siemens.com/lowvoltage/configurators</a>
Siemens Industry Mall – product catalog and online ordering system	<a href="http://www.siemens.com/lowvoltage/mall">www.siemens.com/lowvoltage/mall</a>
Direct forwarding to the Industry Mall	<a href="http://www.siemens.com/product?Article No.">www.siemens.com/product?Article No.</a>
Training	<a href="http://www.siemens.com/sitrain-lowvoltage">www.siemens.com/sitrain-lowvoltage</a>
Local contacts	<a href="http://www.siemens.com/lowvoltage/contact">www.siemens.com/lowvoltage/contact</a> <a href="http://www.siemens.com/lowvoltage/components/contact">www.siemens.com/lowvoltage/components/contact</a> <a href="http://www.siemens.com/lowvoltage/systems/contact">www.siemens.com/lowvoltage/systems/contact</a> <a href="http://www.siemens.com/lowvoltage/software/contact">www.siemens.com/lowvoltage/software/contact</a>
Technical Support	<a href="http://www.siemens.com/support-request">www.siemens.com/support-request</a>
Information on services	<a href="http://www.siemens.com/service-catalog">www.siemens.com/service-catalog</a>
Manual for the generation, transmission and distribution of electrical energy	<a href="http://www.siemens.com/power-engineering-guide">www.siemens.com/power-engineering-guide</a>
Control panels for the North American market	<a href="http://www.siemens.com/northamerican-standards">www.siemens.com/northamerican-standards</a>
Control panel building	<a href="http://www.siemens.com/controlpanel">www.siemens.com/controlpanel</a>
Energy savings and amortization	<a href="http://www.automation.siemens.com/sinasave">www.automation.siemens.com/sinasave</a>
SIMATIC Energy Suite	<a href="http://www.siemens.com/energysuite">www.siemens.com/energysuite</a>
SITOP power supplies	<a href="http://www.siemens.com/sitop">www.siemens.com/sitop</a>
Power distribution with Totally Integrated Power	<a href="http://www.siemens.com/tip">www.siemens.com/tip</a>

# Catalogs and further information



## LV 10 Low-Voltage Power Distribution and Electrical Installation Technology

SENTRON • SIVACON • ALPHA

Protection, Switching, Measuring and  
Monitoring Devices, Switchboards and  
Distribution Systems

PDF (E86060-K8280-A101-B5-7600)



## ET D1 Switches and Socket Outlets DELTA

PDF

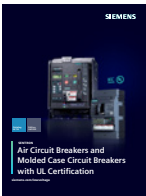

## LV 18 Air Circuit Breakers and Molded Case Circuit Breakers with UL Certification

SENTRON

PDF (E86060-K8280-E347-A9-7600)



## Industry Mall

Information and Ordering Platform  
on the Internet:

[www.siemens.com/industrymall](http://www.siemens.com/industrymall)



## IC 10 Industrial Controls SIRIUS

PDF (E86060-K1010-A101-B3-7600)

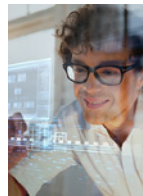

## SITRAIN

Digital Industry Academy

[www.siemens.com/sitrain](http://www.siemens.com/sitrain)



## Siemens TIA Selection Tool

for the selection, configuration and  
ordering of TIA products and devices

[www.siemens.com/tst](http://www.siemens.com/tst)

The catalogs listed above and additional catalogs are available in PDF format at Siemens Industry Online Support [www.siemens.com/lowvoltage/catalogs](http://www.siemens.com/lowvoltage/catalogs)

Further information on low-voltage power distribution and electrical installation technology is available on the Internet at [www.siemens.com/lowvoltage](http://www.siemens.com/lowvoltage)

## Get more information

[www.siemens.com/lowvoltage](http://www.siemens.com/lowvoltage)

Published by  
Siemens AG

Smart Infrastructure  
Electrical Products  
Siemensstraße 10  
93055 Regensburg, Germany

For the U.S. published by  
Siemens Industry Inc.

100 Technology Drive  
Alpharetta, GA 30005  
United States

PDF (Catalog Extract  
E86060-K8280-A101-B5-7600)  
KG 0622 44 En  
Produced in Germany  
© Siemens 2022

## Security information

Siemens provides products and solutions with industrial security functions that support the secure operation of plants, systems, machines and networks.

In order to protect plants, systems, machines and networks against cyber threats, it is necessary to implement – and continuously maintain – a holistic, state-of-the-art industrial security concept. Siemens' products and solutions constitute one element of such a concept.

Customers are responsible for preventing unauthorized access to their plants, systems, machines and networks. Such systems, machines and components should only be connected to an enterprise network or the Internet if and to the extent such a connection is necessary and only when appropriate security measures (e.g. firewalls and/or network segmentation) are in place.

For additional information on industrial security measures that may be implemented, please visit <https://www.siemens.com/industrialsecurity>.

Siemens' products and solutions undergo continuous development to make them more secure. Siemens strongly recommends that product updates are applied as soon as they are available and that the latest product versions are used. Use of product versions that are no longer supported, and failure to apply the latest updates may increase customer's exposure to cyber threats.

To stay informed about product updates, subscribe to the Siemens Industrial Security RSS Feed under <https://www.siemens.com/cert>.

Subject to changes and errors. The information given in this document only contains general descriptions and/or performance features which may not always specifically reflect those described, or which may undergo modification in the course of further development of the products. The requested performance features are binding only when they are expressly agreed upon in the concluded contract.

All product designations may be trademarks or other rights of Siemens AG, its affiliated companies or other companies whose use by third parties for their own purposes could violate the rights of the respective owner.