

## LOGO!

### System Manual



This manual applies to LOGO! 8 6ED1052-xxx08-0BA2 device series.

Preface	
Getting started with LOGO!	1
LOGO! installation and wiring	2
Programming LOGO!	3
LOGO! functions	4
Web server	5
Cloud IoT connection	6
UDF (User-Defined Function)	7
Data log	8
Configuring LOGO!	9
Using memory cards	10
Security	11
LOGO! software	12
Applications	13
Technical data	A
Determining the cycle time	B
LOGO! without display ("LOGO! Pure")	C
LOGO! menu structure	D
Order numbers	E
Troubleshooting	F
Abbreviations	G

## Legal information

### Warning notice system

This manual contains notices you have to observe in order to ensure your personal safety, as well as to prevent damage to property. The notices referring to your personal safety are highlighted in the manual by a safety alert symbol, notices referring only to property damage have no safety alert symbol. These notices shown below are graded according to the degree of danger.

 <b>DANGER</b>
indicates that death or severe personal injury <b>will</b> result if proper precautions are not taken.
 <b>WARNING</b>
indicates that death or severe personal injury <b>may</b> result if proper precautions are not taken.
 <b>CAUTION</b>
indicates that minor personal injury can result if proper precautions are not taken.
<b>NOTICE</b>
indicates that property damage can result if proper precautions are not taken.

If more than one degree of danger is present, the warning notice representing the highest degree of danger will be used. A notice warning of injury to persons with a safety alert symbol may also include a warning relating to property damage.

### Qualified Personnel

The product/system described in this documentation may be operated only by **personnel qualified** for the specific task in accordance with the relevant documentation, in particular its warning notices and safety instructions. Qualified personnel are those who, based on their training and experience, are capable of identifying risks and avoiding potential hazards when working with these products/systems.

### Proper use of Siemens products

Note the following:

 <b>WARNING</b>
Siemens products may only be used for the applications described in the catalog and in the relevant technical documentation. If products and components from other manufacturers are used, these must be recommended or approved by Siemens. Proper transport, storage, installation, assembly, commissioning, operation and maintenance are required to ensure that the products operate safely and without any problems. The permissible ambient conditions must be complied with. The information in the relevant documentation must be observed.

### Trademarks

All names identified by ® are registered trademarks of Siemens Aktiengesellschaft. The remaining trademarks in this publication may be trademarks whose use by third parties for their own purposes could violate the rights of the owner.

### Disclaimer of Liability

We have reviewed the contents of this publication to ensure consistency with the hardware and software described. Since variance cannot be precluded entirely, we cannot guarantee full consistency. However, the information in this publication is reviewed regularly and any necessary corrections are included in subsequent editions.

# Preface

With LOGO! you have acquired a logic module that meets the stringent quality requirements of ISO 9001.

You can use LOGO! in many fields of applications. Due to its high functionality and easy operation, LOGO! offers you the utmost efficiency for almost any application.

## Purpose of this manual

This LOGO! manual provides you with information about the creation of circuit programs, about the installation and use of LOGO! 8 Base Modules with more enhanced features, the LOGO! TDE (Text Display with Ethernet interfaces), and LOGO! expansion modules.

For LOGO! 8 series, LOGO!Soft Comfort uses device type to distinguish different LOGO! device. For more information, you can refer to the following table.

Device	Order number and FS number	Device type in LOGO!Soft Comfort	LOGO!Soft Comfort Version
LOGO! BM	6ED1052-xxx00-0BA8 FS01-FS03	LOGO! 8 (0BA8.Standard)	LOGO!Soft Comfort V8.4 and later version
	6ED1052-xxx00-0BA8 FS04-FS06	LOGO! 8.1 & 8.2 (LOGO! 8.FS4)	
	6ED1052-xxx08-0BA0	LOGO! 8.1 & 8.2 (LOGO! 8.FS4)	
	6ED1052-xxx08-0BA1	LOGO! 8.3	
	6ED1052-xxx08-0BA2	LOGO! 8.4	
LOGO! TDE	6ED1055-4MH00-0BA1 FS01-FS06	LOGO! TDE 6ED1055-4MH08- 0BA1	LOGO!Soft Comfort V8.4 and later version
	6ED1055-4MH08-0BA0		
	6ED1055-4MH08-0BA1		

## LOGO!'s place in information technology

The wiring information in your LOGO! manual can also be found in the LOGO! Product Info, which you can access by scanning the QR code on the device. For more information on programming the LOGO! on your PC, refer to the *LOGO!Soft Comfort Online Help*.

LOGO!Soft Comfort is LOGO! programming software for PCs. It runs under Windows® (Windows 7®, Windows 8®, Windows 10® and Windows 11®), Linux® and Mac OS®. It helps you to get started with LOGO! and to write, test, print out and archive your programs, independent of LOGO!.

## Valid range of this manual

The manual applies to devices of LOGO! 8 6ED1052-xxx08-0BA2 series.

## New features of LOGO! 8.4 (6ED1052-xxx08-0BA2) device series

The following features are new for LOGO! 6ED1052-xxx08-0BA2 device:

- **Cloud IoT connection improvement**
  - Except AWS, LOGO! BM also supports Azure and Alibaba IoT Cloud connections and general MQTT broker connection.
  - You can configure and use new cloud data format which is displayed as Decimal, other than the old cloud data format which is displayed as Binary.
- **Variable Memory extension**
  - VX: the extended area of V area, and it has the same memory function as V area;
  - VR: the extended area to store retentive data, and the behavior is the same with retentivity of function block. When you save the circuit diagram to the SD card, VR area values in the circuit diagram will be synchronized to the inserted SD card.
- **BM sending emails**
  - LOGO! BM supports to send customized emails to corresponding recipients at trigger events after configuration in LOGO!Soft Comfort.
  - LOGO! BM menu includes "Email" in the "Diagnostics" page.
- **Data log improvement**

You can check and upload the connected BM's data log on BM Web server.
- **BM soft keyboard**

LOGO! BM provides soft keyboard (Page 75) to use when you change block name, circuit program name, program password, or switch from operator to administrator.
- **LOGO! digital online nameplate**

You can scan the QR code on LOGO! BM using a smart mobile device to reach to the digital online nameplate of this LOGO! device, where you can check all the necessary information about this device, including ordering, technical documentation, software upgrading and so on.
- **Micro SD card support**

Other than micro SD cards that support FAT32 file system format, LOGO! BM also support micro SD cards that support exFAT file system format.



## New features of LOGO! 8.3 (6ED1052-xxx08-0BA1) device series

The following features are new for LOGO! 6ED1052-XXX08-0BA1 devices:

- **Cloud IoT connection**

LOGO! BM supports AWS Cloud connectivity through MQTT protocol on Ethernet TCP/IP network.

- You can use IoT connectivity to synchronize data between LOGO! BM and AWS Cloud. When this function is enabled, LOGO! BM can publish data to AWS Cloud, and you can change LOGO! BM data remotely through AWS IoT.
- You can use LOGO!Soft Comfort V8.3 to set the Cloud data transmission.
- The LOGO! BM menu includes "Cloud" in the "Diagnostics" page.

- **Security enhancement**

- Enhanced the Network security (Page 311).

- **New menu items are included on TDE**

- The LOGO! TDE menu includes "Factory Reset" in the "Setup" page

## New features of LOGO! 8.2 (6ED1052-xxx08-0BA0) device series

The following features are new for LOGO! 6ED1052-XXX08-0BA0 devices:

- **Support the function that TDE can be scanned**

LOGO! TDE 6ED1055-4MH08-0BA0 can be scanned by LOGO!Soft Comfort V8.2 and later versions.

- **Support LOGO! Access Tool V2.0.0 and later versions**

With LOGO! Access Tool V2.0.0 and later versions, you can set data synchronization period, show history data and start or stop the data synchronization of LOGO! Base Module. For detailed information, refer to *LOGO! Access Tool Help*.

- **Support LOGO! Web Editor tool**

LOGO! Web Editor is a new tool used together with LOGO! Base Module (BM) and LOGO! Soft Comfort. This tool helps you create user-defined web pages in the Editor pane, and visit the whole project through Web Server of LOGO! Base Module. With LOGO! Web Editor, you can also integrate different components including some variables conveniently. For detailed information, refer to *LOGO! Web Editor Tool Online Help*.

## New features of LOGO! 8.1 (FS5) device series

The following features are new for LOGO! 8.FS5 devices

- **Improvement for circuit diagram compatibility**

For LOGO! 8.FS5, the circuit diagram can be used directly in SD card. Compared with LOGO! 8.FS4 and LOGO! 0BA8 device series, the circuit diagram in SD card need to convert in LOGO!Soft Comfort before using. For more information, refer to chapter Compatibility (Page 37).

- **Support function block parameters automatic storage**

The modification for function block parameters can be saved to SD card automatically.

## New features of LOGO! 8.1 (FS4) device series

The following features are new for LOGO! 8.FS4 devices:

- **Support Modbus protocol on Ethernet TCP/IP networks**

LOGO! supports both Modbus Server functions and Modbus Client functions. Modbus modules share connections with S7 modules. LOGO! has separated connection pools for server and client. Each connection in server pool can be used for S7 Server or Modbus Server. There is no limitation and reservation for any server. It means S7 server cannot access if all server connections are occupied by Modbus Server. It is also the same case for client connection pool. Refer to S7 sections for detailed information about server/client connection.

- **Support wider ambient temperature range**

LOGO! BM and EM modules can support wider ambient temperature range, and the ambient temperature is widened to -20 °C to +55 °C.

- **Support Network Time Protocol (NTP) function for time and data synchronization**

An NTP client can synchronize time from an NTP server. LOGO! 8.FS4 BM can serve as both an NTP server and an NTP client at the same time. The NTP function of LOGO! BM is disabled by default. You can enable it on the BM/TDE menu or LOGO!Soft Comfort.

- **Support LOGO! Access Tool**

Siemens provides a new tool, LOGO! Access Tool, to view and trace the variables in LOGO! Base module. You can also save the log files of the traced variables with this tool. For detailed information, refer to *LOGO! Access Tool Help*.

## New features of LOGO! 8.0 (0BA8) device series

The following features are new for LOGO! 0BA8 devices:

- **Ethernet communication support by all LOGO! 0BA8 Base Modules**

Each LOGO! 0BA8 Base Module is equipped with an RJ45 interface and a two-color status LED for Ethernet communication.

- **Small LOGO! 0BA8 module size**

Each LOGO! 0BA8 Base Module is designed with a width of 71.5 mm. The small size of LOGO! 0BA8 allows you to make efficient use of space.

- **New text display module LOGO! TDE with enhanced features**
  - LOGO! TDE module is available with two Ethernet interfaces. These two Ethernet interfaces can also function as a two-port switcher. You can connect the LOGO! TDE with a Base Module, a PC, or another LOGO! TDE through the Ethernet interfaces. LOGO! TDE can connect with different Base Modules through IP address selection.
  - LOGO! TDE provides a three-pin (P1, P2, and FE) terminal for power connection.
  - LOGO! TDE has three main menu commands available, respectively for the IP address selection of a Base Module, the remote settings of the connected Base Module, and the independent configuration of the LOGO! TDE.
- **Support of 6-line display and three backlight colors**

Both the LOGO! onboard display and LOGO! TDE support a 6-line character display and three backlight colors (white/amber/red). The LOGO! onboard display can display a maximum of 16 Western European characters or 8 Asian characters per line. LOGO! TDE can display a maximum of 20 Western European characters or 10 Asian characters per line.
- **Increased maximum I/O connections**

LOGO! OBA8 supports a maximum of 24 digital inputs, 20 digital outputs, 8 analog inputs and 8 analog outputs.
- **Built-in Web server in LOGO! Base Modules**

LOGO! OBA8 provides you with easy access through Internet browsers. With the Web server function, you can access the LOGO! Base Module using a connected device (PC, tablet or smart phone) by entering the IP address of the LOGO! module in the Web browser of the connected device.
- **Enhanced functions added to special function blocks**
  - **Astronomical clock:** Two new parameters "TR Offset" (sunrise offset) and "TS Offset" (sunset offset) are available for this function block. You can use these two parameters to set an offset for the sunrise/sunset value. The offset range is -59 to 59 minutes.
  - **Message texts:** LOGO! OBA8 devices support a 6-line message text display and ticking messages, as well as message text display on the Web server. You can enable the tick setting for each display line by setting the block parameters.
- **More flags for the creation of the circuit program**

LOGO! OBA8 supports 64 digital flags and 64 analog flags. Some new special flags are described as follows:

  - M28: Enables the LOGO! Display amber backlight
  - M29: Enables the LOGO! Display red backlight
  - M30: Enables the LOGO! TDE amber backlight
  - M31: Enables the LOGO! TDE red backlight
- **Extended menu commands for diagnostics**

With the extended menu commands for diagnostics, LOGO! OBA8 provides a facility for diagnosing software and hardware errors and viewing the error logs. You can use these menu commands to troubleshoot and debug the LOGO! system.

- **Curve representation of analog value changes**  
LOGO! 0BA8 supports the graphical display of analog value changes in the form of a trend curve on the onboard display. You can easily monitor each analog I/O in use by means of the trend curves when LOGO! is in RUN mode.
- **Micro SD card support**  
LOGO! 0BA8 supports micro SD (Secure Digital) cards that support FAT32 file system format. You can store and copy-protect a circuit program, with or without the data log of process data, from LOGO! 0BA8 to an SD card, or copy a circuit program from the card to LOGO! 0BA8.
- **Enhanced Data Log function**  
LOGO! 0BA8 supports a maximum of 20000 lines for each data log file stored on the micro SD card. LOGO! automatically creates a new data log file with a new name on the micro SD card when the number of lines in the current file exceeds the maximum number of lines.

### Compatibility with previous devices

LOGO! 8 device series are incompatible with any previous device series.

For more detailed information about the compatibility between different device series, refer to the topic "Compatibility (Page 37)".

### Additional support

Additional support is available on the Siemens LOGO! Web site (<http://www.siemens.com/logo>)

# Table of contents

	<b>Preface .....</b>	<b>3</b>
<b>1</b>	<b>Getting started with LOGO! .....</b>	<b>14</b>
1.1	Safety information .....	14
1.1.1	Cybersecurity information .....	14
1.1.2	Data protection.....	14
1.1.3	Safety information .....	15
1.2	Getting started with LOGO!.....	16
1.3	ID link for the digital nameplate .....	26
1.4	Certification and approvals.....	27
<b>2</b>	<b>LOGO! installation and wiring .....</b>	<b>31</b>
2.1	Modular LOGO! setup .....	32
2.1.1	Maximum LOGO! network setup .....	32
2.1.2	Maximum setup with expansion modules.....	34
2.1.3	Setup with different voltage classes .....	36
2.1.4	Compatibility .....	37
2.2	Installing/removing LOGO! .....	38
2.2.1	DIN rail mounting .....	40
2.2.2	Wall-mounting .....	42
2.2.3	Mounting the LOGO! TDE.....	43
2.2.4	Labeling LOGO! .....	44
2.3	Wiring LOGO! .....	44
2.3.1	Connecting the power supply.....	45
2.3.2	Connecting the LOGO! TDE power supply.....	47
2.3.3	Connecting LOGO! inputs.....	47
2.3.4	Connecting outputs .....	54
2.3.5	Connecting the Ethernet interface.....	57
2.4	Putting into operation.....	58
2.4.1	Powering on LOGO! .....	58
2.4.2	Operating states .....	61
<b>3</b>	<b>Programming LOGO!.....</b>	<b>62</b>
3.1	Connectors .....	63
3.2	Blocks and block numbers.....	65
3.3	From circuit diagram to LOGO! program.....	68
3.4	The four golden rules for operating LOGO!.....	70
3.5	Configuring menu access protection for LOGO! .....	71
3.6	Overview of LOGO! menus.....	74
3.7	Using soft keyboard .....	75

3.8	Writing and starting the circuit program.....	77
3.8.1	Selecting programming mode.....	77
3.8.2	The first circuit program.....	78
3.8.3	Circuit program input.....	79
3.8.4	Assigning a circuit program name .....	83
3.8.5	Password for circuit program protection.....	84
3.8.6	Switching LOGO! to RUN mode .....	89
3.8.7	Second circuit program.....	93
3.8.8	Deleting a block.....	98
3.8.9	Deleting block groups.....	99
3.8.10	Correcting programming errors.....	100
3.8.11	Selecting analog output values for RUN/STOP transition .....	101
3.8.12	Defining the type of analog outputs.....	102
3.8.13	Setting the power-on delay of LOGO!.....	103
3.8.14	Clearing the circuit program and password.....	104
3.8.15	Summertime/wintertime conversion .....	105
3.8.16	Network Time Protocol (LOGO! 8.FS4 and later versions only) .....	108
3.9	Configuring additional functions for LOGO!.....	111
3.9.1	Configuring network settings.....	112
3.9.2	Configuring a UDF (User-Defined Function).....	114
3.9.3	Configuring the Data Log.....	114
3.9.4	Viewing network inputs/outputs .....	114
3.9.5	Changing LOGO! to master/slave mode .....	116
3.9.6	Diagnosing errors from LOGO! .....	118
3.10	Memory space and circuit program size.....	126
<b>4</b>	<b>LOGO! functions .....</b>	<b>130</b>
4.1	Constants and connectors.....	130
4.2	Basic functions list - GF .....	135
4.2.1	AND .....	136
4.2.2	AND with edge evaluation .....	137
4.2.3	NAND (not AND).....	138
4.2.4	NAND with edge evaluation.....	138
4.2.5	OR.....	139
4.2.6	NOR (not OR).....	140
4.2.7	XOR (exclusive OR) .....	141
4.2.8	NOT (Negation, Inverter) .....	141
4.3	Special functions .....	142
4.3.1	Designation of the inputs.....	142
4.3.2	Time response .....	143
4.3.3	Backup of the real-time clock .....	144
4.3.4	Retentivity .....	144
4.3.5	Parameter protection.....	144
4.3.6	Calculating the gain and offset of analog values.....	145
4.4	Special functions list - SF.....	147
4.4.1	On-delay.....	152
4.4.2	Off-delay .....	155
4.4.3	On-/off-delay .....	157
4.4.4	Retentive on-delay.....	159
4.4.5	Wiping relay (pulse output).....	160

4.4.6	Edge-triggered wiping relay .....	162
4.4.7	Asynchronous pulse generator .....	164
4.4.8	Random generator .....	166
4.4.9	Stairway lighting switch .....	168
4.4.10	Multiple function switch .....	170
4.4.11	Weekly timer .....	173
4.4.12	Yearly timer .....	176
4.4.13	Astronomical clock.....	181
4.4.14	Stopwatch .....	183
4.4.15	Up/down counter .....	186
4.4.16	Hours counter.....	189
4.4.17	Threshold trigger .....	193
4.4.18	Analog threshold trigger .....	196
4.4.19	Analog differential trigger.....	199
4.4.20	Analog comparator .....	201
4.4.21	Analog watchdog.....	205
4.4.22	Analog amplifier .....	208
4.4.23	Latching relay .....	210
4.4.24	Pulse relay .....	211
4.4.25	Message texts.....	212
4.4.26	Softkey.....	222
4.4.27	Shift register .....	224
4.4.28	Analog multiplexer .....	226
4.4.29	Analog ramp.....	228
4.4.30	PI controller .....	232
4.4.31	Pulse width modulator (PWM).....	236
4.4.32	Mathematic instruction.....	239
4.4.33	Mathematic instruction error detection .....	242
4.4.34	Analog filter.....	244
4.4.35	Max/Min .....	246
4.4.36	Average value.....	249
4.4.37	Float/Integer Converter .....	251
4.4.38	Integer/Float Converter .....	253
<b>5</b>	<b>Web server.....</b>	<b>257</b>
5.1	Enabling the Web server .....	257
5.2	Logging on to the Web server .....	259
5.3	Viewing LOGO! system information.....	261
5.4	Operating the virtual module on the Web server.....	261
5.5	Viewing and editing variable memory tables .....	266
5.6	Viewing and uploading data log .....	267
5.7	Logging off from the Web server .....	267
<b>6</b>	<b>Cloud IoT connection .....</b>	<b>268</b>
6.1	LOGO! Cloud configuration .....	269
6.2	Secure Cloud connection .....	273
6.3	AWS Cloud data format.....	275
<b>7</b>	<b>UDF (User-Defined Function).....</b>	<b>280</b>

<b>8</b>	<b>Data log .....</b>	<b>284</b>
<b>9</b>	<b>Configuring LOGO! .....</b>	<b>286</b>
9.1	Selecting parameter assignment mode.....	286
9.1.1	Parameters .....	288
9.1.2	Selecting the parameters .....	289
9.1.3	Modifying parameters.....	290
9.2	Setting the default values for LOGO! .....	292
9.2.1	Setting the time of day and date .....	293
9.2.2	Setting the display contrast and backlight choice.....	295
9.2.3	Setting the menu language.....	297
9.2.4	Setting the number of AIs in LOGO! .....	298
9.2.5	Setting the start screen .....	298
<b>10</b>	<b>Using memory cards.....</b>	<b>300</b>
10.1	Formatting micro SD cards.....	300
10.2	Inserting and removing the card from LOGO! .....	304
10.3	Copying data from LOGO! to the card.....	306
10.4	Copying data from the card to LOGO!.....	308
<b>11</b>	<b>Security.....</b>	<b>310</b>
11.1	Network security .....	311
11.2	Program access security .....	313
11.2.1	Program password protection .....	313
11.2.2	Program copy protection.....	314
11.3	Menu access security .....	316
11.4	Installing LOGO! Root certificate .....	317
11.4.1	Installing the certificate for Windows .....	318
11.4.2	Installing the certificate for Linux .....	323
11.4.3	Installing the certificate for Mac OS and IOS .....	330
11.5	Secure decommissioning .....	332
11.5.1	Securely removing data .....	332
11.5.2	Recycling and disposal .....	333
<b>12</b>	<b>LOGO! software .....</b>	<b>334</b>
12.1	LOGO! software .....	334
12.2	Connecting LOGO! to a PC .....	336
<b>13</b>	<b>Applications.....</b>	<b>338</b>
<b>A</b>	<b>Technical data.....</b>	<b>341</b>
A.1	General technical data .....	341
A.2	Technical data: LOGO! 230... .....	344
A.3	Technical data: LOGO! DM8 230R and LOGO! DM16 230R .....	346
A.4	Technical data: LOGO! 24... .....	348
A.5	Technical data: LOGO! DM8 24 and LOGO! DM16 24 .....	350



---

A.6	Technical data: LOGO! 24RC.....	352
A.7	Technical data: LOGO! DM8 24R and LOGO! DM16 24R .....	354
A.8	Technical data: LOGO! 12/24... LOGO! DM8 12/24R.....	355
A.9	Switching capacity/service life of the relay outputs .....	358
A.10	Technical data: LOGO! AM2 .....	359
A.11	Technical data: LOGO! AM2 RTD.....	359
A.12	Technical data: LOGO! AM2 AQ .....	360
A.13	Technical data: LOGO! TDE (Text Display with Ethernet interfaces).....	361
<b>B</b>	<b>Determining the cycle time .....</b>	<b>363</b>
<b>C</b>	<b>LOGO! without display ("LOGO! Pure") .....</b>	<b>365</b>
<b>D</b>	<b>LOGO! menu structure.....</b>	<b>367</b>
D.1	LOGO! Basic.....	367
D.1.1	Menu overview .....	367
D.1.2	Main menu .....	367
D.1.3	Programming menu.....	368
D.1.4	Card menu.....	368
D.1.5	Setup menu .....	369
D.1.6	Network menu.....	370
D.1.7	Diagnostics menu .....	371
D.1.8	Start menu .....	372
D.2	LOGO! TDE .....	373
D.2.1	Menu overview .....	373
D.2.2	Main menu .....	374
D.2.3	LOGO! selection menu .....	375
D.2.4	LOGO! settings menu.....	375
D.2.5	LOGO! TDE settings menu .....	378
<b>E</b>	<b>Order numbers.....</b>	<b>380</b>
<b>F</b>	<b>Troubleshooting .....</b>	<b>382</b>
<b>G</b>	<b>Abbreviations .....</b>	<b>385</b>
	<b>Index.....</b>	<b>386</b>

# Getting started with LOGO!

## 1.1 Safety information

### 1.1.1 Cybersecurity information

Siemens provides products and solutions with industrial cybersecurity functions that support the secure operation of plants, systems, machines and networks.

In order to protect plants, systems, machines and networks against cyber threats, it is necessary to implement – and continuously maintain – a holistic, state-of-the-art industrial cybersecurity concept. Siemens' products and solutions constitute one element of such a concept.

Customers are responsible for preventing unauthorized access to their plants, systems, machines and networks. Such systems, machines and components should only be connected to an enterprise network or the internet if and to the extent such a connection is necessary and only when appropriate security measures (e.g. firewalls and/or network segmentation) are in place.

For additional information on industrial cybersecurity measures that may be implemented, please visit <https://www.siemens.com/cybersecurity-industry>.

Siemens' products and solutions undergo continuous development to make them more secure. Siemens strongly recommends that product updates are applied as soon as they are available and that the latest product versions are used. Use of product versions that are no longer supported, and failure to apply the latest updates may increase customer's exposure to cyber threats.

To stay informed about product updates, subscribe to the Siemens Industrial Cybersecurity RSS Feed under <https://new.siemens.com/cert>.

### 1.1.2 Data protection

Siemens observes the data protection guidelines, especially the requirements regarding data minimization (privacy by design). This means the following for this product: The product does not process / save any personal information, but only technical functional data (e.g. time stamps). If the user links this data to other data (e.g. shift plans) or if the user saves personal information on the same medium (e.g. hard disk) and therefore creates a personal reference in the process, the user has to ensure meeting the guidelines regarding data protection.

**Note****Notes on protecting administrator accounts**

A user with administrator rights has extensive access and manipulation options available to the system.

Therefore, ensure there are adequate safeguards for protecting the administrator accounts to prevent unauthorized changes. To do this, use secure passwords and a standard user account for normal operation. Other measures, such as the use of security policies, should be applied as needed.

---

**Note**

To protect LOGO!Soft Comfort and LOGO! Web Editor from any undesired manipulation when your PC suffers malicious attacks from the Internet, Siemens strongly recommends you to install a whitelist tool on the PC. Then use the tool to manage the software installed on your PC.

---

### 1.1.3 Safety information

**WARNING****Electric shock due to external supplied plan units**

Even if the main supply to the plant is disconnected, externally supplied modules can continue to carry voltage. An electric shock on contact with live parts can lead to death or serious injury.

For special Siemens modules, for example, relay modules, you can connect or switch voltages larger than 24 V DC, for example, 230 V AC. In some applications, these modules are supplied with voltages from outside the system (external power supply). In the event of an external power supply, a dangerous voltage may still be present on these modules even if the system is disconnected.

Ensure the following points before starting work:

- The plant is completely disconnected from the power supply.
- All externally supplied plant units are disconnected from the power supply

## 1.2 Getting started with LOGO!

### Here's LOGO!

LOGO! is a universal logic module made by Siemens that integrates:

- Controls
- Operator and display panel with background lighting
- Power supply
- Interface for expansion modules
- Interface for a micro SD card
- Interface for an optional text display (TDE) module
- Pre-configured standard functions, for example, on- and off-delays, pulse relay and softkey
- Timers
- Digital and analog flags
- Inputs and outputs, according to the device type

LOGO! 8 additionally integrates the following components:

- Interfaces for Ethernet communication
- FE (Functional Earth) terminal for connecting to earth ground
- One LED for indicating Ethernet communication status

### What LOGO! can do for you

LOGO! offers solutions for domestic and installation engineering applications such as stairway lighting, external lighting, sun blinds, shutters, shop window lighting and more. It can also offer solutions for switch cabinet engineering, as well as for mechanical and apparatus engineering such as gate control systems, air-conditioning systems, and rainwater pumps.

You can also use LOGO! to implement special control systems in conservatories or greenhouses, for control signal processing and, by connecting a communications module such as an AS-i module, for distributed local controlling of machines and processes.

Special versions without operator panel and display unit are available for series production applications in small machine, apparatus, switching cabinet and installation engineering.

### Which devices are available?

LOGO! Base Modules are available in two voltage classes:

- Class 1  $\leq 24$  V, i.e. 12 VDC, 24 VDC, 24 VAC
- Class 2  $> 24$  V, i.e. 115 VAC/VDC to 240 VAC/VDC

LOGO! Base Modules are available in two versions:

- **LOGO! Basic** (version with display): 8 inputs and 4 outputs
- **LOGO! Pure** (version without display): 8 inputs and 4 outputs

Each module has an expansion interface and an Ethernet interface and provides 44 pre-configured standard and special function blocks for the creation of your circuit program.

### Which expansion modules are available?

- LOGO! DM8 digital modules are available for operation with 12 VDC, 24 VAC/VDC and 115 VAC/VDC to 240 VAC/VDC, and are equipped with four inputs and four outputs.
- LOGO! DM16 digital modules are available for operation with 24 VDC and 115 VAC/VDC to 240 VAC/VDC, and are equipped with eight inputs and eight outputs.
- LOGO! analog modules are available for operation with 24 VDC and some with 12 VDC, depending on the specific module. Each is equipped with two analog inputs, two PT100 inputs, two PT100/PT1000 inputs (either PT100 or PT1000 or one of each), or two analog outputs.

Each digital/analog module has two expansion interfaces for connecting additional modules.

### Which display modules are available?

- LOGO! Basic (integrated in base module)
- LOGO! TDE

### Features of the LOGO! TDE

The LOGO! TDE is available for the OBA8 series. It provides an additional display that is wider than the LOGO! Basic. It has four function keys that you can program in your circuit program as inputs. Like the LOGO! Basic, it has four cursor keys, an ESC key and an Enter key that you can also program in your circuit program and use for navigation on the LOGO! TDE.

You can create and download a power-up screen for the LOGO! TDE from LOGO!Soft Comfort. This screen displays briefly when you initially power on the LOGO! TDE. You can also upload the power-up screen from the LOGO! TDE to LOGO!Soft Comfort.

LOGO! TDE provides three main menu commands, respectively for the IP address selection of a Base Module, the remote settings of the connected Base Module, and the independent configuration of the LOGO! TDE. The menus for the LOGO! TDE are shown in Appendix "LOGO! TDE (Page 373)".

LOGO! TDE 6ED1055-4MH08-0BA1 and 6ED1055-4MH08-0BA0 can be scanned by LOGO!Soft Comfort V8.2 and later versions.

### It's your choice

The various LOGO! Base Modules, expansion modules, LOGO! TDE and communications modules offer you a highly flexible and adaptive system to suit your specific tasks.

The LOGO! system offers you many solutions for small domestic installations, simple automation tasks, and even complex engineering tasks involving its integration into a bus system.

---

**Note**

You can only use expansion modules of the same voltage as the LOGO! Base Module. Mechanical encoding pins in the housing prevent you from connecting devices of a different voltage class.

Exception: The interface on the left side of an analog module or communications module is galvanically isolated. These types of expansion modules can therefore be connected to devices of a different voltage class (Page 36).

---

A LOGO! TDE has two Ethernet interfaces. You can connect each interface to a Base Module, a PC, or another LOGO! TDE.

Each LOGO! Base Module supports the following connections for the creation of the circuit program, regardless of the number of connected modules:

- Digital inputs I1 to I24
- Analog inputs AI1 to AI8
- Digital outputs Q1 to Q20
- Analog outputs AQ1 to AQ8
- Digital flag blocks M1 to M64:
  - M8: Initialization Flag (Displays blue in LOGO!Soft Comfort V8.2 and later versions)
  - M25: Backlight flag: LOGO! onboard display white
  - M26: Backlight flag: LOGO! TDE white
  - M27: Message Character Set Flag (Displays green in LOGO!Soft Comfort V8.2 and later versions)
  - M28: Backlight flag: LOGO! onboard display amber
  - M29: Backlight flag: LOGO! onboard display red
  - M30: Backlight flag: LOGO! TDE amber
  - M31: Backlight flag: LOGO! TDE red
- Analog flag blocks: AM1 to AM64
- Shift register bits: S1.1 to S4.8 (32 shift register bits)
- 4 cursor keys
- Blank outputs: X1 to X64

The devices of LOGO! 8 series additionally supports the display of the following network digital/analog inputs and outputs if you have previously configured them in the circuit program in LOGO!Soft Comfort V8.1 (and later versions) and downloaded the program to the device:

- 64 network digital inputs: NI1 to NI64
- 32 network analog inputs: NAI1 to NAI32

- 64 network digital outputs: NQ1 to NQ64
- 16 network analog outputs: NAQ1 to NAQ16

## The LOGO! structure

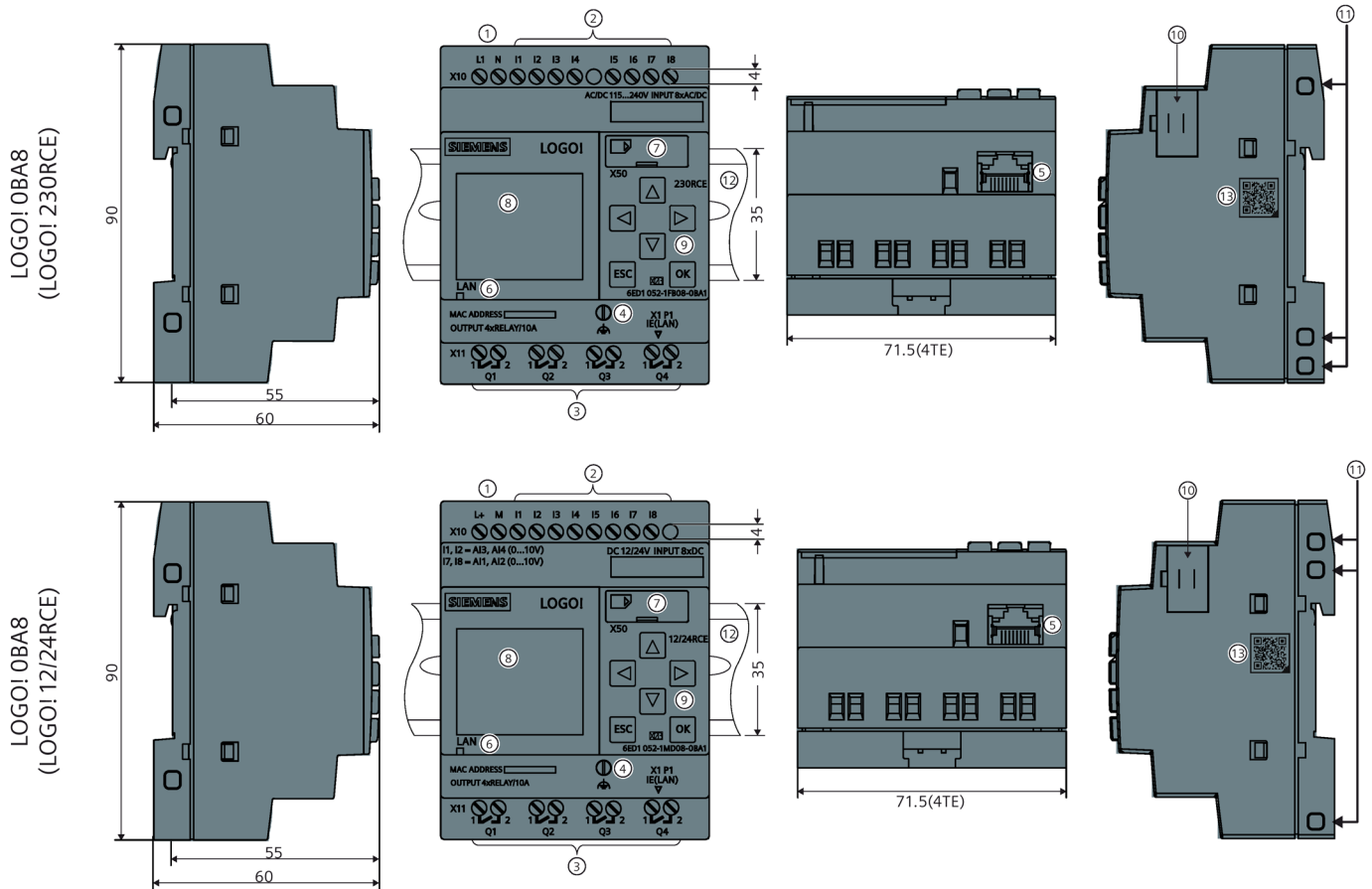

- |   |   |
|---|---|
| ① Power supply  | ② Inputs                                      |
| ③ Outputs   | ④ FE terminal, for connecting to earth ground |
| ⑤ RJ45 interface, for connection to Ethernet (10/100 Mbit/s)                          | ⑥ Ethernet communication status LED           |
| ⑦ Micro SD card slot  | ⑧ LCD   |
| ⑨ Control panel   | ⑩ Expansion interface                         |
| ⑪ Mechanical coding sockets   | ⑫ Standard DIN rail                           |
| ⑬ Device QR code. Refer to section "Device QR code (Page 26)" to learn more about it. |   |

1.2 Getting started with LOGO!

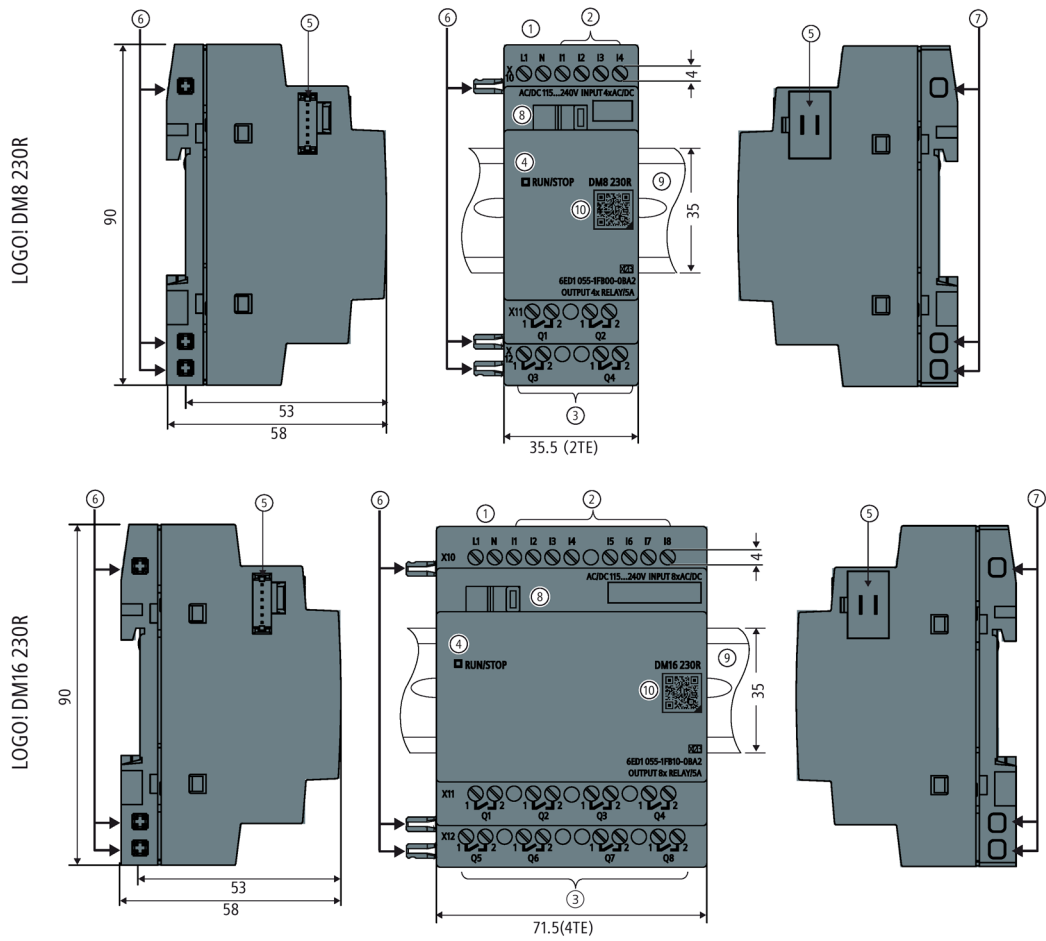

- ① Power supply
- ② Inputs
- ③ Outputs
- ④ RUN/STOP LED
- ⑤ Expansion interface
- ⑥ Mechanical coding pins
- ⑦ Mechanical coding sockets
- ⑧ Slide
- ⑨ Standard DIN rail
- ⑩ Device QR code. Refer to section "Device QR code (Page 26)" to learn more about it.



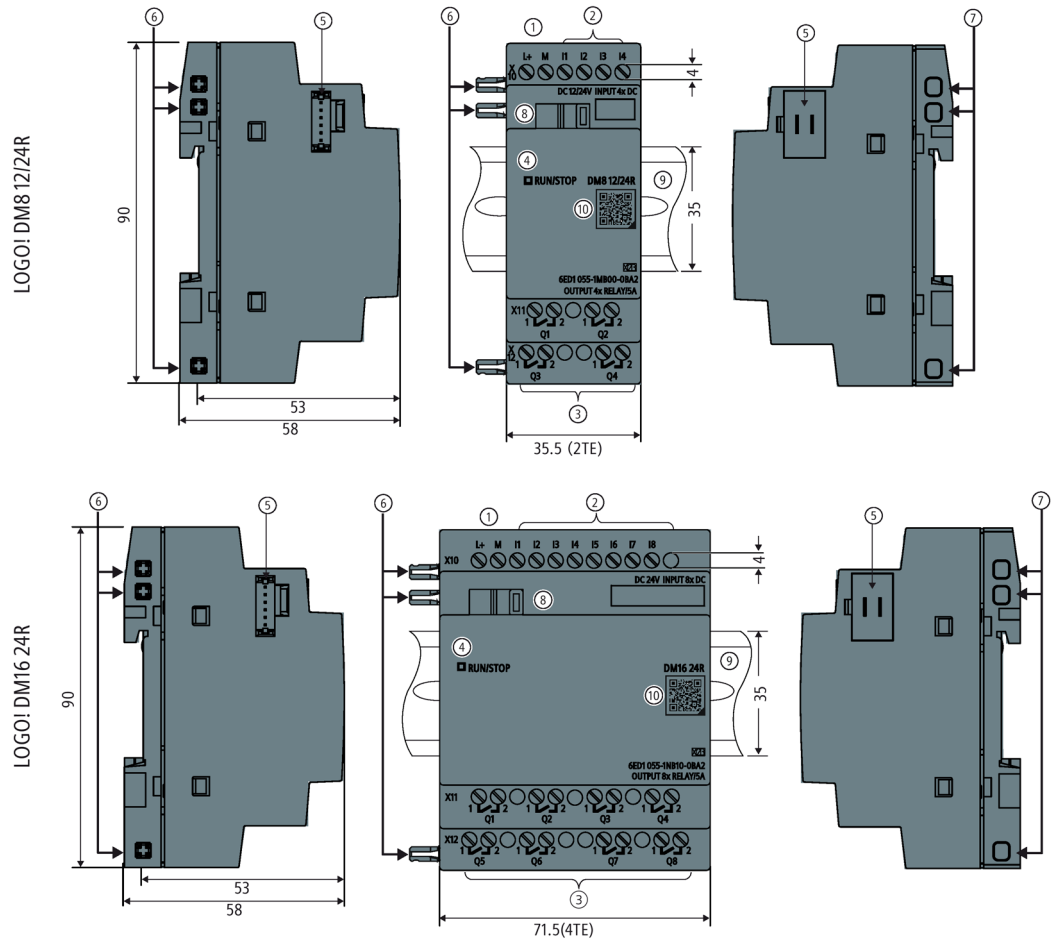

- ① Power supply
- ② Inputs
- ③ Outputs
- ④ RUN/STOP LED
- ⑤ Expansion interface
- ⑥ Mechanical coding pins
- ⑦ Mechanical coding sockets
- ⑧ Slide
- ⑨ Standard DIN rail
- ⑩ Device QR code. Refer to section "Device QR code (Page 26)" to learn more about it.

**LOGO! AM2**

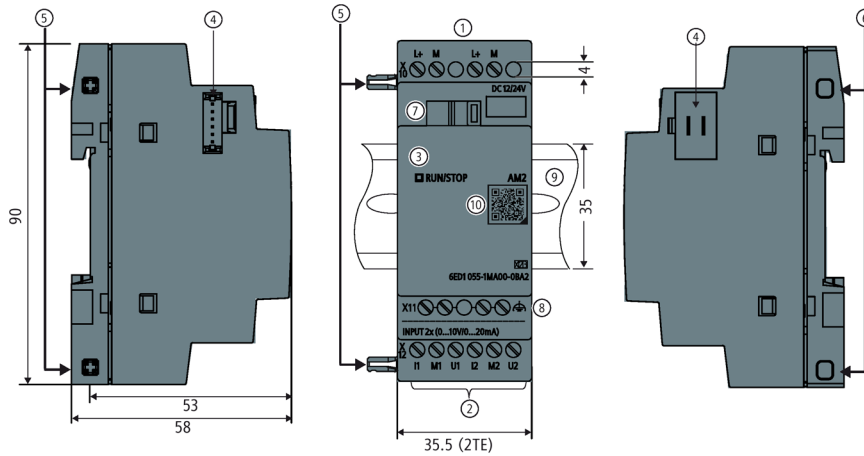

- ① Power supply
- ② Inputs
- ③ RUN/STOP LED
- ④ Expansion interface
- ⑤ Mechanical coding pins
- ⑥ Mechanical coding sockets
- ⑦ Slide
- ⑧ FE terminal, for connecting to earth ground and the shielding of analog measuring cables
- ⑨ Standard DIN rail
- ⑩ Device QR code

**LOGO! AM2 AQ**

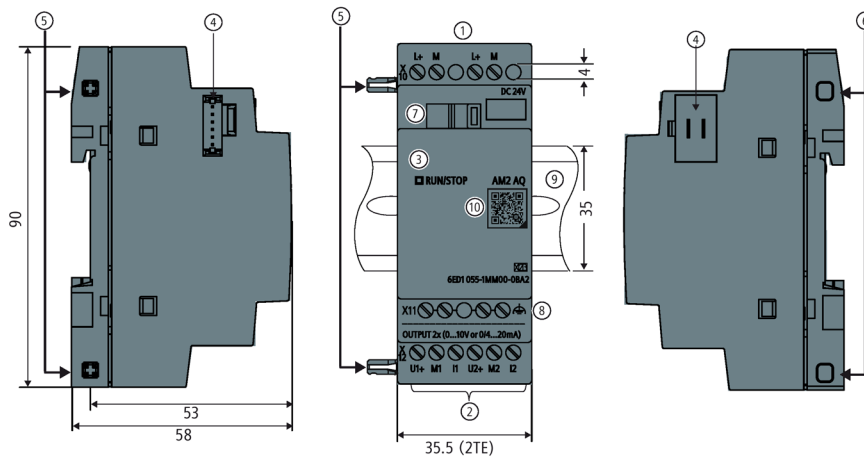

- ① Power supply
- ② Outputs
- ③ RUN/STOP LED
- ④ Expansion interface
- ⑤ Mechanical coding pins
- ⑥ Mechanical coding sockets
- ⑦ Slide
- ⑧ FE terminal, for connecting to earth ground
- ⑨ Standard DIN rail
- ⑩ Device QR code. Refer to section "Device QR code (Page 26)" to learn more about it.

## LOGO! TDE

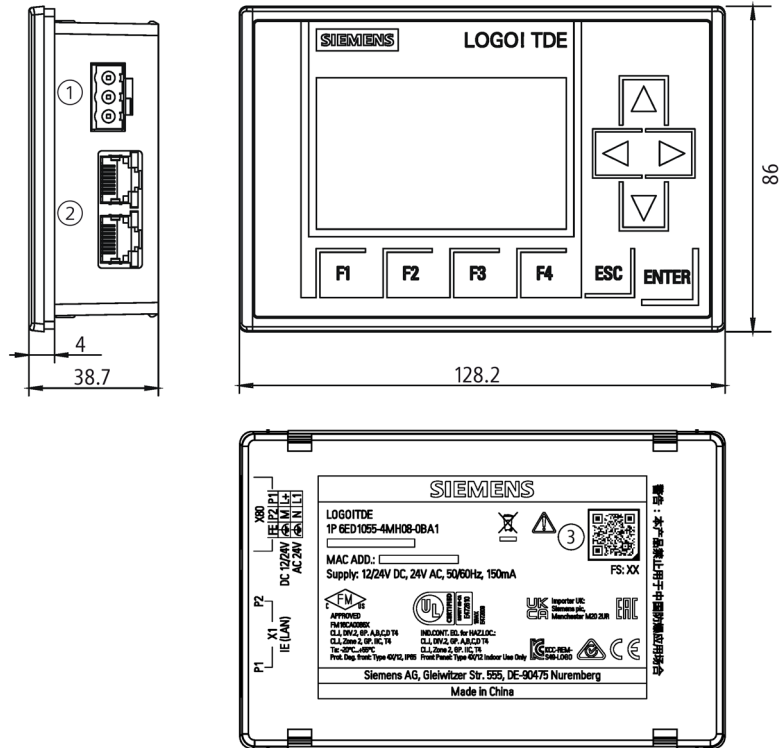

- ① Power supply
- ② Ethernet interfaces
- ③ Device QR code. Refer to section "Device QR code (Page 26)" to learn more about it.







The LOGO! TDE includes a wider display area than the LOGO! onboard display. It includes four programmable cursor keys, four programmable function keys, an ESC key, and an ENTER key. You use the Ethernet cable to connect from the Ethernet interface on the right side of the LOGO! TDE to the Ethernet interface on the LOGO! Base Module.

## How to identify LOGO!

The LOGO! identifier informs you of various properties:



- 12/24: 12/24 VDC version
- 230: 115 VAC/VDC to 240 VAC/VDC version
- R: Relay outputs (without R: solid-state outputs)
- C: Integrated real-time clock
- E: Ethernet interface
- o: Version without display ("LOGO! Pure")
- DM: Digital module
- AM: Analog module
- TDE: Text Display with Ethernet interfaces

## Symbols

	Version with display unit is equipped with 8 inputs, 4 outputs and 1 Ethernet interface.
	Version without display unit is equipped with 8 inputs, 4 outputs and 1 Ethernet interface.
	The digital module is equipped with 4 digital inputs and 4 digital outputs.
	The digital module is equipped with 8 digital inputs and 8 digital outputs.
	The analog module is equipped with 2 analog inputs or 2 analog outputs, according to the device type.
	The LOGO! TDE module is equipped with 2 Ethernet interfaces.

## Versions

The following LOGO! versions are available:

Symbol	Designation	Supply voltage	Inputs	Outputs	Properties
	LOGO! 12/24RCE	12/24VDC	8 digital <sup>1)</sup>	4 relays (10 A)	
	LOGO! 230RCE	115 VAC/VDC to 240 VAC/VDC	8 digital	4 relays (10 A)	
	LOGO! 24CE	24 VDC	8 digital <sup>1)</sup>	4 solid state 24 V/0.3 A	
	LOGO! 24RCE <sup>3)</sup>	24 VAC/VDC	8 digital	4 relays (10 A)	
	LOGO! 12/24RCEo	12/24 VDC	8 digital <sup>1)</sup>	4 relays (10 A)	no display unit no keyboard
	LOGO! 24CEo	24 VDC	8 digital <sup>1)</sup>	4 solid state 24 V/0.3 A	no display unit no keyboard
	LOGO! 24RCEo <sup>3)</sup>	24 VAC/VDC	8 digital	4 relays (10 A)	no display unit no keyboard
	LOGO! 230RCEo <sup>2)</sup>	115 VAC/VDC to 240 VAC/VDC	8 digital	4 relays (10 A)	no display unit no keyboard



<sup>1)</sup> Of those can be used alternatively: 4 analog inputs (0 V to 10 V) and 4 fast digital inputs.

<sup>2)</sup> 230 VAC versions: Two groups consisting of 4 inputs each. Each input within a group must be connected to the same phase. It is possible to interconnect groups with a different phase.

<sup>3)</sup> The digital inputs can be operated with P or N action.

## Expansion modules

The following expansion modules can be connected to LOGO!:

Symbol	Name	Power supply	Inputs	Outputs
	LOGO! DM8 12/24R	12/24 VDC	4 digital	4 relays (5 A)
	LOGO! DM8 24	24 VDC	4 digital	4 solid state 24 V/0.3 A
	LOGO! DM8 24R <sup>3)</sup>	24 VAC/VDC	4 digital	4 relays (5 A)
	LOGO! DM8 230R	115 VAC/VDC to 240 VAC/VDC	4 digital <sup>1)</sup>	4 relays (5 A)
	LOGO! DM16 24	24 VDC	8 digital	8 solid state 24 V/0.3 A
	LOGO! DM16 24R	24 VDC	8 digital	8 relays (5 A)
	LOGO! DM16 230R	115 VAC/VDC to 240 VAC/DC	8 digital <sup>4)</sup>	8 relays (5 A)
	LOGO! AM2	12/24 VDC	2 analog 0 V to 10 V or 0/4 mA to 20 mA <sup>2)</sup>	None
	LOGO! AM2 RTD	12/24 VDC	2 PT100 or 2 PT1000 or 1 PT100 plus 1 PT1000 <sup>6)</sup> -50 °C to 200 °C	None
	LOGO! AM2 AQ	24 VDC	None	2 analog 0 VDC to 10 VDC or 0/4 mA to 20 mA <sup>5)</sup>

- 1) Different phases are not allowed within the inputs.
- 2) 0 V to 10 V, 0/4 mA to 20 mA can be connected optionally.
- 3) Digital inputs can be operated either with P or with N action.
- 4) Two groups consisting of four inputs each. Each input within a group must be connected to the same phase. It is possible to interconnect groups with a different phase.
- 5) 0 V to 10 V, 0/4 mA to 20 mA can be connected optionally.
- 6) Sensors supported by the LOGO! AM2 RTD module are the PT100 and PT1000 sensors with a default temperature coefficient  $\alpha$  of 0.003850.

## Text display module

The following LOGO! TDE module is available:

Symbol	Name	Supply voltage	Display
	LOGO! TDE	24 VAC/VDC 12 VDC	LCD (160 x 96) 6-row display

## 1.3 ID link for the digital nameplate

The ID link is a globally unique identifier according to IEC 61406, which you can find as a QR code on your product and the product packaging.

You can recognize the ID link by the frame with a black frame corner at the bottom right. The ID link takes you to the digital nameplate of your product. Scan the QR code on the product or on the packaging label with a smartphone camera, barcode scanner, or reader app.

In the digital nameplate, you will find product data, manuals, declarations of conformity, certificates and other helpful information about your product.

Below is an example of the ID link for LOGO! Base Module 12/24RCE.



## 1.4 Certification and approvals

### Certification and approvals

LOGO! is certified to cULus and cFMus.

- cULus Haz. and ordinary Loc.  
Underwriters Laboratories Inc. (UL) to
  - UL 508 (Industrial Control Equipment)
  - CSA C22.2 No. 142 (Process Control Equipment)
  - UL 121201 (Hazardous Location)
  - CSA C22.2 No.213 (Hazardous Location)APPROVED for use in  
Class I, Division 2, Group A, B, C, D T4  
Class I, Zone 2, Group IIC Tx
- FM Approval (US Approval and Canada Approval)  
Factory Mutual Research (FM) to
  - Approval Standard Class Number 3611, 3600, 3810
  - ANSI/UL 61010-1
  - ANSI/UL 121201
  - ANSI/IEC60529
  - ANSI/NEMA 250
  - CSN/CSA-C22.2 No. 213
  - CAN/CSA-C22.2 No. 61010-1
  - CAN/CSA-C22.2 No.94APPROVED for use in
  - Class I, Division 2, Group A, B, C, D Tx
  - Class I, Zone 2, Group IIC Tx

 **WARNING**

**Substitution of components can impair the suitability for Class I, Division 2 and Zone 2.**

Repair of units must be done by an authorized Siemens Service Center.

**Note**

You will find current approvals on the rating plate of the relevant module.

LOGO! is issued with the CE Certificate of Conformity. It is compliant with following standards:

- EN 61131-2
- EN 61000-6-1, EN 61000-6-2, EN 61000-6-3, EN 61000-6-4
- EN IEC 63000

## 1.4 Certification and approvals

Marine certificate of approval:

- ABS (American Bureau of Shipping)
- BV (Bureau Veritas)
- DNV-GL (Det Norske Veritas (Norwegen)-Germanischer Lloyd)
- LRS (Lloyds Register of Shipping)
- Class NK (Nippon Kaiji Kyokai)
- CCS (CHINA CLASSIFICATION SOCIETY)
- KR (KOREAN REGISTER)

### ID for Australia



Our products carrying the label shown at the side are compliant with AS/NZS 61000.6.4, AS/NZS 61000.6.3 standard.

### ID for Korea



Our products (except the LOGO! CSM modules) carrying the label shown at the side are compliant with Korean standards.

### WEEE label (European Union)



Disposal instructions, observe the local regulations and below Recycling and Disposal.

### Recycling and disposal

You can fully recycle LOGO! devices due to their low-pollutant equipment. For environmentally friendly recycling and disposal of your old equipment, contact a certified electronic waste disposal company and dispose of the equipment according to the applicable regulations in your country.



## UK Conformity Assessed marking



The device complies with the designated British standards (BS) for programmable logic controllers published in the official consolidated list of the British Government. The device meets the requirements and protection targets of the following regulations and related amendments:

- Electrical Equipment (Safety) Regulations 2016 (Low-Voltage)
- Electromagnetic Compatibility Regulations 2016 (EMC)
- Regulations on the restriction of the use of certain hazardous substances in electrical and electronic equipment 2012 (RoHS).

UK Declarations of Conformity for the respective authorities are available from:

Siemens AG  
Digital Industries  
Factory Automation  
DI FA TI COS TT  
P.O. Box 1963  
D-92209 Amberg

The UK Declaration of Conformity is also available for download from the Siemens Industry Online Support website under the keyword "Declaration of Conformity".

FM



Approval Standard Class Number 3611, 3600, 3810 Factory Mutual Research (FM) in accordance with

Approval Standard Class Number 3611, 3600, 3810

ANSI/UL61010-1, ANSI/UL 121201

CAN/CSA-C22.2 No. 0-10

CSA C22.2 No. 213

CAN/CSA-C22.2 No. 61010-1

APPROVED for use in Class I, Division 2, Group A, B, C, D T4;

Class I, Zone 2, Group IIC Tx

Installation Instructions for FM

- WARNING – Explosion Hazard – Do not disconnect while circuit is live unless area is known to be non-hazardous.
- WARNING - Explosion Hazard - Substitution of components may impair suitability for Class I, Division 2 or Zone 2.
- This equipment is suitable for use in Class I, Division 2, Groups A, B, C, D; Class I, Zone 2, Group IIC; or non-hazardous locations.

LOGO! modules are therefore suitable for use in industrial and residential areas. Use in Class I, Division 2, Group A, B, C and D locations or in non-hazardous locations is supported.

### Identification for Eurasion Customs Union

- EAC (Eurasian Conformity)
- Customs union of Russia, Belarus and Kazakhstan
- Declaration of conformity according to Technical Regulations of the Customs Union (TR CU)

### CCCEX approval



The following approvals according to the following standards are valid for a device with the "CCC" marking.

- Standards:
  - GB/T 3836.1-2021 (Explosive atmospheres - Part 1: Equipment - General requirements)
  - GB/T 3836.3-2021 (Explosive atmospheres - Part 3: Equipment protection by increased safety "e")
  - GB/T 3836.8-2021 (Explosive atmospheres - Part 8: Equipment protection by type of protection "n")
- Approvals:
  - Ex ec nC IIC T4 Gc (module with relay outputs)
  - Ex ec IIC T4 Gc
  - -20 °C to +55 °C

#### Special conditions for safe operation of the devices

- The equipment shall only be used in an area of not more than pollution degree 2, as defined in GB/T 16935.1.
- The equipment shall be installed in an enclosure that provides a minimum ingress protection of IP 54 in accordance with GB/T 3836.1, and accessible only by use of a tool.
- Transient protection shall be provided that is set at a level not exceeding 140% of the peak rated voltage value at the supply terminals to the equipment.
- Antenna shall be installed within the end use enclosure. Routing and remote installation (not evaluated as part of this certification) of the antenna shall be in accordance with the appropriate location regulations when installed in unclassified and/or zone 2 Hazardous Locations.

# LOGO! installation and wiring

## General guidelines

Note the following guidelines for installing and wiring your LOGO!:

- Always ensure you comply with current rules and standards when wiring your LOGO!. Also, conform with all national and regional regulations when you install and operate the devices. For information on standards and regulations that apply to your specific case, contact your local authorities.
- Always switch off power before you wire or install/remove a module.
- Always use cables with appropriate conductor cross-sections for the relevant current. You can wire LOGO! with cable conductor cross-sections (Page 44) from 1.5 mm<sup>2</sup> to 2.5 mm<sup>2</sup>.
- Keep the cabling as short as possible. If longer cables are necessary, use shielded cables. Always route your cables in pairs; that is, one neutral conductor plus one phase conductor or signal line.
- Always keep separate:
  - The AC wiring
  - High-voltage DC circuits with high-frequency switching cycles
  - Low-voltage signal wiring
- Install wires with appropriate strain relief.
- Provide a suitable lightning surge arrester, such as DCO RK E 24, for cables installed in hazardous areas.
- Do not connect an external power supply in parallel to the output load of a DC output. This could develop a reverse current at the output if you have not installed a diode or similar barrier device.
- Be sure to use only certified components to ensure reliable functioning of equipment.

---

### Note

Only qualified personnel who are familiar with and follow general engineering rules, relevant regulations and standards must install LOGO! devices.

 <b>WARNING</b>
<b>Explosion hazard</b>
Do not disconnect equipment while the circuit is live or unless the area is known to be free of ignitable concentrations.

## What you must note when installing

LOGO! is designed for fixed and enclosed installation in the housing or the control cabinet.

### **WARNING**

Attempts to install or wire LOGO! or related equipment with power applied could cause electric shock or faulty operation of the equipment. Failure to disable all power to LOGO! and related equipment during installation or removal procedures could result in death or serious injury to personnel, and/or damage to equipment.

Always follow appropriate safety precautions and be sure to disconnect power from LOGO! before attempting to install or remove LOGO! or related equipment.

Modules of a LOGO! are open facilities. This means that you must install LOGO! only in a housing or cabinet.

Allow access to the housings or cabinets only with the use of a key or a tool and only by authorized or approved personnel.

You can operate LOGO! from the front at any time.

## 2.1 Modular LOGO! setup

### 2.1.1 Maximum LOGO! network setup

#### Maximum LOGO! 8 network setup

LOGO! 8 supports SIMATIC S7/Modbus communication over a 10/100 Mbit/s TCP/IP Ethernet network.

A LOGO! 8 device can support the following network connections:

- A maximum of 16 TCP/IP-based S7/Modbus communication connections with the following devices:
  - Additional LOGO! 8 devices
  - SIMATIC S7 PLCs with Ethernet functionality
  - Modbus over TCP/IP compatible device
  - A maximum of one SIMATIC HMI that supports Ethernet communication with networked S7 PLCs

There are two types of connections available for S7/Modbus communication, static connection and dynamic connection. For the static connection, the server reserves the required resources for the connected client to ensure stable data transfer. For the dynamic connection, the server responds to a communication request only when free resources are available. You can configure the static/dynamic connections as required, for example, n

static connections and 16-n dynamic connections. LOGO! supports a maximum of eight static connections.

- A maximum of one TCP/IP Ethernet connection with the LOGO! TDE. A LOGO! TDE module can connect with different Base Modules through IP address selection, but can not communicate with more than one Base Module at the same time.
- A maximum of one TCP/IP Ethernet connection between a LOGO! Base Module and a PC with LOGO!Soft Comfort V8.2 (and later versions)

---

**Note**

For those devices support both S7 and Modbus communications, Siemens highly recommends you connect it to LOGO! network with S7 connection.

---

**Note**

For detailed information about security functions on LOGO!, see Chapter Security (Page 310).

---

**Note**

You can only construct a LOGO! 8 network topology using LOGO!Soft Comfort V8.0 and later versions.

---

A **typical** LOGO! 8 network setup shows as below:

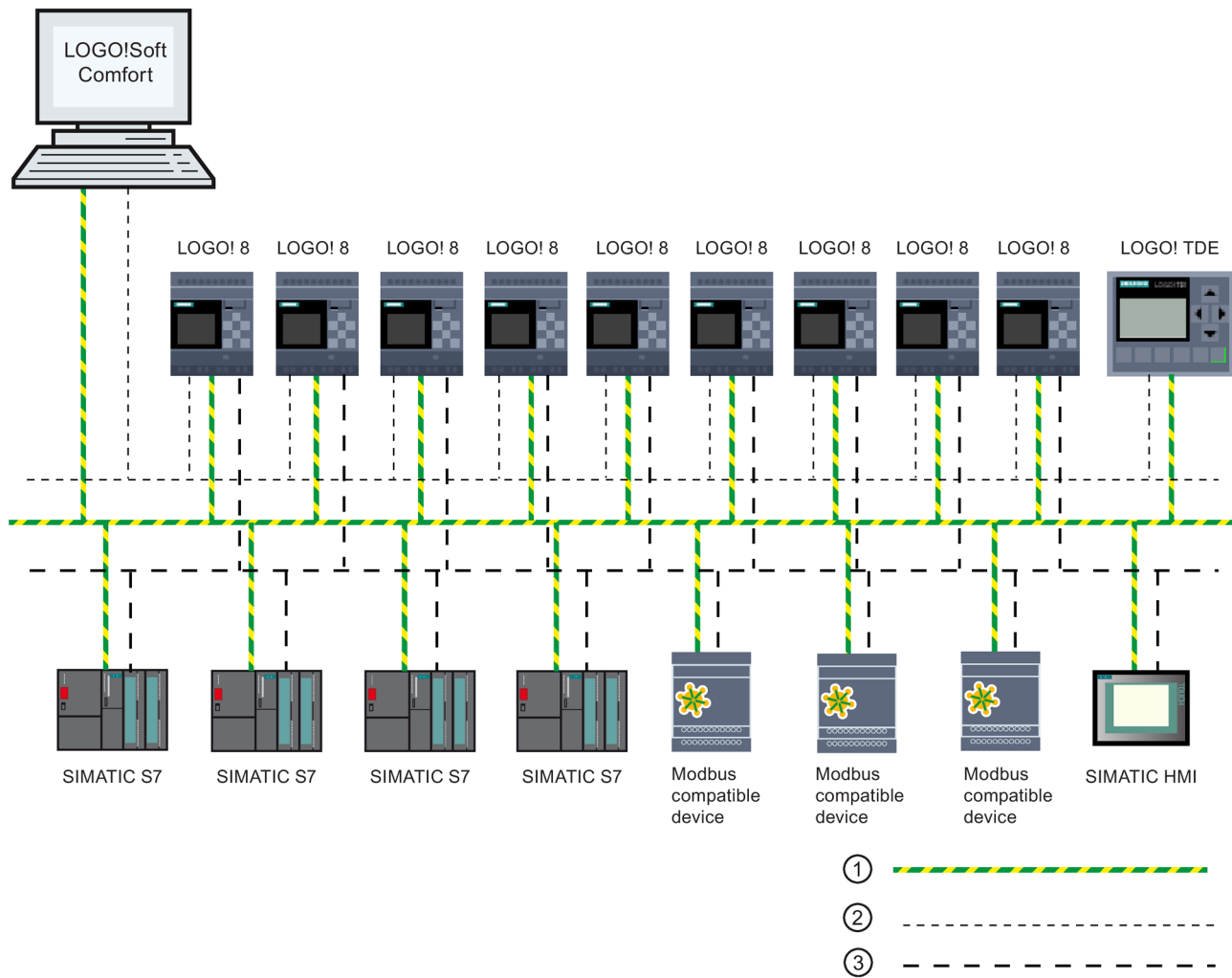

- ① Physical Ethernet connections
- ② Logical connection for communication between LOGO! and PC (by TCP/IP-based Ethernet)
- ③ Logical connections for S7 and Modbus communication between SIMATIC devices (with S7 protocol over TCP/IP)

### 2.1.2 Maximum setup with expansion modules

LOGO! supports a maximum of 24 digital inputs, 8 analog inputs, 20 digital outputs, and 8 analog outputs (Page 16). You can achieve the maximum setup in different ways as shown below:

**Maximum setup of a LOGO! with analog inputs onboard - four in use**

LOGO! Base Module, 4 digital modules and 6 analog modules (example)

I1, I2, I3 .. I6, I7, I8 AI3, AI4, AI1, AI2	I9..I12	I13..I16	I17..I20	I21..I24	AI5, AI6	AI7, AI8				
LOGO! Base Module	LOGO! DM8	LOGO! DM8	LOGO! DM8	LOGO! DM8	LOGO! AM2	LOGO! AM2	LOGO! AM2 AQ	LOGO! AM2 AQ	LOGO! AM2 AQ	LOGO! AM2 AQ
Q1..Q4	Q5..Q8	Q9..Q12	Q13..Q16	Q17..Q20			AQ1, AQ2	AQ3, AQ4	AQ5, AQ6	AQ7, AQ8

**Maximum setup of a LOGO! with analog inputs onboard - two in use**

LOGO! Base Module, 4 digital modules and 7 analog modules (example)

I1, I2, I3 .. I6, I7, I8 AI1, AI2	I9..I12	I13..I16	I17..I20	I21..I24	AI3, AI4	AI5, AI6	AI7, AI8					
LOGO! Base Module	LOGO! DM8	LOGO! DM8	LOGO! DM8	LOGO! DM8	LOGO! AM2	LOGO! AM2	LOGO! AM2	LOGO! AM2 AQ	LOGO! AM2 AQ	LOGO! AM2 AQ	LOGO! AM2 AQ	LOGO! AM2 AQ
Q1..Q4	Q5..Q8	Q9..Q12	Q13..Q16	Q17..Q20				AQ1, AQ2	AQ3, AQ4	AQ5, AQ6	AQ7, AQ8	

**Maximum setup of a LOGO! without analog inputs onboard (LOGO! 24RCE/24RCEo and LOGO! 230RCE/230RCEo)**

LOGO! Base Module, 4 digital modules and 8 analog modules (example)

I1 . . . . . I8	I9..I12	I13..I16	I17..I20	I21..I24	AI1, AI2	AI3, AI4	AI5, AI6	AI7, AI8				
LOGO! Base Module	LOGO! DM8	LOGO! DM8	LOGO! DM8	LOGO! DM8	LOGO! AM2	LOGO! AM2	LOGO! AM2	LOGO! AM2	LOGO! AM2 AQ	LOGO! AM2 AQ	LOGO! AM2 AQ	LOGO! AM2 AQ
Q1..Q4	Q5..Q8	Q9..Q12	Q13..Q16	Q17..Q20					AQ1, AQ2	AQ3, AQ4	AQ5, AQ6	AQ7, AQ8

For LOGO! 12/24RCE/12/24RCEo and LOGO! 24CE/24CEo modules, you can configure whether the module uses zero, two or four of the four possible analog inputs. AI inputs are numbered consecutively depending on how many you configure the LOGO! Base Module to use. If you configure two inputs, they are numbered AI1 and AI2, and correspond to the I7 and I8 input terminals. Subsequent AI expansions modules would begin numbering at AI3. If you configure four inputs, they are numbered AI1, AI2, AI3, and AI4, and correspond to I7, I8, I1, and I2 in that order. Subsequent AI expansions modules would begin numbering at AI5. See topics "Constants and connectors (Page 130)" and "Setting the number of AIs in LOGO! (Page 298)".

**High-speed/optimal communication performance**

For optimal and high-speed communication performance between the LOGO! Base Module and the various modules, install the digital modules first, then the analog modules (as the examples above show). (The special function PI controller is an exception: the AI used for the value PV should be on the LOGO! Base Module or an analog input module adjacent to the LOGO! Base Module).

2.1 Modular LOGO! setup

You install the LOGO! TDE module separately and connect it to the LOGO! Base Module with the Ethernet interface.

2.1.3 Setup with different voltage classes

Rules

You can only connect digital modules to devices of the same voltage class.

You can connect analog and communications modules to devices of any voltage class.

You can replace two similar DM8 expansion modules by one appropriate DM16 expansion module (and vice versa) without having to change the circuit program.

**Note**

You can only replace two DM8 12/24R modules with one DM16 24R module if the power supply is 24 VDC.

You can only replace two DM8 24R modules with one DM16 24R module if they use DC and positive-voltage input.

Overview: Connecting an expansion module to the LOGO! Base Module

In the following tables, "X" means that the connection is possible; "-" means that the connection is not possible.

LOGO! Base Module	Expansion modules				
	DM8 12/24R, DM16 24R	DM8 24, DM16 24	DM 8 24R	DM8 230R, DM16 230R	AM2, AM2 RTD, AM2 AQ
LOGO! 12/24RCE	x	x	x	-	x
LOGO! 230RCE	-	-	-	x	x
LOGO! 24CE	x	x	x	-	x
LOGO! 24RCE	x	x	x	-	x
LOGO! 12/24RCEo	x	x	x	-	x
LOGO! 24CEo	x	x	x	-	x
LOGO! 24RCEo	x	x	x	-	x
LOGO! 230RCEo	-	-	-	x	x



## Overview: Connecting an additional expansion module to an expansion module

Expansion module	Additional expansion modules				
	DM8 12/24R, DM16 24R	DM8 24, DM16 24	DM8 24R	DM8 230R, DM16 230R	AM2, AM2 RTD, AM2 AQ
DM8 12/24R, DM16 24R	x	x	x	-	x
DM8 24, DM16 24	x	x	x	-	x
DM8 24 R	x	x	x	-	x
DM8 230R, DM16 230R	-	-	-	x	x
AM2, AM2 RTD, AM2 AQ	x	x	x	-	x

### 2.1.4 Compatibility

#### The compatibility of modules

You can only use the LOGO! TDE module with equipment LOGO! 8 series. The LOGO! TDE is compatible with LOGO! 8.

#### Note

Siemens recommend you use LOGO! TDE 6ED1055-4MH0 8-0BA1 when you connect LOGO! BM 6ED1052-xxx08-0BA1 or later version. Some of the new features may not be available when you use older version of TDE connecting to the newer version of BM.

The LOGO! TDE module provides two Ethernet ports for network connection and six-line text display specifically for the LOGO! 8 device.

All expansion modules (with the order number of 6ED1055-1XXXX-0BA2) are completely compatible with the Base Modules of LOGO! 8 series and you can only use them with equipment of LOGO!8 series.

The devices of LOGO! 8 series supports micro SD cards.

#### The compatibility of message texts

You cannot edit message texts from the LOGO! Base Module that contain any of the following parameters:

- Par
- Time
- Date
- EnTime

- EnDate
- Analog input
- Digital I/O status
- Special characters (for example: ±, €)

You can only edit such message texts from LOGO!Soft Comfort.

### The compatibility of circuit diagram

The table below shows the detailed compatibility information for different device modules and circuit diagrams.

Order number and FS number	Circuit Diagram hardware type			
	LOGO! 8 (OBA8.Standard)	LOGO! 8.1 & 8.2 (LOGO! 8.FS4)	LOGO! 8.3	LOGO! 8.4
6ED1052-xxxxx-OBA8 FS01-FS03	Yes	No	No	No
6ED1052-xxxxx-OBA8 FS04-FS06	Yes	Yes	No	No
6ED1052-XXX08-OBA0	Yes	Yes	No	No
6ED1052-XXX08-OBA1	Yes	Yes	Yes	No
6ED1052-XXX08-OBA2	Yes	Yes	Yes	Yes

## 2.2 Installing/removing LOGO!

### Dimensions

The LOGO! installation dimensions are compliant with DIN 43880.

LOGO! can be snap-mounted to 35 mm DIN rails according to EN 60715 or mounted on the wall with two M4 screws.

LOGO! width:

- LOGO! TDE has a width of 128.2 mm.
- LOGO! OBA8 Base Modules have a width of 71.5 mm.
- LOGO! expansion modules have a width of 35.5 mm (DM8...) or 71.5 mm (DM16...).

#### Note

The figures above show you an example of the installation and removal of a LOGO! 12/24RCE and a digital module. The measures shown apply to all other LOGO! Base Module versions and expansion modules.

 <b>WARNING</b>
<p><b>Hazardous Voltage</b></p> <p>Hazardous electrical voltage can cause electric shock, burns and property damage.</p> <p>Disconnect your system and devices from the power supply before starting any assembly tasks.</p>

### Mounting positions

LOGO! modules support vertical and horizontal mounting position. When planning your layout for LOGO! modules, allow enough clearance for the wiring and communication cable connections.

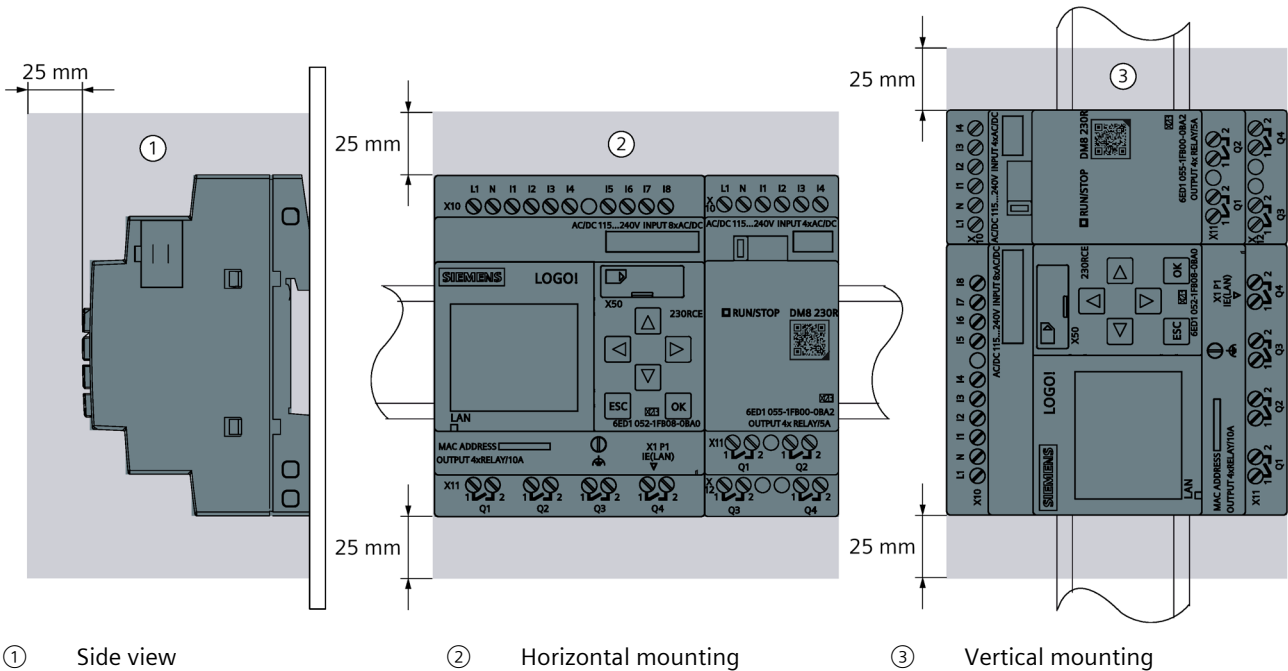

For proper cooling, you must provide a clearance of at least 25 mm above and below the mounting devices. Also, allow at least 25 mm of space between the front of modules and the inside of the enclosure.

## 2.2.1 DIN rail mounting

### Mounting

To mount a LOGO! Base Module and a digital module onto a DIN rail, follow these steps:

1. Hook the LOGO! Base Module onto the rail.
2. Push down the lower end to snap it on. The mounting interlock at the rear must engage.

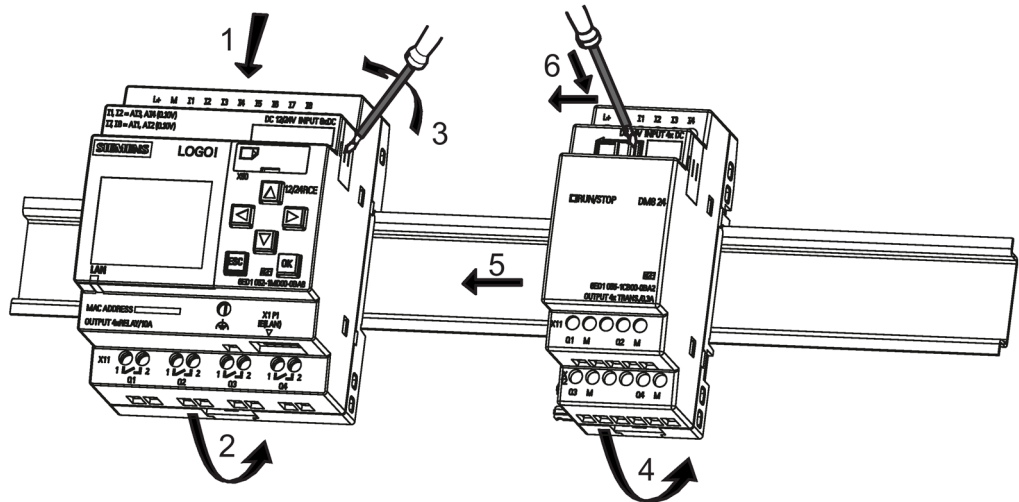

3. On the right side of the LOGO! Base Module/LOGO! expansion module, remove the connector cap.
4. Place the digital module onto the DIN rail on the right-hand side of the LOGO! Base Module.
5. Slide the digital module towards the left until it contacts the LOGO! Base Module.
6. Using a screwdriver, push the interlock to the left. In its end position the slide interlock engages in the LOGO! Base Module.

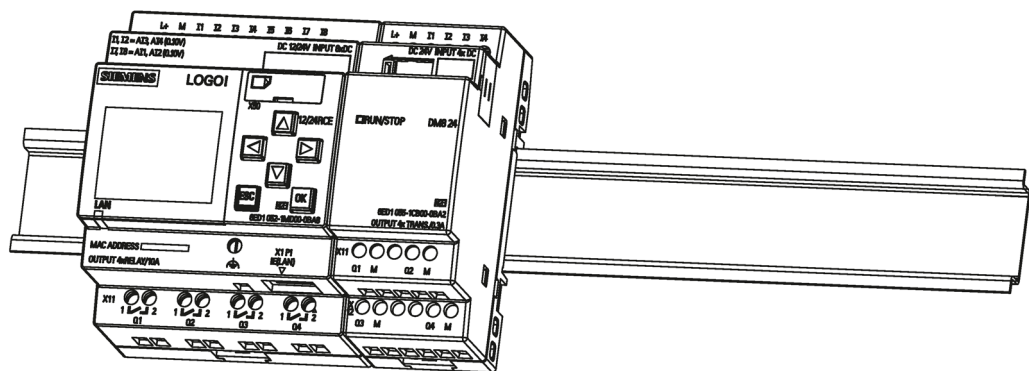

Repeat the digital module steps to mount further expansion modules.

#### Note

Be sure to cover the expansion interface on the last expansion module.

## Removal

To remove LOGO! if you have installed only one LOGO! Base Module, follow these steps:

1. Insert a screwdriver into the eyelet at the bottom of the slide interlock and move the latch downward.
2. Swing the LOGO! Base Module off the DIN rail.

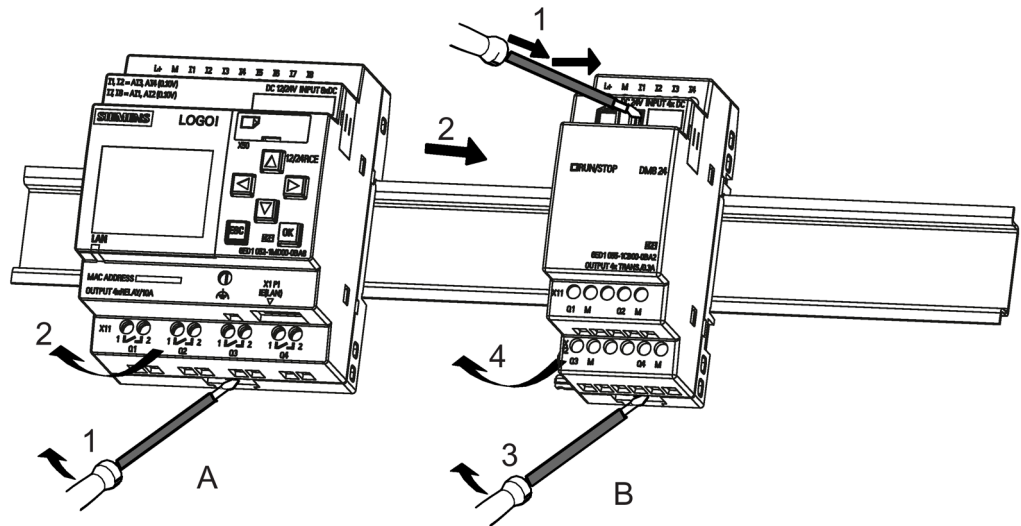

To remove LOGO! if you have connected at least one expansion module to the LOGO! Base Module, follow these steps:

1. Using a screwdriver, push the integrated slide interlock to the right.
2. Slide the expansion module off towards the right.
3. Insert a screwdriver into the eyelet at the bottom of the slide interlock and lever it downward.
4. Swing the expansion module off the profile rail.

Repeat steps 1 to 4 for all other expansion modules.

---

### Note

When removing modules, be sure to disengage the slide interlock of the module that connects it to the next module. When removing multiple modules, it is easier to start with the last module on the right side.

---

### 2.2.2 Wall-mounting

Follow the instructions below to wall-mount LOGO! by means of two mounting slides and two M4 screws (tightening torque 0.8 Nm to 1.2 Nm).

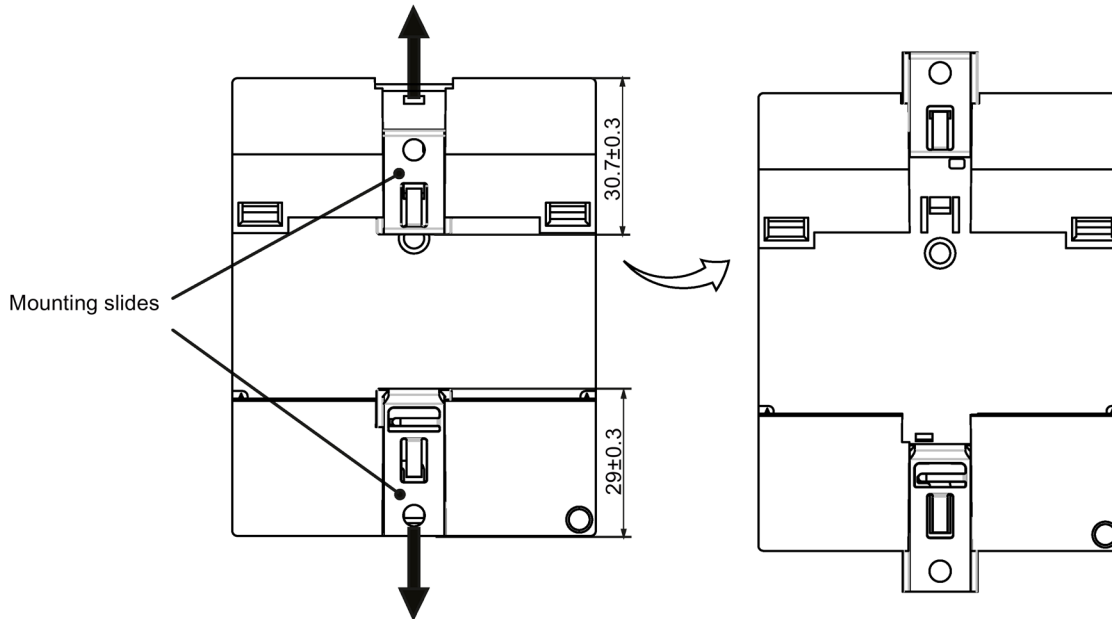

#### Note

When you do not wall-mount LOGO!, always keep the mounting slides in the factory default positions, that is, within the data area given in the illustration above; otherwise, the mounting slides may deform if they are exposed to hot and humid surroundings for a long term.

### Drilling template for wall-mounting

Before you can wall-mount LOGO!, you need to drill holes using the template shown below:

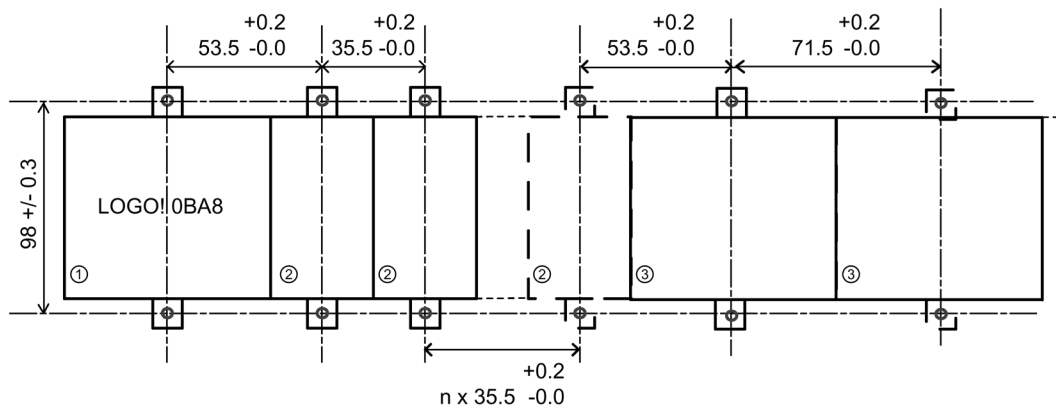

All dimensions in mm

Bore hole for M4 screw, tightening torque 0.8 Nm to 1.2 Nm

- ① LOGO! Base Module
- ② LOGO! expansion modules, DM8 ..., AM...
- ③ LOGO! expansion modules, DM16 ...

### 2.2.3 Mounting the LOGO! TDE

---

#### Note

Make sure you mount the LOGO! TDE vertically on a flat surface of an IP 65 or Type 4X/12 enclosure.

---

To prepare the mounting surface for the optional LOGO! TDE and mount it, follow these steps:

1. Cut a 119 mm × 78.5 mm (tolerance: +0.5 mm) hole in the mounting surface.

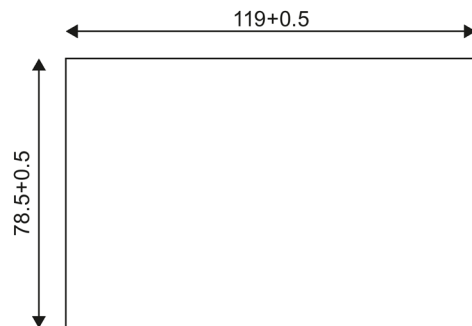

2. Place the included gasket on the front plate of the LOGO! TDE.
3. Fit the LOGO! TDE into the cutout you made in the mounting surface.
4. Attach the mounting brackets (included) to the LOGO! TDE.
5. Tighten the mounting screws on the mounting brackets to 0.2 Nm torque to secure the LOGO! TDE.

2.3 Wiring LOGO!

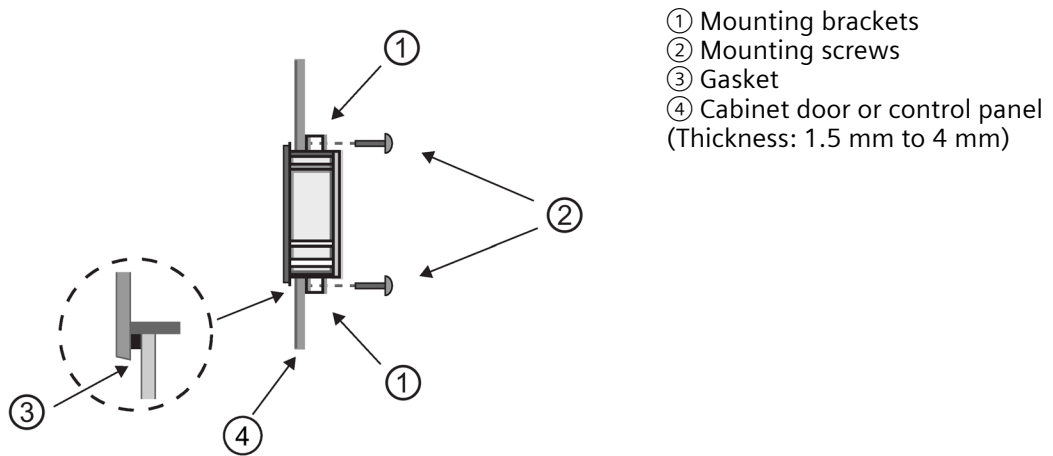

You can then connect the LOGO! TDE to the LOGO! Base Module through the Ethernet interface.

2.2.4 Labeling LOGO!

The rectangular areas on the LOGO! modules are intended for labeling.

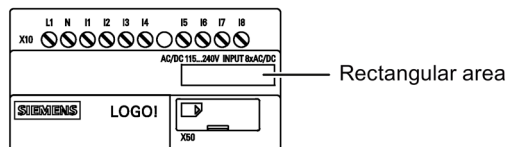

In the case of expansion modules, you can use the rectangular areas for labeling the inputs and outputs, for example. In this connection, you can enter a delta factor of +8 for the inputs or +4 for the outputs if the LOGO! Base Module already has 8 inputs or 4 outputs.

2.3 Wiring LOGO!

Wire LOGO! using a screwdriver with a 3 mm blade.

You do not need to wire ferrules for the terminals. You can use conductors fulfilled the following requirements:

- Cross-sections of up to the following thicknesses:
  - 1 × 2.5 mm<sup>2</sup>
  - 2 × 1.5 mm<sup>2</sup> for each second terminal chamber
- Conductor material: Cu
- Insulation temperature rating: 75 °C
- Tightening torque: 0.8 Nm or 7 in.lbf



**Note**

Always cover the terminals after you have completed the installation. To protect LOGO! adequately from impermissible contact to live parts, comply with local standards.

**⚠ CAUTION****Use copper cables at connectors with terminal connections**

Use copper (Cu) cables for all supply lines that are connected to the device with terminals, e.g. 24/240 VDC power supply cables to the 24/240 VDC power supply connectors.

**Utiliser des câbles en cuivre sur les connexions à bornes**

Utilisez des câbles en cuivre (Cu) pour tous les câbles d'alimentation qui sont raccordés à l'appareil par des bornes, par exemple les câbles d'alimentation 24/240 VCC sur le connecteur d'alimentation 24/240 VCC.

**2.3.1****Connecting the power supply**

The 230 V versions of LOGO! are suitable for operation with rated voltages of 115 VAC/VDC and 240 VAC/VDC. The LOGO! 24 V and 12 V versions can be operated with a 24 VDC, 24 VAC or 12 VDC power supply. For information on permissible voltage tolerances, line frequencies and power consumption, refer to the installation instructions in the Product Information supplied with your device and to the technical data in Appendix A.

The LOGO! TDE must be supplied with a voltage of 12 VDC or 24 VAC/VDC.

**⚠ CAUTION**

Expansion modules DM8 230R and DM16 230R must be operated with the same type of power supply (DC or AC) as for the connected 230 V version of the LOGO! Base Module. The same supply output "+/-" on DC power supplies or "N/L" on AC power supplies must connect to the same phase on both the expansion module DM8/16 230R and the connected LOGO! 230 .... Failure to follow the instructions could result in personal injury.

**Note**

A power failure might cause an additional edge triggering signal at the special functions. The stored data will be from the last uninterrupted cycle.

### Connecting LOGO!

Connect LOGO! to the power supply as shown below, depending on whether your power supply is DC or AC:

LOGO! ... with DC power supply

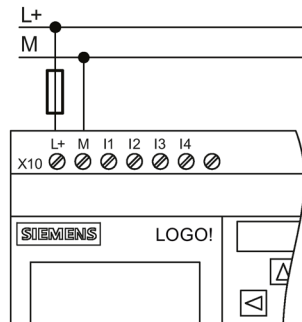

Protection with safety fuse  
if required (recommended) for:  
12/24 RC...: 0.8 A  
24: 2.0 A

LOGO! ... with AC power supply

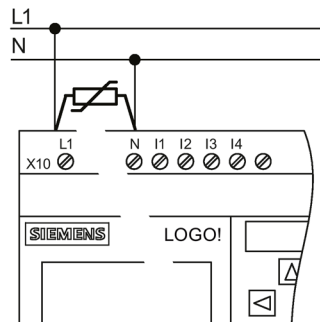

To suppress surge voltages, install  
varistors (MOV) with an operating  
voltage at least 20% above the rated  
voltage.

---

#### Note

LOGO! is a double-insulated switchgear. You must connect its FE terminal to earth ground.

---

#### Circuit protection with AC voltage

To suppress voltage peaks on the power supply lines, you can install a metal oxide varistor (MOV). Make sure the operating voltage of the varistor (MOV) used lies at least 20% above the rated voltage (for example S10K275).

#### Circuit protection with DC voltage

To suppress voltage peaks on the power supply lines, install a protection device, for example DEHN (order number BVT AVD 24).

### 2.3.2 Connecting the LOGO! TDE power supply

You must connect the LOGO! TDE to an external power supply that supplies a voltage of 12 VDC or 24 VAC/VDC. The LOGO! TDE includes a power connector. Connect the power supply to the power connector then plug the power connector to the power supply interface on LOGO! TDE.

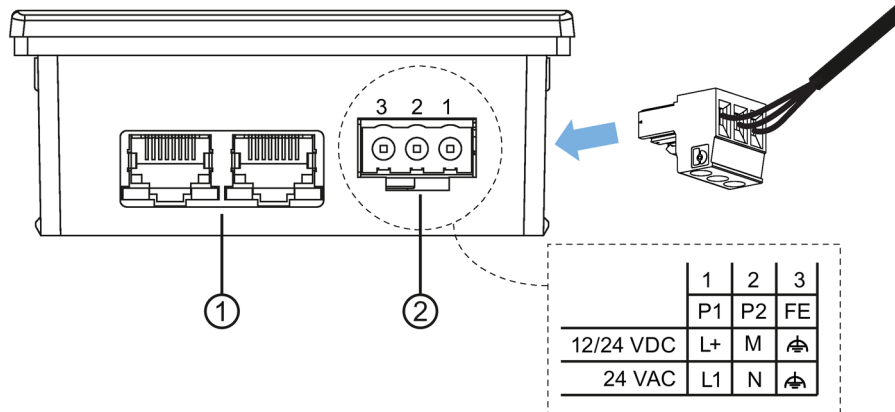

① Ethernet interfaces

② Power supply

- The power connection is non-polar. If you connect a DC power supply to the LOGO! TDE, you can connect the positive supply wire or negative supply wire to either pin 1 or pin 2.
- Pin 3 must be connected to the ground.

#### Note

Siemens recommends that you protect the LOGO! TDE with a 0.5 A safety fuse on the power supply.

### 2.3.3 Connecting LOGO! inputs

#### Requirements

At the inputs you connect sensor elements such as: momentary pushbuttons, switches, light barriers, daylight control switches etc.

**Sensor characteristics for LOGO!**

	LOGO! 12/24RCE		LOGO! 24CE		LOGO! DM8	LOGO! DM8
	LOGO! 12/24RCEo		LOGO! 24CEo		12/24R	24
	I3 ... I6	I1,I2,I7,I8	I3 ... I6	I1,I2,I7,I8	I1 ... I8	I1 ... I8
<b>Signal status 0</b>	< 5 VDC	< 5 VDC	< 5 VDC	< 5 VDC	< 5 VDC	< 5 VDC
Input current	< 0.85 mA	< 0.05 mA	< 0.85 mA	< 0.05 mA	< 0.85 mA	< 0.85 mA
<b>Signal status 1</b>	> 8.5 VDC	> 8.5 VDC	> 12 VDC	> 12 VDC	> 8.5 VDC	> 12 VDC
Input current	> 1.5 mA	> 0.1 mA	> 2 mA	> 0.15 mA	> 1.5 mA	> 2 mA

	LOGO! 24RCE (AC)	LOGO! 24RCE (DC)	LOGO! 230RCE (AC)	LOGO! 230RCE (DC)
	LOGO! 24RCEo (AC)	LOGO! 24RCEo (DC)	LOGO! 230RCEo (AC)	LOGO! 230RCEo (DC)
	LOGO! DM8 24R (AC)	LOGO! DM8 24R (DC)	LOGO! DM8 230R (AC)	LOGO! DM8 230R (DC)
<b>Signal status 0</b>	< 5 VAC	< 5 VDC	< 40 VAC	< 30 VDC
Input current	< 1.0 mA	< 1.0 mA	< 0.03 mA	< 0.03 mA
<b>Signal status 1</b>	> 12 VAC	> 12 VDC	> 79 VAC	> 79 VDC
Input current	> 2.5 mA	> 2.5 mA	> 0.08 mA	> 0.08 mA

	LOGO! DM16 24R	LOGO! DM16 24	LOGO! DM16 230R (AC)	LOGO! DM16 230R (DC)	
	<b>Signal status 0</b>	< 5 VDC	< 5 VDC	< 40 VAC	< 30 VDC
	Input current	< 1.0 mA	< 1.0 mA	< 0.05 mA	< 0.05 mA
<b>Signal status 1</b>	> 12 VDC	> 12 VDC	> 79 VAC	> 79 VDC	
Input current	> 2.0 mA	> 2.0 mA	> 0.08 mA	> 0.08 mA	

**Note**

LOGO! 230RCE/230RCEo and expansion module DM16 230R each contains two groups of four inputs, for a total of eight. Within each group, you must operate all inputs on the same phase. Different phases are only possible between the groups.

Example: I1 to I4 on phase L1, I5 to I8 on phase L2.

You must not connect the inputs of the LOGO! DM8 230R to different phases.

**Sensor connections**

**Connecting glow lamps and two-wire proximity switches (Bero) to LOGO! 230RCE/230RCEo or LOGO! DM8 230R (AC) and LOGO! DM16 230R (AC)**

The figure below shows how you connect a switch with a glow lamp to LOGO!. The current that flows through the glow lamp allows LOGO! to detect a "1" signal even though the switch contact is not closed. If, however you use a switch that has the glow lamp fitted with a power supply, this response does not occur.

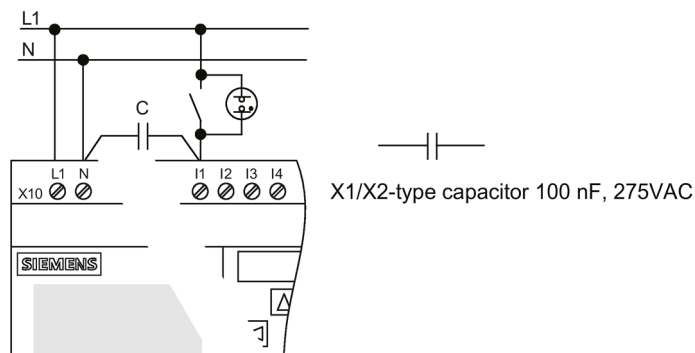

Take into account the quiescent current of any two-wire proximity switches that you use. The level of the quiescent current of some two-wire proximity switches is high enough to trigger a logical "1" signal at the LOGO! input. You should therefore compare the quiescent current of the proximity switches with the technical data of inputs (Page 341).

### Remedy

To suppress this response, use an X1/X2-type capacitor rated at 100 nF and 275 VAC. In a destructive situation, this type of capacitor safely disconnects. You must choose the voltage level for which the capacitor is rated such that it is not destroyed in the case of overvoltage!

At 230 VAC, the voltage between N and an input I(n) must not be greater than 40 V to guarantee a "0" signal. You can connect approximately ten glow lamps to the capacitor.

## Restrictions

### Signal status transitions 0 → 1/1 → 0

After a 0 to 1 or 1 to 0 transition, the signal must remain constant at the input at least for the duration of one program cycle, so that LOGO! can detect the new signal status.

The size of the circuit program determines the program execution time. The appendix "Determining the cycle time (Page 363)" contains a benchmark test routine that you can use to determine the current scan cycle time.

## Special features of LOGO! 12/24RCE/RCEo and LOGO! 24CE/24CEo

### Fast digital inputs: I3, I4, I5 and I6

These modules include fast digital inputs (up/down counters, threshold triggers). The restrictions mentioned earlier do not apply to these fast digital inputs.

---

### Note

Expansion modules do not have fast digital inputs.

---

### Analog inputs: I1 and I2, I7 and I8

You can use the inputs I1, I2, I7 and I8 of LOGO! versions 12/24RCE/RCEo and 24CE/24CEo as either digital inputs or analog inputs. The LOGO! circuit program defines the input mode (digital or analog).

### 2.3 Wiring LOGO!

The inputs I1, I2, I7 and I8 provide digital inputs, and the inputs AI3, AI4, AI1 and AI2 provide analog inputs, as described in the topic "Constants and connectors (Page 130)". AI3 corresponds to the input terminal I1; AI4 corresponds to I2; AI1 corresponds to I7; AI2 corresponds to I8. The use of AI3 and AI4 is optional. You configure your LOGO! to use either two or four analog inputs as the topic "Setting the number of AIs in LOGO! (Page 298)" describes.

When using inputs I1, I2, I7 and I8 as analog inputs, only the range from 0 to 10 VDC is available.

#### Connecting a potentiometer to inputs I1, I2, I7 and I8

To allow you to achieve 10 V as the maximum value when you completely turn the potentiometer once, you must connect a series resistor on the potentiometer's input side regardless of the input voltage (see figure below).

We suggest the following sizes of potentiometers and associated series resistors:

Voltage	Potentiometer	Series Resistor
12 V	5 k $\Omega$	-
24 V	5 k $\Omega$	6.6 k $\Omega$

When using a potentiometer and 10 V input voltage as the maximum value, you must ensure that with a connected input voltage of 24 V, 14 V must release via the series resistor to ensure a maximum supply of 10 V when you turn the potentiometer one full rotation. With a voltage of 12 V, you can neglect this.

---

#### Note

The LOGO! AM2 expansion module provides additional analog inputs. The LOGO! AM2 RTD expansion module provides PT100/PT1000 inputs.

Always use twisted and shielded cables for analog signals, and keep these as short as possible.

---

### Sensor connections

Connect sensors to LOGO! as shown below.

LOGO! 12/24.... and LOGO! 24...

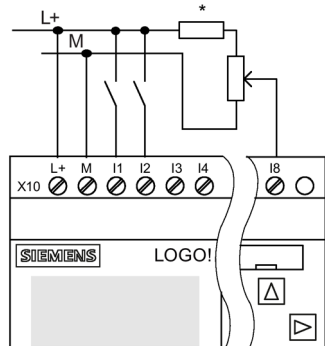

The inputs of these devices are not isolated and therefore require a common reference potential (chassis ground).

With LOGO! 12/24RCE/RCEo and LOGO! 24CE/24CEo modules, you can tap analog signals between the supply voltage and chassis ground (\* = series resistor (6.6 kΩ) at 24 VDC).

Connection example

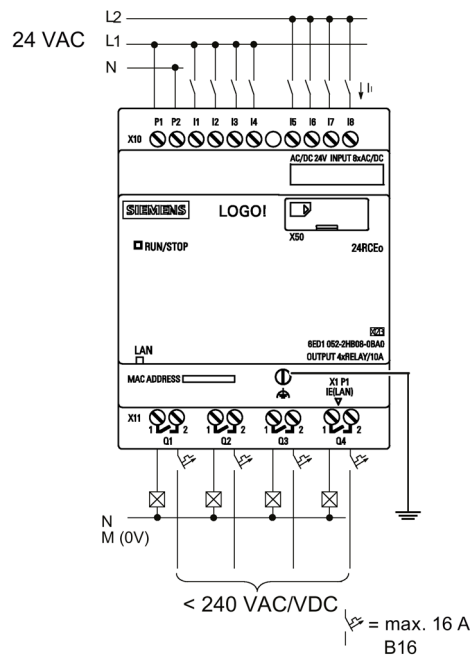

LOGO! 230....

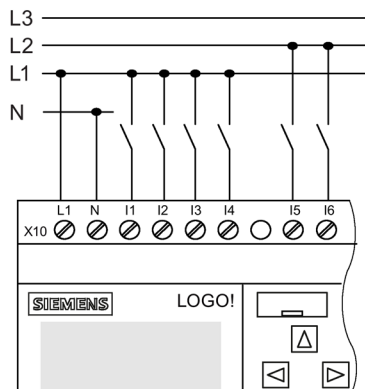

The inputs of these devices are in two groups, each consisting of four inputs. Different phases are only possible between blocks, but not within the blocks.

Connection example

Two-phase connection of the Base Module

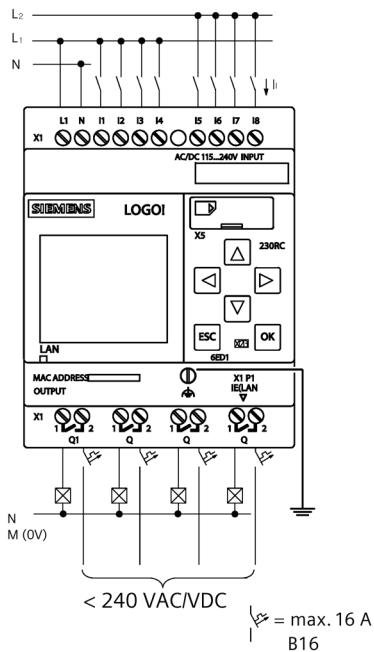

Three-phase connection of the Base Module with an expansion module

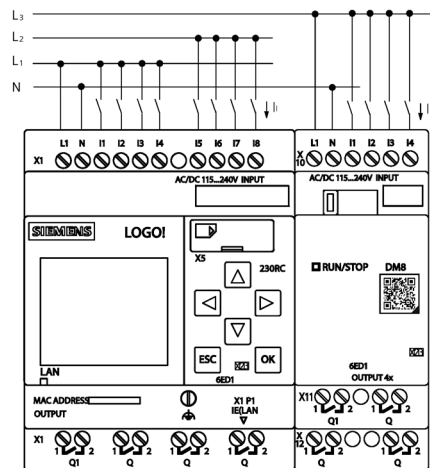

**⚠ WARNING**

Current safety regulations (VDE 0110, ... and IEC 61131-2, ... as well as cULus) do not permit the connection of different phases to an AC input group (I1 to I4 or I5 to I8) or to the inputs of a digital module.



## LOGO! AM2

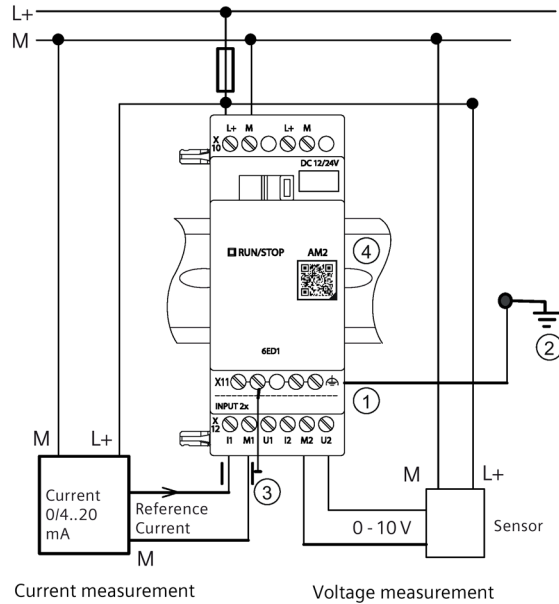

- ① FE terminal for connecting earth and shielding the analog measuring cable      ③ Cable shielding  
 ② Earth      ④ Standard DIN rail

The illustration above shows an example of four-wire current measurement and two-wire voltage measurement.

### Connecting a two-wire sensor to the LOGO! AM2

Wire up the two-wire sensor's connecting wires as follows:

1. Connect the sensor's output to connection U (0 V to 10 V voltage measurement) or to connection I (0/4 mA to 20 mA current measurement) of the AM2 module.
2. Connect the plus connector on the sensor to the 24 V supply voltage (L+).
3. Connect the ground connection of the current output M (on the right side of the sensor, as shown in the figure above) to the corresponding M input (M1 or M2) on the AM2 module.

### LOGO! AM2 RTD

You can connect a maximum of two PT100 sensors or two PT1000 or one PT100 plus one PT1000 sensor in a two-wire or three-wire connection or in a mixed use of two-wire and three-wire connection to the module. Note that the sensor type supported by the module is only PT100 or PT1000 with the default temperature coefficient of  $\alpha = 0.003850$ .

For a two-wire connection, you need to short-circuit terminals U1- and IC1 or U2- and IC2. Errors caused by the ohmic resistance of the measuring line are not compensated for this type of connection. If a PT100 sensor is connected, a line resistance of  $1 \Omega$  is proportional to measuring error of  $+2.5 \text{ }^\circ\text{C}$ ; if a PT1000 sensor is connected, a line resistance of  $1 \Omega$  is proportional to measuring error of  $+0.25 \text{ }^\circ\text{C}$ .

A three-wire technique suppresses the influence of the cable length (ohmic resistance) on the result of the measurement.

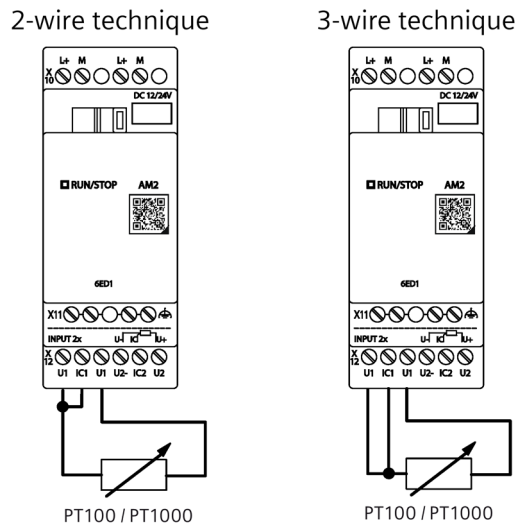

**Note**

Fluctuating analog values can occur if you do not mount/correctly mount the screening on the connecting wire from the analog valuator device to the analog AM2 / AM2 RTD LOGO! expansion module (encoder wire).

To avoid fluctuating analog values when using these expansion modules, take the following measures:

- Use only shielded encoder wires.
- Shorten the encoder wire as much as possible. The encoder wire must not be more than 10 meters long.
- Clamp the encoder wire on one side only and clamp it only to the FE terminal on the AM2/AM2 AQ/AM2 RTD expansion module.
- Connect ground on the encoder supply to the FE terminal on the expansion module.
- Avoid operating the LOGO! AM2 RTD expansion module with a power supply that is not grounded (potential-free). If you cannot avoid this, connect the negative output/ground output on the power supply to the shielding on the resistance thermometer's measuring wires.

**2.3.4 Connecting outputs**

**LOGO! ...R...**

The LOGO! ...R... version includes relay outputs. The potential of the relay contacts is isolated from the power supply and the inputs.

## Requirements for relay outputs

You can connect various loads to the outputs; for example lamps, fluorescent lamps, motors, contactor relays and so on. For information on the properties required for the loads connected to LOGO! ...R..., refer to the technical data (Page 341).

### NOTICE

#### LOGO! Relay contacts may be damaged by a high inrush current.

When low energy lamps or LED Lamps are controlled by LOGO! relay outputs, the energy lamps and/or LED lamps may have a very high inrush current. If the inrush current is not limited, the LOGO! relay contacts may be damaged after some switch cycles.

Use an inrush current limiter to protect the relay contacts.

## Connecting

Connect the load to LOGO! ...R... as shown below:

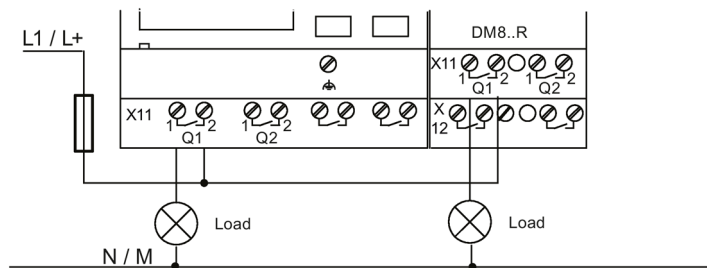

Protection with automatic circuit-breaker, max. 16 A, characteristics B16, e. g. : Power circuit-breaker 5SX2 116-6 (if required)

## LOGO! with solid-state outputs

You can identify LOGO! versions with solid-state outputs by the fact that the letter **R** is missing from their type name. The outputs are short circuit-proof and overload-proof. An auxiliary load voltage supply is not necessary, because LOGO! supplies the load voltage.

## Requirements for solid-state outputs

The load connected to LOGO! must have the following characteristics:

- The maximum switched current is 0.3 A per output.

### Connecting

Connect the load to a LOGO! with solid-state outputs as shown below:

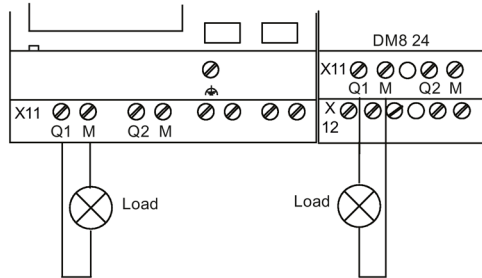

Load: 24 VDC, 0.3 A max.

### LOGO! AM2 AQ

The illustration below shows an example of how to connect the voltage or current load.

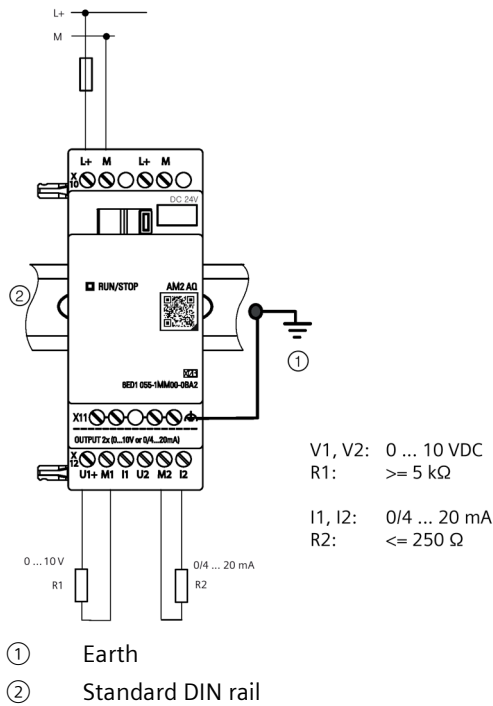

### 2.3.5 Connecting the Ethernet interface

#### LOGO! ...E

The LOGO! ...E version is equipped with a 10/100 Mbit/s Ethernet RJ45 interface.

#### Requirements for the network cable

Use a shielded Ethernet cable to connect to the Ethernet interface. To minimize electromagnetic interference, make sure you use a standard Category 5 shielded twisted-pair Ethernet cable with a shielded RJ45 connector on each end.

#### Connecting

You connect the FE terminal to earth ground, and connect a network cable to the Ethernet interface.

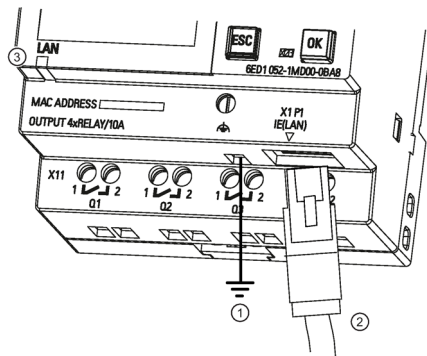

- ① Earth ground
- ② Ethernet cable, for connecting to the Ethernet interface
- ③ Ethernet status LED

#### Ethernet status LED

LED type	Color	Description
Status LED	Flashing orange	LOGO! is receiving/sending data across Ethernet.
	Steady green	LOGO! is already connected to Ethernet.

## 2.4 Putting into operation

### 2.4.1 Powering on LOGO!

LOGO! does not have a power switch. The reaction of LOGO! during startup depends on the following:

- Whether a circuit program is stored in LOGO!
- Whether a micro SD card is inserted
- Whether this is a LOGO! version without display unit (LOGO!...o)
- Whether LOGO! is in RUN mode or STOP mode at the time of power failure

To ensure that the expansion module on LOGO! changes to RUN mode, check the following:

- Has the sliding contact between LOGO! and the expansion module snapped into place properly?
- Is the power supply connected to the expansion module?
- In addition, always ensure that you switch on the power supply to the expansion module first before activating the power supply to the LOGO! Base Module (or activate both power supplies at the same time); if you do not do this, the system does not detect the expansion module when you start up the LOGO! Base Module.

The following illustration shows all possible reactions of LOGO!:

Before power-off

After power-on

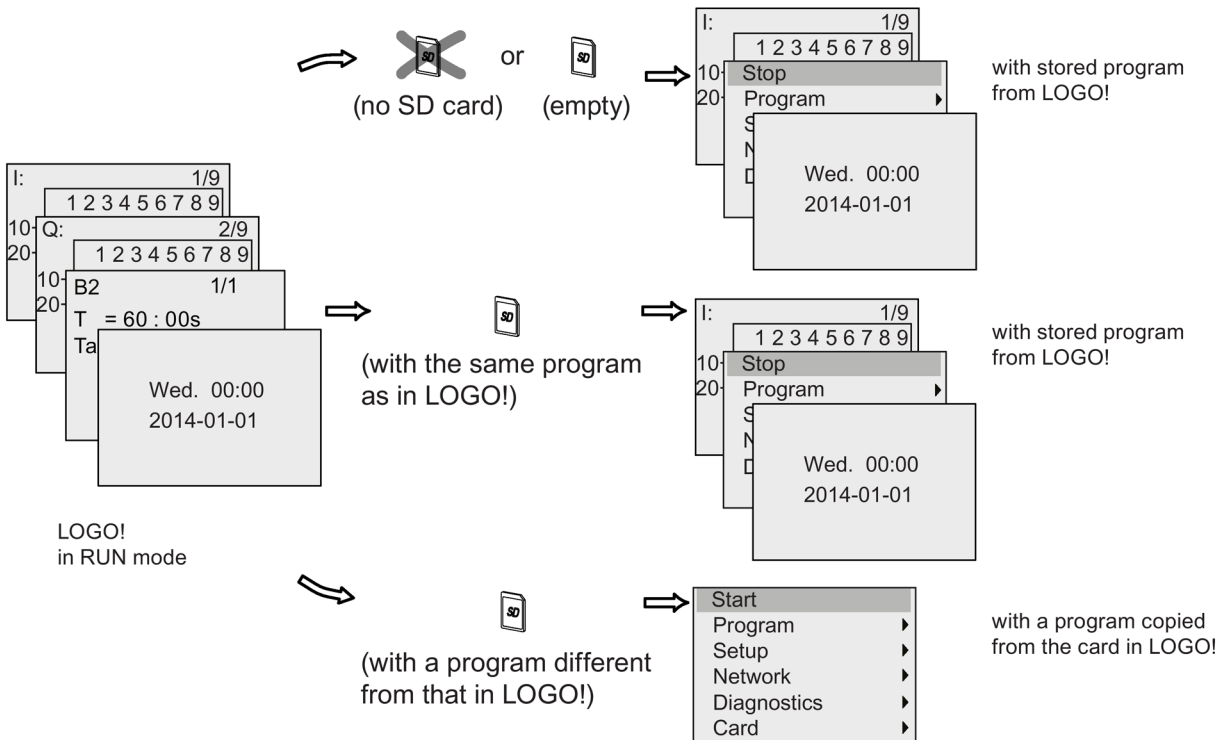
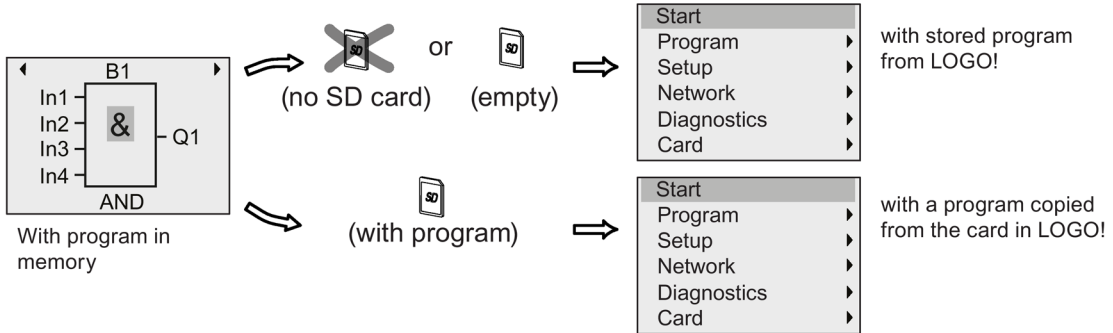
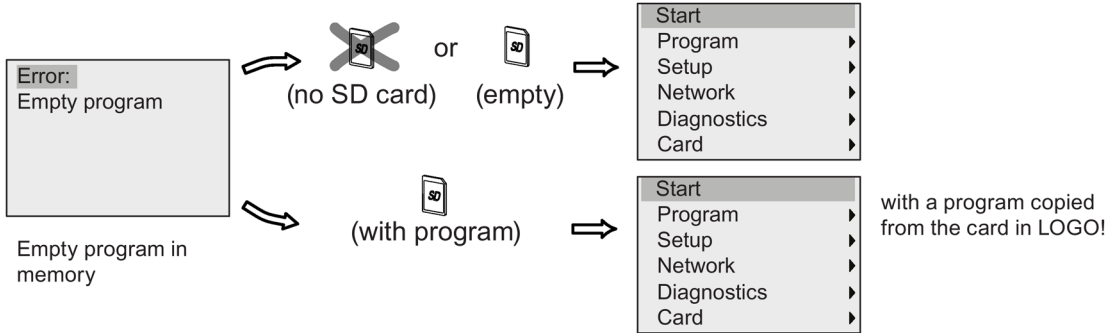

You can also memorize four simple rules for starting LOGO! :

1. If neither LOGO! nor the inserted card contains a circuit program, the LOGO! Basic displays the following:

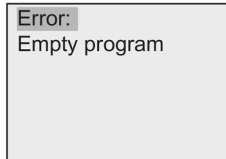

2. LOGO! automatically copies the circuit program on the card to memory and overwrites the existing circuit program.
3. If there is a circuit program in LOGO! or on the card, LOGO! adopts the operational state it had prior to power-off. Versions without a display unit (LOGO!...o) automatically change from STOP to RUN (LED changes from red to green).
4. If you have enabled retentivity for at least one function, or a function is permanently retentive, LOGO! retains the current values at power-off.

---

**Note**

When a power failure occurs while you are entering a circuit program, the program in LOGO! is missing after power is returned.

Before you modify the circuit program, save a backup copy of your original to a card or to a computer using LOGO!Soft Comfort.

---



## 2.4.2 Operating states

### LOGO! Base Module operating states

LOGO! Base Modules (LOGO! Basic or LOGO! Pure) have two operating states: STOP and RUN.

STOP	RUN
<ul style="list-style-type: none"> <li>The display shows that the program is empty when you start the program (except for LOGO!...o devices)</li> <li>Switching LOGO! to programming mode (except for LOGO!...o devices)</li> <li>LED is red (only for LOGO!...o devices)</li> </ul>	<ul style="list-style-type: none"> <li>Display: Screen mask for monitoring I/O and messages (after START in the main menu) or for the parameter assignment menu (except for LOGO!...o devices)</li> <li>Switching LOGO! to parameter assignment mode (except for LOGO!...o devices)</li> <li>LED is green (only for LOGO!...o devices)</li> </ul>
Action of LOGO!: <ul style="list-style-type: none"> <li>The input data is not read.</li> <li>The circuit program is not executed.</li> <li>The relay contacts are permanently open or the solid-state outputs are switched off.</li> </ul>	Action of LOGO!: <ul style="list-style-type: none"> <li>LOGO! reads the status of the inputs.</li> <li>LOGO! uses the circuit program to calculate the status of the outputs.</li> <li>LOGO! switches the relay/solid-state outputs on or off.</li> </ul>

#### Note

After switching the power on, the system briefly switches through the outputs on the LOGO! 24CE/24CEo. With an open circuit, a voltage of > 8 V can occur for up to approximately 100 ms; when the circuit is loaded, this time reduces to a matter of microseconds.

### LOGO! expansion modules, operating states

LOGO! expansion modules have three operating states. The color of the LED (RUN/STOP) indicates one of three operating states for LOGO! expansion modules.

Green (RUN)	Red (STOP)	Orange/Yellow
The expansion module communicates with the device to the left.	The expansion module does <b>not</b> communicate with the device to its left.	Initialization phase of the expansion module

# Programming LOGO!

## Getting started with LOGO!

Programming refers to creating a circuit program from the LOGO! Base Module.

In this chapter you will learn how to use LOGO! to create the LOGO! circuit programs for your application.

LOGO!Soft Comfort is the LOGO! programming software that you can use on your PC to quickly and easily create, test, modify, save and print the circuit programs. The topics in this manual, however, relate only to the creation of circuit programs on the actual LOGO! Base Module. The programming software LOGO!Soft Comfort contains extensive online help.

---

### Note

LOGO! versions without a display unit, that is, the LOGO! 24CEo, LOGO! 12/24RCEo, LOGO! 24RCEo and LOGO! 230RCEo versions, do not have an operator panel and display unit. These devices are ideal for use in small machine and process equipment engineering systems for series production.

You do not program LOGO!...o versions directly on the device. Instead, you download a program to the device from LOGO!Soft Comfort or from memory cards with the program you created on another LOGO! device.

LOGO! versions without a display cannot write data to memory cards.

See Chapters "Using memory cards (Page 300)", "LOGO! software (Page 334)" and the Appendix "LOGO! without display ("LOGO! Pure") (Page 365)" for more information.

---

A small example in the first part of this chapter introduces the operating principles of LOGO!:

- You will learn the meaning of two basic terms, namely the **connector** and the **block**.
- As the next step, you will create a circuit program based on a simple conventional circuit.
- Lastly, you will enter this program directly in LOGO!

It will take you only a few pages of this manual to store your first executable circuit program in the LOGO! device. With suitable hardware (switches etc.), you will then be able to carry out initial tests.

### 3.1 Connectors

LOGO! is equipped with inputs and outputs

Example of a configuration with several modules:

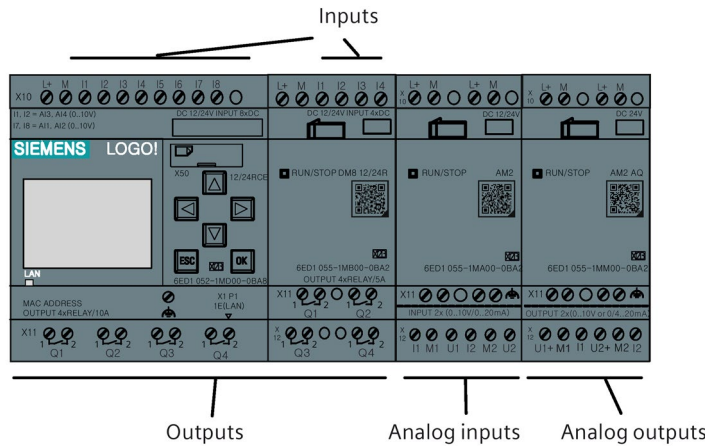

The illustration shows the conceptual usage of the inputs, not the actual physical markings on the module.

The letters I followed by numerals identify the inputs. When you look at LOGO! from the front, you can see the input terminals at the top. Only analog input modules LOGO! AM2 and AM2 RTD have the inputs at the bottom.

The letters Q followed by numerals (on AM2 AQ, AQ plus numeral) identify the outputs. In the figure, you can see the output terminals at the bottom.

---

**Note**

LOGO! can recognize, read and switch the I/O of all expansion modules regardless of their type. The I/O numbers follow the installation order of the modules.

For LOGO! 0BA8 series, the following I/O and flag blocks are available for creating your circuit program from LOGO!:

- I1 to I24, AI1 to AI8, Q1 to Q20, AQ1 to AQ8, M1 to M64, and AM1 to AM64
- 32 shift register bits S1.1 to S4.8
- 4 cursor keys C ▲, C ►, C ▼ and C ◀
- four function keys on the LOGO! TDE: F1, F2, F3, and F4
- 64 blank outputs X1 to X64

If you have previously configured any of the network digital or analog inputs/outputs NI1 to NI64, NAI1 to NAI32, NQ1 to NQ64, and NAQ1 to NAQ16 in your circuit program from LOGO!Soft Comfort, after downloading the circuit program to LOGO!, these network digital or analog inputs/outputs are available in the LOGO!; however, you can not edit the rest of the program from the LOGO!, except for the Par parameter.

See the "Constants and connectors (Page 130)" topic for more details.

The following applies to inputs I1, I2, I7 and I8 of LOGO! 12/24... and LOGO! 24CE/24CEo versions: If you use I1, I2, I7 or I8 in the circuit program, this input signal is digital. If you use AI3, AI4, AI1, or AI2, the input signal is analog. The numbering of the analog inputs is significant: AI1 and AI2 corresponded to I7 and I8. With the addition of two new analog inputs, these modules optionally use I1 for AI3 and I2 for AI4. See the graphical representation in the topic on "Maximum setup with expansion modules (Page 34)". Also note that you can also use I3, I4, I5, and I6 as fast digital inputs.

---

## LOGO!'s connectors

The term connector refers to all connections and states in LOGO! .

The digital I/O status can be '0' or '1'. Status '0' means that the input does not carry a specific voltage. Status '1' means that the input does carry a specific voltage.

The 'hi' and 'lo' connectors make it easier for you to create the circuit program. 'hi' (high) is assigned the status '1', and 'lo' (low) is assigned the status '0'.

You do not have to use all of the connectors of a block. The circuit program automatically assigns the unused connectors a status that ensures proper functioning of the relevant block.

For information on the meaning of the term "block", refer to the topic on "Blocks and block numbers (Page 65)".

LOGO! has the following connectors :

Connectors	 LOGO! 0BA8		DM	AM	AM2 AC
Inputs	LOGO! 23ORCE LOGO! 23ORCEo LOGO! 24RCE LOGO! 24RCEo	Two groups: I1 to I4 and I5 to I8	I9 to I24	A11 to A18	none
	LOGO! 12/24RCE LOGO! 12/24RCEo LOGO! 24CE LOGO! 24CEo	I1, I2, I3-I6, I7, I8 AI3, AI4 ... AI1, AI2	I9 to I24	A15 to A18	
Outputs	Q1 to Q4		Q5 to Q20	none	AQ1 to AQ8
lo	Logical '0' signals (off)				
hi	Logical '1' signals (on)				
Flags	Digital flags: M1 to M64 Analog flags: AM1 to AM64				
Shift register bits	S1.1 to S4.8				
Network inputs <sup>1)</sup>	NI1 to NI64				
Network analog inputs <sup>1)</sup>	NAI1 to NAI32				
Network outputs <sup>1)</sup>	NQ1 to NQ64				
Network analog outputs <sup>1)</sup>	NAQ1 to NAQ16				

**DM:** Digital Module

**AM:** Analog Module

<sup>1)</sup> To make these four connectors available in a LOGO! 0BA8, you must configure them in the circuit program with LOGO!Soft Comfort V8.1 or later version, and download the circuit program to the LOGO! 0BA8 device.

## 3.2 Blocks and block numbers

This chapter shows you how to use LOGO! elements to create complex circuits and how blocks and I/O are interconnected.

In the topic "From circuit diagram to LOGO! program (Page 68)" you will learn how to transform a conventional circuit into a LOGO! circuit program.

### Blocks

A block in LOGO! represents a function that is used to convert input information into output information. Previously you had to wire the individual elements in a control cabinet or terminal box. When you create the circuit program, you interconnect the blocks.

### Logic operations

The most elementary blocks are the logic operations:

- AND
- OR
- ...

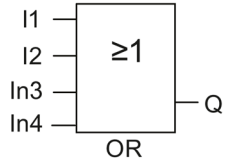

Inputs I1 and I2 connect to the OR block. The last two inputs of the block remain unused.

These special functions offer you significantly greater performance:

- Pulse relay
- Up/down counter
- On-delay
- Softkey
- ....

The chapter entitled "LOGO! functions (Page 130)" gives a full list of the LOGO! functions.

### Block representation on the LOGO! onboard display

The figure below shows a typical view of the LOGO! onboard display. As you can see, it can show only one block at a time. LOGO! shows the block number on the top of the display by default if you assign no name to this block. The block numbers help you check the circuit structure. Alternatively, you can also choose to display a customized block name instead of the block number. For more information about assigning a block name, refer to Section "Circuit program input (Page 79)".

#### View of the LOGO! display

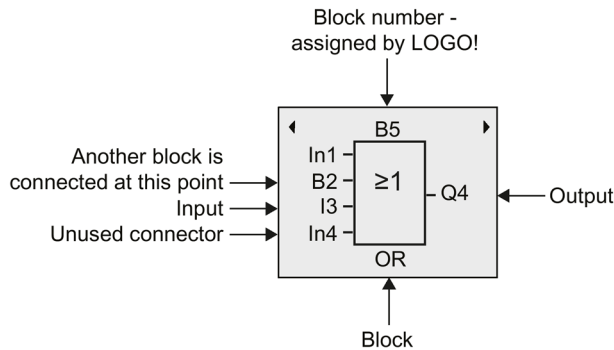

## Assigning a block number

LOGO! automatically assigns each new block in a circuit program a block number. LOGO! uses these block numbers to indicate the block interconnections. This means that these numbers are mainly an aid to your orientation in the circuit program.

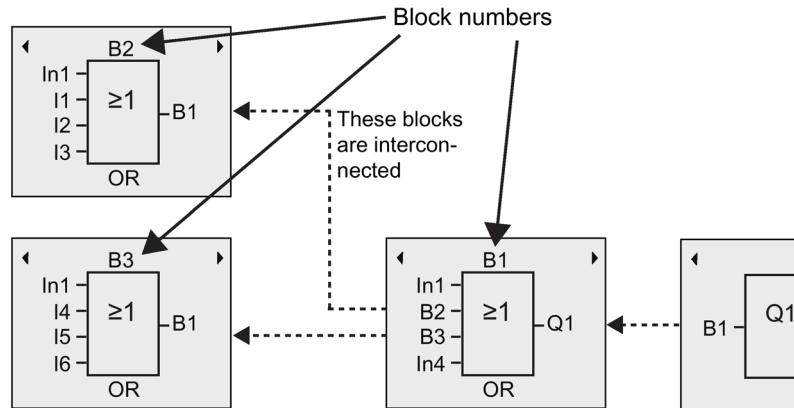

The figure above shows you three views of the LOGO! onboard display, which represent the circuit program. As you can see, LOGO! interconnects the blocks using their numbers. To scroll the circuit program, use the keys ◀ or ▶.

## Advantages of block numbers

You can connect almost any block to an input of the current block by means of its block number. In this way, you can reuse the interim results of logical or other operations, reduce programming effort, save memory space and clean up your circuit layout. To do so, however, you need to know how LOGO! has named the blocks.

---

### Note

An organizational program chart can be a valuable aid when you create the circuit program because you can enter in this chart all the block numbers that LOGO! assigns.

By using the LOGO!Soft Comfort software to program LOGO!, you can directly create a function chart of your circuit program. LOGO!Soft Comfort also allows you to assign 12-character names to up to 100 blocks, and to view these on the LOGO! onboard display in parameter assignment mode. See the topic "The four golden rules for operating LOGO! (Page 70)".

---

### 3.3 From circuit diagram to LOGO! program

#### View of a circuit diagram

The following illustration shows a typical circuit diagram that represents the circuit logic:

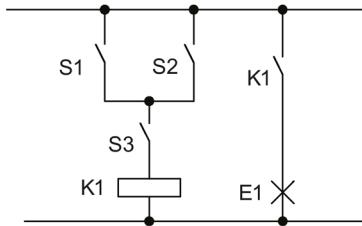

The switches (S1 OR S2) AND S3 activate the relay K1 and switch on the load at E1.

#### Creating this circuit with LOGO!

In LOGO! you create a circuit logic by interconnecting blocks and connectors:

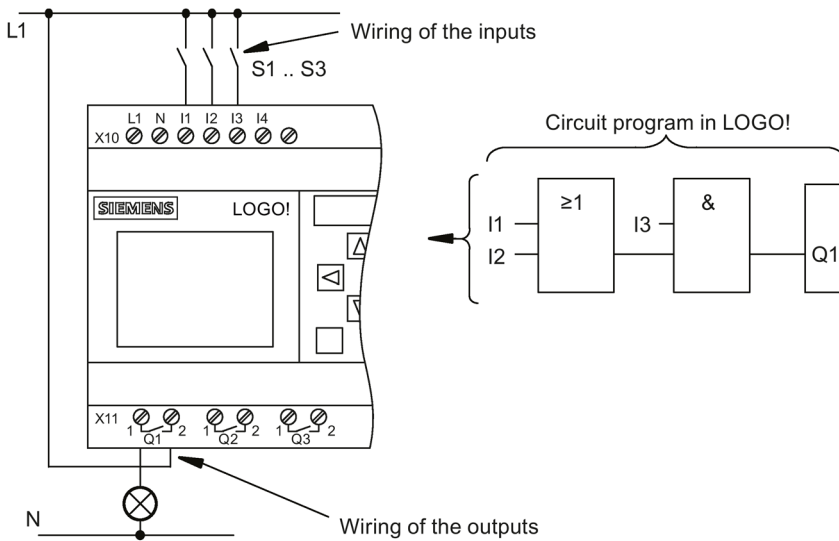

#### Note

Although you have four inputs available for logic operations (Page 135), most of the views only show three inputs for reasons of clarity. You program this fourth input and assign parameters just like you do with the other three inputs.

To create a new circuit logic in LOGO!, start at the circuit output.

The output is the load or relay that is to be switched.

Convert the circuit logic into blocks by working through the circuit, starting at the output and ending at the input:

Step 1: Connect the make contact S3 in series with another circuit element to output Q1. A series connection corresponds to the AND block:



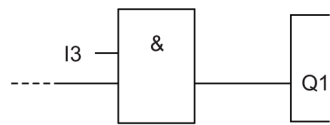

Step 2: Use an OR block to connect S1 and S2 in parallel. A parallel circuit corresponds to the OR block:

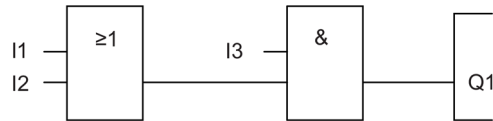

## Unused inputs

The circuit program automatically assigns the unused connectors a status that ensures proper functioning of the relevant block.

In our example we shall use only two inputs of the OR block and two inputs of the AND block; the third and fourth inputs are unused.

Now connect the I/O to LOGO! .

## Wiring

Connect the switches S1 to S3 to the screw terminals of your LOGO! :

- S1 to connector I1 of LOGO!
- S2 to connector I2 of LOGO!
- S3 to connector I3 of LOGO!

The output of the AND block controls the relay at output Q1. The load E1 connects to output Q1.

## Wiring example

The following figure shows you the wiring, based on a 230 VAC version of LOGO!.

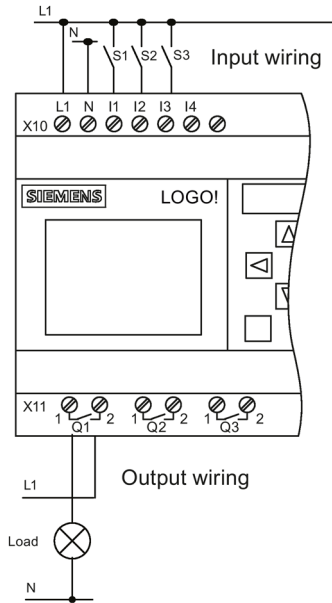

## 3.4 The four golden rules for operating LOGO!

### Rule 1: Changing the operating mode

- You create the circuit program in programming mode. After power is on, and when the program is empty in LOGO!, LOGO! selects the programming mode by default.
- You can edit timer and parameter values of an existing circuit program in both **parameter assignment mode** and **programming mode**. During **parameter assignment** LOGO! is in **RUN mode**; that is, it continues executing the circuit program (see the topic "Configuring LOGO! (Page 286)"). To work in **programming mode**, you need to terminate the circuit program.
- Select the menu command  on the main menu to set **RUN mode**.
- When the system is in **RUN mode**, you can return to **parameter assignment mode** by pressing the **ESC** key.
- When **parameter assignment mode** is open and you want to return to **programming mode**, select the menu command  from the parameter assignment menu to set **STOP mode**.

For more details on operating modes, refer to the Appendix topic "LOGO! menu structure (Page 367)".

### Rule 2: Outputs and inputs

- Always create your circuit program by working from the output to the input.
- You can connect one output to several inputs, but you cannot connect several outputs to one input.
- Within the same program path you cannot connect an output to an upstream input. You can use flags or outputs for such internal recursions.

### Rule 3: Cursor and cursor movement

The following applies when you edit a circuit program:

- You can move the cursor when it appears as a solid square:
  - Press ◀, ▶, ▼ or ▲ to move the cursor in the circuit program.
  - Press **OK** to change to select connector/block.
  - Press **ESC** to exit programming mode.
- You select a connector/block when the cursor appears as a solid square:
  - Press ▼ or ▲ to select a connector or a block.
  - Confirm with **OK**.
  - Press **ESC** to return to the previous step.

### Rule 4: Planning

- Before you start to create a circuit program, first create a design on paper or program LOGO! directly using LOGO!Soft Comfort.
- LOGO! can only save complete and faultless circuit programs.

## 3.5 Configuring menu access protection for LOGO!

LOGO! provides two access levels, administrator and operator, to limit access to specific menus in programming mode. As an administrator, you can access all menu commands; while as an operator, some specific menu commands are not visible (see section "Overview of LOGO! menus (Page 74)"). LOGO!'s default setting is administrator at delivery, and you can switch to operator at any time. When switching from operator to administrator, you need to enter a valid password. To learn how to change the password, refer to section "Tools -> Transfer -> Access Control" in *LOGO!Soft Comfort Online Help*.

LOGO! always saves its access level before power-off.

**Note**

The access level of the LOGO! TDE is operator by default, and you can switch it to administrator with the password.

The LOGO! TDE saves its access level before power-off if it connects to the same Base Module after power-on. If you connect a different Base Module to it, however, the LOGO! TDE restores its access level to operator after power-on.

**Switching LOGO! from administrator to operator**

To switch LOGO!'s access level from administrator to operator, follow these steps:

1. Move the cursor to "①" on the main menu of programming mode: Press ▲ or ▼ .

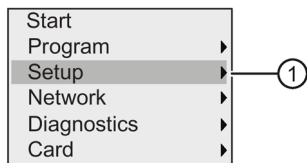

2. Confirm "①": Press **OK**.
3. Move the cursor to "②": Press ▲ or ▼ .

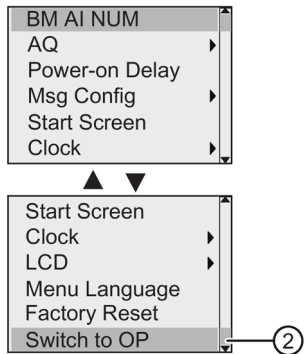

4. Confirm "②": Press **OK**.  
LOGO! now switches to the access level of operator and returns to the main menu.

## Switching LOGO! from operator to administrator

To switch LOGO!'s access level from operator to administrator, follow these steps:

1. Move the cursor to "①" on the main menu of programming mode: Press ▲ or ▼ .

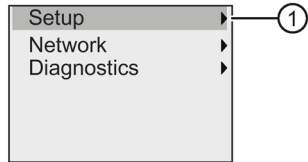

2. Confirm "①": Press **OK**.
3. Move the cursor to "②": Press ▲ or ▼ .

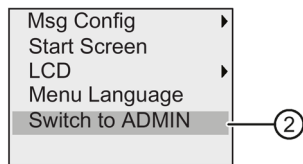

4. Confirm "②": Press **OK**. The display appears as follows:

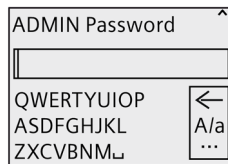

5. To select a character, press ▲, ▼, ◀ or ▶ to move the flashing selection cursor to the character in the soft keyboard and press **OK**, then the selected character appears in the input box.

Refer to section "Using soft keyboard (Page 75)" to learn how to use the soft keyboard.

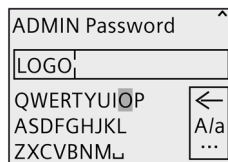

6. To confirm the password, press **ESC** to exit character selection, or move the flashing selection cursor back to the input box, then the dashed cursor in the input box becomes solid cursor. Press **OK**.

LOGO! now switches to the access level of administrator and returns to the main menu.

### 3.6 Overview of LOGO! menus

The following illustration shows an overview of LOGO! OBA8 menus:

Programming mode

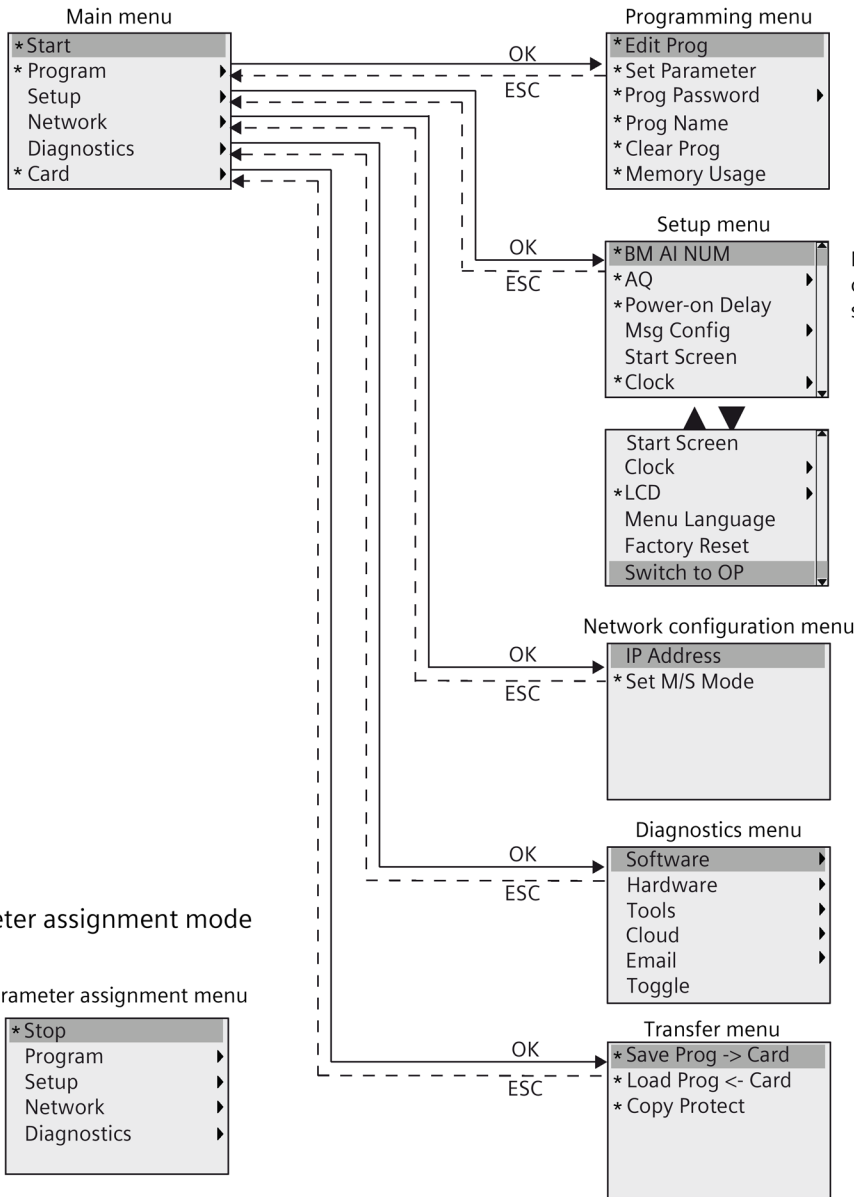

Note: The "BM AI NUM" selection is only available on Base Modules that support four analog inputs.

\* These menu commands are visible only with the access level of administrator. For more details on the menus, refer to the Appendix "LOGO! Basic (Page 367)". The following illustration shows an overview of LOGO! TDE menus:

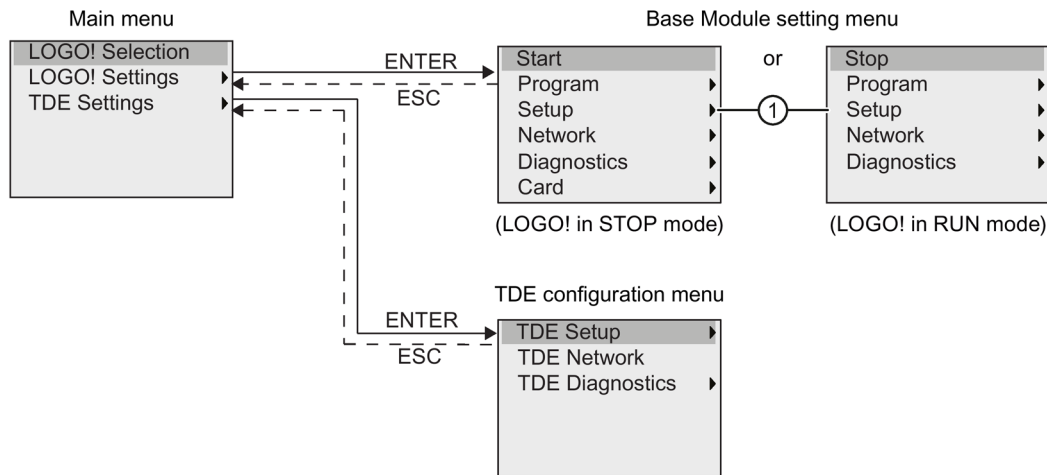

The LOGO! TDE provides three menus as follows:

- The remote IP selection menu

You can use this menu to select a connected Base Module by entering a specific IP address.

- The Base Module setting menu

You can use this menu to perform the remote setting of the connected Base Module. This menu has almost the same menu commands as those on the Base Modules, except for the menu commands under "①". The menu commands for setting the start screen, message text, contrast and backlight, and menu language for the Base Module are not available on the LOGO! TDE.

- The TDE configuration menu

You can use this menu to perform the independent configuration of the LOGO! TDE.

For more details on the menus, refer to the Appendix "LOGO! TDE (Page 373)".

## 3.7 Using soft keyboard

You can use the soft keyboard in LOGO! BM to enter block name, program name or password.

### Soft keyboard introduction

Here we take entering program name as an example. The input page is as follows:

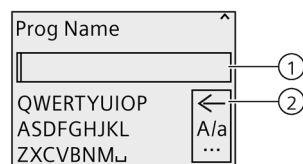

There is a solid cursor in "①" the text input box. You can use ◀ or ▶ key to move the solid cursor between characters in the box. When the flashing selection cursor appears in the soft keyboard, the solid cursor in the input box becomes a dashed cursor.

To enter any characters, move the flashing selection cursor to the character in the keyboard and press **OK**, then the character will be selected and appear in the input box.

To use "②", move the flashing selection cursor to it and press **OK**, the character before the dashed cursor in the input box will be deleted.

To use "③", move the flashing selection cursor to it and press **OK**, the keyboard will be switched from upper case letters to lower case letters or the other way round.

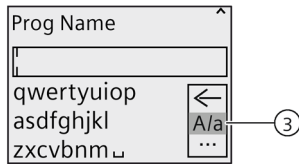

To use "④", move the flashing selection cursor to it and press **OK**, the keyboard will be switched into numbers and special characters.

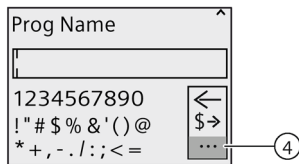

To use "⑤", move the flashing selection cursor to it and press **OK**, the keyboard will be switched to the next page of special characters.

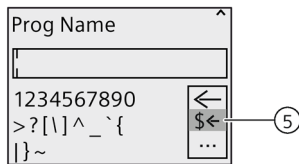

To confirm the input content in the input box, press **ESC** to exit character selection, or move the flashing selection cursor back to the input box, then the dashed cursor in the input box becomes solid cursor. Press **OK**.

### Available character set

The following character set is available in the soft keyboard:

	A	B	C	D	E	F	G	H	I	J	K	L	M	N	O
P	Q	R	S	T	U	V	W	X	Y	Z	0	1	2	3	4
5	6	7	8	9	!	"	#	\$	%	&	'	(	)	*	+
,	-	.	/	:	;	<	=	>	?	@	[	\	]	^	_
`	{		}	~	a	b	c	d	e	f	g	h	i	j	k
l	m	n	o	p	q	r	s	t	u	v	w	x	y	z	



## 3.8 Writing and starting the circuit program

The example below shows how to create a program for your circuit design in LOGO!.

### 3.8.1 Selecting programming mode

When you connect LOGO! to the power supply and switch it on, the display shows you the main menu of the programming mode:

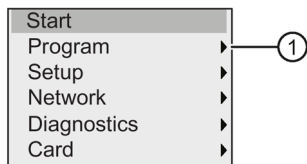

The first line is highlighted. Press ▲ and ▼ to move the highlight bar up and down. Move it to "①" and confirm with **OK**. LOGO! opens the programming menu.

The **LOGO!'s programming menu** is as shown below:

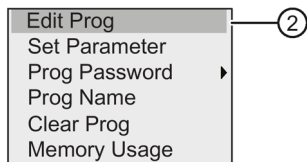

Here you can also move the highlight bar by pressing ▲ and ▼. Move the highlight bar to "②" and confirm with **OK**.

You are now in the circuit program window. Press **OK** to enter the program editing mode, and the cursor appears as a solid square at the "**NEW**" block. The display now shows as follows:

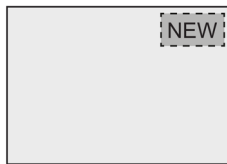

Confirm with **OK** and LOGO! now shows you the first output:

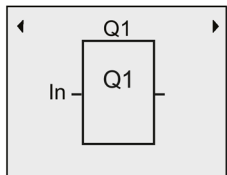

You are now in programming mode. Press ▲ and ▼ to select the other outputs. Now you can start to edit your circuit program.

**Note**

Because you have not yet saved a **password** for the circuit program in LOGO!, you can directly enter editing mode. When you select to edit the program after you have saved a password-protected circuit program, LOGO! prompts you to enter a password and to confirm it with **OK**. You can only edit the program after you have entered the correct password (Page 84).

If you have created your circuit program in LOGO!, you can view it in the circuit program window by moving cursor on the blocks. LOGO! can display a maximum of 31\*31 blocks in the circuit program window.

### 3.8.2 The first circuit program

The following parallel circuit consists of two switches.

#### Circuit diagram

The corresponding circuit diagram shows as follows:

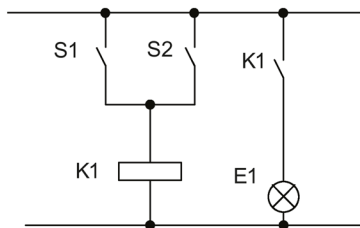

The switch S1 OR S2 turns on the load. LOGO! interprets this parallel circuit as an 'OR' logic, because S1 OR S2 switches on the output.

Translated into a LOGO! circuit program, you use an OR block to control relay K1 at output Q1.

#### Circuit program

Switch S1 connects to input I1 and switch S2 connects to input I2. Inputs I1 and I2 connect to the OR block connectors.

The corresponding layout of the circuit program in LOGO! shows as follows:

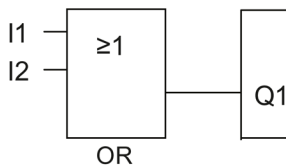

## Wiring

The corresponding wiring shows as follows:

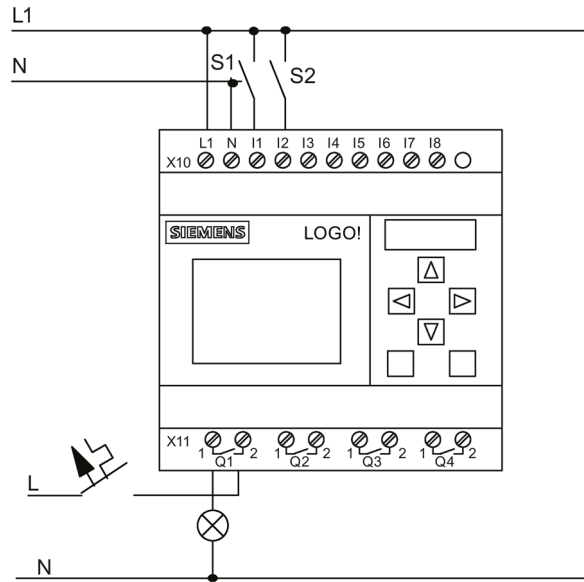

S1 switches input I1, while S2 switches input I2. The load connects to the relay Q1.

### 3.8.3 Circuit program input

You can now write the circuit program, starting at the output and working towards the input. LOGO! initially shows the output:

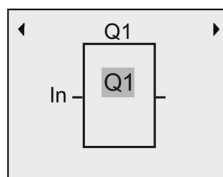

The first LOGO! output

You will see a solid square at Q1, which is the **cursor**. The cursor indicates your current position in the circuit program. You can move the cursor by pressing the ▲, ▼, ◀ and ▶ keys. Now press the ◀ key. The cursor moves to the left.

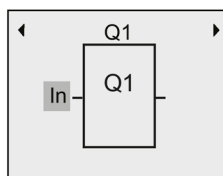

The cursor indicates your current position in the circuit program.

At this point you enter only the first (OR) block. Press **OK** to select editing mode.

3.8 Writing and starting the circuit program

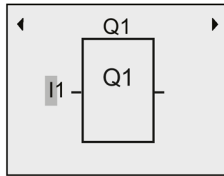

The cursor is displayed as a flashing solid square: you can now select a connector or a block

The cursor now appears as a flashing solid square. LOGO! offers you various options here. Select GF (basic functions) by pressing the ▼ key until GF appears, and confirm with **OK**. LOGO! now shows the first block from the list of basic functions:

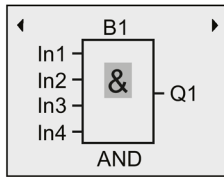

The AND is the first block of the basic function list. The solid square cursor prompts you to select a block.

Press **OK** to select editing mode, which causes LOGO! to display the cursor as a flashing solid square. Now press ▼ or ▲ until the OR block appears on the display:

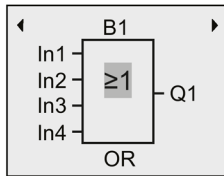

The flashing solid square cursor still appears on the block.

Press **OK** to confirm your entries and exit the dialog.

The display now shows:

Your complete circuit program layout

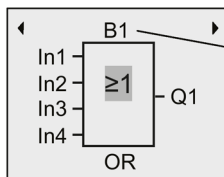

Block number

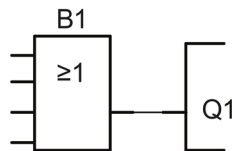

You have now entered the first block. LOGO! automatically assigns a block number to each new block. If you assign a name to the block, LOGO! shows the block name instead of the block number. You can assign a block name as required:

Press ▲ to move the cursor to "B1".

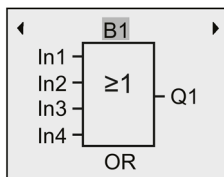

Press **OK**. The name edit page is displayed as follows:

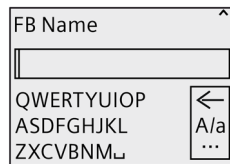

Now you can enter the block name using the soft keyboard (Page 75). After you complete the change, press **OK** to confirm.

You then connect the block inputs as follows:

Press **◀** to position the cursor on In1 and press **OK** to select editing mode.

Press **▼** or **▲** to select the digital input list. The first element of the digital input list is the "Input 1", namely "I1". You can press **▶** to move the cursor to the input number, and then use **▼** or **▲** to select the desired input (I1 to I24).

The display now shows:

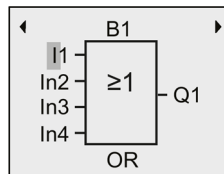

#### Note

Inputs F1, F2, F3, and F4 correspond to the four function keys on the optional LOGO! TDE.

More shift register bits (S1.1 to S4.8), blank connectors (X1 to X64) and analog flags (AM1 to AM64) are available in the OBA8 device series.

Network digital inputs (NI1 to NI64), network analog inputs (NAI1 to NAI32), network digital outputs (NQ1 to NQ64), and network analog outputs (NAQ1 to NAQ16) are available for the OBA8 device series. LOGO! OBA8 does not include these inputs and outputs until you configure them in a circuit program in LOGO!Soft Comfort V8.1 and download the program to your LOGO! OBA8 device.

After selecting I1, the display now shows as follows:

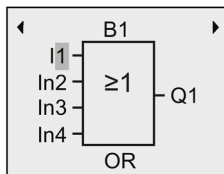

Press **OK** to confirm. You have now connected I1 to the input of the OR block.

3.8 Writing and starting the circuit program

The display now shows:

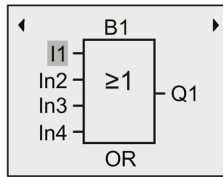

Your complete circuit program in LOGO! up to now:

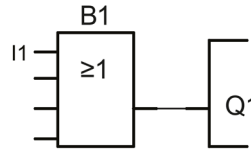

Now you connect input I2 to the input of the OR block:

1. Move the cursor to In2: Press ▼ or ▲
2. Switch to editing mode: Press **OK**
3. Select the digital input list: Press ▼ or ▲
4. Move the cursor to the input number: Press ►
5. Select **I2**: Press ▼ or ▲
6. Apply I2: Press **OK**

You have now connected I2 to the second input of the OR block:

The display now shows:

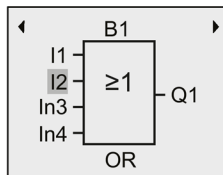

Your complete circuit program in LOGO! up to now:

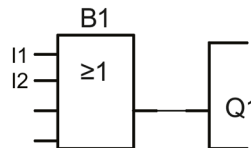

**Note**

You can invert individual inputs of the basic and special functions; that is, if an input carries a logical "1" signal, you can cause the circuit program to output a logical "0". You can also cause LOGO! to invert a logical "0" signal to a logical "1".

To invert an input, move the cursor to the relevant position, for example:

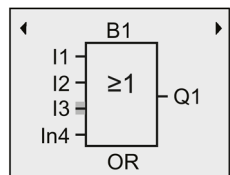

Confirm with **OK**.

Now press ▲ or ▼ to invert this input: ➔

Next, press **ESC**.

Your circuit program layout:

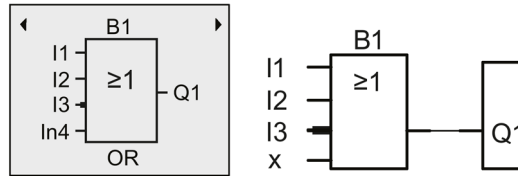

You can review your first circuit program by pressing ◀ or ▶ to move the cursor through the circuit program.

To exit circuit programming mode and return to the programming menu, press **ESC**

### Note

LOGO! has now saved your circuit program to nonvolatile memory. The circuit program remains in the LOGO! memory until you explicitly delete it.

You can save the actual values of special functions in the case of a power outage assuming that these functions support the "Retentive" parameter and that the necessary program memory is available. By default, LOGO! deactivates the "Retentive" parameter when you insert a function; to use it, you must enable this option.

## 3.8.4 Assigning a circuit program name

You can assign your circuit program a name that consists of up to 16 uppercase/lowercase letters, numbers and special characters.

1. In the main menu in programming mode, press ▼ or ▲ to move the cursor to "①".

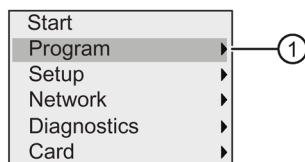

2. To confirm "①", press **OK**.
3. Press ▼ or ▲ to move the cursor to "②".

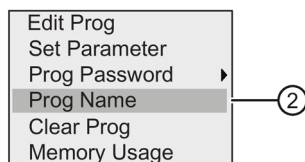

4. To confirm "②", press **OK**.

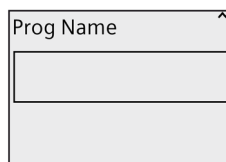

5. Press **OK** to enter the editing page with soft keyboard.

Now you can use the soft keyboard to enter program name. Refer to section "Using soft keyboard (Page 75)" to learn how to use the soft keyboard.

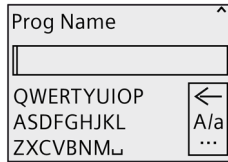

6. To confirm the program name, press **ESC** to exit character selection, or move the flashing selection cursor back to the input box, then the dashed cursor in the input box becomes solid cursor. Press **OK**.

To change the name of your circuit program, proceed in the same way.

---

**Note**

**Circuit program name input limit**

The length of circuit program name cannot exceed 16 bytes. All characters in the soft keyboard are supported for the circuit program name. Refer to section "Using soft keyboard (Page 75)" to learn about the supported character set.

---

**Note**

You can change the name of the circuit program in programming mode only. If you have saved a password-protected circuit program, you can change the name of the circuit program only after you have entered the correct password (refer to section "Password for circuit program protection (Page 84)"). You can **read** the name in both programming mode **and** parameter assignment mode.

### 3.8.5 Password for circuit program protection

You can protect a circuit program from unauthorized access by assigning it a password.

You can assign, change, or deactivate a program password from a LOGO! Basic, LOGO!Soft Comfort or a LOGO! TDE.

---

**Note**

There is only one circuit program protection password that you can assign for LOGO!.

---

**Note**

Siemens recommends you transfer password with secure communication (Page 311).



**Note**

You can assign a password with the maximum length of 10 bytes and only consisting of upper case letters.

You can assign, edit or deactivate the password only in the programming mode on LOGO! Basic.

**Assigning a program password from LOGO! Basic**

To enter a password, follow these steps in the programming menu:

1. Move the cursor to "①": Press ▼ or ▲

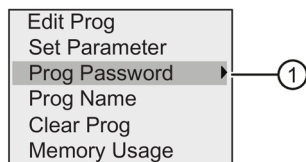

2. Confirm "①": Press **OK**
3. Move the cursor to "②": Press ▼ or ▲

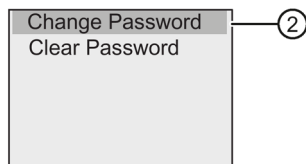

4. Confirm "②": Press **OK**. The input page is as follows:

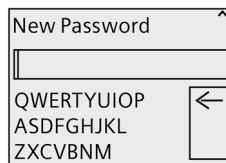

As you can assign password only consisting of upper case letters for the program, only upper case letters are available in the soft keyboard.

5. To select a character, move the flashing selection cursor to the letter in the soft keyboard, then press **OK**. The selected letter appears in the input box.

Refer to section Using soft keyboard (Page 75) to learn how to use the soft keyboard.

6. To confirm the password, press **ESC** to exit character selection, or move the flashing selection cursor back to the input box, then the dashed cursor in the input box becomes solid cursor. Press **OK**.

You have now protected your circuit program with the password and LOGO! returns to the programming menu.

**Note**

You can cancel the input of a new password with **ESC**. In this case, LOGO! Basic returns to the programming menu without saving the password.

You can also set your password using LOGO!Soft Comfort or LOGO! TDE. You cannot edit a password-protected circuit program in a LOGO! Base Module or upload it to LOGO!Soft Comfort unless you enter the correct password.

To allow you to create and edit a circuit program for a protected module (Card), you first need to assign a password to this new program (Page 314).

**Changing the password from LOGO! Basic**

You must know the current password in order to change it. From the programming menu, follow these steps to change the password:

1. Move the cursor to "①": Press ▼ or ▲

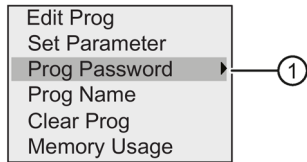

2. Confirm "①": Press **OK**

The display now shows:

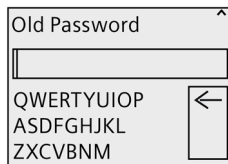

Enter your old password using the soft keyboard (Page 75). Confirm your password with **OK**.

3. Move the cursor to "②": Press ▼ or ▲

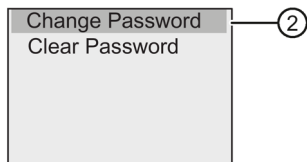

- Confirm "②": Press **OK**. Now you can enter your new password.

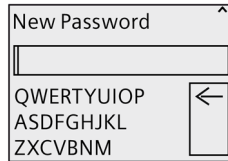

- To confirm the password, press **ESC** exit character selection, or move the flashing selection cursor back to the input box, then the dashed cursor in the input box becomes solid cursor. Press **OK**.

You have now set a new password and LOGO! returns to the programming menu.

### Deactivating the password from LOGO! Basic

To deactivate the password to allow, for example, another user to edit your circuit program, you must know your current password.

To deactivate the password, follow these steps in the programming menu:

- Move the cursor to "①": Press **▼** or **▲**

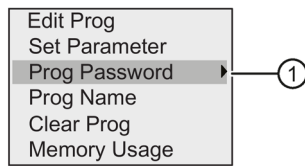

- Confirm "①": Press **OK**

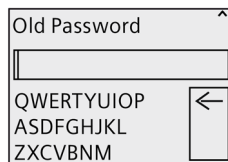

Enter your current password using the soft keyboard (Page 75). Confirm your password with **OK**.

- Move the cursor to "②": Press **▼** or **▲**

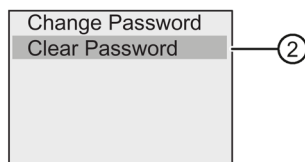

4. Confirm "②": Press **OK**

The display now shows:

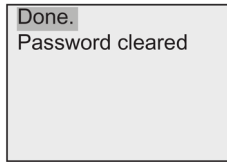

Alternatively, you can also select "③" to clear the password by leaving the input box blank.

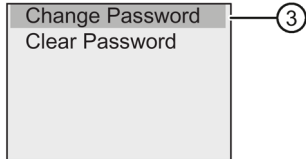

5. Press any key and LOGO! returns to the programming menu. You have now cleared the password.

---

**Note**

This action disables the password prompt, and thus permits access without a password.

---

**Password: Wrong Password!**

If you enter the **wrong** password and confirm the input with **OK**, LOGO! Basic does not open editing mode, and the display shows as follows:

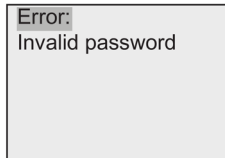

In this case, press any key and LOGO! returns to the programming menu. This repeats itself over and over again until you enter the correct password.

### 3.8.6 Switching LOGO! to RUN mode

To switch LOGO! to RUN mode, follow these steps:

1. Return to the main menu: Press **ESC**
2. Move the cursor to "①": Press **▲** or **▼**

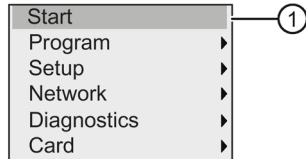

3. Confirm "①": Press **OK**. The display now shows:

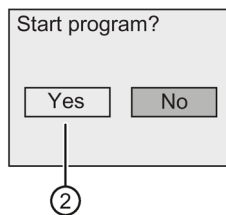

4. Press **◀** to move the cursor to "②" and press **OK**.

LOGO! runs the circuit program and shows the following display:

The start screen of LOGO! displays one of the following:

- Date and current time-of-day (only for versions with real-time clock). This element flashes if you have not set the date and time.
- Digital inputs
- Parameter assignment menu

You can select the default setting for the start screen that LOGO! displays in RUN mode. For more information, see Section "Setting the start screen (Page 298)".

3.8 Writing and starting the circuit program

Display field of LOGO! in RUN mode

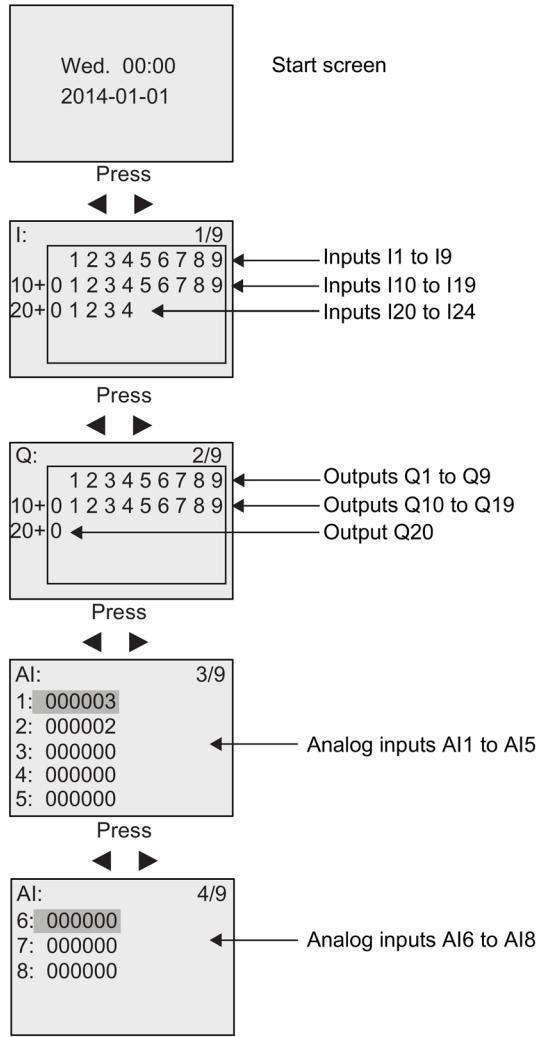

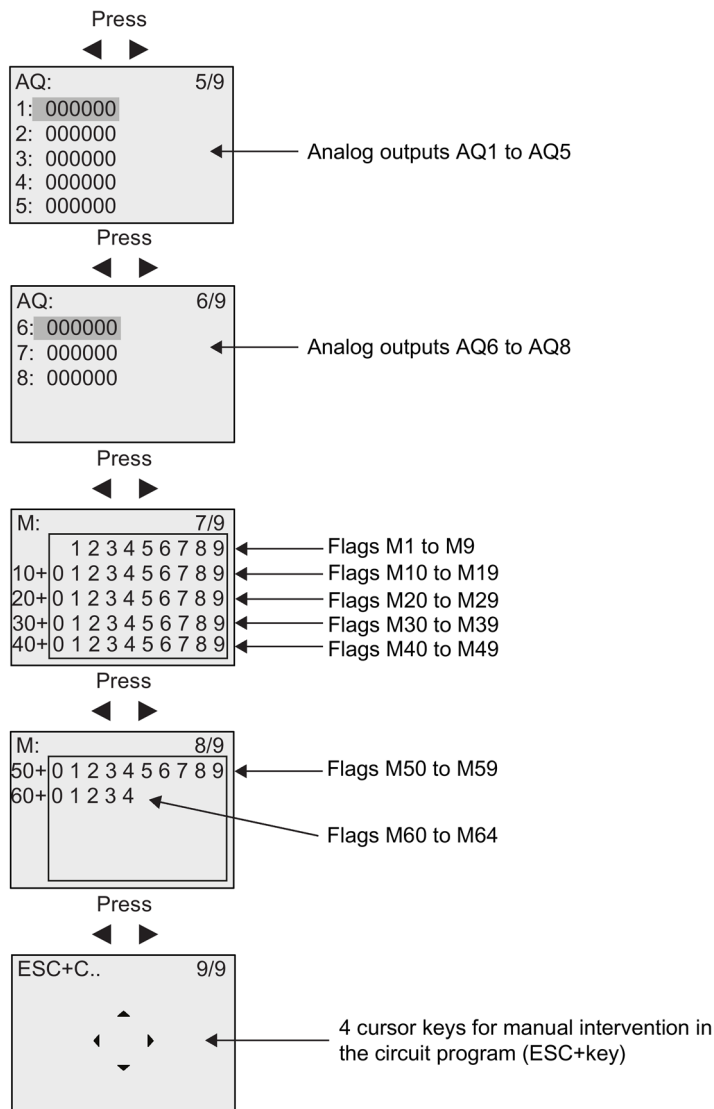

### Viewing the analog value changes

You can view the value changes of each analog I/O in the form of a trend curve when LOGO! is in RUN mode. For example, to view the value changes of AI3, follow these steps:

1. Switch LOGO! to RUN mode.
2. Scroll the display to the AI screen form (3/9): Press ◀ or ▶

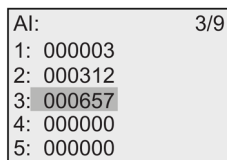

3. Move the cursor to AI3: Press ▲ or ▼
4. Press OK to confirm your selection. The display now shows the AI3 value changes in the form of a curve, for example:

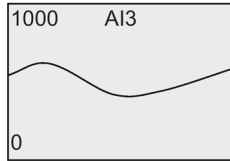

The display refreshes continuously and the curve shifts to the left of the display bit by bit. You can press ◀ or ▶ to move the screen from to the left/right in order to view the earlier/later value changes.

**What is meant by: "LOGO! is in RUN"?**

In RUN mode, LOGO! executes the circuit program. LOGO! first reads the status at the inputs, determines the status of the outputs by means of the circuit program, and switches these on or off according to your settings.

This is how LOGO! indicates the I/O status:

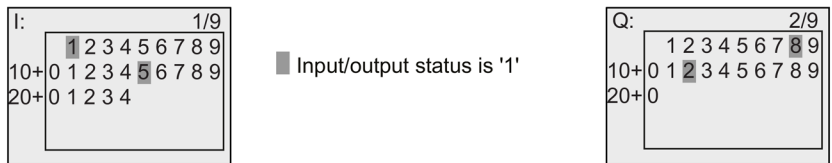

In this example, only the inputs I1 and I15 and the outputs Q8 and Q12 are set "high".

**Status indication on the display**

Using the example, you can see how LOGO! displays the input and output states:

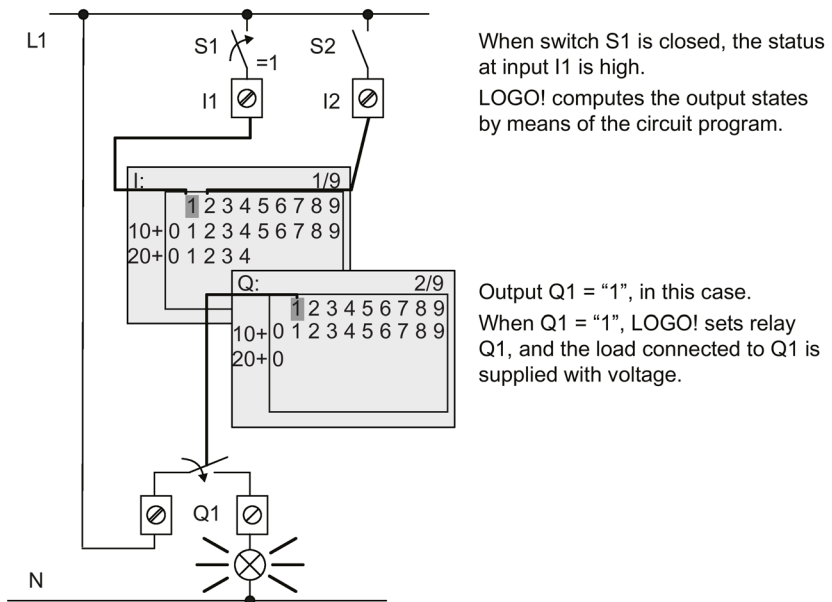



### 3.8.7 Second circuit program

Up to this point, you have successfully created your first circuit program, assigned it a name, and optionally a program password. In this section you will learn how to modify existing circuit programs and how to use the special functions.

Using this second circuit program, you will learn how to perform the following tasks:

- Add a block to an existing circuit program
- Select a block for a special function
- Assign parameters

#### Modifying circuits

You will use the first circuit program as a basis for the second, with some slight modifications.

First of all take a look at the circuit diagram for the second circuit program:

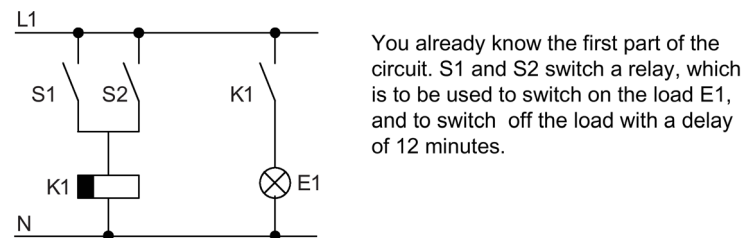

This is the circuit program layout in LOGO!:

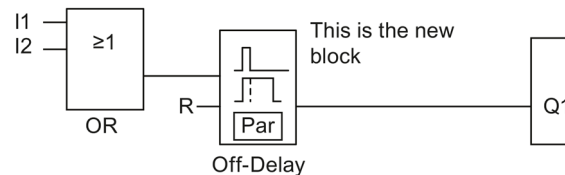

You can see the OR block and the output relay Q1 that you used in the first circuit program. The only difference is the new off-delay block.

#### Editing the circuit program

Follow these steps to edit the circuit program:

1. Switch LOGO! to programming mode. For additional details, see the topic "The four golden rules for operating LOGO! (Page 70)".
2. On the main menu, move the cursor to "①": Press ▲ or ▼

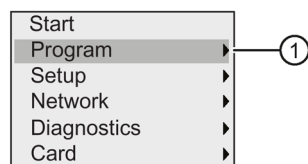

3. Confirm "①": Press **OK**. The display now shows:

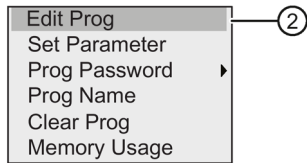

4. On the programming menu, move the cursor to "②": Press **▲** or **▼**

5. Confirm "②": Press **OK**. If required, enter your password at the prompt and confirm with **OK**.

6. In the circuit program window, press **OK** to activate the cursor as a solid square.

You can now modify the current circuit program.

### Adding a block to a circuit program

Press **◀** to move the cursor to B1 (B1 is the number of the OR block):

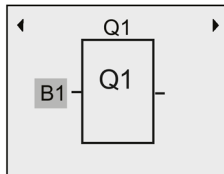

Insert the new block at this position.

Confirm with **OK**, and the cursor appears as a flashing solid square.

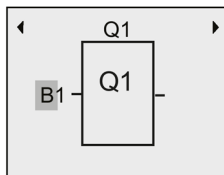

Press **▼** twice to select the SF list. The SF list contains the special function blocks.

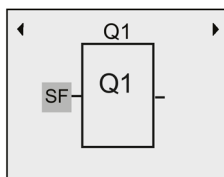

Press **OK**.

LOGO! displays the block of the first special function:

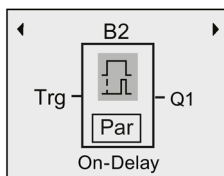

When you select a special or basic function block, LOGO! shows you the relevant function block and positions the solid square cursor on the block. Press **OK** to enter the editing mode, and the cursor appears as a flashing solid square. Press **▲** or **▼** to select the required block.

Select your block (off-delay, see the next figure), and then press **OK**:

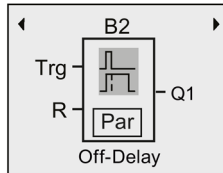

LOGO! assigns the block number B2 to the block that you added.

Press **◀** to move the cursor to Trg, and then press **OK**.

Press **▲** or **▼** to select B1 and confirm with **OK**.

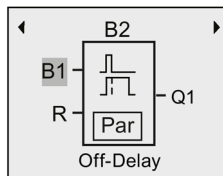

LOGO! automatically connects the uppermost input of the new block to B1, which you had previously connected to Q1. Note that you can only interconnect digital inputs with digital outputs or analog inputs with analog outputs. LOGO! otherwise removes the 'old' block.

The off-delay block has two inputs and a parameter. At the top is the trigger input (Trg) you use to start the off-delay time. In our example, the OR block B1 triggers the off-delay. You reset the time and the output with a signal at the reset input (R). You set the off-delay time at parameter T of the Par.

### Assigning block parameters

Now you set the off-delay time T:

1. Move the cursor to **Par**: Press **▶**
2. Switch to editing mode: Press **OK**

LOGO! shows the parameters in the parameter assignment window:

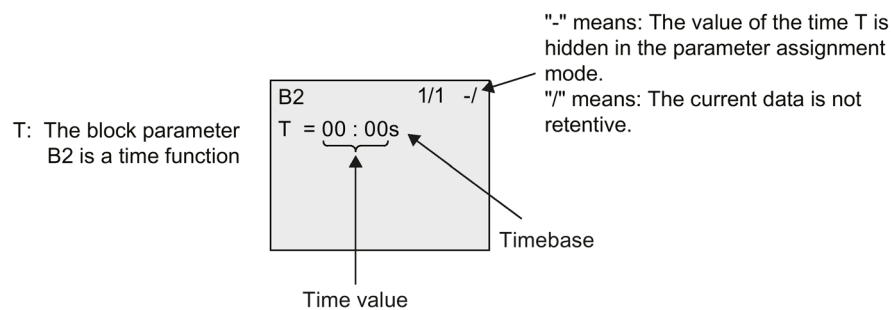

To change the time value, follow these steps:

1. Move the cursor to the time value: Press ▼
2. Switch to editing mode: Press OK
3. Press ◀ and ▶ to position the cursor.
4. Press ▲ and ▼ to modify the value at the relevant position.
5. Confirm your entries with OK.

### Setting the time

Set the time T = 12:00 minutes:

1. Move the cursor to the first digit: Press ◀ or ▶
2. Select the digit "1": Press ▲ or ▼
3. Shift the cursor to the second digit: Press ◀ or ▶
4. Select digit "2": Press ▲ or ▼
5. Move the cursor to the unit: Press ◀ or ▶
6. Select the timebase "m" (for minutes): Press ▲ or ▼
7. Confirm your entries with OK.

### Showing/hiding parameters - the parameter protection mode

If you want to show/hide the parameter and allow/prevent its modification in parameter assignment mode, follow these steps:

1. Move the cursor to "-/": Press ▲ or ▼
2. Switch to editing mode: Press OK
3. Select the protection mode: Press ▲ or ▼

The display should now show:

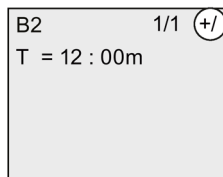

or

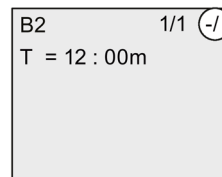

When the protection mode shows "+", you can modify the time T in parameter assignment mode.

When the protection mode shows "-", you cannot modify the time T in parameter assignment mode.

4. Confirm your entries with OK.

## Enabling/disabling retentivity

To decide whether you want to retain your current data after a power failure or not, follow these steps:

1. Move the cursor to "-/": Press ▲ or ▼
2. Switch to editing mode: Press OK
3. Move the cursor to the retentivity setting: Press ◀ or ▶
4. Select the retentivity setting: Press ▲ or ▼

The display now shows:

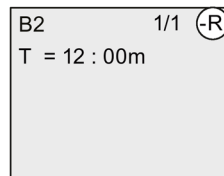

Retentivity R: Current data is retentive.

or

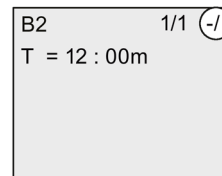

Retentivity /: Current data is not retentive.

5. Confirm your entries with OK.

---

### Note

For further information on the protection mode, refer to the topic "Parameter protection (Page 144)".

For further information on retentivity, refer to the topic "Retentivity (Page 144)".

You can modify the protection mode and retentivity setting only in programming mode. This is **not** possible in parameter assignment mode.

LOGO! displays protection mode ("+" or "-") and retentivity ("R" or "/") settings only where you can actually change these settings.

---

## Verification of the circuit program

You have now completed the program branch for Q1 and LOGO! shows you the output Q1. You can once again view the circuit program on the display. Use the keys to browse the circuit program; that is, press ◀ or ▶ to move from block to block, ▲ and ▼ to move between the inputs at a block.

## Closing the programming mode

When you finish programming, you can exit the programming mode by following these steps:

1. Return to the programming menu: Press ESC
2. Return to the main menu: Press ESC

3. Move the cursor to "①": Press ▲ or ▼

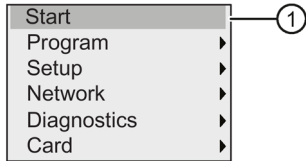

4. Confirm "①": Press **OK**

LOGO! is back in RUN mode:



You can press ◀ or ▶ to scroll the pages and to monitor the I/O states.

### 3.8.8 Deleting a block

Consider the case where you want to delete the block B2 from your circuit program and connect B1 directly to Q1.

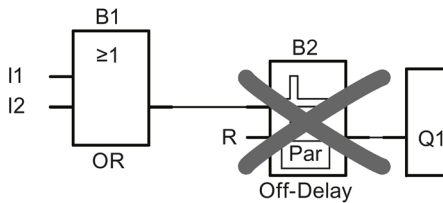

To delete this block, follow these steps:

1. Switch LOGO! to programming mode.  
(As a reminder, refer to the topic "The four golden rules for operating LOGO! (Page 70)").
2. Select "①": Press ▲ or ▼

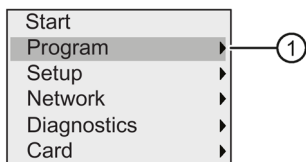

3. Confirm "①": Press **OK**

4. Select "②": Press ▲ or ▼

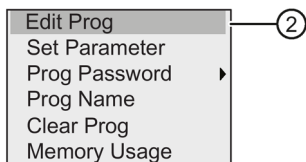

5. Confirm "②": Press **OK**  
(If required, enter your password and confirm with **OK**.)
6. Press **OK** in the circuit program window, and the cursor now appears as a solid square.
7. Move the cursor to the Q1 block and then press **OK**.
8. Move the cursor to B2, the input of Q1, and confirm with **OK**.

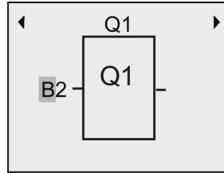

9. Now replace block B2 with block B1 at output Q1.
  - Move the cursor to the 2 in B2: Press **▶**
  - Select 'B1': Press **▼**
  - Apply 'B1': Press **OK**

**Result:** LOGO! deletes block B2 from the circuit and connects the output of B1 directly to output Q1.

### 3.8.9 Deleting block groups

Consider the case where you want to delete blocks B1 and B2 from the second circuit program example (refer to the "Second circuit program (Page 93)" topic).

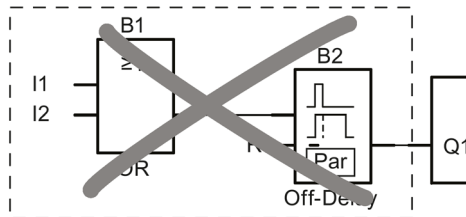

To delete these two blocks from that program, follow these steps:

1. Switch LOGO! to programming mode.  
(As a reminder, refer to the topic "The four golden rules for operating LOGO! (Page 70)".)
2. To select "①": Press **▲** or **▼**

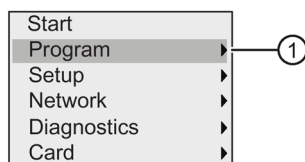

3. To confirm "①": Press **OK**

4. To select "②": Press ▲ or ▼

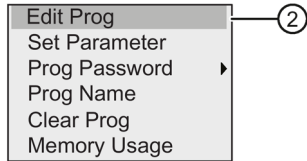

5. To confirm "②": Press **OK**  
(If required, enter your password and confirm with **OK**.)
6. Press **OK** in the circuit program window, and the cursor now appears as a solid square.
7. Move the cursor to the Q1 block and then press **OK**.
8. Move the cursor to B2, the input of Q1, and confirm with **OK**.

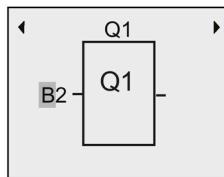

9. Now set the blank connector at output Q1 instead of block B2:
  - Select the blank connector: Press ▲ or ▼
  - Apply the blank connector: Press **OK**

**Result:** LOGO! deletes block B2 and all blocks that connect to B2 (in this case, block B1) from the circuit.

### 3.8.10 Correcting programming errors

You can easily correct programming errors in LOGO!. Providing that you are still in editing mode, you can revert one step by pressing **ESC**. If you have already configured all inputs, simply reconfigure the faulty input:

1. Move the cursor to the faulty position.
2. Change to editing mode: Press **OK**.
3. Enter the correct input circuit.

You can only replace a block with a block that has exactly the same number of inputs. However, you can delete the old block and then insert a new one. You can choose any new block.



### 3.8.11 Selecting analog output values for RUN/STOP transition

You can set the behavior of up to eight analog outputs when LOGO! changes from RUN mode to STOP mode. To set the behavior for analog outputs for a RUN-to-STOP transition, follow these steps:

1. In the programming menu, move the cursor to "①": Press ▼ or ▲ .

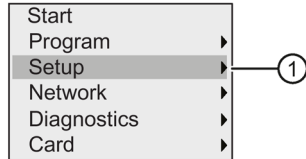

2. Select "①": Press **OK**.
3. Move the cursor to "AQ": Press ▼ or ▲ .
4. Select "AQ": Press **OK**
5. Move the cursor to "②": Press ▼ or ▲ .

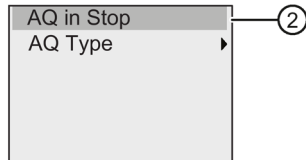

6. Select "②": Press **OK**.

LOGO! shows the following display:



The circle with a dot before "④" above indicates the current setting for the analog output channels.

You can select either "③" or "④". The default setting is "④" which means that LOGO! holds the values of the analog outputs at their last values. A setting of "③" means that LOGO! sets the analog output values to specific values, which you can configure. When LOGO! changes from RUN mode to STOP mode, the values of the analog outputs change as well, depending on the setting.

7. Select the desired output setting: Press ▲ or ▼.
8. Confirm your entry: Press **OK**.

### Defining a specific analog output value

To output a specific analog value at the analog outputs, follow these steps:

1. Move the cursor to "③": Press ▲ or ▼ .

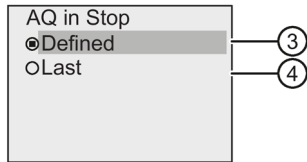

2. Confirm "③": Press **OK**.

The display shows:

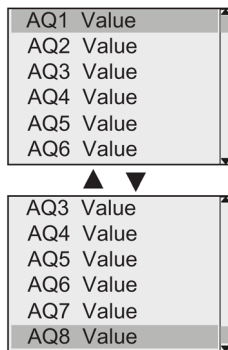

3. Select a desired analog output and press **OK**.
4. Enter a specific output value for the analog output.

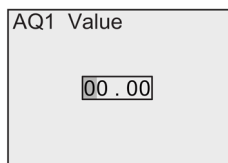

5. To confirm your entry, press **OK**.

### 3.8.12 Defining the type of analog outputs

Analog outputs can be either 0..10V/0..20mA, which is the default, or 4..20mA.

To define the type of analog outputs, follow these steps starting from the programming menu:

1. Move the cursor to "①": Press ▼ or ▲

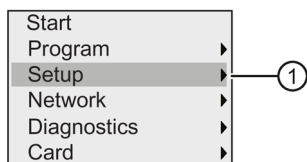

2. Select "①": Press **OK**

3. Move the cursor to "AQ": Press ▼ or ▲
4. Select "AQ": Press OK
5. Move the cursor to "②": Press ▼ or ▲

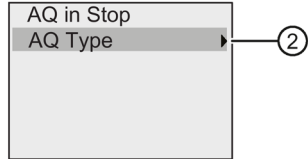

6. Select "②": Press OK

LOGO! shows the following display:

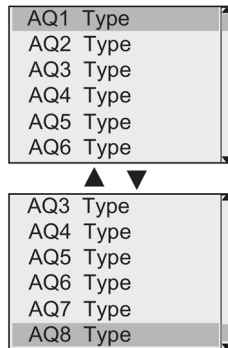

7. Move the cursor to the desired AQ, and press OK.  
LOGO! indicates the defined type for the analog channel by a circle with a dot.
8. Select either 0..10V/0..20mA (default) or 4..20mA: Press ▼ or ▲
9. Confirm your selection: Press OK.

### 3.8.13 Setting the power-on delay of LOGO!

You can set a power-on delay for LOGO! in order to make sure all the connected expansion modules are powered on and ready to use before LOGO! runs the circuit programs.

To set the power-on delay, follow these steps:

1. In the programming menu, move the cursor to "①": Press ▲ or ▼

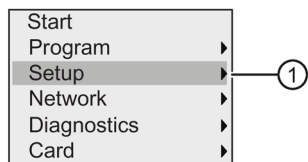

2. Confirm "①": Press OK.

3. Move the cursor to "②": Press ▲ or ▼

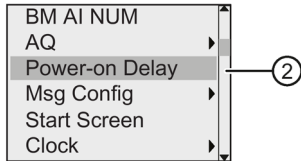

4. Confirm "②": Press **OK**. LOGO! shows the following display:

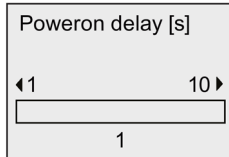

5. Press ► or ◀ to increase or decrease the delay time by 0.2 s. You can also press and hold down ► or ◀ to quickly increase or decrease the time.
6. Confirm your setting: Press **OK**.

### 3.8.14 Clearing the circuit program and password

To clear a circuit program and the password if one is defined, follow these steps:

1. Switch the LOGO! to programming mode. LOGO! opens the main menu:

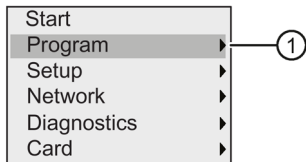

2. On the main menu, press ▲ or ▼ to move the cursor to "①". Press **OK**. LOGO! opens the programming menu.
3. On the programming menu, move the cursor to "②": Press ▲ or ▼

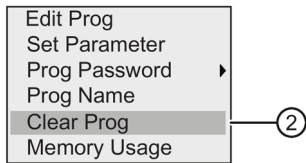

4. Confirm "②": Press **OK**

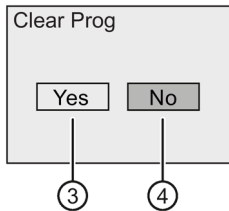

- If you are sure that you want to clear the circuit program in the memory, move the cursor to "③" and confirm with **OK**. LOGO! clears the circuit program and password.

To cancel clearing of the circuit program, leave the cursor at "④" and press **OK**.

### 3.8.15 Summertime/wintertime conversion

You can enable or disable automatic summertime/wintertime conversion.

#### Note

Summertime refers to "daylight saving time" and wintertime refers to "standard time" in the United States.

#### To enable/disable automatic S/W Time conversion in programming mode:

- Switch LOGO! to programming mode. LOGO! displays the main menu.
- Select "①": Press ▲ or ▼ .

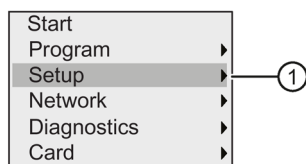

- Confirm "①": Press **OK** .
- Move the cursor to "②": Press ▲ or ▼ .

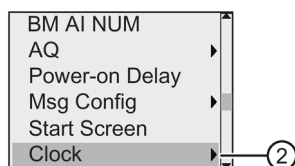

- Confirm "②": Press **OK** .
- Move the cursor to "③": Press ▲ or ▼ .

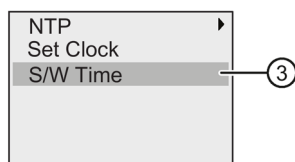

7. Confirm "③": Press **OK** .

LOGO! shows the following display:

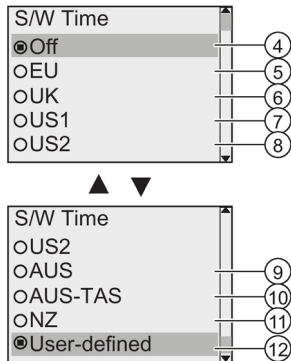

The current setting of automatic S/W Time conversion is indicated by a circle with a dot. The default setting is "④": disabled.

What is shown on the display?:

- "④": LOGO! disables automatic S/W time conversion.
- "⑤" represents the start and end of European summertime.
- "⑥" represents the start and end of summertime in the United Kingdom.
- "⑦" represents the start and end of daylight saving time (summertime) in the United States prior to 2007.
- "⑧" represents the start and end of daylight saving time (summertime) in the United States in 2007 and later years.
- "⑨" represents the start and end of Australian summertime.
- "⑩" represents the start and end of Australian / Tasmanian summertime.
- "⑪" represents the start and end of New Zealand summertime.
- "⑫": Here you can enter any month, day and time zone difference.

The table below lists the preset conversions:

Menu command	Start of summertime	End of summertime	Time zone difference Δ
⑤	Last Sunday in March: 02:00→03:00	Last Sunday in October: 03:00→02:00	60 minutes
⑥	Last Sunday in March: 01:00→02:00	Last Sunday in October: 02:00→01:00	60 minutes
⑦	First Sunday in April: 02:00→03:00	Last Sunday in October: 02:00→01:00	60 minutes
⑧	Second Sunday in March: 02:00→03:00	First Sunday in November: 02:00→01:00	60 minutes
⑨	Last Sunday in October: 02:00→03:00	First Sunday in April: 03:00→02:00	60 minutes
⑩	First Sunday in October: 02:00→03:00	First Sunday in April: 03:00→02:00	60 minutes

Menu command	Start of summertime	End of summertime	Time zone difference $\Delta$
⑪	Last Sunday in September: 02:00→03:00	First Sunday in April: 03:00→02:00	60 minutes
⑫	Customized month and day; 02:00→02:00 + Time zone difference	Customized month and day; Time zone difference: 03:00→03:00 - Time zone difference	User-defined (resolution in minutes)

- To enable the summertime/winter time conversion and set parameters, press ▲ or ▼ to select the desired conversion and then press **OK** to confirm.

**Note**

You can specify a time zone difference  $\Delta$  between 0 and 180 minutes.

**Enabling/disabling automatic S/W Time conversion in parameter assignment mode**

If you want to enable/disable automatic S/W Time conversion in parameter assignment mode, select "①" in the parameter assignment menu, then menus "②" and "③". You can now enable/disable automatic S/W Time conversion.

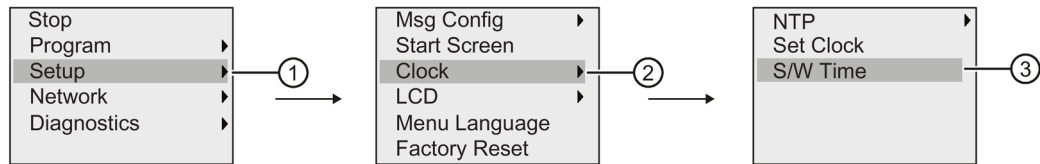

**User-defined parameters**

If none of the parameters/conversions apply to your country, follow these steps to customize the settings:

- Move the cursor to the menu item "①": Press ▲ or ▼ .

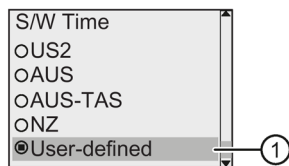

- Confirm with **OK** .

The display shows:

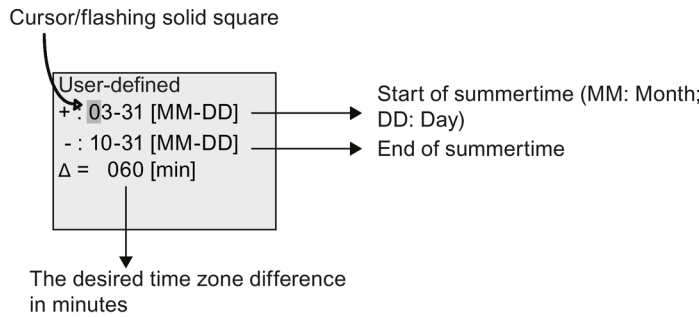

For example, consider an example where you want to configure the following parameters:

- Start of summertime = 31st March
- End of summertime = 1st November
- Time difference of 120 minutes

To configure these settings, follow these steps:

1. Press ◀ or ▶ to move the flashing solid square/cursor.
2. Press ▲ and ▼ to change the value at the cursor position.

The display shows:

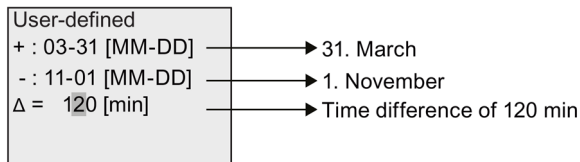

3. Confirm all your entries with **OK**.

You have now customized the summertime/wintertime conversion.

---

**Note**

Summertime/wintertime conversion only functions when LOGO! is operating in RUN or STOP mode. It does not function when the internal real-time clock of LOGO! continues operation after a power failure (refer to Section "Backup of the real-time clock (Page 144)").

---

### 3.8.16 Network Time Protocol (LOGO! 8.FS4 and later versions only)

Network Time Protocol(NTP) function is a new feature and supported in LOGO! 8.FS4 and later versions BM. It is used for network time synchronization.

The NTP contains three function settings:

- NTP Client

NTP Client is used for configuring the NTP function, LOGO! 8.FS4 BM can both serve as an NTP Server and an NTP Client at the same time. To make LOGO! BM synchronize time from the NTP Server, you need to set BM as NTP Client and configure its NTP Server IP first.



- NTP Server

NTP Server is only a reactor server. It can only provide the time passively while the broadcast function is disabled. LOGO! 8.FS4 can act as an NTP Server. When you enable it, LOGO! 8.FS4 works as a time provider for all standard NTP client, includes Windows/Linux NTP client, LOGO! 8.FS4 and so on.

- NTP Time Zone

NTP Client/Server can synchronize the time in different time zone, so we need to set NTP Time Zone in LOGO! for reference. NTP Time Zone is used for setting the local time zone in BM/TDE and LOGO!Soft Comfort. The default setting is GMT time zone.

The NTP function of LOGO! BM is disabled by default. You can enable it in the BM/TDE menu or LOGO!Soft Comfort.

### Configuring NTP in programming mode

To configure NTP function, follow these steps:

1. Switch LOGO! to programming mode. LOGO! displays the main menu.

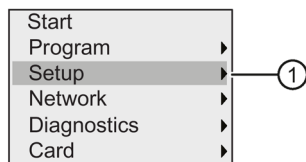

2. Select "①": Press ▲ or ▼ .
3. Confirm "①": Press **OK**.
4. Move the cursor to "②": Press ▲ or ▼ .

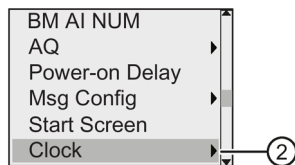

5. Confirm "②": Press **OK**.
6. Move the cursor to "③": Press ▲ or ▼ .

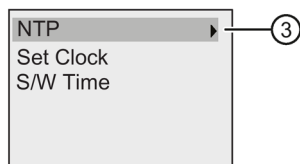

7. Apply "③": Press **OK**.
8. Then there are three options for selecting:

- **NTP Time Zone**

NTP Client/Server can synchronize the time in different time zone, you can provide a time zone in LOGO! 8.FS4 for NTP functions.

The default setting is GMT time zone, and you can change it to the real local time zone in BM/TDE and LOGO!Soft Comfort.

- **NTP Client**

To make LOGO! BM synchronize time from the NTP server, you need to set BM as NTP client and configure its NTP server IP first. Any standard NTP server can be used for LOGO! 8.FS4, such as the Windows/Linux NTP Server, standard time provider and LOGO! 8.FS4 itself.

**Note**

Siemens strongly recommends that you use NTP function at firewalls within Secure Network.

For detailed information about security functions on LOGO!, see Chapter Security (Page 310).

The NTP client is disabled by default, you can enable it in BM/TDE and LOGO!Soft Comfort.

To enable NTP Client function, follow these steps:

- Move the cursor to "④": Press ▲ or ▼.

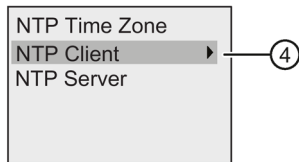

- Apply "④": Press **OK**.
- LOGO! shows the following display:

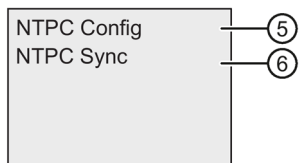

To enable NTP Client function, press ▲ or ▼ to select "⑤";

To identify whether the synchronization request success or failure, press ▲ or ▼ to select "⑥", and then confirm with **OK**. If the last synchronization is successful, the result panel in this menu item shows the last synchronize timestamp with a real time mode, otherwise a "not synchronized" is shown.

**Note**

The NTP client can synchronize time from NTP server every 4096 seconds, but it can synchronize the time immediately in the following scenarios:

- Base Module Power on
- Base Module from Stop to Run
- Server IP is changed
- Select "⑥"

- **NTP Server**

NTP server is only a reactor server. It can only provide the time passively while the broadcast function is disabled.

NTP server is disabled by default. you can enable it in BM/TDE or LOGO!Soft Comfort.

LOGO! 8.FS4 can act as an NTP server. When you enable it, LOGO! 8.FS4 works as a time provider for all standard NTP client, includes Windows/Linux NTP client, LOGO! 8.FS4 and so on.

### Configuring NTP in parameter assignment mode

If you want to configure NTP function in parameter assignment mode, select "①" in the parameter assignment menu , then menus "②" , "③" and "④ ". You can now enable NTP Client synchronization by selecting "⑤ ".

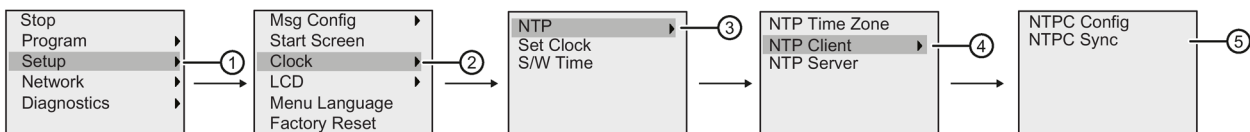

## 3.9 Configuring additional functions for LOGO!

After you have successfully created the second circuit program, you can configure additional functions by means of the following menu commands:

- Network
- Diagnostics

### UDF and Data Log

You can configure the UDF and Data Log functions only from LOGO!Soft Comfort. After you have configured them in LOGO!Soft Comfort and downloaded them to the LOGO! OBA8 device, you can then edit elements connected to these functions from the device:

- UDFs (User-Defined Functions)
- Data Log

### Network digital and analog I/O

You can configure the following connectors representing network digital or analog inputs/outputs only from LOGO!Soft Comfort:

- Network digital inputs
- Network analog inputs
- Network digital outputs
- Network analog outputs

---

**Note**

If your circuit program in a LOGO! OBA8 device contains any network digital or analog inputs/outputs, you can only edit the "Par" parameter of function blocks from LOGO!. You can not edit any of the rest of the circuit program from the device.

---

### 3.9.1 Configuring network settings

A LOGO! OBA8 device can establish network communication with other LOGO! OBA8 devices, SIMATIC S7 PLCs, a SIMATIC HMI, or a PC with LOGO!Soft Comfort V8.1 or later version (For more detailed information, refer to the Maximum LOGO! network setup (Page 32) topic). You can configure the LOGO! OBA8 network only from LOGO!Soft Comfort V8.1 or later version. From LOGO! OBA8, you can configure your LOGO!'s network settings including IP address, subnet mask and gateway.

---

**Note**

You can configure LOGO!'s network settings including IP address, subnet mask and gateway with the access level of administrator only. With the access level of operator, you can only view but cannot change the network settings.

For detailed information about Network security on LOGO!, see Chapter Security (Page 310).

---

### Configuring the network settings

LOGO! OBA8 provides a menu command for configuring network settings.

1. Switch LOGO! to programming mode.
2. Press ▲ or ▼ to move the cursor to "①".

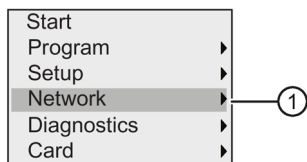

3. Press **OK** to confirm "①".

4. Press ▲ or ▼ to move the cursor to "②".

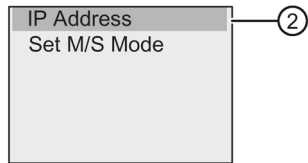

5. Press **OK** to confirm "②". LOGO! displays the following view:

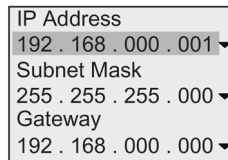

6. The display now shows the default IP address of your LOGO!. To change the setting, press **OK**. When the cursor appears in a flashing solid square, press ◀ or ▶ to move the cursor to a position where you want to modify the number, then press ▲ or ▼ to increase or decrease the number. To confirm your change, press **OK**.

---

#### Note

The default IP address for LOGO! OBA8: 192.168.000.001

The default IP address for LOGO! TDE: 192.168.000.002

The default IP address for LOGO! 8.FS4 and later version: 192.168.000.003

---

LOGO! stores up to four addresses that you set previously. To view your last settings, press ▶ to move the cursor to the "▼" symbol, and then press **OK** to open a drop-down list, for example:

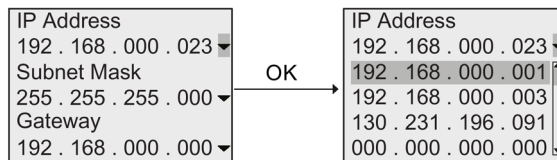

You can press ▲ or ▼ to select a previously configured address in the list, and then press **OK** to confirm.

7. Press ▲ or ▼ to move to the subnet mask setting. The default subnet mask is as shown above. To change the setting, press **OK**. When the cursor appears in a flashing solid square, press ◀ or ▶ to move the cursor to a position where you want to modify the number, then press ▲ or ▼ to increase or decrease the number. To confirm your change, press **OK**.
8. Press ▼ to move to the gateway address setting. The default gateway is as shown above. To change the setting, press **OK**. When the cursor appears in a flashing solid square, press ◀ or ▶ to move the cursor to a position where you want to modify the number, then press ▲ or ▼ to increase or decrease the number. To confirm your change, press **OK**.

## Transferring the circuit program to LOGO!Soft Comfort

After you have finished the network settings, you can transfer the circuit program from LOGO! to LOGO!Soft Comfort using the transfer command LOGO!→PC in LOGO!Soft Comfort. For further information on uploading the circuit program to LOGO!Soft Comfort with this transfer menu command, refer to *LOGO!Soft Comfort Online Help*.

### 3.9.2 Configuring a UDF (User-Defined Function)

You can configure UDF (User-Defined Function) blocks only from LOGO!Soft Comfort.

A UDF block is a preconfigured circuit program that you create in LOGO!Soft Comfort. You can add it to an existing circuit program as you do with a function block. For a detailed description of the UDF configuration in LOGO!Soft Comfort, refer to the Online Help for LOGO!Soft Comfort.

If your circuit program in LOGO! contains a UDF block, you can configure elements connected to the block. For more information of configuration of UDF elements from LOGO! 0BA8, refer to the topic UDF (User-Defined Function) (Page 280).

### 3.9.3 Configuring the Data Log

You can configure the Data Log block only from LOGO!Soft Comfort.

You can configure a maximum of one Data Log for your circuit program using LOGO!Soft Comfort. The Data Log is used to record process measurement variables of the selected function blocks. For a detailed description of configuration of the Data Log function in LOGO!Soft Comfort, refer to the Online Help for LOGO!Soft Comfort.

If your circuit program in LOGO! contains the Data Log block, you can configure elements connected to the block. For more information of configuration of Data Log elements from LOGO! 0BA8, refer to the topic Data log (Page 284).

### 3.9.4 Viewing network inputs/outputs

LOGO!Soft Comfort provides you with the following connectors representing network input/output blocks:

- Network digital inputs (identified with an **NI** in LOGO!)
- Network analog inputs (identified with an **NAI** in LOGO!)
- Network digital outputs (identified with an **NQ** in LOGO!)
- Network analog outputs (identified with an **NAQ** in LOGO!)

Network digital or analog inputs can connect with the inputs of function blocks. Network digital or analog outputs can connect with the outputs of function blocks.

If your circuit program contains a network digital/analog input, LOGO! can read a digital/analog value from another circuit program in a networked device. If your circuit

program contains a network digital/analog output, LOGO! can write its digital/analog output value to another networked OBA8 device in slave mode.

### Note

You can only configure these network connectors for your circuit program from LOGO!Soft Comfort. If your circuit program in LOGO! contains a network connector, you can not make any edits to the circuit program from the LOGO! onboard display.

## Viewing network connectors in LOGO!

Consider a circuit program where a network digital input NI1 connects to the function block B5. B5 is connected to Q4. To view this network input, follow these steps:

1. Switch LOGO! to programming mode.
2. Select "①": Press ▲ or ▼

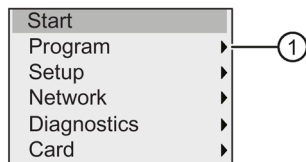

3. Confirm "①": Press **OK**
4. Select "②": Press ▲ or ▼

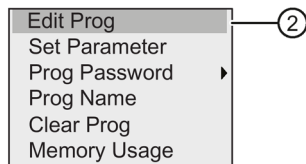

5. Confirm "②": Press **OK**  
(If required, enter your password and confirm with **OK**.)
6. Press **OK** in the circuit program window, and the cursor now appears as a solid square.
7. Move the cursor to the B5 block and then press **OK**. LOGO! shows the following display:

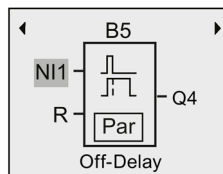

You can see that there is a network digital input NI1 connected at the first input of B5. The following views are examples of network digital and analog outputs in LOGO!:

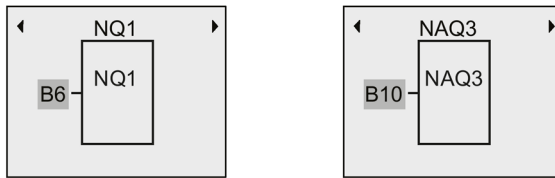

### Available network input/output blocks in LOGO!Soft Comfort

The following network I/O blocks are available for you to create your circuit program in LOGO!Soft Comfort:

- Network digital inputs: NI1 to NI64
- Network analog inputs: NAI1 to NAI32
- Network digital outputs: NQ1 to NQ64
- Network analog outputs: NAQ1 to NAQ16

### 3.9.5 Changing LOGO! to master/slave mode

LOGO! 0BA8 provides a menu command for network communication settings. This section shows you how to change LOGO!'s network communication mode.

A LOGO! 0BA8 device works in either **master** or **slave** communication mode.

#### Master mode versus slave mode

A LOGO! 0BA8 in master mode supports client-server communication with SIMATIC S7 PLCs, a SIMATIC HMI or other 0BA8 devices across Ethernet. This LOGO! can additionally act as a master to communicate with one or more 0BA8 devices in slave mode.

A LOGO! in slave mode functions as a LOGO! expansion module. LOGO! slave devices do not require a circuit program. A master LOGO! can read one or more slave LOGO!'s digital/analog input/output values and write its own digital/analog output values to these slaves. This helps LOGO! achieve network I/O expansion.

---

#### Note

A LOGO! in slave mode can also have its own expansion modules. It also supports a maximum of 24 digital inputs, 8 analog inputs, 20 digital outputs and 8 analog outputs.

---

#### Note

Change LOGO! to slave mode will enable the unsecure port 102 and 502-510.

---



## Changing LOGO! from master mode to slave mode

1. In the main menu in programming mode, move the cursor to "①": Press ▲ or ▼

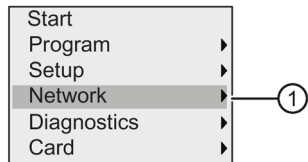

2. Confirm "①": Press **OK**
3. Move the cursor to "②": Press ▲ or ▼

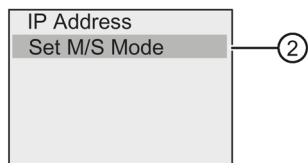

4. Confirm "②": Press **OK**
5. Move the cursor to "③": Press ▲ or ▼

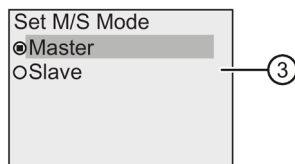

6. Confirm "③": Press **OK**

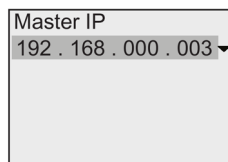

7. In this view, you enter the IP address of the LOGO! that you want to configure to be the master of your slave LOGO!. To change the setting, press **OK**. When the cursor appears in a flashing solid square, press ◀ or ▶ to move the cursor through the numbers. Press ▲ or ▼ to change the number.
8. Confirm the setting: Press **OK**

You have now successfully changed LOGO! from master mode to slave mode. LOGO! restarts automatically and then displays the main menu. Stepping into the following view, you can see that your LOGO! is now in slave mode:

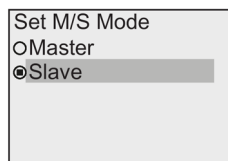

**Note**

When LOGO! is in slave mode, you can not edit the circuit program from the slave LOGO!.  
You cannot change LOGO! to master/slave mode in parameter assignment mode.

**Changing LOGO! from slave mode to master mode**

LOGO! is now in slave mode:

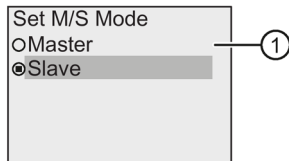

1. Move the cursor to "①": Press ▲ or ▼
2. Confirm "①": Press **OK**

You have now successfully changed LOGO! from slave mode to master mode. LOGO! restarts automatically and then displays the main menu.

Alternatively, you can change LOGO! from slave mode to master mode from LOGO!Soft Comfort. If you download a circuit program to a LOGO! in slave mode from LOGO!Soft Comfort, you are prompted to switch LOGO! to master mode to complete the downloading. For more information, refer to the Online Help for LOGO!Soft Comfort.

**3.9.6 Diagnosing errors from LOGO!**

LOGO! 0BA8 supports error event diagnostics. You can perform the following actions from LOGO!'s diagnostics menu:

- View software status and errors:
  - Data connection error
  - Firmware version of LOGO!
- View hardware status and errors:
  - Ethernet connection error
  - Micro SD card error (for example, card read/write error, card is not inserted, or card is full)
  - EM (expansion module) status and error (for example, bus error and configuration update)
  - MAC address of LOGO!
- View and clear the event log, and check the availability of a specific IP address
- View Cloud connection status, errors and the log for Cloud synchronization

- View the configured SMTP information and logs of mail sending failure
- Toggle an error event alert

### Viewing the software status and errors of LOGO!

To view the software status and errors, follow these steps:

1. In the main menu, move the cursor to "①": Press ▲ or ▼ .

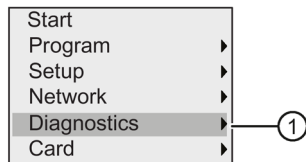

2. Confirm "①": Press OK .
3. LOGO! shows you the diagnostics menu. Move the cursor to "②": Press ▲ or ▼ .

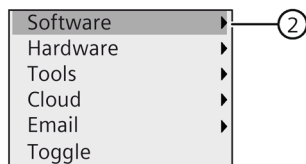

4. Confirm "②": Press OK. LOGO! shows you the following display:

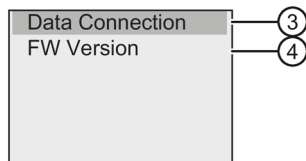

5. You can select "③" to view the real-time status of the S7 connection or Modbus connection. Select "④" to view the firmware version of LOGO!.

After you select "③", you can press ◀ or ▶ to view the status of each Data connection.

### Viewing the hardware status and errors of LOGO!

To view the hardware status and errors, follow these steps:

1. In the main menu, move the cursor to "①": Press ▲ or ▼ .

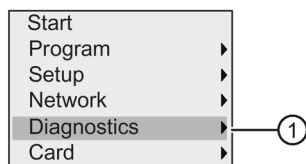

2. Confirm "①": Press OK.

- LOGO! shows you the diagnostics menu. Move the cursor to "②": Press ▲ or ▼ .

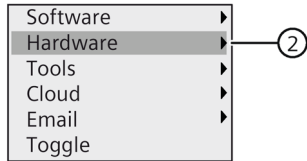

- Confirm "②": Press **OK**. LOGO! shows you the following display:

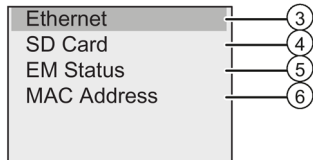

- You can select the following menu commands to view the corresponding hardware status and errors:
  - ③: To view the status of the Ethernet interface of LOGO!. If the Ethernet cable is not connected, an error appears.
  - ④: To view the status of the micro SD card. You may find an error event under this menu command when no card is inserted, the card is full, or a read/write error occurs.
  - ⑤: To view the real-time status of the connected expansion module(s). You can find the number of the expansion modules and the total I/O number under this menu command.
  - ⑥: To view the MAC address of LOGO!

## Viewing error information

To view the errors detected, follow these steps:

- In the diagnostics menu shown below, move the cursor to "①": Press ▲ or ▼ .

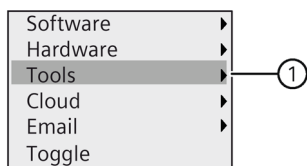

- Confirm "①": Press **OK** .
- Move the cursor to "②": Press ▲ or ▼ .

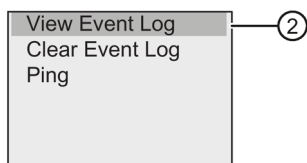

- Confirm "②": Press **OK**. LOGO! displays all errors detected. You can press ◀ or ▶ to view each error record. Press **ESC** or **OK** to return to the previous menus.

**Note****BM crash caused by a damaged circuit diagram**

If BM crashes by a damaged circuit diagram, BM will try to restart for four times at most. If BM still cannot work after these restarts, BM will:

- delete the error diagram in BM. If the diagram is loaded to BM by SD card, BM will also save the bin file in SD card as dmg file to avoid this error diagram being loaded to BM again.
- record this error in the event log

After BM deleted the error diagram, the screen of LOGO! Basic or the RUN/STOP LED for LOGO! Pure will flashes once every second in amber in next BM restarts. The flash stops when you do either of the following:

- Download a new diagram to BM.
- Switch off the power and then restart BM.

**Clearing error information**

To clear all errors, follow these steps:

1. In the diagnostics menu shown below, move the cursor to "①": Press ▲ or ▼ .

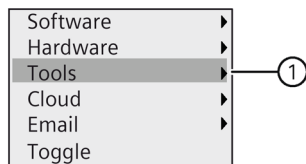

2. Confirm "①": Press OK .
3. Move the cursor to "②": Press ▲ or ▼ .

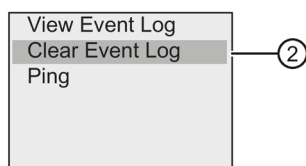

4. Confirm "②": Press OK .

5. Move the cursor to "③": Press ▲ or ▼ .

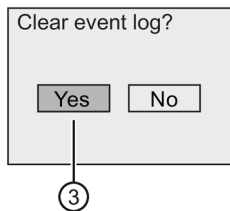

6. Confirm "③": Press **OK**. LOGO! clears all error messages and displays as follows:



### Diagnosing a specific IP address

You can check the availability of a specific IP address by following these steps:

1. In the diagnostics menu shown below, move the cursor to "①": Press ▲ or ▼ .

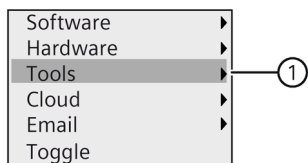

2. Confirm "①": Press **OK** .
3. Move the cursor to "②": Press ▲ or ▼ .

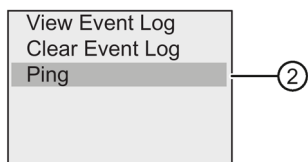

4. Confirm "②": Press **OK**. LOGO! displays the following view:

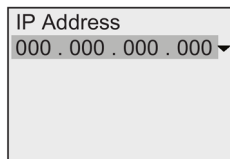

5. To enter an IP address, Press **OK**. When the cursor appears in a flashing solid square, press ◀ or ▶ to move the cursor to a position where you want to modify the number, then press ▲ or ▼ to increase or decrease the number.
6. Press **OK** to confirm your input.

LOGO! stores up to four addresses that you entered previously. To view your last inputs, press ▶ to move the cursor to the "▼" symbol, and then press **OK** to open a drop-down list, for example:

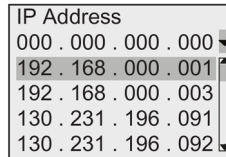

You can press ▲ or ▼ to select a previously configured address in the list, and then press **OK** to confirm.

## Viewing Cloud status

To view the Cloud status, follow these steps:

1. In the diagnostics menu shown below, move the cursor to "①": Press ▲ or ▼.

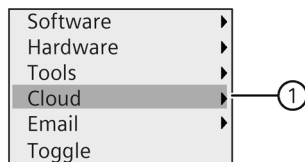

2. Confirm "①": Press **OK**.
3. Move the cursor to "②": Press ▲ or ▼.

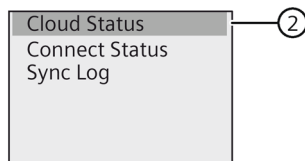

4. Confirm "②": Press **OK**. LOGO! displays the real-time Cloud status and Cloud configuration. Press **ESC** or **OK** to return to the previous menus.

## Viewing Cloud connection status

To view Cloud connection state, follow these steps:

1. In the diagnostics menu shown below, move the cursor to "①": Press ▲ or ▼.

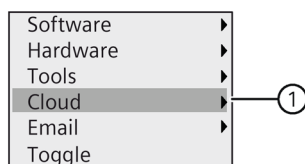

2. Confirm "①": Press **OK**.

3. Move the cursor to "②": Press ▲ or ▼.

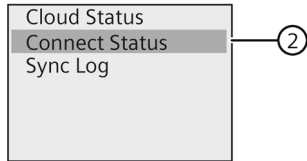

4. Confirm "②": Press **OK**.

If the connection state is **Error**, LOGO! displays specific error information. You can refer to Troubleshooting (Page 382) to try to fix connection error.

Press **ESC** or **OK** to return to the previous menus.

### Viewing the synchronization log

To view the synchronization log, follow these steps:

1. In the diagnostics menu shown below, move the cursor to "①": Press ▲ or ▼.

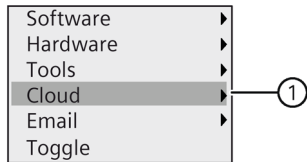

2. Confirm "①": Press **OK**.
3. Move the cursor to "②": Press ▲ or ▼.

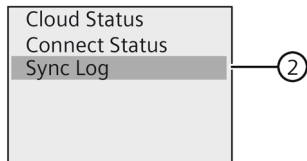

4. Confirm "②": Press **OK**.

### Viewing Email SMTP information

To view the configured Email SMTP information, follow these steps:

1. In the diagnostics menu shown below, move the cursor to "①": Press ▲ or ▼.

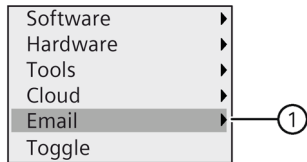

2. Confirm "①": Press **OK**.



3. Move the cursor to "②": Press ▲ or ▼ .

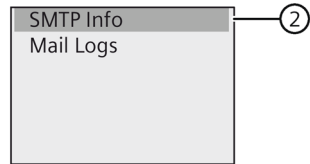

4. Confirm "②": Press OK.

## Viewing logs of email sending failure

To view logs of email sending failure, follow these steps:

1. In the diagnostics menu shown below, move the cursor to "①": Press ▲ or ▼ .

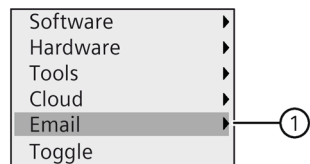

2. Confirm "①": Press OK.
3. Move the cursor to "②": Press ▲ or ▼ .

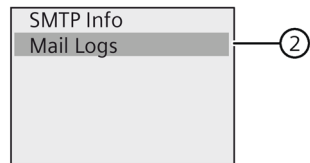

4. Confirm "②": Press OK.

LOGO! Base Module records the latest 16 logs. According to the fail cause displayed in the log, you can refer to Troubleshooting (Page 382) to try to fix email sending errors.

## Toggling an error alert

You can enable/disable an error alert by following these steps:

1. In the diagnostic menu shown below, move the cursor to "①": Press ▲ or ▼ .

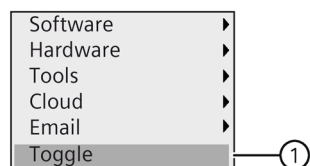

2. Confirm "①": Press OK .

- The circle with a dot indicates the current setting. To change the setting: Press ▲ or ▼ .

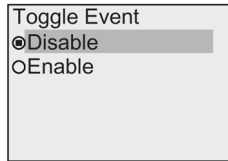

- Confirm your selection: Press **OK**. LOGO! returns to the previous view.

If you enable the error alert, when an error occurs, the LOGO! display turns to red backlight, reminding you that LOGO! detects an error. You can go to the diagnostics menu to view and clear the error.

## 3.10 Memory space and circuit program size

The size of a circuit program in LOGO! is limited by the memory space.

### Memory areas

- Program memory:**  
 LOGO! allows only a limited number of blocks in your circuit program. The second limitation is based on the maximum number of bytes a circuit program can contain. You can determine the total number of bytes used by adding up the number of bytes used for the relevant function blocks.
- Retentive memory (Rem):**  
 In this area, LOGO! stores values that are retentive; for example, the hours counter value. Blocks with optional retentivity use this memory area only if you have enabled the retentivity function.

### Resources available in LOGO!

A circuit program in LOGO! can occupy the following maximum resources:

LOGO! device series	Bytes	Blocks	REM
LOGO! 0BA8	8500	400	250

LOGO! monitors memory utilization, and offers only those functions from the lists for which it can actually provide sufficient memory space.

### Memory requirements

The table below shows an overview of the memory requirements for the basic and special function blocks in LOGO! 0BA8:

Function	Program memory	Rem memory*
<b>Basic functions</b>		
AND	12	-

Function	Program memory	Rem memory*
AND with edge evaluation	12	-
NAND (not AND)	12	-
NAND with edge evaluation	12	-
OR	12	-
NOR (not OR)	12	-
XOR (exclusive OR)	8	-
NOT (Negation)	8	-
<b>Special functions</b>		
Timers		
On-delay	12	3
Off-delay	16	3
On-/Off-delay	16	3
Retentive on-delay	16	3
Wiping relay (pulse output)	12	3
Edge triggered wiping relay	20	4
Asynchronous pulse generator	16	3
Random generator	16	-
Stairway lighting switch	16	3
Multiple function switch	20	3
Weekly timer	24	-
Yearly timer	12	-
Astronomical clock	40	-
Stopwatch	28	19
Counters		
Up/down counter	32	5
Hours counter	36	13
Threshold trigger	20	-
Analog		
Analog threshold trigger	20	-
Analog differential trigger	20	-
Analog comparator	24	-
Analog watchdog	24	-
Analog amplifier	12	-
Pulse Width Modulator (PWM)	32	-
Mathematic instruction	24	-
Mathematic instruction error detection	16	1
Analog multiplexer	20	-
Analog ramp	40	-
PI controller	44	2
Analog filter	20	-
Max/Min	20	7
Average value	32	20
Others		
Latching relay	12	1
Pulse relay	12	1

3.10 Memory space and circuit program size

Function	Program memory	Rem memory*
Message texts	12	-
Softkey	12	2
Shift register	16	1
Float/Integer Converter	20	-
Integer/Float Converter	24	-

\*: Bytes in the Rem memory area if you have enabled retentivity

**Note**

Since a UDF block is a preconfigured circuit program that you create from LOGO!Soft Comfort for your LOGO! device, the memory size (program memory and Rem memory) of a UDF block depends upon the size of the function blocks contained in the UDF.

**Utilization of memory areas**

LOGO! indicates that there is insufficient memory space by not allowing you to add a block to your circuit program. LOGO! offers you only the blocks for which it can provide sufficient memory space. If LOGO! memory space is insufficient to hold any additional blocks, the system denies access to the block list.

If memory space is full, optimize your circuit program or install another LOGO!.

**Calculating memory requirements**

When calculating the memory requirements of a circuit, you must always take into account all individual areas of memory.

**Example:**

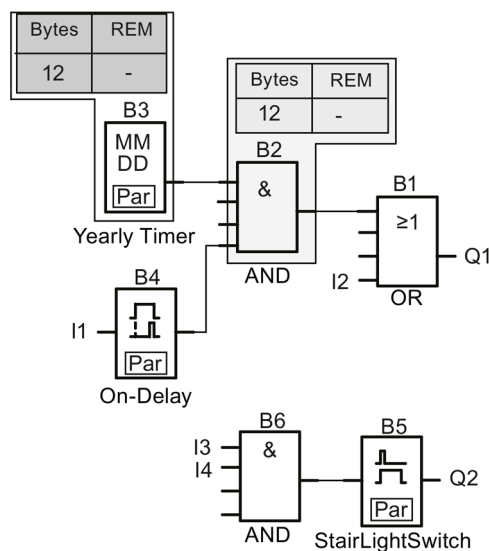

The sample circuit program contains:

Block no.	Function	Memory area		
		Bytes	Blocks	REM
B1	OR	12	1	-
B2	AND	12	1	-
B3	Yearly timer	12	1	-
B4	On-delay*	12	1	3
B5	Stairway lighting switch	16	1	3
B6	AND	12	1	-
	Resources used by the circuit program	76	6	6
	Memory space limits in LOGO!	8500	400	250
	<b>Still available in LOGO!</b>	<b>8424</b>	<b>394</b>	<b>244</b>

\*: Configured with retentivity.

This means that this circuit program fits in LOGO!.

### Indication of available memory space

To view the amount of free memory space in LOGO!, follow these steps:

1. Switch LOGO! to programming mode.  
(As a reminder, refer to the topic "The four golden rules for operating LOGO! (Page 70)".)
2. Move the cursor to "①": Press ▲ or ▼

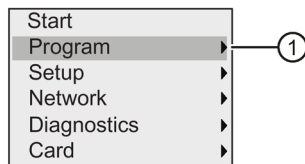

3. Confirm "①": Press **OK**
4. Move the cursor to "②": Press ▲ or ▼

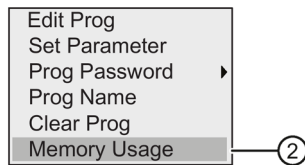

5. Confirm "②": Press **OK**

The display now shows:

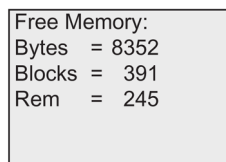

## LOGO! functions

LOGO! provides you with various elements in programming mode, and organizes them in the following lists:

- Connector list (Connector) (Page 130)
- ↓GF: List of the basic functions AND, OR, ... (Page 135)
- ↓SF: List of the special functions (Page 147)
- List of reusable blocks configured in the circuit program

LOGO! OBA8 can additionally provide you with the following elements in programming mode, if you have previously configured them in your circuit program using LOGO!Soft Comfort:

- UDF: List of user-defined function blocks configured in the circuit program
- L: A Data Log function block configured in the circuit program

### List contents

All lists show the elements available in LOGO!. Usually, this includes all connectors, basic functions, and special functions.

LOGO! does not show all elements if:

- You cannot add additional blocks.  
This occurs when the memory space is insufficient or when you have reached the maximum number of blocks.
- A specific block's memory space requirement (Page 126) would exceed the space available in LOGO!.
- You have created program elements in LOGO!Soft Comfort but have not downloaded the program to LOGO!.

## 4.1 Constants and connectors

Constants and connectors represent inputs, outputs, flags, constants, and network digital and analog inputs/outputs.

### Inputs

- **Digital inputs**  
Digital inputs begin with the letter **I**. The number of the digital inputs (I1, I2, ...) corresponds to the number of the input connectors of the LOGO! Base Module and of the connected digital modules, in the order of their installation. You can use the fast digital

inputs I3, I4, I5, and I6 of the LOGO! versions LOGO! 12/24 RCE, LOGO! 12/24 RCEo, LOGO! 24 CE and LOGO! 24 CEo as fast counters.

---

**Note**

To avoid that the LOGO! Base Module fails to read input signals because its built-in MCU (Microcontroller Unit) is too sensitive and runs much faster than those in previous LOGO! devices, an on-/off-delay function is designed for LOGO!:

- For LOGO! 230RCE and LOGO! 230RCEo, a 25 ms on-delay time and a 20 ms off-delay time are defined for digital inputs I1 to I8.
- For all the other LOGO! versions, a 5 ms on-delay time and a 5 ms off-delay time are defined for all the digital inputs.

Besides, when the LOGO! Base Module is in slave mode, a 5 ms on-delay time and a 100 ms signal-retentive-time are defined for all the digital inputs.

---

- **Analog inputs**

The LOGO! versions LOGO! 24 CE, LOGO! 24 CEo, LOGO! 12/24 RCE and LOGO! 12/24 RCEo have the inputs I1, I2, I7 and I8, which you can also program for use as **AI3**, **AI4**, **AI1** and **AI2** inputs. As described in topic "Setting the number of AIs in LOGO! (Page 298)", you can configure these modules to use either two analog inputs (AI1 and AI2), or all four. LOGO! interprets signals at the I1, I2, I7 and I8 inputs as digital values, and those at the AI3, AI4, AI1 and AI2 inputs as analog values. Note that AI3 corresponds to I1 and AI4 corresponds to I2. This numbering preserves the previous correspondence of AI1 to I7 and AI2 to I8 that was available with the OBA5 series. LOGO! numbers the inputs of a connected analog module according to the already existing analog inputs. See topic "Maximum setup with expansion modules (Page 34)" for example setups. In programming mode, when you select the input signal of a special function that takes an analog input, LOGO! offers the analog inputs AI1 to AI8, analog flags AM1 to AM64, analog outputs AQ1 to AQ8, and the block numbers of functions with analog outputs.

## Outputs

- **Digital outputs**

Digital outputs begin with the letter **Q**. The output numbers (Q1, Q2, ... Q20) correspond with the numbers of the output connectors at the LOGO! Base Module and with those of the expansion modules, in their order of installation.

LOGO! OBA8 also provides 64 blank outputs and identifies them with the letter **x**. You cannot reuse the blank outputs in a circuit program. The blank outputs differ from flags, for example, which you can reuse. A blank output, for example, is useful for the special function "Message texts" (Page 212), if only the message text is of significance to a circuit program.

- **Analog outputs**

Analog outputs begin with the letters **AQ**. Eight analog outputs are available, namely AQ1, AQ2,... AQ8. You can only connect an analog output with the analog input of a function, an analog flag AM or an analog output connector.

The following figure shows an example LOGO! configuration and the numbering of the inputs and outputs for the circuit program.

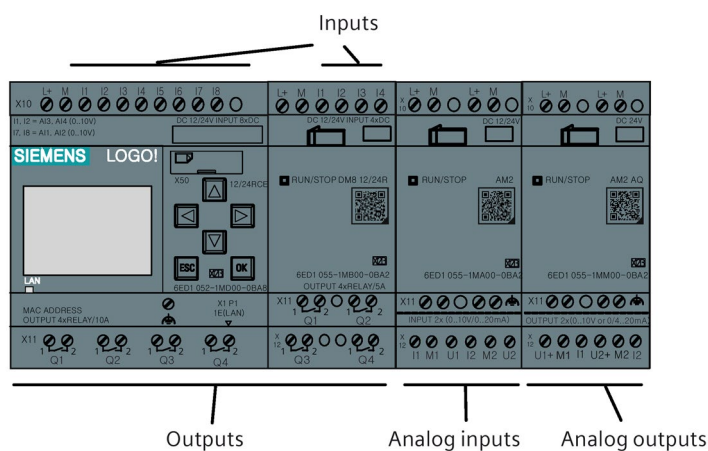

### Note

LOGO! OBA8 supports the graphical display of the analog value changes in the form of a trend curve on the onboard display. You can easily monitor each analog I/O in use by means of the trend curves when LOGO! is in RUN mode. For more information on how to view the trend curve, refer to "Viewing the analog changes (Page 89)".

## Flag blocks

The letters **M** or **AM** identify flag blocks. These are virtual outputs, which output the value of their inputs. LOGO! OBA8 provides 64 digital flags M1 to M64 and 64 analog flags AM1 to AM64.



## Startup flag M8

LOGO! sets flag M8 in the first cycle of the circuit program. You can thus use it as a startup flag in your circuit program. LOGO! resets M8 at the end of the first cycle.

You can use the M8 flag in all further cycles for setting, deletion and evaluation procedures in the same way as other flags.

## Backlight flags M25, M26, M28 to M31

The following flags control the backlight colors of the LOGO! onboard display or the LOGO! TDE:

Backlight display	Flag	Remarks
White	M25	The color white means LOGO! is in RUN mode.
	M26	The color white means LOGO! TDE is in RUN mode.
Amber	M28	The color amber means LOGO! is in programming mode or parameter assignment mode.
	M30	The color amber means LOGO! TDE is in programming mode, parameter assignment mode or TDE setting mode.
Red	M29	The color red means LOGO! has a diagnosis error.
	M31	The color red means LOGO! TDE has a diagnostics error.

**Note:** The backlight lifetime of the LOGO! TDE is 20,000 hours.

## Message text character set flag M27

The M27 flag selects between the two character sets that LOGO! uses to display message texts. State 0 corresponds to Character Set 1, and state 1 corresponds to Character Set 2. If M27=0 (low), LOGO! only displays message texts configured for Character Set 1; If M27=1 (high), LOGO! only displays message texts configured for Character Set 2. If you do not include M27 in the circuit program, message texts display in the character set that you selected from either LOGO!Soft Comfort or a LOGO! device.

### Note

- The output of the flag always carries the signal of the previous program cycle. This value does not change within the same program cycle.
- You can read or write flags from the network. If you have not added any special flags in the diagram, but written them from the network, they can still work except M27. So if you want to control character sets by M27, you must add it in the diagram first, and you can connect M27 to NI blocks to control it from the network.

### Shift register bits

LOGO! provides read-only shift register bits S1.1 to S4.8. Only the "Shift register" (Page 224) special function can modify shift register bit values.

### Cursor keys

Up to four cursor keys are available to you, namely C ▲, C ►, C ▼ and C ◀ ("C" = "Cursor"). Cursor keys are programmed for the circuit program in the same way as other inputs. You can program cursor keys in the corresponding display while the system is in RUN (Page 89) , and in an active message text (ESC + Key). Cursor keys can save switches and inputs, and allow operator control of the circuit program. Cursor key inputs from the LOGO! TDE are identical to cursor key inputs from the LOGO! Base Module.

### LOGO! TDE function keys

The LOGO! TDE has four function keys, F1, F2, F3, and F4, which you can use in your circuit program. You program these keys in the same way as other inputs. Like the cursor keys, you can press these keys when LOGO! is in RUN mode to affect the behavior of the circuit program, and to save switches and inputs.

### Levels

Voltage levels are designated **hi** and **lo**. A constant "1" = hi or "0" = lo status at the block can be set by means of a permanent voltage level or constant value hi or lo.

### Open connectors

LOGO! uses the letter **x** to indicate unused block connectors.

### Network inputs/outputs (available only if configured from LOGO!Soft Comfort)

You can configure the following network inputs/outputs only from LOGO!Soft Comfort. If the circuit program in LOGO! contains a network digital/analog I/O, you can not edit any of the rest of the circuit program except for the Par parameter. To edit the rest of the program, you must upload the program to LOGO!Soft Comfort and then edit from LOGO!Soft Comfort.

#### 1) Network digital inputs

The letters **NI** identify a network digital input. There are 64 digital network digital inputs NI1 to NI64 available for configuration in the circuit program from LOGO!Soft Comfort.

#### 2) Network analog inputs

The letters **NAI** identify a network analog input. There are 32 network analog inputs NAI1 to NAI32 available for configuration in the circuit program from LOGO!Soft Comfort.

### 3) Network digital outputs

The letters **NQ** identify a network digital output . There are 64 network digital outputs NQ1 to NQ64 available for configuration in the circuit program from LOGO!Soft Comfort.

### 4) Network analog outputs

The letters **NAQ** identify a network analog output. There are 16 network analog outputs NAQ1 to NAQ16 available for configuration in the circuit program from LOGO!Soft Comfort.

## 4.2 Basic functions list - GF

Basic functions represent simple logical elements of Boolean algebra.

You can invert the inputs of individual basic functions, that is, the circuit program inverts a logical "1" at a relevant input to a logical "0"; if "0" is the value at the input, the program sets a logical "1". See the programming example at Circuit program input (Page 79).

The GF list contains the basic function blocks you can use for your circuit program. The following basic functions are available:

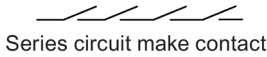
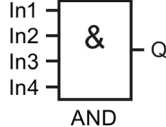
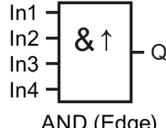
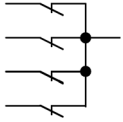
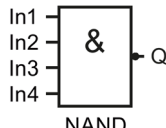
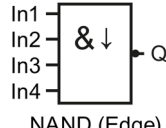
View in the circuit diagram	View in LOGO!	Name of the basic function
 <p>Series circuit make contact</p>	 <p>AND</p>	AND (Page 136)
	 <p>AND (Edge)</p>	AND with edge evaluation (Page 137)
 <p>Parallel circuit with break contacts</p>	 <p>NAND</p>	NAND (Page 138) (not AND)
	 <p>NAND (Edge)</p>	NAND with edge evaluation (Page 138)

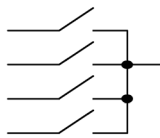
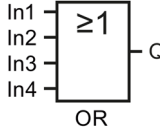
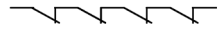
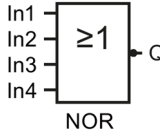
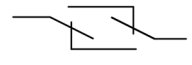
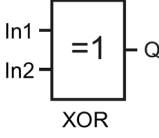
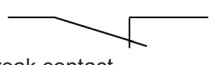
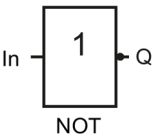
View in the circuit diagram	View in LOGO!	Name of the basic function
 <p>Parallel circuit with make contacts</p>	 <p>OR</p>	OR (Page 139)
 <p>Series circuit with break contacts</p>	 <p>NOR</p>	NOR (Page 140) (not OR)
 <p>Double changeover contact</p>	 <p>XOR</p>	XOR (Page 141) (exclusive OR)
 <p>Break contact</p>	 <p>NOT</p>	NOT (Page 141) (negation, inverter)

### 4.2.1 AND

Circuit diagram of a series circuit with several make contacts:

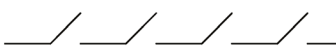

Symbol in LOGO!:

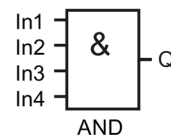

The output of the AND is only 1 if **all** inputs are 1, that is, all contacts are closed.

At an unused block input (x): x = 1.

#### AND function logic table

1	2	3	4	Q
0	0	0	0	0
0	0	0	1	0
0	0	1	0	0
0	0	1	1	0
0	1	0	0	0

1	2	3	4	Q
0	1	0	1	0
0	1	1	0	0
0	1	1	1	0
1	0	0	0	0
1	0	0	1	0
1	0	1	0	0
1	0	1	1	0
1	1	0	0	0
1	1	0	1	0
1	1	1	0	0
1	1	1	1	1

### 4.2.2 AND with edge evaluation

Symbol in LOGO!:

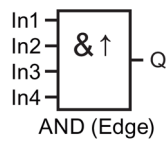

The output of an edge-triggered AND is only 1 if **all** inputs are 1 and if **at least one** input was low in the previous cycle.

At an unused block input (x): x = 1.

### Timing diagram for the AND with edge evaluation

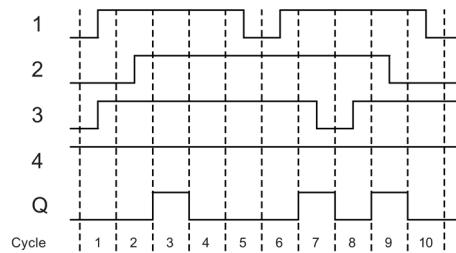

### 4.2.3 NAND (not AND)

Parallel circuit with multiple break contacts in the circuit diagram:

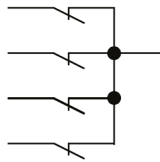

Symbol in LOGO!:

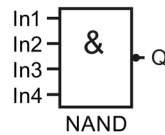

The output of the NAND is only 0 if the status at **all** inputs is 1, that is, the contacts are closed.

At an unused block input (x):  $x = 1$ .

#### NAND function logic table

1	2	3	4	Q
0	0	0	0	1
0	0	0	1	1
0	0	1	0	1
0	0	1	1	1
0	1	0	0	1
0	1	0	1	1
0	1	1	0	1
0	1	1	1	1
1	0	0	0	1
1	0	0	1	1
1	0	1	0	1
1	0	1	1	1
1	1	0	0	1
1	1	0	1	1
1	1	1	0	1
1	1	1	1	0

### 4.2.4 NAND with edge evaluation

Symbol in LOGO!:

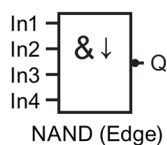

The output status of the NAND with edge evaluation is only 1 if **at least one** input is 0 and if **all** inputs were 1 in the previous cycle.

At an unused block input (x):  $x = 1$ .

### Timing diagram for the NAND with edge evaluation

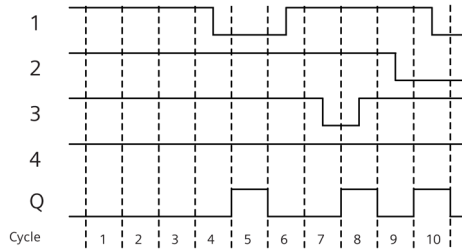

### 4.2.5 OR

Circuit diagram of a parallel circuit with several make contacts:

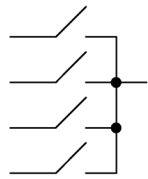

Symbol in LOGO!:

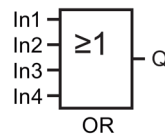

The output status of the OR element is only 1 if **at least one** input is 1, that is, at least one of the contacts is closed.

At an unused block input (x):  $x = 0$ .

### OR function logic table

1	2	3	4	Q
0	0	0	0	0
0	0	0	1	1
0	0	1	0	1
0	0	1	1	1
0	1	0	0	1
0	1	0	1	1
0	1	1	0	1
0	1	1	1	1
1	0	0	0	1
1	0	0	1	1
1	0	1	0	1
1	0	1	1	1
1	1	0	0	1
1	1	0	1	1

1	2	3	4	Q
1	1	1	0	1
1	1	1	1	1

### 4.2.6 NOR (not OR)

Circuit diagram of a series circuit with several break contacts:

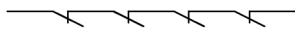

Symbol in LOGO!:

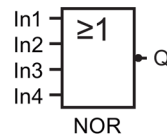

The output status of the NOR is only 1 if **all** inputs are 0, that is, off. The NOR output is set to 0 when one of the inputs is on (logical 1 status).

At an unused block input (x): x = 0.

### NOR function logic table

1	2	3	4	Q
0	0	0	0	1
0	0	0	1	0
0	0	1	0	0
0	0	1	1	0
0	1	0	0	0
0	1	0	1	0
0	1	1	0	0
0	1	1	1	0
1	0	0	0	0
1	0	0	1	0
1	0	1	0	0
1	0	1	1	0
1	1	0	0	0
1	1	0	1	0
1	1	1	0	0
1	1	1	1	0



### 4.2.7 XOR (exclusive OR)

The XOR in a circuit diagram, shown as series circuit with 2 changeover contacts:

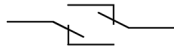

Symbol in LOGO!:

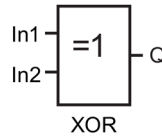

The output status of the XOR is 1 if the inputs are **not equivalent**.

At an unused block input (x):  $x = 0$ .

#### XOR function logic table

1	2	Q
0	0	0
0	1	1
1	0	1
1	1	0

### 4.2.8 NOT (Negation, Inverter)

A break contact in the circuit diagram:

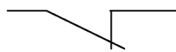

Symbol in LOGO!:

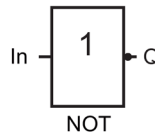

The output status is 1 if the input is 0. The NOT block inverts the input status.

An advantage of the NOT block, for example, is that you do not have to use break contacts. You simply use a make contact and the NOT block to convert these into a break contact.

#### NOT function logic table

1	Q
0	1
1	0

## 4.3 Special functions

Because of their different input designation, you can see right away that there is a difference between the special functions and basic functions. Special functions (SFs) contain timer functions, retentive functions and various parameter assignment options, which allow you to adapt the circuit program to suit your own requirements.

This section provides you with a brief overview of input designations and with some particular background information on SFs (Page 147).

### 4.3.1 Designation of the inputs

#### Logical inputs

The following connectors enable you to create a logical link to other blocks or to the inputs of the LOGO! unit:

- **S (Set):**  
A signal at input S sets the output to logical "1".
- **R (Reset):**  
The reset input R takes priority over all other inputs and resets the outputs.
- **Trg (Trigger):**  
This input triggers the start of a function.
- **Cnt (Count):**  
This input counts pulses.
- **Fre (Frequency):**  
LOGO! applies frequency signals to be evaluated to this input.
- **Dir (Direction):**  
This input determines the direction, + or -.
- **En (Enable):**  
This input enables a block function. When this input is "0", the block ignores all other signals.
- **Inv (Invert):**  
A signal at this input inverts the output signal of the block.
- **Ral (Reset all):**  
A signal at this input resets all internal values.
- **Lap (for the stopwatch function)**  
A signal at this input pauses the stopwatch.

---

#### Note

Unused logical inputs of special functions default to logical "0".

---

### Connector X at SF inputs

The connector "x" input for any SF input is low. That is, the input carries a "lo" signal.

### Parameter inputs

At some of the inputs you do not apply any signals. You configure the relevant block values instead. Examples:

- **Par (Parameter):**  
You do not connect the Par parameter. Instead, you set the relevant block parameters (times, on/off thresholds etc.).
- **Priority:**  
This is an open input. Here, you define priorities and specify whether a message is to be acknowledged in RUN.

## 4.3.2 Time response

### Parameter T

You can configure a time value T for some of the SF blocks. When you preset this time, note that your input values are based on the timebase set:

Timebase	__ : __
s (seconds)	seconds : $\frac{1}{100}$ seconds
m (minutes)	minutes : seconds
h (hours)	hours : minutes

B6     1/1 +/ T =04:10h	Setting a time T of 250 minutes: Unit in hours h: 04:00 hours     240 minutes 00:10 hours     +10 minutes =                    250 minutes
----------------------------	--

The LOGO! OBA8-specific stopwatch (Page 183) function provides an additional timebase - 10 ms.

### Accuracy of T

Because of slight tolerances in the characteristics of electronic components, the set time T can deviate. You can find a detailed description of such deviations in the "On-delay" topic (Page 152).

### Accuracy of the timer (weekly/yearly timer)

To prevent timing inaccuracy of the real-time clock in C versions (LOGO! devices with an integrated real-time clock) caused by this deviation, LOGO! continuously compares the timer value to a high-precision timebase and makes continual corrections. The resultant maximum timing inaccuracy is  $\pm 2$  s/day.

### 4.3.3 Backup of the real-time clock

The supercapacitor in LOGO! backs up the internal real-time clock, making the real-time clock continue operation after a power failure. The surrounding temperature influences the backup time. At a surrounding temperature of 25°C, the typical backup time of a LOGO! 0BA8 is 20 days. It takes 30 minutes to get the supercapacitor fully charged after the LOGO! is powered up, and the fully charged supercapacitor can support typical 20-day backup time.

If there is a power outage of a LOGO! for more than 20 days, on restarting, the internal clock is back in the status that it was in before the power outage.

### 4.3.4 Retentivity

You can set the switching states, counter and time values of many SF blocks (Page 147) to be retentive. This means that LOGO! retains current data values after a power failure, and that the block resumes operation at the break point. The timer is not reset, but resumes operation until the time-to-go has expired.

To enable this response, however, the relevant functions must be set retentive. Two options are available:

R: The data is retentive.

/: Current data is not retentive (default). See the section in topic "Second circuit program (Page 93)" on enabling and disabling retentivity.

The hours counter, weekly timer, yearly timer and PI controller are always retentive.

### 4.3.5 Parameter protection

In the parameter protection settings, you can determine whether or not you display and edit the parameters in LOGO! parameter assignment mode. Two options are available:

- +: The parameter attribute permits read/write access in parameter assignment mode (default).
- : The parameter settings are read–/write–protected in parameter assignment mode, and you can only edit them in programming mode. See the parameter protection mode example in the Second circuit program (Page 93).

#### Note

Parameter protection covers only the "Set Parameter" window. If you embed variables of protected special functions in a message text, the variables are still editable from the message text. To protect these variables, you must also activate the protection of the message text.

### 4.3.6 Calculating the gain and offset of analog values

A sensor is connected to the analog input and converts a process variable into an electrical signal. This value of signal lies within the typical range of this sensor.

LOGO! always converts the electrical signals at the analog input into digital values from 0 to 1000.

LOGO! internally transforms a voltage of 0 V to 10 V at input AI to a range of values from 0 to 1000. LOGO! interprets an input voltage exceeding 10 V as internal value 1000.

Because you cannot always process the range of values from 0 to 1000 as predetermined by LOGO!, you can multiply the digital values by a gain factor and then shift the zero of the range of values (offset). This allows you to output an analog value to the LOGO! onboard display that is proportional to the actual process variable.

Parameter	Minimum	Maximum
Input voltage (in V)	0	≥ 10
Internal value	0	1000
Gain	-10.00	+10.00
Offset	-10000	+10000

#### Mathematical rule

*Actual value Ax* =  
(internal value at input Ax • gain) + offset

#### Gain and offset calculation

LOGO! calculates the gain and offset based on the relevant high and low values of the function.

Example 1:

The available thermocouples have the following technical data: -30 °C to +70 °C, 0 to 10 VDC (that is, 0 to 1000 in LOGO!).

*Actual value* = (internal value • gain) + offset, thus

4.3 Special functions

$-30 = (0 \cdot A) + B$ , that is, offset  $B = -30$

$+70 = (1000 \cdot A) - 30$ , that is, gain  $A = 0.1$

Example 2:

A pressure sensor converts a pressure of 1000 mbar into a voltage of 0 V, and a pressure of 5000 mbar into a voltage of 10 V.

*Actual value* = (internal value • gain) + offset, thus

$1000 = (0 \cdot A) + B$ , that is, offset  $B = 1000$

$5000 = (1000 \cdot A) + 1000$ , that is, gain  $A = 4$

**Example of analog values**

Process variable	Voltage (V)	Internal value	Gain	Offset	Value shown (Ax)
-30 °C	0	0	0.1	-30	-30
0 °C	3	300	0.1	-30	0
+70 °C	10	1000	0.1	-30	70
1000 mbar	0	0	4	1000	1000
3700 mbar	6.75	675	4	1000	3700
5000 mbar	10	1000	4	1000	5000
	0	0	0.01	0	0
	5	500	0.01	0	5
	10	1000	0.01	0	10
	0	0	1	0	0
	5	500	1	0	500
	10	1000	1	0	1000
	0	0	10	0	0
	5	500	10	0	5000
	10	1000	10	0	10000
	0	0	0.01	5	5
	5	500	0.01	5	10
	10	1000	0.01	5	15
	0	0	1	500	500
	5	500	1	500	1000
	10	1000	1	500	1500
	0	0	1	-200	-200
	5	500	1	-200	300
	10	1000	1	-200	800
	0	0	10	-10000	-10000
	10	1000	10	-10000	0
	0.02	2	0.01	0	0
	0.02	2	0.1	0	0
	0.02	2	1	0	2
	0.02	2	10	0	20

For further information on a sample application, refer to the "Analog comparator (Page 201)" topic.

For further information on analog inputs, refer to the Constants and connectors (Page 130) topic.

## 4.4 Special functions list - SF



When you create your circuit program in LOGO!, you find the special function blocks in the SF list.

You can invert the inputs of SFs individually, that is, the circuit program converts a logical "1" at the input into a logical "0"; a logical "0" it converts into a logical "1". See the programming example in topic "Circuit program input (Page 79)".

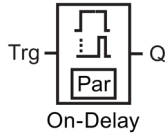
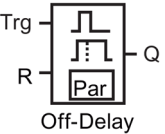
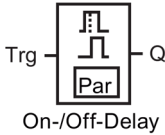
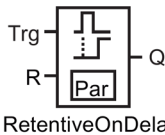
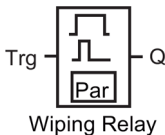
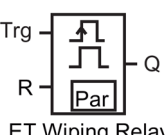

The table also specifies whether the relevant function can be set retentive (Rem). The following SFs are available:

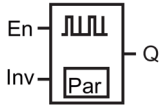
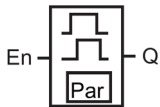
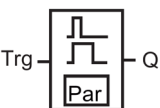
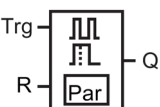
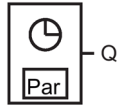
View in LOGO!	Name of the special function	Rem
<b>Timers</b>		
 <p>On-Delay</p>	On-delay (Page 152)	REM
 <p>Off-Delay</p>	Off-delay (Page 155)	REM
 <p>On-/Off-Delay</p>	On-/off-delay (Page 157)	REM
 <p>RetentiveOnDelay</p>	Retentive on-delay (Page 159)	REM
 <p>Wiping Relay</p>	Wiping relay (pulse output) (Page 160)	REM
 <p>ET Wiping Relay</p>	Edge-triggered wiping relay (Page 162)	REM

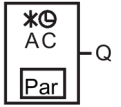
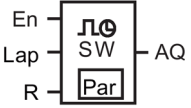
4.4 Special functions list - SF

View in LOGO!	Name of the special function	Rem
 <p>Async. Pulse</p>	Asynchronous pulse generator (Page 164)	REM
 <p>Random Generator</p>	Random generator (Page 166)	
 <p>StairLightSwitch</p>	Stairway lighting switch (Page 168)	REM
 <p>MultiFunc.Switch</p>	Multiple function switch (Page 170)	REM
 <p>Weekly Timer</p>	Weekly timer (Page 173)	
 <p>Yearly Timer</p>	Yearly timer (Page 176)	
 <p>Astron. Clock</p>	Astronomical clock (Page 181)	
 <p>Stopwatch</p>	Stopwatch (Page 183)	
<b>Counter</b>		

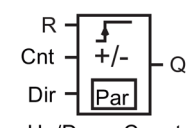
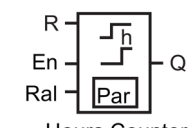
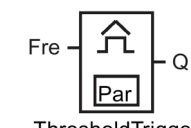
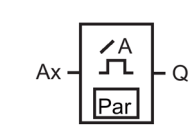
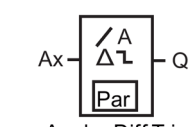
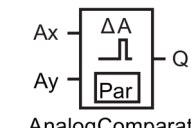

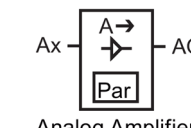
View in LOGO!	Name of the special function	Rem
 <p>Up/Down Counter</p>	Up/down counter (Page 186)	REM
 <p>Hours Counter</p>	Hours counter (Page 189)	REM
 <p>ThresholdTrigger</p>	Threshold trigger (Page 193)	
<b>Analog</b>		
 <p>AnalogThres.Trig</p>	Analog threshold trigger (Page 196)	
 <p>AnalogDiff.Trig</p>	Analog differential trigger (Page 199)	
 <p>AnalogComparator</p>	Analog comparator (Page 201)	
 <p>Analog Watchdog</p>	Analog watchdog (Page 205)	
 <p>Analog Amplifier</p>	Analog amplifier (Page 208)	

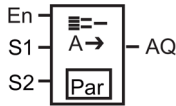
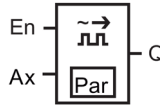
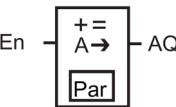
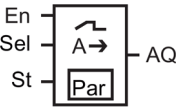
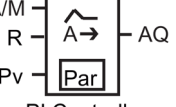
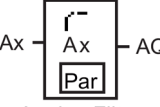
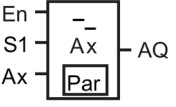
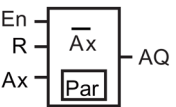
View in LOGO!	Name of the special function	Rem
 <p>Analog MUX</p>	Analog multiplexer (Page 226)	
 <p>PWM</p>	Pulse width modulator (PWM) (Page 236)	
 <p>MATH</p>	Mathematic instruction (Page 239)	
 <p>Analog Ramp</p>	Analog ramp (Page 228)	
 <p>PI Controller</p>	PI controller (Page 232)	REM
 <p>Analog Filter</p>	Analog filter (Page 244)	
 <p>Max/Min</p>	Max/Min (Page 246)	REM
 <p>Average Value</p>	Average value (Page 249)	REM
<b>Miscellaneous</b>		

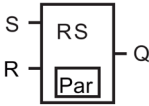
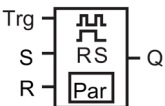
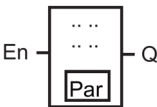
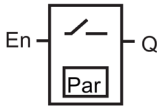
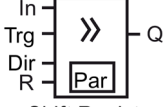
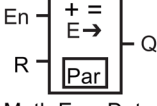
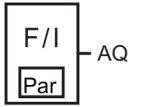
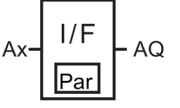
View in LOGO!	Name of the special function	Rem
 <p>Latching Relay</p>	Latching relay (Page 210)	REM
 <p>Pulse Relay</p>	Pulse relay (Page 211)	REM
 <p>Message Text</p>	Message texts (Page 212)	
 <p>Softkey</p>	Softkey (Page 222)	REM
 <p>Shift Register</p>	Shift register (Page 224)	REM
 <p>Math.ErrorDetect</p>	Mathematic instruction error detection (Page 242)	
 <p>FIConverter</p>	Float/Integer Converter (Page 251)	
 <p>IFConverter</p>	Integer/Float Converter (Page 253)	

### 4.4.1 On-delay

#### Short description

The output is only set after a configurable on-delay time expires.

Symbol in LOGO!	Wiring	Description
<p>Trg — [Symbol] — Q On-Delay</p>	Input Trg	A signal at input Trg (Trigger) triggers the on-delay timer.
	Parameter	T represents the time after which the output is on (0 to 1 transition of the output signal). Retentivity: / = no retentivity R = the status is retentive.
	Output Q	Q is on when the set time T expires, provided Trg is still set.

#### Parameter T

Note the defaults for parameter T in topic Time response (Page 143).

The actual value of another already-configured functions can provide the time for parameter T. You can use the actual values of the following functions for the value of T:

- Analog comparator (Page 201)(actual value Ax - Ay)
- Analog threshold trigger (Page 196)(actual value Ax)
- Analog amplifier (Page 208)(actual value Ax)
- Analog multiplexer (Page 226)(actual value AQ)
- Analog ramp (Page 228)(actual value AQ)
- Mathematic instruction (Page 239) (actual value AQ)
- PI controller (Page 232)(actual value AQ)
- Up/down counter (Page 186)(actual value Cnt)
- Analog filter (Page 244) (actual value AQ)
- Average value (Page 249) (actual value AQ)
- Max/Min (Page 246) (actual value AQ)
- On-delay (current time Ta)
- Off-delay (Page 155)(current time Ta)
- On-/off-delay (Page 157)(current time Ta)
- Retentive on-delay (Page 159)(current time Ta)
- Wiping relay (pulse output) (Page 160)(current time Ta)
- Edge-triggered wiping relay (Page 162)(current time Ta)
- Asynchronous pulse generator (Page 164)(current time Ta)
- Stairway lighting switch (Page 168)(current time Ta)

- Multiple function switch (Page 170)(current time Ta)
- Stopwatch (Page 183)(actual value AQ)
- Threshold trigger (Page 193) (actual value Fre)

Select the required function by the block number. The timebase is configurable.

### Valid ranges of the timebase, if T = parameter

Note the following characteristics of timebase values.

Timebase	max. value	min. resolution	Accuracy
s (seconds)	99:99	10 ms	+ 10 ms
m (minutes)	99:59	1s	+ 1 s
h (hours)	99:59	1 min	+ 1 min

The parameter T initially appears as follows in programming mode, for example:

```

B12      1/1 +R
T =04:10h
```

### Valid ranges of the timebase

If an already-programmed function provides the value of T, the valid ranges of the timebase are as follows:

Timebase	max. value	Meaning	Accuracy
ms	99990	Number of ms	+ 10 ms
s	5999	Number of s	+ 1 s
m	5999	Number of min	+ 1 min

The LOGO! display appears as follows in programming mode, if you have, for example, set the actual value of B6 in seconds to parameter T of B12:

```

B12      1/1 +R
T →B006s
```

If the referenced block (B6, in the example) returns a value that lies out of the valid range, LOGO! rounds the value up or down to the next valid value.

### Parameter preset = Actual value of an already-programmed function

To include the actual value of an already-programmed function for parameter T, follow these steps:

1. Press ► to move the cursor to the equal sign of parameter T.

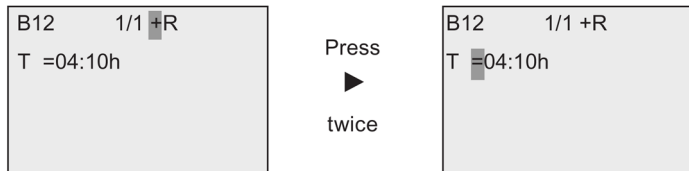

2. Press ▼ to change the equal sign into an arrow. LOGO! displays the last referenced block if it exists.

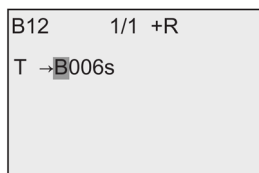

3. Press ► to move the cursor to the "B" of the shown block, and then press ▼ to select the required block number.
4. Press ► to move the cursor to the block's timebase and press ▼ to select the required timebase.

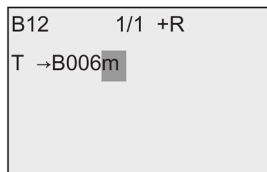

The view in parameter assignment mode appears as follows, for example:

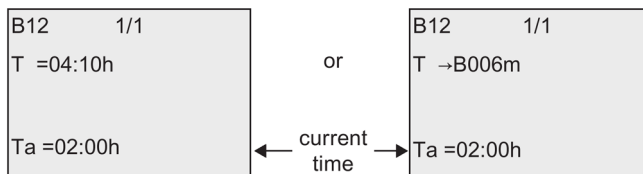

### Timing diagram

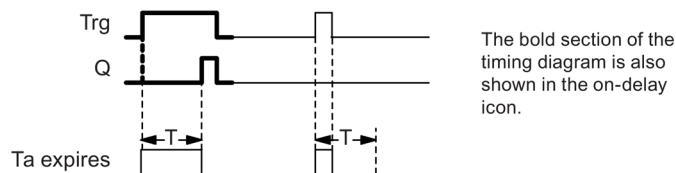

### Functional description

A 0 to 1 transition triggers the time  $T_a$  at input Trg ( $T_a$  is the current LOGO! time).

If the status of input Trg is 1 at least for the duration of the configured time T, LOGO! sets the output to 1 on expiration of this time (the output follows the input with on-delay).

LOGO! resets the time when the status at input Trg returns to 0 before the time T expires.

LOGO! resets the output to 0 when the signal at input Trg is 0.

If the block is retentive, LOGO! resets output Q and the expired time to the values before a power failure; if the block is not retentive, LOGO! resets output Q and the expired time to defaults after a power failure.

## 4.4.2 Off-delay

### Short description

When an off-delay is set, the output is reset when the configured time has expired.

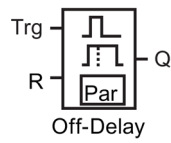
Symbol in LOGO!	Wiring	Description
 <p>Trg R Par Off-Delay Q</p>	Input Trg	The off-delay timer starts with a negative edge (1 to 0 transition) at input Trg (Trigger)
	Input R	A signal at input R resets the on-delay time and the output.
	Parameter	The output switches off (transitions from 1 to 0) when the delay time T expires. Retentivity: I = No retentivity R = The status is retentive.
	Output Q	A signal at input Trg sets Q. Q holds this state until T expires.

### Parameter T

Note the parameter T defaults specified in topic Time response (Page 143).

The actual value of another already-configured functions can provide the time for parameter T. You can use the actual value of the following functions:

- Analog comparator (Page 201) (actual value Ax - Ay)
- Analog threshold trigger (Page 196) (actual value Ax)
- Analog amplifier (Page 208) (actual value Ax)
- Analog multiplexer (Page 226) (actual value AQ)
- Analog ramp (Page 228) (actual value AQ)
- Mathematic instruction (Page 239) (actual value AQ)
- PI controller (Page 232) (actual value AQ)
- Up/down counter (Page 186) (actual value Cnt)
- Analog filter (Page 244) (actual value AQ)
- Average value (Page 249) (actual value AQ)

- Max/Min (Page 246) (actual value AQ)
- On-delay (Page 152) (current time  $T_a$ )
- Off-delay (current time  $T_a$ )
- On/off-delay (Page 157) (current time  $T_a$ )
- Retentive on-delay (Page 159) (current time  $T_a$ )
- Wiping relay (pulse output) (Page 160) (current time  $T_a$ )
- Edge-triggered wiping relay (Page 162) (current time  $T_a$ )
- Asynchronous pulse generator (Page 164) (current time  $T_a$ )
- Stairway lighting switch (Page 168) (current time  $T_a$ )
- Multiple function switch (Page 170) (current time  $T_a$ )
- Stopwatch (Page 183) (actual value AQ)
- Threshold trigger (Page 193) (actual value  $F_{re}$ )

Select the required function by the block number. The timebase is configurable. For information on valid timebase ranges and parameter preset, refer to Section "On-delay (Page 152)".

### Timing diagram

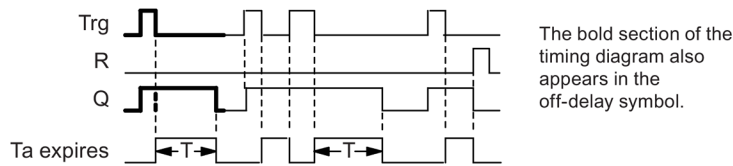

### Functional description

LOGO! sets Output Q to hi immediately when the input Trg changes to hi.

LOGO! retriggers the actual time  $T_a$  at the 1 to 0 transition of Trg. The output remains set. LOGO! resets Output Q to 0 with off-delay when  $T_a$  reaches the value configured at T ( $T_a=T$ ).

LOGO! retriggers the time  $T_a$  with a one-shot at input Trg.

You can set input R (Reset) to reset the time  $T_a$  and the output before  $T_a$  expires.

If the block is retentive, LOGO! resets output Q and the expired time to the values before a power failure; if the block is not retentive, LOGO! resets output Q and the expired time to defaults after a power failure.



### 4.4.3 On-/off-delay

#### Short description

The on-/off-delay function sets the output after the set on-delay time has expired, and resets it upon expiration of the off-delay time.

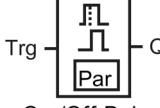
Symbol in LOGO!	Wiring	Description
 <p>On-/Off-Delay</p>	Input Trg	A positive edge (0 to 1 transition) at input Trg (Trigger) triggers the on-delay time $T_H$ . A negative edge (1 to 0 transition) at input Trg (Trigger) triggers the off-delay time $T_L$ .
	Parameter	$T_H$ is the time after which the output is set hi (output signal transition 0 to 1). $T_L$ is the time after which the output is reset ( output signal transition 1 to 0). Retentivity: / = No retentivity R = The status is retentive.
	Output Q	LOGO! sets Q when the configured time $T_H$ expires and Trg is still set. LOGO! resets Q when $T_L$ expires, if the trigger Trg has not been set.

#### Parameters $T_H$ and $T_L$

Note the preset values for the parameters  $T_H$  and  $T_L$  in topic Time response (Page 143).

The actual value of another, already-configured function can provide the on-delay and off-delay times for parameters  $T_H$  and  $T_L$ . You can use the actual values of the following functions:

- Analog comparator (Page 201)(actual value Ax - Ay)
- Analog threshold trigger (Page 196)(actual value Ax)
- Analog amplifier (Page 208)(actual value Ax)
- Analog multiplexer (Page 226)(actual value AQ)
- Analog ramp (Page 228)(actual value AQ)
- Mathematic instruction (Page 239) (actual value AQ)
- PI controller (Page 232)(actual value AQ)
- Up/down counter (Page 186)(actual value Cnt)
- Analog filter (Page 244) (actual value AQ)
- Average value (Page 249) (actual value AQ)
- Max/Min (Page 246) (actual value AQ)
- On-delay (Page 152)(current time Ta)
- Off-delay (Page 155)(current time Ta)
- On-/off-delay (current time Ta)

- Retentive on-delay (Page 159)(current time  $T_a$ )
- Wiping relay (pulse output) (Page 160)(current time  $T_a$ )
- Edge-triggered wiping relay (Page 162)(current time  $T_a$ )
- Asynchronous pulse generator (Page 164)(current time  $T_a$ )
- Stairway lighting switch (Page 168)(current time  $T_a$ )
- Multiple function switch (Page 170)(current time  $T_a$ )
- Stopwatch (Page 183)(actual value  $AQ$ )
- Threshold trigger (Page 193) (actual value  $Fre$ )

Select the required function by the block number. The timebase is configurable. For information on valid timebase ranges and parameter preset, refer to Section "On-delay (Page 152)".

### Timing diagram

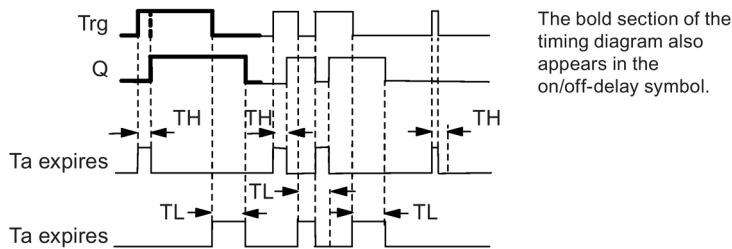

### Functional description

The time  $T_H$  is triggered with a 0 to 1 transition at input  $Trg$ .

If the status at input  $Trg$  is 1 at least for the duration of the time  $T_H$ , LOGO! sets the output to 1 on expiration of the time  $T_H$  (the output follows the input with on-delay).

LOGO! resets the time when LOGO! resets the signal at input  $Trg$  to 0 before the time  $T_H$  expires.

A 1 to 0 transition at input  $Trg$  triggers the time  $T_L$ .

If the status at input  $Trg$  is 0 at least for the duration of the signal  $T_L$ , LOGO! sets the output to 0 on expiration of the time  $T_L$  (the output follows the input with off-delay).

LOGO! resets the time when the signal at input  $Trg$  changes to 1 again before the time  $T_L$  expires.

If the block is retentive, LOGO! resets output  $Q$  and the expired time to the values before a power failure; if the block is not retentive, LOGO! resets output  $Q$  and the expired time to defaults after a power failure.

## 4.4.4 Retentive on-delay

### Short description

A one-shot at the input triggers a configurable on-delay time. The output is set when this time has expired.

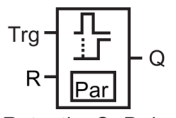
Symbol in LOGO!	Wiring	Description
 <p>RetentiveOnDelay</p>	Input Trg	A signal at input Trg (Trigger) triggers the on-delay timer.
	Input R	A signal at input R resets the on-delay time and the output.
	Parameter	T represents the on-delay time for the output (output status transition 0 to 1). Retentivity: / = no retentivity R = The status is retentive.
	Output Q	LOGO! sets output Q after the time T expires.

### Parameter T

Note the defaults specified in topic Time response (Page 143).

The actual value of another already-programmed function can provide the time for parameter T. You can use the actual values of the following functions:

- Analog comparator (Page 201)(actual value Ax – Ay)
- Analog threshold trigger (Page 196)(actual value Ax)
- Analog amplifier (Page 208)(actual value Ax)
- Analog multiplexer (Page 226)(actual value AQ)
- Analog ramp (Page 228)(actual value AQ)
- Mathematic instruction (Page 239) (actual value AQ)
- PI controller (Page 232)(actual value AQ)
- Up/down counter (Page 186)(actual value Cnt)
- Analog filter (Page 244) (actual value AQ)
- Average value (Page 249) (actual value AQ)
- Max/Min (Page 246) (actual value AQ)
- On-delay (Page 152)(current time Ta)
- Off-delay (Page 155)(current time Ta)
- On-/off-delay (Page 157)(current time Ta)
- Retentive on-delay (current time Ta)
- Wiping relay (pulse output) (Page 160)(current time Ta)
- Edge-triggered wiping relay (Page 162)(current time Ta)

- Asynchronous pulse generator (Page 164)(current time  $T_a$ )
- Stairway lighting switch (Page 168)(current time  $T_a$ )
- Multiple function switch (Page 170)(current time  $T_a$ )
- Stopwatch (Page 183)(actual value  $AQ$ )
- Threshold trigger (Page 193) (actual value  $Fre$ )

Select the required function by the block number. The timebase is configurable. For information on valid ranges and parameter defaults, refer to Section "On-delay (Page 152)".

### Timing diagram

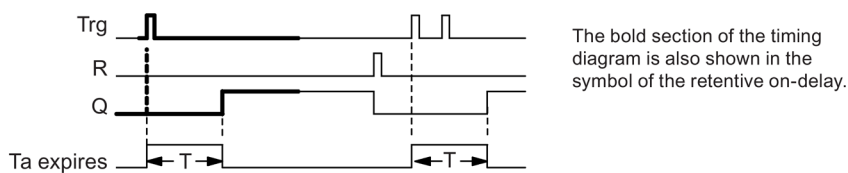

### Functional description

The 0 to 1 signal transition at input Trg triggers the current time  $T_a$ . LOGO! sets output Q when  $T_a = T$ . A further signal at input Trg does not influence the time  $T_a$ .

LOGO! resets the output and the time  $T_a$  with the next 1 signal at input R.

If the block is retentive, LOGO! resets output Q and the expired time to the values before a power failure; if the block is not retentive, LOGO! resets output Q and the expired time to defaults after a power failure.

### 4.4.5 Wiping relay (pulse output)

#### Short description

An input signal generates a signal with a configurable period at the output.

Symbol in LOGO!	Wiring	Description
	Input Trg	A signal at input Trg (Trigger) triggers the time for the wiping relay function.
	Parameter	The output is switched off after the time T has expired (output signal transition 1 to 0). Retentivity: / = No retentivity R = The status is retentive.
	Output Q	A signal at input Trg sets Q. If the input signal = 1, output Q remains set for the time $T_a$ .

## Parameter T

Note the information on parameter T in topic Time response (Page 143).

The actual value of another already-programmed function can provide the time for parameter T. You can use the actual values of the following functions:

- Analog comparator (Page 201)(actual value Ax – Ay)
- Analog threshold trigger (Page 196)(actual value Ax)
- Analog amplifier (Page 208)(actual value Ax)
- Analog multiplexer (Page 226)(actual value AQ)
- Analog ramp (Page 228)(actual value AQ)
- Mathematic instruction (Page 239) (actual value AQ)
- PI controller (Page 232)(actual value AQ)
- Up/down counter (Page 186)(actual value Cnt)
- Analog filter (Page 244) (actual value AQ)
- Average value (Page 249) (actual value AQ)
- Max/Min (Page 246) (actual value AQ)
- On-delay (Page 152)(current time Ta)
- Off-delay (Page 155)(current time Ta)
- On-/off-delay (Page 157)(current time Ta)
- Retentive on-delay (Page 159)(current time Ta)
- Wiping relay (pulse output) (current time Ta)
- Edge-triggered wiping relay (Page 162)(current time Ta)
- Asynchronous pulse generator (Page 164)(current time Ta)
- Stairway lighting switch (Page 168)(current time Ta)
- Multiple function switch (Page 170)(current time Ta)
- Stopwatch (Page 183)(actual value AQ)
- Threshold trigger (Page 193) (actual value Fre)

Select the required function by the block number. The timebase is configurable. For information on valid ranges and parameter defaults, refer to Section "On-delay (Page 152)".

## Timing diagram

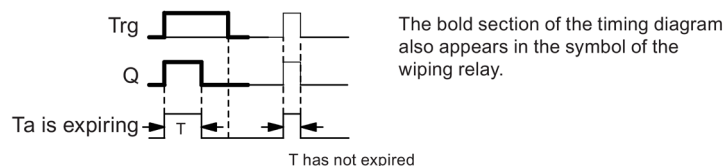

### Functional description

A 0 to 1 transition at input Trg sets the output, and triggers a time  $T_a$  during which the output remains set.

LOGO! resets output Q to lo (pulse output) when  $T_a$  reaches the value preset at T ( $T_a = T$ ).

LOGO! sets the output immediately if there is a 1 to 0 transition at input Trg before the specified time expires.

If the block is retentive, LOGO! resets output Q and the expired time to the values before a power failure; if the block is not retentive, LOGO! resets output Q and the expired time to defaults after a power failure.

### 4.4.6 Edge-triggered wiping relay

#### Short description

An input pulse generates a preset number of output pulses with a defined pulse/pause ratio (retriggerable), after a configured delay time has expired.

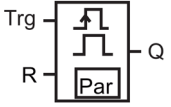
Symbol in LOGO!	Wiring	Description
 <p>ET Wiping Relay</p>	Input Trg	A signal at input Trg (Trigger) triggers the times for the edge triggered wiping relay.
	Input R	A signal at input R resets the current time ( $T_a$ ) and the output.
	Parameter	The interpulse width $T_L$ and the pulse width $T_H$ are configurable. N determines the number of pulse/pause cycles $T_L/T_H$ : Range of values: 1...9 Retentivity: I = No retentivity R = The status is retentive.
	Output Q	Q is set after $T_L$ expires, and reset after $T_H$ expires.

#### Parameters $T_H$ and $T_L$

Note the information on parameter T in topic Time response (Page 143).

The actual value of another already-programmed function can provide the pulse width  $T_H$  and the interpulse width  $T_L$ . You can use the actual values of the following functions:

- Analog comparator (Page 201) (actual value  $A_x - A_y$ )
- Analog threshold trigger (Page 196) (actual value  $A_x$ )
- Analog amplifier (Page 208) (actual value  $A_x$ )
- Analog multiplexer (Page 226) (actual value  $A_Q$ )
- Analog ramp (Page 228) (actual value  $A_Q$ )
- Mathematic instruction (Page 239) (actual value  $A_Q$ )
- PI controller (Page 232) (actual value  $A_Q$ )

- Up/down counter (Page 186) (actual value Cnt)
- Analog filter (Page 244) (actual value AQ)
- Average value (Page 249) (actual value AQ)
- Max/Min (Page 246) (actual value AQ)
- On-delay (Page 152) (current time Ta)
- Off-delay (Page 155) (current time Ta)
- On-/off-delay (Page 157) (current time Ta)
- Retentive on-delay (Page 159) (current time Ta)
- Wiping relay(pulse output) (Page 160) (current time Ta)
- Edge triggered wiping relay (current time Ta)
- Asynchronous pulse generator (Page 164) (current time Ta)
- Stairway light switch (Page 168) (current time Ta)
- Multiple function switch (Page 170) (current time Ta)
- Stopwatch (Page 183) (actual value AQ)
- Threshold trigger (Page 193) (actual value Fre)

Select the required function by the block number. The timebase is configurable. For information on valid ranges and parameter defaults, refer to the On-delay (Page 152) topic.

### Timing diagram A

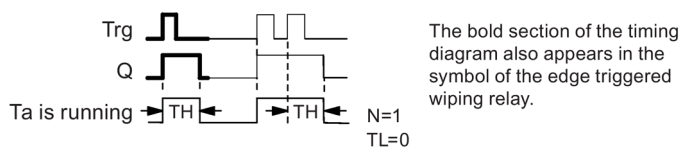

### Timing diagram B

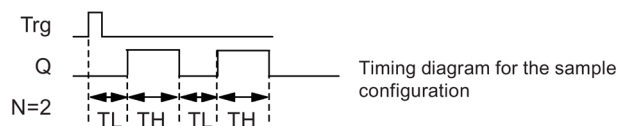

### Functional description

A 0 to 1 transition at input Trg triggers the time  $T_L$  (Time Low). After the time  $T_L$  has expired, output Q is set for the duration of  $T_H$  (Time High).

If there is a further 0 to 1 transition (retriggering pulse) at input Trg before the preset time ( $T_L + T_H$ ) has expired,  $T_a$  is reset and the pulse/pause cycle is restarted.

If the block is retentive, LOGO! resets output Q and the expired time to the values before a power failure; if the block is not retentive, LOGO! resets output Q and the expired time to defaults after a power failure.

### Setting the Par parameter

View in programming mode (example):

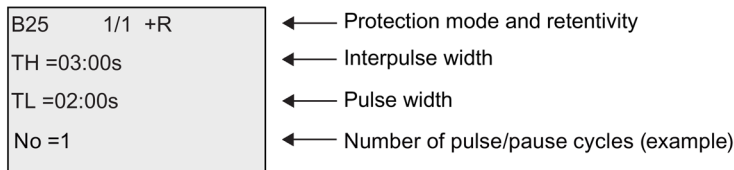

View in parameter assignment mode (example):

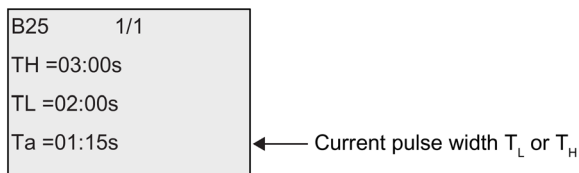

## 4.4.7 Asynchronous pulse generator

### Short description

You can asynchronously output pulses with this function.

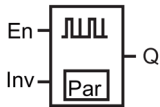
Symbol in LOGO!	Wiring	Description
 <p>En</p> <p>Inv</p> <p>Par</p> <p>Async. Pulse</p> <p>Q</p>	Input En	You can use input EN to set and reset the asynchronous pulse generator.
	Input Inv	You can use input Inv to invert the output signal of the active asynchronous pulse generator.
	Parameter	You can configure the pulse width $T_H$ and the inter-pulse width $T_L$ . Retentivity: / = No retentivity R = The status is retentive.
	Output Q	The pulse and pause values cyclically set and reset Q.

### Parameters TH and TL

Note the information on parameter T in topic Time response (Page 143)



The actual value of another already-programmed function can provide the pulse width TH and the interpulse width TL. You can use the actual values of the following functions:

- Analog comparator (Page 201) (actual value Ax – Ay)
- Analog threshold trigger (Page 196) (actual value Ax)
- Analog amplifier (Page 208) (actual value Ax)
- Analog multiplexer (Page 226) (actual value AQ)
- Analog ramp (Page 228) (actual value AQ)
- Mathematic instruction (Page 239) (actual value AQ)
- PI controller (Page 232) (actual value AQ)
- Up/down counter (Page 186) (actual value Cnt)
- Analog filter (Page 244) (actual value AQ)
- Average value (Page 249) (actual value AQ)
- Max/Min (Page 246) (actual value AQ)
- On-delay (Page 152) (current time Ta)
- Off-delay (Page 155) (current time Ta)
- On-/off-delay (Page 157) (current time Ta)
- Retentive on-delay (Page 159) (current time Ta)
- Wiping relay(pulse output) (Page 160) (current time Ta)
- Edge triggered wiping relay (Page 162) (current time Ta)
- Asynchronous pulse generator (current time Ta)
- Stairway light switch (Page 168) (current time Ta)
- Multiple function switch (Page 170) (current time Ta)
- Stopwatch (Page 183) (actual value AQ)
- Threshold trigger (Page 193) (actual value Fre)

Select the required function by the block number. The timebase is configurable. For information on valid ranges and parameter defaults, refer to the On-delay (Page 152) topic.

## Timing diagram

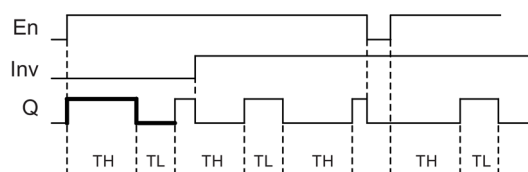

## Functional description

You can configure the pulse/interpulse width at the TH (Time High) and TL (Time Low) parameters.

Input Inv can be used to invert the output signal, provided the block is enabled with a signal at input EN.

If the block is retentive, LOGO! resets output Q and the expired time to the values before a power failure; if the block is not retentive, LOGO! resets output Q and the expired time to defaults after a power failure.

#### 4.4.8 Random generator

##### Short description

The random generator function sets an output randomly within a configured time.

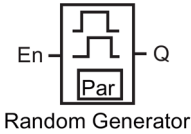
Symbol in LOGO!	Wiring	Description
	Input En	<p>A positive edge ( 0 to 1 transition) at input En (Enable) triggers the on-delay time of the random generator.</p> <p>A negative edge ( 1 to 0 transition) at input En (Enable) triggers the off-delay time of the random generator.</p>
	Parameter	<p>LOGO! sets the on-delay at random to a value between 0 s and <math>T_H</math>.</p> <p>The off-delay is set at random to a value between 0 s and <math>T_L</math>.</p>
	Output Q	<p>LOGO! sets output Q when the on-delay expires and if En is still set. LOGO! resets Q when the off-delay expires, provided LOGO! has not set En again meanwhile.</p>

##### Parameter $T_H$ and $T_L$

Note the defaults of the  $T_H$  and  $T_L$  parameters listed in topic Time response (Page 143).

The actual value of another already-programmed function can provide the on-delay time  $T_H$  and the off-delay time  $T_L$ . You can use the actual values of the following functions:

- Analog comparator (Page 201) (actual value  $A_x - A_y$ )
- Analog threshold trigger (Page 196) (actual value  $A_x$ )
- Analog amplifier (Page 208) (actual value  $A_x$ )
- Analog multiplexer (Page 226) (actual value  $A_Q$ )
- Analog ramp (Page 228) (actual value  $A_Q$ )
- Mathematic instruction (Page 239) (actual value  $A_Q$ )
- PI controller (Page 232) (actual value  $A_Q$ )
- Up/down counter (Page 186) (actual value Cnt)
- Analog filter (Page 244) (actual value  $A_Q$ )
- Average value (Page 249) (actual value  $A_Q$ )

- Max/Min (Page 246) (actual value AQ)
- On-delay (Page 152) (current time Ta)
- Off-delay (Page 155) (current time Ta)
- On-/off-delay (Page 157) (current time Ta)
- Retentive on-delay (Page 159) (current time Ta)
- Wiping relay(pulse output) (Page 160) (current time Ta)
- Edge triggered wiping relay (Page 162) (current time Ta)
- Asynchronous pulse generator (Page 164) (current time Ta)
- Stairway light switch (Page 168) (current time Ta)
- Multiple function switch (Page 170) (current time Ta)
- Stopwatch (Page 183) (actual value AQ)
- Threshold trigger (Page 193) (actual value Fre)

Select the required function by the block number. The timebase is configurable. For information on valid ranges and parameter defaults, refer to the On-delay (Page 152) topic.

## Timing diagram

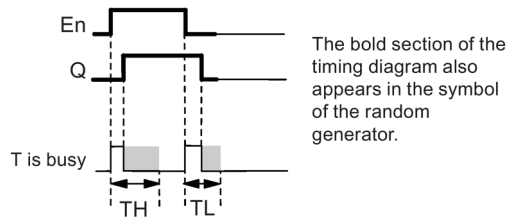

## Functional description

The 0 to 1 transition at input En triggers a random on-delay time between 0 s and  $T_H$ . The output is set when the on-delay time expires and if the signal at input En remains hi at least for the duration of this time.

The time is reset if input En is reset before the on-delay time has expired.

A 1 to 0 transition at input EN triggers a random off-delay time between 0 s and  $T_L$ .

LOGO! resets the output after the off-delay time expires, provided input En remains lo at least for the duration of this time.

LOGO! resets the time if the signal at input En changes to 1 again before the off-delay time expires.

If the block is retentive, LOGO! resets output Q and the expired time to the values before a power failure; if the block is not retentive, LOGO! resets output Q and the expired time to defaults after a power failure.

### 4.4.9 Stairway lighting switch

#### Short description

An input edge triggers a configurable and retriggerable time. LOGO! resets the output after this time expires. LOGO! can optionally output a warning signal to warn of the impending time expiration.

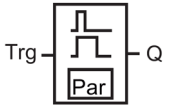
Symbol in LOGO!	Wiring	Description
 <p>Trg — Q StairLightSwitch</p>	Input Trg	A signal at input Trg (Trigger) triggers the off-delay time for the stairway lighting switch.
	Parameter	T represents the off-delay time of the output (output signal transition 1 to 0). T <sub>I</sub> determines the triggering time for the pre-warning. T <sub>IL</sub> determines the length of the pre-warning signal. Retentivity: / = No retentivity R = The status is retentive.
	Output Q	LOGO! resets Q after the time T expires. LOGO! outputs a warning signal before this time expires.

#### Parameter T, T<sub>I</sub> and T<sub>IL</sub>

Note the defaults of the T parameters listed in topic Time response (Page 143).

The actual value of another already-programmed function can provide the off-delay time T, the pre-warning time T<sub>I</sub> and the pre-warning period T<sub>IL</sub>. You can use the actual values of the following functions:

- Analog comparator (Page 201) (actual value Ax – Ay)
- Analog threshold trigger (Page 196) (actual value Ax)
- Analog amplifier (Page 208) (actual value Ax)
- Analog multiplexer (Page 226) (actual value AQ)
- Analog ramp (Page 228) (actual value AQ)
- Mathematic instruction (Page 239) (actual value AQ)
- PI controller (Page 232) (actual value AQ)
- Up/down counter (Page 186) (actual value Cnt)
- Analog filter (Page 244) (actual value AQ)
- Average value (Page 249) (actual value AQ)
- Max/Min (Page 246) (actual value AQ)
- On-delay (Page 152) (current time Ta)
- Off-delay (Page 155) (current time Ta)
- On-/off-delay (Page 157) (current time Ta)
- Retentive on-delay (Page 159) (current time Ta)

- Wiping relay(pulse output) (Page 160) (current time  $T_a$ )
- Edge triggered wiping relay (Page 162) (current time  $T_a$ )
- Asynchronous pulse generator (Page 164) (current time  $T_a$ )
- Stairway lightswitch (current time  $T_a$ )
- Multiple function switch (Page 170) (current time  $T_a$ )
- Stopwatch (Page 183) (actual value  $AQ$ )
- Threshold trigger (Page 193) (actual value  $Fre$ )

Select the required function by the block number. The timebase is configurable. For information on valid ranges and parameter defaults, refer to the On-delay (Page 152) topic.

### Timing diagram

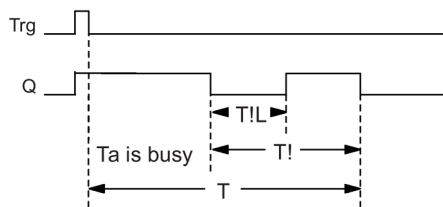

### Functional description

A 0 to 1 signal transition at input Trg sets output Q. The next 1 to 0 transition at Trg retriggers the current time  $T_a$ , and output Q remains set.

LOGO! resets output Q when  $T_a = T$ . You can output a warning signal before the off-delay time  $(T - T_i)$  expires to reset Q for the time of the pre-warning period  $T_{iL}$ .

A further one-shot at input Trg during  $T_a$  retriggers the time  $T_a$ .

If the block is retentive, LOGO! resets output Q and the expired time to the values before a power failure; if the block is not retentive, LOGO! resets output Q and the expired time to defaults after a power failure.

### Setting the Par parameter

Note the defaults specified in topic Time response (Page 143).

---

#### Note

All times must have the same timebase.

---

View in programming mode (example):

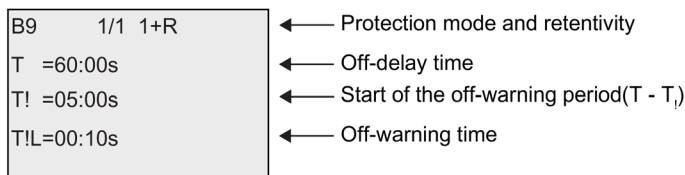

View in parameter assignment mode (example):

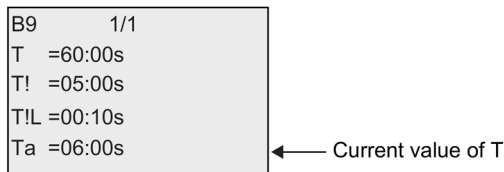

### 4.4.10 Multiple function switch

#### Short description

The multiple function switch provides two different functions:

- Pulse switch with off-delay
- Switch (permanent lighting)

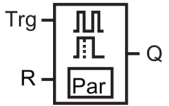
Symbol in LOGO!	Wiring	Description
 <p>MultiFunc.Switch</p>	Input Trg	A signal at input Trg (Trigger) sets output Q (permanent light) or resets Q with an off-delay. When active, output Q can be reset with a signal at input Trg.
	Input R	A signal at input R resets the current time T <sub>a</sub> and resets the output.
	Parameter	<p>T represents the off-delay time. LOGO! resets the output (1 to 0 transition) when time T expires.</p> <p>T<sub>L</sub> represents the time during which the output must be set to enable the permanent light function.</p> <p>T<sub>I</sub> represents the on-delay for the prewarning time.</p> <p>T<sub>IL</sub> represents the length of the prewarning time period.</p> <p>Retentivity:                      / = No retentivity                      R = The status is retentive.</p>
	Output Q	A signal at Trg switches on output Q. Depending on the length of the input at Trg, the output is off again or on permanently, or it is reset with a further signal at Trg.

#### Parameters T, T<sub>L</sub>, T<sub>I</sub> and T<sub>IL</sub>

Note the defaults of the T parameters listed in topic Time response (Page 143).

The actual value of another already-programmed function can provide the off-delay time  $T$ , the permanent light time  $T_L$ , the on-delay prewarning time  $T_I$  and the prewarning time period  $T_{IL}$ . You can use the actual values of the following functions:

- Analog comparator (Page 201) (actual value  $A_x - A_y$ )
- Analog threshold trigger (Page 196) (actual value  $A_x$ )
- Analog amplifier (Page 208) (actual value  $A_x$ )
- Analog multiplexer (Page 226) (actual value  $AQ$ )
- Analog ramp (Page 228) (actual value  $AQ$ )
- Mathematic instruction (Page 239) (actual value  $AQ$ )
- PI controller (Page 232) (actual value  $AQ$ )
- Up/down counter (Page 186) (actual value  $Cnt$ )
- Analog filter (Page 244) (actual value  $AQ$ )
- Average value (Page 249) (actual value  $AQ$ )
- Max/Min (Page 246) (actual value  $AQ$ )
- On-delay (Page 152) (current time  $T_a$ )
- Off-delay (Page 155) (current time  $T_a$ )
- On-/off-delay (Page 157) (current time  $T_a$ )
- Retentive on-delay (Page 159) (current time  $T_a$ )
- Wiping relay(pulse output) (Page 160) (current time  $T_a$ )
- Edge triggered wiping relay (Page 162) (current time  $T_a$ )
- Asynchronous pulse generator (Page 164) (current time  $T_a$ )
- Stairway light switch (Page 168) (current time  $T_a$ )
- Multiple function switch (current time  $T_a$ )
- Stopwatch (Page 183) (actual value  $AQ$ )
- Threshold trigger (Page 193) (actual value  $Fre$ )

Select the required function by the block number. The timebase is configurable. For information on valid ranges and parameter defaults, refer to the On-delay (Page 152) topic.

## Timing diagram

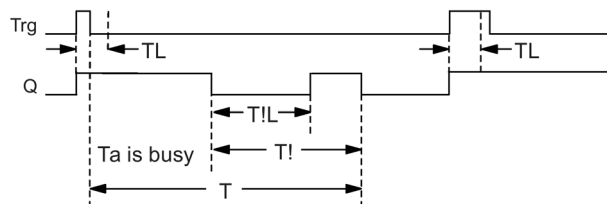

### Functional description

A 0 to 1 transition at input Trg sets output Q.

If output Q = 0, and input Trg is set hi at least for the duration of T<sub>L</sub>, LOGO! enables the permanent lighting function and sets output Q accordingly.

LOGO! triggers the off-delay T when input Trg returns to 0 before T<sub>L</sub> has expired.

Output Q is reset when T<sub>a</sub> = T.

You can output an off-warning signal prior to the expiration of the off-delay time (T - T<sub>i</sub>) that resets Q for the duration of the prewarning time period T<sub>iL</sub>. A subsequent signal at Trg always resets T and the output Q.

If the block is retentive, LOGO! resets output Q and the expired time to the values before a power failure; if the block is not retentive, LOGO! resets output Q and the expired time to defaults after a power failure.

### Setting the Par parameter

Note the defaults specified in the topic "Time response (Page 143)".

---

#### Note

T, T<sub>i</sub> and T<sub>iL</sub> must all have the same timebase.

---

View in programming mode (example):

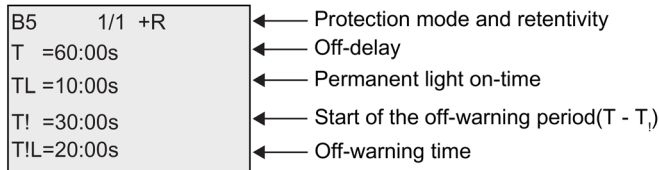

View in parameter assignment mode (example):

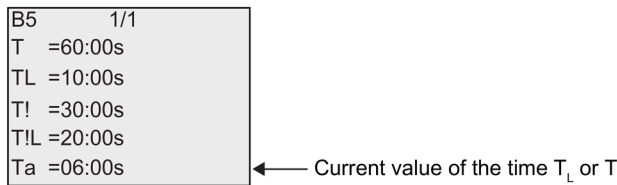



## 4.4.11 Weekly timer

### Short description

The weekly timer controls an output by means of a configurable on/off date. The function supports any combination of weekdays. You select the active weekdays by hiding the inactive days.

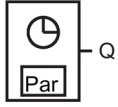
Symbol in LOGO!	Wiring	Description
 Weekly Timer	Cam parameters 1, 2 and 3	At the Cam parameters, you set the on- and off-times of the weekly timer for each <b>Cam</b> switch. Here you also configure the days and the time-of-day. You can also specify whether the timer pulses on for one cycle when activated and then reset. The pulse setting applies to all three cams.
	Output Q	LOGO! sets Q when actuating the configured cam.

### Timing diagram (three examples)

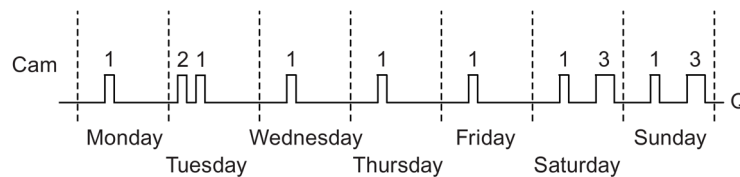

Cam 1:	Daily:	06:30 h to 8:00 h
Cam 2:	Tuesday:	03:10 h to 04:15 h
Cam 3:	Saturday and Sunday:	16:30 h to 23:10 h

### Functional description

Each weekly timer has three cams for you to configure a time hysteresis. You specify the on- and off-times at the Cam parameters. The weekly timer sets the output at a certain on-time; if you have not set it, the weekly timer resets the output at a certain off-time if you configure an off-time, or at the end of the cycle if you specify a pulse output.

You will cause a conflict if you set overlapping on- and off-times; the earliest on- and off-times take priority. Here is an example:

Cam	On-time	Off-time
1	1:00h	2:00h
2	1:10h	1:50h
3	1:20h	1:40h

In this example, the work time is 1:00h to 1:40h.

The status of all three cams determines the switching state of the weekly timer.

### Parameter assignment screen form

View of the parameter assignment screen form, for example for Cam1 and the Pulse setting:

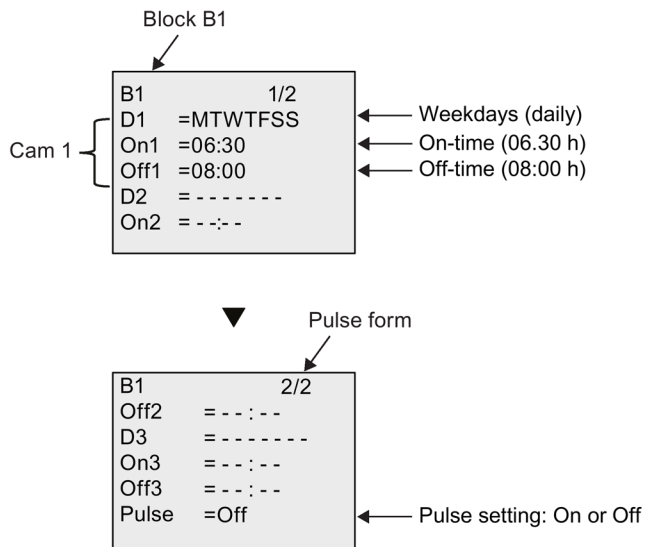

### Days of the week

The prefix "D=" (Day) has the following meaning:

- M: Monday
- T: Tuesday
- W: Wednesday
- T: Thursday
- F: Friday
- S: Saturday
- S: Sunday

Uppercase letters indicate a specific day of the week. A "-" indicates no selection for the day of the week.

### On-/Off-times

Any time between 00:00 h and 23:59 h is possible. You can also configure the on time to be a pulse signal. The timer block will be activated at the specified time for one cycle and then the output is reset.

--:-- means: No on-/off-times set.

## Setting the weekly timer

To set the on-/off-times:

1. Move the cursor to one of the Cam parameters of the timer (for example, No1).
2. Press **OK**. The cursor is positioned on the day of the week.
3. Press **▲** and **▼** to select one or several days of the week.
4. Press **▶** to move the cursor to the first position of the on-time.
5. Set the on-time.  
Modify the value at the respective position, using the keys **▲** and **▼**. Move to the cursor to the various positions, using the keys **◀** and **▶**. At the first position, you can only select the value -:-:-  
(-:-:- means: No on-/off-times set).
6. Press **▶** to move the cursor to the first position of the off-time.
7. Set the off-time (in same way as in Step 5).
8. Confirm your entries with **OK**.

To configure Cam2, press **▶**. The cursor is now positioned on the No2 parameter (Cam2) and you can continue with Steps 1 to 8.

---

### Note

For information on timer accuracy, refer to the technical data and to the topic "Time response (Page 143)".

---

## Weekly timer: Example

The output of the weekly timer switch is to be set daily from 06:30 h to 08:00 h. The output should also be set every Tuesday from 03:10 h to 04:15 h, and on the weekends from 16:30 h to 23:10 h.

This requires three cams.

Here are the parameter assignment screen forms of the cams No 1, 2 and 3, based on the timing diagram shown earlier.

- Cam No1 must set the output of the weekly timer daily from 06:30 h to 08:00 h.
- Cam No2 must set the output of the weekly timer every Tuesday from 03:10 h to 04:15 h.
- Cam No3 must set the output of the weekly timer switch every Saturday and Sunday from 16:30 h to 23:10 h.

Views in LOGO!:

B1	1/2
D1	=MTWTFSS
On1	=06:30
Off1	=08:00
D2	=-T-----
On2	=03:10

B1	2/2
Off2	=04:15
D3	=-----SS
On3	=16:30
Off3	=23:10
Pulse	=Off

**Result**

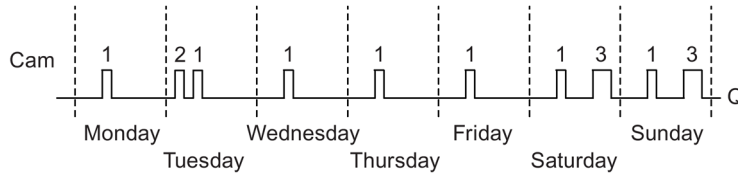

**4.4.12 Yearly timer**

**Short description**

The output is controlled by means of a configurable on/off date. You can configure the timer to activate on a yearly, monthly, or user-defined time basis. With any mode, you can also configure the timer to pulse the output during the defined time period. The time period is configurable within the date range of January 1, 2000 to December 31, 2099.

Symbol in LOGO!	Wiring	Description
<p>Yearly Timer</p>	Cam parameter	At the Cam parameter, you configure the timer mode, the on-/off-times for the timer, and whether the output is a pulse output.
	Output Q	LOGO! sets Q when the configured cam is on.

**Timing diagrams**

**Example 1:** Yearly mode on, Monthly mode off, Pulse Off, On Time = 2000-06-01, Off Time = 2099-08-31: every year on June 1 the timer output switches on and remains on until August 31.

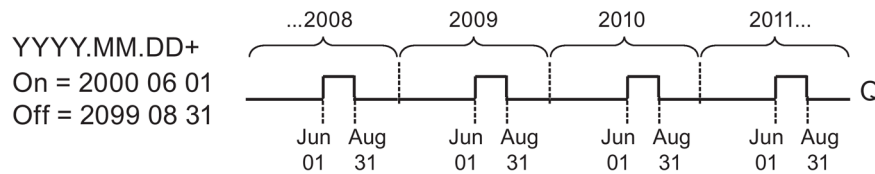

B6	1/3
Yearly	=On
Monthly	=Off
Pulse	=Off

B6	2/3
On Date	YYYY-MM-DD
	2000-06-01

B6	3/3
Off Date	YYYY-MM-DD
	2099-08-31

**Example 2:** Yearly mode on, Monthly mode off, Pulse on, On Time = 2000-03-15, Off Time = 2099-\*\*-\*\*: every year on March 15, the timer switches on for one cycle.

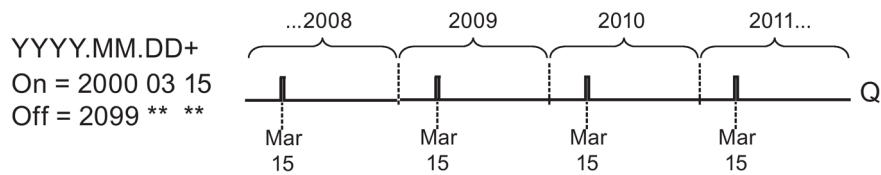

B6	1/3
Yearly	=On
Monthly	=Off
Pulse	=On

B6	2/3
On Date	YYYY-MM-DD
	2000-03-15

B6	3/3
Off Date	YYYY-MM-DD
	2099-**-**

**Example 3:** Yearly mode on, Monthly mode off, Pulse off, On Time = 2008-06-01, Off Time = 2010-08-31: on June 1 of 2008, 2009, and 2010 the timer output switches on and remains on until August 31.

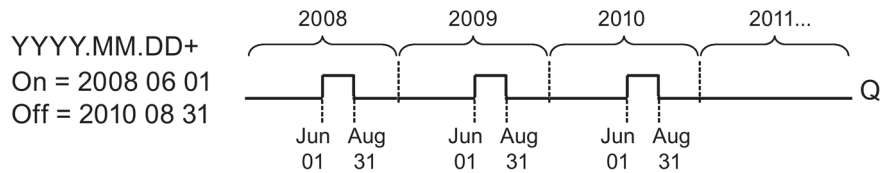

B6	1/3
Yearly	=On
Monthly	=Off
Pulse	=Off

B6	2/3
On Date	YYYY-MM-DD
	2008-06-01

B6	3/3
Off Date	YYYY-MM-DD
	2010-08-31

**Example 4:** Yearly mode on, Monthly mode off, Pulse on, On Time = 2008-03-15, Off Time = 2010-\*\*-\*\*: on March 15 of 2008, 2009, and 2010, the timer output switches on for one cycle.

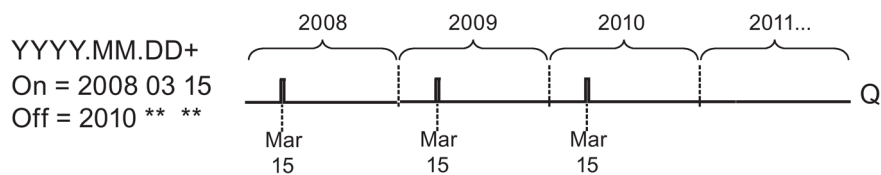

B6	1/3
Yearly	=On
Monthly	=Off
Pulse	=On

B6	2/3
On Date	YYYY-MM-DD
	2008-03-15

B6	3/3
Off Date	YYYY-MM-DD
	2010-**-**

**Example 5:** Yearly mode off, Monthly mode off, Pulse off, On Time = 2008-06-01, Off Time = 2010-08-31: on June 1, 2008 the timer output switches on and remains on until August 31, 2010.

4.4 Special functions list - SF

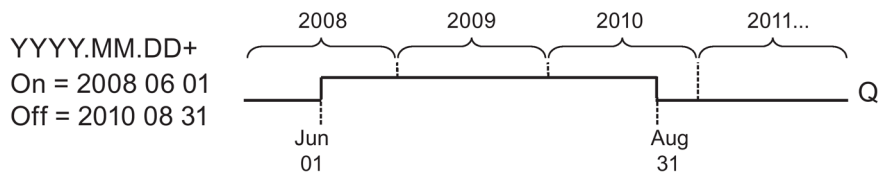

B6	1/3
Yearly	=Off
Monthly	=Off
Pulse	=Off

B6	2/3
On Date	YYYY-MM-DD
	2008-06-01

B6	3/3
Off Date	YYYY-MM-DD
	2010-08-31

**Example 6:** Yearly mode off, Monthly mode off, Pulse selected, On Time = 2008-03-15, Off Time = \*\*\*\*\_\*\*\_\*\*: on March 15, 2008 the timer output switches on for one cycle. Because the timer does not have a monthly action or yearly action, the timer output pulses only one time at the specified On Time.

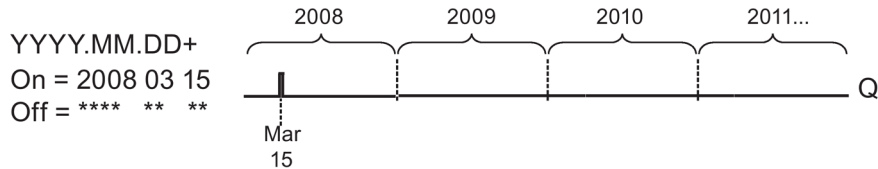

B6	1/3
Yearly	=Off
Monthly	=Off
Pulse	=On

B6	2/3
On Date	YYYY-MM-DD
	2008-03-15

B6	3/3
Off Date	YYYY-MM-DD
	****_**_**

**Example 7:** Yearly mode on, Monthly mode off, Pulse off, On Time = 2008-12-15, Off Time = 2010-01-07: on December 15 of 2008 and 2009, the timer output switches on and remains on until January 7 of the following year. When the timer output turns off on January 7, 2010 it does NOT turn on again the following December 15.

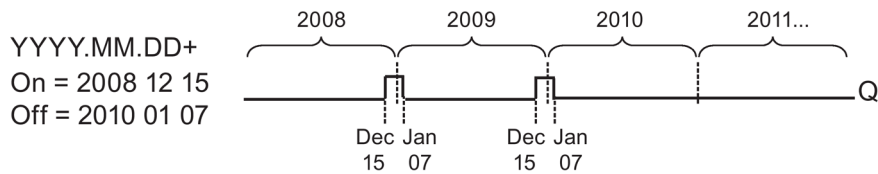

B6	1/3
Yearly	=On
Monthly	=Off
Pulse	=Off

B6	2/3
On Date	YYYY-MM-DD
	2008-12-15

B6	3/3
Off Date	YYYY-MM-DD
	2010-01-07

**Example 8:** Yearly mode on, Monthly mode on, On Time = 2008-\*\*-01, Off Time = 2010-\*\*-05: starting in 2008, on the first day of each month the timer output switches on and switches off on the fifth day of the month. The timer continues in this pattern through the last month of 2010.

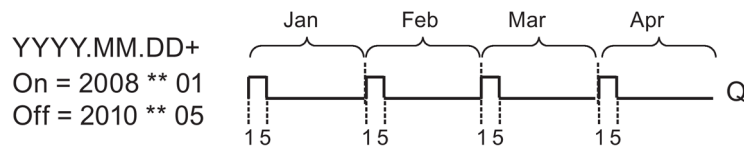

B6	1/3
Yearly	=On
Monthly	=On
Pulse	=Off

B6	2/3
On Date	YYYY-MM-DD
	2008-**-01

B6	3/3
Off Date	YYYY-MM-DD
	2010-**-05

## Functional description

The yearly timer sets and resets the output at specific on and off dates. Sets and resets are executed at 00:00. If your application requires a different time, use a weekly timer together with a yearly timer in your circuit program.

The on time specifies when the timer is activated. The off time specifies when the output is reset again. For the on and off times, note the order of the fields: The first field defines the year, the second the month and the third the day.

If you set the Monthly mode on, the timer output switches on each month at the specified day of the on time and remains on until the specified day of the off time. The on time specifies the initial year in which the timer is activated. The off time defines the last year in which the timer turns off. The maximum year is 2099.

If you set the Yearly mode on, the timer output switches on each year at the specified month and day of the on time and remains on until the specified month and day of the off time. The on time specifies the initial year in which the timer is activated. The off time defines the last year in which the timer turns off. The maximum year is 2099.

If you set Pulse output, the timer output switches on at the specified on time for one cycle and then the timer output is reset. You can choose to pulse a timer on a monthly or yearly basis, or just a single time.

If you set none of the Monthly, Yearly, or Pulse modes on, you can define a specific time period with the on time and off time. It can span any time period that you choose.

For a process action that is to be switched on and off at multiple but irregular times during the year, you can define multiple yearly timers with the outputs connected by an OR function block.

## Backup of the real-time clock

The internal real-time clock of LOGO! is buffered against power failure. The buffering time is influenced by the surrounding temperature, and is typically 20 days at a surrounding temperature of 25°C.

**Sample configuration**

The output of a LOGO! is to be set annually on March 1, reset on April 4, set again on July 7, and reset again on November 19. You need to configure two yearly timers with corresponding on-times, then logically link the outputs by means of an OR block.

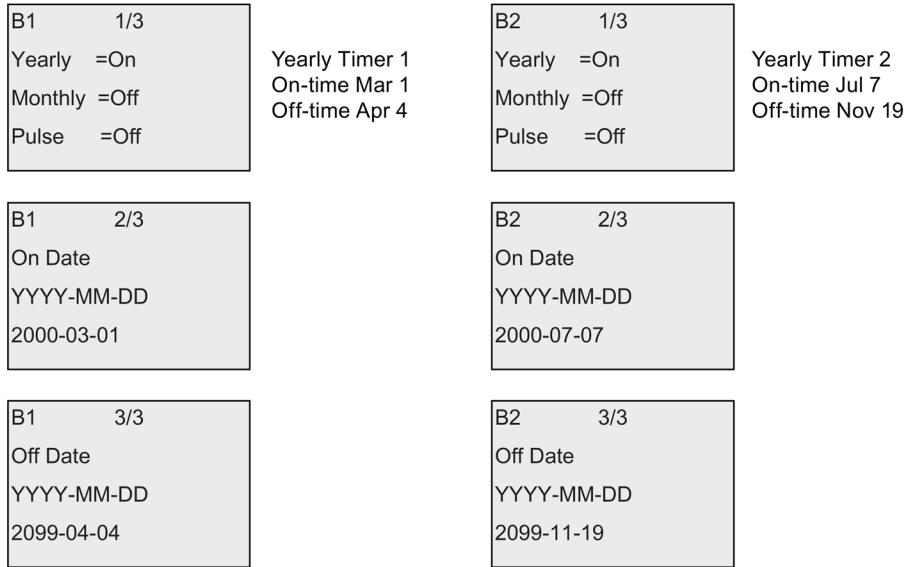

**Result**

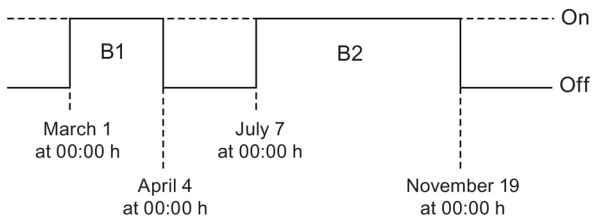



### 4.4.13 Astronomical clock

#### Short description

The astronomical clock function is used to set an output high when the current time of your LOGO! Base Module is between the time of sunrise (TR) and the time of sunset (TS). LOGO! automatically calculates these times based on the geographical location, the settings for automatic summertime/wintertime conversion, and the current time of the module.

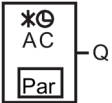
Symbol in LOGO!	Wiring	Description
 <p>Astron. Clock</p>	Parameter	<p>You specify the longitude, latitude, time zone, sunrise time offset and sunset time offset:</p> <p><b>Longitude:</b>                      Direction settings:                      EAST or WEST                      Range of values:                      0 ° to 180 ° (degrees)                      0 ' to 59 ' (minutes)                      0 " to 59 " (seconds)</p> <p><b>Latitude:</b>                      Direction settings:                      NORTH or SOUTH                      Range of values:                      0 ° to 90 ° (degrees)                      0 ' to 59 ' (minutes)                      0 " to 59 "(seconds)</p> <p><b>Zone:</b>                      Range of values:                      -11 to 12</p> <p><b>TR Offset</b> (sunrise time offset):                      Range of values:                      -59 minutes to 59 minutes</p> <p><b>TS Offset</b> (sunset time offset):                      Range of values:                      -59 minutes to 59 minutes</p>
	Output Q	LOGO! sets Q to "1" when the current time of your LOGO! Base Module is between the sunrise time (TR) and the sunset time (TS).

#### Note

From LOGO!Soft Comfort V8.1, you can choose from several pre-defined time zone locations. If you select one of these locations, LOGO!Soft Comfort uses the latitude, longitude, and the time zone of your selection. This location pre-configuration capability is only possible from LOGO!Soft Comfort.

### Timing diagram

The following illustration is an example of the timing diagram where Ta refers to the current time of the LOGO! Base Module:

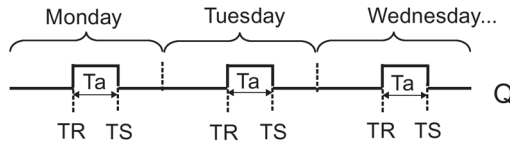

### Functional description

The function calculates the TR and TS values at the input and sets Q when Ta (Ta is the current LOGO! Time) is between TR and TS; otherwise, the function resets Q.

If automatic summertime/wintertime conversion (see the topic Summertime/wintertime conversion (Page 105) for details) is enabled, the function takes the configured time difference into consideration when calculating the TR and TS values.

### Setting the Par parameter

View in programming mode (example):

B1	1/3	+/-	← Protection mode
Longitude			Direction
EAST			(EAST/WEST)
80° 23' 5"			← Value
			(degrees, minutes and seconds)

Press ►

B1	2/3	+/-	← Protection mode
Latitude			Direction
NORTH			(EAST/WEST)
50° 10' 0"			← Value (degrees, minutes and seconds)
Zone: GMT	8		← Time zone
TR Offset	=+0		← Sunrise time offset

Press ►

B1	3/3	+/-	← Protection mode
TS Offset	=+0		← Sunset time offset

View in parameter assignment mode (example):

```
B1      1/3
Longitude
EAST
80° 23' 5"
```

Press ▼

```
B1      2/3
Latitude
NORTH
50° 10' 0"
Zone: GMT 8
TR Offset =+0
```

If automatic summertime/wintertime conversion is disabled, press ▼ and LOGO! shows the following view in parameter assignment mode (example):

```
B1      3/3
TR Offset =+0
TR       =10:38 ← Sunrise time
TS       =18:46 ← Sunset time
```

If automatic summertime/wintertime conversion is enabled and set to "EU" (for example), press ▼ and LOGO! shows the following view in parameter assignment mode (example):

```
B1      3/3
TR Offset =+0
TR       =11:38
TS       =19:46
```

## 4.4.14 Stopwatch

### Short description

The stopwatch function counts the elapsed time between a start stopwatch signal and a stop stopwatch signal.

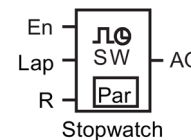
Symbol in LOGO!	Wiring	Description
 <p>En — [SW] — AQ Lap — [Par] R — Stopwatch</p>	En	A signal at input En begins counting elapsed time at analog output AQ.
	Lap	A positive edge (0 to 1 transition) at input Lap pauses the stopwatch. A negative edge (1 to 0 transition) at input Lap resumes the stopwatch.
	R	A signal at input R resets the elapsed time.

Symbol in LOGO!	Wiring	Description
	Parameter	You can set a timebase TB for the stopwatch. <b>Possible timebase settings:</b> 10 ms, s, m, and h Retentivity: / = No retentivity R = The status is retentive
	Output AQ	A signal at input Lap holds the value of AQ until Lap is reset to 0. A signal at input R resets the value of AQ to 0.

### Parameters TB

You can set a timebase from the following timebase set:

- 10 ms (10 milliseconds)
- s (seconds)
- m (minutes)
- h (hours)

### Timing diagram

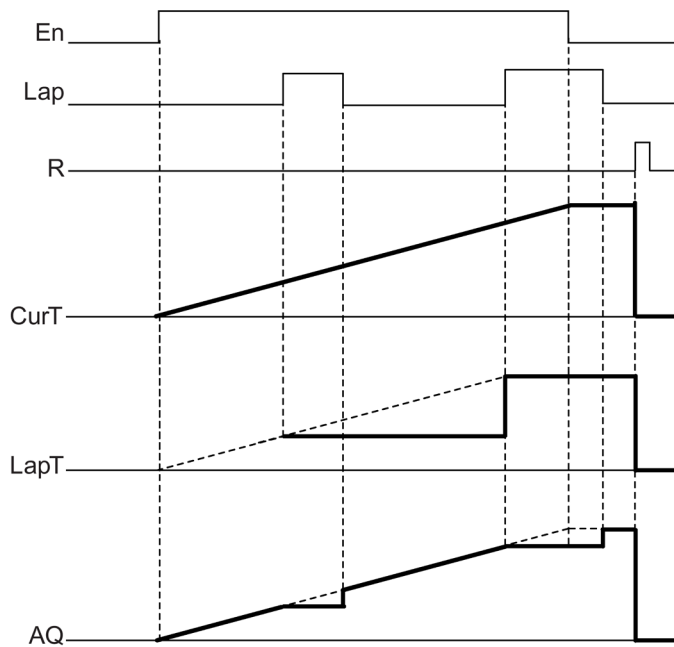

### Functional description

En = 1 and Lap = 0: Using the selected timebase, the stopwatch outputs the current time (CurT) to AQ.

En = 1 and Lap = 1: The stopwatch leaves AQ at its last value when Lap = 0. This value is recorded as LapT for stopwatch pause time.

En = 0 and Lap = 1: The stopwatch pauses counting time. It outputs LapT to AQ.

En = 0 and Lap = 0: The stopwatch outputs the current time (CurT) to AQ.

A signal at R sets the AQ value to 0.

### Setting the Par parameter

View in programming mode (example):

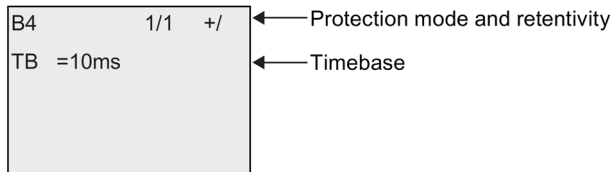

To change the timebase, press **▶** to move the cursor to "10ms". Press **OK** and now the timebase can be selected. Press **▲** or **▼** to select another timebase. To confirm your selection, press **OK**.

View in parameter assignment mode (example):

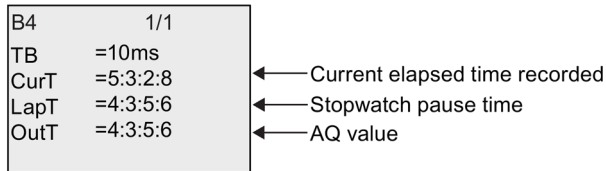

### 4.4.15 Up/down counter

#### Short description

An input pulse increments or decrements an internal value, depending on the parameter setting. The output is set or reset when a configured threshold is reached. The direction of count can be changed with a signal at input Dir.

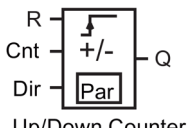
Symbol in LOGO!	Wiring	Description
 <p>Up/Down Counter</p>	Input R	A signal at input R resets the internal count value to zero.
	Input Cnt	The function counts the 0 to 1 transitions at input Cnt. 1 to 0 transitions are not counted. You can use the following as the input: <ul style="list-style-type: none"> <li>inputs I3, I4, I5, and I6 for fast counting (only LOGO! 12/24RCE/RCEo and LOGO! 24CE/24CEo): max. 5 kHz, if the fast input is directly connected to the up/down counter function block</li> <li>any other input or circuit component for counting low frequency signals (typically 4 Hz)</li> </ul>
	Input Dir	You set the direction of count at input Dir: Dir = 0: Count up Dir = 1: Count down
	Parameter	On: on threshold Range of values: 0...999999 Off: off threshold Range of values: 0...999999 StartVal: initial value from which to begin counting either down or up. Retentivity for internal counter value Cnt: / = No retentivity R = The status is retentive.
	Output Q	Q is set or reset, depending on the current value at Cnt and the set thresholds.

#### Parameters On and Off

The actual value of another already-programmed function can provide the on threshold On and the off threshold Off. You can use the actual values of the following functions:

- Analog comparator (Page 201) (actual value Ax – Ay)
- Analog threshold trigger (Page 196) (actual value Ax)
- Analog amplifier (Page 208) (actual value Ax)
- Analog multiplexer (Page 226) (actual value AQ)
- Analog ramp (Page 228) (actual value AQ)
- Mathematic instruction (Page 239) (actual value AQ)

- PI controller (Page 232) (actual value AQ)
- Up/down counter (actual value Cnt)
- Analog filter (Page 244) (actual value AQ)
- Average value (Page 249) (actual value AQ)
- Max/Min (Page 246) (actual value AQ)
- On-delay (Page 152) (current time Ta)
- Off-delay (Page 155) (current time Ta)
- On-/off-delay (Page 157) (current time Ta)
- Retentive on-delay (Page 159) (current time Ta)
- Wiping relay(pulse output) (Page 160) (current time Ta)
- Edge triggered wiping relay (Page 162) (current time Ta)
- Asynchronous pulse generator (Page 164) (current time Ta)
- Stairway light switch (Page 168) (current time Ta)
- Multiple function switch (Page 170) (current time Ta)
- Stopwatch (Page 183) (actual value AQ)
- Threshold trigger (Page 193) (actual value Fre)

Select the required function by the block number.

## Timing diagram

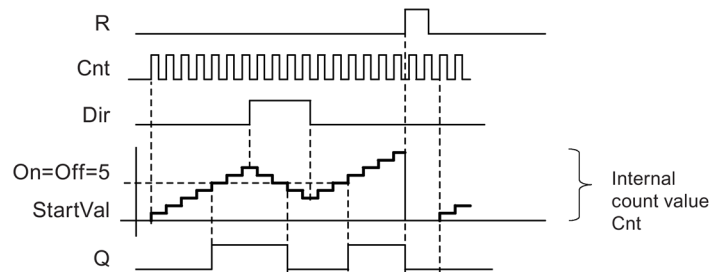

## Functional description

The internal counter increments ( $Dir = 0$ ) or decrements ( $Dir = 1$ ) by one count with every positive edge at input Cnt.

You can use input R to reset the internal count value to the start value. As long as  $R = 1$ , the output is also 0 and the pulses at input Cnt are not counted.

If retentivity is not set, output Q and the expired time are reset after a power failure.

Q is set or reset depending on the current value at Cnt and the set thresholds. See the calculation rule below.

**Calculation rule**

- If the On threshold  $\geq$  Off threshold, then:  
 $Q = 1$ , if  $Cnt \geq On$   
 $Q = 0$ , if  $Cnt < Off$
- If the On threshold  $<$  Off threshold, then  $Q = 1$ , if  $On \leq Cnt < Off$ .

**Note**

The system scans the counter limit value cyclically.

Thus, if the pulse frequency at the fast digital inputs I3, I4, I5 or I6 is faster than the cycle time, the special function might not switch until after the specified limit value is exceeded.

Example: Up to 100 pulses per cycle can be counted; 900 pulses have been counted so far. On = 950; Off = 10000. The output is set in the next cycle, after the value has reached 1000. (The output would not be set at all if the value Off = 980).

View in programming mode (example):

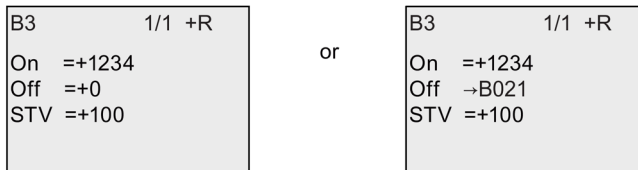

If the referenced block (B021, in the example) returns a value that lies out of the valid range, the value is rounded to the next valid value.

The view in parameter assignment mode (example):

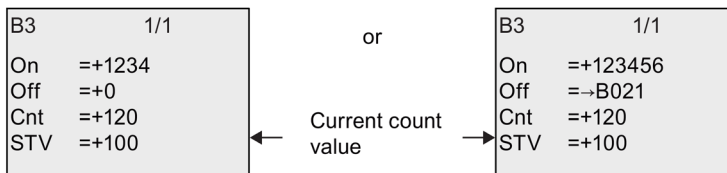



## 4.4.16 Hours counter

### Short description

A configured time is triggered with a signal at the monitoring input. The output is set when this time has expired.

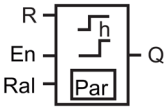
Symbol in LOGO!	Wiring	Description
 <p>Hours Counter</p>	Input R	A positive edge (0 to 1 transition) at input R resets output Q and sets a configured value MI at the counter for the duration of the time-to-go (MN).
	Input En	En is the monitoring input. LOGO! scans the on-time of this input.
	Input Ral	A positive edge at input Ral (Reset all) resets the hours counter (OT) and the output, and sets the time-to-go value (MN) to the maintenance interval MI: <ul style="list-style-type: none"> <li>Output Q = 0</li> <li>Measured operating time OT = 0</li> <li>Time-to-go of the maintenance interval MN = MI.</li> </ul>
	Parameter	MI: Maintenance interval to be preset in units of hours and minutes Range of values: 0000 h to 9999 h, 0 m to 59 m OT: the accumulated total operating time (you can specify an offset in hours and minute) Range of values: 00000 h to 99999 h, 0 m to 59 m Q → 0 occurs depending on the following conditions: <ul style="list-style-type: none"> <li>When "R" is selected: Q = 1, if MN = 0; Q = 0, if R = 1 or Ral = 1</li> <li>When "R+En" is selected: Q = 1, if MN = 0; Q = 0, if R = 1 or Ral = 1 or En = 0.</li> </ul>
Output Q	The output is set when the time-to-go MN = 0 (see timing diagram). The output is reset under the following conditions: <ul style="list-style-type: none"> <li>When "Q→0:R+En", if R = 1 or Ral = 1 or En = 0</li> <li>When "Q→0:R", if R = 1 or Ral = 1.</li> </ul>	

### Note

MI, MN and OT are always retentive.

## Parameter MI

The maintenance interval MI can be provided by the actual value of another already-programmed function. The timebase of the referenced value is "h" (for hours) only. You can use the actual values of the following functions:

- Analog comparator (Page 201) (actual value Ax – Ay)
- Analog threshold trigger (Page 196) (actual value Ax)
- Analog amplifier (Page 208) (actual value Ax)
- Analog multiplexer (Page 226) (actual value AQ)
- Analog ramp (Page 228) (actual value AQ)
- Mathematic instruction (Page 239) (actual value AQ)
- PI controller (Page 232) (actual value AQ)
- Up/down counter (Page 186) (actual value Cnt)
- Analog filter (Page 244) (actual value AQ)
- Average value (Page 249) (actual value AQ)
- Max/Min (Page 246) (actual value AQ)
- On-delay (Page 152) (current time Ta)
- Off-delay (Page 155) (current time Ta)
- On-/off-delay (Page 157) (current time Ta)
- Retentive on-delay (Page 159) (current time Ta)
- Wiping relay(pulse output) (Page 160) (current time Ta)
- Edge triggered wiping relay (Page 162) (current time Ta)
- Asynchronous pulse generator (Page 164) (current time Ta)
- Stairway light switch (Page 168) (current time Ta)
- Multiple function switch (Page 170) (current time Ta)
- Stopwatch (Page 183) (current time Ta)

Select the required function by the block number.

## Timing diagram

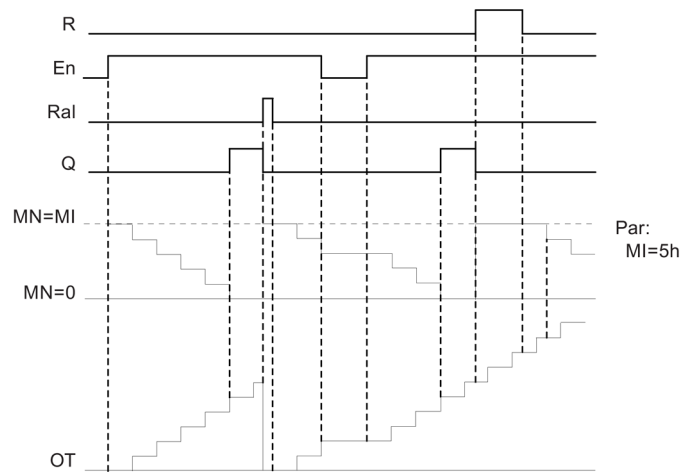

MI = Configured time interval  
MN = Time-to-go  
OT = Total time expired since the last hi signal at input Ral

## Functional description

The hours counter monitors input En. When En = 1, LOGO! computes the time expired and the time-to-go MN. LOGO! shows these times in parameter assignment mode. Output Q is set when the time-to-go MN = 0.

A signal at reset input R resets output Q and sets the preset value of MI at the counter for the duration of MN. The hours counter OT is not affected.

With a signal at the reset input Ral, you reset output Q and set the preset value of MI at the counter for the duration of MN. The hours counter OT is reset to zero.

Depending on your configuration of parameter Q, the output is either reset with a signal at input R or Ral ("Q→0:R"), or when a reset signal is set hi, or the En signal is set lo ("Q→0:R+En").

## Viewing the MI, MN and OT values

- LOGO! Basic: You can open the parameter assignment mode when the system is in RUN to view the actual values of MI, MN and OT.
- LOGO! Pure: In LOGO!Soft Comfort, you can use the Online Test to read these values. For further information, see chapter "LOGO! software (Page 334)".
- In LOGO!Soft Comfort you can get the hours counter via the "Tools -> Transfer: Hours counter" menu command.

### Limit value of OT

The value of the operating hours in OT is retained when you reset the hours counter with a signal at input R. The hours counter OT will be reset to zero with a transition from 0 to 1 at Ra. It continues the count as long as En = 1, irrespective of the status at the reset input R. The counter limit of OT is 99999 h. The hours counter stops when it reaches this value.

In programming mode, you can set the initial value of OT. MN is calculated according to the following formula when reset input R is never enabled:  $MN = MI - (OT \% MI)$ . The % operator provides an integer division remainder.

Example:

$$MI = 30h, OT = 100h$$

$$MN = 30 - (100 \% 30)$$

$$MN = 30 - 10$$

$$MN = 20h$$

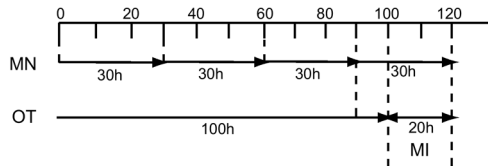

In runtime mode, the value OT can not be preset. If the value for MI is changed, there would be no calculation for the MN. MN would take on the value of MI.

### Setting the Par parameter

View in programming mode:

B16	1/1 +/
MI	=100h:0m
OT	=30h:0m
Q→0:	=R+En

B16	1/1 +/
MI	→B001 h
OT	=30h:0m
Q→0:	=R+En

**MI** is the configurable time interval. The permissible range of values is 0 to 9999 hours.

For information on how to assign the actual value of another already-programmed function to a parameter, see the On-delay (Page 152) topic.

View in parameter assignment mode:

B16	1/1	
MI	=100h:0m	← Time interval
OT	=83h:15m	← Total operating hours
MN	=16h:45m	← Time-to-go

## 4.4.17 Threshold trigger

### Short description

The output is set and reset with two configurable threshold triggers.

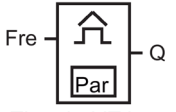
Symbol in LOGO!	Wiring	Description
 <p>ThresholdTrigger</p>	Input Fre	<p>The function counts the 0 to 1 transitions at input Fre. 1 to 0 transitions are not counted.</p> <p>Use the following as the input:</p> <ul style="list-style-type: none"> <li>inputs I3, I4, I5, I6 for fast counting (only LOGO! 12/24RCE/RCEo and LOGO! 24CE/24CEo): max. 5 kHz, if the fast input is directly connected to the threshold trigger function block</li> <li>any other input or circuit component for counting low frequency signals (typically 4 Hz)</li> </ul>
	Parameter	<p>On: on threshold Range of values: 0000...9999</p> <p>Off: off threshold Range of values: 0000...9999</p> <p>G_T: time interval or gate time during which the input pulses are measured Range of values: 00:00 s...99:99 s</p>
	Output Q	Q is set and reset at the thresholds.

### Parameter G\_T

The gate time G\_T can be provided by the actual value of another already-programmed function. You can use the actual values of the following functions:

- Analog comparator (Page 201) (actual value Ax – Ay)
- Analog threshold trigger (Page 196) (actual value Ax)
- Analog amplifier (Page 208) (actual value Ax)
- Analog multiplexer (Page 226) (actual value AQ)
- Analog ramp (Page 228) (actual value AQ)
- Mathematic instruction (Page 239) (actual value AQ)
- PI controller (Page 232) (actual value AQ)
- Up/down counter (Page 186) (actual value Cnt)
- Analog filter (Page 244) (actual value AQ)
- Average value (Page 249) (actual value AQ)
- Max/Min (Page 246) (actual value AQ)
- On-delay (Page 152) (current time Ta)

- Off-delay (Page 155) (current time  $T_a$ )
- On-/off-delay (Page 157) (current time  $T_a$ )
- Retentive on-delay (Page 159) (current time  $T_a$ )
- Wiping relay(pulse output) (Page 160) (current time  $T_a$ )
- Edge triggered wiping relay (Page 162) (current time  $T_a$ )
- Asynchronous pulse generator (Page 164) (current time  $T_a$ )
- Stairway light switch (Page 168) (current time  $T_a$ )
- Multiple function switch (Page 170) (current time  $T_a$ )
- Stopwatch (Page 183) (actual value  $AQ$ )
- Threshold trigger (actual value  $Fre$ )

Select the required function by the block number.

### Timing diagram

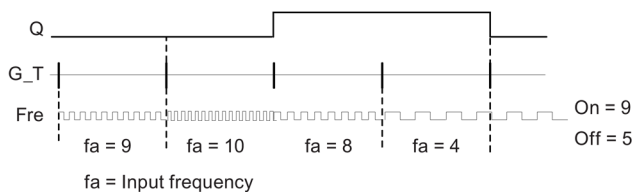

### Functional description

The threshold trigger measures the signals at input  $Fre$ . The pulses are recorded across a configurable time  $G\_T$ .

Output  $Q$  is set and reset in accordance with the set thresholds. See the calculation rule below.

### Calculation rule

- If the On threshold  $\geq$  Off threshold, then  $Q = 1$ , if  $f_a > \text{On}$  or  $Q = 0$ , if  $f_a \leq \text{Off}$ .
- If the On threshold  $<$  Off threshold, then  $Q = 1$  if  $\text{On} \leq f_a < \text{Off}$ .

### Setting the Par parameter

---

#### Note

The system scans the counter limit value once per interval  $G\_T$ .

---

View in programming mode (example):

B15	1/1	+/	← Parameter protection mode
On	=9		← On threshold
Off	=5		← Off threshold
G_T	=01:00s		← Time interval for pulses (example)

---

**Note**

The "seconds" timebase is here set as permanent default.

When you preset a time G\_T of 1 s, LOGO! returns the current frequency in parameter  $f_a$  in Hz.

---

View in parameter assignment mode (example):

B15	1/1		
On	=9	←	On threshold
Off	=5	←	Off threshold
$f_a$	=10	←	$Q = 1 (f_a > \text{On})$

---

**Note**

$f_a$  always represents the total pulses measured per time unit G\_T.

---

### 4.4.18 Analog threshold trigger

#### Short description

The output is set and reset at two configurable thresholds.

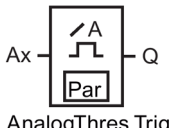
Symbol in LOGO!	Wiring	Description
 AnalogThres.Trig	Input Ax	Input Ax is one of the following analog signals: <ul style="list-style-type: none"> <li>• AI1 to AI8 (*)</li> <li>• AM1 to AM64</li> <li>• NAI1 to NAI32</li> <li>• AQ1 to AQ8</li> <li>• NAQ1 to NAQ16</li> <li>• Block number of a function with analog output</li> </ul>
	Parameter	A: gain Range of values: -10.00 to 10.00 B: zero offset Range of values: -10,000 to 10,000 On: on threshold Range of values: -20,000 to 20,000 Off: off threshold Range of values: -20,000 to 20,000 p: number of decimals Range of values: 0, 1, 2, 3
	Output Q	Q is set or reset by the threshold triggers.
* AI1...AI8: 0...10 V corresponds with 0...1000 (internal value).		

#### Gain and offset parameters

Please note the information on gain and offset parameters in topic "Calculating the gain and offset of analog values (Page 145)".

#### Parameters On and Off

The actual value of another already-programmed function can provide the On and Off parameters. You can use the actual values of the following functions:

- Analog comparator (Page 201) (actual value Ax – Ay)
- Analog amplifier (Page 208) (actual value Ax)
- Analog multiplexer (Page 226) (actual value AQ)
- Analog ramp (Page 228) (actual value AQ)
- Mathematic instruction (Page 239) (actual value AQ)
- PI controller (Page 232) (actual value AQ)
- Up/down counter (Page 186) (actual value Cnt)
- Analog filter (Page 244) (actual value AQ)



- Average value (Page 249) (actual value AQ)
- Max/Min (Page 246) (actual value AQ)
- On-delay (Page 152) (current time Ta)
- Off-delay (Page 155) (current time Ta)
- On-/off-delay (Page 157) (current time Ta)
- Retentive on-delay (Page 159) (current time Ta)
- Wiping relay (pulse output) (Page 160) (current time Ta)
- Edge-triggered wiping relay (Page 162) (current time Ta)
- Asynchronous pulse generator (Page 164) (current time Ta)
- Stairway lighting switch (Page 168) (current time Ta)
- Multiple function switch (Page 170) (current time Ta)
- Stopwatch (Page 183) (actual value AQ)
- Analog threshold trigger (actual value Ax)
- Threshold trigger (Page 193) (actual value Fre)

Select the required function by the block number.

### Parameter p (number of decimals)

Applies only to the display of On, Off and Ax values in a message text.

Does not apply to the comparison of On and Off values. (The compare function ignores the decimal point.)

### Timing diagram

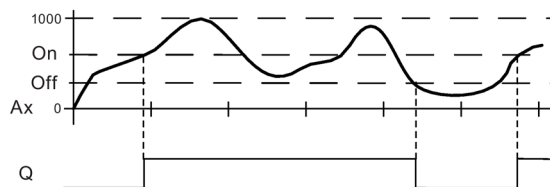

### Functional description

The function fetches the analog signal at input Ax.

Ax is multiplied by the value of the A (gain) parameter, and the value at parameter B (offset) is added to product, i.e.  $(Ax \cdot \text{gain}) + \text{offset} = \text{actual value of Ax}$ .

Output Q is set or reset, depending on the set thresholds. See the calculation rule below.

### Calculation rule

- If the On threshold  $\geq$  Off threshold, then  $Q = 1$ , if the actual value  $Ax > On$  or  $Q = 0$ , if the actual value  $Ax \leq Off$ .
- If the On threshold  $<$  Off threshold, then  $Q = 1$  if  $On \leq actual\ value\ Ax < Off$ .

### Setting the Par parameter

The gain and offset parameters are used to adapt the sensors to the relevant application.

View in programming mode (example):

B3	1/1	+/	← Parameter protection mode
On	=+4000		← On threshold
Off	=+2000		← Off threshold
A	=+1.00		← Gain
B	=+0		← Offset
P	=2		← Decimals in the message text

View in parameter assignment mode (example):

B3	1/1	
On	=+4000	← On threshold
Off	=+2000	← Off threshold
Ax	=+0	← $Q = 1 (Ax > On)$

View in the message text (example):

+050.00	← Ax, when $p = 2$ $Q = 1 (Ax > On)$
---------	---

## 4.4.19 Analog differential trigger

### Short description

The output is set and reset depending on a configurable threshold and a differential value.

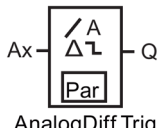
Symbol in LOGO!	Wiring	Description
 <p>Symbol: AnalogDiff.Trig</p>	Input Ax	Input Ax is one of the following analog signals: <ul style="list-style-type: none"> <li>• AI1 to AI8 (*)</li> <li>• AM1 to AM64</li> <li>• NAI1 to NAI32</li> <li>• AQ1 to AQ8</li> <li>• NAQ1 to NAQ16</li> <li>• Block number of a function with analog output</li> </ul>
	Parameter	A: gain Range of values: -10.00 to 10.00 B: zero offset Range of values: -10,000 to 10,000 On: On/Off threshold Range of values: -20,000 to 20,000 Δ: differential value for calculating the off parameter Range of values: -20,000 to 20,000 p: Number of decimals Range of values: 0, 1, 2, 3
	Output Q	Q is set or reset, depending on the threshold and difference values.
* AI1...AI8: 0...10 V corresponds with 0...1000 (internal value).		

### Gain and offset parameters

Please note the information on gain and offset parameters in topic "Calculating the gain and offset of analog values (Page 145)".

### Parameter p (number of decimals)

Applies only to the display of On, Off and Ax values in a message text.

### Timing diagram A: Function with negative difference $\Delta$

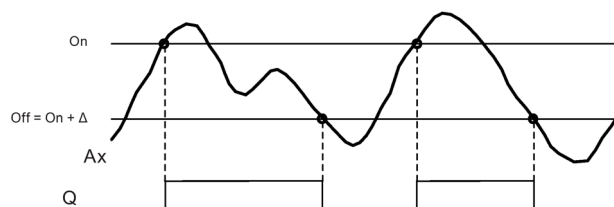

### Timing diagram B: Function with positive difference $\Delta$

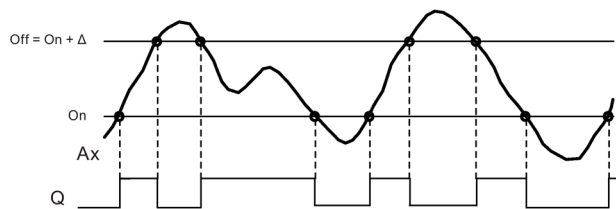

### Functional description

The function fetches the analog signal at input Ax.

Ax is multiplied by the value of the A (gain) parameter, and the value at parameter B (offset) is added to product, i.e.  $(Ax \cdot \text{gain}) + \text{offset} = \text{actual value of Ax}$ .

Output Q is set or reset, depending on the set (On) threshold and difference value ( $\Delta$ ). The function automatically calculates the Off parameter:  $\text{Off} = \text{On} + \Delta$ , whereby  $\Delta$  may be positive or negative. See the calculation rule below.

### Calculation rule

- When you set a negative differential value  $\Delta$ , the On threshold  $\geq$  Off threshold, and  $Q = 1$  if the actual value  $Ax > \text{On}$  or  $Q = 0$  if the actual value  $Ax \leq \text{Off}$ . See the timing diagram A.
- When you set a positive differential value  $\Delta$ , the On threshold  $<$  the Off threshold, and  $Q = 1$ , if  $\text{On} \leq \text{actual value } Ax < \text{Off}$ . See the timing diagram B.

### Setting the Par parameter

The gain and offset parameters are used to adapt the sensors to the relevant application.

View in programming mode (example):

B3	1/1 +/-	← Parameter protection mode
On	=+4000	← On/off threshold
$\Delta$	=-2000	← Differential value for the on/off threshold
A	=+1.00	← Gain
B	=+0	← Offset
P	=2	← Decimals in the message text

View in parameter assignment mode (example):

B3	1/1	
On	=+4000	← On threshold
$\Delta$	=-2000	← Differential value for the off threshold
Off	=+2000	← Off threshold
Ax	=+5000	← $Q = 1 (Ax > \text{On})$

## 4.4.20 Analog comparator

### Short description

The output is set and reset depending on the difference  $A_x - A_y$  and on two configurable thresholds.

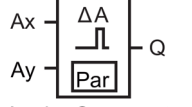
Symbol in LOGO!	Wiring	Description
 <p>AnalogComparator</p>	Inputs $A_x$ and $A_y$	Inputs $A_x$ and $A_y$ are one of the following analog signals: <ul style="list-style-type: none"> <li>• AI1 to AI8 (*)</li> <li>• AM1 to AM64</li> <li>• NAI1 to NAI32</li> <li>• AQ1 to AQ8</li> <li>• NAQ1 to NAQ16</li> <li>• Block number of a function with analog output</li> </ul>
	Parameter	A: gain Range of values: -10.00 to 10.00 B: ero offset Range of values: -10,000 to 10,000 On: on threshold Range of values: -20,000 to 20,000 Off: off threshold Range of values: -20,000 to 20,000 p: number of decimals Range of values: 0, 1, 2, 3
	Output Q	Q is set or reset, depending on the difference $A_x - A_y$ and the set thresholds..
* AI1...AI8: 0...10 V corresponds with 0...1000 (internal value).		

### Gain and offset parameters

For more information on the gain and offset parameters, refer to topic "Calculating the gain and offset of analog values (Page 145)".

### Parameters On and Off

The actual value of another already-programmed function the on threshold On and the off threshold Off. You can use the actual values of the following functions:

- Analog threshold trigger (Page 196) (actual value  $A_x$ )
- Analog amplifier (Page 208) (actual value  $A_x$ )
- Analog multiplexer (Page 226) (actual value AQ)
- Analog ramp (Page 228) (actual value AQ)
- Mathematic instruction (Page 239) (actual value AQ)
- PI controller (Page 232) (actual value AQ)

- Up/down counter (Page 186) (actual value Cnt)
- Analog filter (Page 244) (actual value AQ)
- Average value (Page 249) (actual value AQ)
- Max/Min (Page 246) (actual value AQ)
- On-delay (Page 152) (current time Ta)
- Off-delay (Page 155) (current time Ta)
- On-/off-delay (Page 157) (current time Ta)
- Retentive on-delay (Page 159) (current time Ta)
- Wiping relay (pulse output) (Page 160) (current time Ta)
- Edge-triggered wiping relay (Page 162) (current time Ta)
- Asynchronous pulse generator (Page 164) (current time Ta)
- Stairway lighting switch (Page 168) (current time Ta)
- Multiple function switch (Page 170) (current time Ta)
- Stopwatch (Page 183) (actual value AQ)
- Analog comparator (actual value Ax - Ay)
- Threshold trigger (Page 193) (actual value Fre)

Select the required function by the block number.

### Parameter p (number of decimals)

Applies only to Ax, Ay, On, Off and  $\Delta$  values displayed in a message text.

Does not apply to the comparison of on and off values! (The compare function ignores the decimal point.)

### Timing diagram

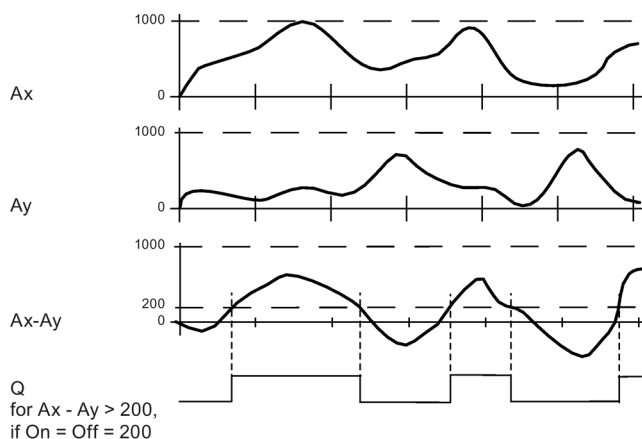

## Functional description

The function fetches the analog values from the inputs Ax and Ay.

Ax and Ay are each multiplied by the value of the A (gain) parameter, and the value at parameter B (offset) is then added to the relevant product, i.e.

$(Ax \cdot \text{gain}) + \text{offset} = \text{actual value Ax}$  or

$(Ay \cdot \text{gain}) + \text{offset} = \text{actual value Ay}$ .

The function forms the difference ("Δ") between the actual values Ax - Ay.

Output Q is set or reset, depending on difference of the actual values Ax - Ay and the set thresholds. See the calculation rule below.

## Calculation rule

- If the On threshold  $\geq$  Off threshold, then Q = 1 if (actual value Ax - actual value Ay) > On or Q = 0 if (actual value Ax - actual value Ay)  $\leq$  Off.
- If the On threshold < Off threshold, then Q = 1, if On  $\leq$  (actual value Ax - actual value Ay) < Off.

## Setting the Par parameter

The gain and offset parameters are used to adapt the sensors to the relevant application.

View in programming mode:

B3	1/1 +/-	← Parameter protection mode
On	=+0	← On threshold
Off	=+0	← Off threshold
A	=+0.00	← Gain
B	=+0	← Offset
P	=0	← Decimals in the message text

## Example

In a heating control system, the supply  $T_v$  and return line temperatures  $T_r$  are to be compared, for example with a sensor at AI2.

A control signal is to be triggered (for example "heater On") when the difference between the supply and return line temperatures is greater than 15 °C. The control signal is reset when the difference is less than 5 °C.

The process variable of the temperature is to be shown in parameter assignment mode.

The thermocouples available have the following technical data: -30 °C to +70 °C, 0 VDC to 10 VDC.

Application	Internal mapping
-30 °C to 70 °C = 0 VDC to 10 VDC	0 to 1000
0 °C	300 → Offset = -30
Range of values: -30 °C to 70 °C = 100	1000 → Gain = 100/1000 = 0.1

Application	Internal mapping
On threshold = 15 °C	Threshold = 15
Off threshold = 5 °C	Threshold = 5
See also topic "Calculating the gain and offset of analog values (Page 145)".	

Configuration (example):

B3	1/1 +/	← Parameter protection mode
On	==+15	← On threshold
Off	==+5	← Off threshold
A	==+0.10	← Gain
B	== -30	← Offset
P	=0	← Decimals in the message text (if used)

View in parameter assignment mode (example):

B3	1/1	
On	==+15	← On threshold
Off	==+5	← Off threshold
Ax	==+10	← Temperature values
Ay	== -20	
Δ	==+30	← Q=1 (Δ>On)

View in the message text (example):

Ax ==+10
Ay ==-20

### Reducing the input response of the analog comparator

You can selectively delay the output of an analog comparator by means of the "On-delay" and "Off-delay" special functions. With on-delay, output Q is only set if the pulse width of the triggering signal at input Trg (=analog comparator output) is longer than the on-delay time.

Using this method, you will obtain a virtual hysteresis and reduce the input response to short signals.

### Function block diagram

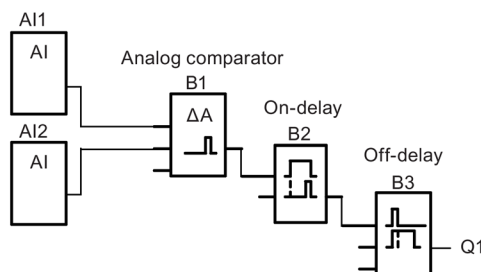



## 4.4.21 Analog watchdog

### Short description

This special function saves the process variable of an analog input to memory, and sets the output when the output variable exceeds or drops below this stored value plus a configurable offset.

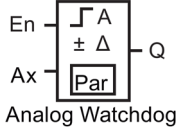
Symbol in LOGO!	Wiring	Description
 <p>En — <math>\int</math> A  <math>\pm \Delta</math>          Ax — Par          Analog Watchdog — Q</p>	Input En	A positive edge (0 to 1 transition) at input En saves the analog value at input Ax ("Aen") to memory and starts monitoring of the analog range $Aen - \Delta_2$ to $Aen + \Delta_1$
	Input Ax	Input Ax is one of the following analog signals: <ul style="list-style-type: none"> <li>• AI1 to AI8 (*)</li> <li>• AM1 to AM64</li> <li>• NAI1 to NAI32</li> <li>• AQ1 to AQ8</li> <li>• NAQ1 to NAQ16</li> <li>• Block number of a function with analog output</li> </ul>
	Parameter	A: gain Range of values: -10.00 to 10.00 B: zero offset Range of values: -10,000 to 10,000 $\Delta_1$ : difference value above Aen: on/off threshold Range of values: 0 to 20,000 $\Delta_2$ : difference value below Aen: on/off threshold Range of values: 0 to 20,000 p: number of decimals Range of values: 0, 1, 2, 3 Retentivity: / = no retentivity R = the status is retentive in memory
	Output Q	Q is set/reset, depending on the stored analog value and the offset.

\* AI1...AI8: 0...10 V corresponds with 0...1000 (internal value).

### Gain and offset parameters

For more information on gain and offset parameters, refer to topic "Calculating the gain and offset of analog values (Page 145)".

### Parameters Delta1 and Delta2

The actual value of another already-programmed function the Delta1 and Delta2 parameters. You can use the actual value of the following functions:

- Analog comparator (Page 201) (actual value Ax – Ay)
- Analog threshold trigger (Page 196) (actual value Ax)
- Analog amplifier (Page 208) (actual value Ax)
- Analog multiplexer (Page 226) (actual value AQ)
- Analog ramp (Page 228) (actual value AQ)
- Mathematic instruction (Page 239) (actual value AQ)
- PI controller (Page 232) (actual value AQ)
- Up/down counter (Page 186) (actual value Cnt)
- Analog filter (Page 244) (actual value AQ)
- Average value (Page 249) (actual value AQ)
- Max/Min (Page 246) (actual value AQ)
- On-delay (Page 152) (current time Ta)
- Off-delay (Page 155) (current time Ta)
- On-/off-delay (Page 157) (current time Ta)
- Retentive on-delay (Page 159) (current time Ta)
- Wiping relay (pulse output) (Page 160) (current time Ta)
- Edge-triggered wiping relay (Page 162) (current time Ta)
- Asynchronous pulse generator (Page 164) (current time Ta)
- Stairway lighting switch (Page 168) (current time Ta)
- Multiple function switch (Page 170) (current time Ta)
- Stopwatch (Page 183) (actual value AQ)
- Threshold trigger (Page 193) (actual value Fre)

Select the required function by the block number.

### Parameter p (number of decimals)

Applies only to the Aen, Ax,  $\Delta_1$  and  $\Delta_2$  values displayed in a message text.

## Timing diagram

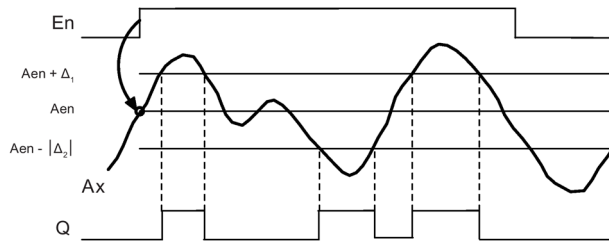

## Functional description

A 0 to 1 transition at input En saves the value of the signal at the analog input Ax. This saved process variable is referred to as "Aen".

Both the analog actual values Ax and Aen are multiplied by the value at parameter A (gain), and parameter B (offset) is then added to the product:

$(Ax \cdot \text{gain}) + \text{offset} = \text{Actual value Aen}$ , when input En changes from 0 to 1, or

$(Ax \cdot \text{gain}) + \text{offset} = \text{Actual value Ax}$ .

Output Q is set when the signal at input En = 1 and if the actual value at input Ax is out of range of  $Aen - \Delta_2$  to  $Aen + \Delta_1$ .

Output Q is reset, when the actual value at input Ax lies within the range of  $Aen - \Delta_2$  to  $Aen + \Delta_1$ , or when the signal at input En changes to lo.

## Setting the Par parameter

The gain and offset parameters are used to adapt the used sensors to the respective application.

View in programming mode:

B3	1/1	+/	← Parameter protection mode
Δ1	=0		← Differential value for the on/off threshold
Δ2	=0		←
A	=+0.00		← Gain
B	=+0		← Offset
P	=0		← Decimals in the message text

View in parameter assignment mode (example):

B3	1/1		
Ax	=+5		← Q = 1 (Ax is out of the range of Aen - Δ2 to Aen + Δ1)
Aen	=-20		
Δ1	=10		
Δ2	=10		

## 4.4.22 Analog amplifier

### Short description

This special function amplifies the value of an analog input and outputs the result at an analog output.

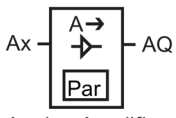
Symbol in LOGO!	Wiring	Description
 <p>Analog Amplifier</p>	Input Ax	Input Ax is one of the following analog signals: <ul style="list-style-type: none"> <li>• AI1 to AI8 (*)</li> <li>• AM1 to AM64</li> <li>• NAI1 to NAI32</li> <li>• AQ1 to AQ8</li> <li>• NAQ1 to NAQ16</li> <li>• Block number of a function with analog output</li> </ul>
	Parameter	A: gain Range of values: -10.00 to 10.00 B: zero offset Range of values: -10,000 to 10,000 p: number of decimals Range of values: 0, 1, 2, 3
	Output AQ	This special function has an analog output. This output can only be connected with analog inputs, analog flags, analog outputs or network analog outputs. Range of values for AQ: -32767 to 32767
* AI1...AI8: 0 V to 10 V corresponds with 0 to 1000 (internal value).		

### Gain and offset parameters

Please note the information on gain and offset parameters in topic Calculating the gain and offset of analog values (Page 145).

### Parameter p (number of decimals)

Applies only to the AQ value in a message text.

### Functional description

The function fetches the analog signal of input Ax.

This value is multiplied by the value of the A (gain) parameter, and parameter B (offset) is then added to the product:  $(Ax \cdot \text{gain}) + \text{offset} = \text{actual value Ax}$ .

The actual value Ax is output at AQ.

## Analog output

If you interconnect this special function with a real analog output, note that the analog output can only process values between 0 and 1000. To do this, you may need to connect an additional amplifier between the analog output of the special function and the real analog output. Using this amplifier, you standardize the output range of the special function to a value range of 0 to 1000.

## Scaling an analog input value

You can influence the analog input value of a potentiometer by interconnecting an analog input with an analog amplifier and an analog flag.

- Scale the analog value at the analog amplifier for further use.
- Connect, for example, the time base for parameter T of a time function (e.g. On-/Off-delay (Page 157)) or the on and/or off limit specification of an up/down counter (Page 186) to the scaled analog value.

For more information with programming examples refer to the Online Help for LOGO!Soft Comfort.

## Setting the Par parameter

The gain and offset parameters are used to adapt the sensors to the relevant application.

View in programming mode (example):

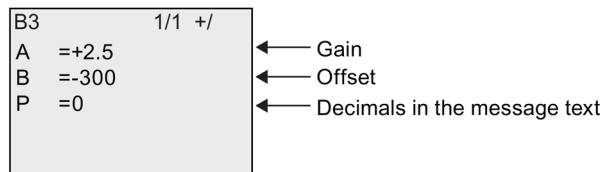

View in parameter assignment mode (example):

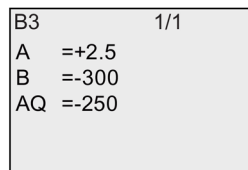

### 4.4.23 Latching relay

#### Short description

Input S sets output Q, input R resets output Q again.

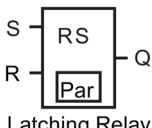
Symbol in LOGO!	Wiring	Description
 <p>Latching Relay</p>	Input S	You set output Q with a signal at input S.
	Input R	You reset output Q with a signal at input R. If S and R = 1, the output is reset.
	Parameter	Retentivity: / = no retentivity R = the status is retentive.
	Output Q	Q is set with a signal at input S, and reset with a signal at input R.

#### Timing diagram

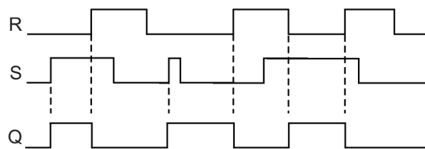

#### Switching response

A latching relay represents a simple binary element. The output value depends on the status at the inputs and on the previous output status. The following table shows the logic once again:

S <sub>n</sub>	R <sub>n</sub>	Q	Comment
0	0	x	The status is retentive
0	1	0	Reset
1	0	1	Set
1	1	0	Reset (takes priority over Set)

When retentivity is enabled, the current status of the output signal is retained after a power failure.

## 4.4.24 Pulse relay

### Short description

A short pulse at the input sets and resets the output.

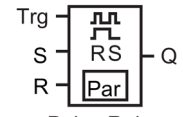
Symbol in LOGO!	Wiring	Description
 <p>Pulse Relay</p>	Input Trg	You set and reset output Q with a signal at input Trg (Trigger).
	Input S	You set output Q with a signal at input S.
	Input R	You reset output Q with a signal at input R.
	Parameter	Selection: RS (R input priority) or SR (S input priority)  Retentivity: / = no retentivity R = the status is retentive.
	Output Q	Q is set with a signal at Trg, and reset with the next signal at Trg, if S and R = 0.

### Timing diagram

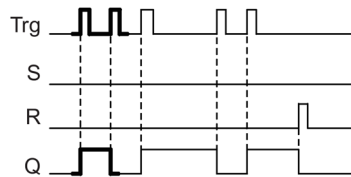

The bold printed section of the timing diagram is also shown in the symbol for the pulse relay.

### Functional description

Output Q changes its status; that is, the output is set or reset with each 0 to 1 transition at input Trg and if the inputs S and R = 0.

The signal at input Trg does not influence the special function when S or R = 1.

You set the pulse relay with a signal at input S. The output is set hi.

You reset the pulse relay with a signal at input R. The output is set lo.

### Status diagram

Par	Q <sub>n-1</sub>	S	R	Trg	Q <sub>n</sub>
*	0	0	0	0	0
*	<b>0</b>	0	0	0 ->1	<b>1**</b>
*	0	0	1	0	0
*	0	0	1	0 ->1	0
*	0	1	0	0	1
*	0	1	0	0 ->1	1
RS	0	1	1	0	0

Par	Q <sub>n-1</sub>	S	R	Trg	Q <sub>n</sub>
RS	0	1	1	0 ->1	0
SR	0	1	1	0	1
SR	0	1	1	0 ->1	1
*	1	0	0	0	1
*	<b>1</b>	0	0	0 ->1	0**
*	1	0	1	0	0
*	1	0	1	0 ->1	0
*	1	1	0	0	1
*	1	1	0	0 ->1	1
RS	1	1	1	0	0
RS	1	1	1	0 ->1	0
SR	1	1	1	0	1
SR	1	1	1	0 ->1	1

\*: RS or SR

\*\* : Triggering signal is effective, because S and R = 0.

Depending on your configuration, either input R takes priority over input S (input S is not effective when R = 1), or vice versa (input R is not effective when S = 1).

After a power failure, the pulse relay and output Q are reset if you have not enabled retentivity.

View in programming mode:

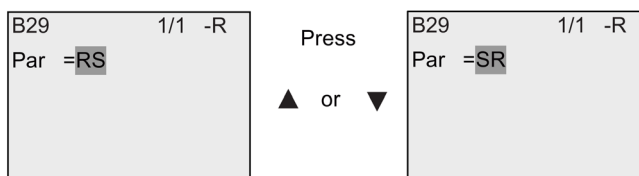

This special function is not available in parameter assignment mode.

**Note**

If Trg = 0 and Par = RS, the special function "Pulse relay" corresponds with the special function "Latching relay (Page 210)".

**4.4.25 Message texts**

**Short description**

With the message text function block, you can configure a message that includes text and other parameters for LOGO! to display in RUN mode.

You can configure simple message texts from the LOGO! onboard display. LOGO!Soft Comfort provides an extended set of features for message texts: bar graph representation of data,



names for digital I/O states and more. Refer to the LOGO!Soft Comfort documentation for information on these features.

## Global message text settings

You configure global parameters that apply to all message texts on the programming menu:

- **Analog time:** refresh rate in milliseconds that specifies how frequently analog inputs in message texts are updated
- **Tick time:** frequency at which message texts scroll on and off the display  
There are two ways that a message text can tick on and off the screen: line by line, or character by character, which are described in more detail below. A line of a text message, or each character of a text message in turn will tick on and off the LOGO! onboard display based on the tick time. For a message that ticks line by line, the actual tick time is ten times the configured tick time. For messages that tick character by character, the actual tick time is the configured tick time.
- **Current character set:** which character set is selected for the display of message texts. Options Set1 and Set2 can be any of the supported character sets for LOGO!:

Character set in LOGO!	Common name	Supported languages	Internet reference
ISO8859-1	Latin-1	English, German, Italian, Spanish (partly), Dutch (partly)	<a href="http://en.wikipedia.org/wiki/ISO/IEC_8859-1">http://en.wikipedia.org/wiki/ISO/IEC_8859-1</a>
ISO8859-5	Cyrillic	Russian	<a href="http://en.wikipedia.org/wiki/ISO/IEC_8859-5">http://en.wikipedia.org/wiki/ISO/IEC_8859-5</a>
ISO8859-9	Latin-5	Turkish	<a href="http://en.wikipedia.org/wiki/ISO/IEC_8859-9">http://en.wikipedia.org/wiki/ISO/IEC_8859-9</a>
ISO8859-16	Latin-10	French	<a href="http://en.wikipedia.org/wiki/ISO/IEC_8859-16">http://en.wikipedia.org/wiki/ISO/IEC_8859-16</a>
GB-2312	Chinese	Chinese	<a href="http://en.wikipedia.org/wiki/GB2312">http://en.wikipedia.org/wiki/GB2312</a>
Shift-JIS	Japanese	Japanese	<a href="http://en.wikipedia.org/wiki/Shift-jis">http://en.wikipedia.org/wiki/Shift-jis</a>

Of the 50 possible message texts that you can configure, you can select any number of them to be from the first language and any number from the second language. For example, you could configure 50 message text function blocks that have a single message text for Character Set 1. Alternatively, you could configure twenty-five message text function blocks, each of which has two message texts: one for Character Set 1 and one for Character Set 2. Any combination is valid such that the total does not exceed 50.

Within a single message text, the text must be from one character set. You can edit message texts in any of the supported character sets from LOGO!Soft Comfort. From LOGO! Basic, you can only edit text using characters from the ISO8859-1 character set.

The language and therefore character set of a message text is independent of the language setting for menus on the LOGO! onboard display. They can be different.

## Chinese character set

LOGO! Basic and the LOGO! TDE support the Chinese character set (GB-2312) for the People's Republic of China. The devices use Microsoft Windows encoding for this character set. The Windows encoding allows the devices to display the same characters as shown in the LOGO!Soft Comfort message text editor when you are using a Chinese emulator or a Chinese version of Microsoft Windows.

The Chinese character set requires a Chinese version of Windows or a Chinese emulator to properly display Chinese characters in the LOGO!Soft Comfort message text editor. You must start the Chinese emulator before you open the message text function block in LOGO!Soft Comfort.

### Programming global message text parameters

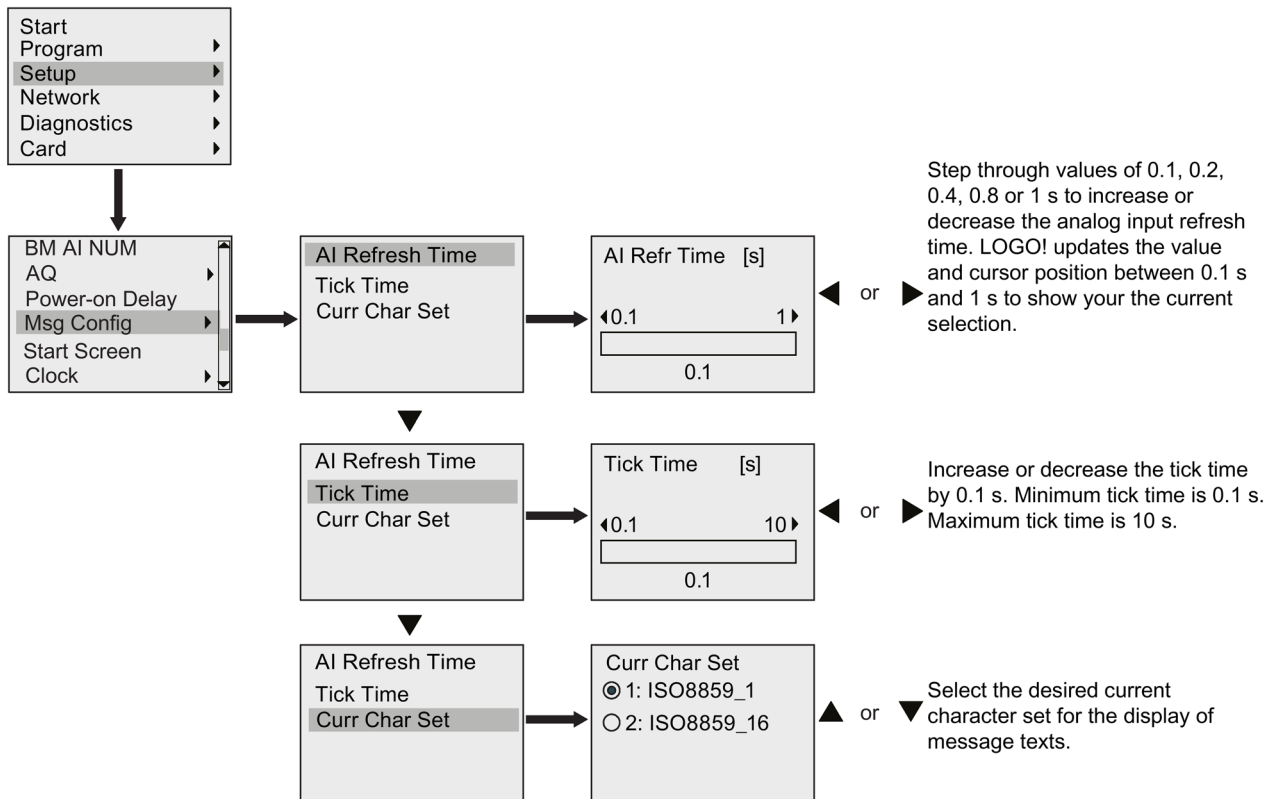

## Message text function block

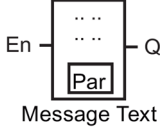
Symbol in LOGO!	Wiring	Description
	Input En	A 0 to 1 transition at input En (Enable) starts the output of the message text.
	Parameter	<p>Ack: acknowledgment of the message text</p> <p>Msg Text: input of the message text</p> <p>Priority: priority of the message text</p> <p>Range of values: 0 to 127</p> <p>Tick Type:</p> <ul style="list-style-type: none"> <li>• C-C: tick message character by character</li> <li>• L-L: tick message line by line</li> </ul> <p>Msg. Dst: message destination (BM, TDE or Both)</p> <p>Web Show: show LOGO! Basic on Web server</p> <p>Line tick settings (to define whether a line ticks):</p> <ul style="list-style-type: none"> <li>• Line1 Tick</li> <li>• Line2 Tick</li> <li>• Line3 Tick</li> <li>• Line4 Tick</li> <li>• Line5 Tick</li> <li>• Line6 Tick</li> </ul> <p><b>Note:</b> You can only edit the Text parameter of the message from LOGO! Basic. ISO8859-1 is the only available character set for editing text. You can edit all other parameters, and other languages for the Text parameter from LOGO!Soft Comfort. For configuration details, refer to the Online Help for LOGO!Soft Comfort.</p>
	Output Q	Q remains set as long as the message text is set.

### Restriction

A maximum of 50 message text blocks are available.

### Functional description

When LOGO! is in RUN mode, LOGO! displays the message text that you have configured along with its parameter values upon a 0 to 1 transition of the signal at input En.

Based on your setting for the message destination, the message text displays on the LOGO! onboard display, the LOGO! TDE, or both.

If you use flag M27 in your circuit program, then if M27=0 (low) then LOGO! displays the message text only if it is from the primary character set (Character Set 1). If M27=1 (high), then LOGO! displays the message text only if it is from the secondary character set (Character Set 2). (See the M27 flag description in topic Constants and connectors (Page 130)).

If you have configured message ticking, the message will tick on and off the display according to your specifications, either a character at a time, or a line at a time.

If acknowledgment is disabled (Ack = No), the message text is hidden when the status of the signal at input En changes from 1 to 0.

If acknowledgment is enabled (Ack = Yes) and the status of the signal at input En changes from 1 to 0, the message text is output until it is acknowledged with **OK**. When En = 1, you cannot acknowledge the message text.

When multiple message text functions are triggered with En=1, LOGO! displays the message text with the highest priority (0 = lowest, 127 = highest). This also means that LOGO! displays a newly activated message text only if its priority is higher than that of previously activated message texts.

After a message text is disabled or acknowledged, the function automatically shows the previously active message text that takes the highest priority.

You can press the ▲ and ▼ keys to step through multiple active message texts.

### Example

This is how two message texts could be shown:

Display field of LOGO! in RUN mode

```
Motor 5
STOP AT
10:12
!!Action!!
START AT
11:30
```

Example: Message text with priority 30

Press  
▼ ▲

```
Motor 2
3000
hours
MAINTENANCE
START AT
13:30
```

Example: Message text with priority 10

Press  
▼ ▲

```
Mo 09:00
2003-01-27
```

Date and current time-of-day  
(only for versions with real-time clock)

### Message ticking

You can configure message text lines to tick or not tick. Two types of message ticking exist:

- Character by character
- Line by line

Messages that tick character by character scroll off the characters of the message line one character at a time to the left with the additional characters scrolling in one at a time from the right. The time interval for the tick is specified by the TickTime message text setting.

Messages that tick line by line scroll one half of the message off the display to the left with the second half of the message scrolling in from the right. The time interval for the tick is ten times the TickTime parameter. The two halves of the message simply alternate on the LOGO! onboard display or LOGO! TDE.

**Example: tick message character by character**

The following illustration shows a one-line, 24-character message text:

X <sub>1</sub>	X <sub>2</sub>	X <sub>3</sub>	X <sub>4</sub>	X <sub>5</sub>	X <sub>6</sub>	X <sub>7</sub>	X <sub>8</sub>	X <sub>9</sub>	X <sub>10</sub>	X <sub>11</sub>	X <sub>12</sub>	X <sub>13</sub>	X <sub>14</sub>	X <sub>15</sub>	X <sub>16</sub>	X <sub>17</sub>	X <sub>18</sub>	X <sub>19</sub>	X <sub>20</sub>	X <sub>21</sub>	X <sub>22</sub>	X <sub>23</sub>	X <sub>24</sub>	

If you set this message to tick "character by character" with a tick interval of 0.1 seconds, then the initial appearance of this message line on the LOGO! onboard display or LOGO! TDE is as shown in this illustration:

X <sub>1</sub> X <sub>2</sub> X <sub>3</sub> X <sub>4</sub> X <sub>5</sub> X <sub>6</sub> X <sub>7</sub> X <sub>8</sub> X <sub>9</sub> X <sub>10</sub> X <sub>11</sub> X <sub>12</sub>	X <sub>13</sub> X <sub>14</sub> X <sub>15</sub> X <sub>16</sub> X <sub>17</sub> X <sub>18</sub> X <sub>19</sub> X <sub>20</sub> X <sub>21</sub> X <sub>22</sub> X <sub>23</sub> X <sub>24</sub>
--	---

After 0.1 second, one character of the message line ticks. The message appears as follows on the LOGO! onboard display or LOGO! TDE:

X <sub>2</sub> X <sub>3</sub> X <sub>4</sub> X <sub>5</sub> X <sub>6</sub> X <sub>7</sub> X <sub>8</sub> X <sub>9</sub> X <sub>10</sub> X <sub>11</sub> X <sub>12</sub> X <sub>13</sub>	X <sub>14</sub> X <sub>15</sub> X <sub>16</sub> X <sub>17</sub> X <sub>18</sub> X <sub>19</sub> X <sub>20</sub> X <sub>21</sub> X <sub>22</sub> X <sub>23</sub> X <sub>24</sub> X <sub>1</sub>
---	--

**Example: tick message line by line**

The following example uses the same message configuration as the previous example:

X <sub>1</sub>	X <sub>2</sub>	X <sub>3</sub>	X <sub>4</sub>	X <sub>5</sub>	X <sub>6</sub>	X <sub>7</sub>	X <sub>8</sub>	X <sub>9</sub>	X <sub>10</sub>	X <sub>11</sub>	X <sub>12</sub>	X <sub>13</sub>	X <sub>14</sub>	X <sub>15</sub>	X <sub>16</sub>	X <sub>17</sub>	X <sub>18</sub>	X <sub>19</sub>	X <sub>20</sub>	X <sub>21</sub>	X <sub>22</sub>	X <sub>23</sub>	X <sub>24</sub>	

If you set this message to tick "line by line" with a tick interval of 0.1 seconds, then the initial appearance of this message on the LOGO! onboard display or LOGO! TDE is the left half of the message as shown in this illustration:

X <sub>1</sub> X <sub>2</sub> X <sub>3</sub> X <sub>4</sub> X <sub>5</sub> X <sub>6</sub> X <sub>7</sub> X <sub>8</sub> X <sub>9</sub> X <sub>10</sub> X <sub>11</sub> X <sub>12</sub>	X <sub>13</sub> X <sub>14</sub> X <sub>15</sub> X <sub>16</sub> X <sub>17</sub> X <sub>18</sub> X <sub>19</sub> X <sub>20</sub> X <sub>21</sub> X <sub>22</sub> X <sub>23</sub> X <sub>24</sub>
--	---

After 1 second (10 x 0.1 second), the message ticks to show the right half of the message as shown in this illustration:

X13 X14 X15 X16 X17 X18 X19 X20 X21 X22 X23 X24 X1 X2 X3 X4 X5 X6 X7 X8 X9 X10 X11 X12

The screen display alternates between the two message halves every second.

You can configure each individual line of a message text to tick or not tick. The "character by character" or "line by line" setting applies to all lines that you configure to tick.

### Setting the Par parameter

From the input P, you configure the following characteristics of the message text:

- Priority
- Acknowledgement
- Message destination
- Tick type, and tick setting for each line

View in programming mode:

B33	1/3	+/	← "+" means: The parameters and actual values in an active message text can be edited
Ack	=No		← Status of the acknowledgement
Msg Text	= . . .		
Priority	=000		← Priority
Tick Type	=C-C		
Msg. Dst	=TDE		

1. Press ► to position the cursor on the "ACK" line.
2. Press **OK**. Enable "Ack": Press ▲ or ▼
3. Position the cursor on the "Msg Text" line by pressing ►. Press **OK** twice. To select a line for the message text, press ▲ and ▼. LOGO! shows as follows:

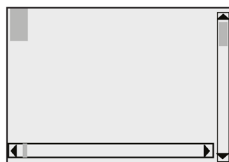

4. Press ▲ and ▼ to select the letter to be displayed in the text. To move the cursor from one position to another, press ◀ and ▶.

---

#### Note

The list of available characters is the same as for the circuit program name. The character set is found in topic Circuit program input (Page 79). When you enter message text from LOGO! Basic, you can only enter characters from the ISO8859-1 character set. To enter text from another language, you must enter the text in LOGO!Soft Comfort.

Note that the number of characters per line of message text can be greater than the number of character positions on the LOGO! onboard display.

---

5. Confirm your entries with **OK**.
6. Press ► to position the cursor on the "Priority" line.

7. Increase the priority by pressing ▲.
8. Press ► to position the cursor on the "Msg. Dst" line.

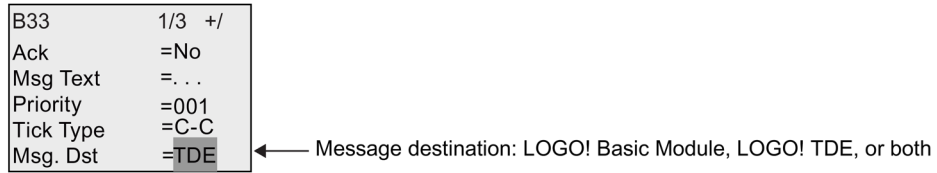

9. Press ▲ or ▼ to toggle through the three choices for message destination: BM, TDE, or Both.
10. Press ◀ to position the cursor on the "Tick Type" line.

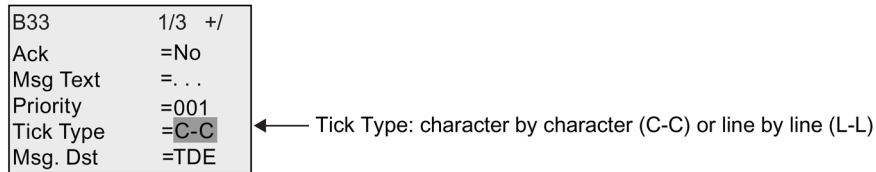

11. Press ▲ or ▼ to select either "C-C" or "L-L" for the "Tick Type".
12. Enable or disable ticking for each line of the message text by pressing ►. LOGO! displays as follows:

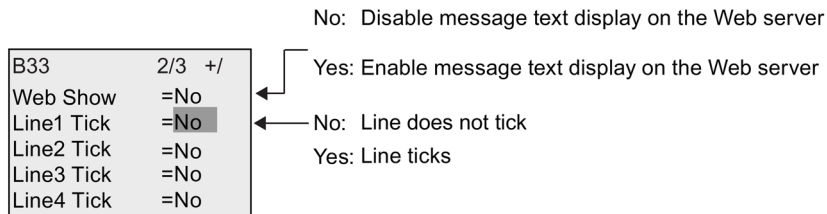

13. To choose between "No" and "Yes" to define whether Line 1 ticks, press ▲ or ▼
14. Press ► to move the cursor to the second line, and press ▲ or ▼ to choose between "No" and "Yes" for Line 2. Configure line ticking for lines 3, 4, 5 and 6 in the same way as for lines 1 and 2.
15. Position the cursor on the "Web Show" line by pressing ►. Press ▲ or ▼ to select between "No" and "Yes" for "Web Show".
16. Press OK to confirm the complete message text configuration.

### Visible parameters or process variables

The following parameters or process variables can be displayed in a message text, as either numerical values or bar-graph representations of values:

Special function	Parameter or process variable visible in a message text
Timers	
On-delay	T, T <sub>a</sub>
Off-delay	T, T <sub>a</sub>
On-/Off-delay	T <sub>a</sub> , TH, TL

Special function	Parameter or process variable visible in a message text
Retentive on-delay	T, T <sub>a</sub>
Wiping relay (pulse output)	T, T <sub>a</sub>
Edge triggered wiping relay	T <sub>a</sub> , TH, TL
Asynchronous pulse generator	T <sub>a</sub> , TH, TL
Random generator	T <sub>H</sub> , TL
Stairway lighting switch	T <sub>a</sub> , T, T!, T!L
Multiple function switch	T <sub>a</sub> , T, TL, T!, T!L
Weekly timer	3*on/off/day
Yearly timer	On, Off
Astronomical clock	Longitude, latitude, zone, TS, TR
Stopwatch	TB, T <sub>a</sub> , Lap, AQ
Counter	
Up/down counter	Cnt, On, Off
Hours counter	MI, Q, OT
Threshold trigger	f <sub>a</sub> , On, Off, G_T
Analog	
Analog threshold trigger	On, Off, A, B, Ax
Analog differential trigger	On, n, A, B, Ax, Off
Analog comparator	On, Off, A, B, Ax, Ay, nA
Analog watchdog	n, A, B, Ax, Aen
Analog amplifier	A, B, Ax
Analog multiplexer	V1, V2, V3, V4, AQ
Analog ramp	L1, L2, MaxL, StSp, Rate, A, B, AQ
PI controller	SP, Mq, KC, TI, Min, Max, A, B, PV, AQ
Mathematic instruction	V1, V2, V3, V4, AQ
PWM (Pulse Width Modulator)	A, B, T, Ax amplified
Miscellaneous	
Latching relay	-
Pulse relay	-
Message texts	-
Softkey	On/Off
Shift register	-
Analog filter	Sn, Ax, AQ
Max/Min	Mode, Min, Max, Ax, AQ
Average value	Ax, St, Sn, AQ
Float /Integer Converter	Typ, VM, Res, eAx, Aq,
Integer/Float Converter	Typ, VM, Res, eAx, eAq, Aq,

For timers, a message text can also display the remaining time. "Remaining time" refers to how much time of the parameter setting remains.

Bar graphs can be either horizontal or vertical representations of the current or actual value scaled between the minimum and maximum value. For more information on configuring and displaying bar graphs in message texts, refer to the Online Help for LOGO!Soft Comfort.



## Editing message texts

You can only edit simple message texts from LOGO! Basic. You cannot edit message texts that contain features such as bar graphs, I/O status names, and others from LOGO! Basic. You can only edit these types of message texts from LOGO!Soft Comfort.

Also, you **cannot** edit message texts from LOGO! Basic that contain any of the following parameters:

- Par
- Time
- Date
- EnTime
- EnDate
- Analog input
- Digital I/O status
- Special characters (for example: ±, €)

You can only edit such message texts from LOGO!Soft Comfort.

## Changing parameters in the active message text

When the message text is active, press **ESC** to select the editing mode.

---

### Note

You must keep the **ESC** key pressed for at least one second.

---

Press ◀ and ▶ to select the relevant parameter. Press **OK** to change the parameter. Use the ▲ and ▼ keys to edit a parameter.

Confirm your changes with **OK**. You can now edit further parameters in the message text (if any exist). Press **ESC** to exit editing mode.



## Key input simulation in the active message text

You can enable the four cursor keys C ▲, C ▼, C ◀ and C ▶ in an active message text by pressing **ESC** plus the relevant cursor key.

## 4.4.26 Softkey

### Short description

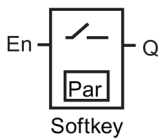
This special function has the effect of a mechanical pushbutton or switch.

Symbol in LOGO!	Wiring	Description
 <p>En —  — Q  <div style="border: 1px solid black; padding: 2px; display: inline-block;">Par</div>  Softkey</p>	Input En	Output Q is set with a 0 to 1 transition of the signal at input En (Enable), and if "Switch=On" was confirmed in parameter assignment mode.
	Parameter	Programming mode: Selecting the function for pushbutton action for the duration of one cycle, or for switching action. Start: on or off state, initialized at the first start of the program. Retentivity: / = no retentivity R = the status is retentive. Parameter assignment mode (RUN mode): Switch: switches the momentary pushbutton (switch) on or off.
	Output Q	Switches on if En=1 and Switch=On was confirmed with <b>OK</b> .

### Factory setting

The default parameter setting is switching action.

### Timing diagram

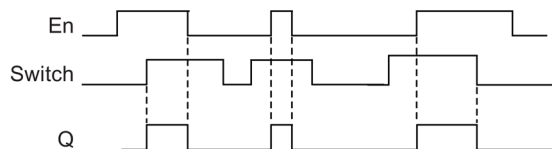

### Functional description

In parameter assignment mode, the output is set with a signal at input En, if the "Switch" parameter is set to "On" and confirmed with **OK**. Whether the function was configured for pushbutton or switching action is of no concern here.

The output is reset to "0" in the following three cases:

- After a 1 to 0 transition at input En
- When the function was configured for momentary pushbutton action, and one cycle has expired since it was switched on
- When the position "Off" was selected at the "Switch" parameter and confirmed with **OK** in parameter assignment mode

If retentivity is not set, output Q is initialized after a power failure according to your configuration at the "Start" parameter.

### Setting the Par parameter

View in programming mode (example):

1. Position the cursor on "Par". Press **OK**.
2. Press **▶** to position the cursor on the "On" line.

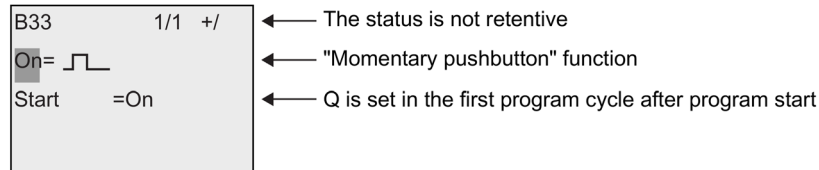

3. Press **OK**. Select "Momentary pushbutton" or "Switch": Press **▲** or **▼**.

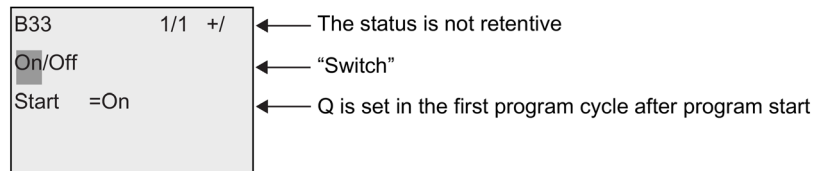

4. Press **▶** to move the cursor to "Start" line.
5. To change the "Start" state: Press **▲** or **▼**.

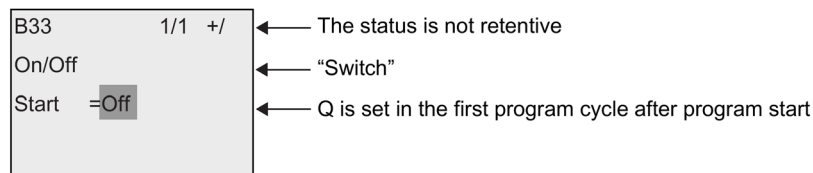

6. Confirm your entries with **OK**.

View in parameter assignment mode (example):

Here, you can set or reset the "Switch" parameter (On/Off). When in RUN, LOGO! shows the following display:

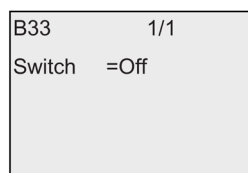

Let us assume you want to set "Switch" (On).

1. Press **OK** (the cursor is now positioned on "Off").
2. To change from "Off" to "On": Press **▲** or **▼**.
3. Confirm your entries with **OK**.

### 4.4.27 Shift register

#### Short description

You can use the shift register function to read the value of an input and to shift its bits left or right. The output value corresponds with the configured shift register bit. The shifting direction can be changed at a special input.

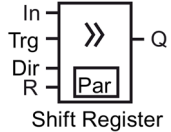
Symbol in LOGO!	Wiring	Description
 <p>Shift Register</p>	Input In	Input read at the start of the function.
	Input Trg	A positive edge (0 to 1 transition) at input Trg (Trigger) starts the special function. 1 to 0 transitions are irrelevant.
	Input Dir	The signal at input Dir determines the shifting direction for the shift register bits Sx.1 to Sx.8. "x" refers to the configured shift register byte index 1, 2, 3, or 4. Dir = 0: shift up (Sx.1>>Sx.8) Dir = 1: shift down (Sx.8>>Sx.1)
	Input R	The SFB is reset with a positive edge (0 to 1 transition) at input R (Reset). All the shift register bit (Sx.1 to Sx.8) are set to 0 when the SFB is reset.
	Parameter	Shift register bit that determines the value at output Q. Possible settings: Byte index: 1 to 4 Q: S1 to S8 LOGO! provides a maximum of 32 shift register bits, with eight bits per shift register. Retentivity: I = no retentivity R = the status is retentive.
	Output Q	The output value corresponds with the configured shift register bit.

#### Functional description

The function reads the value at input In with a positive edge (0 to 1 transition) at input Trg (Trigger).

This value is applied to shift register bit Sx.1 or Sx.8 depending on the shifting direction, where "x" refers to the index number of the shift register and the number after the decimal point refers to the bit number:

- Shift up: the value at input In is set at Sx.1; the previous value at Sx.1 is shifted to Sx.2; the previous value at Sx.2 is shifted to Sx.3 etc.
- Shift down: the value at input In is set at Sx.8; the previous value at Sx.8 is shifted to Sx.7; the previous value at Sx.7 is shifted to Sx.6 etc.

Output Q returns the value of the configured shift register bit.

If retentivity is disabled, the shift function restarts at Sx.1 or Sx.8 after a power failure. When enabled, retentivity always applies to all shift register bits.

**Note**

There are a maximum of four shift register function blocks available for use in the circuit program in LOGO!.

**Timing diagram**

The timing diagram example for the shift register in LOGO! is shown as follows:

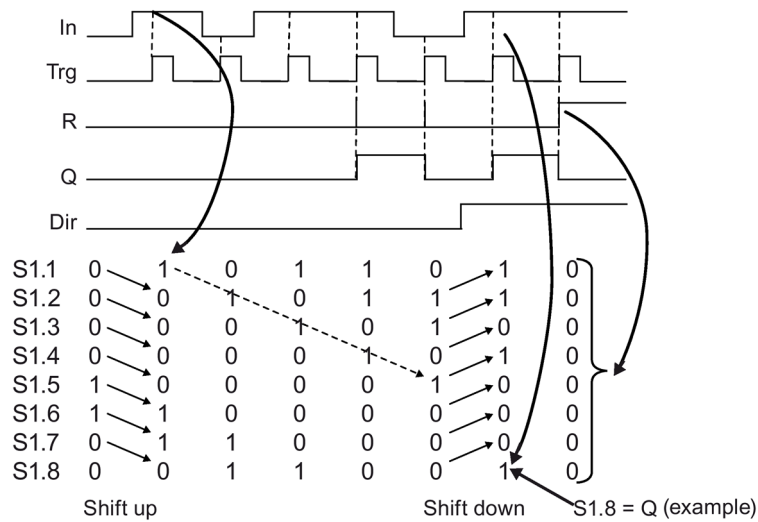

**Setting the Par parameter**

View in programming mode (example):

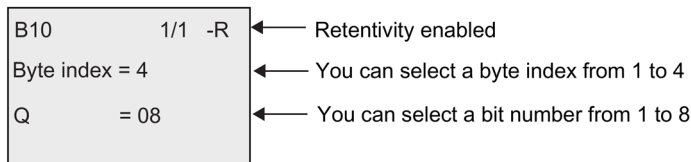

The view above indicates that the configured shift register bit is S4.8.

This special function is not available in parameter assignment mode.

## 4.4.28 Analog multiplexer

### Short description

This special function outputs one of four predefined analog values or 0 at the analog output.

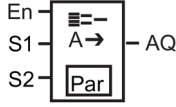
Symbol in LOGO!	Wiring	Description
 <p>En S1 S2 Analog MUX</p>	Input En	A change in status from 0 to 1 at input En (Enable) switches a parameterized analog value to the output AQ, depending on the value of S1 and S2.
	Inputs S1 and S2	<p>S1 and S2 (selectors) for selecting the analog value to be issued.</p> <ul style="list-style-type: none"> <li>S1 = 0 and S2 = 0: value 1 is issued.</li> <li>S1 = 0 and S2 = 1: value 2 is issued.</li> <li>S1 = 1 and S2 = 0: value 3 is issued.</li> <li>S1 = 1 and S2 = 1: value 4 is issued.</li> </ul>
	Parameter	<p>V1 to V4: analog values that will be issued. Range of values: -32768 to 32767</p> <p>p: number of decimals Range of values: 0, 1, 2, 3</p>
	Output AQ	<p>This special function has an analog output. This output can only be connected with analog inputs, analog flags, analog outputs or network analog outputs. Range of values for AQ: -32768 to 32767</p>

### Parameters V1...V4

The analog values for the parameters V1 to V4 can be derived from another already-programmed function. You can use the actual values of the following functions:

- Analog comparator (Page 201) (actual value Ax – Ay)
- Analog threshold trigger (Page 196) (actual value Ax)
- Analog amplifier (Page 208) (actual value Ax)
- Analog ramp (Page 228) (actual value AQ)
- Mathematic instruction (Page 239) (actual value AQ)
- PI controller (Page 232) (actual value AQ)
- Up/down counter (Page 186) (actual value Cnt)
- Analog multiplexer (actual value AQ)
- Analog filter (Page 244) (actual value AQ)
- Average value (Page 249) (actual value AQ)
- Max/Min (Page 246) (actual value AQ)

- On-delay (Page 152) (current time Ta)
- Off-delay (Page 155) (current time Ta)
- On-/off-delay (Page 157) (current time Ta)
- Retentive on-delay (Page 159) (current time Ta)
- Wiping relay (pulse output) (Page 160) (current time Ta)
- Edge-triggered wiping relay (Page 162) (current time Ta)
- Asynchronous pulse generator (Page 164) (current time Ta)
- Stairway lighting switch (Page 168) (current time Ta)
- Multiple function switch (Page 170) (current time Ta)
- Stopwatch (Page 183) (actual value AQ)
- Threshold trigger (Page 193) (actual value Fre)

Select the required function by the block number. For information on parameter defaults, refer to the On-delay (Page 152) topic.

### Parameter p (number of decimals)

Applies only to the values displayed in a message text.

### Timing diagram

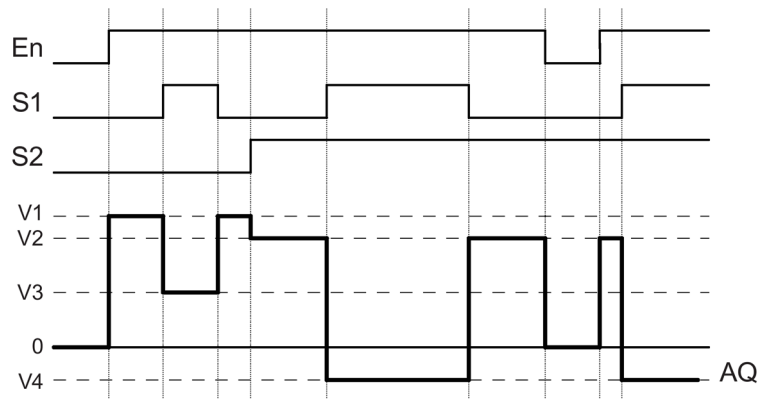

### Functional description

If input En is set, then the function issues one of four possible analog values V1 to V4 at the output AQ, depending on the value of S1 and S2.

If the input En is not set, then the function issues the analog value 0 at output AQ.

### Analog output

If you interconnect this special function with a real analog output, note that the analog output can only process values between 0 and 1000. To do this, you may need to connect an additional amplifier between the analog output of the special function and the real analog output. Using this amplifier, you standardize the output range of the special function to a value range of 0 to 1000.

### Setting the Par parameter

View in programming mode (example):

B3	1/1	+/
V1	=+4000	
V2	=-2000	
V3	=+0	
V4	=+0	
p	=0	

View in parameter assignment mode:

B3	1/1
V1	=+4000
V2	=-2000
V3	=+0
V4	=+0
AQ	=+0

## 4.4.29 Analog ramp

### Short description

This function allows the output to be changed from the current level to the selected level at a specified rate.

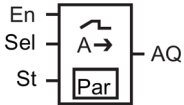
Symbol in LOGO!	Wiring	Description
 <p>En Sel St AQ Par Analog Ramp</p>	Input En	A change in the status from 0 to 1 at input En (Enable) applies the start/stop level (Offset "B" + StSp) to the output for 100 ms and starts the ramp operation to the selected level. A change in the status from 1 to 0 immediately sets the current level to Offset "B", which makes output AQ equal to 0.
	Input Sel	Sel = 0: level 1 is selected. Sel = 1: level 2 is selected. A change in status of Sel causes the current level to start changing to the selected level at the specified rate.



Symbol in LOGO!	Wiring	Description
	Input St	A change in the status from 0 to 1 at input St (Decelerated Stop) causes the current level to decrease at a constant rate until the start/stop level (Offset "B" + StSp) is reached. The start/stop level is maintained for 100 ms and then the current level is set to Offset "B", which makes output AQ equal to 0.
	Parameter	<p>Level 1 and Level 2: levels to be reached Range of values for each level: -10000 to 20000</p> <p>MaxL: maximum value that must not be exceeded under any circumstances. Range of values: -10000 to 20000</p> <p>StSp: Start/Stop offset: value that is added to Offset "B" to create the start/stop level. If the Start/Stop offset is 0, then the start/stop level is Offset "B". Range of values: 0 to 20000</p> <p>Rate: acceleration with which level 1, level 2 or Offset is reached. Steps/seconds are issued. Range of values: 1 to 10000</p> <p>A: gain Range of values: 0 to 10.00</p> <p>B: offset Range of values: -10000 to 10000</p> <p>p: number of decimals Range of values: 0, 1, 2, 3</p>
	Output AQ	<p>Range of values for AQ: 0 to 32767</p> <p>(Current Level - Offset "B") / Gain "A"</p> <p>Range of values: 0 to 32767</p> <p><b>Note:</b> When AQ is displayed in parameter mode or message mode, it is displayed as a scaled value, both on the LOGO! Base Module and LOGO!Soft Comfort (engineering units: current level).</p>

## Parameters L1, L2

The analog values for the parameters L1 and L2 can be derived from another already-programmed function. You can use the actual values of the following functions:

- Analog comparator (Page 201) (actual value Ax – Ay)
- Analog threshold trigger (Page 196) (actual value Ax)
- Analog amplifier (Page 208) (actual value Ax)
- Analog multiplexer (Page 226) (actual value AQ)

- Mathematic instruction (Page 239) (actual value AQ)
- PI controller (Page 232) (actual value AQ)
- Up/down counter (Page 186) (actual value Cnt)
- Analog filter (Page 244) (actual value AQ)
- Average value (Page 249) (actual value AQ)
- Max/Min (Page 246) (actual value AQ)
- On-delay (Page 152) (current time Ta)
- Off-delay (Page 155) (current time Ta)
- On-/off-delay (Page 157) (current time Ta)
- Retentive on-delay (Page 159) (current time Ta)
- Wiping relay (pulse output) (Page 160) (current time Ta)
- Edge-triggered wiping relay (Page 162) (current time Ta)
- Asynchronous pulse generator (Page 164) (current time Ta)
- Stairway lighting switch (Page 168) (current time Ta)
- Multiple function switch (Page 170) (current time Ta)
- Stopwatch (Page 183) (actual value AQ)
- Analog ramp (actual value AQ)
- Threshold trigger (Page 193) (actual value Fre)

Select the required function by the block number. For information on parameter defaults, refer to the On-delay (Page 152) topic.

### Parameter p (number of decimals)

Applies only to the AQ, L1, L2, MaxL, StSp and Rate values displayed in a message text.

### Timing diagram for current level

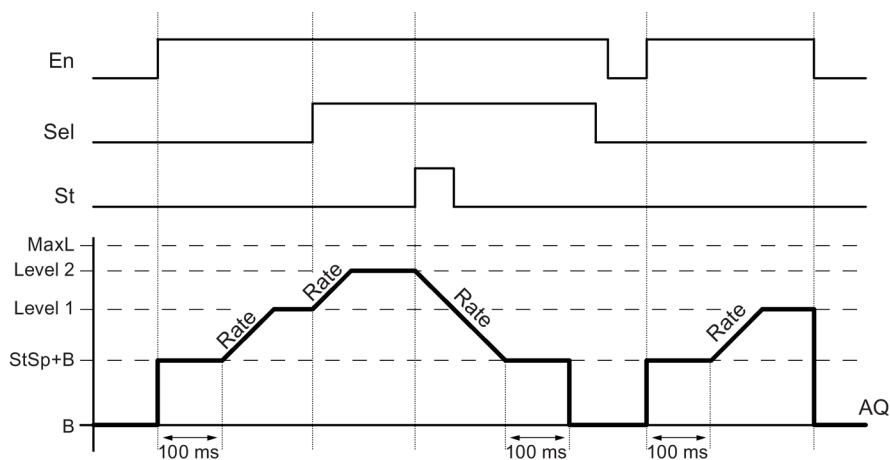

## Functional description

If the input En is set, then the function sets the current level to StSp + Offset "B" for 100 ms. Then, depending on the connection of Sel, the function runs from the level StSp + Offset "B" to either level 1 or level 2 at the acceleration set in Rate.

If the input St is set, the function runs to a level of StSp + Offset "B" at the acceleration set in Rate. Then the function holds the level at StSp + Offset "B" for 100 ms. After 100 ms, the level is set to Offset "B". The scaled value (output AQ) is 0.

If the input St is set, the function can only be restarted after the inputs St and En have been reset.

If input Sel has been changed, depending on the connection of Sel, the function runs from the current target level to the new target level at the rate that is specified.

If the input En is reset, the function immediately sets the current level to Offset "B".

The current level is updated every 100 ms. Note the following relationship between output AQ and the current level:

$$\text{Output AQ} = (\text{current level} - \text{Offset "B"}) / \text{Gain "A"}$$

---

### Note

For further information on analog value processing, please refer to the Online Help for LOGO!Soft Comfort.

---

## Setting the Par parameter

View in programming mode (example):

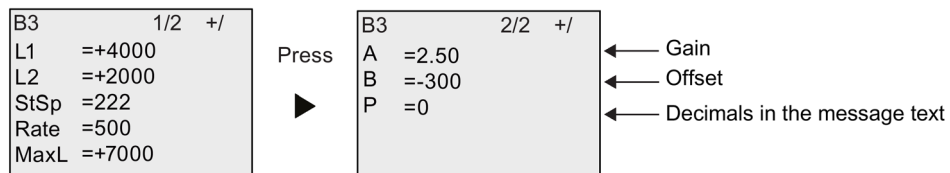

View in parameter assignment mode:



### 4.4.30 PI controller

#### Short description

Proportional-action and integral-action controllers. You can use both types of controller individually or combined.

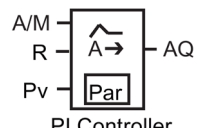
Symbol in LOGO!	Wiring	Description
 <p>A/M R Pv AQ Par PI Controller</p>	Input A/M	Set the mode of the controller: 1: automatic mode 0: manual mode
	Input R	Use the input R to reset the output AQ. As long as this input is set, the input A/M is disabled. Output AQ is set to 0.
	Input PV	Analog value: process variable, influences the output
	Parameter	SP: set-value assignment Range of values: -10,000 to 20,000  KC: gain Range of values: 00.00 to 99.99  TI: integral time Range of values: 00:01m to 99:59 m  Dir: action direction of the controller Range of values: + or -  Mq: value from AQ with manual mode Range of values: 0 to 1,000  Min: minimum value for PV Range of values: -10,000 to 20,000  Max: maximum value for PV Range of values: -10,000 to 20,000  A: gain Range of values: -10.00 to 10.00  B: offset Range of values: -10,000 to 10,000  p: number of decimals Range of values: 0, 1, 2, 3
Output AQ	This special function has an analog output (= manipulated variable). This output can only be connected with analog inputs, analog flags, analog outputs or network analog outputs. Range of values for AQ: 0 to 1,000	

## Parameters SP and Mq

The set-value SP and the value for Mq can be provided by another already-programmed function. You can use the actual values of the following functions:

- Analog comparator (Page 201) (actual value Ax – Ay)
- Analog threshold trigger (Page 196) (actual value Ax)
- Analog amplifier (Page 208) (actual value Ax)
- Analog multiplexer (Page 226) (actual value AQ)
- Analog ramp (Page 228) (actual value AQ)
- Mathematic instruction (Page 239) (actual value AQ)
- Up/down counter (Page 186) (actual value Cnt)
- Analog filter (Page 244) (actual value AQ)
- Average value (Page 249) (actual value AQ)
- Max/Min (Page 246) (actual value AQ)
- On-delay (Page 152) (current time Ta)
- Off-delay (Page 155) (current time Ta)
- On-/off-delay (Page 157) (current time Ta)
- Retentive on-delay (Page 159) (current time Ta)
- Wiping relay (pulse output) (Page 160) (current time Ta)
- Edge-triggered wiping relay (Page 162) (current time Ta)
- Asynchronous pulse generator (Page 164) (current time Ta)
- Stairway lighting switch (Page 168) (current time Ta)
- Multiple function switch (Page 170) (current time Ta)
- Stopwatch (Page 183) (actual value AQ)
- PI controller (actual value AQ)
- Threshold trigger (Page 193) (actual value Fre)

Select the required function by the block number. For information on parameter defaults, refer to the On-delay (Page 152) topic.

## Parameters KC, TI

Please note the following circumstances:

- If parameter KC has value 0, the "P" function (proportional control) will not be executed.
- If parameter TI has value 99:59 m, the "I" function (integral-action control) will not be executed.

## Parameter p (number of decimals)

Applies only to the PV, SP, Min and Max values displayed in a message text.

## Timing diagram

The nature, manner and speed with which the AQ changes depend on the parameters KC and TI. Thus, the course of AQ in the diagram is merely an example. A control action is continuous; therefore the diagram portrays just an extract.

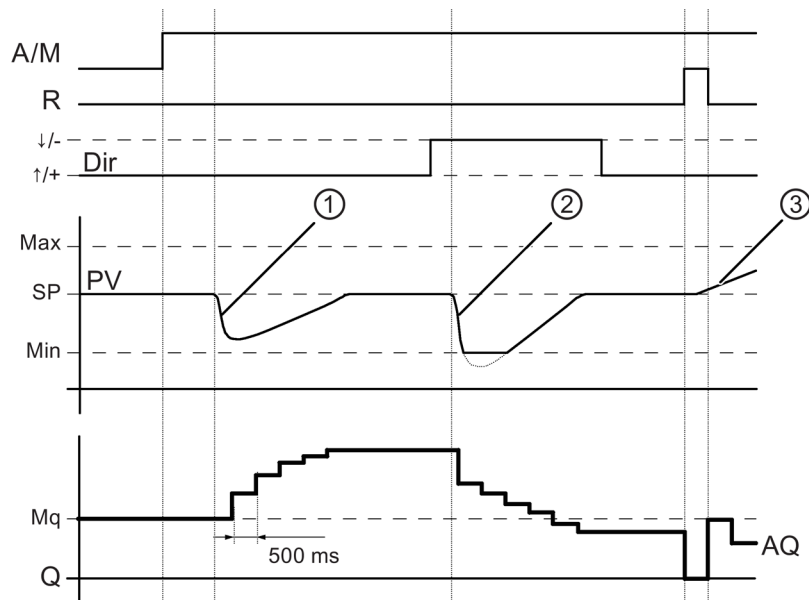

1. A disturbance causes the PV to drop, as Dir is positioned upwards, AQ increases until PV corresponds again to SP.
2. A disturbance causes the PV to drop, as Dir is positioned downwards, AQ decreases until PV corresponds again to SP.  
It is not possible to change the direction (Dir) at runtime of the function. The change is shown here for illustrative purposes only.
3. As AQ is set to 0 by means of the input R, PV changes. This is based on the fact that PV increases, which on account of Dir = upwards causes AQ to drop.

## Functional description

If the input A/M is set to 0, then the special function issues output AQ with the value that you set with parameter Mq.

If the input A/M is set to 1, then automatic mode commences. As an integral sum the value Mq is adopted, the controller function begins the calculations.

---

### Note

For further information on the controller basics, please refer to the Online Help for LOGO!Soft Comfort.

---

The updated value PV is used to calculate in the formulas:

Updated value  $PV = (PV \cdot \text{gain}) + \text{offset}$

- If the updated value  $PV = SP$ , then the special function does not change the value of AQ.
- Dir = upwards (+) (timing diagram numbers 1. and 3.)
  - If the updated value  $PV > SP$ , then the special function reduces the value of AQ.
  - If the updated value  $PV < SP$ , then the special function increases the value of AQ.
- Dir = downwards (-) (timing diagram number 2.)
  - If the updated value  $PV > SP$ , then the special function increases the value of AQ.
  - If the updated value  $PV < SP$ , then the special function reduces the value of AQ.

With a disturbance, AQ continues to increase / decrease until the updated value PV again corresponds to SP. The speed with which AQ changes depends on the parameters KC and TI.

If the input PV exceeds the parameter Max, then the updated value PV is set to the value of Max. If the PV falls short of the parameter Min, then the updated value PV is set to the value of Min.

If the input R is set to 1, then the AQ output is reset. As long as R is set, the input A/M is disabled.

## Sampling time

The sampling time is fixed at 500 ms.

## Parameter sets

For more information and application examples with application-related parameter sets for KC, TI and Dir, refer to the Online Help for LOGO!Soft Comfort.

## Setting the Par parameter

View in programming mode (example):



View in parameter assignment mode:

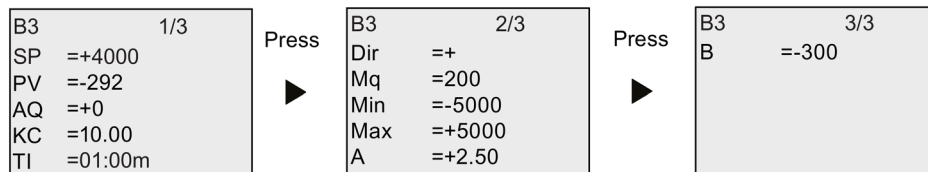

### 4.4.31 Pulse width modulator (PWM)

#### Short description

The Pulse Width Modulator (PWM) instruction modulates the analog input value  $A_x$  to a pulsed digital output signal. The pulse width is proportional to the analog value  $A_x$ .

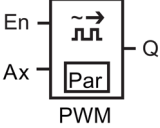
Symbol in LOGO!	Wiring	Description
	Input En	A positive edge (0 to 1 transition) at input En enables the PWM function block.
	Input $A_x$	Analog signal to be modulated to a pulsed digital output signal.
	Parameter	A: gain Range of values: -10.00 to 10.00 B: zero offset Range of values: 10,000 to 10,000 T: periodic time over which the digital output is modulated p: number of decimals Range of values: 0, 1, 2, 3 Min: Range of values: -20,000 to 20,000 Max: Range of values: -20,000 to 20,000
	Output Q	Q is set or reset for the proportion of each time period according to the proportion of the standardized value $A_x$ to the analog value range.

#### Parameter T

Note the defaults of the T parameters listed in topic Time response (Page 143).

The periodic time T can be provided by the actual value of another already-programmed function. You can use the actual value of the following functions:

- Analog comparator (Page 201) (actual value  $A_x - A_y$ )
- Analog threshold trigger (Page 196) (actual value  $A_x$ )
- Analog amplifier (Page 208) (actual value  $A_x$ )
- Analog multiplexer (Page 226) (actual value AQ)
- Analog ramp (Page 228) (actual value AQ)
- Mathematic instruction (Page 239) (actual value AQ)
- PI controller (Page 232) (actual value AQ)
- Up/down counter (Page 186) (actual value Cnt)
- Analog filter (Page 244) (actual value AQ)
- Average value (Page 249) (actual value AQ)
- Max/Min (Page 246) (actual value AQ)
- On-delay (Page 152) (current time  $T_a$ )



- Off-delay (Page 155) (current time Ta)
- On-/off-delay (Page 157) (current time Ta)
- Retentive on-delay (Page 159) (current time Ta)
- Wiping relay (pulse output) (Page 160) (current time Ta)
- Edge-triggered wiping relay (Page 162) (current time Ta)
- Asynchronous pulse generator (Page 164) (current time Ta)
- Stairway lighting switch (Page 168) (current time Ta)
- Multiple function switch (Page 170) (current time Ta)
- Stopwatch (Page 183) (actual value AQ)
- Threshold trigger (Page 193) (actual value Fre)

Select the required function by the block number. The timebase is configurable. For information on valid ranges and parameter defaults, refer to the On-delay (Page 152) topic.

### Parameters p (number of decimals)

Parameter p applies only to the display of the Ax value in a message text.

### Functional description

The function reads the value of the signal at the analog input Ax. This value is multiplied by the value of parameter A (gain). Parameter B (offset) is added to the product, as follows:

$$(Ax \cdot \text{Gain}) + \text{Offset} = \text{Actual value Ax}$$

The function block calculates the proportion of the actual value Ax to the range. The block sets the digital output Q high for the same proportion of the T (periodic time) parameter, and sets Q low for the remainder of the time period.

### Examples with timing diagrams

The following examples show how the PWM instruction modulates a digital output signal from the analog input value:

#### Example 1

Analog input value: 500 (range 0 to 1,000)

Periodic time T: four seconds

The digital output of the PWM function is 2 seconds high, 2 seconds low, 2 seconds high, 2 seconds low and continues in that pattern as long as parameter "En" = high.

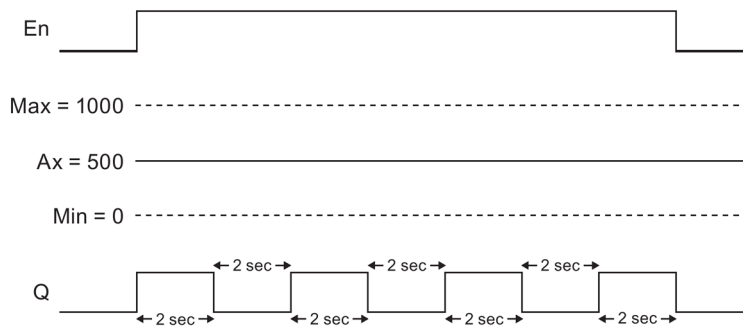

**Example 2**

Analog input value: 300 (range 0 to 1,000)

Periodic time T: 10 seconds

The digital output of the PWM function is three seconds high, seven seconds low, three seconds high, seven seconds low and continues in that pattern as long as parameter "En" = high.

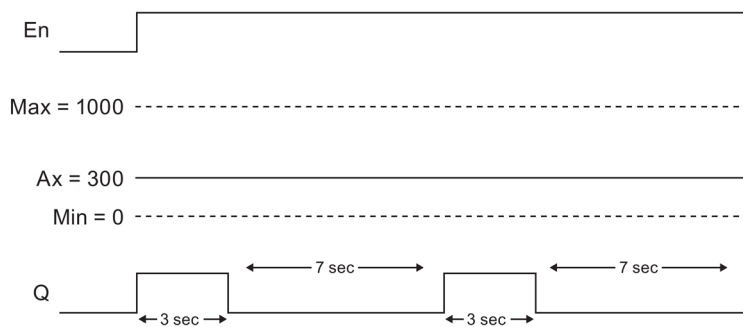

**Calculation rule**

$Q = 1$ , for  $(Ax - Min) / (Max - Min)$  of time period T, when  $Min < Ax < Max$ .  
 $Q = 0$ , for  $PT - [(Ax - Min) / (Max - Min)]$  of periodic time T.

**Note:** Ax in this calculation refers to the actual value Ax as calculated using the Gain and Offset.

**Setting the Par Parameter**

The following illustration shows the view in programming mode that corresponds to the first example:

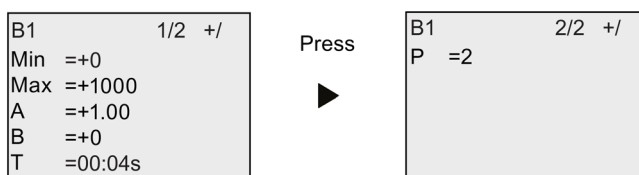

View in parameter assignment mode:

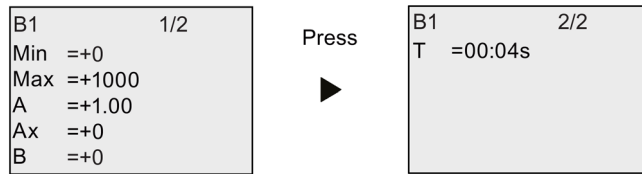

### 4.4.32 Mathematic instruction

#### Short description

The mathematic instruction block calculates the value AQ of an equation formed from the user-defined operands and operators.

Symbol in LOGO!	Wiring	Description
	Input En	A change in the status from 0 to 1 at input En (Enable) enables the mathematic instruction function block.
	Parameter	<b>V1:</b> first operand value <b>V2:</b> second operand value <b>V3:</b> third operand value <b>V4:</b> fourth operand value  <b>Op1:</b> first operator <b>Op2:</b> second operator <b>Op3:</b> third operator  <b>Operator Prio:</b> priority of the operands  <b>Qen→0:</b> 0: reset value of AQ to 0 when En=0 1: retain last value of AQ when En=0 <b>p:</b> number of decimals Range of values: 0, 1, 2, 3
	Output AQ	The output AQ is the result of the equation formed from the operand values and operators. AQ will be set to 32767 if a divide by 0 or overflow occurs, and -32768 if a negative overflow (underflow) occurs.

#### Parameters V1 to V4

Another already-programmed function can provide the analog values for the parameters V1 to V4. You can use the actual values of the following functions:

- Analog comparator (Page 201) (actual value Ax – Ay)
- Analog threshold trigger (Page 196) (actual value Ax)
- Analog amplifier (Page 208) (actual value Ax)
- Analog multiplexer (Page 226) (actual value AQ)
- Analog ramp (Page 228) (actual value AQ)
- PI controller (Page 232) (actual value AQ)

- Up/down counter (Page 186) (actual value Cnt)
- Analog filter (Page 244) (actual value AQ)
- Average value (Page 249) (actual value AQ)
- Max/Min (Page 246) (actual value AQ)
- On-delay (Page 152) (current time Ta)
- Off-delay (Page 155) (current time Ta)
- On-/off-delay (Page 157) (current time Ta)
- Retentive on-delay (Page 159) (current time Ta)
- Wiping relay (pulse output) (Page 160) (current time Ta)
- Edge-triggered wiping relay (Page 162) (current time Ta)
- Asynchronous pulse generator (Page 164) (current time Ta)
- Stairway lighting switch (Page 168) (current time Ta)
- Multiple function switch (Page 170) (current time Ta)
- Stopwatch (Page 183) (actual value AQ)
- Mathematic instruction (actual value AQ)
- Threshold trigger (Page 193) (actual value Fre)

Select the required function by the block number. For information on parameter defaults, refer to the On-delay (Page 152) topic.

---

**Note**

If the analog value for parameter V1, V2, V3 or V4 is derived from another already-programmed function whose actual value exceeds the value range for V1 to V4, LOGO! will display the limit value -32768 if the value is less than the lower range or 32767 if the value is greater than the upper range.

---

**Parameters p (number of decimals)**

Parameter p applies only to the display of Value1, Value2, Value3, Value4 and AQ in a message text.

**Functional description**

The mathematic instruction function combines the four operations and three operators to form an equation. The operator can be any one of the four standard operators: +, -, \*, or /. The priority of operators is determined by "(" and "[", in which "(" has a higher priority. The operand values can reference another previously-defined function to provide the value. The mathematic instruction function rounds the result to the nearest integer value.

The number of operand values is fixed at four and the number of operators is fixed at 3. If you need to use fewer operands, use constructions such as + 0 or \* 1 to fill the remaining parameters.

You can also configure the behavior of the function when the Enable parameter  $En=0$ . The function block can either retain its last value, or be set to 0. If the parameter  $Qen \rightarrow 0 = 0$ , then the function sets AQ to 0 when  $En=0$ . If the parameter  $Qen \rightarrow 0 = 1$ , then the function leaves AQ at its last value when  $En=0$ .

### Possible errors: zero division and overflow

If the mathematic instruction function block execution results in zero division or overflow, it sets internal bits that indicate the type of error that occurred. You can program a mathematic instruction error detection function block in your circuit program to detect these errors, and to control the program behavior as needed. You program one mathematic instruction error detection function block to reference one specific mathematic instruction function block.

### Examples

The following tables show some simple example mathematic instruction block parameters, and the resulting equations and output values:

V1	Op1 (Priority)	V2	Op2 (Priority)	V3	Op3 (Priority)	V4
12	[+]	6	(/)	3	-	1

Equation:  $[12 + (6 / 3)] - 1$

Result: 13

V1	Op1 (Priority)	V2	Op2 (Priority)	V3	Op3 (Priority)	V4
2	+	3	[*]	1	(+)	4

Equation:  $2 + [3 * (1 + 4)]$

Result: 17

V1	Op1 (Priority)	V2	Op2 (Priority)	V3	Op3 (Priority)	V4
100	(-)	25	/	2	[+]	1

Equation:  $(100 - 25) / [2 + 1]$

Result: 25

### Setting the Par parameter

The following illustration shows the view in programming mode that corresponds to the first example  $[12 + (6 / 3)] - 1$ :

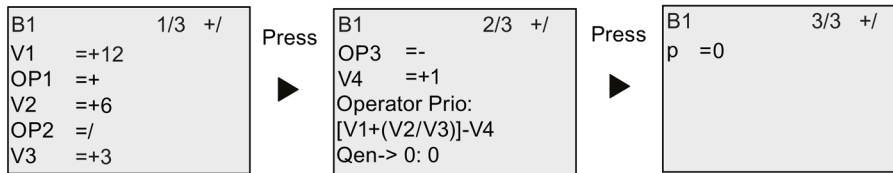

View in parameter assignment mode:

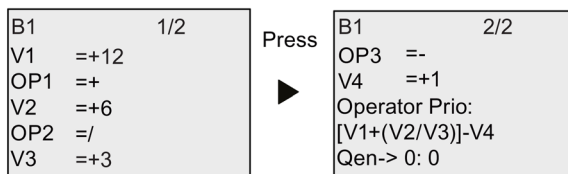

### 4.4.33 Mathematic instruction error detection

#### Short description

The mathematic instruction error detection block sets an output if an error has occurred in the referenced Mathematic instruction (Page 239) function block.

Symbol in LOGO!	Wiring	Description
<p>Math.ErrorDetect</p>	Input En	A change in the status from 0 to 1 at input En (Enable) enables the mathematic instruction error detection block.
	Input R	A signal at input R resets the output.
	Parameter	MathBN: block number of a mathematic instruction Err: ZD: divide by 0 error OF: overflow error ZD/OF: (divide by 0 error) OR (overflow error) AutoRst: reset the output before the next execution of the mathematic instruction error function block. Y = yes; N = no
	Output Q	Q is set high if the error to detect occurred in the last execution referenced mathematic instruction function block.

#### Parameter MathBN

The value for the MathBN parameter references the block number of an already-programmed mathematic instruction function block.

## Functional description

The mathematic instruction error detection block sets the output when the referenced mathematic instruction function block has an error. You can program the function to set the output on a zero division error, an overflow error, or when either type of error occurs.

If AutoRst is set, the output is reset prior to the next execution of the function block. If AutoRst is not set, then whenever the output is set it remains set until the mathematic instruction error detection block is reset with the R parameter. In this way, even if the error subsequently clears, the circuit program still has knowledge that an error did occur at some point.

In any scan cycle, if the referenced mathematic instruction function block executes before the mathematic instruction error detection function block, the error is detected in the same scan cycle. If the referenced mathematic instruction function block executes after the mathematic instruction error detection function block, the error is detected in the next scan cycle.

## Mathematic instruction error detection logic table

In the table below, Err represents the parameter of the mathematic instruction error detection instruction that selects which type of error to detect. ZD represents the zero division bit set by the mathematic instruction at the end of its execution: 1 if the error occurred, 0 if not. OF represents the overflow bit set by the mathematic instruction: 1 if the error occurred, 0 if not. The ZD/OF Err parameter represents the logical OR of the zero division bit and overflow bit of the referenced mathematic instruction. Q represents the output of the mathematic instruction error detection function. An "x" indicates that the bit can be either 0 or 1 with no influence on the output.

Err	ZD	OF	Q
ZD	1	x	1
ZD	0	x	0
OF	x	1	1
OF	x	0	0
ZD/OF	1	0	1
ZD/OF	0	1	1
ZD/OF	1	1	1
ZD/OF	0	0	0

If the MathBN parameter is null, then the output Q is always 0.

## Setting the Par parameter

The parameters MathBN, AutoRst, and Err can be set in programming mode or parameter assignment mode.

View in programming mode (example):

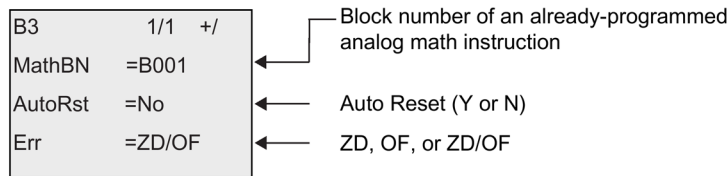

View in parameter assignment mode (example):

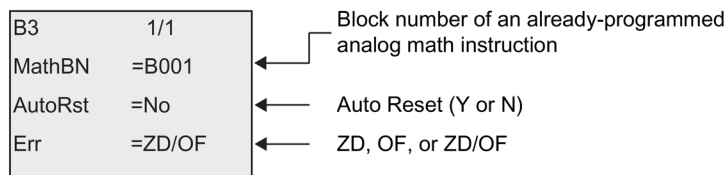

### 4.4.34 Analog filter

#### Short description

The analog filter function smooths the analog input signal.

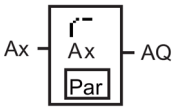
Symbol in LOGO!	Wiring	Description
 <p>Analog Filter</p>	Ax	Input Ax is the analog input signal to be smoothed. Input Ax is one of the following analog signals: <ul style="list-style-type: none"> <li>• AI1 to AI8 (*)</li> <li>• AM1 to AM64</li> <li>• NAI1 to NAI32</li> <li>• AQ1 to AQ8</li> <li>• NAQ1 to NAQ16</li> <li>• Block number of a function with analog output</li> </ul>
	Parameter	<b>Sn</b> (Number of samples) determines how many analog values are sampled within the program cycles that are determined by the set number of samples. LOGO! samples an analog value within every program cycle. The number of program cycles is equal to the set number of samples. Possible settings: 8, 16, 32, 64, 128, 256
	Output AQ	AQ is the average value of input Ax over the current number of samples.
* AI1 to AI8: 0 V to 10 V corresponds with 0 to 1000 (internal value).		



### Timing diagram (example)

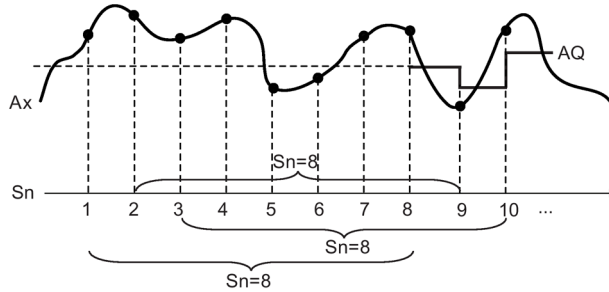

### Functional description

The function fetches the analog signal at input  $A_x$  based on the set number of samples ( $S_n$ ) and outputs the average value.

#### Note

There are a maximum of eight analog filter function blocks available for use in the circuit program in LOGO!.

### Setting the Par parameter

View in programming mode (example):

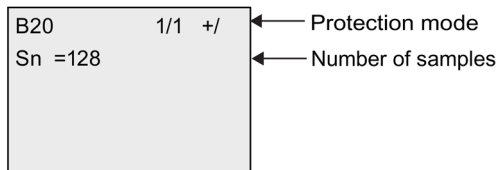

View in parameter assignment mode (example):

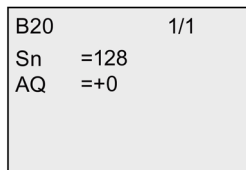

### 4.4.35 Max/Min

#### Short description

The Max/Min function records the maximum or minimum value of Ax.

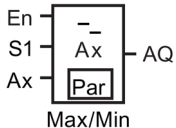
Symbol in LOGO!	Wiring	Description
	En	A signal at input En (Enable) outputs an analog value to AQ, depending on the settings of parameters ERst and Mode.
	S1	S1 functions only when the parameter Mode is set to 2. If Mode is set to 2, a change in status from 0 to 1 at input S1 (selector) outputs the maximum value to AQ. If Mode is set to 2, a change in status from 1 to 0 at S1 outputs the minimum value to AQ.
	Ax	Input Ax is one of the following analog signals: <ul style="list-style-type: none"> <li>• AI1 to AI8 (*)</li> <li>• AM1 to AM64</li> <li>• NAI1 to NAI32</li> <li>• AQ1 to AQ8</li> <li>• NAQ1 to NAQ16</li> <li>• Block number of a function with analog output</li> </ul>
	Parameter	<b>Mode:</b> Possible settings: 0, 1, 2, 3 Mode = 0: AQ = Min Mode = 1: AQ = Max Mode = 2 and S1= 0 (low): AQ = Min Mode = 2 and S1= 1 (high): AQ = Max Mode = 3: AQ = Actual value of Ax <b>ERst (Enable Reset):</b> Possible settings: ERst = 0: disable reset ERst = 1: enable reset <b>Retentivity:</b> / = no retentivity R = the status is retentive
	Output AQ	The function issues a minimum, maximum, or current value at AQ, depending on your configuration.
* AI1 to AI8: 0 V to 10 V corresponds with 0 to 1000 (internal value).		

## Parameter Mode

The actual value of another already-programmed function can provide the value for parameter Mode. You can use the actual values of the following functions:

- Analog comparator (Page 201) (actual value  $A_x - A_y$ )
- Analog threshold trigger (Page 196) (actual value  $A_x$ )
- Analog amplifier (Page 208) (actual value  $A_x$ )
- Analog multiplexer (Page 226) (actual value AQ)
- Analog ramp (Page 228) (actual value AQ)
- Mathematic instruction (Page 239) (actual value AQ)
- PI controller (Page 232) (actual value AQ)
- Up/down counter (Page 186) (actual value Cnt)
- Analog filter (Page 244) (actual value AQ)
- Average value (Page 249) (actual value AQ)
- On-delay (Page 152) (current time  $T_a$ )
- Off-delay (Page 155) (current time  $T_a$ )
- On-/off-delay (Page 157) (current time  $T_a$ )
- Retentive on-delay (Page 159) (current time  $T_a$ )
- Wiping relay (pulse output) (Page 160) (current time  $T_a$ )
- Edge-triggered wiping relay (Page 162) (current time  $T_a$ )
- Asynchronous pulse generator (Page 164) (current time  $T_a$ )
- Stairway lighting switch (Page 168) (current time  $T_a$ )
- Multiple function switch (Page 170) (current time  $T_a$ )
- Stopwatch (Page 183) (actual value AQ)
- Max/Min (actual value AQ)
- Threshold trigger (Page 193) (actual value  $F_{re}$ )

Select the required function by the block number.

**Timing diagram (example)**

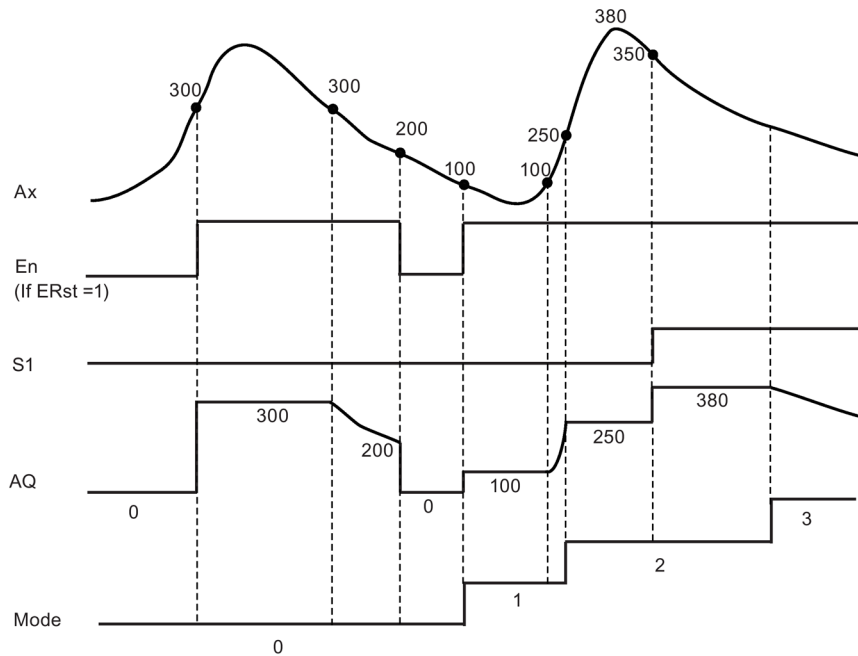

**Functional description**

ERst = 1 and En = 0: the function sets the AQ value to 0.

ERst = 1 and En = 1: the function outputs a value at AQ, depending on the settings of Mode and S1.

ERst = 0 and En = 0: the function holds the value of AQ at the current value.

ERst = 0 and En = 1: the function outputs a value at AQ, depending on the settings of Mode and S1.

Mode = 0: the function sets AQ to the minimum value

Mode = 1: the function sets AQ to the maximum value

Mode = 2 and S1 = 0: the function sets AQ to the minimum value

Mode = 2 and S1 = 1: the function sets AQ to the maximum value

Mode = 3: the function outputs current analog input value.

**Setting the Par parameter**

View in programming mode (example)

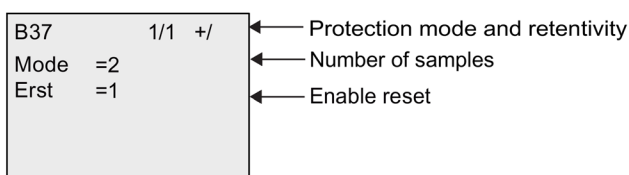

View in parameter assignment mode (example)

B37	1/1
Mode	=2
Min	=+0
Max	=+0
Erst	=1
AQ	=+0

### 4.4.36 Average value

#### Short description

The average value function calculates the average value of an analog input over a configured time period.

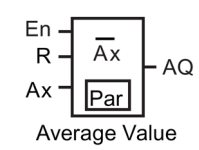
Symbol in LOGO!	Wiring	Description
 <p>Average Value</p>	En	A change in status from 0 to 1 transition at input En starts the average value function. A change in status from 1 to 0 at input En holds the analog output value.
	R	A signal at input R clears the analog output value.
	Ax	Input Ax is one of the following analog signals: <ul style="list-style-type: none"> <li>• AI1 to AI8 (*)</li> <li>• AM1 to AM64</li> <li>• NAI1 to NAI32</li> <li>• AQ1 to AQ8</li> <li>• NAQ1 to NAQ16</li> <li>• Block number of a function with analog output</li> </ul>
	Parameter	<p><b>St</b> (Sampling time): you can set the timebase to s (seconds), d (days), h (hours), or m (minutes). Range of values: St = s: 1 to 59 St = d: 1 to 365 St = h: 1 to 23 St = m: 1 to 59</p> <p><b>Sn</b> (Number of samples): Range of values: St = s: 1 to St*100 St = d: 1 to 32767 St = h: 1 to 32767 St = m and St ≤ 5 minutes: 1 to St*6000 St = m and St ≥ 6 minutes: 1 to 32767</p> <p>Retentivity: / = no retentivity R = retentivity</p>

Symbol in LOGO!	Wiring	Description
	Output AQ	Outputs the average value of input Ax over configured time sampling period.
* AI1 to AI8: 0 V to 10 V corresponds with 0 to 1000 (internal value).		

**Timing diagram (example)**

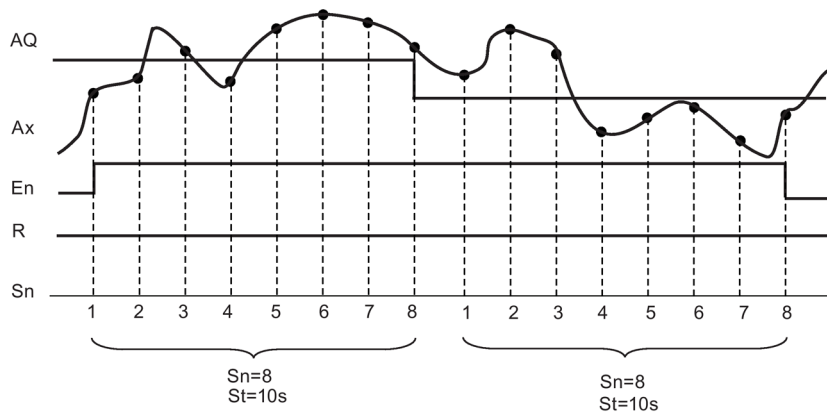

**Functional description**

This function fetches the analog input signal according to both the set sampling time St and the number of samples Sn and outputs the average value. A signal at R sets AQ to 0.

**Setting the Par parameter**

View in programming mode (example):

B45      1/1 +/ St = 12Sec Sn = 1200	← Protection mode and retentivity ← Sampling time (in seconds, days, hours or minutes) ← Number of samples
--	--

## 4.4.37 Float/Integer Converter

### Short description

LOGO! only can deal with integer. If you transfer some float from outer system by network with S7/Modbus protocol, LOGO! cannot deal with it directly. With this Float /Integer Converter function block, you can convert a float to integer by dividing a resolution in the range of values, and then the LOGO! can process the logic with this integer. If required, use Integer/Float Converter to convert the result into float and store it in the VM; and transfer the float to outer system with S7/Modbus protocol. You need to set a suitable resolution for the input float in the parameter setting.

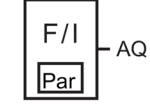
Symbol in LOGO!	Wiring	Description
 <p>FIConverter</p>	Parameter	<ul style="list-style-type: none"> <li>Typ. : It specifies the type of input data.                             <ul style="list-style-type: none"> <li>Float: it is a 32 bits single-precision float number;</li> <li>Double: it is a 64 bits double-precision float number.</li> </ul> </li> <li>VM. : Variable Memory Address, starting address of float or double stored in VM. Range of values:                             <ul style="list-style-type: none"> <li>For Float: 0-847</li> <li>For Double: 0-843</li> </ul> </li> <li>Res. : Resolution, it's a divider for output value. Range of values: 0.001 to 1000</li> </ul>
	Extended analog output <b>eAQ</b>	<p>Extended analog output for programming via parameter reference.</p> <ul style="list-style-type: none"> <li>Used as a reference parameter of the other function block.</li> <li>Signed 32 bits value.</li> <li>Range of values: -999,999,999 to 999,999,999.</li> </ul>
	Output <b>AQ</b>	<p>AQ is the analog output value. It has the following features.</p> <ul style="list-style-type: none"> <li>Used as input value of the other function block.</li> <li>Signed 16 bit value.</li> <li>Range of values: -32768 to 32767.</li> </ul>

### Functional description

You usually need both the blocks Float/Integer converter and Integer/Float converter to complete a task. A typical way to use these function blocks is:

1. Transfer the floats from outer system by network (with S7/Modbus protocol) and store them in VM.
2. Convert the floats stored in VM to integer by Float/Integer converter.
3. Process the integer with LOGO! BM.

4. Convert the result to floats by Integer/Float and store them in the VM.
5. Transfer the floats to outer system (with S7/Modbus protocol).

### Calculation rule

Define  $Q = \text{Data Input} / \text{Resolution}$

#### Analog output (AQ)

- if  $-32768 \leq Q \leq 32767$ , the Analog output =  $Q$ .
- if the  $Q \geq 32767$ , then Analog output = 32767.
- if the  $Q \leq -32768$ , then Analog output = -32768.

#### Extended analog output (eAq)

- if  $-999,999,999 \leq Q \leq 999,999,999$ , the Extended analog output =  $Q$ .
- if the  $Q \geq 999,999,999$ , then Extended analog output = 999,999,999.
- if the  $Q \leq -999,999,999$ , then Extended analog output = -999,999,999.

### Setting the Par parameter

View in programming mode (example):

B1	1/1	
Typ.	=Float	← The type for the input
VM.	=0	← Variable Memory Address
Res.	=0.100	← Resolution

View in parameter assignment mode (example):

B1	1/1	
Typ.	=Float	← The type for the input
VM.	=0	← Variable Memory Address
Res.	=0.100	← Resolution
eAq	=0	← Extended analog output
Aq	=0	← Analog output



## 4.4.38 Integer/Float Converter

### Short description

LOGO! only can deal with integer. If you transfer some float from outer system by network with S7/Modbus protocol, LOGO! cannot deal with it directly. With this Integer/Float Converter function block, you can convert an integer to float by multiplying a resolution in the range of values, and stored it in VM, then you can transfer this result to the outer system through network. You need to set a suitable resolution for the output float in the parameter setting.

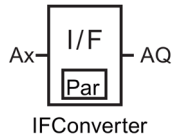
Symbol in LOGO!	Wiring	Description
 <p>IFConverter</p>	Input <b>Ax</b>	<p>Input Ax is one of the following analog signals:</p> <ul style="list-style-type: none"> <li>• AI1 to AI8 (*)</li> <li>• AM1 to AM16 (if 0BA7), or AM1 to AM64 (if 0BA8)</li> <li>• NA11 to NA132</li> <li>• AQ1 to AQ2 (if 0BA7), or AQ1 to AQ8 (if 0BA8)</li> <li>• NAQ1 to NAQ16</li> <li>• Block number of a function with analog output</li> </ul>
	Parameter	<ul style="list-style-type: none"> <li>• Typ. : It specifies the type of output data. <ul style="list-style-type: none"> <li>– Float: it is a 32 bits single-precision float number;</li> <li>– Double: it is a 64 bits double-precision float number.</li> </ul> </li> <li>• VM. : Variable Memory Address, starting address of float or double stored in VM: <ul style="list-style-type: none"> <li>– For Float: 0-847</li> <li>– For Double: 0-843</li> </ul> </li> <li>• Res. : Resolution, it's a multiplier for output value. Range of values: 0.001 to 1000</li> </ul>
	Extended analog input <b>eAx</b>	<p>If the analog input (Ax) is not available, you can assign a value to Extended analog input (eAQ) by inputting a value to the eAx field or referring to other FB's parameter.</p> <p>Range of values: -999,999,999 to 999,999,999</p>
	Extended analog output <b>eAQ</b>	<p>Extended analog output for programming through parameter reference.</p> <ul style="list-style-type: none"> <li>• Used as a reference parameter of the other function block.</li> <li>• Signed 32 bits value.</li> <li>• Range of values: -999,999,999 to 999,999,999.</li> </ul>
	Output <b>AQ</b>	<p>AQ is the analog output value. It has the following features.</p> <ul style="list-style-type: none"> <li>• Used as input value of the other function block.</li> <li>• Signed 16 bit value.</li> <li>• Range of values: -32768 to 32767.</li> </ul>

Symbol in LOGO!	Wiring	Description
* AI1 to AI8: 0 V to 10 V corresponds with 0 to 1000 (internal value).		

## Functional description

You usually need both the blocks Float/Integer converter and Integer/Float converter to complete a task. A typical way to use these function blocks is:

1. Transfer the floats from outer system by network (with S7/Modbus protocol) and store them in VM.
2. Convert the floats stored in VM to integer by Float/Integer converter.
3. Process the integer with LOGO! BM.
4. Convert the result to floats by Integer/Float and store them in the VM.
5. Transfer the floats to outer system (with S7/Modbus protocol).

## Extended analog input eAx

The eAx value can be provided by another already-programmed function:

- Analog comparator (Page 201) (actual value Ax- Ay)
- Analog amplifier (Page 208) (actual value Ax)
- Analog multiplexer (Page 226) (actual value AQ)
- Analog ramp (Page 228) (actual value AQ)
- Mathematic instruction (Page 239) (actual value AQ)
- PI controller (Page 232) (actual value AQ)
- Up/down counter (Page 186) (actual value Cnt)
- Analog filter (Page 244) (actual value AQ)
- Average value (Page 249) (actual value AQ)
- Max/Min (Page 246) (actual value AQ)
- On-delay (Page 152) (current time Ta)
- Off-delay (Page 155) (current time Ta)
- On-/off-delay (Page 157) (current time Ta)
- Retentive on-delay (Page 159) (current time Ta)
- Wiping relay (pulse output) (Page 160) (current time Ta)
- Edge-triggered wiping relay (Page 162) (current time Ta)
- Asynchronous pulse generator (Page 164) (current time Ta)
- Stairway lighting switch (Page 168) (current time Ta)
- Multiple function switch (Page 170) (current time Ta)
- Stopwatch (Page 183) (actual value AQ)

- Threshold trigger (Page 193) (actual value Ax)
- Analog threshold trigger (Page 196) (actual value Fre)

Select the required function by the block number.

## Calculation rule

### Float Value in VM address

Float Value in VM address = Analog input x Resolution

### Analog output (AQ)

- Analog input connector is connected: Analog output = Analog input
- Analog input connector isn't connected:
  - if  $-32768 \leq \text{Extended analog input} \leq 32767$ , the Analog output = Extended analog input.
  - if the Analog input  $\geq 32767$ , then Analog output = 32767.
  - if the Analog input  $\leq -32768$ , then Analog output = -32768.

### Extended analog output (eAQ):

- If the analog input connector is connected: Extended analog input = analog input.
- Extended analog input connector isn't connected:
  - if  $-999,999,999 \leq \text{Extended analog input} \leq 999,999,999$ , the Extended Analog Output = Extended analog input.
  - if the Extended analog input  $\geq 999,999,999$ , then Extended analog output = 999,999,999.
  - if the Extended analog input  $\leq -999,999,999$ , then Extended analog output = -999,999,999.

## Setting the Par parameter

View in programming mode (example):

B1	1/2	
Typ.	=Float	← The type for the input
VM.	=0	← Variable Memory Address
Res.	=0.100	← Resolution
eAx	=0	← Extended analog input

View in parameter assignment mode (example):

4.4 Special functions list - SF

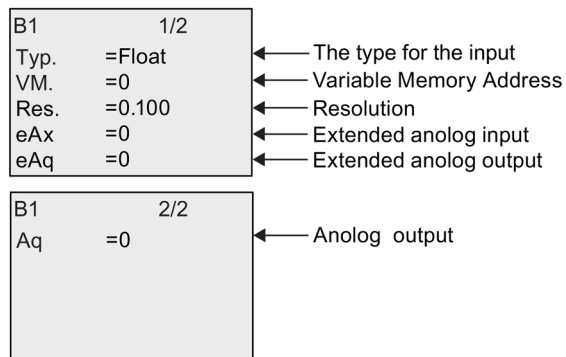

## Web server

LOGO! OBA8 has a built-in Web server which enables you to operate the LOGO! Base Module or the LOGO! TDE from a traditional PC or a mobile device.

In this approach, you can access the LOGO! Base Module or the LOGO! TDE using a connected device (conventional PC, tablet or smart phone with Web browsing capabilities) through its IP address.

The Web server allows you to use the mouse pointer or the touch screen, depending on the device you are using, to perform fast and easy operations on the virtualized LOGO! Base Module and LOGO! TDE.

LOGO! supports the following protocols for Web server communication:

- HTTP
- HTTPS (recommended)

---

### Note

When you use the HTTPS protocol to access the Web server through port mapping on the router, the browser would remind you of privacy error.

---

For detailed information about security functions on LOGO!, see Chapter Security (Page 310).

### 5.1 Enabling the Web server

Make sure you have connected your PC or mobile device to the desired LOGO! Base Module or LOGO! TDE, and guarantee you have enabled the Web user access in LOGO!Soft Comfort according to instructions in the user profile settings of the Online Help for LOGO!Soft Comfort.

Install the LOGO! Root certificate (Page 317) if you enabled HTTPS access for web server.

## Supported network explorers

The LOGO! Web server supports the following OS and Web browsers:

- Windows
  - Edge 90.0 to 126.0
  - Firefox 67.0 to 115.13
  - Google Chrome 63.0 to 126.0
  - Opera 84.0 to 125.0
- Mac OS and IOS
  - Apple Safari 12.1.2 to 15.6.1
  - Firefox 67.0 to 128.0
  - Google Chrome 70.0 to 126.0
  - Opera 84.0 to 111.0
- Linux (64 bit)
  - Firefox 91.8 to 115.13
  - Google Chrome 91.0 to 126.0
  - Opera 81.0 to 84.0

---

### Note

Make sure you do not disable cookies on your browser.

---

## Supported devices

The LOGO! Web server supports the following communications devices when you use one of the above explorers:

- Conventional PC
- Apple iPhone series
- Apple iPad series
- Smart phones and tablets with Android system with minimum version Android 2.0

## Supported Web page language

The LOGO! Web server supports the following Web page languages:

- German
- English
- Italian
- French
- Spanish

- Chinese Simplified
- Japanese

## 5.2 Logging on to the Web server

Follow the steps below to log on to the desired LOGO! Base Module.

1. Open your Web browser.
2. Enter the IP address of your LOGO! Base Module in the IP address bar.

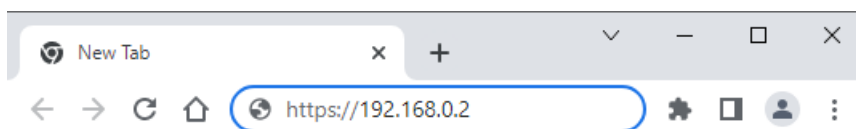

3. Press **Enter** key on your keyboard. The LOGO! Web server redirects you to the welcome page.
4. Select the account and enter the password. You can log on as Web user or Web guest user.

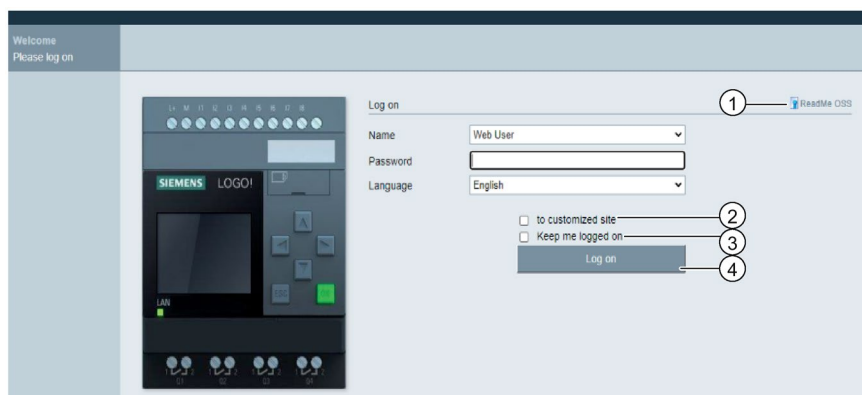

5. Select an appropriate language from the drop-down menu if needed.

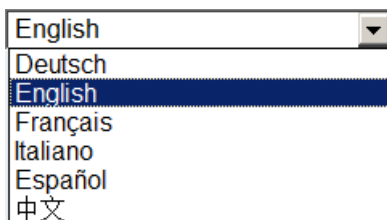

6. Click or tap "①" to view the OSS Readme.

---

**Note**

You can view the OSS Readme without enabling the Web server.

---

**Open Source Software Declaration**



7. If you want to view the LWE project deployed on BM after logon, select the "②" check box.
8. Enter the password.

---

**Note**

- You can only enable the Web server access or change the logon password using LOGO!Soft Comfort. For more information about setting the user password, refer to the Online Help for LOGO!Soft Comfort.
  - If you do not desire to enter the user name and password again at the next logon, you can select the "③" check box. Make sure you do not set your browser to private mode, since your browser does not record any browsing history or passwords in this mode.
  - You can access one LOGO! Base Module from multiple LOGO! Web server clients, but due to memory usage, this might also impact the performance of the connected Base Module.
- 

9. Click or tap "④" to log on to the Web server.

---

**Note**

- For remote access, the logon may take several seconds.
  - If your logon fails, press or tap the refresh button on your browser (or press the keyboard shortcut "F5" on the conventional PC) to try it again.
-



## 5.3 Viewing LOGO! system information

Once logged in, the LOGO! Web server displays all the system information of the LOGO! Base Module including module generation, module type, firmware (FW) version, IP address, and module status.



### Note

The firmware version in the above screen is listed for an example, your LOGO! device may be of a later version.

## 5.4 Operating the virtual module on the Web server

The LOGO! Web server enables you to do the following operations on the virtual LOGO! Base Module through **LOGO! BM** menu and the virtual LOGO! TDE through **LOGO! TD** menu.

### Operating the keys on the virtual module

If you have previously programmed the cursor keys and function keys in your circuit program, you can perform the following basic operations with these keys on the virtual LOGO! Base Module or LOGO! TDE:

To enable the functionality of the programmed cursor, click or tap the **ESC** key. Function keys are always enabled.

### 5.4 Operating the virtual module on the Web server

You can then proceed as follows:

- To enable pulse inputs, click or tap the cursor key or function key concerned.
- To enable continuous high-level signal input, continue to click the cursor keys or function key, if you release the button, the high-level signal will be lost.
- To disable the programmed cursor key or function key, click or tap the **ESC** key again.
- To disable the display of an active message as long as this message has been previously configured in LOGO!Soft Comfort as acknowledgeable, click or tap the **OK** key.

#### Viewing message text

If you have configured your message text on LOGO!Soft Comfort according to the instructions in the Online Help for LOGO!Soft Comfort, you are then able to see them on the virtual screen of the module. You can view the eastern characters in Web server in LOGO!Soft Comfort V8.3 and later versions.

Click or tap **LOGO! BM** or **LOGO! TD** on the left navigation bar and you can view active messages on the virtual device.

- On the LOGO! Base Module:



- On the LOGO! TDE:

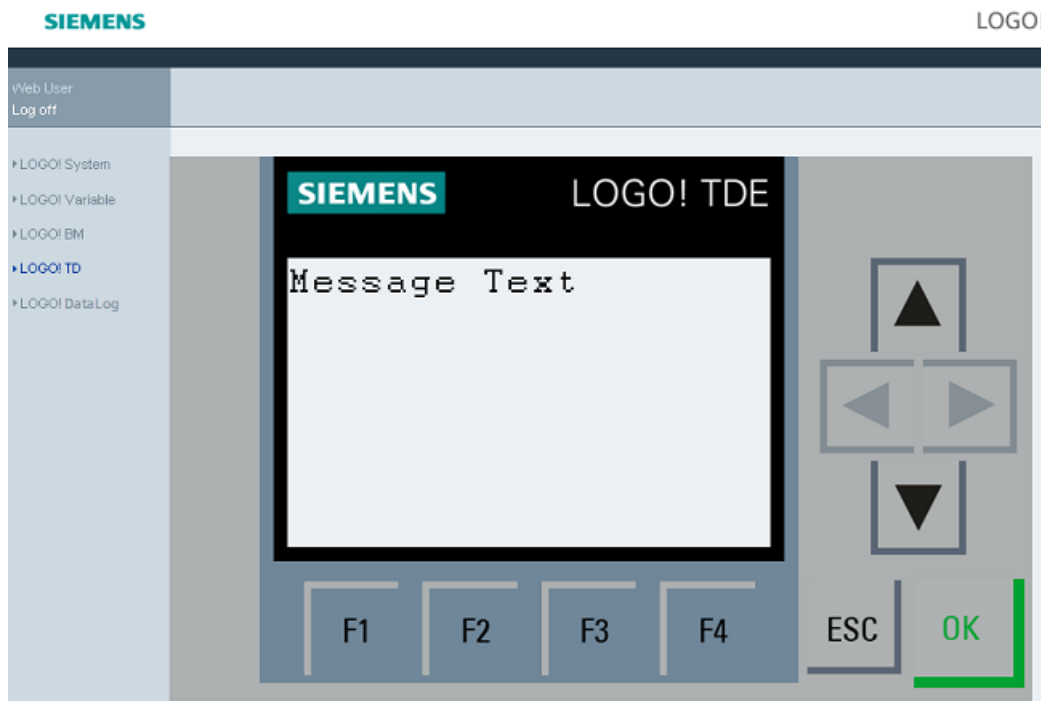

You can click or tap ▲ or ▼ to tick manually for available messages.

#### Note

The ◀ and ▶ are gray, indicating they are not applicable in viewing message texts.

### Viewing message text ticking

If you have configured message ticking settings on LOGO!Soft Comfort according to the instructions in the Online Help for LOGO!Soft Comfort, you can see the message text ticking by lines or characters on the virtual LOGO! Base Module or LOGO! TDE.

### Checking backlight color status

If you have configured backlight color settings on LOGO!Soft Comfort according to the instructions in the Online Help for LOGO!Soft Comfort, you can see the same backlight effect displayed on the virtual LOGO! Base Module or LOGO! TDE.

### Setting the configurable parameters

If you have configured to show certain parameters on LOGO! Base Module or LOGO! TDE according to the instructions in the Online Help for LOGO!Soft Comfort, you can see them displayed on the screen.

5.4 Operating the virtual module on the Web server

Double-click or double-tap on the displayed parameter to activate the parameter modification dialog. A parameter is grayed out when it is not editable.

- On the LOGO! Base Module:

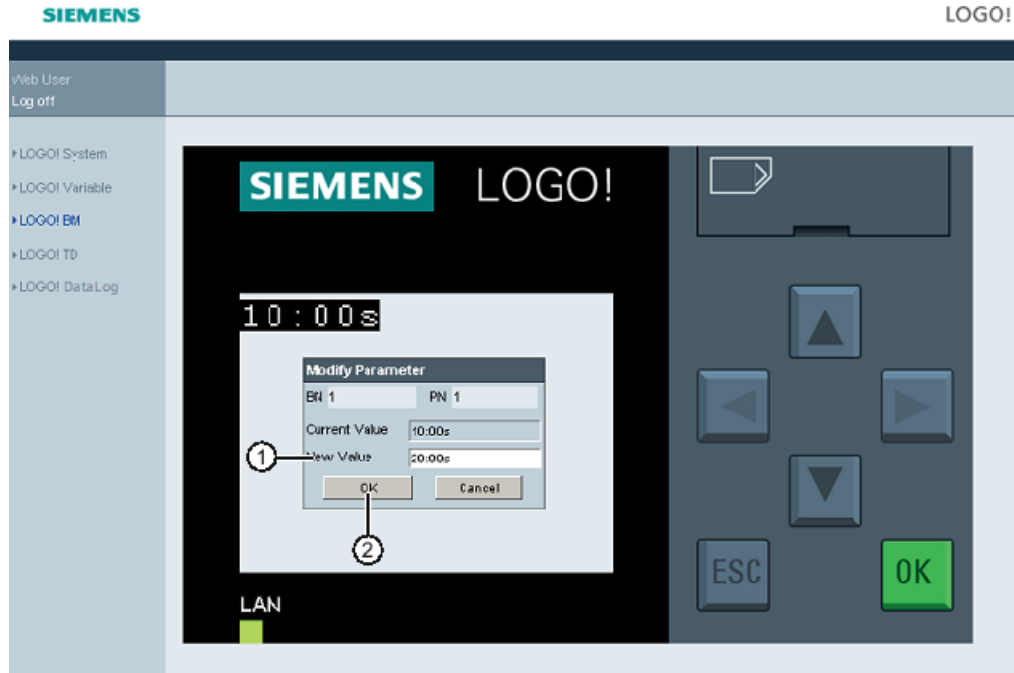

- On the LOGO! TDE:

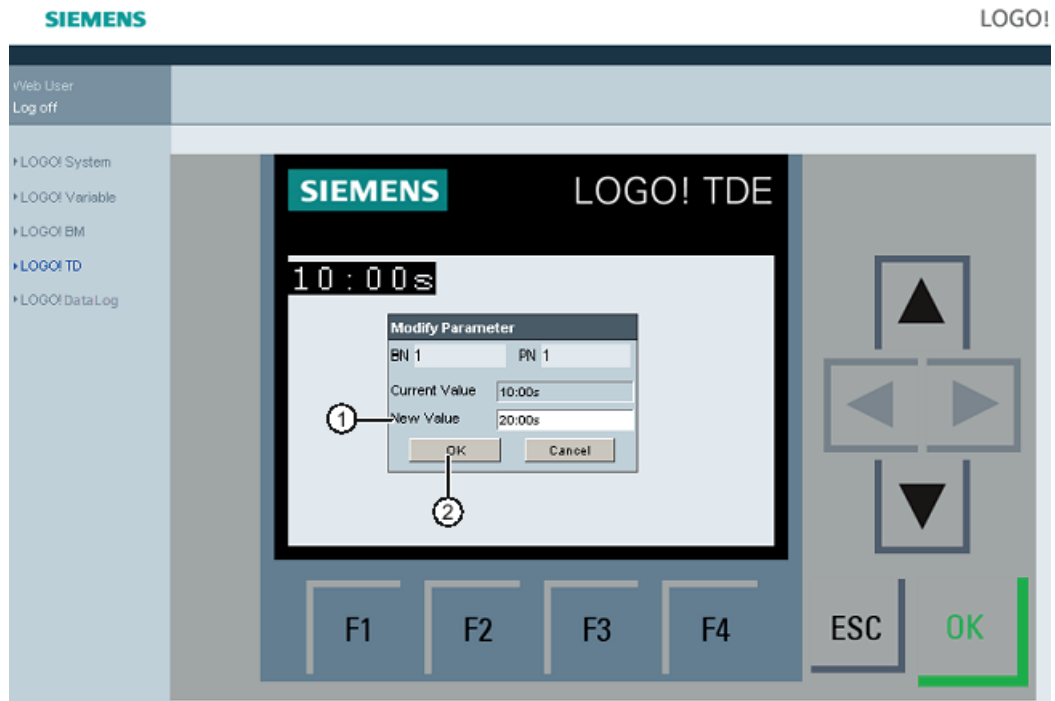

Enter the desired parameter value in line "①" on the above screens. In this example, enter "20:00s".

Make sure you have strictly followed the example of your current value. Any inconsistency may cause errors on the module.

Click or tap "②". The updated parameter is displayed.

- On the LOGO! Base Module:

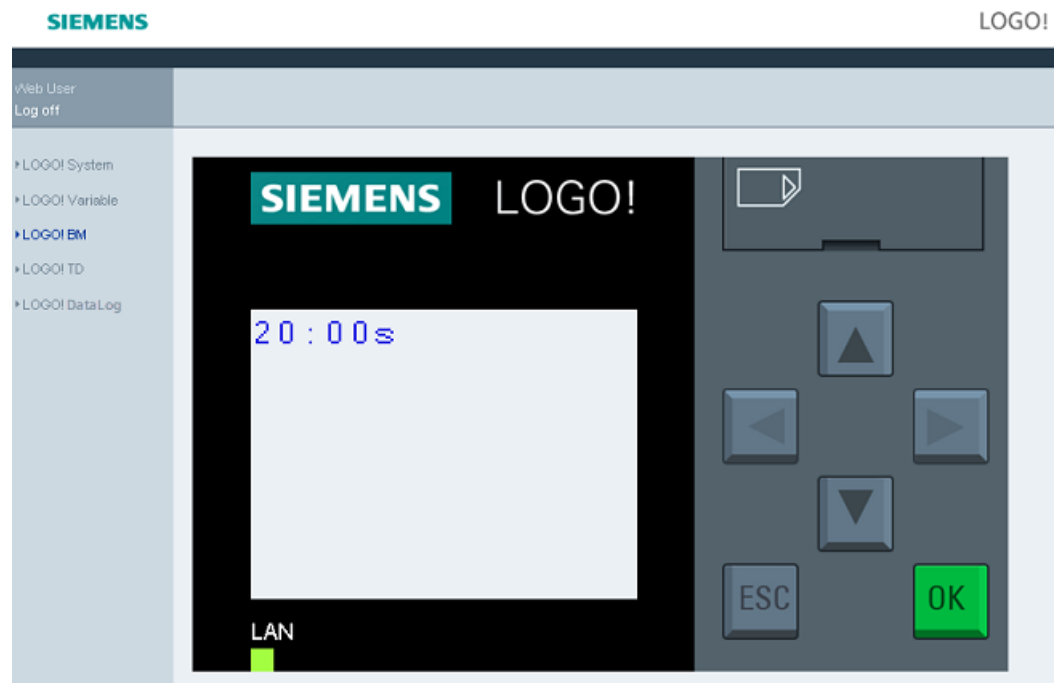

- On the LOGO! TDE:

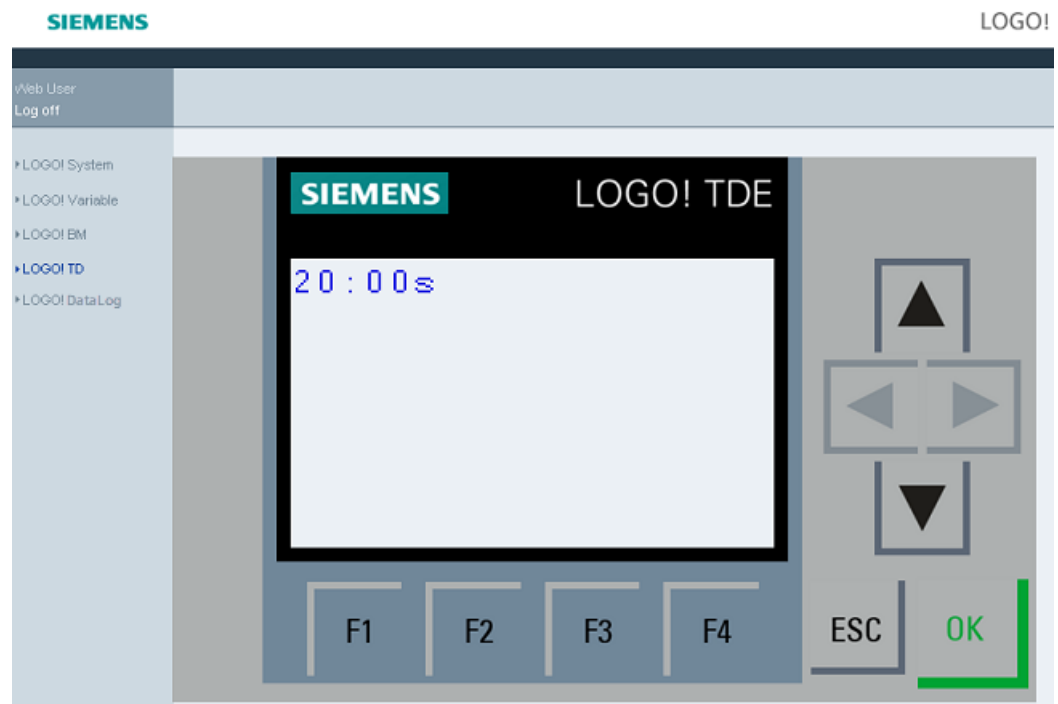

## 5.5 Viewing and editing variable memory tables

The LOGO! Web server allows you to check and modify variable memory tables on the Web browser.

For complete description on the LOGO! variables, refer to the "Parameter VM mapping" section of the Online Help for LOGO!Soft Comfort.

Click or tap "①" on the left navigation bar to show the variable table.

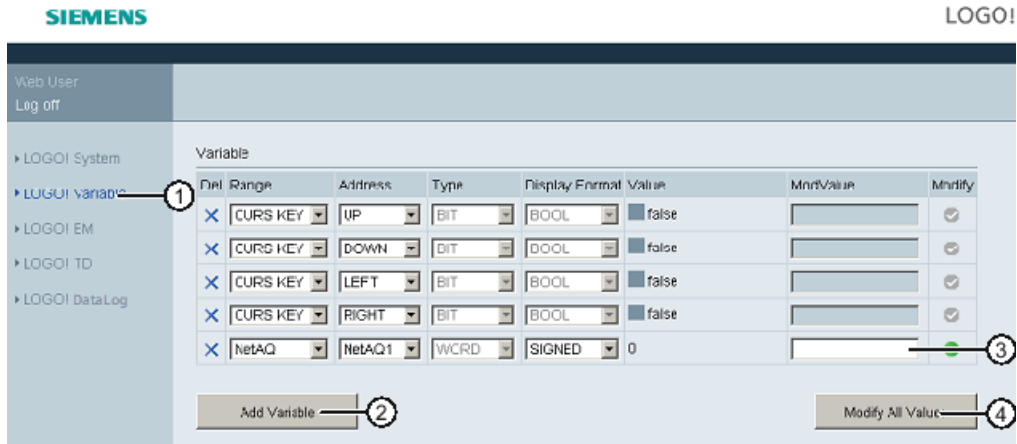

Click or tap "②" to add a new variable. Follow the steps below to set the variable.

1. Choose a desired range. Web server displays the mapping address, variable type, display format of the range.
2. Enter the new mapping address in the added empty column "③".

The  indicates the variable is to be modified.

The  indicates it is not editable.

Click or tap "④" to apply the new mapping addresses.

## 5.6 Viewing and uploading data log

The LOGO! Web server allows you to view data log (Page 284) of LOGO! Base Module, and upload data log files into the connected PC.



Click "①" to view the detailed information of the data log file.

To Upload certain data log files into the connected local PC, follow these steps:

1. Check the box of the displayed data log file you want to upload. You can select all files by checking the box in the header of the table.
2. Click "②" to start the upload process. The uploaded data log files are saved in the default directory set by the web browser, and they are in .CSV format. You can open these files by Microsoft Excel or a text editor.

## 5.7 Logging off from the Web server

To log off from the Web server, click or tap the button on top of the left navigation bar .



# Cloud IoT connection

## Functions of LOGO! Cloud connection

With the LOGO! 8.3 (and later versions) product portfolio, you can access and work with LOGO! BM and its extension modules connected through public Cloud. With this new function, you can

- publish LOGO! BM data to the supported public IoT Cloud and MQTT brokers (for example, HiveMQ, EMQX, Mosquitto, ioBroker) as configured
- change LOGO! BM data remotely through the supported public IoT Cloud and MQTT brokers

Below public IoT Cloud are supported:

- LOGO! 8.3 only supports AWS Cloud
- LOGO! 8.4 supports AWS, Azure, Alibaba Cloud

---

### Note

For LOGO! 8.3 BM, Cloud connection is available only when Cloud connection is configured and circuit diagram is in run mode. When circuit diagram switches to stop mode, the cloud connection closes automatically.

For LOGO! 8.4 and later version BMs, Cloud connection is available when Cloud connection is configured and regardless of whether circuit diagram is in run or stop mode. Cloud data is transferred when Cloud connection is configured and circuit diagram is in run mode.

---

## Protocols for the Cloud connection

LOGO! 8.3 and later versions support the following protocols for communication with a Cloud server:

- MQTT over Transport layer security (TLS), according to OASIS standard version 3.1 / 3.1.1

For general MQTT broker connection, LOGO! 8.4 also supports MQTT over TCP (Transmission Control Protocol) after configured.



## 6.1 LOGO! Cloud configuration

LOGO! Cloud connection includes:

- Connection between the supported IoT Cloud and LOGO! BM (registered and configured by LOGO!Soft Comfort V8.3 or later version)
- Connection between deployed LWE project on AWS Elastic Beanstalk and LOGO! BM (deployed and configured by LOGO! Web Editor V1.1 or later version)

---

### Note

Only AWS Cloud is supported to deploy LWE projects as WebApp.

All deployed LWE projects are under your account and you can access these projects by URL which are provided by AWS.

---

### Note

The data collected by AWS IoT can be used by other services only with your own AWS account. And other AWS services or applications are also created by yourself. So all the data and applications are under your instance and belong to you. According to AWS rules, you can use correct "AWSAccessKeyId" and "AWSSecretKey" to fetch data from IoT shadow by yourself too.

For LOGO! 8.4 and later version BM, you can also use AWS Temporary Credential Account (TVM) to establish AWS IoT Cloud connection. You can use correct "AWSAccessKeyId", "AWSSecretKey" and "SessionToken" to fetch data from IoT shadow by yourself.

---

On how to establish a Cloud connection to LOGO!, refer to section *Tools -> Transfer -> Cloud Settings -> Cloud Connection Settings* in *LOGO!Soft Comfort Online Help*.

### AWS Cloud configuration

The following picture shows the relationship and roles each part plays in AWS Cloud configuration.

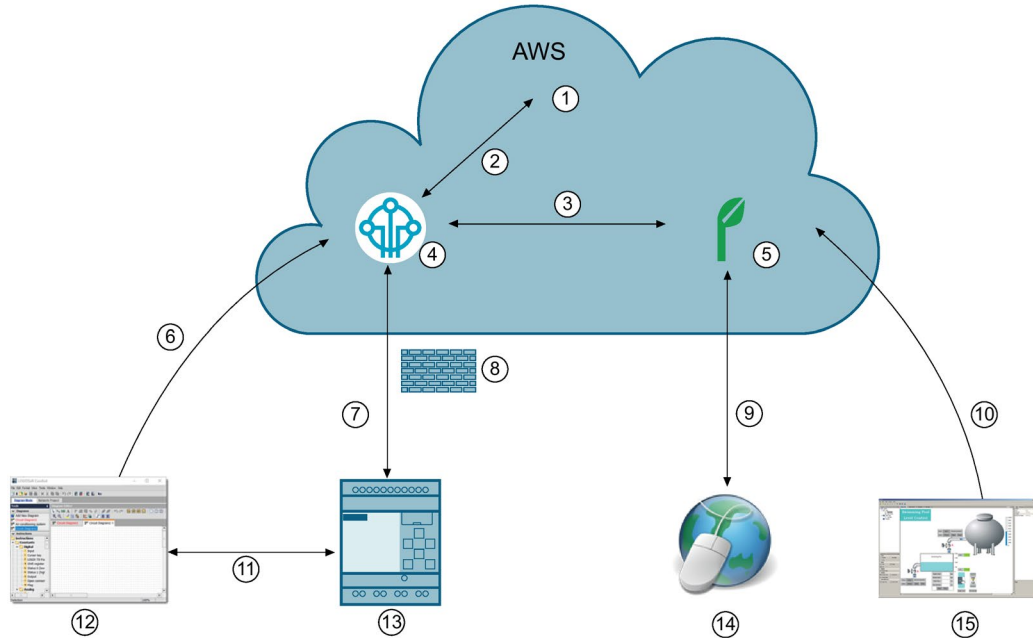

- ① Other AWS services
- ② AWS rules  
<https://docs.aws.amazon.com/iot/latest/developerguide/iot-rules-tutorial.html>
- ③ MQTT
- ④ AWS IoT
- ⑤ AWS Elastic Beanstalk (Web server)
- ⑥ Register
- ⑦ Transfer Data through MQTT
- ⑧ Firewall
- ⑨ Http/Https
- ⑩ Deploy
- ⑪ Configure connection and transfer
- ⑫ LOGO!Soft Comfort
- ⑬ LOGO! Base module
- ⑭ Browser
- ⑮ LOGO! Web Editor

---

**Note**

All data in Other AWS services, AWS IoT and AWS Elastic Beanstalk belong to the login account.

---

**Note**

Siemens recommends you use standalone firewall to protect you LOGO! BM device.

---

## Azure/Alibaba Cloud configuration

The following picture shows the relationship and roles each part plays in Azure/Ali Cloud configuration.

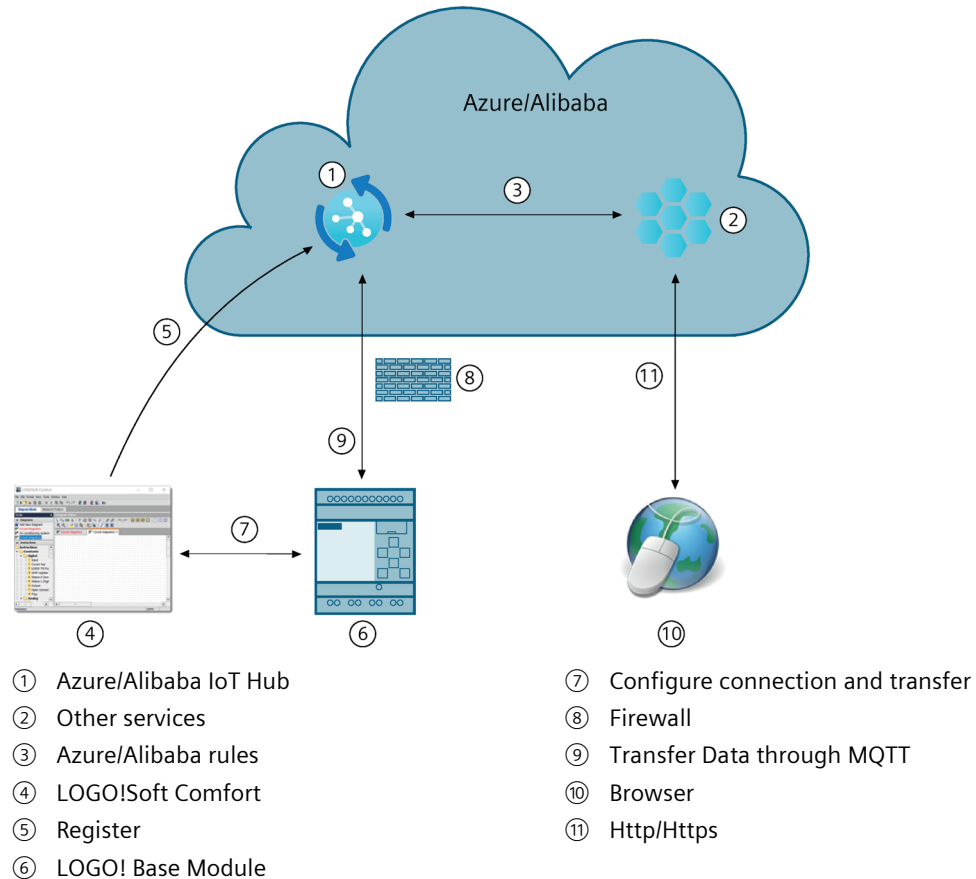

### Note

Siemens recommends you use standalone firewall to protect you LOGO! BM device.

## MQTT configuration

General MQTT can be used to connect LOGO! BM to other Clouds/Servers that support MQTT. You cannot register IoT things/devices for these Clouds/Servers on LOGO!Soft Comfort, but you can configure general MQTT on LOGO!Soft Comfort.

### Note

LOGO! BM only supports JSON format, therefore, only general MQTT which support JSON format can establish IoT connection with LOGO! BM and transfer data.

The following picture shows the relationship and roles each part plays in MQTT configuration.

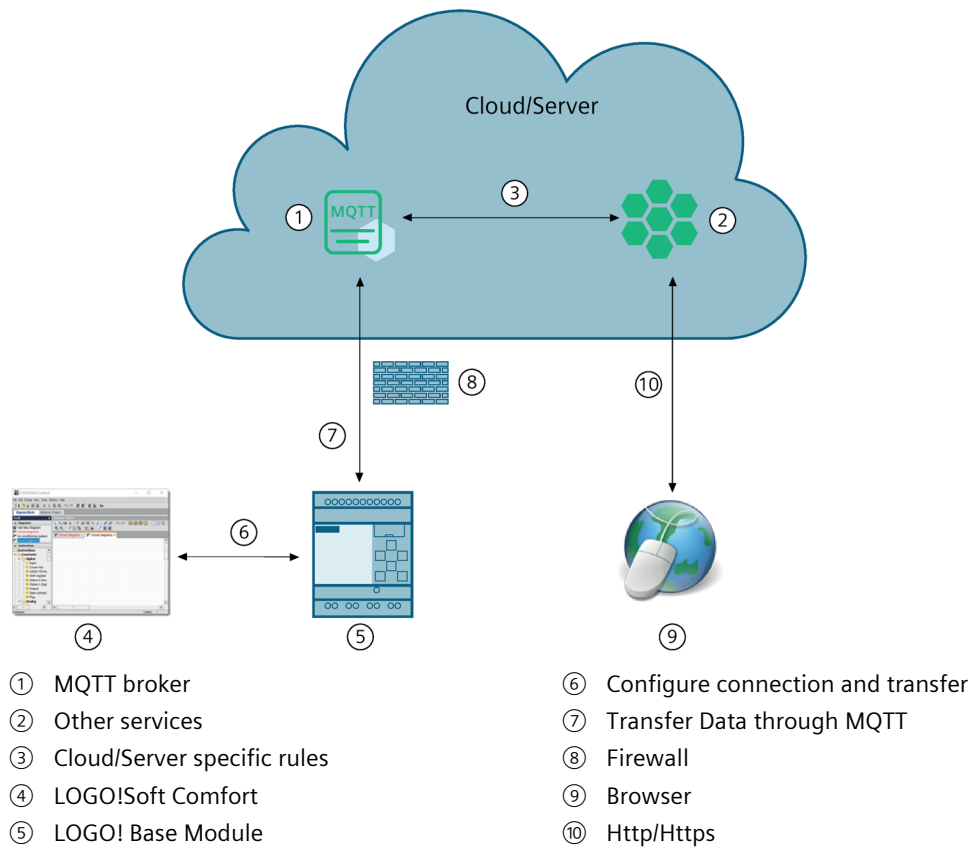

**Note**

Siemens recommends you use standalone firewall to protect you LOGO! BM device.

## 6.2 Secure Cloud connection

### Secure Cloud connection to AWS

With LOGO!Soft Comfort 8.3 or later version, you can register LOGO! BM and download the Amazon Root CA Certificate to LOGO! BM. LOGO! BM saves the certificates for Cloud and devices in it. LOGO! BM establishes connection to AWS through TLS (Transport Layer Security).

On how to register LOGO! BM and download the Amazon Root CA certification, refer to Chapter *Tool* -> *Transfer* -> *Cloud Settings* -> *Cloud Connection Settings* in *LOGO!Soft Comfort Online Help*.

LOGO!Soft Comfort 8.3 (or later version) creates the AWS Cloud certificate as follows:

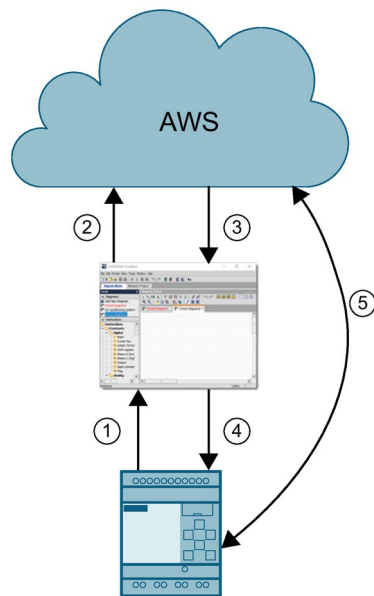

- ① LOGO!Soft Comfort connects to LOGO! BM and gets the certificate signing request (CSR).
- ② LOGO!Soft Comfort connects to AWS through HTTPS and sends the CSR to AWS.
- ③ AWS returns the signed certificate to LOGO!Soft Comfort.
- ④ LOGO!Soft Comfort downloads certificate to LOGO! BM.
- ⑤ LOGO! BM connects to AWS through encrypted channel.

---

#### Note

If the Cloud security configuration is out of date or invalid, you should reconfigure it through LOGO!Soft Comfort.

---

### Secure Cloud connection to Azure/Alibaba

LOGO! 8.4 supports Azure/Alibaba IoT Cloud connection. LOGO! BM builds the secure connection with Azure/Alibaba as follows:

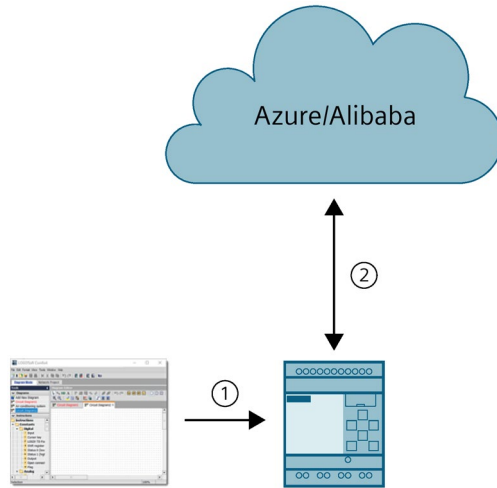

- ① LOGO!Soft Comfort downloads Azure/Alibaba CA certificate to LOGO! Base Module.
- ② LOGO! Base Module connects to Azure/Alibaba through encrypted channel.

### Secure Cloud connection to general MQTT

LOGO! 8.4 supports general MQTT connection modes as follows:

Connection mode	Description
TCP	Data transfer channel is not encrypted.
TLS without authentication	Data transfer channel is encrypted, but both server and client are not authenticated. Siemens doesn't recommend you use this connection mode as connection is not secure enough.
TLS one-way	Data transfer channel is encrypted, and only the client authenticates the server.
TLS two-way	Data transfer channel is encrypted, and both server and client are authenticated.

When you use TCP or TLS without authentication connection mode, LOGO! Base Module connects to the Cloud directly. When you use TLS one-way or two-way mode, the secure connection is as follows:

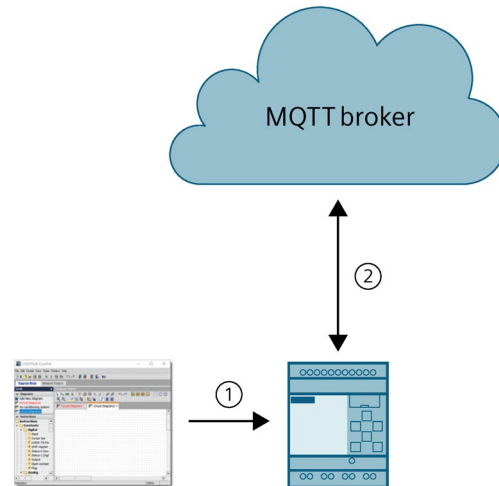

- ① TLS one-way: LOGO!Soft Comfort downloads server's CA certificate to LOGO! Base Module.  
TLS two-way: LOGO!Soft Comfort downloads server's CA certificate as well as registered device's key and certificate to LOGO! Base Module.
- ② TLS one-way/two-way: LOGO! Base Module connects to server through encrypted channel.

## 6.3 AWS Cloud data format

### Customized format for LOGO! JSON document

LOGO! Base Module publishes data to the supported IoT Cloud with its device shadow. A device's shadow is a JSON document that is used to store and retrieve current state information for a device in the Cloud. Each device's shadow is uniquely identified by the name of the corresponding thing. You can use the shadow to get and set the state of LOGO! BM over MQTT, regardless of whether the LOGO! BM is connected to the Internet. If BM is not connected to internet, when Cloud sends data to the BM, the data is saved in buffer and will be send to the BM when it is connected to internet.

Siemens customized the format of JSON document for LOGO! BM. When you change the values in the shadow of LOGO! BM, follow the customized format. Otherwise, LOGO! BM ignores the changes.

LOGO! JSON documents have the following format:

6.3 AWS Cloud data format

"range.sub\_range.data\_type:start\_addr-number": "value"

Variables	Mandatory or not?	Description			
range	Yes	Range of a block type. Support I, Q, M, AI, AQ, AM, NI, NQ, NAI, NAQ, V, VB, VX, VR, VW, VD Cursors key (CK), function key (FK), shift register (SR). All range should be capitalized.			
sub_range	No	Reserved			
data_type	No	1	2	4	6
		bit	byte	word	double word
start_addr	Yes	The start address of data.			
number	Yes	The length of data value. The unit depends on data_type.			
value	Yes	The value of data. It is hex string.			

Variables	Bit range	Word range	V range	Range shift register
range	I, Q, M, NI, NQ, Cursors key (CK), Function key (FK)	AI, AM, AQ, NAI, NAQ	V	Shift register (SR)
sub_range	Reserved			
data_type	1	4	1, 2, 4, 6 default value is 2.	1
start_addr	1 to n	1 to n	0 to n If the data type is 1 (bit), the starts address starts from 0.0. Otherwise, the start address starts from 0.	1.1 to n.8
number	1 to n	1 to n	1 to n+1	1 to 8n

Example

- **Bit range:** Q1~Q2:11. Start\_addr = Q1, number = 2. Format: "Q..1-2":03" or "Q..1:1-2":03"
- **Word range:** AI1~AI4: 0x1111222233334444 Start\_addr = AI2, number = 2. Format: "AI..4:2-2":22223333" or "AI..:2-2":22223333"
- **V range:** V0~V8: 001122334455667788 Start\_addr = V1.1, number = 3. Format: "V..1:1.1-3":01" Start\_addr = VB0, number = 2. Format: "V..2:0-2":0011" or "V..:0-2":0011" Start\_addr = VW2, number = 2. Format: "V..4:2-2":22334455" Start\_addr = VD3, number = 1. Format: "V..6:3-1":33445566"
- **SR1.1~S2.8:** 1134 Start\_addr = SR1.1, number = 3. Format: "SR..1:1.1-3":01" or "SR..:1.1-3":01"



### Cloud variable parsing strategy

- If the value field is not byte-aligned (odd characters), add '0' before the first character to align its bytes.  
**Example:** "Q..1:1-2":"3" → "Q..1:1-2":"03"
- In a left-aligned manner, BM parses each element specified by key (WORD,DWROD)  
**Example:** "AI..:2-2":"22223333" → AI2: 0x2222; AI3: 0x3333
- If the length of value is smaller than that specified by key, the values of the remaining elements are '0' by default.  
**Example:** "V..2:0-2":"11" → VB0: 0x11; VB1: 0x00
- If the length of the last element of value does not meet the length of a single element, fill '0' in the MSB (Most Significant Bit).  
**Example:** "V..6:3-1":"334455" → VD3: 0x00334455  
"V..6:3-2":"334455667788" → VD3: 0x33445566; VD4: 0x00007788
- If the length of value is larger than the length specified by key, the data of extra length is discarded.  
**Example:** "V..6:3-2":"33445566778899AA001122" → VD3: 0x33445566; VD4: 0x778899AA

### General integer array format

LOGO! 8.4 and later versions BM also support integer array format for Cloud data transfer.

Integer array follows below format:

```
"{name}":{
  "desc":"{range}-{type}-{start address}-{count}",
  "value":[signed decimal, signed decimal .....]
}
```

Variables	Mandatory or not	Description
{name}	Yes	You can configured it through "Cloud Data Transfer Settings" in <i>LOGO!Soft Comfort</i> .
{range}	Yes	Range of a block type. Support I, Q, M, AI, AQ, AM, NI, NQ, NAI, NAQ, V, VB, VX, VR, VW, VD Cursors key (CK), function key (FK), shift register (SR). All range should be capitalized.
{start address}	Yes	The start address of data.
{count}	Yes	The length of data value.
{type}	Yes	It can be bit, byte, word or dword.

"value" is represented as an array of signed decimal integers, and the number of integers is the same with {count} in "desc".

**Example:**

- Bit range: Q1-Q2:11. Start address = Q1, number = 2. Format: "desc": "Q-bit-1-2", "value": [1, 1]
- Word range: AI1-AI4: 0x1111222233334444. Start address = AI2, number = 2. Format: "desc": "AI-word-2-2", "value": [8738, 13107]
- V range: V0-V8: 0x001122334455667788. Start address = V1.1, number = 3. Format: "desc": "V-bit-1.1-3", "value": [1, 0, 0]. Start address = VB0, number = 2, Format: "desc": "V-byte-0-2", "value": [0, 17]. Start address = VW2, number = 2, Format: "desc": "V-word-2-2", "value": [8755, 17493]. Start address = VD3, number = 1, Format: "desc": "V-dword-3-1", "value": [860116326]
- SR1.1-S2.8: 0x1134. Start address = SR1.1, number = 3. Format: "desc": "SR-bit-1.1-3", "value": [1, 0, 0]

**Cloud variable parsing strategy**

- If the length of value array is smaller than that specified by count in "desc", the values of the remaining elements are unchanged.  
**Example:** "desc": "V-byte-0-2", "value": [3] → VB0: 0x11; VB1: 0x00
- If the length of value array is larger than that specified by count in "desc", the data of extra length is discarded.  
**Example:** "desc": "V-dword-3-2", "value": [860116326, 2005440938, 4386] → VD3: 0x33445566; VD4: 0x778899AA
- If some values in array are out of range specified by type, these values are ignored.  
**Example:** "desc": "V-word-100-3", "value": [100,40000,60] (40000 is out of range: -32768 to 32767) → VW100: 0x64; VW101: unchanged; VW102: 0x3C

**Send data to broker**

According to the configuration in Cloud Data Transfer Settings in LOGO!Soft Comfort, LOGO! BM sends data to broker only when it's in RUN mode. To learn more about cloud data transfer configuration, refer to section *Tools -> Transfer -> Cloud Settings -> Cloud Data Transfer Settings* in *LOGO!Soft Comfort Online Help*.

When LOGO! BM is set from STOP to RUN mode, BM publishes below messages to the public topic:

- Clean broker shadow caches:

```
{
  "state": {
    "reported": null
  }
}
```

- Send data format version information to parse data:

```
{
  "state": {
    "reported": {
      "$style": 1
    }
  }
}
```

```
}  
}  
}
```

When LOGO! BM is in RUN mode, BM publishes LOGO! time data value every 10 seconds. The LOGO! time data value can be concluded in a message that contains other data values. The following are examples of messages containing LOGO! time data value:

- LOGO! time data value in hex string format (Compatible to 8.3 cloud data format):

```
{  
  "state": {  
    "reported": {  
      "I..1:1-1": "00",  
      "V..2:990-6": "282303060313"  
    }  
  }  
}
```

- LOGO! time data value in integer array format:

```
{  
  "state": {  
    "reported": {  
      "I": {  
        "desc": "I-bit-1-1",  
        "value": [  
          0  
        ]  
      },  
      "$logotime": 1678072448  
    }  
  }  
}
```

## UDF (User-Defined Function)

### User-Defined Function (UDF)

LOGO!Soft Comfort provides you with a UDF (User-Defined Function) editor for creating circuit programs. You can save circuit programs created in the UDF editor as individual UDF blocks for use in a circuit program in the UDF or FBD editor.

A UDF block is a preconfigured circuit program that you create. You can add it to an existing circuit program as you do with a function block. If the circuit program in LOGO!Soft Comfort already contains a UDF, after transferring the program from LOGO!Soft Comfort to a LOGO! OBA8, you can edit the elements connected to this UDF from the module.

For a detailed description of the UDF configuration in LOGO!Soft Comfort, refer to the Online Help for LOGO!Soft Comfort.

### Editing elements connected to a UDF block

You can neither create a UDF block from LOGO! OBA8, nor edit the members of the block. You can only edit elements connected to the inputs or outputs of a UDF block or edit its parameter settings.

---

#### Note

Each UDF block has a maximum of eight inputs and four outputs, dependent upon your configuration in LOGO!Soft Comfort.

---

### Editing elements to the inputs of a UDF block

1. Switch LOGO! to programming mode.

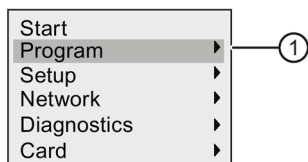

2. Select "①" on the main menu: Press ▲ or ▼
3. Confirm "①": Press OK

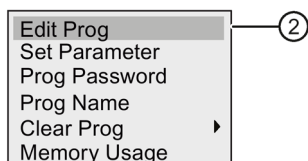

4. Select "②": Press ▲ or ▼

5. Press **OK** twice to enter circuit program edit mode. A "U" identifies a UDF block. "U1" refers to the first UDF block. The following display shows you an example of the circuit program that contains a UDF block configured from LOGO!Soft Comfort.

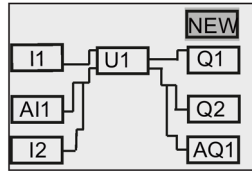

6. Move the cursor to "U1": Press **▲**, **▼**, **◀** or **▶**.
7. Press **OK** to enter the screen form for the first UDF block "U1". To select another element, press the cursor keys.

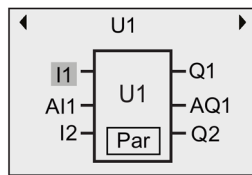

8. Position the cursor on the selected input ("I1" in this example) and press **OK**. The cursor appears in a flashing solid square. If you want to change the first input to another element, press **▲** or **▼**.
9. Confirm your selection by pressing **OK**. The first input of "U1" is now changed.

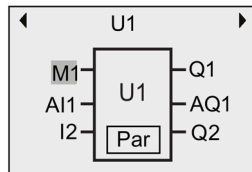

### Editing elements to the outputs of a UDF block

If LOGO! shows the following screen form as shown in the above Step 5 and you want to change "Q1" to another element, follow the steps below:

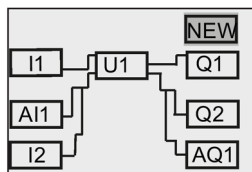

1. Press **OK** and LOGO! shows the following display:

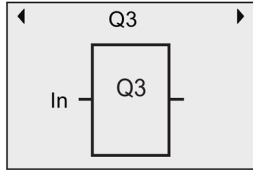

2. Move the cursor to "In" by pressing **◀**. Press **OK** and the cursor appears in a flashing solid square. You can change the input to "U1.1" ("1" refers to the first output of the UDF block that is connected to "Q1") by pressing **▲** or **▼** and LOGO! shows the following display:

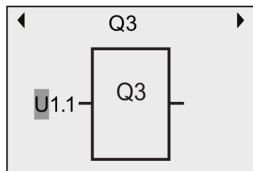

3. Confirm your selection by pressing **OK**. Press **ESC** and LOGO! shows the following display:

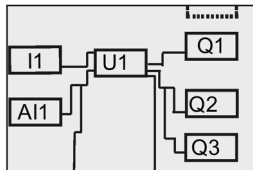

Now "U1" is connected to "Q3".

4. Press **OK** and move the cursor to "Q1" by pressing **▲**, **▼**, **◀** or **▶**. Press **OK** and LOGO! shows the following display:

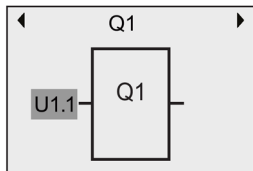

5. Press **OK** and the cursor appears in a flashing solid square. Select an empty input by pressing **▲** or **▼**. Press **OK** and LOGO! shows the following display:

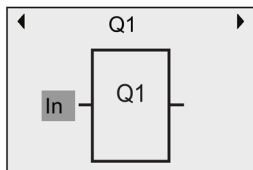

6. Press **ESC** and LOGO! shows the following display:

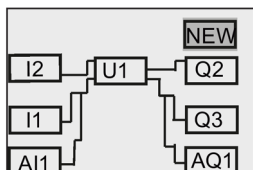

Now the connection between "U1" and "Q1" is removed.

You have changed the element connected to the first output of "U1" from "Q1" to "Q3".

## Setting the Par parameter

You can edit the **Par** parameter for your UDF block if you have configured parameters for this UDF using LOGO!Soft Comfort; otherwise, you cannot edit parameters for UDF blocks. If your UDF block contains the **Par** parameter, you can edit the parameters as described below:

View in programming mode (example):

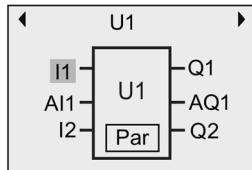

1. Press **▼** to move the cursor to "Par" and press **OK**. LOGO! shows you the following display (T and TH are the identifiers you specified for the relevant UDF parameters in LOGO!Soft Comfort . You can configure a maximum of eight parameters for each UDF block using LOGO!Soft Comfort. LOGO! can show a maximum of three parameters on a single display.):

First view of U1 parameters

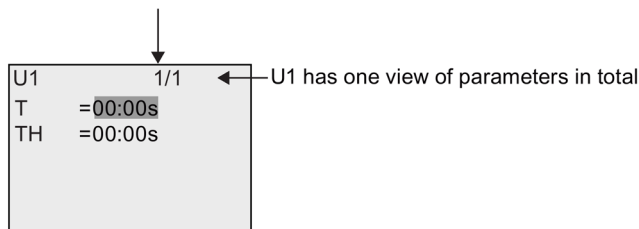

2. Press **OK** and the cursor moves to the first number of "T":

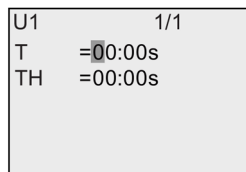

3. Press **▲** or **▼** to change the value. Press **◀** or **▶** to select another number and then press **▲** or **▼** to change its value. Press **OK** to confirm your modifications. Then LOGO! shows the following display:

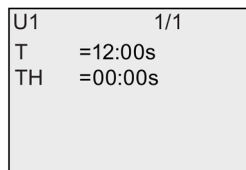

You can also edit UDF parameter settings in parameter assignment mode in the same way as you do in programming mode.

## Data log

You can configure a maximum of one data log for your circuit program using LOGO!Soft Comfort. The data log records process measurement variables for function blocks that you configure for data logging. You can add the data log instruction to your circuit program as you do with a function block.

If you configured the data log for your circuit program, after transferring the program from LOGO!Soft Comfort to LOGO!, you can edit the elements connected to the data log block.

For a detailed description of configuration of the data log function in LOGO!Soft Comfort, refer to the Online Help for LOGO!Soft Comfort. From the LOGO! Base Module, you can only configure elements connected to the data log block.

### Editing elements connected to the data log block

If your circuit program in LOGO! contains a data log block configured from LOGO!Soft Comfort, you can edit elements connected to this data log as follows:

1. Switch to programming mode. Press **OK** twice to step into the following display of your circuit program:

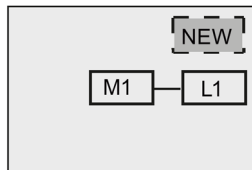

2. Move the cursor to "L1" by pressing ▼ (The data log is identified with a "L1"). Press **OK**. LOGO! shows the following display:

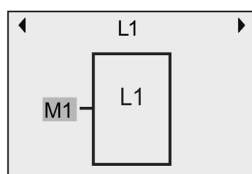

3. Press **OK** on the selected input ("M1" in this example) and the cursor appears in a flashing solid square. To select a different element from the available list (for example, B3), press ▼. Press **OK**. LOGO! shows the following display:

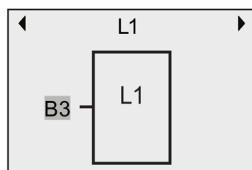



4. In the following example, you can see that this "L1" is now connected to the B3 block:

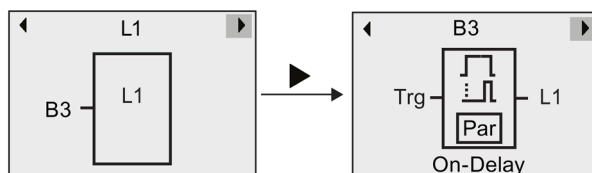

### Note

For LOGO! 8.4 (6ED1052-xxx08-0BA2) devices, it provides a 4096-byte buffer for data logging. If no micro SD card is inserted in the LOGO! BM card slot before running a circuit diagram, LOGO! BM writes data to buffer temporarily. Buffer keeps the latest 4096-byte data while the old data gets lost. If a micro SD card is inserted in the LOGO! BM card slot before running a circuit diagram, LOGO! writes data in the buffer to SD card firstly, and LOGO! writes data generated later into SD card as well. If the SD card is removed out of LOGO! in the process of a circuit running, the generated data gets lost. If the speed of data generation in LOGO! OBA8 is faster than that of data writing to the micro SD card, data loss can occur. To avoid the occurrence of data loss, apply an enable signal to the data log function block at a minimum time interval of 500 ms.

A micro SD card can store a maximum of 50 latest data log files for each circuit diagram running in each LOGO! Base Module. If the inserted SD card already stores 50 data log files for a circuit diagram, the SD card stores newly created data log files and deletes the oldest ones to keep the maximum number of 50 data log files. The micro SD card stores another 50 data log files of another circuit program running in the same LOGO! Base Module, but the maximum number of lines that a card can store is limited to its memory size. A data log file on the micro SD card can contain a maximum of 20000 lines. If the memory of the micro SD card is full and you want to create a new data file, then an error message will be generated automatically.

LOGO! automatically creates file names with the format of "<IP>\_<date>\_<number>\_<checksum>.csv". <IP> stands for the IP address of the connected LOGO! Base Module. <date> stands for the date when creating this data log file. <number> indicates the sequential number of the created data file and ranges from 1 to 9999. <checksum> identifies the circuit diagram. Do not change the file name because the LOGO! Base Module cannot recognize user-defined names.

You can upload the data log files in buffer or micro SD card from LOGO! to the connected PC through LOGO!Soft Comfort or web server (Page 267).

Under the following circumstances, LOGO! creates a new data log file:

- When the circuit program in LOGO! is changed
- When the IP address of the connected LOGO! Base Module is changed
- When the number of lines in the data log file exceeds 20000

The created file will have a name with an increased number index, for example, if the name for the current data file is "192\_168\_0\_3\_2023\_06\_30\_0001\_ad4b810.csv", the new file will be named "192\_168\_0\_3\_2023\_06\_30\_0002\_ad4b810.csv".

# Configuring LOGO!

Parameter assignment refers to the configuration of the block parameters. You can set delay times for time functions, the switching times of timers, counter threshold values, the monitoring interval of an hours counter, the on and off thresholds of the trigger, and more.

You can configure the parameters:

- In programming mode
- In parameter assignment mode

Parameter assignment mode allows the editing of parameters without having to modify the circuit program. This feature is available so that you can edit parameters without having to change to programming mode. The advantage is that you can edit program parameters, but the circuit program remains protected.

---

## Note

In parameter assignment mode, LOGO! continues execution of the circuit program.

---

## 9.1 Selecting parameter assignment mode

Press ESC to access the parameter assignment mode:

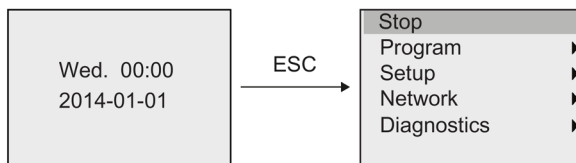

For more information about the menu commands in parameter assignment mode, refer to Section "LOGO! Basic (Page 367)".

Follow these steps to stop your circuit program and thus change to the main menu of programming mode:

1. Move the cursor to "①": Press ▲ or ▼

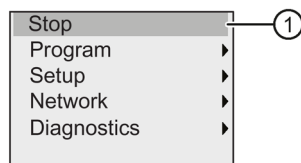

2. Confirm "①": Press OK

3. Move the cursor to "②": Press ◀

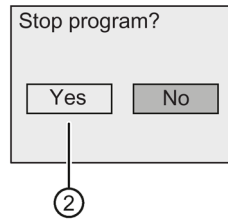

4. Confirm placing LOGO! in STOP mode by pressing **OK** with the cursor on "②".

LOGO! shows the main menu of the programming mode:

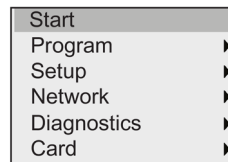

For more information about switching LOGO! to RUN mode, refer to Section "Switching LOGO! to RUN mode (Page 89)".

## Description of other menu commands of the parameter assignment menu

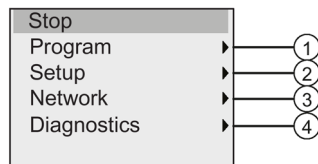

- **Menu command ①**

For information on the various settings, refer to the following topics:

- Parameters (Page 288)
- Selecting the parameters (Page 289)
- Modifying parameters (Page 290)
- Assigning a circuit program name (Page 83)

- **Menu command ②**

For information on the various settings, refer to the following topics:

- Setting the time of day and date (Page 293)
- Summertime/wintertime conversion (Page 105)
- Network Time Protocol (LOGO! 8.FS4 and later versions only) (Page 108)
- Setting the start screen (Page 298)
- Setting the display contrast and backlight choice (Page 295)
- Setting the default values for LOGO! (Page 292)

## 9.1 Selecting parameter assignment mode

- **Menu command ③**

For information on the various settings, refer to the topic "Configuring network settings (Page 112)".

- **Menu command ④**

For information on the various settings, refer to the topic "Diagnosing errors from LOGO! (Page 118)".

### 9.1.1 Parameters

---

#### Note

You can only view and edit parameters in the parameter assignment mode when they have the read/write ("+") designation. See the "Parameter protection (Page 144)" topic.

---

Parameters are, for example:

- The delay times of a timer relay
- The switching times (cams) of a timer switch
- Counter thresholds
- The monitoring time for hour counters
- The trigger thresholds

A block number (Bx) and the short name of the parameter identifies each parameter.

Examples:

- T: ...is a configurable time
- MI: ...is a configurable time interval

---

#### Note

LOGO!Soft Comfort also allows you to assign names to blocks (for more information, refer to the chapter entitled "LOGO! Software (Page 334)".

---

### 9.1.2 Selecting the parameters

To select a parameter:

1. On the parameter assignment menu, move the cursor to "①": Press ▼ or ▲

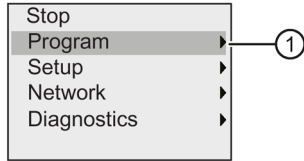

2. Confirm "①" with **OK**.
3. Move the cursor to "②": Press ▼ or ▲

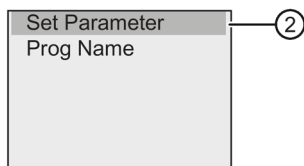

4. Confirm "②" with **OK**.

LOGO! shows the list of all available blocks, for example:

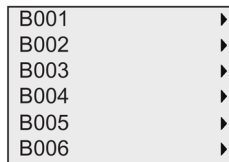

If no parameter can be set, the display shows as follows, and you can press **ESC** to return to the parameter assignment menu.

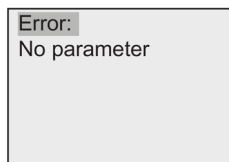

5. Press ▲ or ▼ to move the cursor to the block that you desire to change its parameter, and confirm with **OK**.

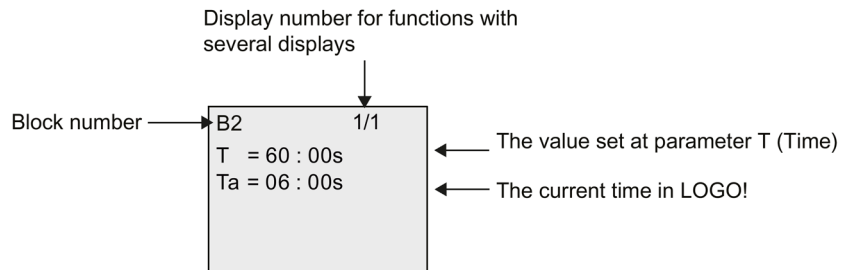

6. Now, select the desired parameter: Press ▲ or ▼
7. Select the parameter you want to edit, and press **OK**.

### 9.1.3 Modifying parameters

You first select the parameter you want to edit (Page 289).

You change the value of the parameter in the same way as you did in programming mode:

1. Move the cursor to the point at which you want to make the change: Press ◀ or ▶
2. To change this value: Press ▲ or ▼
3. To apply the value: **OK**

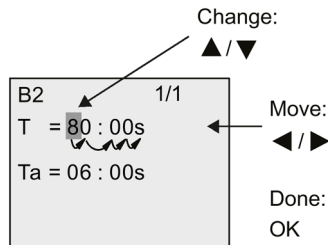

#### Note

When changing the time parameter when the system is in RUN, you can also change the timebase (s=seconds, m=minutes, h=hours). This does not apply if the time parameter represents the result of another function (for an example, see the "On-delay (Page 152)" topic). In this case you can neither change the value nor the timebase. The current time is reset to zero when you change the timebase.

### Current value of a time T

View of a time T in parameter assignment mode:

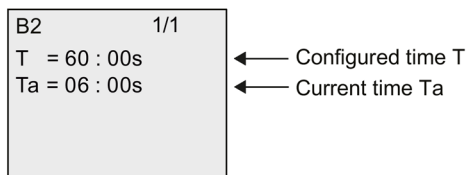

You can change the configured time T.

### Current timer value

View of a timer cam in parameter assignment mode:

B9	1/2
D1	= M-W-F- -
On1	= 09 : 00
Off1	= 10 : 00
D2	= -T- - - - -
On2	= 03 : 00



B9	2/2
Off2	= 04:15
D3	= - - - - -SS
On3	= 16:30
Off3	= 23:10
Pulse	= Off

You can change the on/off times and the day.

### Current value of a counter

View of a counter parameter in parameter assignment mode:

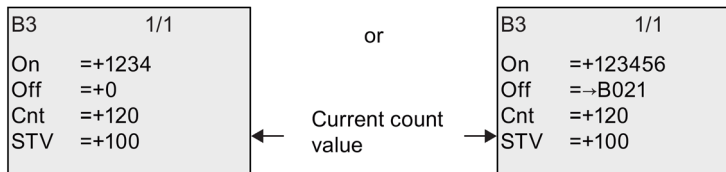

You can change the on/off threshold. This does not apply if the on or off threshold represents the result of another function (In the "Up/down counter (Page 186)" topic, this is B021).

### Current value of an hour counter

View of an hour counter parameter in parameter assignment mode:

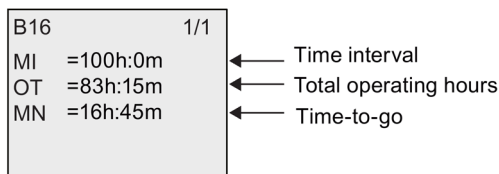

You can edit the configured time interval MI.

### Current value of a threshold trigger

View of the parameter of a threshold trigger in parameter assignment mode:

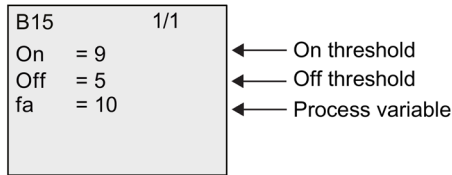

You can change the on/off threshold.

## 9.2 Setting the default values for LOGO!

You can set the following default values for a LOGO! Basic:

### Clock settings

You can set the default values for time-of-day and date (Page 293), summertime/wintertime conversion (Page 105) and Network Time Protocol (LOGO! 8.FS4 and later versions only) (Page 108) in programming mode or parameter assignment mode through the following menu commands:

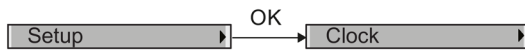

### Contrast and backlight settings

You can set the default value for the backlight (Page 295) and the default value for the display contrast (Page 295) in programming mode or parameter assignment mode through the following menu commands:

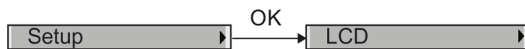

### Menu language

You can set the language (Page 297) in which LOGO! displays the menus in programming mode through the following menu commands:

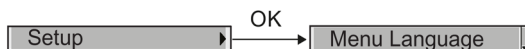



### Number of Base Module analog inputs

The LOGO! Base Modules LOGO! 24CE, LOGO! 24CEo, LOGO! 12/24RCE, and LOGO! 12/24RCEo support four analog inputs. Formerly they supported two. You can choose whether to use two or four analog inputs (Page 298) on these modules in programming mode through the following menu commands:

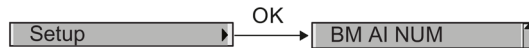

### Start screen settings

You can select the default setting for the start screen (Page 298) that displays on LOGO! when LOGO! transfers to RUN mode in programming mode or parameter assignment mode through the following menu commands:

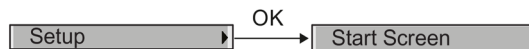

### Message text settings

You can select settings that apply to all message text function blocks (Page 212) in programming mode or parameter assignment mode through the following menu commands:

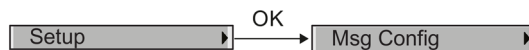

## 9.2.1 Setting the time of day and date

You can set the time of day and the date in programming mode or parameter assignment mode.

### Setting the time of day and the date in parameter assignment mode

Follow these steps to set the time of day and the date:

1. Select parameter assignment mode (Page 286).
2. On the parameter assignment menu, move the cursor to "①": Press ▼ or ▲

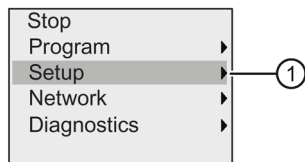

3. Confirm "①": Press **OK**

- 4. Move the cursor to "②": Press ▲ or ▼

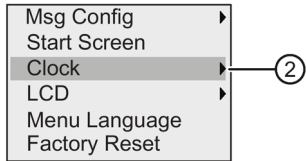

- 5. Confirm "②": Press OK
- 6. Move the cursor to "③": Press ▲ or ▼

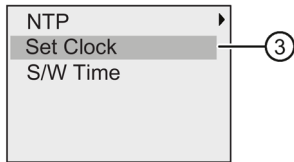

- 7. Confirm "③": Press OK

LOGO! shows the following display.



- 8. To set the correct time of day, press ◀ or ▶ to move the cursor to the desired position, and press ▲ or ▼ to change the value.
- 9. To set the correct date, press ◀ or ▶ to move the cursor to the desired position, and press ▲ or ▼ to change the value.
- 10. To confirm your entries: Press OK

### Setting the time of day and the date in programming mode

If you want to set the time of day and the date in programming mode, select "①" in the main menu, then menus "②" and "③". You can now set the date and the time as described earlier.

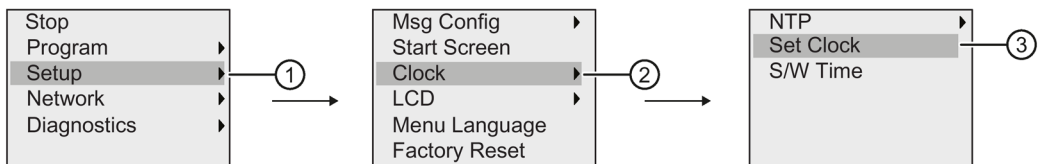

## 9.2.2 Setting the display contrast and backlight choice

You can set the default value for the display contrast and backlight in programming mode or parameter assignment mode.

### Setting the display contrast in parameter assignment mode

Follow these steps to set the display contrast:

1. Select parameter assignment mode (Page 286).
2. On the parameter assignment menu, move the cursor to "①": Press ▼ or ▲ .

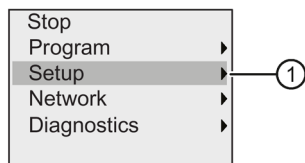

3. Confirm "①": Press OK .
4. Move the cursor to "②": Press ▼ or ▲ .

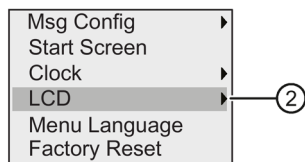

5. Confirm "②": Press OK
6. Move the cursor to "③": Press ▲ or ▼ .

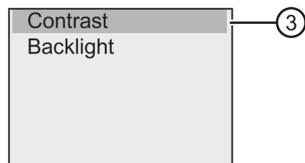

7. Confirm "③": Press OK .

LOGO! shows the following display:

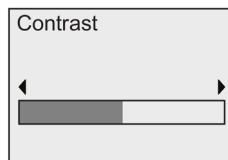

8. To change the display contrast: Press ◀ or ▶ .
9. To confirm your entry: Press OK .

### Setting the display contrast in programming mode

If you want to set the display contrast in programming mode, select menu command "①" in the main menu, then menus "②" and "③". You can now set the display contrast as described earlier.

### Setting the backlight choice in parameter assignment mode

Follow these steps to set the backlight choice:

1. On the parameter assignment menu, move the cursor to "①": Press ▼ or ▲ .

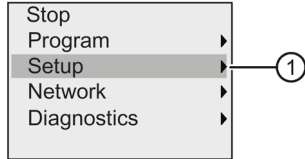

2. Confirm "①": Press **OK** .
3. Move the cursor to "②": Press ▼ or ▲ .

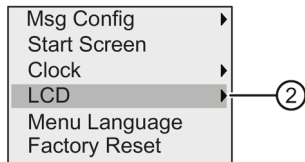

4. Confirm "②": Press **OK** .
5. Move the cursor to "③": Press ▲ or ▼ .

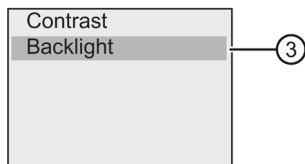

6. Confirm "③": Press **OK** .

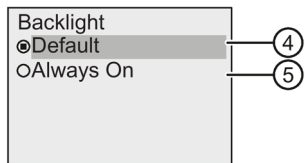

7. Move the cursor to "④" or "⑤": Press ▼ or ▲ .
8. Confirm "④" or "⑤": Press **OK** .

The default setting is that the backlight is not on. To set the backlight to always be on, select "⑤".

## Setting the backlight choice in programming mode

If you want to set the backlight in programming mode, select menu command "①" in the main menu, then menus "②" and "③". You can now set the backlight as described earlier.

### Note

The backlight lifetime of the LOGO! TDE is 20000 hours.

You can change the backlight colors of the LOGO! onboard display or the LOGO! TDE by means of some special flags (M25, M26, M28 to M31). For more information, refer to section "Constants and connectors (Page 130)". If you use these special flags in your circuit programs, the backlight setting through the above menu commands takes no effect.

## 9.2.3 Setting the menu language

The language of the LOGO! menus can be one of ten predefined languages:

German	English	French	Spanish	Italian
Chinese	Dutch	Turkish	Russian	Japanese

### Setting the menu language in programming mode

You can set the menu language in programming mode only:

1. In the main menu of programming mode, move the cursor to "①": Press ▼ or ▲

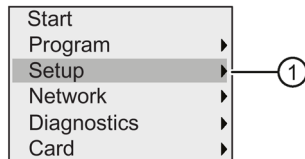

2. Confirm "①": Press OK
3. Move the cursor to "②": Press ▼ or ▲

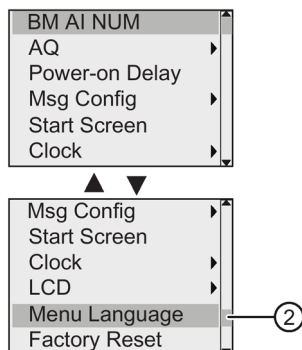

4. Confirm "②": Press OK

5. Move the cursor to the language of your choice: Press ▲ or ▼
6. Confirm language selection: Press **OK**

### 9.2.4 Setting the number of AIs in LOGO!

LOGO! 12/24RCE/RCEo and LOGO! 24CE/24CEo support up to four onboard inputs that can be used as either digital or analog inputs (0 V to 10V). Inputs I7 (AI1) and I8 (AI2) are available as analog inputs by default, whether you use them or not. Inputs I1 (AI3) and I2 (AI4) are optional analog inputs. LOGO! provides a menu where you can choose to use two analog inputs (the default, AI1 and AI2), or four, or even zero. Regardless of the settings, inputs I1 and I2 can be used as digital inputs. To use them as analog inputs AI3 and AI4, you must set the number of analog inputs to four. Note that the number of configured analog inputs on LOGO! affects the subsequent numbering of analog inputs on attached expansion modules (see the "Maximum setup (Page 34)" topic).

You can set the number of AIs in programming mode only.

#### Setting the number of AIs in programming mode

Follow these steps to set the number of analog inputs:

1. In the main menu of programming mode, select "①": Press ▼ or ▲

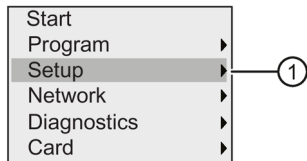

2. Confirm "①": Press **OK**
3. Select "②": Press ▼ or ▲

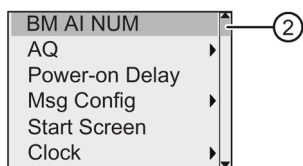

4. Confirm "②": Press **OK**
5. Move to "0 AI", "2 AIs" or "4 AIs": Press ▲ or ▼
6. Confirm your selection with **OK**, and the setting takes effect immediately.

### 9.2.5 Setting the start screen

You can select the default setting for the start screen that LOGO! displays in RUN mode. You make this selection from LOGO! in either parameter assignment mode or programming mode.

## Selecting the start screen in parameter assignment mode

Follow these steps to select the start screen for LOGO!:

1. Select parameter assignment mode (Page 286).
2. On the parameter assignment menu, move the cursor to "①": Press ▼ or ▲ .

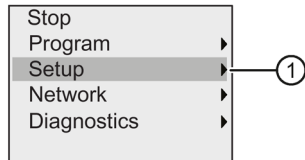

3. Confirm "①": Press **OK** .
4. Move the cursor to "②": Press ▲ or ▼ .

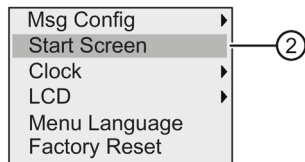

5. Confirm "②": Press **OK** .

The display now shows:

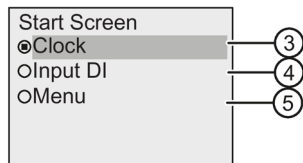

The current setting of the start screen is indicated by the circle with a dot. The default setting is "③".

You can choose to display the current time-of-day and date (③), the values of the digital inputs (④), or the parameter assignment menu (⑤).

6. Select the desired default setting: Press ▲ or ▼ .
7. To confirm your entry: Press **OK** .

Power LOGO! off then on to make your changes take effect. When LOGO! is in RUN mode, it displays the start screen that you selected.

## Using memory cards

For program storage, LOGO! supports micro SD cards that support below file system format:

- LOGO! 8.3 and earlier versions only support micro SD cards that support FAT32 file system format.
- LOGO! 8.4 and later versions support micro SD cards that support FAT32 and exFAT file system format.

You can store and copy-protect a circuit program, with or without the data log of process data, from a LOGO! device to a micro SD card, or copy a circuit program from the card to a LOGO! device.

LOGO! allows you to store only one circuit program in its memory. If you want to modify the circuit program or create an additional one without deleting the first, you must archive it somewhere.

For detailed information about how to format micro SD cards, see Section "Formatting micro SD cards (Page 300)".

For detailed information about the copy protection function, see Section "Program copy protection (Page 314)".

For detailed information about the data log, see Chapter "Data log (Page 284)".

### Upward compatibility of circuit programs

You can transfer circuit programs written for the previous versions 0BA0...0BA7 to 0BA8 devices from LOGO!Soft Comfort.

## 10.1 Formatting micro SD cards

As LOGO! 8.3 and earlier versions only supports micro SD cards that support FAT32 file system format, and LOGO! 8.4 and later versions support micro SD cards that support FAT32 and exFAT file system format for program storage, you must format the micro SD card first if it supports other file systems. The following examples describe how to format a micro SD card under operating systems Windows 7, Linux Suse® and Mac OS ® respectively.



## Formatting under Windows OS

Follow the steps below to format the micro SD card under Windows OS:

1.

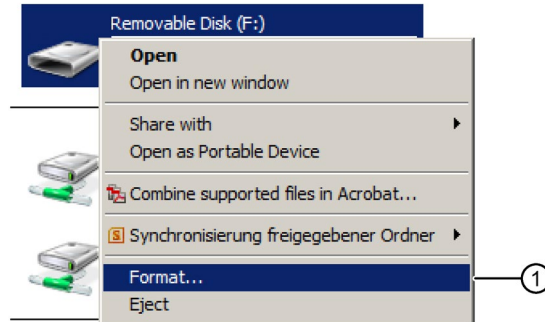

2.

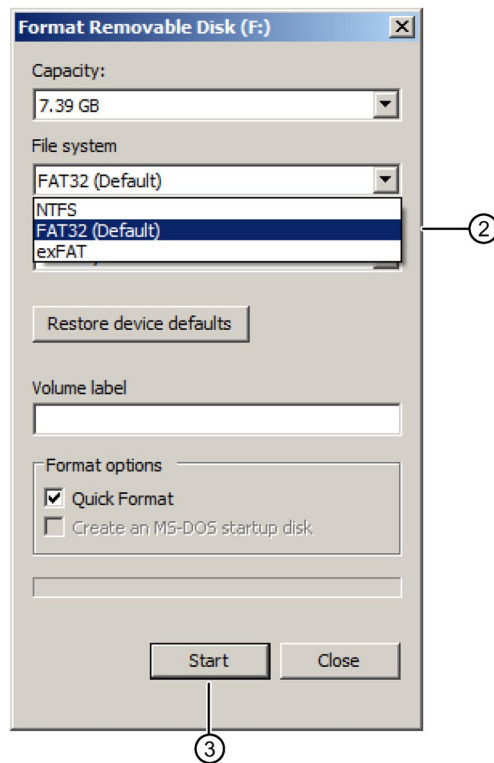

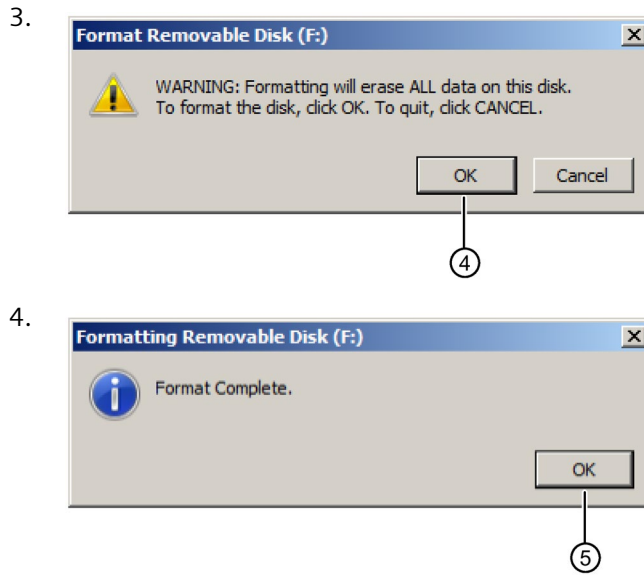

## Formatting under Linux OS



1. Open the following terminal in the application browser to enter commands:



2. Enter the first command "fdisk -l" in the terminal to search for the removable device block name and "/dev/sdc1" is found.
3. Enter "sudo umount /dev/sdc1" to uninstall device.
4. Enter "sudo mkfs.vfat -f 32 /dev/sdc1" and formatting is completed.

## Formatting under Mac OS

Follow the steps below to format the micro SD card under MAC OS:

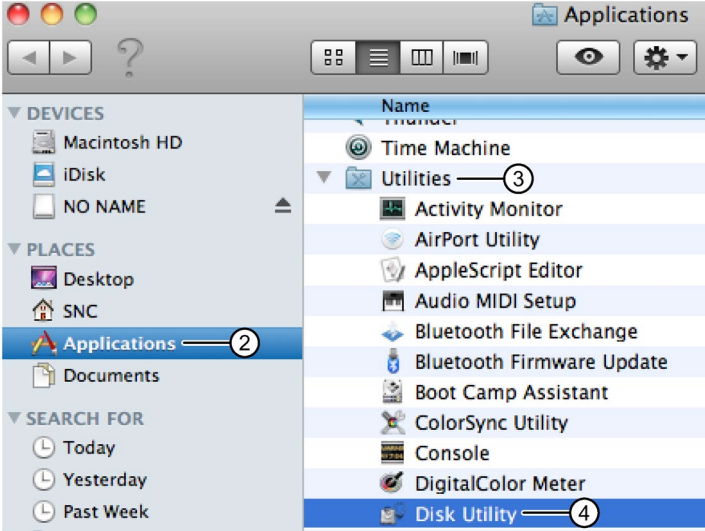
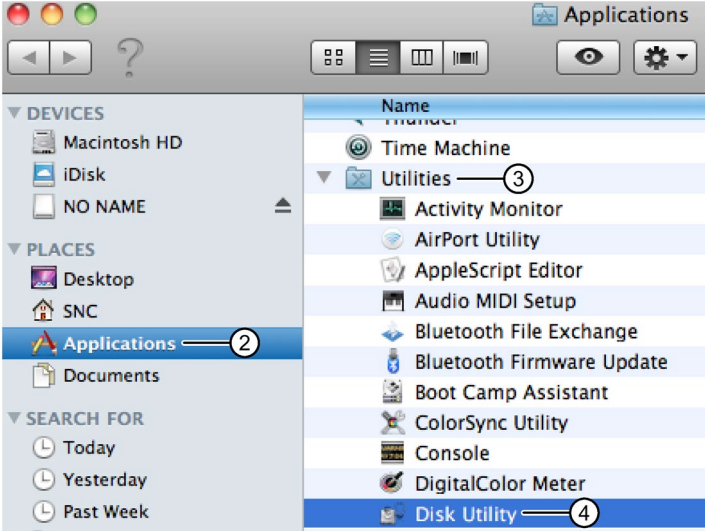
- 1. 
- 2. 

10.2 Inserting and removing the card from LOGO!

3.

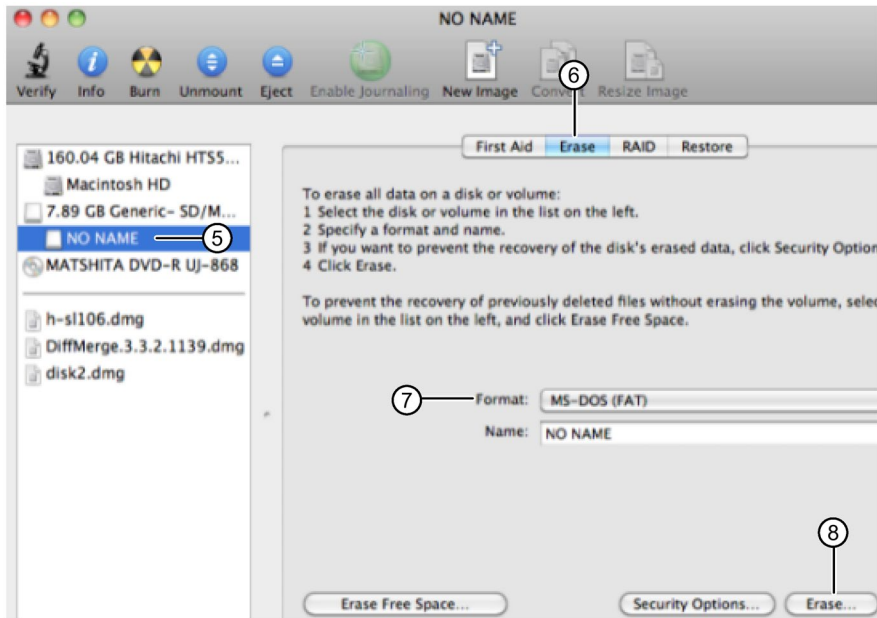

4.

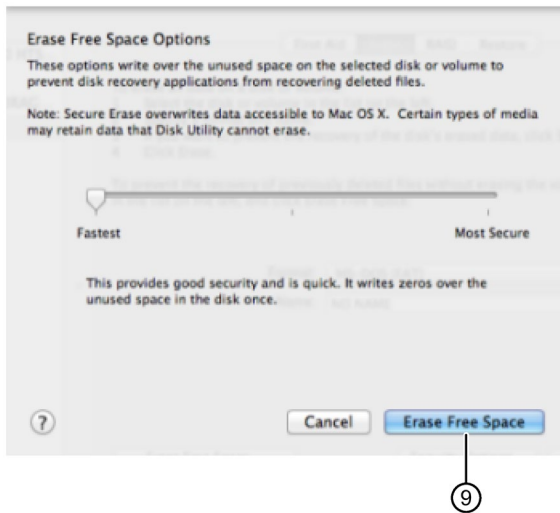

## 10.2 Inserting and removing the card from LOGO!

When you remove a micro SD card that contains a circuit program with copy protection attributes, note the following: LOGO! can only execute the circuit program stored on the card if the card remains inserted during system runtime.

A removal of the card during RUN mode can lead to impermissible operating states.

### WARNING

#### Fire hazard

Insert/remove under hazardous location may trigger a fire in the machine or plant.

Death or serious injury could occur.

Do not insert/remove the memory card in hazardous locations.

## Removing the micro SD card

To remove the micro SD card, carefully insert a screwdriver with a 3-mm blade into the groove on the front of the socket, and lever the socket partially out of the slot. Pull the socket to the position as the following figure shows. You can now remove the micro SD card from the socket.

### Note

To avoid any possible damage to the SD card socket, do not pull the socket completely out from the module.

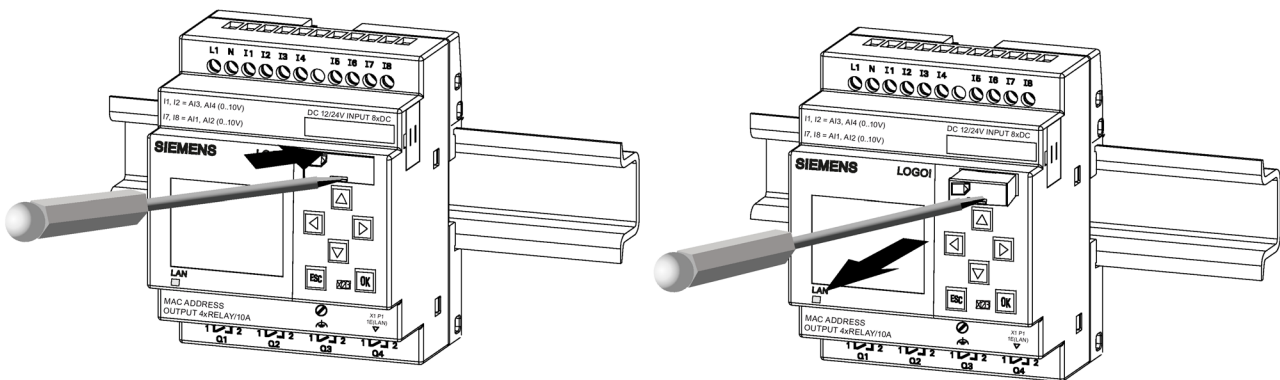

## Inserting the micro SD card

The entry of the card slot is chamfered on its bottom right. The edge of the cards is chamfered accordingly. This encoding prevents you from inserting cards in the wrong way. Insert the card into the holder and push it in until it engages.

### Note

Make sure that you insert the card into the right position in the socket until you hear an audible sound of a click.

**Note**

If the SD card socket cannot be pushed in smoothly, don't push hard. Pull the card, adjust the direction, and push it in again. Refer to the following figure for the right direction.

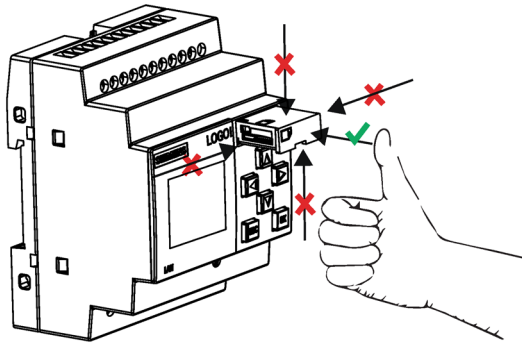

### 10.3 Copying data from LOGO! to the card

#### Copying data from LOGO! to the card manually

To manually copy the circuit program to the micro SD card, follow the steps shown in the illustration below:

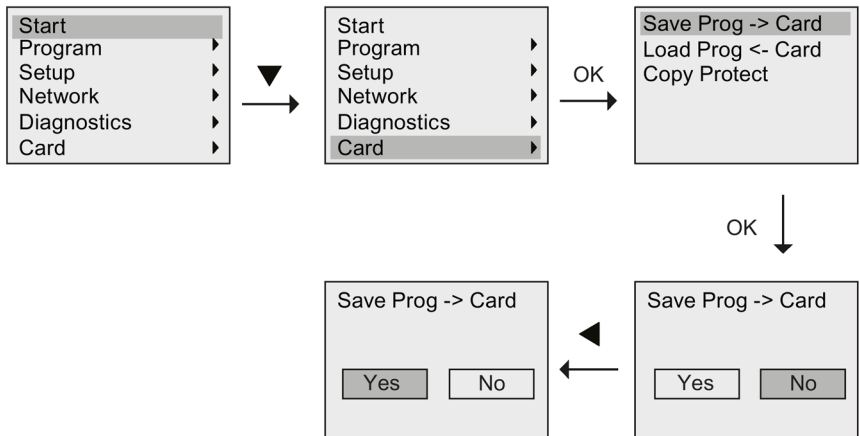

Press OK. LOGO! starts copying the circuit program to the card.

If power fails while LOGO! is copying the circuit program, repeat the process after power-on.

---

**Note**

- If the program is empty, a message will display on the screen to remind you the program in LOGO! is empty.
  - The password of a protected circuit program in LOGO! also applies to the copied program version on your card.
- 

### Copying data from LOGO! to the card automatically

LOGO!Soft Comfort provides an option for automatically copying the circuit program to the micro SD card when transferring the circuit program to LOGO!. This option is available in the dialog for PC->LOGO! transfer. If you select this option, LOGO!Soft Comfort transfers the circuit program to LOGO! and to the micro SD card.

---

**Note**

To successfully copy the circuit program from LOGO! to the micro SD card, make sure that the free memory space available on the micro SD card is at least 1 M bytes.

---

### Function block parameters can be saved automatically

In LOGO! 8.FS5 and later versions, if the parameters for function block have some modifications, they can be saved to SD card automatically.

### Generating the data log on the micro SD card

If your circuit program in LOGO! includes a Data Log function block configured from LOGO!Soft Comfort, you can save the data log in your LOGO! or on the micro SD card. If there is a micro SD card inserted into the slot of your LOGO!, then when LOGO! switches from STOP to RUN, it attempts to copy the data log to the micro SD card; otherwise, LOGO! saves the data log in memory. At every STOP to RUN transition, LOGO! determines the destination of the data log storage.

If LOGO! copies the data log to the micro SD card, it saves the data log by default as .CSV file format, which you can then open from a PC. Each line in the .CSV file includes a time stamp, the function block number and the actual values recorded. For more information about the data log, refer to chapter "Data log (Page 284)".

---

**Note**

- For LOGO! 8.3 and earlier versions, when LOGO! with an inserted micro SD card is in STOP mode, you can upload the most recent data log file on the micro SD card to LOGO!Soft Comfort using a transfer menu command in LOGO!Soft Comfort. For more information about the data log uploading command, refer to *LOGO!Soft Comfort Online Help*.
  - For LOGO! 8.4 and later versions, you can upload at most 50 recent log files on the micro SD card to LOGO!Soft Comfort no matter when LOGO! is in STOP or RUN mode.
-

## 10.4 Copying data from the card to LOGO!

You can copy a circuit program from a micro SD card to LOGO! in one of the following ways:

- Automatically during the startup of LOGO! (POWER ON)
- By means of the card specific menu of LOGO!

---

### Note

If the program on the card is protected with a password, the copied program in LOGO! is also protected with the same password. For more information about the Card menu, refer to Section "Overview of LOGO! menus (Page 74)".

---

### Automatic copying during the startup of LOGO!

To automatically copy the circuit program to LOGO!, follow these steps:

1. Switch off the power supply to LOGO!.
2. Insert the card into the relevant slot.
3. Switch on the power supply to LOGO!.

LOGO! copies the program from the program module/card to LOGO!. For LOGO! 8.4 and later versions BM, when LOGO! finishes copying, BM is in STOP mode. It opens the LOGO! main menu as the following:

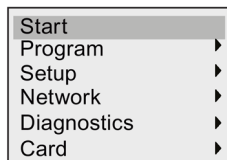

For LOGO! 8.3 and earlier versions BM, when LOGO! finishes copying, BM is in the same status as the one before it's powered off. If BM is in RUN mode before it's powered off, after copying the circuit program, BM is also in RUN mode and you can ignore the following steps.

---

### Note

Before you switch LOGO! to RUN, you must ensure that the system you are controlling with LOGO! does not represent a source of hazard.

---

4. Move the cursor to the first menu command in Step 3: Press ▲ or ▼.
5. Press OK.



### Copying by means of the card specific menu

For more information about the replacement of a micro SD card, refer to Section "Inserting and removing the card from LOGO! (Page 304)".

To copy a program from the card to LOGO!, insert the card and follow the steps shown in the illustration below:

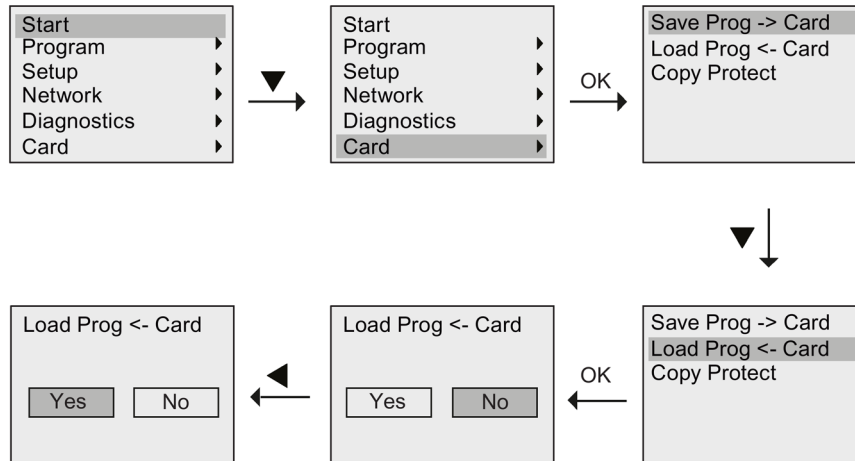

Press OK. LOGO! copies the circuit program from the card to LOGO!. When LOGO! has finished copying, it automatically returns to the LOGO! main menu.

## Overview

This chapter describes the following security functions on LOGO!:

Security function	Description
Network security	<p>LOGO! 8.3 (and later version) Base Module can connect to Cloud (Page 268) through MQTT.</p> <p>To protect your network communication, LOGO! 8.3 (and later version) Base Module uses HTTPS for the following connections:</p> <ul style="list-style-type: none"> <li>• LOGO!Soft Comfort V8.3 (or later version) and LOGO! 8.3 TDE</li> <li>• LOGO! BM and LOGO!Soft Comfort V8.3 (or later version)/LOGO! Web Editor V1.1 (or later version)</li> <li>• LOGO! Access Tool V2.1 (or later version)/standard web browser and LOGO! 8.3 (or later version) BM</li> </ul> <p>If authentication, encryption, or integrity protection is required in the Network, Siemens recommends that you protect network and physical access to the LOGO! devices with appropriate measures.</p> <p>For more information about Network security, you can refer to Network security (Page 311).</p>
Program access security	<p>The following protection methods can help you protect your circuit programs from unauthorized access:</p> <ul style="list-style-type: none"> <li>• Password protection</li> <li>• Copy protection</li> </ul> <p>For detailed information, you can refer to Program access security (Page 313).</p>
Menu access security	<p>You can limit access to specific menus of LOGO! by setting the access level.</p> <p>For detailed information, you can refer to Menu access security (Page 316).</p>

### WARNING

#### Protect the device against unauthorized access

An unauthorized user can operate the device incorrectly, read or write data and bypass logon by restarting the device.

Operation by unauthorized persons jeopardizes operational reliability.

You must protect these forms of communication by limiting physical access. Siemens recommend you lock the LOGO! devices in a cabinet.

**Note**

The communication protocol for LOGO! is designed for use in a trusted environment, and allows unauthenticated access to the devices. Siemens therefore strongly recommends you protect network access to the LOGO! devices with appropriate mechanisms.

**Note****Protect communication with LOGO! devices through white list mechanism.**

Siemens recommends that you use white list mechanism to protect the communication with LOGO! devices. White list mechanism works when you don't use the default product root certificate as trust anchor, but use each independent unique issuing certificate. When one LOGO! device is broken or out of use, you can remove the device issuing certificate out of trusted repository.

About how to download LOGO! issuing certificate, refer to section *Tools -> Transfer -> Certificate Settings* in *LOGO!Soft Comfort Online Help*.

## 11.1 Network security

With the enhanced network security of LOGO! 8.3 (and later version) devices, you can access the LOGO! 8.3 (and later version) Base Modules through a local area network, a remote area network or a Cloud.

Different devices/software connect to LOGO! devices with different channels.

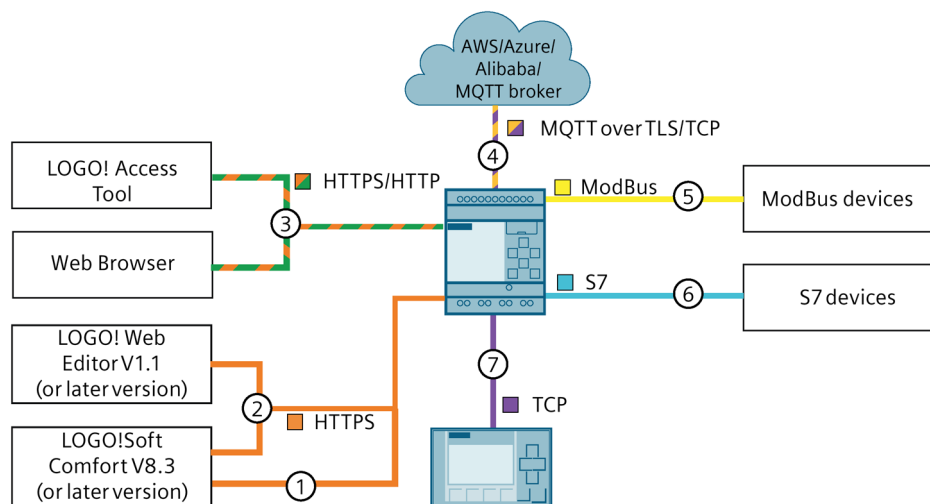

Con- nec- tions	Supported APP/Device	Port	Ac- count	Proto- cols	Remarks
①	LSC V8.3 (or later version)	8443 (on TDE)	LSC user	HTTPS	Only one LOGO!Soft Comfort V8.3 (or later version) can connect to a LOGO! 8.3 TDE at a time.
②	LSC V8.3 (or later version) LWE V1.1 (or later version)	8443	LSC user	HTTPS	<ul style="list-style-type: none"> <li>Only one connection can be established between LOGO! 8.3 (or later version) BM and LOGO!Soft Comfort V8.3 (or later version) or LOGO! Web Editor V1.1 (or later version).</li> <li>Only one LOGO!Soft Comfort V8.3 (or later version) can connect to a LOGO! 8.3 (or later version) BM at a time.</li> </ul>
③	LOGO! Access Tool	80/443	Web User	HTTPS/H TTP	<p>You can select to use HTTPS or HTTP by LOGO!Soft Comfort V8.3 (or later version).</p> <ul style="list-style-type: none"> <li>For LOGO! 8.3 BM, Cloud access must be disabled. When HTTPS is enabled,</li> <li>Only two connections can be established between LOGO! 8.3 (or later version) BM and LOGO! Access Tool/Web Browser.</li> </ul>
	Web Browser	80/443	Web User / Web Guest		
④	Cloud			MQTT over TLS/TCP	<ul style="list-style-type: none"> <li>For AWS, Azure and Alibaba Cloud connection, the connection mode is MQTT over TLS.</li> <li>For general MQTT broker connection, you can choose the connection mode as MQTT over TLS or TCP. Refer to Secure Cloud connection (Page 273) for details.</li> <li>When the Cloud connection is enabled, LOGO! 8.3 BM cannot establish connection to LOGO! Access Tool/Web Browser.</li> </ul>
⑤	Modbus devices	502-510		Modbus	You can enable or disable the S7/Modbus connections through LOGO!Soft Comfort V8.3 (or later version).
⑥	S7 devices	102		S7	<ul style="list-style-type: none"> <li>In the programs created by LOGO!Soft Comfort V8.3 (or later version), the S7/Modbus connections are disabled by default.</li> <li>In the programs converted from previous version LOGO!Soft Comfort, the S7/Modbus connections are enabled after the conversion.</li> </ul>
⑦	LOGO! TDE	135	TDE Onboard User	TCP	<p>LOGO! TDE connects to LOGO! BM through unsecured channel. The connection is enabled by default.</p> <p>You can disable the connection through LOGO!Soft Comfort V8.3 (or later version).</p>

In order to maintain an adequate security level, Siemens strongly recommends that you open the ports only at firewalls within the Secure Network. The table above lists all the port information for the LOGO! supported applications.

All static resources used in LOGO! Web server or LWE project, for example, pictures or PDF files, is not protected by login password. You can access to these resources by entering corresponding static resource URL in the web browser without logging in LOGO! Web server.

For more information about network security, refer to Network Security (<http://www.industry.siemens.com/topics/global/en/industrial-security/network-security/Pages/Default.aspx>).

 **WARNING**

**Unauthorized access to the LOGO! through the Web server**

Unauthorized access to the LOGO! devices or changing LOGO! variables to invalid values could disrupt process operation and could result in death, severe personal injury and/or property damage. Because enabling the Web server allows authorized users to perform operating mode changes, writes to LOGO! data, and firmware updates, Siemens recommends that you observe the following security practices:

- Enable access to the Web server only with the HTTPS protocol.
- Password-protect Web server user IDs with a strong password. Strong passwords are ten characters in length, mix letters, numbers, and special characters, are not words that can be found in a dictionary, and are not names or identifiers that can be derived from personal information. Keep the password secret and change it frequently.
- Perform error-checking and range-checking on your variables in your program logic because Web page users can change PLC variables to invalid values.
- Use a secure Virtual Private Network (VPN) to connect to the Logo! Web server when you use HTTP protocol.

 **WARNING**

**Unauthorized access to the LOGO! through unsecure port (502-510 for Modbus, 102 for S7, 135 for LOGO! TDE )**

Unauthorized access to the LOGO! devices or changing LOGO! variables to invalid values could disrupt process operation and could result in death, severe personal injury and/or property damage.

Because enabling the unsecure port allows authorized users to perform operating mode changes, writes to LOGO! data, and firmware updates, Siemens strongly recommends that you open the ports only at firewalls within the Secure Network.

## 11.2 Program access security

### 11.2.1 Program password protection

You can protect your circuit program from unauthorized access with a password. Siemens strongly recommends you use password protection to prevent unauthorized reading or editing of your circuit programs.

11.2 Program access security

For more information about assigning and changing a program password, refer to Section "Password for circuit program protection (Page 84)".

**Note**

If a password protection program is stored in a LOGO! Base Module and you want to download a new one, you must enter the password in order to unlock the current program.

**Note**

Circuit programs edited and saved in LOGO! 8 (6ED1052-xxx08-0BA1) and later versions BM are encrypted.

**11.2.2 Program copy protection**

The copy protection function provides protection for circuit programs on micro SD cards. A circuit program is **protected** when you transfer it to a protected memory card.

This additional security feature allows you to bind the circuit program to a specific memory card. If you copy a protected circuit program to another memory card, LOGO! cannot recognize the program and rejects loading it after you insert the card.

To execute this circuit program in LOGO!, you must leave the card in the LOGO! Base Module; that is, you cannot remove the card to copy the program to other LOGO! devices.

A circuit program with password protection is no longer protected after the correct password has been entered; that is, you can then edit or copy the program and remove the card.

**Operation status under the different functions**

The following table describes which operations are possible:

Operations	Editing	Copying	Deleting
Without Program password protection and without Program copy protection	Yes	Yes	Yes
With Program password protection, without Program copy protection	Yes, with password	Yes	Yes
Without Program password protection, with Program copy protection	No	No	Yes
With Program password protection and with Program copy protection	Yes, with password	No	Yes

## Enabling the protection function

To assign the copy protection function to the card, follow these steps:

1. Enter the programming mode and move the cursor to "①": Press ▼ or ▲

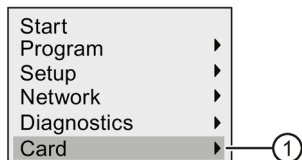

2. Confirm "①" with **OK**.
3. Move the cursor to "②": Press ▼ or ▲

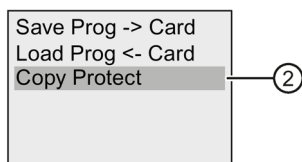

4. Confirm "②" with **OK**.

LOGO! shows the following display:

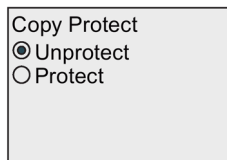

By default, the card is unprotected.

5. Move the cursor to "③": Press ▼ or ▲

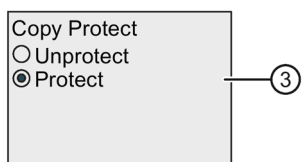

6. Move the cursor to "④": Press ▼ or .

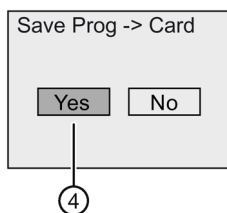

7. Confirm "④" with **OK**.

Then you can enable the protection function and save the program to card.

**Note**

The protection function applies only to the card; you must copy (Page 306) the circuit program to the card in a separate action at power-on.

You can always change the status of the protection function from "disabled" to "enabled".

You can always change the status of the card protection from "protection function disabled" to "protection function enabled".

---

## 11.3 Menu access security

LOGO! provides two access levels, administrator and operator, to limit access to specific menus in programming mode. As an administrator, you can access all menu commands. As an operator, some specific menu commands are not visible. LOGO!'s default setting is administrator, which you can change to operator at any time. When switching from operator to administrator, you must enter a valid password.

**Note**

For menu access security, Siemens recommend that you set a strong password. Strong passwords are at least eight characters in length; mix letters, numbers, and special character; are not words that can be found in a dictionary; and are not names or identifiers that can be derived from personal information. Keep the password secret and change it frequently. To learn how to change the password, refer to section "Tools -> Transfer -> Access Control" in *LOGO!Soft Comfort Online Help*.

---

LOGO! always saves its access level before power-off. For more information about switching between the access levels, refer to section "Configuring menu access protection for LOGO! (Page 71)".

**Note**

The access level of the LOGO! TDE is operator by default, and you can switch it to administrator with the password.

The LOGO! TDE saves its access level before power-off if it connects to the same LOGO! Base Module after power-on. If you connect a different LOGO! Base module to it, however, the LOGO! TDE restores its access level to operator after power-on.

---



## 11.4 Installing LOGO! Root certificate

LOGO! Root certificate is the trust anchor of LOGO! device. You need to import the LOGO! Root certificate before using HTTPS to visit BM with browsers or LOGO! Access Tool. You can import the LOGO! Root certificate to the following OS and browsers:

- Windows
  - Edge 90.0 to 126.0
  - Firefox 67.0 to 115.13
  - Google Chrome 63.0 to 126.0
  - Opera 84.0 to 125.0
- Mac OS and IOS
  - Apple Safari 12.1.2 to 15.6.1
  - Firefox 67.0 to 128.0
  - Google Chrome 70.0 to 126.0
  - Opera 84.0 to 111.0
- Linux (64 bit)
  - Firefox 91.8 to 115.13
  - Google Chrome 91.0 to 126.0
  - Opera 81.0 to 84.0

---

### Note

LOGO! Root Certificate cannot be installed in Android system.

---

### Prerequisite

You can get the "LOGOV84RootCAV10.cer" in one of the following path:

- on DVD: **Windows, Linux, or MAC → Application“\_operating system version” → res**  
“\_operating system version” is available only for Linux and Windows.

---

### Note

You may find more than one root certificate file in the path:

- LOGORootCert.crt: works for LOGO! 8.3 Base Module.
  - LOGORootCert.pem: works for LOGO! 8.3 Base Module.
  - LOGOV84RootCAV10.cer: works for LOGO! 8.4 Base Module.
- 
- in LOGO! Web Editor installation path: The LOGO! Web Editor installation drive (such as C:) → **Program Files → lwe → lwe → res**
  - in LOGO!Soft Comfort installation path: The LOGO!Soft Comfort installation drive (such as C:) → **Program Files → Siemens → LOGOComfort\_V8.4 → res**

## 11.4.1 Installing the certificate for Windows

### Install LOGO! Root Certificate for Windows

1. Open the certificate by double-clicking the **LOGOV84RootCAV10.cer**, and then click ①.

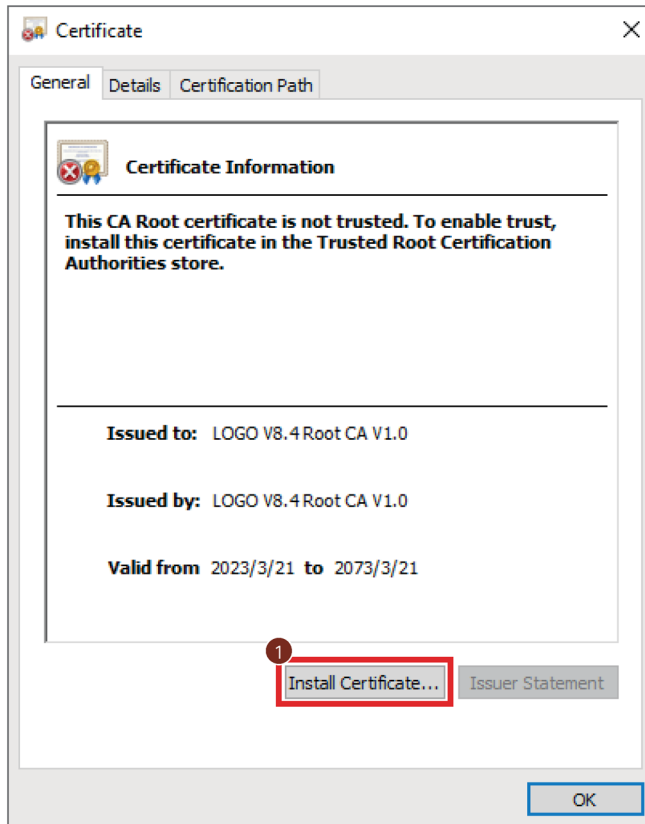

2. In the certificate import Wizard welcome page, select the store location ②.
  - If you select "Current User", the certificate is only valid for the current user.
  - If you select "Local Machine", the certificate is valid for all the user on this PC. Only administrator can install the certificate as "Local Machine".

3. Click ③ to continue.

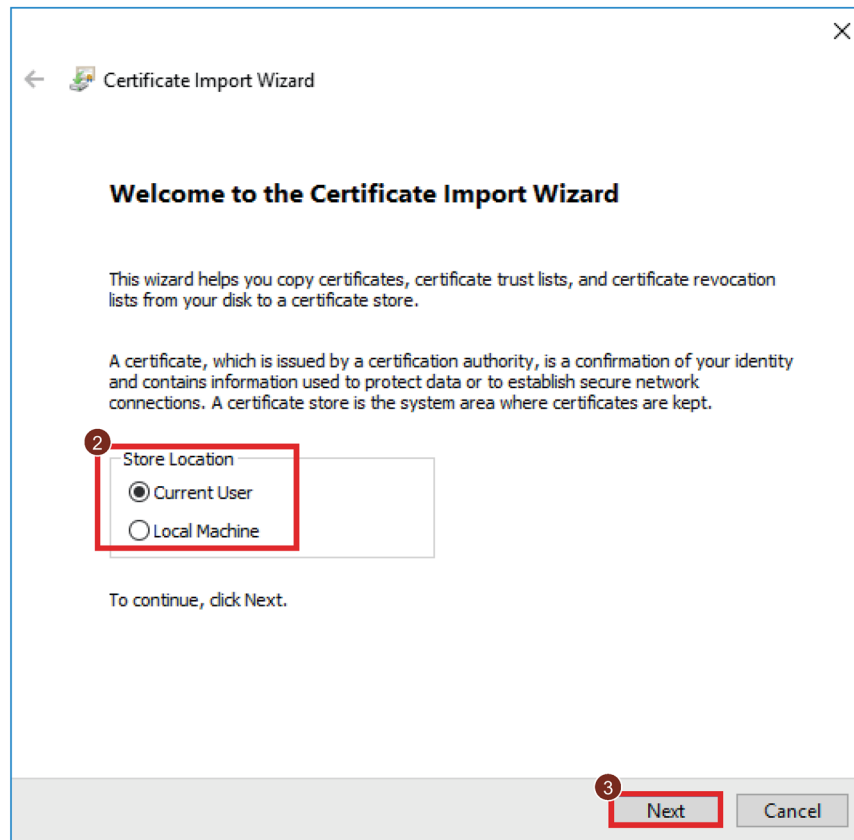

4. Select the check box of ④ and click ⑤ to store the certificate.
5. Trust the certificate by selecting ⑥ in the pop-up window and then clicking ⑦.

6. Click ⑧ to continue.

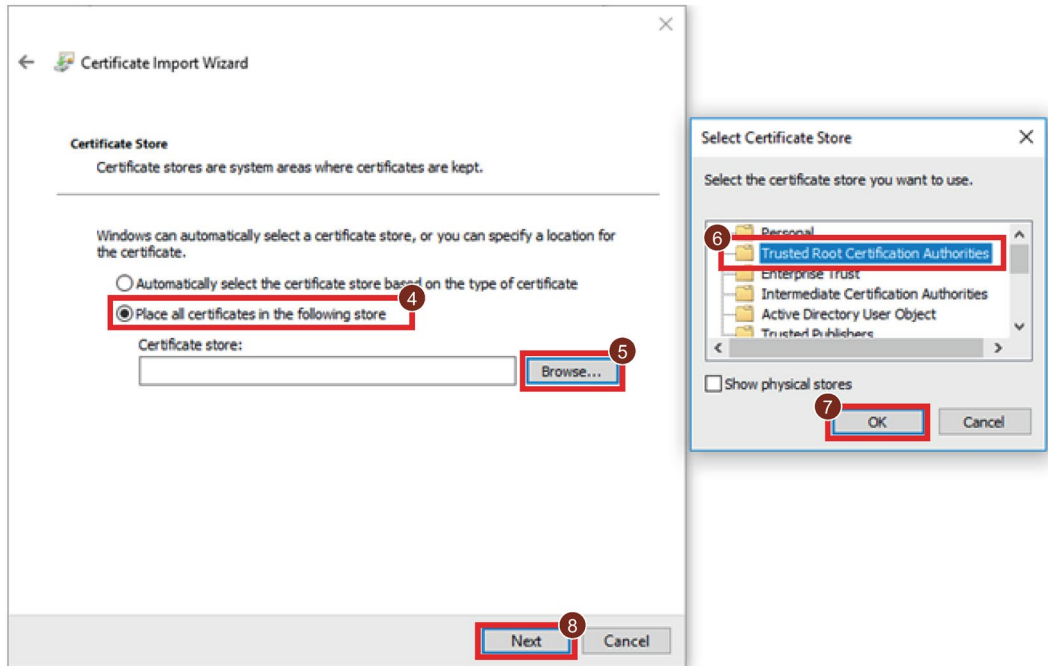

7. Click ⑨ to confirm your selection.

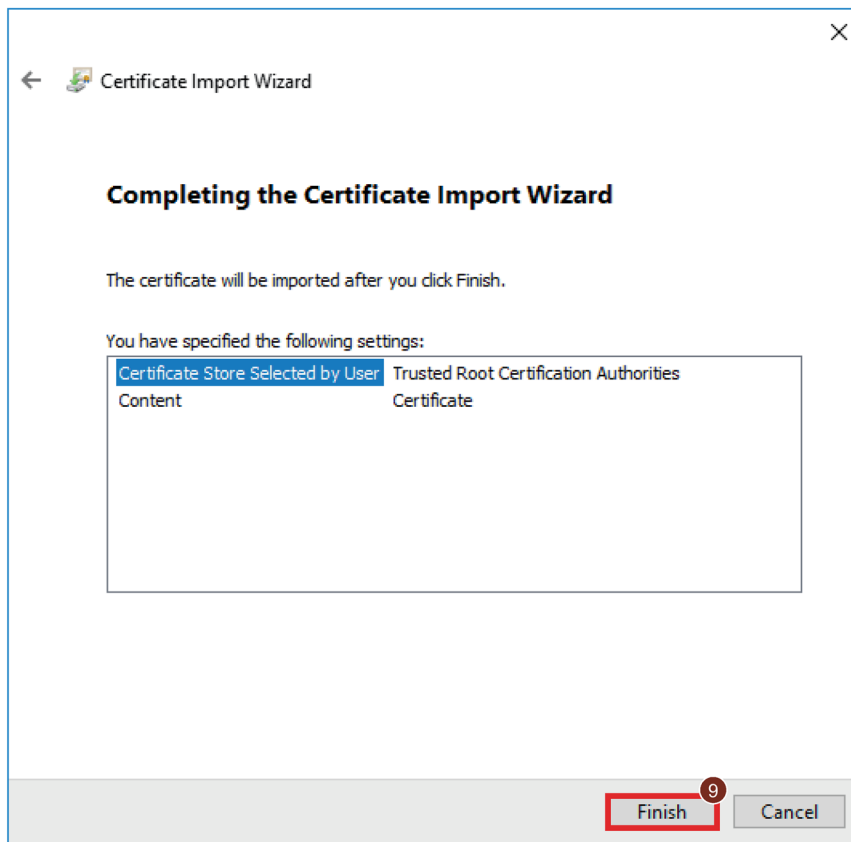

- Click the "Yes" button to confirm the installation.

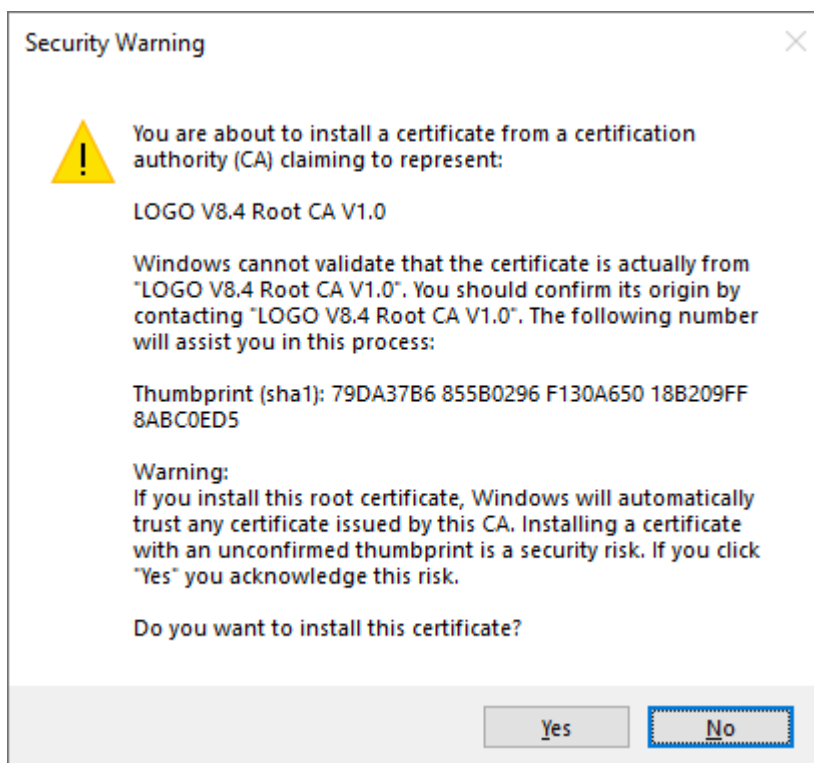

If Firefox still cannot trust the certificate after you installed the certificate, modify the setting as below steps:

- Start Firefox.
- Enter `about:config` in the address bar at the top of the browser.

3. Click ①.

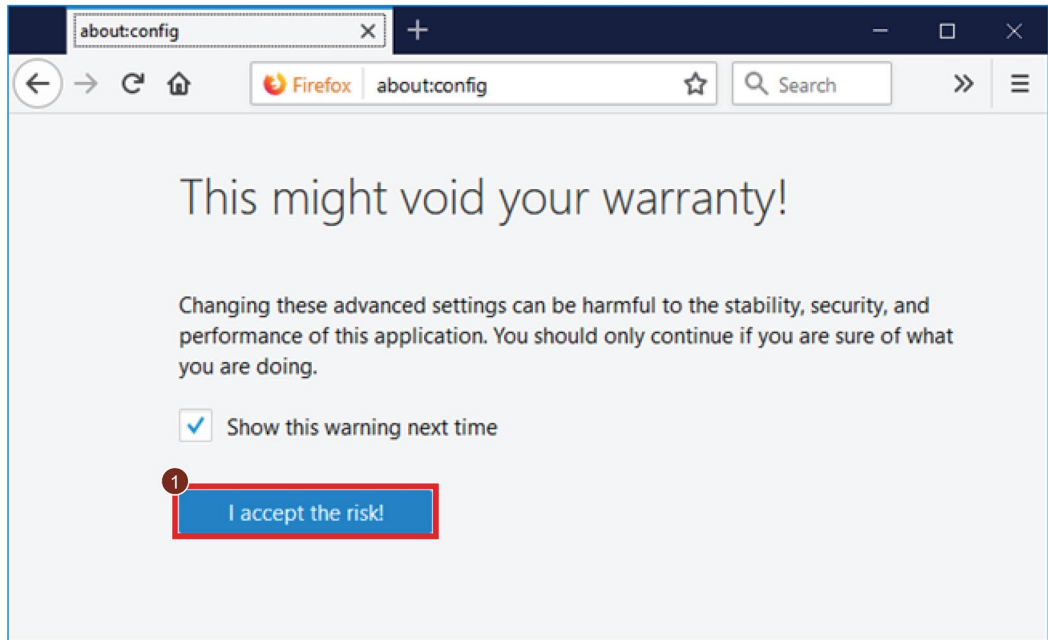

4. Enter `security.enterprise_roots.enabled` in the search bar and set its value as "true".

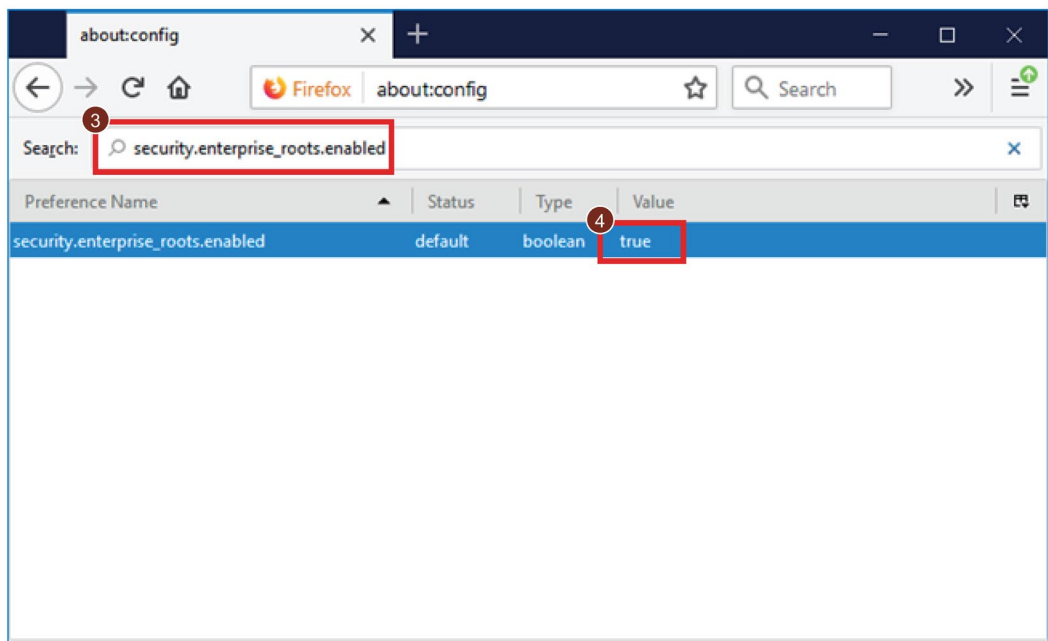

## 11.4.2 Installing the certificate for Linux

In the Linux system, you need to import the certificate in each browser separately.

### Install the certificate for Firefox

1. Start Firefox.
2. Select ① → ② to open the preference.

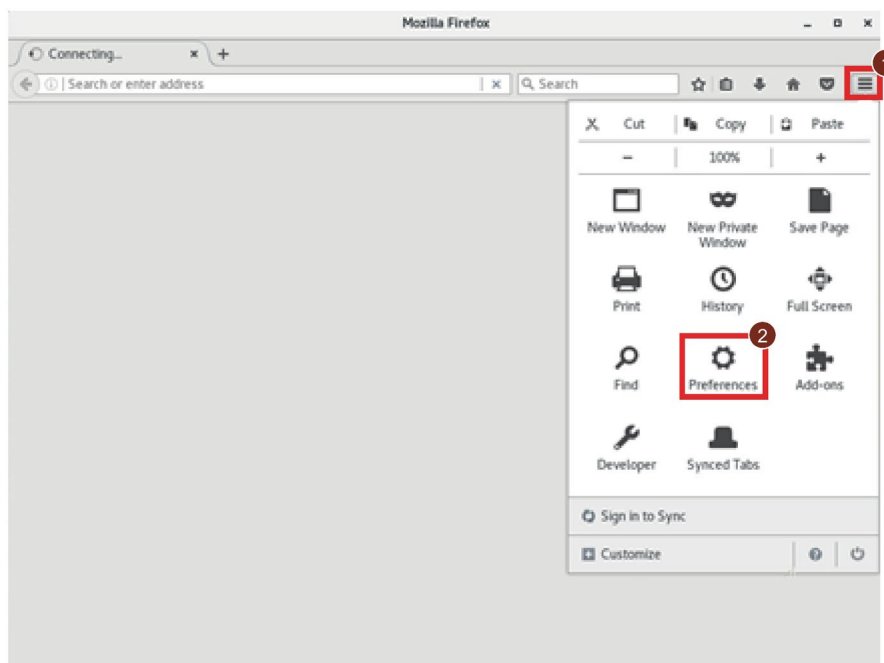

3. Select ③ → ④ → ⑤ to view the certificates.

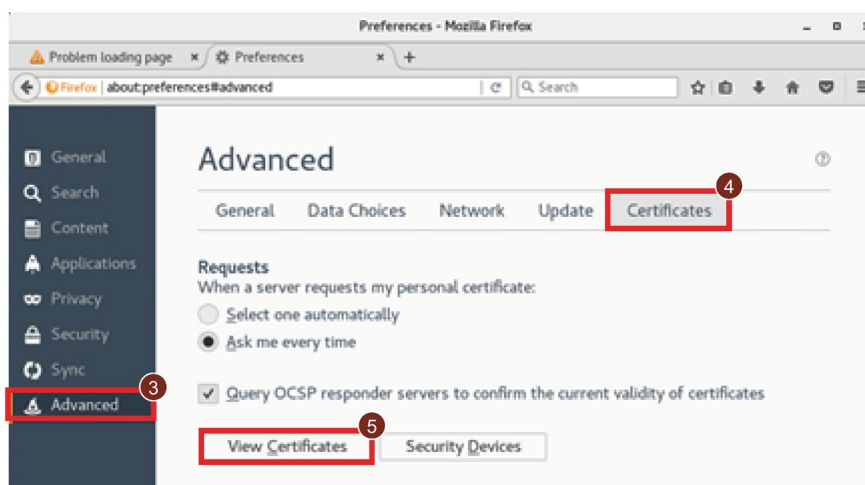

## 11.4 Installing LOGO! Root certificate

4. Click ⑥ and then click ⑦ to import "LOGOV84RootCAV10.cer".

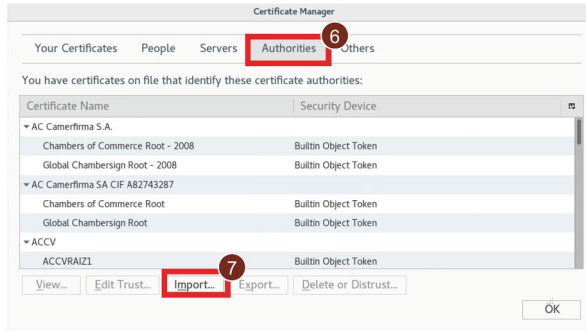

5. Select the certificate in ⑧ and click ⑨.

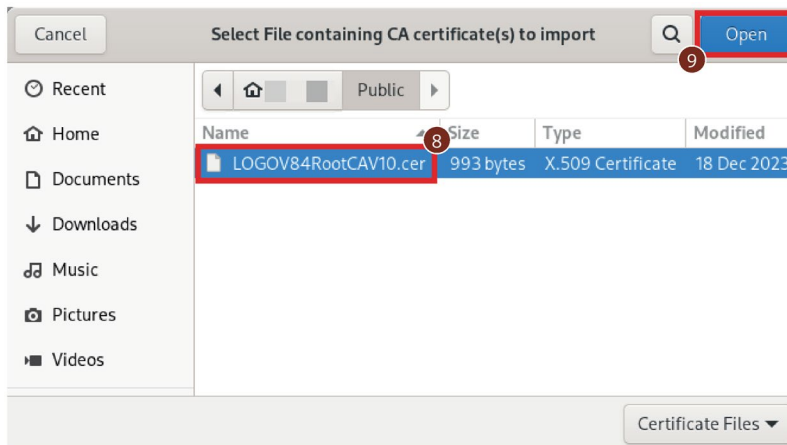

6. Select the checkbox next to ⑩ and then clicking ⑪.

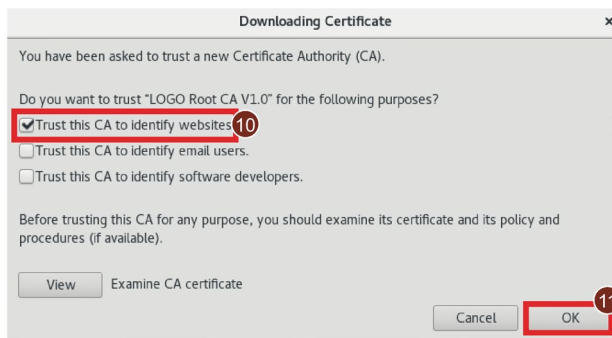



## Install the certificate for Google Chrome

1. Start Chrome.
2. Select ① → ② to open the settings.

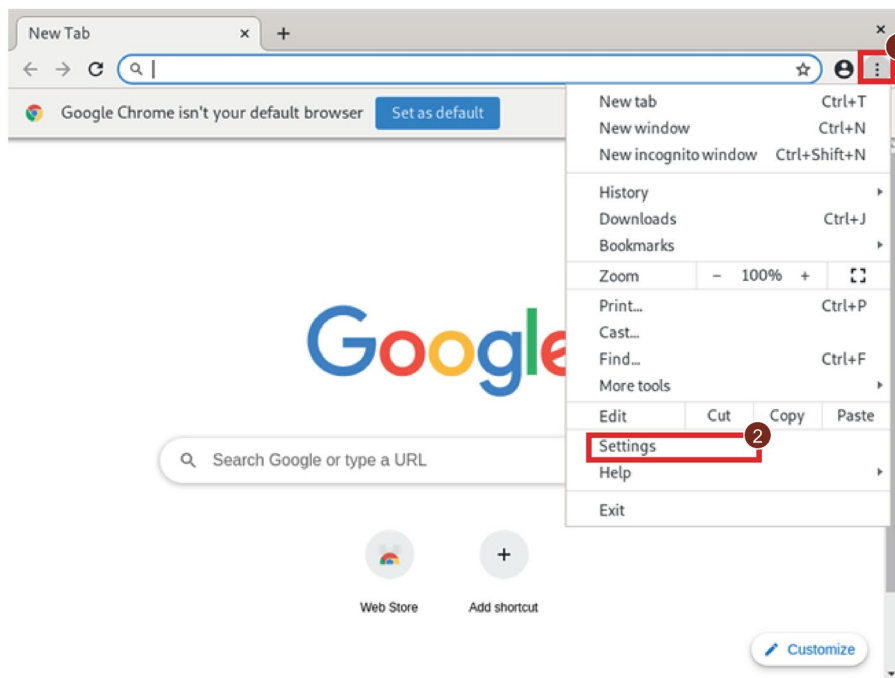

11.4 Installing LOGO! Root certificate

3. Select ③ → ④ → ⑤ to view the certificates.

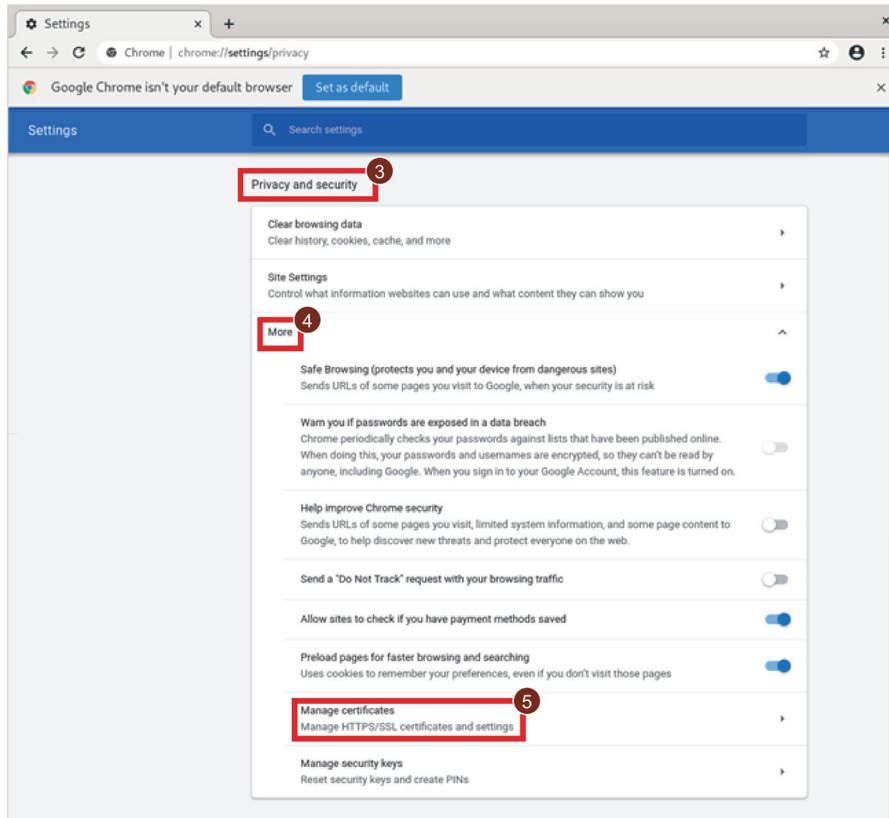

4. Click ⑥ and then click ⑦ to import "LOGOV84RootCAV10.cer".

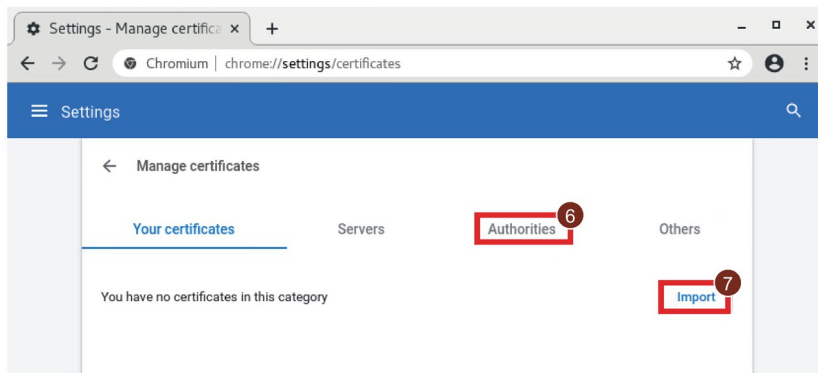

5. Select ⑧, select the certificate ⑨ and click ⑩.

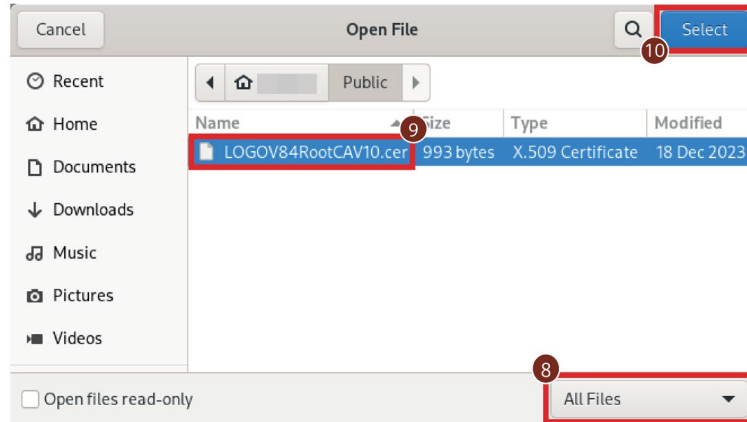

6. Select the checkbox next to ⑪ and then clicking ⑫.

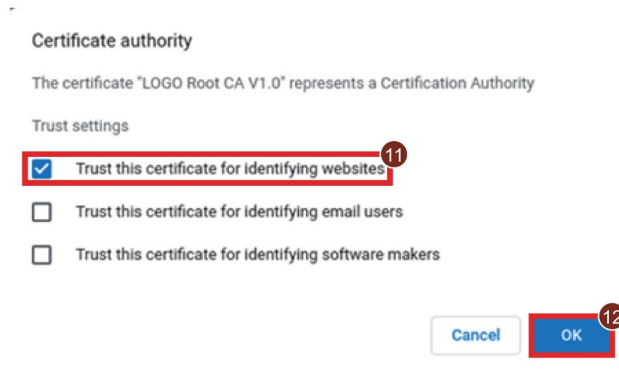

## Install the certificate for Opera

1. Start Opera.
2. Select ① to open the settings.

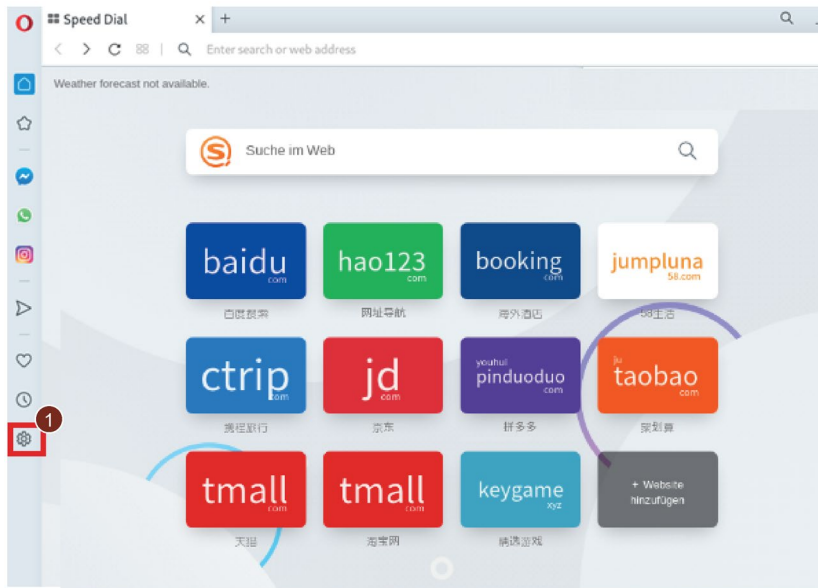

3. Select ② → ③ → ④ to view the certificates.

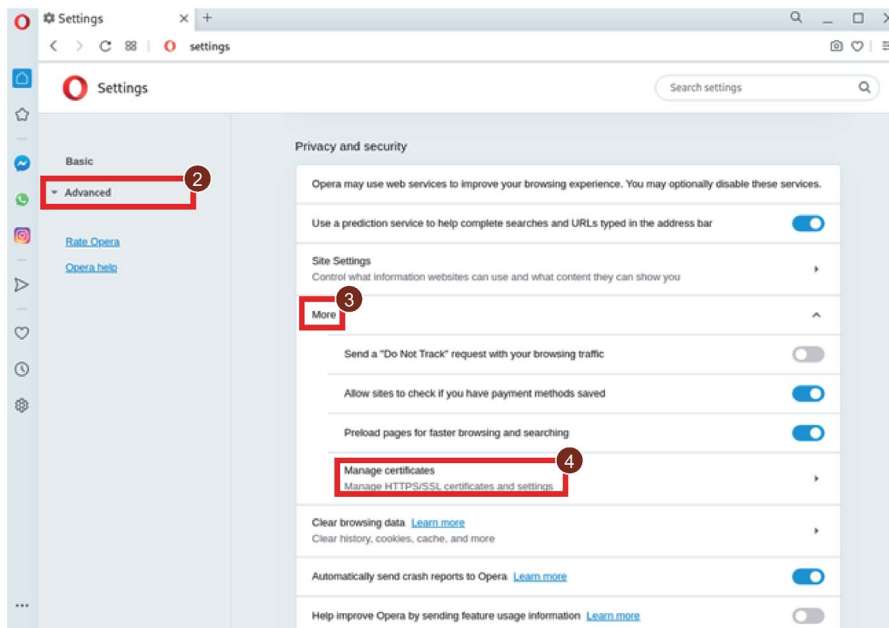

4. Click ⑤ and then click ⑥ to import "LOGOV84RootCAV10.cer".

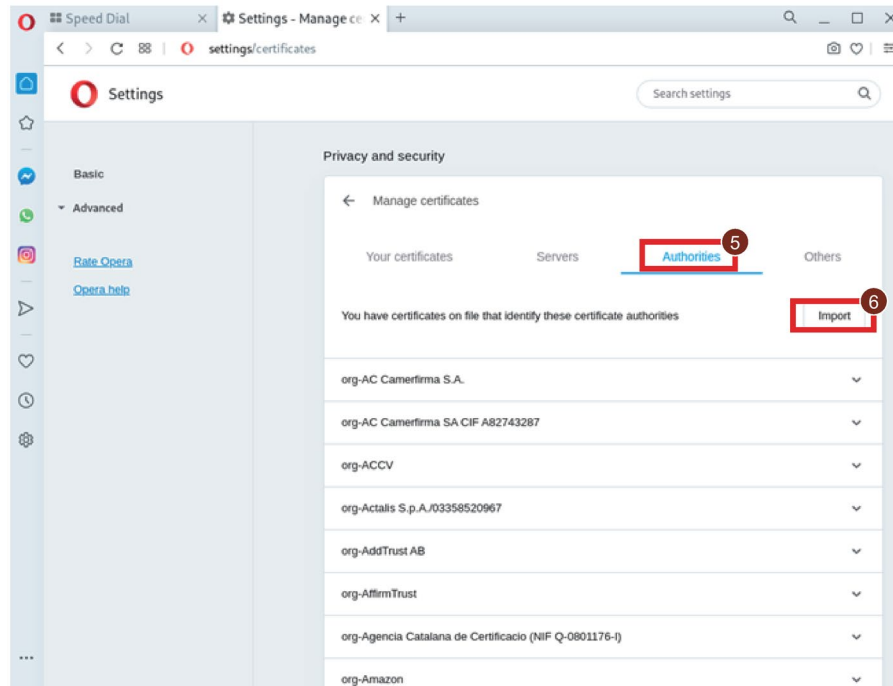

5. Select ⑦, select the certificate ⑧ and click ⑨.

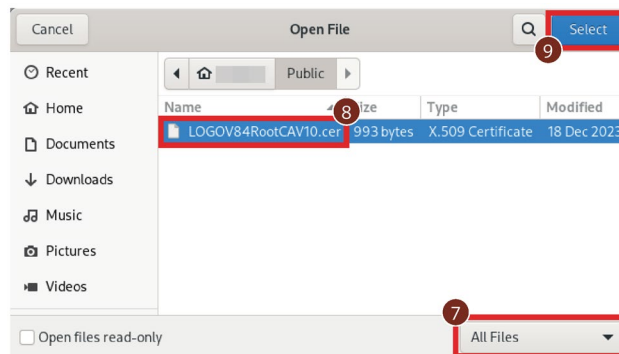

6. Select the checkbox next to ⑩ and then clicking ⑪.

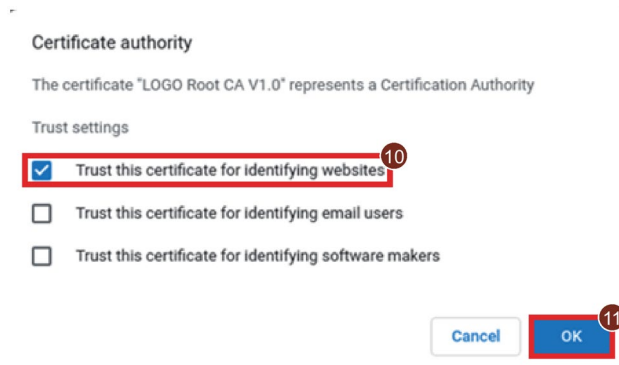

### 11.4.3 Installing the certificate for Mac OS and IOS

#### Install the certificate for MAC OS

1. Open the Keychain.
2. The add a certificate, select ① → ②.

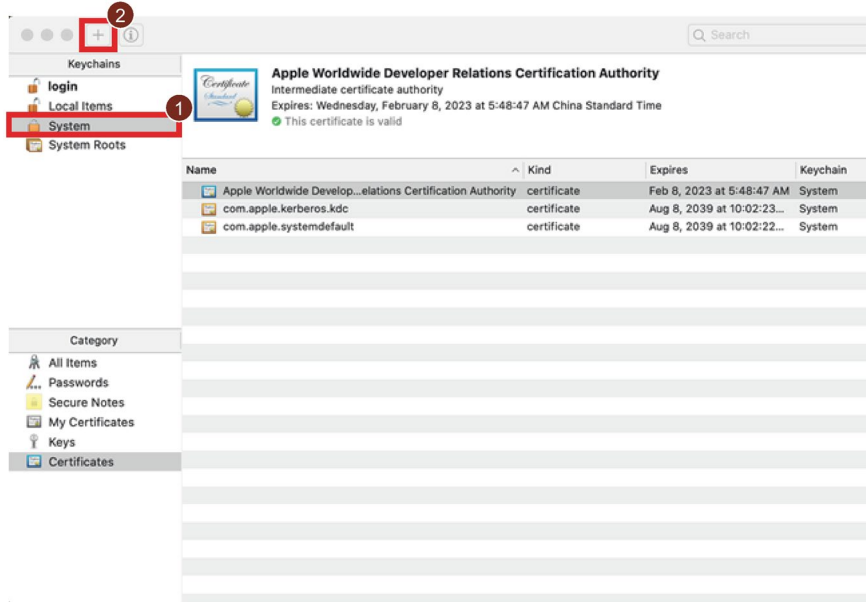

3. Select ③ and then click ④ to add "LOGOV84RootCAV10.cer".

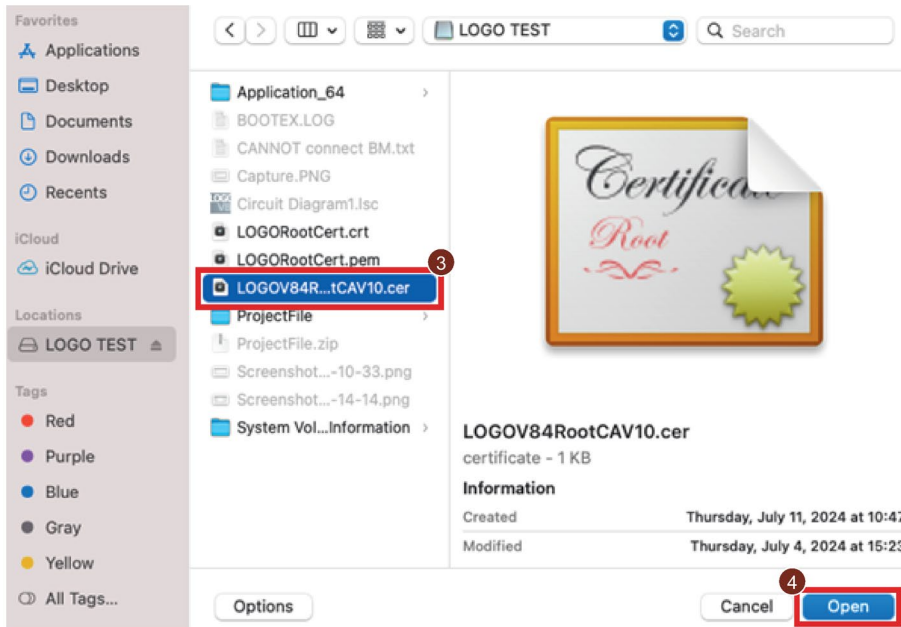

4. Enter the password, and then Click ⑤.

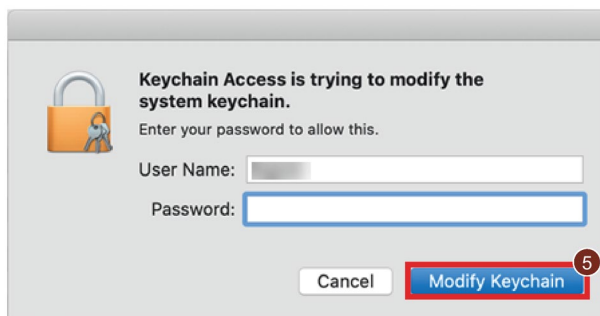

5. Double-click "LOGOV84RootCAV10.cer" to open it.
6. Trust the certificate by clicking ⑥ and setting ⑦ as "Always trust".

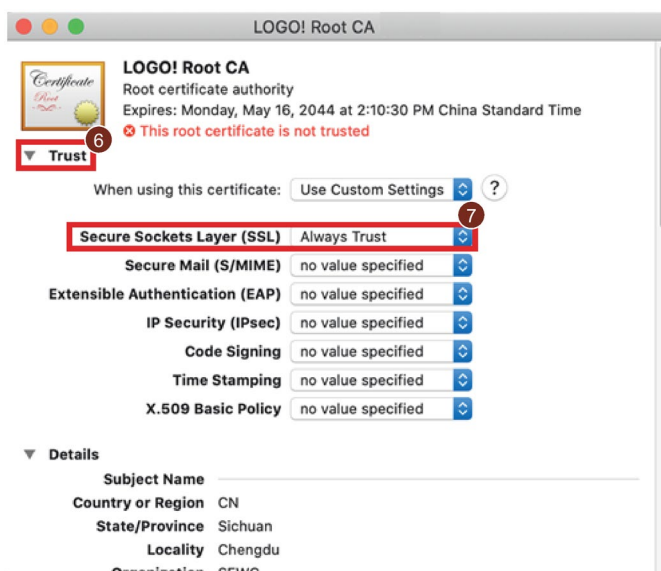

7. Enter the password, and confirm the modification.

## Install the certificate for IOS

1. Click "LOGOV84RootCAV10.cer".
2. Click "Install" button.

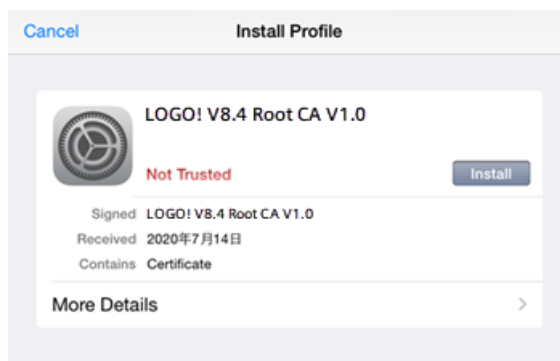

3. Click "Install" in the prompt warning window.
4. Enter the password.
5. System prompts that "LOGO! V8.4 Root CA V1.0" is installed.  
Click the "Done" button.

## 11.5 Secure decommissioning

In this section, you will find information on how to properly decommission individual components of your automation system. Decommissioning is necessary when the component has reached the end of its service life.

Decommissioning includes environmentally sound disposal and secure removal of all digital data of electronic components with storage medium.

### 11.5.1 Securely removing data

Before disposing of components of your automation system, you should securely delete all data from the storage media of these components. How to securely delete data from the devices so that it cannot be recovered is described below.

#### NOTICE

##### Data misuse resulting from non-secure deletion of data

Incomplete or non-secure deletion of data from data memories can result in data misuse by third parties.

For this reason, ensure secure deletion of data from all storage media used before disposing of the product.

To delete all data from the data memories of LOGO! device, reset the device to factory setting. The function deletes all information that was saved internally on the module. You can take the following three methods to reset your LOGO! device to factory setting.

#### Factory reset by LOGO! BM/TDE menu command

1. Switch the LOGO! to programming mode. LOGO! opens the main menu:
2. Press ▲ or ▼ to move the cursor to ①, then press **OK**. LOGO! open the programming menu.

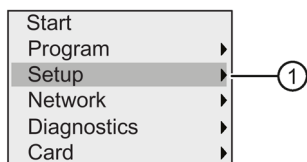



3. Move the cursor to ②, then press **OK**.

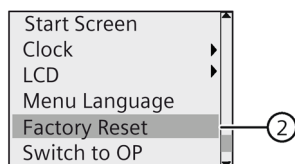

4. Move the cursor to ③, then press **OK** to confirm factory reset operation.

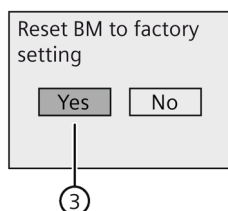

### Factory reset by LOGO!Soft Comfort

Use menu command in LOGO!Soft Comfort: Tools -> Transfer -> Factory Reset LOGO!. For detailed operation, refer to the section: *Tools -> Transfer -> Factory Reset LOGO! (LOGO! 8.F54 and later versions only)* in LOGO!Soft Comfort Online Help.

### Factory reset by reset file

1. Copy `_reset.bm` file in the DVD-ROM into the root directory of an SD card.
2. Insert the SD card into the LOGO! BM.
3. Power on the LOGO! BM to execute factory reset. After the BM is reset to factory setting, `_reset.bm` file in the SD card is deleted automatically.

---

#### Note

The `_reset.bm` file can only be used to reset factory setting for LOGO! BM 8.3 and later versions.

---

## 11.5.2 Recycling and disposal

You can fully recycle LOGO! devices due to their low-pollutant equipment. For environmentally friendly recycling and disposal of your old equipment, contact a certified electronic waste disposal company and dispose of the equipment according to the applicable regulations in your country.

## 12.1 LOGO! software

LOGO!Soft Comfort is available as a programming package for the PC. This software provides many features, for example:

- A graphical user interface for offline creation of your circuit program by means of Ladder Diagram (contact chart / circuit diagram) or Function Block Diagram (function chart)
- A graphical user interface for offline creation of your Network project
- Simulation of your circuit program on the PC
- Generating and printing of an overview chart for the circuit program
- Saving a backup of the circuit program on the hard drive or other media
- Comparing circuit programs
- Easy configuration of blocks
- Transferring the circuit program in both directions:
  - from LOGO! to the PC
  - from the PC to LOGO!
- Reading the values of the hour counter
- Setting the time of day
- Summertime/wintertime conversion
- Online testing that provides a display of status changes and process variables of LOGO! in RUN mode:
  - Status of digital I/O, flags, shift register bits and cursor keys
  - Values of all analog I/O and flags
  - Results of all blocks
  - Current values (including the times) of selected blocks
- Starting and stopping circuit program execution from the PC (switching between RUN and STOP modes)
- Network communication
- Creating UDF blocks (Page 280) for use in a circuit program
- Configuring the Data Log (Page 284) function block for your circuit program to record process values of the configured function blocks

The current version is LOGO!Soft Comfort V8.4. The Online Help for LOGO!Soft Comfort describes all of the programming functionality and design features.

## The LOGO! advantages

As you can see, LOGO!Soft Comfort offers many advantages:

- You can develop the circuit program on your PC.
- You simulate the circuit program on your computer and verify its functions before you actually implement it in your system.
- You can add comments to the circuit program and create hard copies.
- You can save a copy of your circuit program to the file system on your PC, to make it directly available for modifications.
- It takes only a few key actions to download the circuit program to LOGO!.

## Supported operating systems

You can execute LOGO!Soft Comfort on any of the following operating systems:

- Windows: Windows 7 (64 bit), Windows 8 (64 bit), Windows 10 (32/64 bit) or Windows 11
- Linux: SUSE Linux 15 (64 bit).
- Mac OS: Mac OS 10.14 Mojave; Mac OS 10.15 Catalina; Mac OS 11 Big Sur; Mac OS 12.1 Monterey.
- Recommended Java Runtime Environment version: Amazon Corretto 11.0.13.8.1

## Installing/Starting LOGO!Soft Comfort

To install LOGO!Soft Comfort, follow these steps:

1. Insert the DVD in the DVD-ROM driver.
2. View the DVD-ROM contents using your file-management program.
3. In the main directory of the DVD-ROM, open the folder with the name of the desired operating system (Windows, Linux, or MAC)
4. Proceed in either of the following ways:
  - Select the **Setup** or **Start** file to install the program.  
In this way, you can select whether to install LOGO! Web Editor after LOGO!Soft comfort is installed. Click **Yes** to install the LOGO! Web Editor or Click **No** to quit.
  - Select the folder **Application<-operating system version>("<\_operating system version>"** is available only for Linux and Windows) and copy it to your hard disk. Double-click LOGO!Comfort.exe in the folder to start the program.

You can find order numbers in Section "Order numbers (Page 380)".

## Upgrading previous LOGO!Soft Comfort versions

You can upgrade the LOGO!Soft Comfort version from V8.0, V8.1, V8.1.1, V8.2 and V8.3 to V8.4. And you can download the upgrade packages manually from Siemens ([www.siemens.com](http://www.siemens.com)) .

You can find order numbers in Section "Order numbers (Page 380)".

To upgrade from an old version to a new version, follow these steps:

1. Start `setup.exe` of upgrade Web installer.
2. When the system prompts you for the previous version:
  - If you have an old version installed on your PC, point your browser to the "...\\Application" directory of your LOGO!Soft comfort installation folder.
  - If you haven't an old version on your PC, place the old LOGO!Soft Comfort DVD in the DVD drive and point your browser to the "...\\Application" directory on the DVD.

## Updates and information

You can download demo versions of the software free of charge from the Internet address specified in the preface (Page 3).

For detailed information on updates, upgrades and the LOGO!Soft Comfort Update Center, refer to the Online Help for LOGO!Soft Comfort.

## 12.2 Connecting LOGO! to a PC

### Connecting LOGO! to a PC

You can connect a LOGO! 8 Base Module to a PC with an Ethernet cable.

### Switching LOGO! to PC ↔ LOGO! mode

Two methods are available to switch LOGO! to STOP mode:

- Switch LOGO! to STOP mode from your PC (refer to the Online Help for LOGO!Soft Comfort).
- Select the following menu command on a device with display.

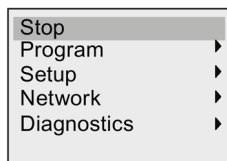

Confirm your selection with "①":

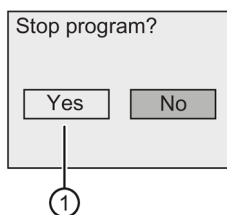

When LOGO! is in STOP mode and online with the PC, the following PC commands are available:

- Switch LOGO! to RUN
- Read/write the circuit program
- Read/write the summertime/wintertime

---

**Note**

For more information on LOGO! versions without display, refer to the Appendix topic "LOGO! without display ("LOGO! Pure") (Page 365)".

---

### Closing the PC ↔ LOGO! mode

When LOGO! completes the data transfer, it shuts down the connection to the PC.

---

**Note**

If you have password-protected the program that you created in LOGO!Soft Comfort, LOGO! receives both the circuit program and the password during the download.

The upload of a password-protected program created in LOGO! is possible only after you enter the correct password in LOGO!Soft Comfort.

---

---

## Note

LOGO! sample applications are available to all our customers free of charge on the Siemens LOGO! website (<http://www.siemens.com/logo>) (go to Products & Solutions → Applications → Application Examples).

Siemens does not guarantee that the provided examples are error-free; they serve as general information about the fields of application for LOGO!, and can be different from user-specific solutions. Siemens reserves the right to make changes.

You are responsible for the operation of your system.. For safety concerns, refer to the relevant national standards and system-related installation regulations.

---

On the Internet you can find the following sample applications, tips for further applications, and more:

- Irrigation system for greenhouse plants
- Conveyor control system
- Bending machine control system
- Shop window lighting
- Bell system (for example, in a school)
- Parking lot surveillance
- Outdoor lighting
- Shutter control system
- Domestic outdoor and indoor lighting system
- Control system of a cream stirrer
- Sports hall lighting
- Constant load on three consumers
- Sequential control system for cable-welding machines for large cross-sections
- Step switch (for example, for fans)
- Sequential control for boilers
- Control system for several pump sets with centralized operator control
- Cutting device (for example, for detonating fuses)
- Monitoring periods of utilization, for example of a solar energy system
- Intelligent foot switches, for example, for speed preselection)
- Elevating platform controls
- Impregnation of textiles, heating and conveyor belt controls

- Silo-filling system
- Fill station with message text on the LOGO! TDE that displays the sum of counted objects

On the Web you can also find descriptions and the corresponding circuit diagrams of the applications. You can read these \*.pdf files with the Adobe Acrobat Reader. If you have installed LOGO!Soft Comfort on your computer, you can simply click the disk icon to download the relevant circuit programs, which you can then adapt to suit your application and download to LOGO! directly via the PC cable.

## Benefits of LOGO!

LOGO! is a particularly useful feature:

- For replacing auxiliary switchgear with the integrated LOGO! functions
- For saving wiring and installation work - because LOGO! keeps the wiring "in its head."
- For reducing space requirements for components in the control cabinet/distribution box. A smaller control cabinet/distribution box may provide sufficient space.
- For adding or changing functions, without having to install additional switchgear or change the wiring.
- For offering your customers new, additional functions for domestic and commercial housing installations. Examples:
  - Domestic security systems: LOGO! switches on a lamp at regular intervals or opens and closes the shutters while you are on holiday.
  - Central heating: LOGO! runs the circulation pump only when water or heating is actually required.
  - Refrigerating systems: LOGO! can defrost refrigerating systems at regular intervals to save energy costs.
  - You can illuminate aquaria and terraria on a time-dependent basis.

Last but not least, you can:

- Use commonly available switches and pushbuttons, which makes it easy to install a domestic system.
- Connect LOGO! directly to your domestic installation; the integrated power supply makes it possible.

## Do you want more information?

For more information about LOGO!, see the Siemens Web page (As mentioned in the first paragraph of the Note in this chapter).

### Do you have any suggestions?

There are definitely many more useful applications for LOGO!. If you know of one, please write to the following address or send it to the online Support Request (<http://www.siemens.com/automation/support-request>). Siemens will collect all the suggestions made and distribute as many of them as possible. Your suggestions are valuable to Siemens.

Write to:

Siemens AG

Division Digital Factory

Postfach 48 48

90026 NÜRNBERG

GERMANY



# Technical data

## A.1 General technical data

Criterion	Tested in accordance with	Values
<b>LOGO! Base Modules (0BA8)</b> <b>LOGO! Basic</b> Dimensions (WxHxD) Weight <ul style="list-style-type: none"> <li>• Modules with relay output</li> <li>• Modules with transistor output</li> </ul> Installation		71.5 x 90 x 60 mm  Approx. 240 g Approx. 195 g On a 35 mm profile rail four module widths or wall mounting
<b>LOGO! Pure</b> Dimensions (WxHxD) Weight <ul style="list-style-type: none"> <li>• Modules with relay output</li> <li>• Modules with transistor output</li> </ul> Installation		71.5 x 90 x 58 mm  Approx. 200 g Approx. 160 g On a 35 mm profile rail four module widths or wall mounting
<b>LOGO! expansion modules DM16...</b> Dimensions (WxHxD) Weight <ul style="list-style-type: none"> <li>• Modules with relay output</li> <li>• Modules with transistor output</li> </ul> Installation		71.5 x 90 x 58 mm  Approx. 225 g Approx. 165 g On a 35 mm profile rail four module widths or wall mounting
<b>LOGO! expansion modules DM8...</b> Dimensions (WxHxD) Weight <ul style="list-style-type: none"> <li>• Modules with relay output</li> <li>• Modules with transistor output</li> </ul> Installation		35.5 x 90 x 58 mm  Approx. 130 g Approx. 95 g On a 35 mm profile rail two module widths or wall mounting
<b>LOGO! expansion modules AM...</b> Dimensions (WxHxD) Weight Installation		35.5 x 90 x 58 mm Approx. 95 g On a 35 mm profile rail two module widths or wall mounting
<b>LOGO! TDE (Text Display with Ethernet interfaces)</b> Dimensions (WxHxD) Weight Installation		128.2 x 86 x 38.7 mm Approx. 220 g Bracket mounting

A.1 General technical data

Criterion	Tested in accordance with	Values
<b>Climatic conditions</b>		
Ambient temperature for BM and EM <ul style="list-style-type: none"> <li>Horizontal installation</li> <li>Vertical installation</li> </ul>	Low temperature to IEC 60068-2-1 High temperature to IEC 60068-2-2	<ul style="list-style-type: none"> <li>-20 °C to +55 °C <sup>1)</sup></li> <li>-20 °C to +55 °C</li> </ul>
Ambient temperature for TDE <ul style="list-style-type: none"> <li>Horizontal installation</li> <li>Vertical installation</li> </ul>	Low temperature to IEC 60068-2-1 High temperature to IEC 60068-2-2	<ul style="list-style-type: none"> <li>-20 °C to +55 °C <sup>1)</sup></li> <li>-20 °C to +55 °C</li> </ul>
Storage and Transport		- 40 °C to +70 °C
Relative humidity	IEC 60068-2-30	From 10% to 95% no condensation
Atmospheric pressure, Altitude <ul style="list-style-type: none"> <li>Operation</li> <li>Storage/transport</li> </ul>		<ul style="list-style-type: none"> <li>1080 to 795 hPa, corresponds to an elevation of -1000 m to 2000 m</li> <li>1080 to 660 hPa, corresponds to an elevation of -1000 m to 3500 m</li> </ul>
Altitude during operation		Up to 2000 m
Pollutants	IEC 60068-2-42 IEC 60068-2-43	SO <sub>2</sub> 10 cm <sup>3</sup> /m <sup>3</sup> , 21 days H <sub>2</sub> S 1 cm <sup>3</sup> /m <sup>3</sup> , 21 days
Pollution degree		2
<b>Ambient mechanical conditions</b>		
Degree of protection		<ul style="list-style-type: none"> <li>IP20 for LOGO! Base Modules, expansion modules, and the LOGO! TDE excluding the TDE front panel</li> <li>IP65 for LOGO! TDE front panel</li> </ul>
Enclosure type		<ul style="list-style-type: none"> <li>Type 1 for the front panel of LOGO! Base Modules and expansion modules</li> <li>Type 4X/12 for LOGO! TDE front panel</li> </ul>
Vibrations:	IEC 60068-2-6	5 Hz to 8.4 Hz (constant amplitude 3.5 mm) 8.4 Hz to 200 Hz (constant acceleration 1 g)
Shock	IEC 60068-2-27	half-sine wave 15 g/11 ms
Free fall (packaged)	IEC 60068-2-32	0.3 m
<b>Electromagnetic compatibility (EMC)</b>		
Radiated emission	EN 61000-6-3 EN 61000-6-4	Limit class B group 1 Limit class B
Electrostatic discharge	IEC 61000-4-2	±2 kV, ±4kV, ±8 kV air discharge ±6 kV contact discharge
Radiated electromagnetic field	IEC 61000-4-3	80 MHz-1000 MHz and 1.4 GHz-2.0 GHz 10V/m, 80% AM(1 kHz) 2.0 GHz-6.0 GHz 3V/m, 80% AM(1 kHz)

Criterion	Tested in accordance with	Values
Conducted disturbance	IEC 61000-4-6	150 KHz-80 MHz 10 V, 80%AM(1 kHz)
Fast transient bursts	IEC 61000-4-4	<ul style="list-style-type: none"> <li>For power port: 2 kV</li> <li>For signal port:                             <ul style="list-style-type: none"> <li>Signal Lines&lt;30 m: 1 kV/5 kHz and 100 kHz</li> <li>Signal Lines&gt;30 m: 2 kV/5 kHz and 100 kHz</li> </ul> </li> </ul>
Surge immunity (applies only to LOGO! 230 and DM8/16 230R)	IEC 61000-4-5	1 kV line-to-line 2 kV line-to-earth
Surge immunity (applies to low-voltage (12 V or 24 V) LOGO! modules)		With surge arrester (such as BVT AD 24): <ul style="list-style-type: none"> <li>1 kV line-to-line</li> <li>2 kV line-to-earth</li> </ul> Without surge arrester: <ul style="list-style-type: none"> <li>0.5 kV line-to-line</li> <li>1 kV line-to-earth</li> </ul>
<b>Safety to IEC</b>		
Clearance and creepage distance rating	IEC 60664, IEC 61131-2, cULus to UL 508, CSA C22.2 No. 142, IEC 60730	Fulfilled
Insulation strength	IEC 61131-2	Fulfilled
<b>Cycle time</b>		
Cycle time per function		< 0.1 ms
<b>Startup</b>		
Startup time at power-up		Typ. 1.6 s
<b>Overvoltage</b>		
Overvoltage category		<ul style="list-style-type: none"> <li>Category II: LOGO! 24CE, LOGO! DM8 24, LOGO! DM16 24, LOGO! AM2, LOGO! AM2 RTD, LOGO! AM2 AQ, LOGO! TDE</li> <li>Category III: LOGO! 12/24RCE, LOGO! 24RCE (AC/DC), LOGO! 230RCE (AC/DC), LOGO! DM8 12/24R, LOGO! DM8 24R, LOGO! DM8 230R, LOGO! DM16 24R, LOGO! DM16 230R</li> </ul>

<sup>1)</sup> The updating rate of LCD can be reduced at operating temperature less than 0°C.

**Note**

The maximum length for directly connecting two LOGO! Base Modules through CAT5e shielded network cable is 100 meters.

## A.2 Technical data: LOGO! 230...

	LOGO! 230RCEo	LOGO! 230RCE
<b>Power supply</b>		
Input voltage	115 VAC/VDC to 240 VAC/VDC	115 VAC/VDC to 240 VAC/VDC
Permissible range	85 VAC to 265 VAC 100 VDC to 253 VDC	85 VAC to 265 VAC 100 VDC to 253 VDC
Input frequency	50/60 Hz	50/60 Hz
Permissible mains frequency	47 Hz to 63 Hz	47 Hz to 63 Hz
Power consumption		
<ul style="list-style-type: none"> <li>• 115 VAC</li> <li>• 240 VAC</li> <li>• 115 VDC</li> <li>• 240 VDC</li> </ul>	<ul style="list-style-type: none"> <li>• 20 mA to 40 mA</li> <li>• 15 mA to 25 mA</li> <li>• 10 mA to 20 mA</li> <li>• 5 mA to 15 mA</li> </ul>	<ul style="list-style-type: none"> <li>• 20 mA to 40 mA</li> <li>• 15 mA to 25 mA</li> <li>• 10 mA to 20 mA</li> <li>• 5 mA to 15 mA</li> </ul>
Voltage failure buffering		
<ul style="list-style-type: none"> <li>• 115 VAC/VDC</li> <li>• 240 VAC/VDC</li> </ul>	<ul style="list-style-type: none"> <li>• Typ. 10 ms</li> <li>• Typ. 20 ms</li> </ul>	<ul style="list-style-type: none"> <li>• Typ. 10 ms</li> <li>• Typ. 20 ms</li> </ul>
Power loss at		
<ul style="list-style-type: none"> <li>• 115 VAC</li> <li>• 240 VAC</li> <li>• 115 VDC</li> <li>• 240 VDC</li> </ul>	<ul style="list-style-type: none"> <li>• 2.3 W to 4.6 W</li> <li>• 3.6 W to 6.0 W</li> <li>• 1.2 W to 2.3 W</li> <li>• 1.2 W to 3.6 W</li> </ul>	<ul style="list-style-type: none"> <li>• 2.3 W to 4.6 W</li> <li>• 3.6 W to 6.0 W</li> <li>• 1.2 W to 2.3 W</li> <li>• 1.2 W to 3.6 W</li> </ul>
Backup of the real-time clock at 25 °C	Typ. 20 days	Typ. 20 days
Accuracy of the real-time clock	Typ. ± 2 s/day	Typ. ± 2 s/day
<b>Digital inputs</b>		
Number	8	8
Electrical isolation	No	No
Number of high speed inputs	0	0
Input frequency		
<ul style="list-style-type: none"> <li>• Normal input</li> <li>• High speed input</li> </ul>	<ul style="list-style-type: none"> <li>• Max. 4 Hz</li> <li>• --</li> </ul>	<ul style="list-style-type: none"> <li>• Max. 4 Hz</li> <li>• --</li> </ul>
Digital input	115 to 240 VAC/DC, 50/60 Hz	115 to 240 VAC/DC, 50/60 Hz
Max. continuous permissible voltage	265 VAC 253 VDC	265 VAC 253 VDC
Input voltage L1		
<ul style="list-style-type: none"> <li>• Signal 0</li> <li>• Signal 1</li> <li>• Signal 0</li> <li>• Signal 1</li> </ul>	<ul style="list-style-type: none"> <li>• &lt; 40 VAC</li> <li>• &gt; 79 VAC</li> <li>• &lt; 30 VDC</li> <li>• &gt; 79 VDC</li> </ul>	<ul style="list-style-type: none"> <li>• &lt; 40 VAC</li> <li>• &gt; 79 VAC</li> <li>• &lt; 30 VDC</li> <li>• &gt; 79 VDC</li> </ul>

	LOGO! 230RCEo	LOGO! 230RCE
Input current at		
<ul style="list-style-type: none"> <li>• Signal 0</li> <li>• Signal 1</li> <li>• Signal 0</li> <li>• Signal 1</li> </ul>	<ul style="list-style-type: none"> <li>• &lt; 0.05 mA AC</li> <li>• &gt; 0.08 mA AC</li> <li>• &lt; 0.06 mA DC</li> <li>• &gt; 0.13 mA DC</li> </ul>	<ul style="list-style-type: none"> <li>• &lt; 0.05 mA AC</li> <li>• &gt; 0.08 mA AC</li> <li>• &lt; 0.06 mA DC</li> <li>• &gt; 0.13 mA DC</li> </ul>
Delay time at 0 to 1:		
<ul style="list-style-type: none"> <li>• 120 VAC</li> <li>• 240 VAC</li> <li>• 120 VDC</li> <li>• 240 VDC</li> </ul>	<ul style="list-style-type: none"> <li>• Typ. 40 ms</li> <li>• Typ. 30 ms</li> <li>• Typ. 25 ms</li> <li>• Typ. 20 ms</li> </ul>	<ul style="list-style-type: none"> <li>• Typ. 40 ms</li> <li>• Typ. 30 ms</li> <li>• Typ. 25 ms</li> <li>• Typ. 20 ms</li> </ul>
Delay time at 1 to 0:		
<ul style="list-style-type: none"> <li>• 120 VAC</li> <li>• 240 VAC</li> <li>• 120 VDC</li> <li>• 240 VDC</li> </ul>	<ul style="list-style-type: none"> <li>• Typ. 45 ms</li> <li>• Typ. 70 ms</li> <li>• Typ. 60 ms</li> <li>• Typ. 75 ms</li> </ul>	<ul style="list-style-type: none"> <li>• Typ. 45 ms</li> <li>• Typ. 70 ms</li> <li>• Typ. 60 ms</li> <li>• Typ. 75 ms</li> </ul>
Line length (unshielded)	max. 100 m	max. 100 m
<b>Digital outputs</b>		
Number	4	4
Output type	Relay outputs	Relay outputs
Electrical isolation	Yes	Yes
In groups of	1	1
Control of a digital input	Yes	Yes
Continuous current I <sub>th</sub>	Recommended range of application ≥ 100 mA at 12 VAC/VDC Max. 10 A per relay	Recommended range of application ≥ 100 mA at 12 VAC/VDC Max. 10 A per relay
Relay rated voltage	240 VAC/VDC	240 VAC/VDC
Surge current Incandescent lamp load (25000 switching cycles) at	Max. 30 A	Max. 30 A
<ul style="list-style-type: none"> <li>• 230/240 VAC</li> <li>• 115/120 VAC</li> </ul>	<ul style="list-style-type: none"> <li>• 1000 W</li> <li>• 500 W</li> </ul>	<ul style="list-style-type: none"> <li>• 1000 W</li> <li>• 500 W</li> </ul>
Fluorescent tubes with ballast (25000 switching cycles)	10 x 58 W (at 230/240 VAC)	10 x 58 W (at 230/240 VAC)
Fluorescent tubes, conventionally compensated (25000 switching cycles)	1 x 58 W (at 230/240 VAC)	1 x 58 W (at 230/240 VAC)
Fluorescent tubes, uncompensated (25000 switching cycles)	10 x 58 W (at 230/240 VAC)	10 x 58 W (at 230/240 VAC)
Short circuit-proof cos 1	Power protection B16, 600 A	Power protection B16, 600 A
Short circuit-proof cos 0.5 to 0.7	Power protection B16, 900 A	Power protection B16, 900 A
Derating	None; across the entire temperature range	None; across the entire temperature range
Parallel output circuits for power increase	Not permitted	Not permitted

A.3 Technical data: LOGO! DM8 230R and LOGO! DM16 230R

	LOGO! 230RCEo	LOGO! 230RCE
Protection of output relay (if desired)	Max. 16 A, characteristic B16	Max. 16 A, characteristic B16
Line length (unshielded)	Max. 100 m	Max. 100 m
<b>Switching rate</b>		
Mechanical	10 Hz	10 Hz
Ohmic load/lamp load	2 Hz	2 Hz
Inductive load	0.5 Hz	0.5 Hz

Notice: For fluorescent lamps with capacitors, you must consider the technical data of fluorescent lamp ballasts. If the current exceeds the maximum allowed surge current, appropriate contactor relays must switch the fluorescent lamps.

Notice: Output: B300, R300; 8A, 24 VDC, G.P.; 10A, 240 VAC, G.P.; 3A, 120 VAC, Tungsten.

The data was determined with the following devices:

- Siemens fluorescent tubes 58 W VVG 5LZ 583 3-1 uncompensated.
- Siemens fluorescent tubes 58 W VVG 5LZ 583 3-1 parallel compensated with 7 µF.
- Siemens fluorescent tubes 58 W VVG 5LZ 501 1-1N with ballast.

### A.3 Technical data: LOGO! DM8 230R and LOGO! DM16 230R

	LOGO! DM8 230R	LOGO! DM16 230R
<b>Power supply</b>		
Input voltage	115 VAC/VDC to 240 VAC/VDC	115 VAC/VDC to 240 VAC/VDC
Permissible range	85 VAC to 265 VAC 100 VDC to 253 VDC	85 VAC to 265 VAC 100 VDC to 253 VDC
Input frequency	50/60 Hz	50/60 Hz
Permissible mains frequency	47Hz to 63 Hz	47Hz to 63 Hz
Power consumption	<ul style="list-style-type: none"> <li>• 115 VAC</li> <li>• 240 VAC</li> <li>• 115 VDC</li> <li>• 240 VDC</li> </ul>	<ul style="list-style-type: none"> <li>• 20 mA to 40 mA</li> <li>• 15 mA to 30 mA</li> <li>• 10 mA to 25 mA</li> <li>• 5 mA to 15 mA</li> </ul>
Voltage failure buffering	<ul style="list-style-type: none"> <li>• Typ. 10 ms</li> <li>• Typ. 20 ms</li> </ul>	<ul style="list-style-type: none"> <li>• Typ. 10 ms</li> <li>• Typ. 20 ms</li> </ul>
Power loss at	<ul style="list-style-type: none"> <li>• 115 VAC</li> <li>• 240 VAC</li> <li>• 115 VDC</li> <li>• 240 VDC</li> </ul>	<ul style="list-style-type: none"> <li>• 2.3 W to 4.6 W</li> <li>• 3.6 W to 7.2 W</li> <li>• 1.2 W to 2.9 W</li> <li>• 1.2 W to 3.6 W</li> </ul>

A.3 Technical data: LOGO! DM8 230R and LOGO! DM16 230R

	LOGO! DM8 230R	LOGO! DM16 230R
<b>Digital inputs</b>		
Number	4	8
Electrical isolation	No	No
Number of high speed inputs	0	0
Input frequency		
<ul style="list-style-type: none"> <li>• Normal input</li> <li>• High speed input</li> </ul>	<ul style="list-style-type: none"> <li>• Max. 4 Hz</li> <li>• --</li> </ul>	<ul style="list-style-type: none"> <li>• Max. 4 Hz</li> <li>• --</li> </ul>
Digital input	115 to 240 VAC/DC, 50/60 Hz	115 to 240 VAC/DC, 50/60 Hz
Max. continuous permissible voltage	265 VAC 253 VDC	265 VAC 253 VDC
Input voltage L1		
<ul style="list-style-type: none"> <li>• Signal 0</li> <li>• Signal 1</li> <li>• Signal 0</li> <li>• Signal 1</li> </ul>	<ul style="list-style-type: none"> <li>• &lt; 40 VAC</li> <li>• &gt; 79 VAC</li> <li>• &lt; 30 VDC</li> <li>• &gt; 79 VDC</li> </ul>	<ul style="list-style-type: none"> <li>• &lt; 40 VAC</li> <li>• &gt; 79 VAC</li> <li>• &lt; 30 VDC</li> <li>• &gt; 79 VDC</li> </ul>
Input current at		
<ul style="list-style-type: none"> <li>• Signal 0</li> <li>• Signal 1</li> <li>• Signal 0</li> <li>• Signal 1</li> </ul>	<ul style="list-style-type: none"> <li>• &lt; 0.05 mA AC</li> <li>• &gt; 0.08 mA AC</li> <li>• &lt; 0.06 mA DC</li> <li>• &gt; 0.13 mA DC</li> </ul>	<ul style="list-style-type: none"> <li>• &lt; 0.05 mA AC</li> <li>• &gt; 0.08 mA AC</li> <li>• &lt; 0.06 mA DC</li> <li>• &gt; 0.13 mA DC</li> </ul>
Delay time at 0 to 1:		
<ul style="list-style-type: none"> <li>• 120 VAC</li> <li>• 240 VAC</li> <li>• 120 VDC</li> <li>• 240 VDC</li> </ul>	<ul style="list-style-type: none"> <li>• Typ. 40 ms</li> <li>• Typ. 30 ms</li> <li>• Typ. 25 ms</li> <li>• Typ. 20 ms</li> </ul>	<ul style="list-style-type: none"> <li>• Typ. 40 ms</li> <li>• Typ. 30 ms</li> <li>• Typ. 25 ms</li> <li>• Typ. 20 ms</li> </ul>
Delay time at 1 to 0:		
<ul style="list-style-type: none"> <li>• 120 VAC</li> <li>• 240 VAC</li> <li>• 120 VDC</li> <li>• 240 VDC</li> </ul>	<ul style="list-style-type: none"> <li>• Typ. 45 ms</li> <li>• Typ. 70 ms</li> <li>• Typ. 60 ms</li> <li>• Typ. 75 ms</li> </ul>	<ul style="list-style-type: none"> <li>• Typ. 45 ms</li> <li>• Typ. 70 ms</li> <li>• Typ. 60 ms</li> <li>• Typ. 75 ms</li> </ul>
Line length (unshielded)	Max. 100 m	Max. 100 m
<b>Digital outputs</b>		
Number	4	8
Output type	Relay outputs	Relay outputs
Electrical isolation	Yes	Yes
In groups of	1	1
Control of a digital input	Yes	Yes
Continuous current I <sub>th</sub>	Recommended range of application ≥ 100 mA at 12 VAC/VDC Max. 5 A per relay	Recommended range of application ≥ 100 mA at 12 VAC/VDC Max. 5 A per relay
Relay rated voltage	240 VAC/VDC	240 VAC/VDC
Surge current	Max. 30 A	Max. 30 A

	LOGO! DM8 230R	LOGO! DM16 230R
Incandescent lamp load (25000 switching cycles) at: 230/240 VAC 115/120 VAC	1000 W 500 W	1000 W 500 W
Fluorescent tubes with ballast (25000 switching cycles)	10 x 58 W (at 230/240 VAC)	10 x 58 W (at 230/240 VAC)
Fluorescent tubes, conventionally compensated (25000 switching cycles)	1 x 58 W (at 230/240 VAC)	1 x 58 W (at 230/240 VAC)
Fluorescent tubes, uncompensated (25000 switching cycles)	10 x 58 W (at 230/240 VAC)	10 x 58 W (at 230/240 VAC)
Short circuit-proof cos 1	Power protection B16, 600 A	Power protection B16, 600 A
Short circuit-proof cos 0.5 to 0.7	Power protection B16, 900 A	Power protection B16, 900 A
Derating	None; across the entire temperature range	None; across the entire temperature range
Parallel output circuits for power increase	Not permitted	Not permitted
Protection of output relay (if desired)	Max. 16 A, characteristic B16	Max. 16 A, characteristic B16
Line length (unshielded)	Max. 100 m	Max. 100 m
<b>Switching rate</b>		
Mechanical	10 Hz	10 Hz
Ohmic load/lamp load	2 Hz	2 Hz
Inductive load	0.5 Hz	0.5 Hz

Notice: For fluorescent lamps with capacitors, you must consider the technical data of fluorescent lamp ballasts. If the current exceeds the maximum allowed surge current, appropriate contactor relays must switch the fluorescent lamps.

Notice: Output: B300, R300; 5A, 24 VDC, G,P.; 5A, 240 VAC, G.P.; 3A, 120 VAC, Tungsten.

The data was determined with the following devices:

- Siemens fluorescent tubes 58 W VVG 5LZ 583 3-1 uncompensated.
- Siemens fluorescent tubes 58 W VVG 5LZ 583 3-1 parallel compensated with 7 µF.
- Siemens fluorescent tubes 58 W VVG 5LZ 501 1-1N with ballast.

## A.4 Technical data: LOGO! 24...

	LOGO! 24CE LOGO! 24CEo
<b>Power supply</b>	
Input voltage	24 VDC
Permissible range	20.4 VDC to 28.8 VDC
Reverse polarity protection	Yes
Permissible mains frequency	--



	<b>LOGO! 24CE</b> <b>LOGO! 24CEo</b>
Power consumption from 24 VDC	25 mA to 50 mA (no load on digital output) 1.2 A (with max. load on digital output)
Voltage failure buffering	--
Power loss at 24 VDC	0.6 W to 1.2 W
Backup of the real-time clock at 25 °C	Typ. 20 days
Accuracy of the real-time clock	Typ. $\pm 2$ s/day
<b>Digital inputs</b>	
Number	8
Electrical isolation	No
Number of high speed inputs	4 (I3, I4, I5, I6)
Input frequency	<ul style="list-style-type: none"> <li>• Normal input</li> <li>• High speed input</li> </ul>
	<ul style="list-style-type: none"> <li>• Max. 4 Hz</li> <li>• Max. 5 kHz</li> </ul>
Digital input	24 VDC
Max. continuous permissible voltage	28.8 VDC
Input voltage	L+
Signal 0	< 5 VDC
Signal 1	> 12 VDC
Input current at	
Signal 0	< 0.9 mA (I3 to I6) < 0.07 mA (I1, I2, I7, I8)
Signal 1	> 2.1 mA (I3 to I6) > 0.18 mA (I1, I2, I7, I8)
Delay time at	
0 to 1	<ul style="list-style-type: none"> <li>• Typ. 1.5 ms</li> <li>• &lt;1.0 ms (I3 to I6)</li> </ul>
1 to 0	<ul style="list-style-type: none"> <li>• Typ. 1.5 ms</li> <li>• &lt;1.0 ms (I3 to I6)</li> </ul>
Line length (unshielded)	Max. 100 m
<b>Analog inputs</b>	
Number	4 (I1=AI3, I2=AI4, I7=AI1, I8=AI2)
Range	0 VDC to 10 VDC Input impedance 80 k $\Omega$
Cycle time for analog value generation	300 ms
Line length (shielded and twisted)	Max. 10 m
Error limit	$\pm 1.5\%$ at FS
<b>Digital outputs</b>	
Number	4
Output type	Transistor, current-sourcing <sup>1)</sup>
Electrical isolation	No
In groups of	--
Control of a digital input	Yes
Output voltage	$\leq$ Supply voltage
Output current	Max. 0.3 A per channel

	LOGO! 24CE LOGO! 24CEo
Short circuit-proof and overload-proof	Yes
Short circuit current limitation	Approx. 1 A per channel
Derating	None; across the entire temperature range
Short circuit-proof cos 1	--
Short circuit-proof cos 0.5 to 0.7	--
Parallel output circuit for power increase	Not permitted
Protection of output relay (if desired)	--
Line length (unshielded)	Max. 100 m
<b>Switching rate <sup>2)</sup></b>	
Mechanical	--
Electrical	10 Hz
Ohmic load/lamp load	10 Hz
Inductive load	0.5 Hz

1) When you switch on LOGO! 24CE/24CEo, LOGO! DM8 24 or LOGO! DM16 24, the CPU sends signal 1 to the digital outputs for about 50 µs. Take this into account, especially when using devices that react to short pulses.

2) The maximum switching rate is only dependent on the switching program's cycle time.

Notice: Output: 24 VDC, 0.3 A, RES./P.D.

## A.5 Technical data: LOGO! DM8 24 and LOGO! DM16 24

	LOGO! DM8 24	LOGO! DM16 24
<b>Power supply</b>		
Input voltage	24 VDC	24 VDC
Permissible range	20.4 VDC to 28.8 VDC	20.4 VDC to 28.8 VDC
Reverse polarity protection	Yes	Yes
Permissible mains frequency	--	--
Power consumption from 24 VDC	25 mA to 40 mA (no load on digital output) 1.2 A (with max. load on digital output)	25 mA to 50 mA (no load on digital output) 2.4 A (with max. load on digital output)
Power loss at 24 V	0.6 W to 1.0 W	0.6 W to 1.2 W
<b>Digital inputs</b>		
Number	4	8
Electrical isolation	No	No
Number of high speed inputs	0	0
Input frequency		
• Normal input	• Max. 4 Hz	• Max. 4 Hz
• High speed input	• --	• --
Digital input	24 VDC	24 VDC
Max. continuous permissible voltage	28.8 VDC	28.8 VDC

	LOGO! DM8 24	LOGO! DM16 24
Input voltage	L+	L+
• Signal 0	• < 5 VDC	• < 5 VDC
• Signal 1	• > 12 VDC	• > 12 VDC
Input current at		
• Signal 0	• < 0.88 mA	• < 0.85 mA
• Signal 1	• > 2.1 mA	• > 2 mA
Delay time at		
• 0 to 1	• Typ. 1.5 ms	• Typ. 1.5 ms
• 1 to 0	• Typ. 1.5 ms	• Typ. 1.5 ms
Line length (unshielded)	Max. 100 m	Max. 100 m
<b>Digital outputs</b>		
Number	4	8
Output type	Transistor, current-sourcing <sup>1)</sup>	Transistor, current-sourcing <sup>1)</sup>
Electrical isolation	No	No
In groups of	--	--
Control of a digital input	Yes	Yes
Output voltage	≤ Supply voltage	≤ Supply voltage
Output current	Max. 0.3 A per channel	Max. 0.3 A per channel
Short circuit-proof and over-load-proof	Yes	Yes
Short circuit current limitation	Approx. 1 A per channel	Approx. 1 A per channel
Derating	None; across the entire temperature range	None; across the entire temperature range
Short circuit-proof cos 1	--	--
Short circuit-proof cos 0.5 to 0.7	--	--
Parallel output circuit for power increase	Not permitted	Not permitted
Protection of output relay (if desired)	--	--
Line length (unshielded)	Max. 100 m	Max. 100 m
<b>Switching rate</b>		
Mechanical	--	--
Electrical	10 Hz	10 Hz
Ohmic load/lamp load	10 Hz	10 Hz
Inductive load	0.5 Hz	0.5 Hz

<sup>1)</sup> When you switch on LOGO! 24CE/24CEo, LOGO! DM8 24 or LOGO! DM16 24, the CPU sends signal 1 to the digital outputs for about 50 µs. Take this into account, especially when using devices that react to short pulses.

Notice:

- Output of LOGO! DM8 24: 24 VDC, 0.3 A, RES./P.D.
- Output of LOGO! DM16 24: 24 VDC, 0.3 A, RES./P.D.; 3W, 24 VDC, Tungsten.

## A.6 Technical data: LOGO! 24RC...

	LOGO! 24RCE LOGO! 24RCEo	
<b>Power supply</b>		
Input voltage	24 VAC/VDC	
Permissible range	20.4 VAC to 26.4 VAC 20.4 VDC to 28.8 VDC	
Reverse polarity protection	--	
Input frequency	50/60 Hz	
Permissible mains frequency	47 Hz to 63 Hz	
Power consumption	<ul style="list-style-type: none"> <li>• 24 VAC</li> <li>• 24 VDC</li> </ul>	<ul style="list-style-type: none"> <li>• 60 mA to 185 mA</li> <li>• 25 mA to 100 mA</li> </ul>
Voltage failure buffering	Typ. 5 ms	
Power loss	<ul style="list-style-type: none"> <li>• 24 VAC</li> <li>• 24 VDC</li> </ul>	<ul style="list-style-type: none"> <li>• 1.4 W to 4.4 W</li> <li>• 0.6 W to 2.4 W</li> </ul>
Backup of the real-time clock at 25 °C	Typ. 20 days	
Accuracy of the real-time clock	Typ. $\pm 2$ s/day	
<b>Digital inputs</b>		
Number	8, optional positive voltage or negative voltage	
Electrical isolation	No	
Number of high speed inputs	0	
Input frequency	<ul style="list-style-type: none"> <li>• Normal input</li> <li>• High speed input</li> </ul>	<ul style="list-style-type: none"> <li>• Max. 4 Hz</li> <li>• --</li> </ul>
Digital input	24 VAC/DC, 50/60 Hz	
Max. continuous permissible voltage	26.4 VAC 28.8 VDC	
Input voltage	L	
<ul style="list-style-type: none"> <li>• Signal 0</li> <li>• Signal 1</li> </ul>	<ul style="list-style-type: none"> <li>• &lt; 5 VAC/VDC</li> <li>• &gt; 12 VAC/VDC</li> </ul>	
Input current at	<ul style="list-style-type: none"> <li>• Signal 0</li> <li>• Signal 1</li> </ul>	<ul style="list-style-type: none"> <li>• &lt; 1.2 mA</li> <li>• &gt; 2.6 mA</li> </ul>
Delay time at	<ul style="list-style-type: none"> <li>• 0 to 1</li> <li>• 1 to 0</li> </ul>	<ul style="list-style-type: none"> <li>• Typ. 1.5 ms</li> <li>• Typ. 15 ms</li> </ul>
Line length (unshielded)	Max. 100 m	
<b>Analog inputs</b>		
Number	--	
Range	--	
max. Input voltage	--	

	LOGO! 24RCE LOGO! 24RCEo
<b>Digital outputs</b>	
Number	4
Output type	Relay outputs
Electrical isolation	Yes
In groups of	1
Control of a digital input	Yes
Continuous current $I_{th}$	Recommended range of application $\geq 100$ mA at 12 VAC/VDC Max. 10 A per relay
Relay rated voltage	240 VAC/VDC
Surge current	Max. 30 A
Incandescent lamp load (25000 switching cycles) at	1000 W
Fluorescent tubes with ballast (25000 switching cycles)	10 x 58 W
Fluorescent tubes, conventionally compensated (25000 switching cycles)	1 x 58 W
Fluorescent tubes, uncompensated (25000 switching cycles)	10 x 58 W
Derating	None; across the entire temperature range
Short circuit-proof cos 1	Power protection B16, 600 A
Short circuit-proof cos 0.5 to 0.7	Power protection B16, 900 A
Parallel output circuits for power increase	Not permitted
Protection of output relay (if desired)	Max. 16 A, characteristic B16
Line length (unshielded)	Max. 100 m
<b>Switching rate</b>	
Mechanical	10 Hz
Ohmic load/lamp load	2 Hz
Inductive load	0.5 Hz

Notice: For fluorescent lamps with capacitors, you must consider the technical data of fluorescent lamp ballasts. If the current exceeds the maximum allowed surge current, appropriate contactor relays must switch the fluorescent lamps.

Notice: Output: B300, R300; 8A, 24 VDC, G.P.; 10A, 24 VAC, G.P.; 3A, 120 VAC, Tungsten.

The data was determined with the following devices:

- Siemens fluorescent tubes 58 W VVG 5LZ 583 3-1 uncompensated.
- Siemens fluorescent tubes 58 W VVG 5LZ 583 3-1 parallel compensated with 7  $\mu$ F.
- Siemens fluorescent tubes 58 W VVG 5LZ 501 1-1N with ballast.

## A.7 Technical data: LOGO! DM8 24R and LOGO! DM16 24R

	LOGO! DM8 24R	LOGO! DM16 24R
<b>Power supply</b>		
Input voltage	24 VAC/VDC	24 VDC
Permissible range	20.4 VAC to 26.4 VAC 20.4 VDC to 28.8 VDC	20.4 VDC to 28.8 VDC
Reverse polarity protection	--	Yes
Input frequency	50/60 Hz	--
Permissible mains frequency	47 Hz to 63 Hz	--
Power consumption		
• 24 VAC	• 40 mA to 110 mA	• --
• 24 VDC	• 15 mA to 50 mA	• 30 mA to 115 mA
Voltage failure buffering	Typ. 5 ms	Typ. 5 ms
Power loss		
• 24 VAC	• 1.0 W to 2.6 W	• --
• 24 VDC	• 0.4 W to 1.2 W	• 0.7 W to 2.8 W
<b>Digital inputs</b>		
Number	4, optional positive voltage or negative voltage	8
Electrical isolation	No	No
Number of high speed inputs	0	0
Input frequency		
• Normal input	• Max. 4 Hz	• Max. 4 Hz
• High speed input	• --	• --
Digital input	24 VAC/DC, 50/60 Hz	24 VDC
Max. continuous permissible voltage	• 26.4 VAC • 28.8 VDC	• -- • 28.8 VDC
Input voltage	L	
• Signal 0	• < 5 VAC/VDC	• < 5 VDC
• Signal 1	• > 12 VAC/VDC	• > 12 VDC
Input current at		
• Signal 0	• < 1.1 mA	• < 0.85 mA
• Signal 1	• > 2.63 mA	• > 2.0 mA
Delay time at		
• 0 to 1	• Typ. 1.5 ms	• Typ. 1.5 ms
• 1 to 0	• Typ. 15 ms	• Typ. 1.5 ms
Line length (unshielded)	Max. 100 m	Max. 100 m
<b>Digital outputs</b>		
Number	4	8
Output type	Relay outputs	Relay outputs
Electrical isolation	Yes	Yes
In groups of	1	1

	LOGO! DM8 24R	LOGO! DM16 24R
Control of a digital input	Yes	Yes
Continuous current $I_{th}$	Recommended range of application $\geq 100$ mA at 12 VAC/VDC Max. 5 A per relay	Recommended range of application $\geq 100$ mA at 12 VAC/VDC Max. 5 A per relay
Relay rated voltage	240 VAC/VDC	240 VAC/VDC
Surge current	Max. 30 A	Max. 30 A
Incandescent lamp load (25000 switching cycles) at	1000 W	1000 W
Fluorescent tubes with ballast (25000 switching cycles)	10 x 58 W	10 x 58 W
Fluorescent tubes, conventionally compensated (25000 switching cycles)	1 x 58 W	1 x 58 W
Fluorescent tubes, uncompensated (25000 switching cycles)	10 x 58 W	10 x 58 W
Derating	None; across the entire temperature range	None; across the entire temperature range
Short circuit-proof $\cos 1$	Power protection B16, 600 A	Power protection B16, 600 A
Short circuit-proof $\cos 0.5$ to $0.7$	Power protection B16, 900 A	Power protection B16, 900 A
Parallel output circuits for power increase	Not permitted	Not permitted
Protection of output relay (if desired)	Max. 16 A, characteristic B16	Max. 16 A, characteristic B16
Line length (unshielded)	Max. 100 m	Max. 100 m
<b>Switching rate</b>		
Mechanical	10 Hz	10 Hz
Ohmic load/lamp load	2 Hz	2 Hz
Inductive load	0.5 Hz	0.5 Hz

Notice: For fluorescent lamps with capacitors, you must consider the technical data of fluorescent lamp ballasts. If the current exceeds the maximum allowed surge current, appropriate contactor relays must switch the fluorescent lamps.

Notice: Output: B300, R300; 5A, 24 VDC, G.P.; 5A, 240 VAC, G.P.; 3A, 120 VAC, Tungsten.

The data was determined with the following devices:

- Siemens fluorescent tubes 58 W VVG 5LZ 583 3-1 uncompensated.
- Siemens fluorescent tubes 58 W VVG 5LZ 583 3-1 parallel compensated with 7  $\mu$ F.
- Siemens fluorescent tubes 58 W VVG 5LZ 501 1-1N with ballast.

## A.8 Technical data: LOGO! 12/24... LOGO! DM8 12/24R

	LOGO! 12/24RCEo LOGO! 12/24RCE	LOGO! DM8 12/24R
<b>Power supply</b>		
Input voltage	12/24 VDC	12/24 VDC

	LOGO! 12/24RCEo LOGO! 12/24RCE	LOGO! DM8 12/24R
Permissible range	10.8 VDC to 28.8 VDC	10.8 VDC to 28.8 VDC
Reverse polarity protection	Yes	Yes
Power consumption <ul style="list-style-type: none"> <li>• 12 VDC</li> <li>• 24 VDC</li> </ul>	<ul style="list-style-type: none"> <li>• 50 mA to 165 mA</li> <li>• 25 mA to 90 mA</li> </ul>	<ul style="list-style-type: none"> <li>• 20 mA to 90 mA</li> <li>• 15 mA to 50 mA</li> </ul>
Voltage failure buffering <ul style="list-style-type: none"> <li>• 12 VDC</li> <li>• 24 VDC</li> </ul>	<ul style="list-style-type: none"> <li>• Typ. 2 ms</li> <li>• Typ. 5 ms</li> </ul>	<ul style="list-style-type: none"> <li>• Typ. 2 ms</li> <li>• Typ. 5 ms</li> </ul>
Power loss <ul style="list-style-type: none"> <li>• 12 VDC</li> <li>• 24 VDC</li> </ul>	<ul style="list-style-type: none"> <li>• 0.6 W to 2.0 W</li> <li>• 0.6 W to 2.2 W</li> </ul>	<ul style="list-style-type: none"> <li>• 0.2 W to 1.1 W</li> <li>• 0.4 W to 1.2 W</li> </ul>
Backup of the real-time clock at 25 °C	Typ. 20 days	--
Accuracy of the real-time clock	Typ. $\pm 2$ s/day	--
Electrical isolation	No	No
<b>Digital inputs</b>		
Number	8	4
Electrical isolation	No	No
Number of high speed inputs	4 (I3, I4, I5, I6)	0
Input frequency <ul style="list-style-type: none"> <li>• Normal input</li> <li>• High speed input</li> </ul>	<ul style="list-style-type: none"> <li>• Max. 4 Hz</li> <li>• Max. 5 kHz</li> </ul>	<ul style="list-style-type: none"> <li>• Max. 4 Hz</li> <li>• --</li> </ul>
Digital input	12/24 VDC	12/24 VDC
Max. continuous permissible voltage	28.8 VDC	28.8 VDC
Input voltage L+ <ul style="list-style-type: none"> <li>• Signal 0</li> <li>• Signal 1</li> </ul>	<ul style="list-style-type: none"> <li>• &lt; 5 VDC</li> <li>• &gt; 8.5 VDC</li> </ul>	<ul style="list-style-type: none"> <li>• &lt; 5 VDC</li> <li>• &gt; 8.5 VDC</li> </ul>
Input current at <ul style="list-style-type: none"> <li>• Signal 0</li> <li>• Signal 1</li> </ul>	<ul style="list-style-type: none"> <li>&lt; 0.88 mA (I3 to I6)</li> <li>&lt; 0.07 mA (I1, I2, I7, I8)</li> <li>&gt; 1.5 mA (I3 to I6)</li> <li>&gt; 0.12 mA (I1, I2, I7, I8)</li> </ul>	<ul style="list-style-type: none"> <li>&lt; 0.88 mA</li> <li>&gt; 1.5 mA</li> </ul>
Delay time at <ul style="list-style-type: none"> <li>• 0 to 1</li> <li>• 1 to 0</li> </ul>	<ul style="list-style-type: none"> <li>• Typ. 1.5 ms</li> <li>&lt;1.0 ms (I3 to I6)</li> <li>• Typ. 1.5 ms</li> <li>&lt;1.0 ms (I3 to I6)</li> </ul>	<ul style="list-style-type: none"> <li>• Typ. 1.5 ms</li> <li>• Typ. 1.5 ms</li> </ul>
Line length (unshielded)	Max. 100 m	Max. 100 m
<b>Analog inputs</b>		
Number	4 (I1=AI3, I2=AI4, I7=AI1, I8=AI2)	--
Range	0 VDC to 10 VDC Input impedance 80 k $\Omega$	--



	LOGO! 12/24RCEo LOGO! 12/24RCE	LOGO! DM8 12/24R
Cycle time for analog value generation	300 ms	--
Line length (shielded and twisted)	Max. 10 m	--
Error limit	± 1.5% at FS	--
<b>Digital outputs</b>		
Number	4	4
Output type	Relay outputs	Relay outputs
Electrical isolation	Yes	Yes
In groups of	1	1
Control of a digital input	Yes	Yes
Continuous current $I_{th}$ (per terminal)	Recommended range of application ≥ 100 mA at 12 VAC/VDC Max. 10 A per relay	Recommended range of application ≥ 100 mA at 12 VAC/VDC Max. 5 A per relay
Relay rated voltage	240 VAC/VDC	240 VAC/VDC
Surge current	Max. 30 A	Max. 30 A
Incandescent lamp load (25000 switching cycles) at	1000 W	1000 W
Fluorescent tubes with ballast (25000 switching cycles)	10 x 58 W	10 x 58 W
Fluorescent tubes, conventionally compensated (25000 switching cycles)	1 x 58 W	1 x 58 W
Fluorescent tubes, uncompensated (25000 switching cycles)	10 x 58 W	10 x 58 W
Derating	None; across the entire temperature range	None; across the entire temperature range
Short circuit-proof cos 1	Power protection B16, 600 A	Power protection B16, 600 A
Short circuit-proof cos 0.5 to 0.7	Power protection B16, 900 A	Power protection B16, 900 A
Parallel output circuits for power increase	Not permitted	Not permitted
Protection of output relay (if desired)	Max. 16 A, characteristic B16	Max. 16 A, characteristic B16
Line length (unshielded)	Max. 100 m	Max. 100 m
<b>Switching rate</b>		
Mechanical	10 Hz	10 Hz
Ohmic load/lamp load	2 Hz	2 Hz
Inductive load	0.5 Hz	0.5 Hz

Notice: For fluorescent lamps with capacitors, you must consider the technical data of fluorescent lamp ballasts. If the current exceeds the maximum allowed surge current, appropriate contactor relays must switch the fluorescent lamps.

Notice:

- Output of LOGO! 12/24RCE/RCEo: B300, R300; 8A, 24 VDC, G.P.; 10A, 240 VAC, G.P.; 3A, 120 VAC, Tungsten.
- Output of LOGO! DM8 12/24R: B300, R300; 5A, 24 VDC, G.P.; 5A, 240 VAC, G.P.; 3A, 120 VAC, Tungsten.

A.9 Switching capacity/service life of the relay outputs

The data was determined with the following devices:

- Siemens fluorescent tubes 58 W VVG 5LZ 583 3-1 uncompensated.
- Siemens fluorescent tubes 58 W VVG 5LZ 583 3-1 parallel compensated with 7  $\mu$ F.
- Siemens fluorescent tubes 58 W VVG 5LZ 501 1-1N with ballast.

## A.9 Switching capacity/service life of the relay outputs

### Switching capacity and service life of the contacts with ohmic loading (heating):

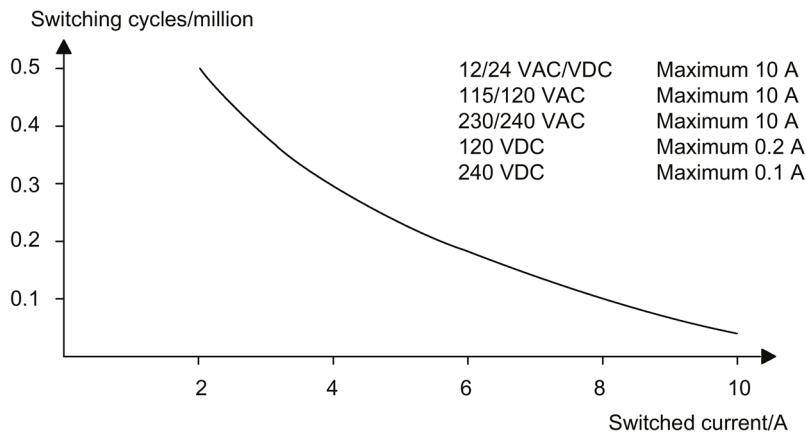

### Switching capacity and service life of the contacts with high inductive load to IEC 60947-5-1 DC 13/AC 15 (contactors, solenoid coils, motors):

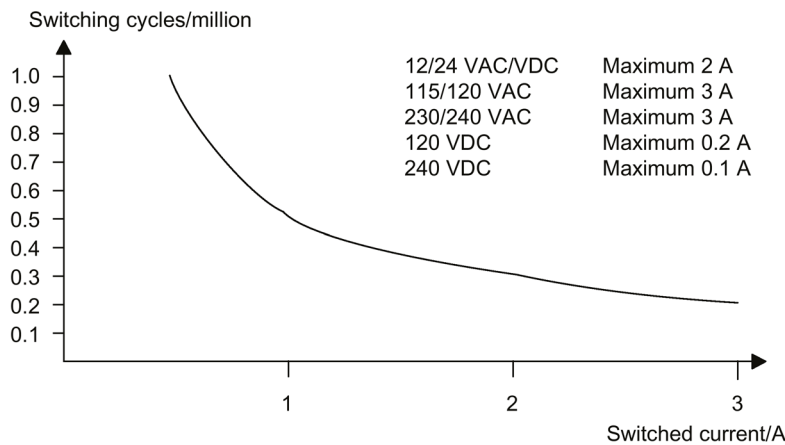

#### Note

To ensure the switching capacity and service life, keep the minimum switching load of the relay outputs at 100 mA with the voltage of 12 VAC/VDC.

## A.10 Technical data: LOGO! AM2

LOGO! AM2	
<b>Power supply</b>	
Input voltage	12/24 VDC
Permissible range	10.8 VDC to 28.8 VDC
Power consumption	25 mA to 30 mA
Voltage failure buffering	Typ. 10 ms
Power loss at <ul style="list-style-type: none"> <li>• 12 VDC</li> <li>• 24 VDC</li> </ul>	<ul style="list-style-type: none"> <li>• 0.3 W to 0.4 W</li> <li>• 0.6 W to 0.7 W</li> </ul>
Electrical isolation	No
Reverse polarity protection	Yes
Ground terminal	For connecting ground and shielding of the analog measuring line
<b>Analog inputs</b>	
Number	2
Type	Unipolar
Input range	0 VDC to 10 VDC (input impedance 76 k $\Omega$ ) or 0/4 mA to 20 mA (input impedance <250 $\Omega$ )
Resolution	10 bit, normalized to 0 to 1000
Cycle time for analog value generation	50 ms
Electrical isolation	No
Line length (shielded and twisted)	Max. 10 m
Encoder supply voltage	None
Error limit	$\pm 1.5\%$ FS
Interference frequency suppression	55 Hz

## A.11 Technical data: LOGO! AM2 RTD

LOGO! AM2 RTD	
<b>Power supply</b>	
Input voltage	12/24 VDC
Permissible range	10.8 VDC to 28.8 VDC
Power consumption	25 mA to 30 mA
Voltage failure buffering	Typ. 10 ms
Power loss at <ul style="list-style-type: none"> <li>• 12 VDC</li> <li>• 24 VDC</li> </ul>	<ul style="list-style-type: none"> <li>• 0.3 W to 0.4 W</li> <li>• 0.6 W to 0.7 W</li> </ul>
Electrical isolation	No
Reverse polarity protection	Yes
Ground terminal	For connecting ground and shielding of the measuring line.

A.12 Technical data: LOGO! AM2 AQ

LOGO! AM2 RTD	
<b>Sensor inputs</b>	
Number	2
Type	PT100 or PT1000 with the default temperature coefficient of $\alpha = 0.003850$ for both Types, or compatible sensors.
Connection of sensors	<ul style="list-style-type: none"> <li>• 2-wire technique</li> <li>• 3-wire technique</li> </ul>
Measurement range	-50 °C to +200 °C -58 °F to +392 °F
Settings for the measurement display on the LOGO! Basic:	<ul style="list-style-type: none"> <li>• 1 °C steps</li> <li>• 0.25 °C steps (rounded to one decimal)</li> <li>• 1 °F steps</li> <li>• 0.25 °F steps (rounded to one decimal)</li> </ul>
Curve linearization	No
Measuring current I <sub>c</sub>	Pulse current signal: PT100: 0.5 mA PT1000: 0.5 mA
Measurement rate	Depends on the installation Typ. 50 ms
Resolution	0.25 °C
Error limits (3-wire technique)	Of the final measured value: <ul style="list-style-type: none"> <li>• 0 °C to +200 °C</li> <li>• -50 °C to 200 °C</li> </ul>
Electrical isolation	No
Cable length (twisted)	Max. 10 m
Interference frequency suppression	50 Hz, 60 Hz

**A.12 Technical data: LOGO! AM2 AQ**

LOGO! AM2 AQ	
<b>Power supply</b>	
Input voltage	24 VDC
Permissible range	20.4 VDC to 28.8 VDC
Power consumption	30 mA to 82 mA
Voltage failure buffering	Typ. 10 ms
Power loss at 24 VDC	0.7 W to 2.0 W
Electrical isolation	No

A.13 Technical data: LOGO! TDE (Text Display with Ethernet interfaces)

LOGO! AM2 AQ	
Reverse polarity protection	Yes
Ground terminal	For connecting ground and shielding of the analog output line.
<b>Analog outputs</b>	
Number	2
Voltage range	0 VDC to 10 VDC
Voltage load	≥5 kΩ
Current output	0/4 mA to 20 mA
Current load	≤250 Ω
Resolution	10 bit, normalized to 0 to 1000
Cycle time for analog output	Depending on installation (50 ms)
Electrical isolation	No
Line length (shielded and twisted)	Max. 10 m
Error limit	± 2.5% FS
Short circuit protection	Voltage output: Yes
Overload protection	Current output: Yes Voltage output: Yes

## A.13 Technical data: LOGO! TDE (Text Display with Ethernet interfaces)

LOGO! TDE	
<b>Mechanical data</b>	
Keyboard	Membrane keypad with 10 keys
Display	FSTN-Graphic Display with 160 x 96 (columns x rows), LED backlight (white/amber/red)
<b>Power supply</b>	
Input voltage	24 VAC/VDC 12 VDC
Permissible range	20.4 VAC to 26.4 VAC 10.2 VDC to 28.8 VDC
Input frequency	50/60 Hz
Permissible mains frequency	47Hz to 63 Hz
Power consumption (Ethernet and white backlight active)	<ul style="list-style-type: none"> <li>• 12 VDC</li> <li>• 24 VDC</li> <li>• 24 VAC</li> </ul> <ul style="list-style-type: none"> <li>• Typ. 150 mA</li> <li>• Typ. 75 mA</li> <li>• Typ. 145 mA</li> </ul>
<b>Degree of protection</b>	
	IP20 for LOGO! TDE excluding front panel IP65 for LOGO! TDE front panel
Enclosure type	Type 4X/12 for LOGO! TDE front panel

A.13 Technical data: LOGO! TDE (Text Display with Ethernet interfaces)

LOGO! TDE	
<b>Communication port</b>	
Ethernet performance	Two Ethernet interfaces with 10/100 M full/half duplex data transmission rate
Connection distance	Max. 30 m
<b>LCD Display and Backlight</b>	
Backlight lifetime <sup>1)</sup>	20,000 hours
Display lifetime <sup>2)</sup>	50,000 hours
<b>Mounting</b>	
Mounting hole dimensions (WxH)	(119 + 0.5 mm) x (78.5 + 0.5 mm)
Mounting conditions	Mount the LOGO! TDE vertically on a flat surface of an IP 65 or Type 4x/12 enclosure.

- 1) The backlight lifetime is when the final brightness is 50% of the original brightness.
- 2) The display lifetime is calculated under ordinary operating and storage conditions: room temperature (20 ± 8 °C), normal humidity below 65% relative humidity, and not in exposure to direct sunlight.

## Determining the cycle time

The program cycle is the complete execution of the circuit program, that is, primarily the reading in of the inputs, the processing of the circuit program and the subsequent writing the outputs. The cycle time is the time required to execute a circuit program once in full.

You can determine the time required for a program cycle using a short test program. Create this test program in LOGO! to return a value from which you can calculate the cycle time.

### Test program

To program this test program, follow these steps:

1. Create the test program by linking an output to a threshold trigger and connecting the trigger input with an inverted flag.

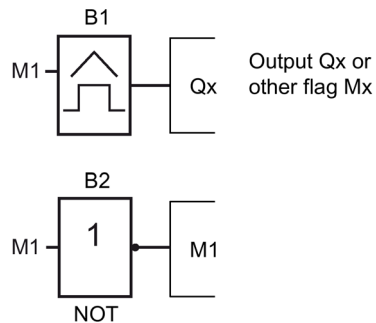

2. Configure the threshold trigger as shown below. LOGO! generates a pulse in each program cycle due to the inverted flag. The trigger interval is 2 seconds.

B1	1/1	+/
On	=1000	
Off	=0	
G_T	=02:00s	

3. Now start the circuit program and switch LOGO! to parameter assignment mode. In this mode, view the trigger parameters.

B1	1/1	
On	=1000	
Off	=0	
fa	=2130	← f <sub>a</sub> = total of measured pulses per timebase G_T

4. The reciprocal value of f<sub>a</sub> is equivalent to the LOGO! execution time of the current circuit program in its memory.

$$1/f_a = \text{cycle time in s}$$

### Explanation

The inverted flag block changes its output signal at each program execution. Thus, one logic level (high or low) width is exactly equivalent to the length of one cycle. Hence, a period lasts two cycles.

The threshold trigger indicates the ratio of periods per two seconds, which results in the ratio of cycles per second.

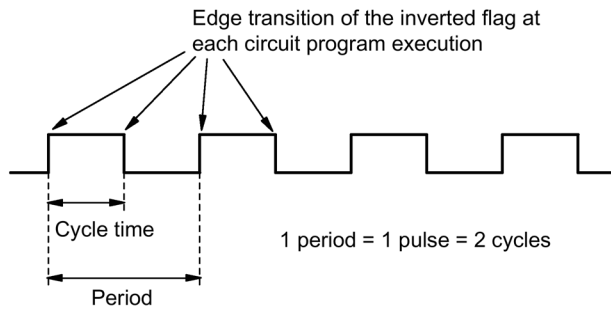



# LOGO! without display ("LOGO! Pure")

Because some specific applications do not require operator control or interface elements, such as buttons or a display, Siemens provides the LOGO! 12/24RCEo, LOGO! 24RCEo, LOGO! 24CEo and LOGO! 230RCEo versions without display.

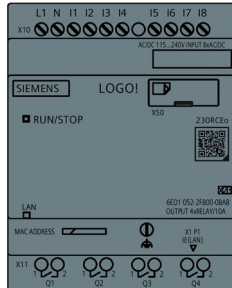

## Less is definitely more!

The versions without display offer you the following benefits:

- Even more cost-effective without the operating elements
- Requires less switch cabinet space than conventional hardware
- Substantial benefits with regard to flexibility and prime costs compared to stand-alone electronic switchgear
- Advantageous even for applications in which it replaces merely two or three conventional switching devices
- Very easy to use
- Access-protected
- Compatible to LOGO! versions with display
- Offers the option to read data by means of LOGO!Soft Comfort

## Creating a circuit program without operator panel

You can use one of two ways to create a circuit program for a LOGO! without display:

- You create the circuit program with LOGO!Soft Comfort on your PC and then download it to LOGO!.
- You download the circuit program from a micro SD card (Page 300) to your LOGO! without display.

## Network communication indication

When you create a circuit program with LOGO!Soft Comfort, you need to connect the module to your PC with an Ethernet cable. You can refer to the chapter Connecting the Ethernet interface (Page 57) to find the details about the wiring of the Ethernet interface and also about the status of the Ethernet LEDs.

## Operating characteristics

LOGO! is ready for operation when you switch on power. Switching off a LOGO! without display is equivalent to disconnecting the power supply.

You can not start or stop the circuit program of LOGO!...o versions by means of buttons, therefore, this is why the LOGO!...o versions have other startup characteristics.

## Startup characteristics

If there is no circuit program in LOGO! or on the inserted micro SD card, LOGO! remains in STOP mode.

If there is a valid circuit program in LOGO! memory or on the micro SD card, LOGO! automatically switches from STOP mode to RUN mode when you switch on power.

LOGO! automatically copies the circuit program on an inserted micro SD card to memory, immediately after you switch on power. LOGO! rewrites the existing circuit program in memory if one exists, and then changes from STOP mode to RUN mode.

By connecting an Ethernet cable to LOGO! (Page 336), you can use LOGO!Soft Comfort to download the circuit program and place LOGO! in RUN mode.

## Operating status indication

An LED on the front panel indicates the operating state:

- Lights red: Power On/STOP
- Lights green: Power On/RUN

The LED lights red after Power On and in all LOGO! states other than RUN mode. The LED lights green when LOGO! is in RUN mode.

## Reading current data

LOGO!Soft Comfort provides an online test for reading the current data of all functions while the system is in RUN.

If your LOGO! without display holds a protected micro SD card, you cannot read the current data unless you enter the correct password (Page 314) for the circuit program. LOGO! deletes the circuit program from memory when you remove the micro SD card.

## Deleting the circuit program

Use LOGO!Soft Comfort to delete the circuit program and password if a password exists.

## LOGO! menu structure

### D.1 LOGO! Basic

#### D.1.1 Menu overview

All of the following menu commands are valid for LOGO! Basic with the ADMIN access level. If you operate the LOGO! with the OP access level, some menu commands are invisible. For more information see section Overview of LOGO! Menus (Page 74).

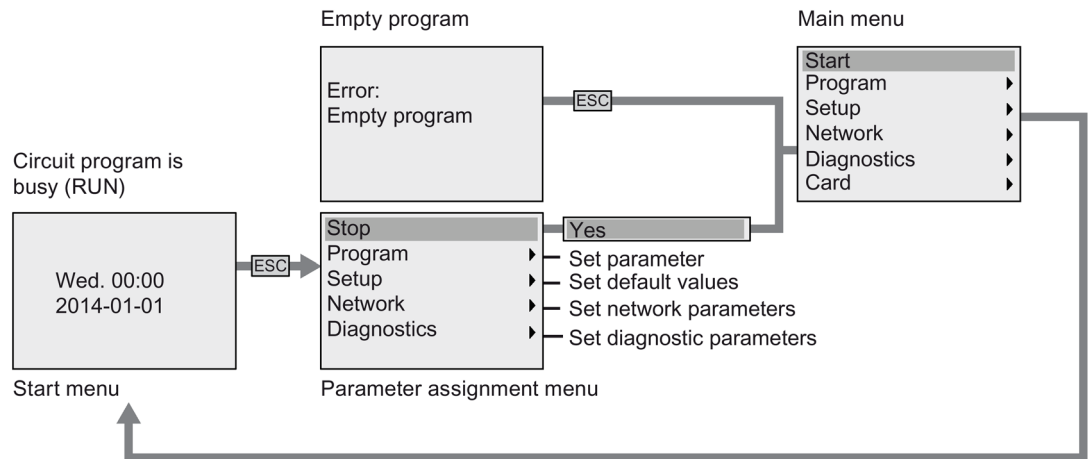

#### D.1.2 Main menu

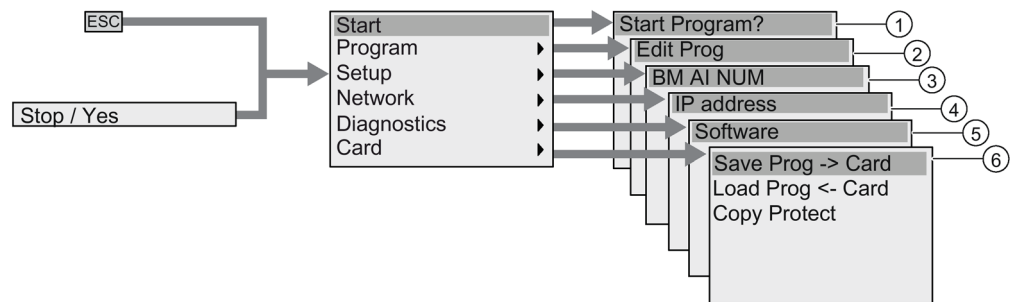

- ① See "Start menu (Page 372)"
- ② See "Programming menu (Page 368)"
- ③ See "Setup menu (Page 369)"
- ④ See "Network menu (Page 370)"
- ⑤ See "Diagnostic menu (Page 371)"
- ⑥ See "Card menu (Page 368)"

### D.1.3 Programming menu

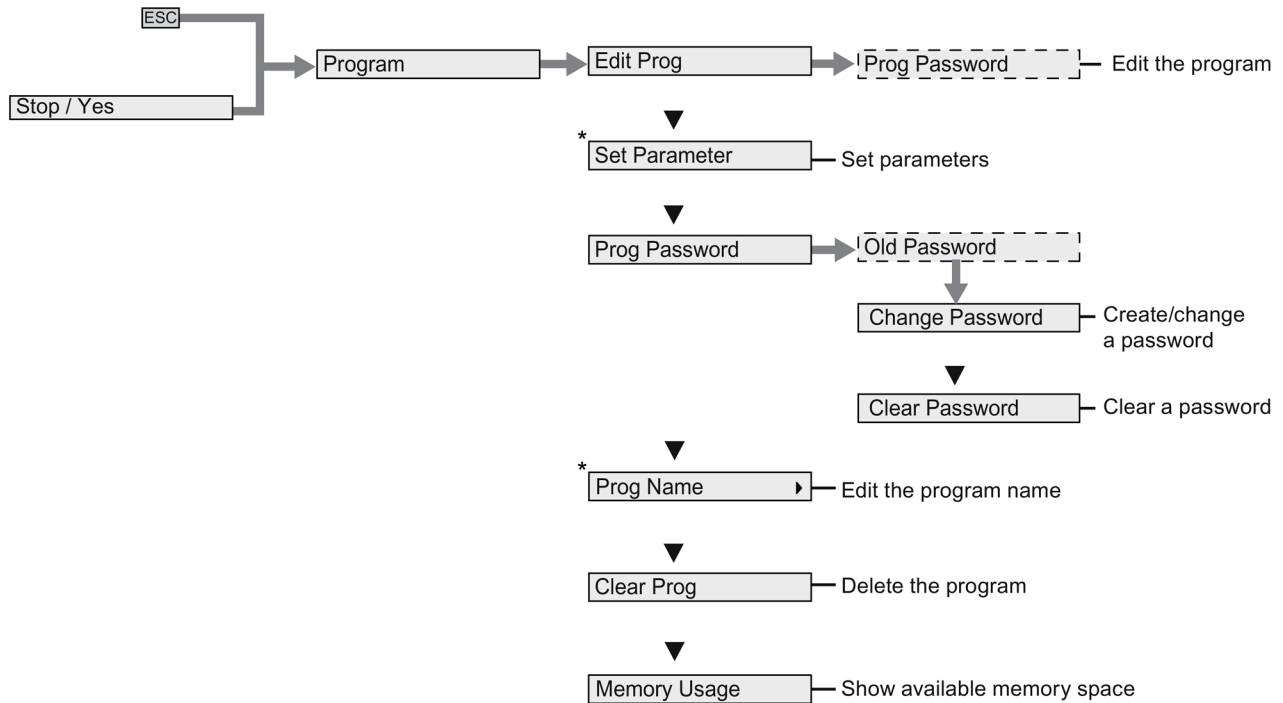

**Note**

When LOGO! is in RUN mode, only the menu commands with an asterisk (\*) are available in the programming menu.

### D.1.4 Card menu

This menu is available only when LOGO! is in programming mode.

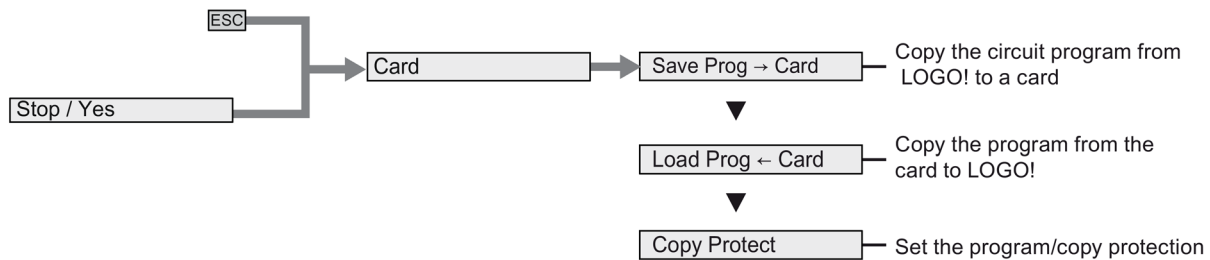

### D.1.5 Setup menu

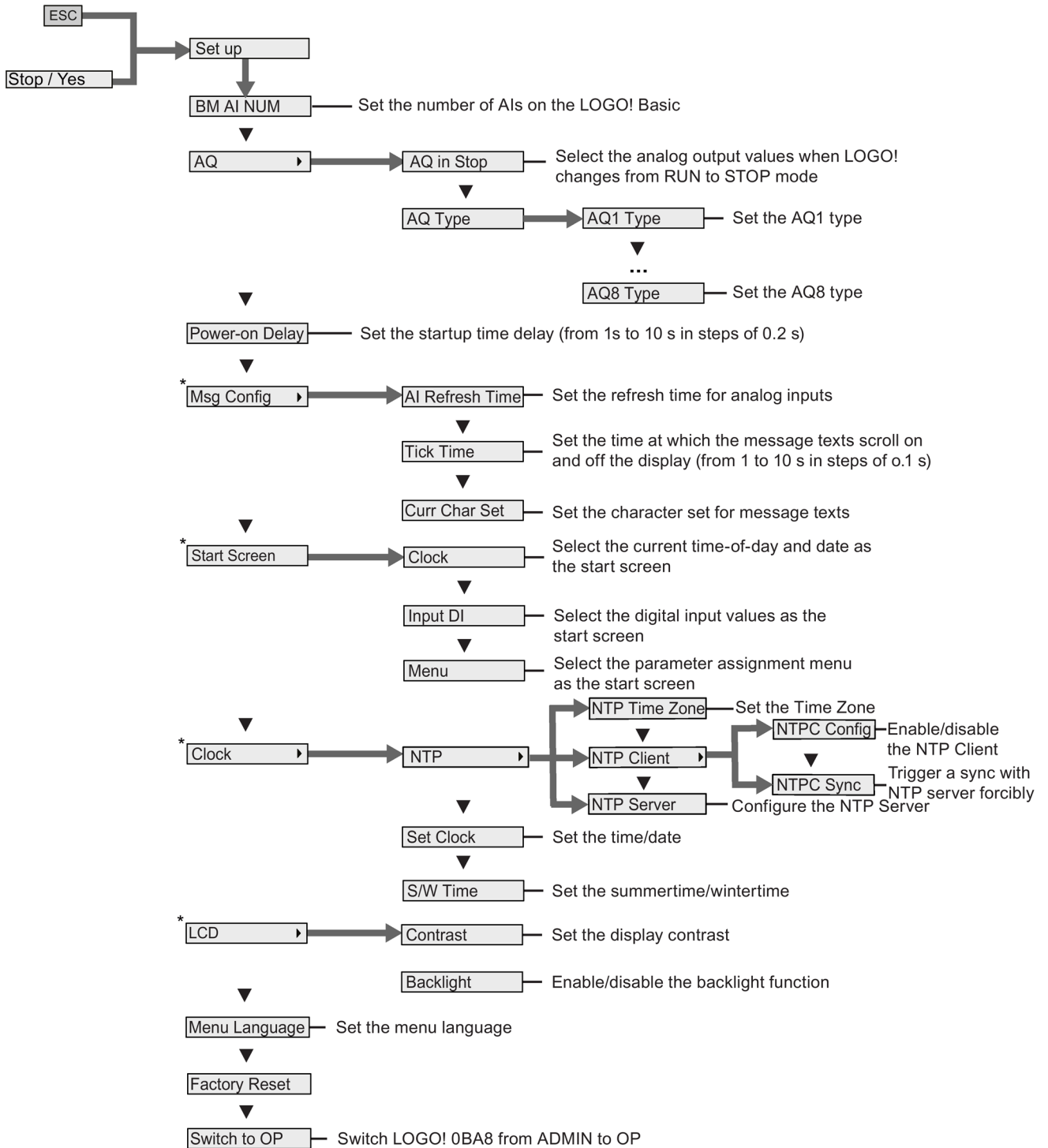

---

**Note**

When LOGO! is in RUN mode, only the menu commands with an asterisk (\*) are available in the setup menu.

---

**D.1.6 Network menu**

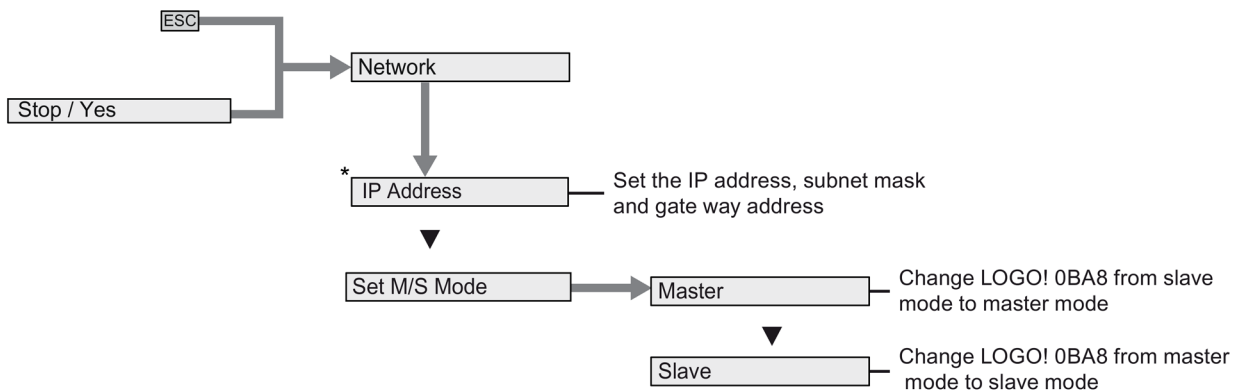

---

**Note**

When LOGO! is in RUN mode, only the menu commands with an asterisk (\*) are available in the network menu.

---

### D.1.7 Diagnostics menu

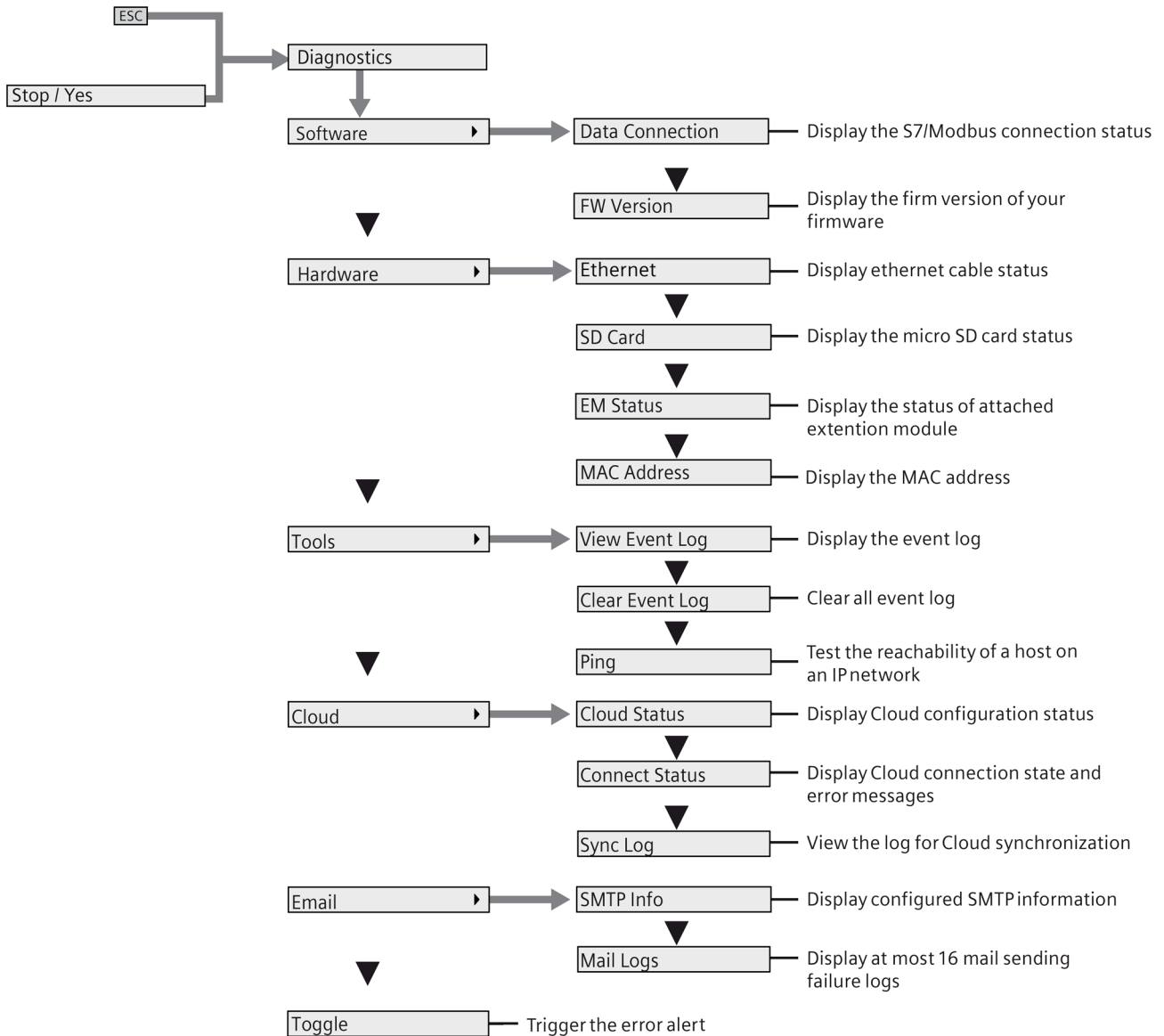

### D.1.8 Start menu

Parameter assignment menu

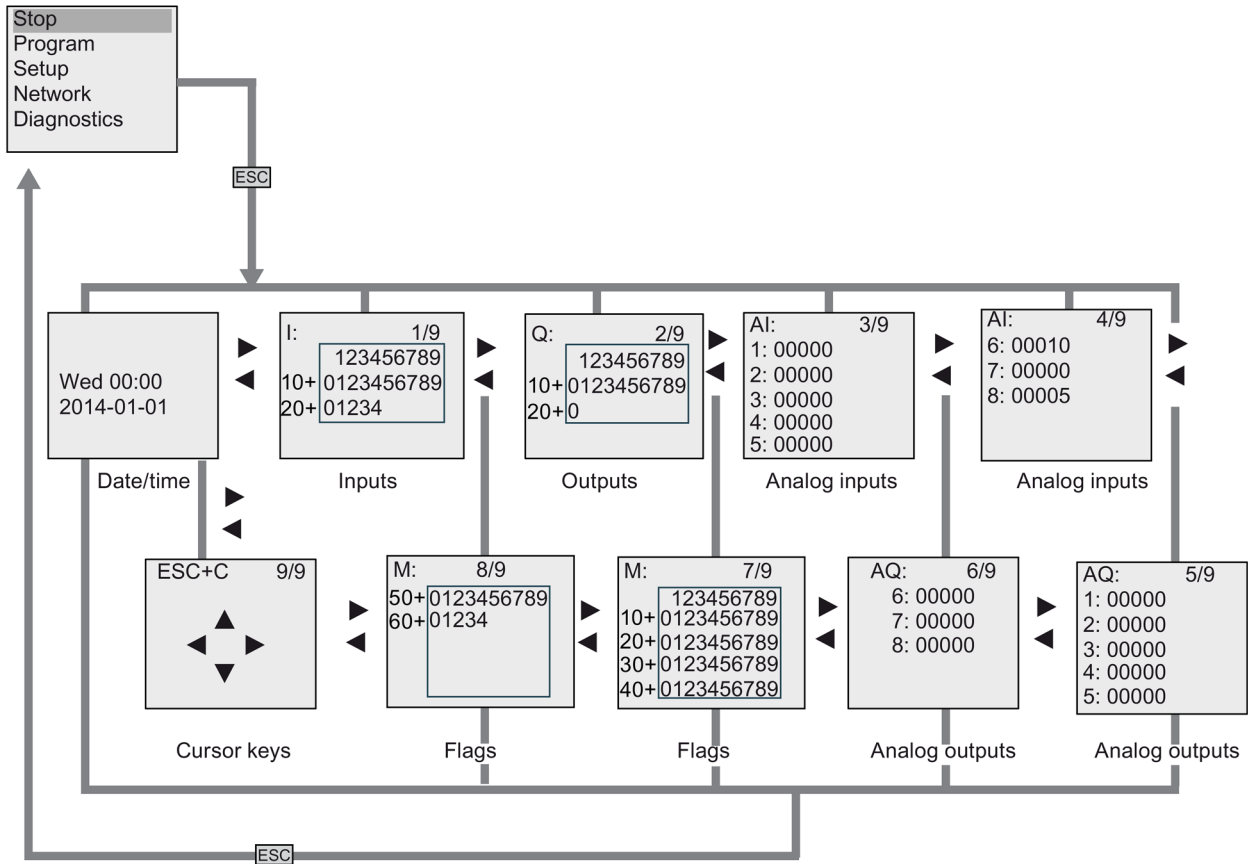



## D.2 LOGO! TDE

### D.2.1 Menu overview

All of the following menu commands are valid for the LOGO! TDE with the ADMIN access level. If you operate the LOGO! TDE with the OP access level, some menu commands are invisible. For more information, see section Overview of LOGO! menus (Page 74).

Circuit program is busy (RUN)

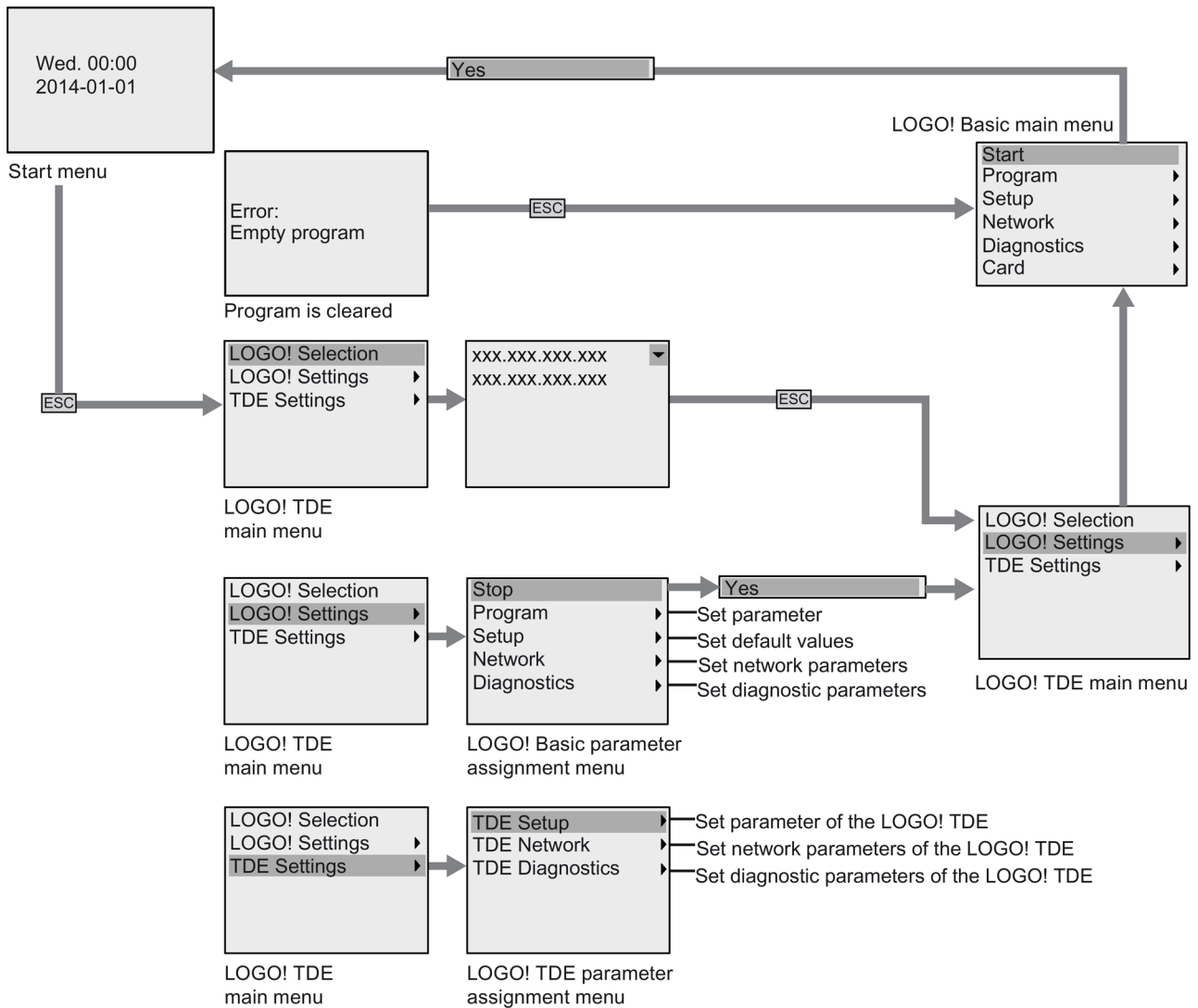

### D.2.2 Main menu

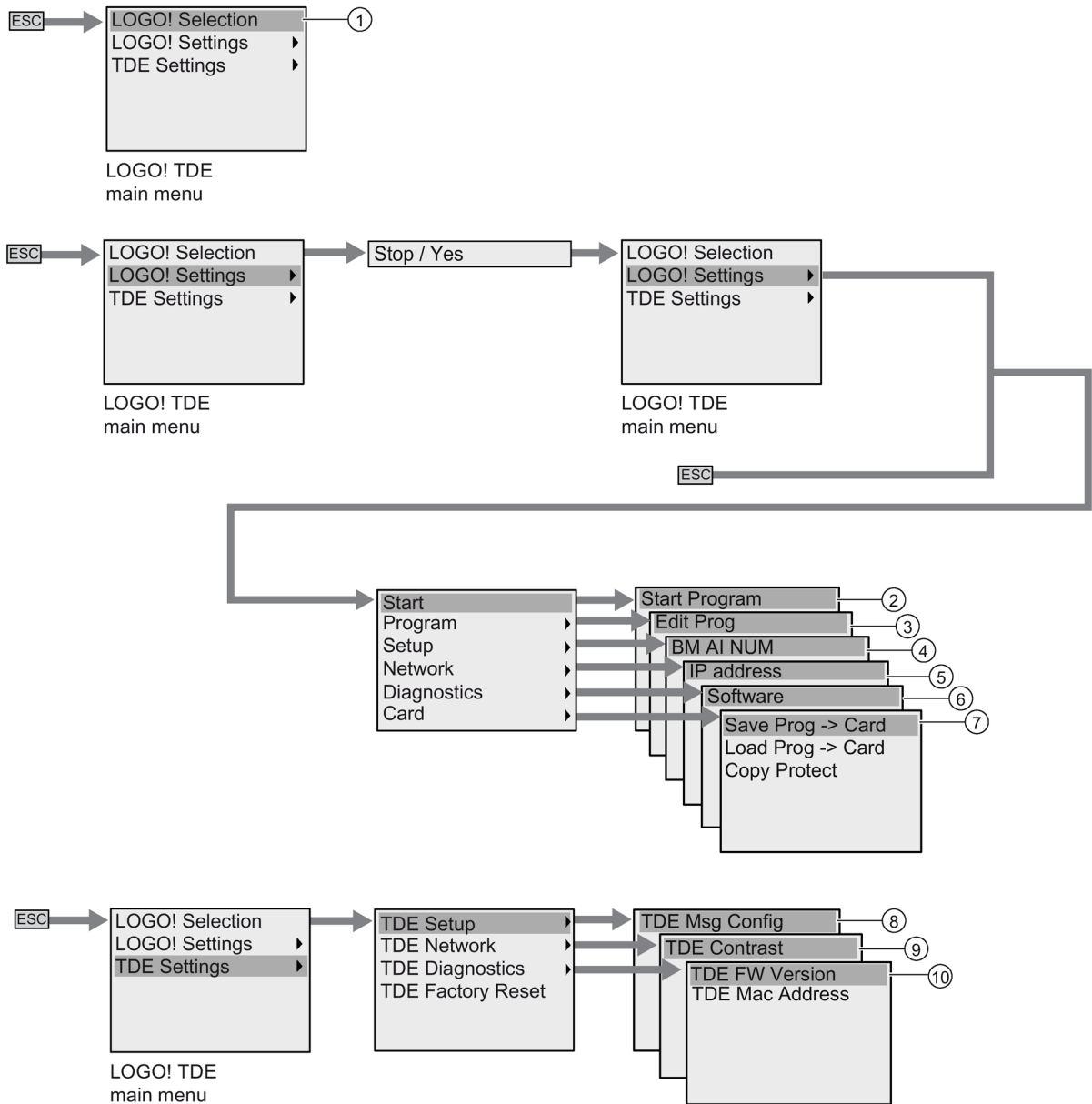

- ① See "LOGO! selection menu (Page 375)".
- ② See "Start menu (Page 375)".
- ③ See "Programming menu (Page 375)".
- ④ See "Setup menu (Page 375)".
- ⑤ See "Network menu (Page 375)".
- ⑥ See "Diagnostic menu (Page 375)".
- ⑦ See "Card menu (Page 375)".
- ⑧ See "TDE setup menu (Page 378)".
- ⑨ See "TDE network menu (Page 378)".
- ⑩ See "TDE diagnostic menu (Page 378)".

### D.2.3 LOGO! selection menu

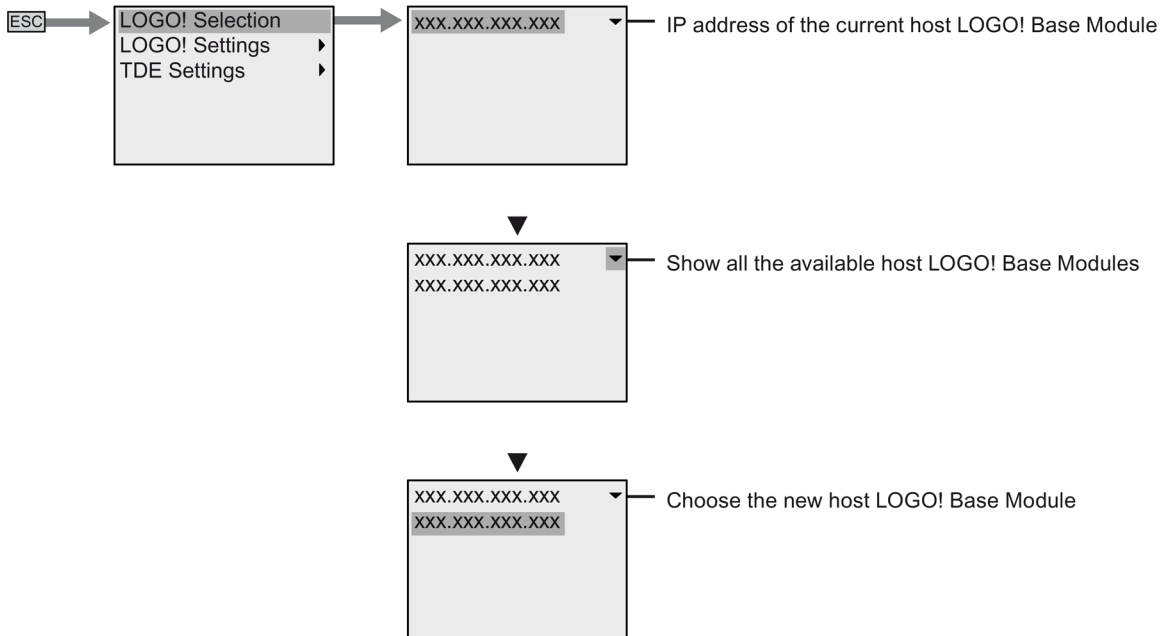

### D.2.4 LOGO! settings menu

The LOGO! TDE allows you to view and configure settings of the connected LOGO! Base Module in its LOGO! settings menu.

#### Program menu

The program menu is the same as that on the LOGO! Base Module. See "Programming menu (Page 368)" for more information.



#### Card menu

The card menu is the same as that on the LOGO! Base Module. See "Card menu (Page 368)" for more information.



### Setup menu

The setup menu is different from that on the LOGO! Base Module. See "Setup menu (Page 369)" for the complete setup menu for LOGO! Basic.

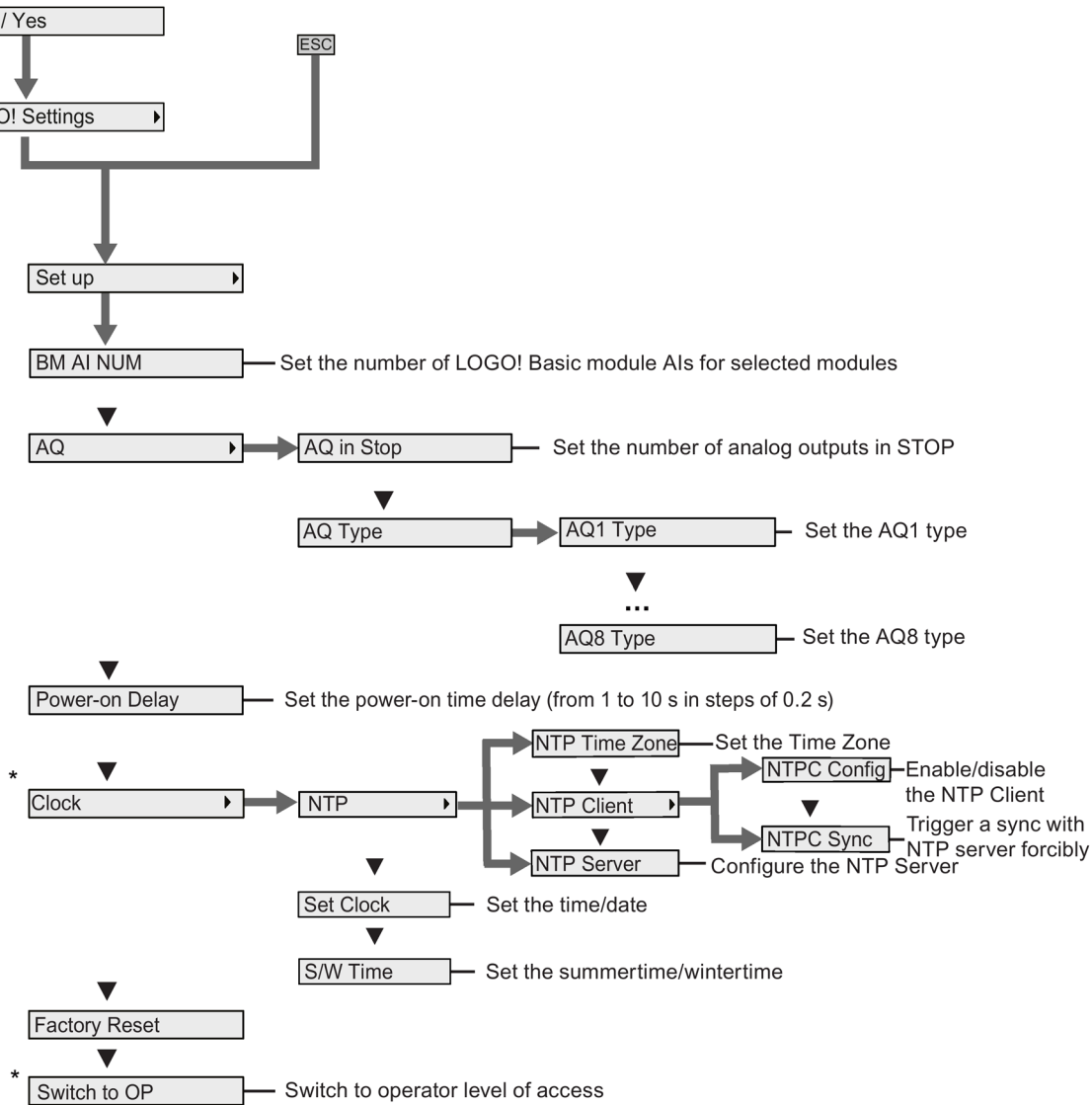

#### Note

When LOGO! 0BA8 is in RUN mode, only the menu commands with an asterisk (\*) are available in the above menu.

## Network menu

The network menu is the same as that on the LOGO! Base Module. See "Network menu (Page 370)" for more information.



## Diagnostics menu

The diagnostics menu is the same as that on the LOGO! Base Module. See "Diagnostics menu (Page 371)" for more information.



## Start menu

The start menu is the same as that on the LOGO! Base Module. See "Start menu (Page 372)" for more information.

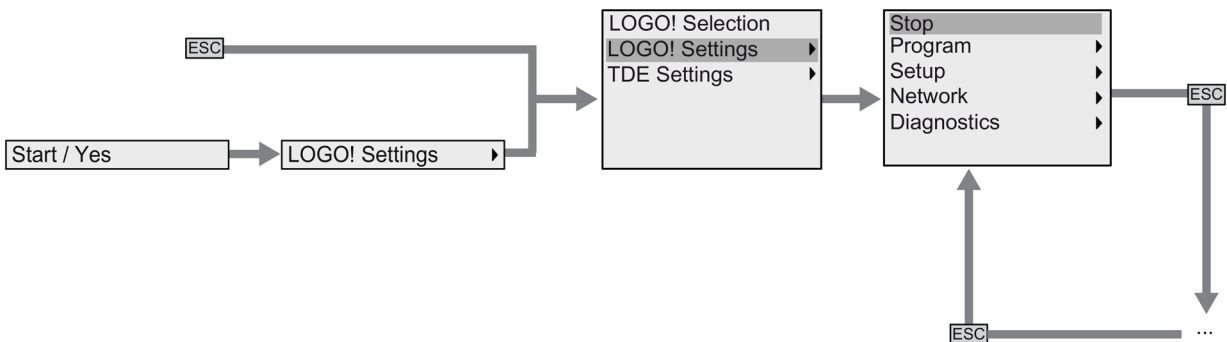

### Note

The start screen of the LOGO! TDE is always the clock display when LOGO! Basic is in RUN mode.

### D.2.5 LOGO! TDE settings menu

The LOGO! TDE allows you to view and configure settings of the LOGO! TDE itself.

The following LOGO! TDE settings menu structure applies both when the connected LOGO! Basic is in RUN or STOP mode.

#### LOGO! TDE setup menu

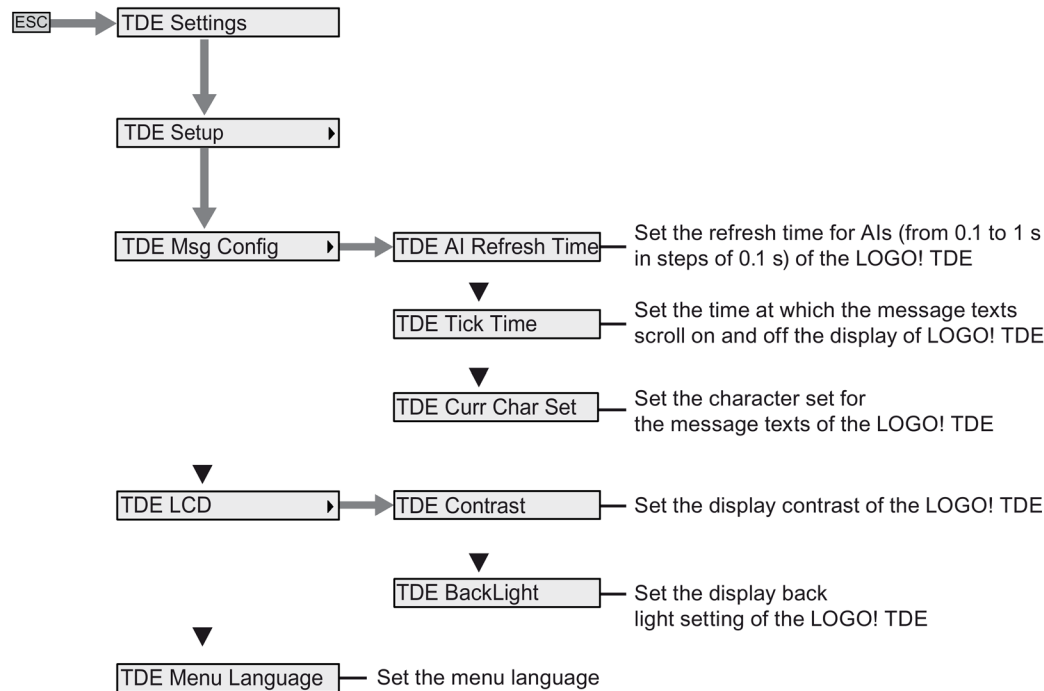

#### LOGO! TDE network menu

You can use the menu below to set the LOGO! TDE network configurations.

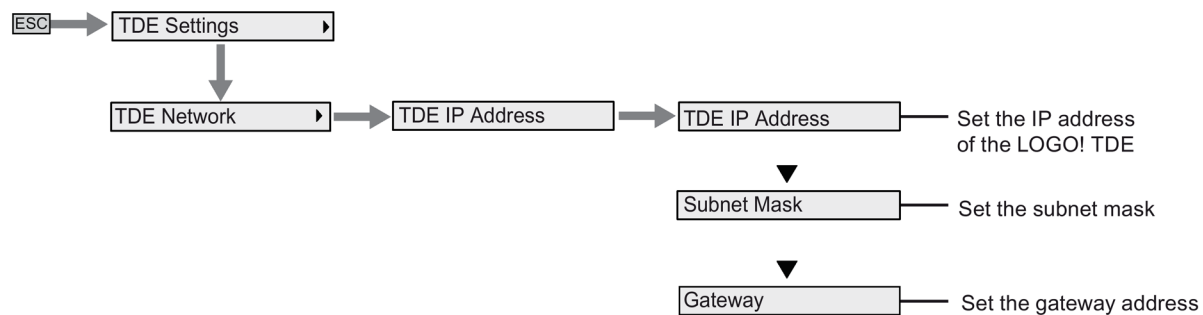



---

#### Note

The IP address of the LOGO! TDE is read-only when it is in RUN mode.

---

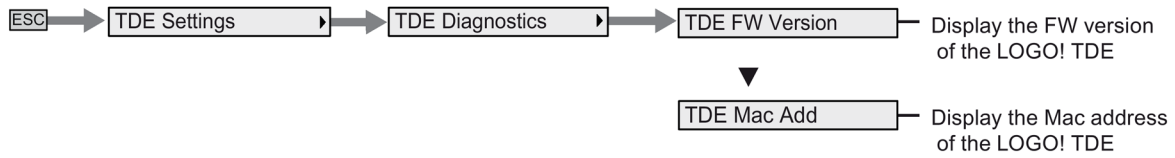
### LOGO! TDE diagnostics menu



## Order numbers

### Modules

Variant	Designation	Order number
LOGO! Basic (Base Module with display)	LOGO! 12/24RCE *	6ED1052-1MD08-0BA2
	LOGO! 24CE *	6ED1052-1CC08-0BA2
	LOGO! 24RCE (AC/DC)	6ED1052-1HB08-0BA2
	LOGO! 230RCE (AC/DC)	6ED1052-1FB08-0BA2
LOGO! Pure (Base Module without display)	LOGO! 12/24RCE <sub>o</sub> *	6ED1052-2MD08-0BA2
	LOGO! 24CE <sub>o</sub> *	6ED1052-2CC08-0BA2
	LOGO! 24RCE <sub>o</sub> (AC/DC)	6ED1052-2HB08-0BA2
	LOGO! 230RCE <sub>o</sub> (AC/DC)	6ED1052-2FB08-0BA2
Digital modules	LOGO! DM8 12/24R	6ED1055-1MB00-0BA2
	LOGO! DM8 24	6ED1055-1CB00-0BA2
	LOGO! DM8 24R	6ED1055-1HB00-0BA2
	LOGO! DM8 230R	6ED1055-1FB00-0BA2
	LOGO! DM16 24	6ED1055-1CB10-0BA2
	LOGO! DM16 24R	6ED1055-1NB10-0BA2
	LOGO! DM16 230R	6ED1055-1FB10-0BA2
Analog modules	LOGO! AM2	6ED1055-1MA00-0BA2
	LOGO! AM2 RTD	6ED1055-1MD00-0BA2
	LOGO! AM2 AQ (0...10V, 0/4...20mA)	6ED1055-1MM00-0BA2
Text Display module with Ethernet interfaces	LOGO! TDE	6ED1055-4MH08-0BA1

\*: Also with analog inputs



## Accessories

Accessories	Designation	Order number
LOGO!Soft Comfort DVD	LOGO!Soft Comfort V8.4.1	6ED1058-0BA08-0YA1
Switching modules	LOGO! Contact 24 V	6ED1057-4CA00-0AA0
	LOGO! Contact 230 V	6ED1057-4EA00-0AA0
Power modules	LOGO!POWER 5 V / 3 A	6EP3310-6SB00-0AY0
	LOGO!POWER 5 V / 6.3 A	6EP3311-6SB00-0AY0
	LOGO!POWER 12 V / 0.9 A	6EP3320-6SB00-0AY0
	LOGO!POWER 12 V / 1.9 A	6EP3321-6SB00-0AY0
	LOGO!POWER 12 V / 4.5 A	6EP3322-6SB00-0AY0
	LOGO!POWER 15 V / 1.9 A	6EP3321-6SB10-0AY0
	LOGO!POWER 15 V / 4 A	6EP3322-6SB10-0AY0
	LOGO!POWER 24 V / 0.6 A	6EP3330-6SB00-0AY0
	LOGO!POWER 24 V / 1.3 A	6EP3331-6SB00-0AY0
	LOGO!POWER 24 V / 2.5 A	6EP3332-6SB00-0AY0
Ethernet switch modules	LOGO!POWER 24 V / 4 A	6EP3333-6SB00-0AY0
	LOGO!POWER EX 24 V / 4 A	6EP3333-6SC00-0AY0
Communication module	LOGO! CSM12/24	6GK7177-1MA20-0AA0
	LOGO! CMK2000 Communicative Interface Module (CIM)	6BK1700-0BA20-0AA0 6ED1055-5MC08-0BA2
TD accessories *	LOGO! TD	6ED1057-1DA00-0BA0

- \* TD accessories includes:
- mounting accessories (Page 43): mounting brackets, mounting screws, gasket
  - power connector (not applicable to TDE)

# Troubleshooting

This chapter provides you with tips on how to locate and troubleshoot problems.

## Sending emails

Diagnostics information is displayed on LOGO! Base module through menu: Diagnostics → Email → Mail Logs. You can refer to the following table to troubleshoot the error cause and fix the error through corresponding solution.

Diagnosics	Possible cause	Possible remedy
Mail busy	Emails are sent too frequently. When the server is sending an email, another email is triggered to send.	As you cannot change the email sending frequency, modify the email sending trigger event.
Time out	<ul style="list-style-type: none"> <li>The network connection is unstable.</li> <li>SMTP server response is time-out.</li> </ul>	<ul style="list-style-type: none"> <li>Check if your network connection is interrupted.</li> <li>Check if the communication with the SMTP server is normal.</li> </ul>
Failed to parse DNS	<ul style="list-style-type: none"> <li>Network connection to DNS server is interrupted.</li> <li>Some error occurs on the SMTP domain name.</li> </ul>	<ul style="list-style-type: none"> <li>Check if the connection with the DNS server is normal.</li> <li>Change DNS server.</li> <li>Check if the SMTP server domain name is correct.</li> </ul>
Failed to login	The login account or login password is incorrect in the SMTP settings.	Check the login account or password in SMTP settings. Additional application code is required for certain SMTP server login. Refer to the user manual of specified email server for detailed information.
Receiver error	<ul style="list-style-type: none"> <li>Email receiver is not configured.</li> <li>Some error occurs on the configured email receiver.</li> </ul>	<ul style="list-style-type: none"> <li>Check if the email receiving group is configured with email receivers. On how to configure email receiver, refer to <i>User interface -&gt; Menu bar -&gt; Tools menu -Transfer -&gt; Email settings</i> in LOGO!Soft Comfort online help.</li> <li>Check if the receiver email address is correct.</li> <li>Check if the receiver email address is within the receiving range of the SMTP server.</li> </ul>
Net error	The network is disconnected when the server is sending the email.	Check your network connection.
No configuration	SMTP server is not configured in LSC.	Configure SMTP in LSC. Refer to <i>User interface -&gt; Menu bar -&gt; Tools menu -Transfer -&gt; Email settings</i> in LOGO!Soft Comfort online help.

Diagnostics	Possible cause	Possible remedy
Server error	<ul style="list-style-type: none"> <li>• SMTP server rejects the email sending request.</li> <li>• SMTP server response doesn't meet with the SMTP specifications.</li> </ul>	Check if error occurs on the SMTP server or the SMTP server login email account.
Failed to verify certificate	The SMTP server certificate is invalid.	<ul style="list-style-type: none"> <li>• Upload valid certificate in SMTP configuration.</li> <li>• Check if the BM time is correct. Incorrect BM time makes it fail to verify certificate.</li> </ul>

## Cloud connection

Diagnostics information is displayed on LOGO! Base module through menu: Diagnostics → Cloud → Connection Status. You can refer to the following table to troubleshoot the error cause and possible solution.

Diagnosics	Possible cause	Possible remedy
Failed to parse DNS	<ul style="list-style-type: none"> <li>DNS server is not available.</li> <li>Error occurs when parsing IP address from DNS server.</li> </ul>	<ul style="list-style-type: none"> <li>Check your network connection.</li> <li>Check if the gateway configuration is correct.</li> <li>Check if the broker URL is correct.</li> </ul>
Server connection timeout	<ul style="list-style-type: none"> <li>No response from server when LOGO! is establishing TCP/TLS connection with it.</li> <li>Server is not accessible</li> </ul>	<ul style="list-style-type: none"> <li>Check your network connection.</li> <li>Check if the broker URL is correct.</li> <li>Contact server technical support.</li> </ul>
Server connection error	Error occurs when LOGO! is establishing TCP/TLS connection with server.	Check connection parameters, for example, port, authentication mode, key, certificate.
No reply from MQTT broker	Server's MQTT service is unavailable.	Contact server technical support.
Failed to send data to MQTT broker	Cloud connection with MQTT broker is interrupted when LOGO! is sending data.	Check your network connection.
Failed to receive data from MQTT broker	<ul style="list-style-type: none"> <li>Cloud connection with MQTT broker is interrupted when LOGO! is receiving data.</li> <li>Received data is invalid, for example, packet format error, unrecognizable packet type.</li> </ul>	<ul style="list-style-type: none"> <li>Check your network connection.</li> <li>Check server configuration.</li> </ul>
Unacceptable protocol version	The server does not support the level of the MQTT protocol requested by the client.	Check if the server supports MQTT 3.1/3.1.1 protocol.
Identifier rejected	The client identifier is UTF-8 which is not supported by the server.	Contact server technical support.
Server unavailable	The network is connected but MQTT services is unavailable.	Contact server technical support.
Bad user name or password	The data in the user name or password is malformed.	<ul style="list-style-type: none"> <li>Check if user name and password are correct.</li> <li>Contact server technical support.</li> </ul>
Not authorized	The client is not authorized to connect.	Check if user name and password are provided.
Data from MQTT broker is too long	Data received from the server is malformed or too long.	<ul style="list-style-type: none"> <li>Check if data sent from the server is valid.</li> <li>Contact server technical support.</li> </ul>

## Abbreviations

AM	Analog module
B1	Block number B1
C	LOGO! device designation: integrated clock
Cnt	Count = Counter input
Dir	Direction (of count, for example)
DM	Digital Module
E	LOGO! device designation: integrated Ethernet interface
En	Enable = switching on (for example, clock generators)
Fre	Input for frequency signals to be analyzed
GF	Basic Functions
Inv	Input for inverting the output signal
DL	Data Log
NAI	Network analog input
NAQ	Network analog output
NI	Network input
No	Cam (parameter of the timer)
NQ	Network output
o	In LOGO! designations: without display
Par	Parameter
R	Reset input
R	In LOGO! designations: Relay outputs
Ral	Reset all = Input for resetting all internal values
S	Set (latching relay, for example)
SF	Special functions
T	Time = parameter
TDE	Text Display with Ethernet interfaces
Trg	Trigger (parameter)
UDF	User-Defined Function
OBA8 device	The latest LOGO! Basic Module version, described in this manual

# Index

## A

Approval  
  CCCEX, 30  
  FM, 29

## B

Backlight flags, 133  
Basic functions  
  AND, 136  
  AND, with edge, 137  
  NAND, 138  
  NAND, with edge, 138  
  NOT, 141  
  OR, 139  
  XOR, 141  
Basics on special functions, 142  
Block number, 67  
Blocks, 65

## C

CCCEX, 30  
Certification and approvals  
  CE label, 27  
  cFMus, 27  
  C-tick label, 28  
  cULus, 27  
  KCC label, 28  
Ch by Ch ticking, 217  
Character set flag, 133  
Character sets, 213  
Circuit protection, 46  
Compatibility, 37  
Connectors, 64  
Constants and connectors, 130  
Counters  
  operating hours, 189  
  threshold trigger, 193  
  Up/down, 186

## D

Data log, 284

Days of the week, 174  
Demo versions, 336  
Device QR code, 19  
Digital nameplate, 26  
DIN rail, 38  
Display modules, 17

## E

EAC, 30  
Error event diagnostics, 118  
Ethernet interface, 57  
Expansion modules, 17

## F

Factory reset, 332  
Flag blocks, 132  
FM, 29  
Formatting micro SD cards, 300

## G

Gain, 145  
GB-2312, 213

## H

Hysteresis, 204

## I

ID link, 26  
Inputs  
  analog inputs, 131  
  cursor keys, 134  
  digital inputs, 130  
  inverting, 135, 147  
  TDE function keys, 134  
Installation and removal  
  DIN rail mounting, 40  
  LOGO! TDE, 43  
  wall-mounting, 42  
integer array, 277  
Internet support, 8  
Inverter, 141

ISO8859-1, 213  
 ISO8859-16, 213  
 ISO8859-5, 213  
 ISO8859-9, 213

## J

JSON document, 275

## L

Latching relay, 210, 210  
 LED, 366  
 Ln by Ln ticking, 217  
 Logical inputs, 142  
 LOGO! 8 network setup, 33  
 LOGO! security
 

- menu access protection, 72
- Network security, 311
- Program copy protection, 314
- program password protection, 84

 LOGO! software, 334  
 LOGO! structure, 19  
 LOGO! TDE, 23
 

- backlight lifetime, 362
- display lifetime, 362
- function keys, 17
- LCD lifetime, 362
- menus, 17
- power-up screen, 17

 LOGO! versions, 24

## M

Master/slave mode, 116  
 Maximum switched current, 55  
 Memory space, 126  
 Message ticking, 216  
 Mounting position, 39  
 MQTT broker, 268

## N

Network I/O, 134  
 NTP, 108

## O

On-/Off-times, 174  
 On-delay, 152

LOGO!

System Manual, 08/2024, A5E33039675-AM

Open connectors, 134  
 Operating states
 

- LOGO! Base Modules, 61
- LOGO! expansion modules, 61

 Outputs
 

- analog outputs, 132
- digital outputs, 132

 Overflow error, 242

## P

Parameter assignment mode, 286  
 Parameter inputs, 143  
 Parameter protection, 144  
 PC-LOGO mode, 336  
 Program cycle, 363  
 Program name
 

- change, 84

 Program password
 

- assign, 85
- change, 86
- deactivate, 87

 Programming mode, 77  
 Public Cloud, 268  
 Pulse relay, 211

## R

Recycling and disposal, 333  
 Relay outputs, 358  
 Retentivity, 144

## S

Secure Cloud connection, 273  
 Sensor connections, 50  
 Setting default values
 

- AI number, 298
- clock, 293
- contrast and backlight, 295
- menu language, 297
- start screen, 298

 Setup with different voltage classes, 36  
 SF, 142, 147  
 Shift register bits, 134  
 Shift-JIS, 213  
 Signal status transitions, 49  
 soft keyboard
 

- character set, 76

 Soft keyboard, 75

Special functions, 147  
  Analog amplifier, 208  
  Analog comparator, 201  
  Analog differential trigger, 199  
  Analog filter, 244  
  Analog multiplexer, 226  
  Analog ramp, 228  
  Analog threshold trigger, 196  
  Analog watchdog, 205  
  Astronomical clock, 181  
  Asynchronous pulse generator, 164  
  Average value, 249  
  Basics, 142  
  Edge-triggered wiping relay, 162  
  Float/Integer Converter, 251  
  Hours counter, 189  
  Integer/Float Converter, 253  
  Latching relay, 210  
  Mathematic instruction, 239  
  Mathematic instruction error detection, 242  
  Max/Min, 246  
  Message texts, 212  
  Multiple function switch, 170  
  Off-delay, 155  
  On-/off- delay, 157  
  On-delay, 152  
  PI controller, 232  
  Pulse relay, 211  
  Pulse Width Modulator (PWM), 236  
  Random generator, 166  
  Relays, 210, 211  
  Retentive on-delay, 159  
  Shift register, 224  
  Softkey, 222  
  Stairway lighting switch, 168  
  Stopwatch, 183  
  Threshold trigger, 193  
  Up-down counter, 186  
  Weekly timer, 173  
  Wiping relay, 160  
  Yearly timer, 176  
Startup flag, 133  
Summertime/wintertime conversion, 105  
Supported operating systems, 335  
Switch to RUN mode, 89

## T

Thing, 275  
Time response, 143  
Timebase, 143, 153  
Timer accuracy, 144

## Timers

Astronomical clock, 181  
Asynchronous pulse generator, 164  
Edge-triggered wiping relay, 162  
Multiple function switch, 170  
Off-delay, 155  
On-/off- delay, 157  
On-delay, 152  
Random generator, 166  
Retentive on-delay, 159  
Stairway lighting switch, 168  
Stopwatch, 183  
Weekly timer, 173  
Wiping relay (pulse output), 160  
Yearly timer, 176  
Timing inaccuracy, 144  
Troubleshooting, 382

## U

UKCAI, 29  
User-Defined Function (UDF), 280

## V

Voltage levels, 134

## W

Web server, 257  
  logon, 260  
  logout, 267  
Weekly timer  
  examples, 175  
  setting, 175  
Wire ferrules, 44

## Z

Zero division error, 242  
Zero offset, 145