

**SIEMENS**

*Ingenuity for life*

24/7

NEWS

Industry Online Support

Home

# Basic Positioner (EPos) in SINAMICS V90 PN

SINAMICS V90 PROFINET Version

<https://support.industry.siemens.com/cs/ww/en/view/109747750>

Siemens  
Industry  
Online  
Support



## Warranty and liability

### Note

The Application Examples are not binding and do not claim to be complete regarding the circuits shown, equipping and any eventuality. The Application Examples do not represent customer-specific solutions. They are only intended to provide support for typical applications. You are responsible for ensuring that the described products are used correctly. These Application Examples do not relieve you of the responsibility to use safe practices in application, installation, operation and maintenance. When using these Application Examples, you recognize that we cannot be made liable for any damage/claims beyond the liability clause described. We reserve the right to make changes to these Application Examples at any time without prior notice.

If there are any deviations between the recommendations provided in these Application Examples and other Siemens publications – e.g. Catalogs – the contents of the other documents have priority.

We do not accept any liability for the information contained in this document. Any claims against us – based on whatever legal reason – resulting from the use of the examples, information, programs, engineering and performance data etc., described in this Application Example shall be excluded. Such an exclusion shall not apply in the case of mandatory liability, e.g. under the German Product Liability Act (“Produkthaftungsgesetz”), in case of intent, gross negligence, or injury of life, body or health, guarantee for the quality of a product, fraudulent concealment of a deficiency or breach of a condition which goes to the root of the contract (“wesentliche Vertragspflichten”). The damages for a breach of a substantial contractual obligation are, however, limited to the foreseeable damage, typical for the type of contract, except in the event of intent or gross negligence or injury to life, body or health. The above provisions do not imply a change of the burden of proof to your detriment.

Any form of duplication or distribution of these Application Examples or excerpts hereof is prohibited without the expressed consent of the Siemens AG.

### Security information

Siemens provides products and solutions with industrial security functions that support the secure operation of plants, systems, machines and networks. In order to protect plants, systems, machines and networks against cyber threats, it is necessary to implement – and continuously maintain – a holistic, state-of-the-art industrial security concept. Siemens’ products and solutions only form one element of such a concept.

Customer is responsible to prevent unauthorized access to its plants, systems, machines and networks. Systems, machines and components should only be connected to the enterprise network or the internet if and to the extent necessary and with appropriate security measures (e.g. use of firewalls and network segmentation) in place.

Additionally, Siemens’ guidance on appropriate security measures should be taken into account. For more information about industrial security, please visit <http://www.siemens.com/industrialsecurity>.

Siemens’ products and solutions undergo continuous development to make them more secure. Siemens strongly recommends to apply product updates as soon as available and to always use the latest product versions. Use of product versions that are no longer supported, and failure to apply latest updates may increase customer’s exposure to cyber threats.

To stay informed about product updates, subscribe to the Siemens Industrial Security RSS Feed under <http://www.siemens.com/industrialsecurity>.

# Table of contents

	<b>Warranty and liability.....</b>	<b>2</b>
<b>1</b>	<b>Task.....</b>	<b>4</b>
	1.1 Overview.....	4
<b>2</b>	<b>Solution.....</b>	<b>5</b>
	2.1 Solution overview .....	5
	2.2 Hardware and Software Components .....	6
	2.2.1 Validity .....	6
	2.2.2 Used Components.....	6
<b>3</b>	<b>Basics .....</b>	<b>7</b>
	3.1 Basics regarding SINAMICS V90 PN version .....	7
	3.2 Installation and startup .....	8
	3.2.1 Hardware installation.....	8
	3.2.2 Trial-run .....	8
<b>4</b>	<b>Configuration .....</b>	<b>9</b>
	4.1 Configurations via V-ASSISTANT .....	9
	4.2 Configurations via TIA Portal V14 .....	13
<b>5</b>	<b>Operation of the application.....</b>	<b>18</b>
	5.1 Scenario A (with FB284) .....	18
	5.1.1 Function block SINA_POS (FB284) .....	18
	5.1.2 Operations .....	22
<b>6</b>	<b>Appendix .....</b>	<b>29</b>
	6.1 Service and Support.....	29
	6.2 Links and Literature .....	30
	6.3 Contact .....	30
	6.4 History .....	30



# 1 Task

## 1.1 Overview

### Introduction

Basic positioner (EPos) is one of the two basic control modes for SINAMICS V90 PROFINET version. In this manual, the basic application of the basic positioner (EPos) in SINAMICS V90 PN will be described in detail.

### Overview of the automation task

The figure below provides an overview of the automation task.

Figure 1-1

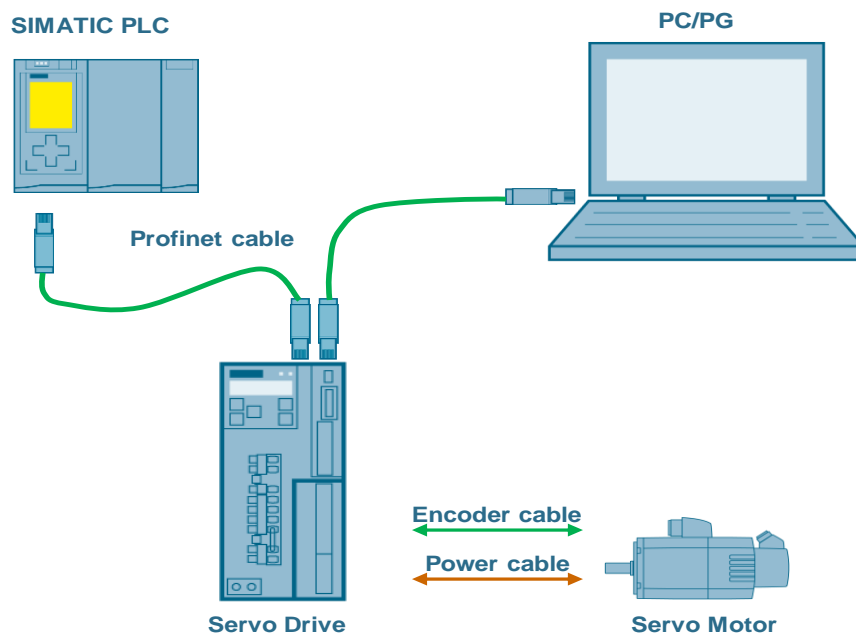

## 2 Solution

### 2.1 Solution overview

#### Schema Display

The following figure displays the most important components of the solution:

Figure 2-1

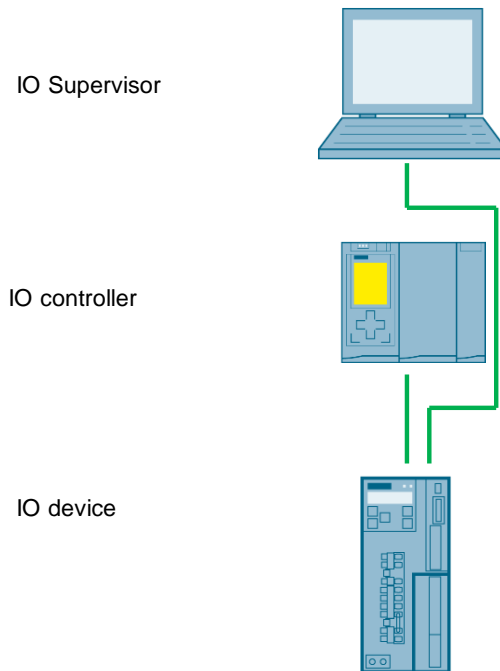

#### Delimitation

This application does not include a description of

- PROFINET communication
- SINAMICS V90 PN version
- BOP operation

Basic knowledge of these topics is assumed.

#### Required knowledge

Basic knowledge on TIA Portal is assumed.

## 2.2 Hardware and Software Components

### 2.2.1 Validity

This application example is valid for

- TIA Portal V14
- S7-1200/1500/300/400 CPU with PN interface
- SINAMICS V90 PN FW V10002.4 or newer
- SIMOTICS S-1FL6 Li motor

### 2.2.2 Used Components

The application was generated with the following components:

#### Hardware components

Table 2-1

Component	No.	Article number	Note
SIMATIC S7-1500 CPU1511 1-PN	1	6ES7511-1AK00-0AB0	V1.7
SINAMICS V90 PN 200V	1	6SL3210-5FB10-1UF0	0.4 kW
SIMOTICS S-1FL6 Li motor	1	1FL6024-2AF21-1AA1	0.4 kW

#### Standard software components

Table 2-2

Component	No.	Article number	Note
TIA Portal	1		V14
SINAMICS V-ASSISTANT	1		V1.05.00.00

#### Sample files and projects

The following list includes all files and projects that are used in this example.

Table 2-3

Component	Note
109747750_V90_EPos_Test_CODE.zip	TIA Project file
109747750_V90_EPos_Test_V-ASSISTANT.zip	SINAMICS V-ASSISTANT Project file
109747750_V90_EPos_DOC_v10_en.pdf	Reference document

## 3 Basics

### 3.1 Basics regarding SINAMICS V90 PN version

#### Supported Telegrams

When SINAMICS V90 PN is working in EPos mode, the following telegrams are supported:

- Standard telegram 7
- Standard telegram 9
- Siemens telegram 110
- Siemens telegram 111

Among these four telegrams, telegram 111 is the factory default telegram and also the mostly frequently used one. **Thus, the Siemens telegram 111 will be used in this basic application.**

#### Number of IO devices

When the basic positioner (EPos mode) is used in SINAMICS V90 PN, number of IO device depends on the number of slaves supported by the controller; for example, SIMATIC S7-1200 supports maximally 16 slaves including the CPU itself.

## 3.2 Installation and startup

### 3.2.1 Hardware installation

The figure below shows the hardware configuration of the application:

**CAUTION** **Wrong wiring can damage the drive!**

In this application, the one phase 230V power supply is used. It is a must for you to check the supply voltage; otherwise, the drive can be damaged!

Figure 3-1

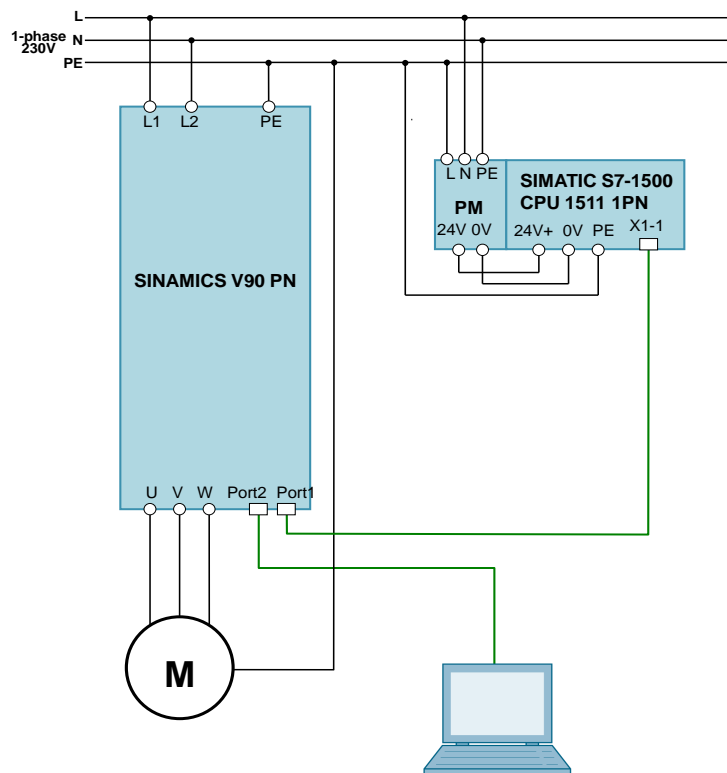

© Siemens AG 2017. All rights reserved.

### 3.2.2 Trial-run

Table 3-1 Trial-run

Nr.	Action	Remarks
1.	Set drive parameter p29108 to be 1.	JOG function is enabled when p29108=1
2.	Switch to JOG menu with drive BOP operation.	
3.	Press ▲ or ▼ button to run the motor.	Check if the motor can run properly.



## 4 Configuration

In this section, the configurations from V-ASSISTANT side as well as from the TIA Portal V14 will be described in details. The used telegram is telegram 111.

### 4.1 Configurations via V-ASSISTANT

Table 4-1 Configurations via V-ASSISTANT

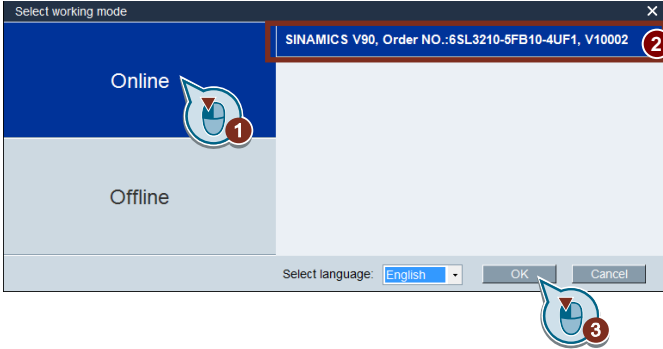
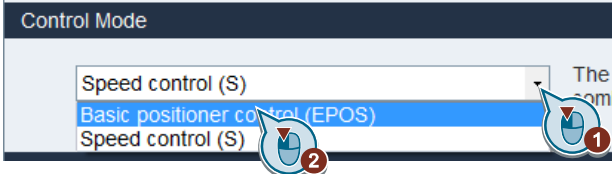
Step	Description
1.	<p><b>Go online with V-ASSISTANT</b></p> <p>Double-click the V-ASSISTANT icon  to start this software:</p>  <ol style="list-style-type: none"> <li>1. Select the <b>“Online”</b> working mode. Normally, the online mode is the default working mode.</li> <li>2. If the USB communication is okay, the drive information will be displayed.</li> <li>3. Click the <b>“OK”</b> button to proceed.</li> </ol>
2.	<p><b>Change control mode</b></p> <p>When the V-ASSISTANT has been successfully connected to SINAMICS V90 servo drive, you need to change the control mode from S mode to EPos mode firstly:</p>  <ol style="list-style-type: none"> <li>1. Open the drop-down list.</li> <li>2. Select <b>“Basic positioner control (EPOS)”</b>.</li> </ol> <p><b>NOTICE:</b> Change of the control mode needs a restart of servo drive, so the parameters must be saved before drive restart.</p>

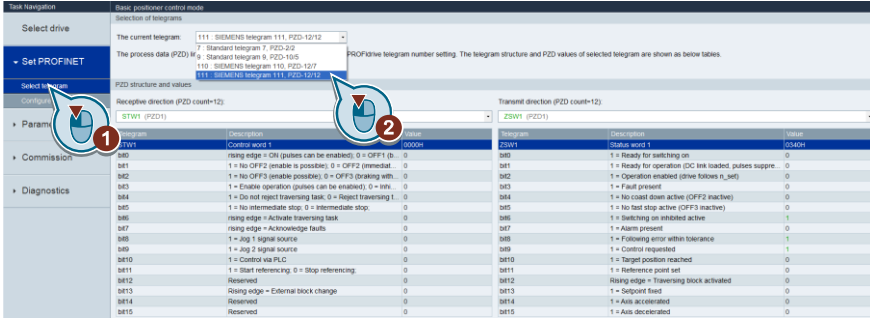
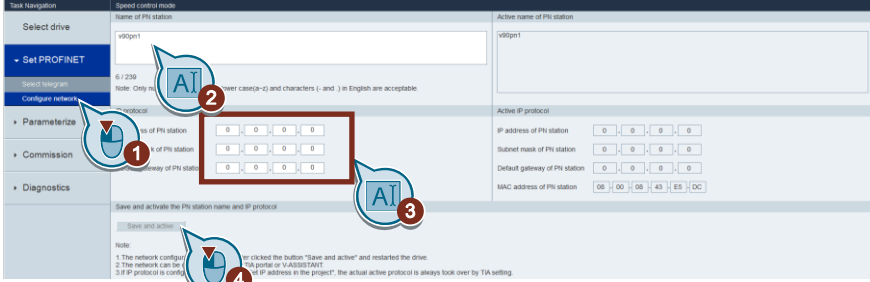
Step	Description
3.	<p><b>Configure telegram</b></p> <p>After successfully switching to EPos mode, you can select the telegram according to actual application:</p>  <ol style="list-style-type: none"> <li>1. Click <b>“Select telegram”</b>.</li> <li>2. Select a telegram from the drop-down list. In this example application document, we will keep the default telegram 111.</li> </ol>
4.	<p><b>Configure network settings</b></p> <p>The following parameters can be configured with the V-ASSISTANT from the PROFINET settings menu field:</p>  <ol style="list-style-type: none"> <li>1. Click <b>“Configure network”</b>.</li> <li>2. Input a device name for SINAMICS V90 PN servo drive currently connected.</li> <li>3. Input valid IP address for the servo drive.</li> <li>4. Click the <b>“Save and active”</b> button.</li> </ol>

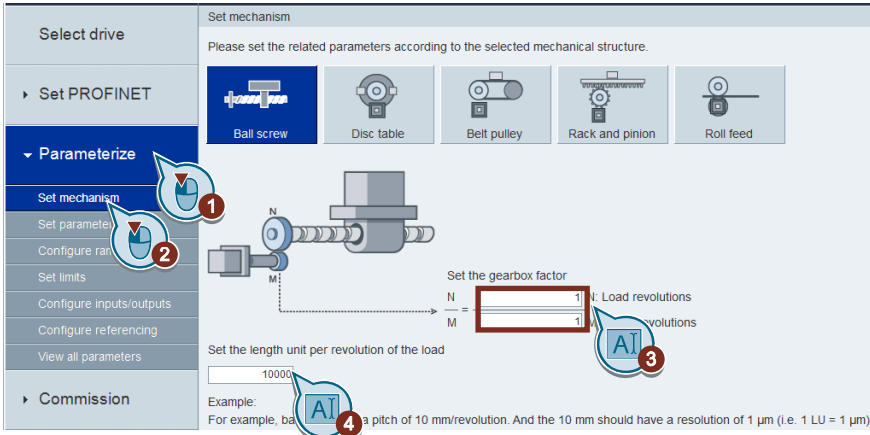
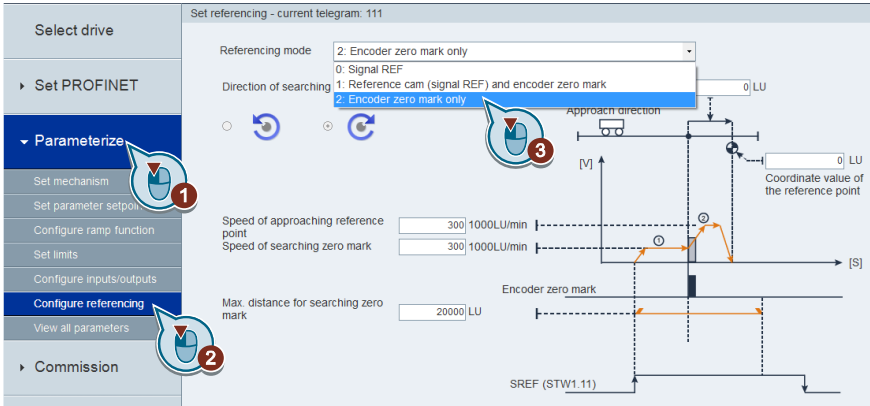
Step	Description
5.	<p><b>Configure mechanism</b> Set relevant mechanism parameters according to actual mechanism system:</p>  <ol style="list-style-type: none"> <li>1. Click <b>"Parameterize"</b>.</li> <li>2. Click <b>"Set mechanism"</b>.</li> <li>3. Set the gearbox. In this example, we will keep default settings.</li> <li>4. Set the length unit per revolution of the load. In this example, we will keep default settings.</li> </ol>
6.	<p><b>Configure referencing</b> Configure the referencing mode:</p>  <ol style="list-style-type: none"> <li>1. Click <b>"Parameterize"</b>.</li> <li>2. Click <b>"Configure referencing"</b>.</li> <li>3. Three referencing modes are available for SINAMICS V90PN working in EPos mode (0: Signal REF; 1: Reference cam and encoder zero mark; 2: Encoder zero mark only). In the example, we will use the third mode (only encoder zero mark).</li> </ol>

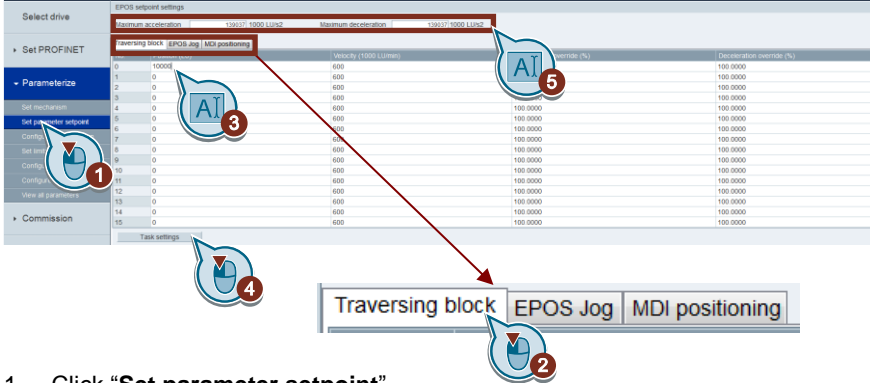
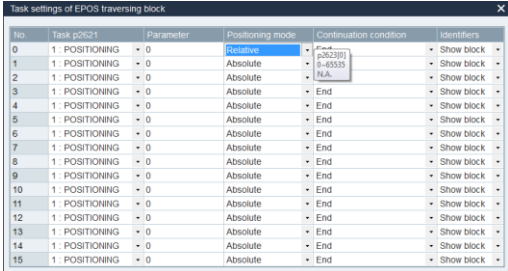
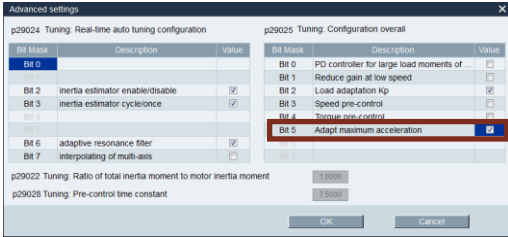
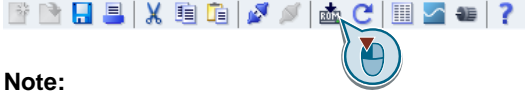
Step	Description
7.	<p><b>Configure setpoint parameters</b></p> <p>Configure setpoint parameters for EPos traversing block, EPos MDI and EPos Jog:</p>  <ol style="list-style-type: none"> <li>1. Click <b>"Set parameter setpoint"</b>.</li> <li>2. Click to switch between the headlines of traversing block, EPos MDI and EPos Jog.</li> <li>3. Input a target position for traversing block 0. In this example, we will use 10000 LU, that's, one motor revolution according to the mechanism configuration. <b>Note:</b> in this example, we will keep the default settings for EPos Jog.</li> <li>4. Click <b>"Task settings"</b> to configure task settings for traversing block 0:</li> </ol>  <p>In this example, we will use relative positioning for traversing block 0.</p> <ol style="list-style-type: none"> <li>5. Configure maximum acceleration/deceleration time in EPos mode. These two values can be calculated automatically by activating bit5 of auto-tuning configuration in advanced setting:</li> </ol> 
8.	<p><b>Save parameter settings into drive ROM</b></p> <p>After finishing above parameter settings, we should save parameter settings into drive ROM by clicking the <b>"Save parameters into ROM"</b> button:</p>  <p><b>Note:</b> You can also perform other configurations like torque limit, DI/DO, etc. according to actual application. Please refer to SINAMICS V90 PN Operating Instruction for more details: <a href="https://support.industry.siemens.com/cs/ww/en/view/109742518">https://support.industry.siemens.com/cs/ww/en/view/109742518</a></p>

## 4.2 Configurations via TIA Portal V14

Table 4-2 Configurations via TIA Portal V14

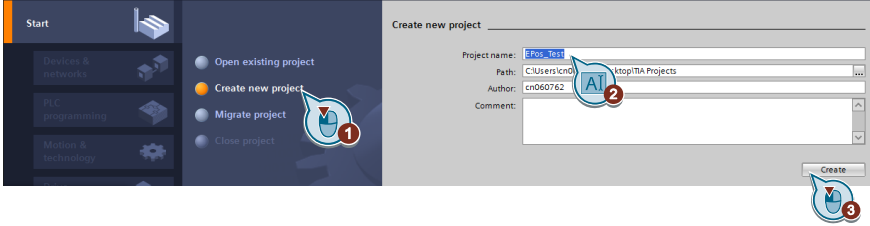
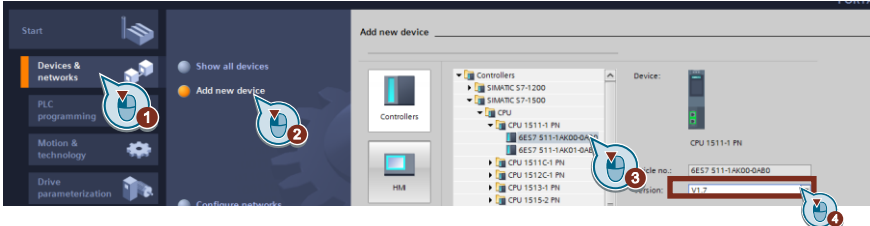
Step	Descriptions
1.	<p><b>Create a new project</b> Open TIA Portal V14 and create a new project:</p>  <ol style="list-style-type: none"> <li>1. Click <b>“Create new project”</b>.</li> <li>2. Input a name for this newly created project; for example, <b>“EPos_Test”</b>.</li> <li>3. Click <b>“Create”</b> button.</li> </ol>
2.	<p><b>Add PLC into project</b></p>  <ol style="list-style-type: none"> <li>1. Click <b>“Devices &amp; networks”</b>.</li> <li>2. Click <b>“Add new device”</b>.</li> <li>3. Find the target PLC.</li> <li>4. Select the PLC FW version.</li> </ol>

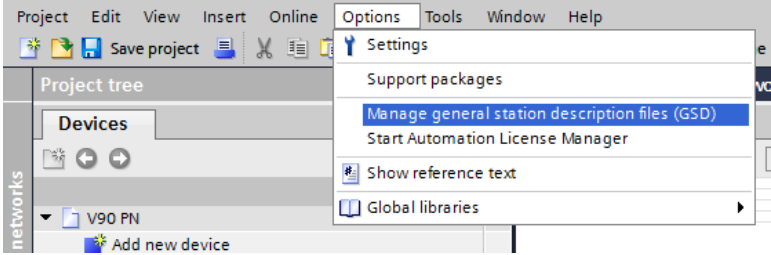
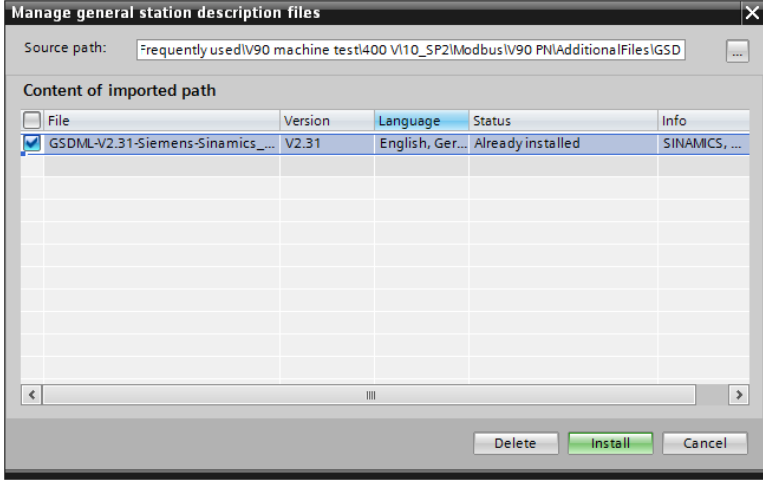
Step	Descriptions
3.	<p><b>Install V90PN GSD file into TIA Portal</b></p> <ol style="list-style-type: none"> <li>Click menu “Options” → “Manage general station description (GSD)”.                      </li> <li>Find the GSD file and install it.                      </li> </ol> <p><b>Note:</b>                      The latest V90PN GSD file can be found from the link below:  <a href="http://support.automation.siemens.com/WW/view/en/109737269">http://support.automation.siemens.com/WW/view/en/109737269</a></p>

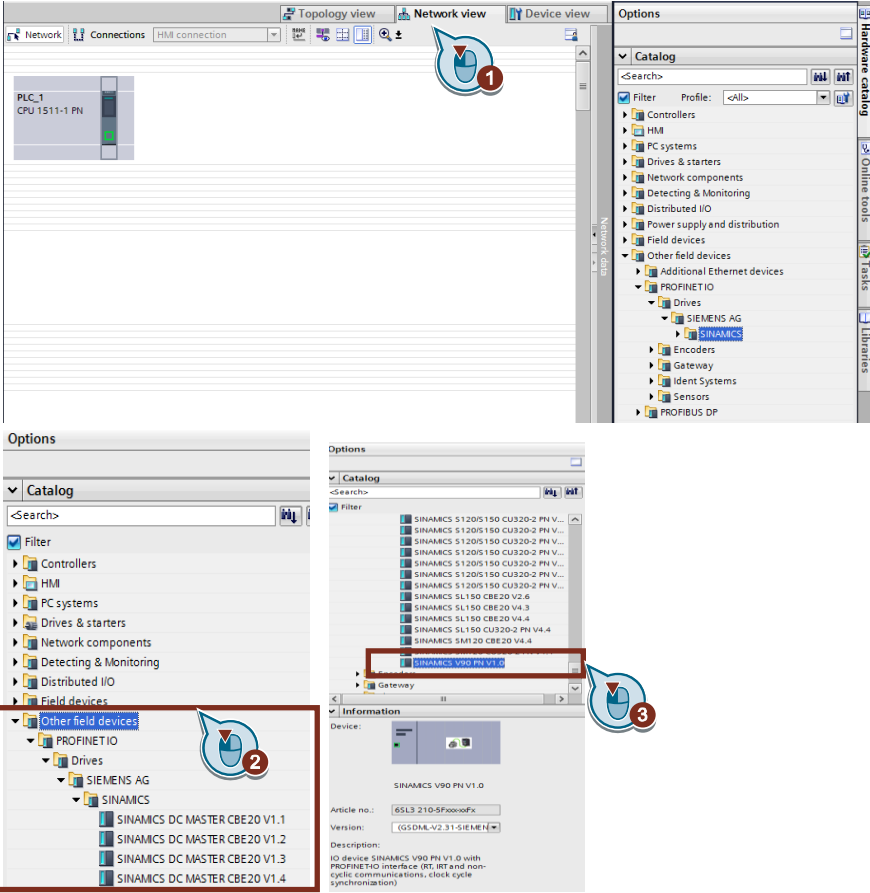
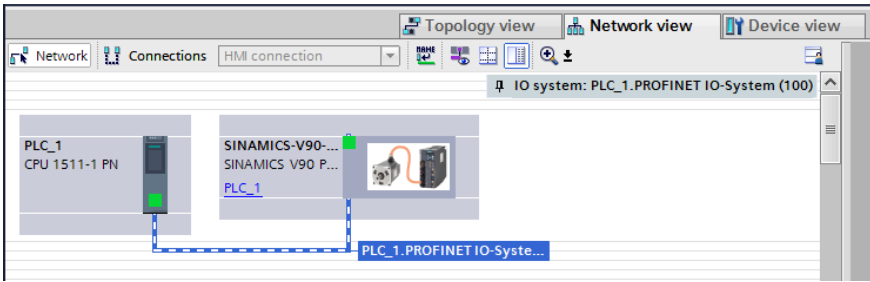

Step	Descriptions
4.	<p><b>Insert V90PN into project</b></p>  <ol style="list-style-type: none"> <li>1. Click <b>"Network view"</b> tab to switch to <b>"Network view"</b>.</li> <li>2. In the <b>"Hardware Catalog"</b>, click <b>"Other field devices"</b> → <b>"PROFINET IO"</b> → <b>"Drives"</b> → <b>"SIEMENS AG"</b> → <b>"SINAMICS"</b> → <b>"SINAMICS V90 PN V1.0"</b>.</li> <li>3. Double-click the V90 PN node or drag it to the network view.</li> </ol>
5.	<p><b>Connect SINAMICS V90PN to SIMATIC PLC</b></p> <p>Establish the connection between SINAMICS V90 PN and SIMATIC PLC:</p> 

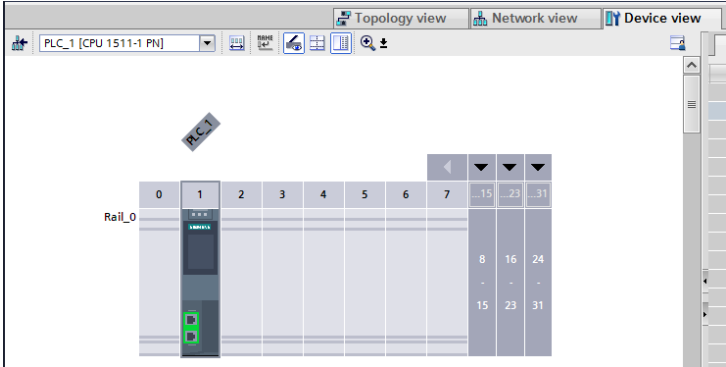
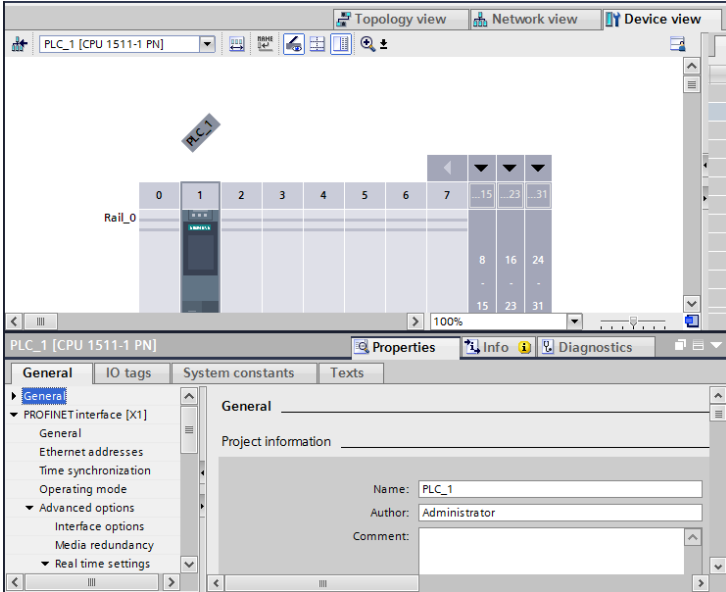
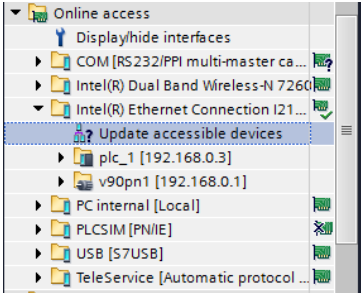
Step	Descriptions
6.	<p><b>Make device configurations for SIMATIC PLC</b></p> <ol style="list-style-type: none"> <li>In the “Network view”, double-click PLC to enter the device view of SIMATIC PLC:</li> </ol>  <ol style="list-style-type: none"> <li>Double-click PLC to open the property view of SIMATIC PLC:</li> </ol>  <p>Configure PLC properties like device name, ethernet address...</p> <p><b>Note:</b> You can also use the “Online access” to find the accessible device and make sure the information is consistent:</p> 

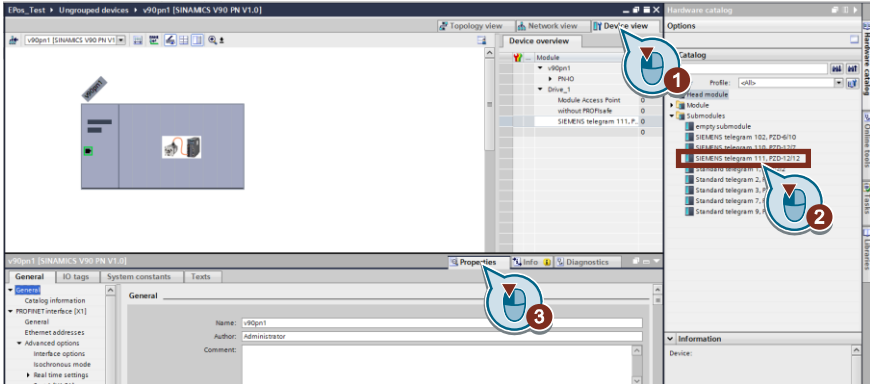
Step	Descriptions
7.	<p><b>Make device configurations for SINAMICS V90PN</b></p>  <ol style="list-style-type: none"> <li>1. Click the <b>“Device view”</b> tab to switch to device view.</li> <li>2. Select telegram 111 from the submodule for SINAMICS V90PN.</li> <li>3. Double-click the servo drive and configure properties of SINAMICS V90PN in the property view.</li> </ol> <p><b>Note:</b> You can also use the <b>“Online access”</b> to find the accessible device and make sure the information is consistent.</p>

# 5 Operation of the application

## 5.1 Scenario A (with FB284)

In the following paragraph, we will use the function block FB284 (SINA\_POS) to perform the operations of SINAMICS V90 PN with EPos (basic positioner).

### 5.1.1 Function block SINA\_POS (FB284)

**NOTICE** Standard telegram 111 must be selected for the communication when configuring the SINAMICS drive.

For more information about the function block SINA\_POS, please refer to the manual about SINAMICS function blocks. The latest version of this manual is available at the link below:

<https://support.industry.siemens.com/cs/ww/en/view/109475044>

The SINA\_XXX function blocks are delivered with the actual Startdrive software package or in a separate download.

Figure 5-1 SINA\_POS (FB284)

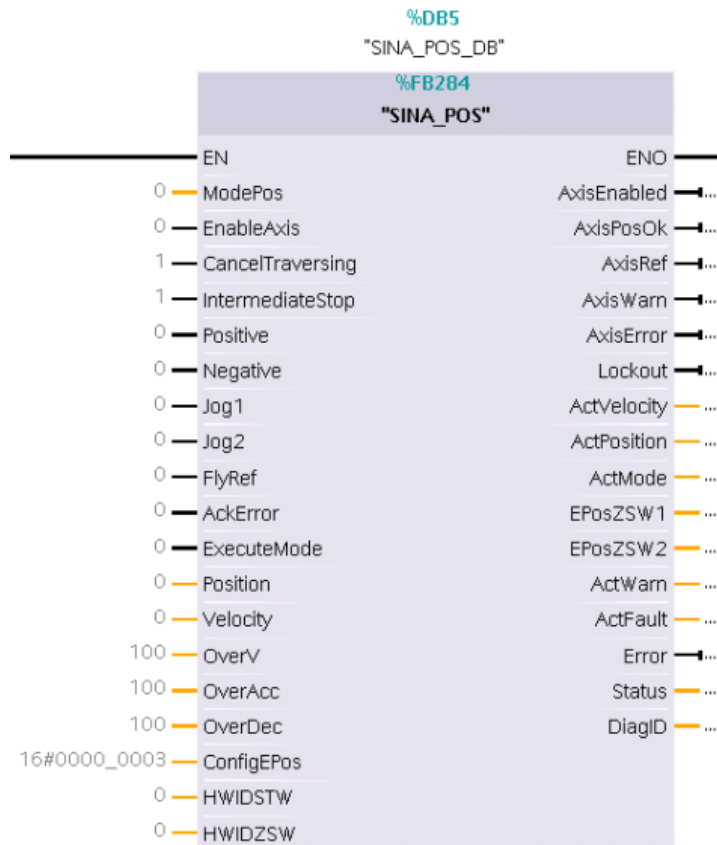

### Input interface of SINA\_POS

The input interface consists of 19 inputs with various data formats.

When the function block is first configured, the inputs are set up with initial values. An overview of the input interface is subsequently shown as follows:

Table 5-1 Input interface of SINA\_POS

Input signal	Type	Default	Meaning
ModePos	INT	0	Operating mode: 1 = relative positioning 2 = absolute positioning 3 = positioning as setup 4 = approach reference point 5 = set reference point 6 = traversing block 0~15 7 = Jog mode 8 = incremental jogging
EnableAxis	BOOL	0	Switching command: 0=OFF, 1=ON
CancelTraversing	BOOL	1	0 = reject active traversing task, 1 = do not reject
IntermediateStop	BOOL	1	0 = active traversing command is interrupted, 1 = no intermediate stop
Positive	BOOL	0	Positive direction
Negative	BOOL	0	Negative direction
Jog1	BOOL	0	Jog signal source 1
Jog2	BOOL	0	Jog signal source 2
FlyRef	BOOL	0	0 = deselect flying referencing, 1 = select flying referencing <b>Note:</b> Currently flying referencing is not supported by SINAMICS V90 PN.
AckError	BOOL	0	Acknowledging errors
ExecuteMode	BOOL	0	Activate traversing task / setpoint activate reference function
Position	DINT	0[LU]	Position setpoint in [LU] for direct setpoint input/ MDI mode OR traversing block number for traversing block mode
Velocity	DINT	0[1000 LU/min]	Velocity in [1000 LU/min] for MDI mode
OverV	INT	100[%]	Velocity override active for all modes: 0-199%
OverAcc	INT	100[%]	Acceleration override active 0-100%
OverDec	INT	100[%]	Deceleration override active 0-100%

Input signal	Type	Default	Meaning
ConfigEPos	DWORD	3h	<p>With this interface, the following bit functions of telegram 111 can be transmitted:</p> <ul style="list-style-type: none"> <li>Bit0 = STW1.1 (OFF2: 1 = no pulse inhibit)</li> <li>Bit1 = STW1.2 (OFF3: 1 = no pulse inhibit)</li> <li>Bit2 = EPosSTW2.14 (Software limit switch: 1 = active)</li> <li>Bit3 = EPosSTW2.15 (Stop output cam: 1 = active)</li> <li>Bit4 = EPosSTW2.11 (reserved)</li> <li>Bit5 = EPosSTW2.10 (reserved)</li> <li>Bit6 = EPosSTW2.2 (signal source reference mark)</li> <li>Bit7 = STW1.13 (External block change)</li> <li>Bit8 = EPosSTW1.12 (continuous setpoint transfer MDI: 1 = active)</li> <li>Bit9 = STW2.0 (reserved)</li> <li>Bit10 = STW2.1 (reserved)</li> <li>Bit11 = STW2.2 (reserved)</li> <li>Bit12 = STW2.3 (reserved)</li> <li>Bit13 = STW2.4 (reserved)</li> <li>Bit14 = STW2.7 (reserved)</li> <li>Bit15 = STW1.14 (reserved)</li> <li>Bit16 = STW1.15 (reserved)</li> <li>Bit17 = EPosSTW1.6 (reserved)</li> <li>Bit18 = EPosSTW1.7 (reserved)</li> <li>Bit19 = EPosSTW1.11 (reserved)</li> <li>Bit20 = EPosSTW1.13 (reserved)</li> <li>Bit21 = EPosSTW2.3 (reserved)</li> <li>Bit22 = EPosSTW2.4 (reserved)</li> <li>Bit23 = EPosSTW2.6 (reserved)</li> <li>Bit24 = EPosSTW2.7 (reserved)</li> <li>Bit25 = EPosSTW2.12 (reserved)</li> <li>Bit26 = EPosSTW2.13 (reserved)</li> <li>Bit27 = STW2.5 (reserved)</li> <li>Bit28 = STW2.6 (reserved)</li> <li>Bit29 = STW2.8 (travel to fixed endstop: 1 = active)</li> <li>Bit30 = STW2.9 (reserved)</li> </ul>
HWIDSTW	HW_IO	0	Symbolic name or HW ID/IO address on the SIMATIC S7-1x00/300/400 of the setpoint slot
HWIDZSW	HW_IO	0	Symbolic name or HW ID/IO address on the SIMATIC S7-1x00/300/400 of the setpoint slot



### Output signal of SINA\_POS

The output interface consists of 16 outputs with various data formats.

When the block is first configured, the outputs are set up with initial values. The following is an overview of the output interface:

Table 5-2 Output signal of SINA\_POS

Output signal	Type	Default	Meaning
AxisEnabled	BOOL	0	Drive is ready and switched on
AxisPosOk	BOOL	0	Target position of the axis reached
AxisRef	BOOL	0	Reference point set
AxisWarn	BOOL	0	Drive has alarm
AxisError	BOOL	0	Drive has fault
Lockout	BOOL	0	Switching-on inhibit
ActcVelocity	DINT	0	Actual velocity (scaled 40000000h = 100% x p2000)
ActPosition	DINT	0[LU]	Actual position in LU
ActMode	INT	0	Currently active mode
EPosZSW1	WORD	0	Status of EPos ZSW1 (bit-granular)
EPosZSW2	WORD	0	Status of EPos ZSW2 (bit-granular)
ActWarn	WORD	0	Actual alarm number
ActFault	WORD	0	Actual fault active
Error	BOOL	0	1 = group fault active
Status	INT	0	<ul style="list-style-type: none"> <li>• 16#7002: No fault – block is being executed</li> <li>• 16#8401: Drive fault</li> <li>• 16#8402: Switching-on inhibit</li> <li>• 16#8403: flying referencing could not be started</li> <li>• 16#8600: Error DPRD_DAT</li> <li>• 16#8601: Error DPWR_DAT</li> <li>• 16#8202: incorrect operating mode selected</li> <li>• 16#8203: incorrect setpoints parameterized</li> <li>• 16#8204: incorrect traversing block number selected</li> </ul>
DiagID	WORD	0	Extended communication error → error during SFB call

5.1.2 Operations

Table 5-3 Operations

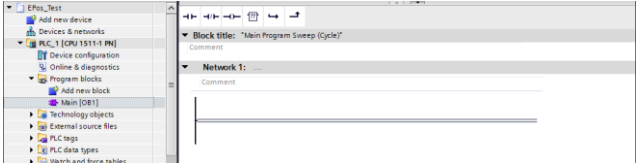
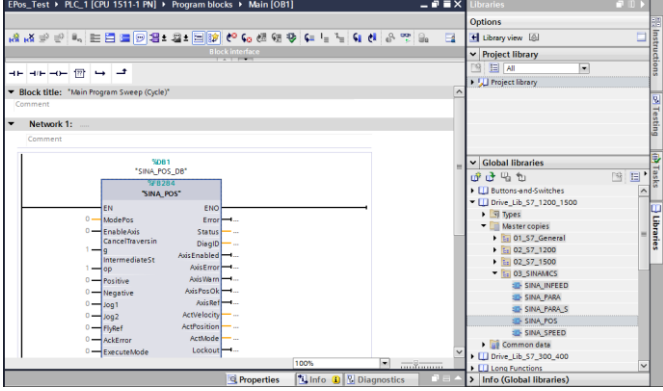
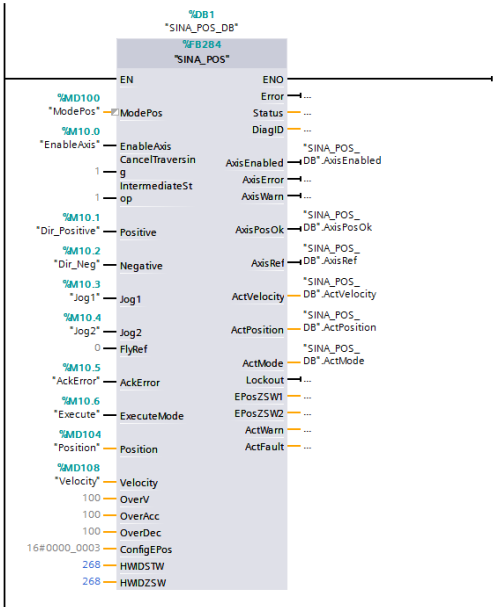
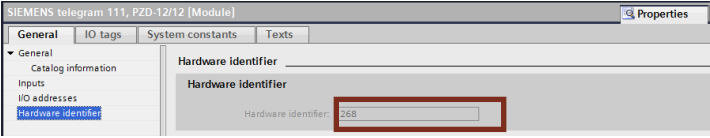
Step	Descriptions
1.	<p><b>Make PLC programming</b></p> <ol style="list-style-type: none"> <li data-bbox="480 376 1018 409">Open program view by clicking "Main [OB1]":</li> </ol>  <ol style="list-style-type: none"> <li data-bbox="480 577 1066 611">Find SINA_POS and add it into the main program:</li> </ol>  <ol style="list-style-type: none"> <li data-bbox="480 1003 858 1037">Make programming as follows:</li> </ol>  <p><b>Note:</b></p> <p>The Hardware IDs (HWIDSTW and HWIDZSW) are the same and refer to the Hardware Identifier of communication telegram. Such information can be found in the properties of the communication telegram as follows:</p> 

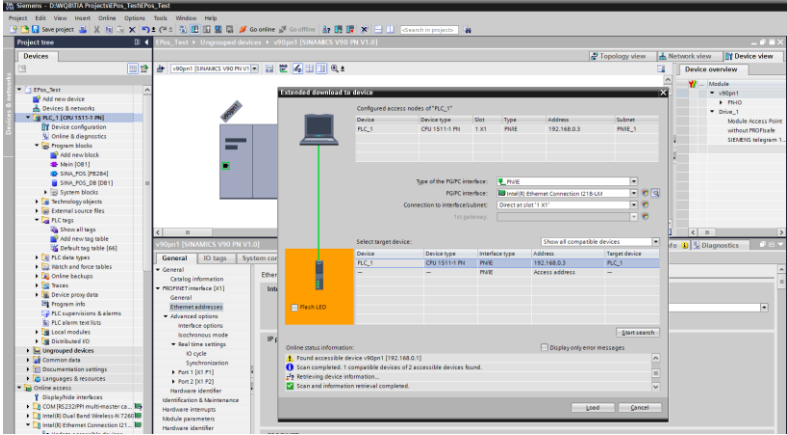
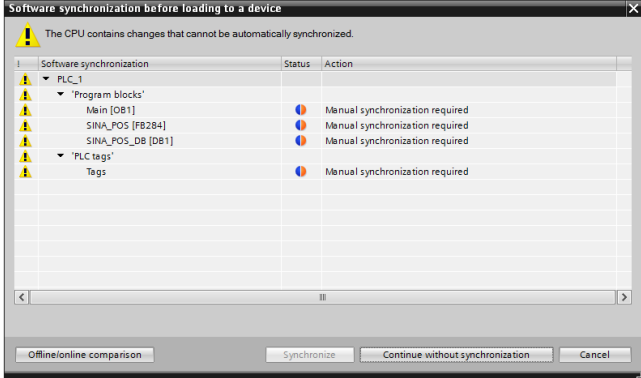
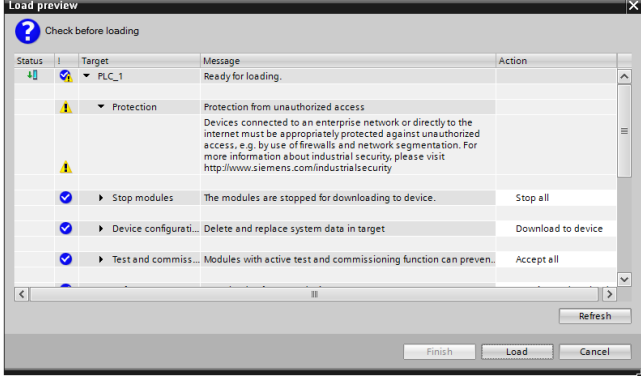
Step	Descriptions
2.	<p><b>Compile the project and download it into PLC CPU</b></p> <ol style="list-style-type: none"> <li>1. Compile the project by clicking the “Compile” button.</li> <li>2. Download the project into PLC CPU</li> </ol>   

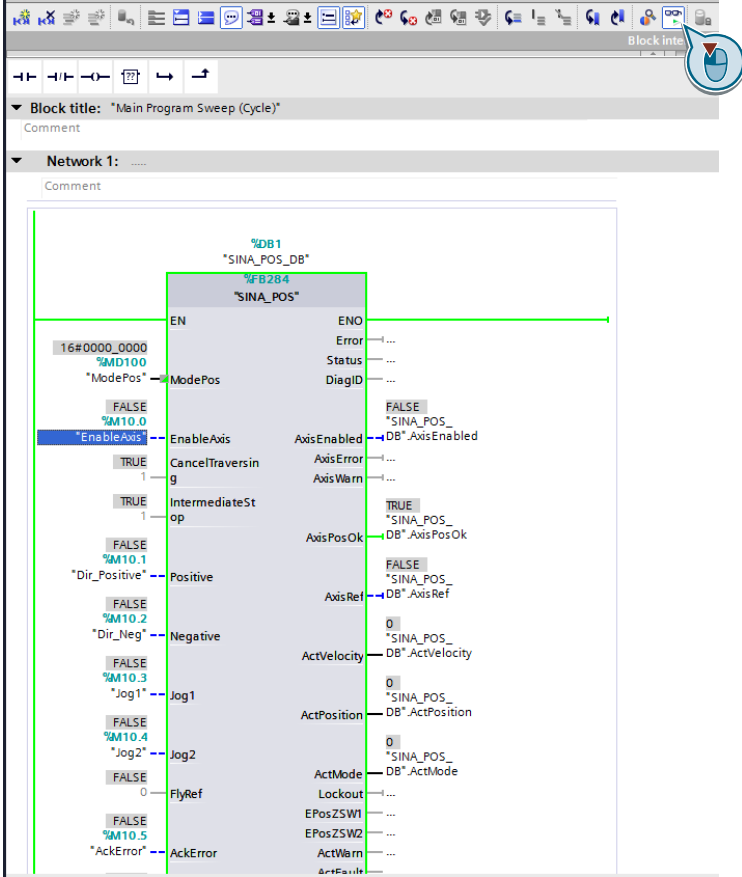
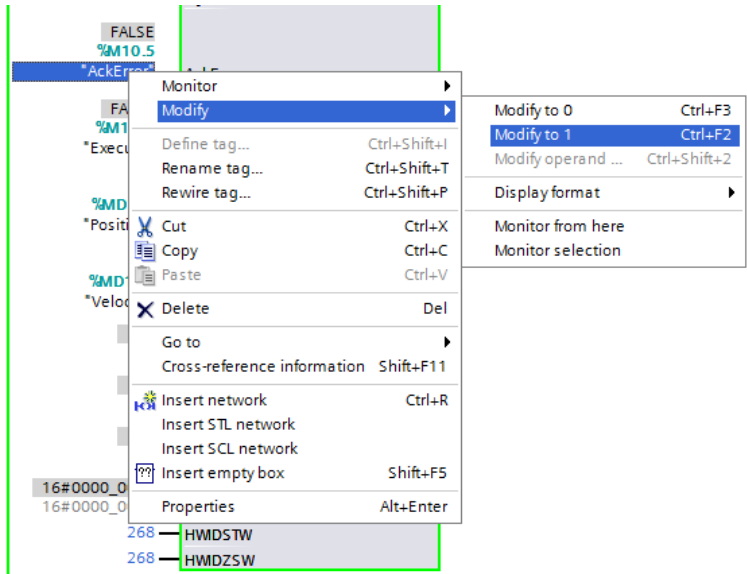
Step	Descriptions
<p>3.</p>	<p><b>Activate program monitoring</b></p> <ol style="list-style-type: none"> <li>Switch to the view of main program.</li> <li>Press the monitoring button to activate program monitoring.</li> </ol> 
<p>4.</p>	<p><b>Clear faults</b> Clear faults with M10.5 (AckError) = 1.</p> 

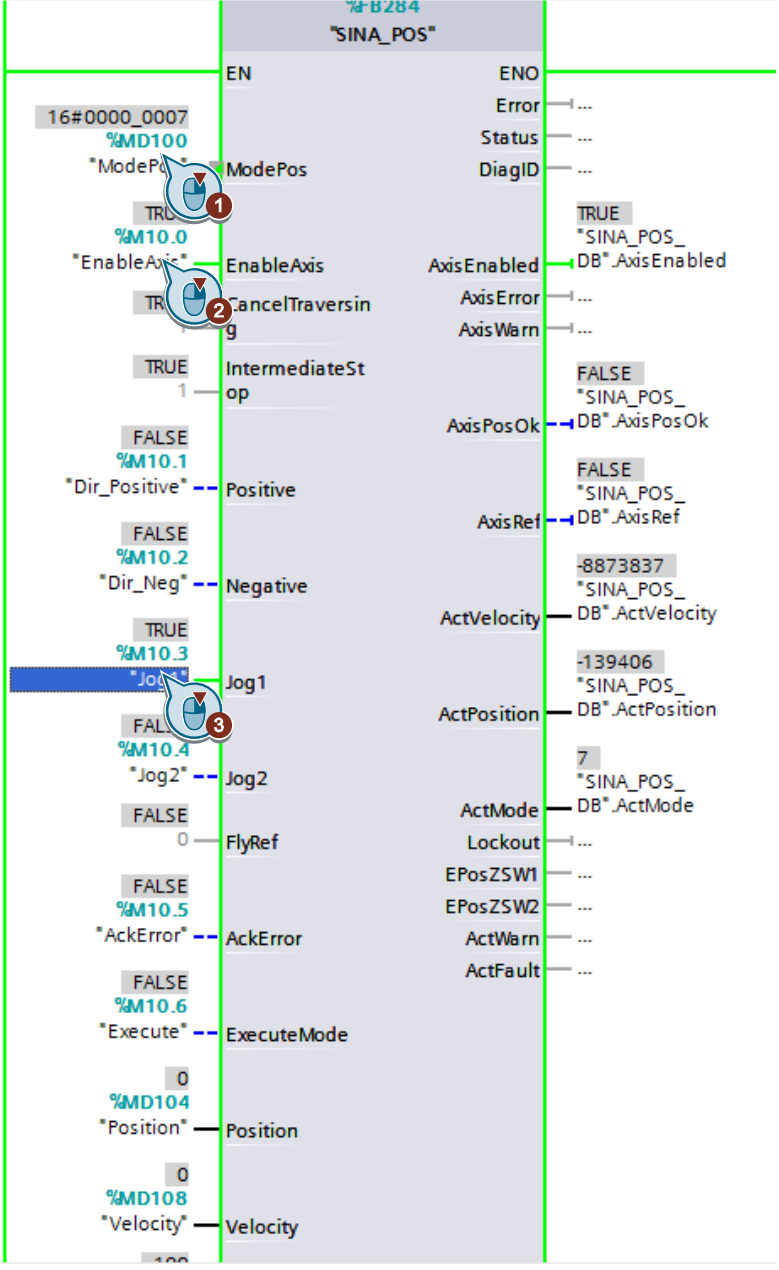
Step	Descriptions
5.	<p><b>Jog</b></p>  <p>16#0000_0007 %MD100 "ModePos" ModePos</p> <p>TRU %M10.0 "EnableAxis" EnableAxis</p> <p>TR CancelTraversin g</p> <p>TRUE 1 IntermediateSt op</p> <p>FALSE %M10.1 "Dir_Positive" Positive</p> <p>FALSE %M10.2 "Dir_Neg" Negative</p> <p>TRUE %M10.3 "Jog1" Jog1</p> <p>FAL %M10.4 "Jog2" Jog2</p> <p>FALSE 0 FlyRef</p> <p>FALSE %M10.5 "AckError" AckError</p> <p>FALSE %M10.6 "Execute" ExecuteMode</p> <p>0 %MD104 "Position" Position</p> <p>0 %MD108 "Velocity" Velocity</p> <p>100</p> <p>%B284 "SINA_POS"</p> <p>ENO Error Status DiagID</p> <p>TRUE "SINA_POS_ DB".AxisEnabled</p> <p>AxisError AxisWarn</p> <p>FALSE "SINA_POS_ DB".AxisPosOk</p> <p>FALSE "SINA_POS_ DB".AxisRef</p> <p>-8873837 "SINA_POS_ DB".ActVelocity</p> <p>-139406 "SINA_POS_ DB".ActPosition</p> <p>7 "SINA_POS_ DB".ActMode</p> <p>Lockout EPosZSW1 EPosZSW2 ActWarn ActFault</p> <ol style="list-style-type: none"> <li>Set operating mode (MD100) to be <b>7h</b> (Jog mode).</li> <li>Enable servo drive by setting M10.0 (<b>EnableAxis</b>) to be 1. If the drive has been successfully enabled, the output signal "<b>AxisEnabled</b>" turns to be "1".</li> <li>Activate Jog resource 1 by setting M10.3 to be 1 or Jog resource 2 by setting M10.4 to be 1. Then, the motor starts running at 30 rpm that is the default setting for Jog speed.</li> </ol>

Step	Descriptions
6.	<div data-bbox="478 264 1197 1489"> </div> <ol style="list-style-type: none"> <li>1. Set M10.3 (<b>Jog1</b>) or M10.4 (<b>Jog2</b>) to be "0".</li> <li>2. Set operating mode (MD100) to be <b>1h</b> (MDI: relative positioning).</li> <li>3. Enable servo drive by setting M10.0 (<b>EnableAxis</b>) to be 1. If the drive has been successfully enabled, the output signal "<b>AxisEnabled</b>" turns to be "1".</li> <li>4. Configure MDI (relative positioning) parameters as follows:             <ul style="list-style-type: none"> <li>- MD104 = 10000: MDI target position of 10 motor revolutions (10000 LU)</li> <li>- MD108 = 1000: MDI speed of 100 rpm</li> </ul> </li> <li>5. Trigger a rising edge to M10.6 (<b>execute mode</b>) and the motor starts running for 10 revolutions at the speed of 100 rpm.</li> </ol>

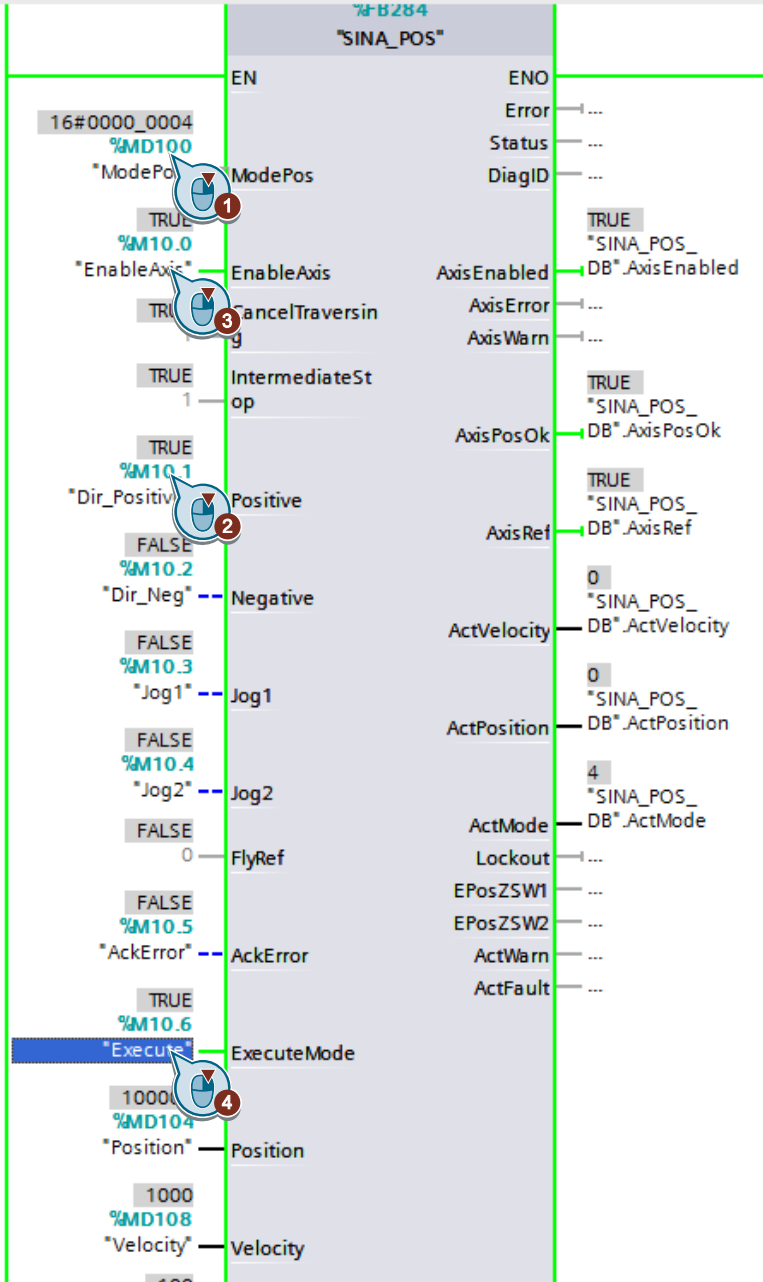

Step	Descriptions
7.	<p><b>Homing</b></p>  <p>1. Set operating mode (MD100) to be <b>4h (approach reference point)</b>.</p> <p>2. Set M10.1 to be "1", which means the start homing direction of positive has been selected.</p> <p>3. Enable servo drive by setting M10.0 (<b>EnableAxis</b>) to be "1".</p> <p>4. Trigger a rising edge to M10.6 (<b>execute mode</b>) and the motor starts homing as configured in SINAMICS V-ASSISTANT. In this example, the homing method of searching zero mark has been selected.</p> <p>When the homing operation has been done, the output signal "<b>AxisRef</b>" turns to be 1.</p>

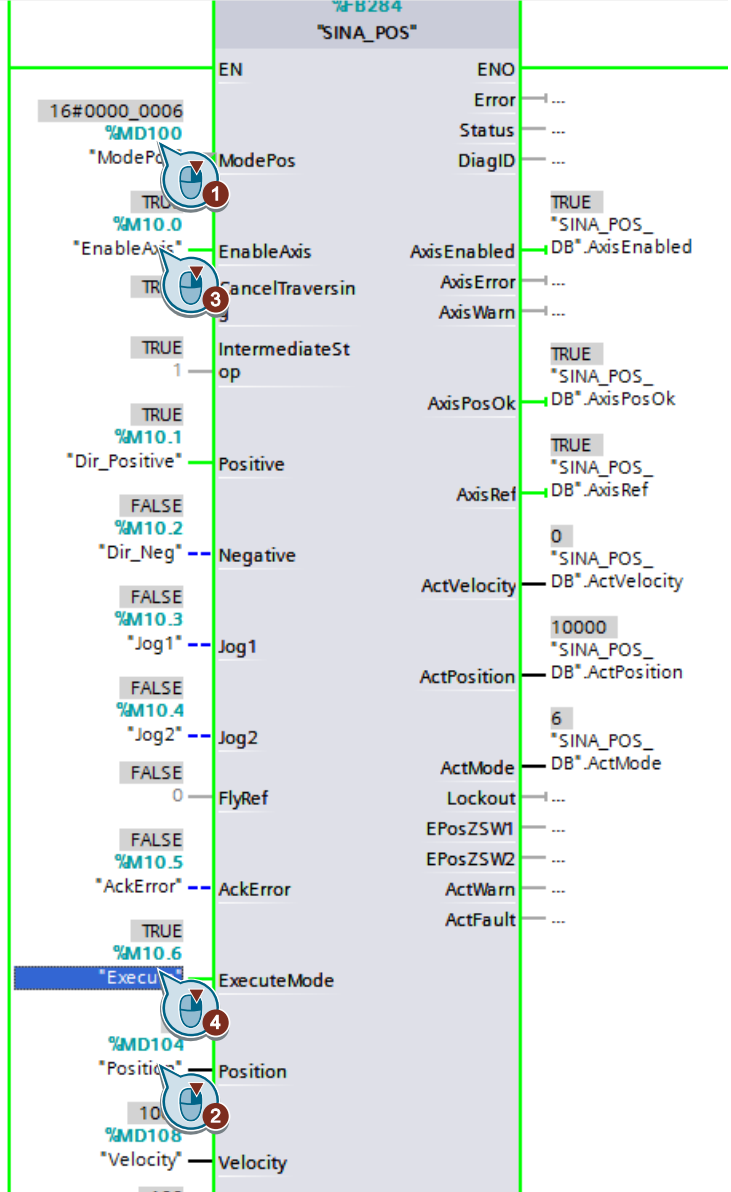
Step	Descriptions
8.	<p><b>Traversing block</b></p>  <p>1. Set operating mode (MD100) to be <b>6h (traversing block)</b>.</p> <p>2. Set MD104 to be 0, which means that traversing block 0 has been selected.</p> <p>3. Enable servo drive by setting M10.0 (<b>EnableAxis</b>) to be “1”.</p> <p>4. Trigger a rising edge to M10.6 (<b>execute mode</b>) and the motor starts running according to the configurations of traversing block 0 in SINAMICS V-ASSISTANT; in this example, relative positioning of one motor revolution. When the positioning has been done, the output signal of “<b>ActPosition</b>” will display the actual position.</p>
9.	<p><b>End operation</b></p> <p>1. Set M10.0 (EnableAxis) to be “0”, which means the servo drive is switched to servo-off state.</p> <p>2. Go offline.</p>

## 6 Appendix

### 6.1 Service and Support

#### Industry Online Support

Do you have any questions or need assistance?

Siemens Industry Online Support offers round the clock access to our entire service and support know-how and portfolio.

The Industry Online Support is the central address for information about our products, solutions and services.

Product information, manuals, downloads, FAQs, application examples and videos – all information is accessible with just a few mouse clicks at:

<https://support.industry.siemens.com>

#### Technical Support

The Technical Support of Siemens Industry provides you fast and competent support regarding all technical queries with numerous tailor-made offers – ranging from basic support to individual support contracts. You send queries to Technical Support via Web form:

[www.siemens.com/industry/supportrequest](http://www.siemens.com/industry/supportrequest)

#### Service offer

Our range of services includes, inter alia, the following:

- Product trainings
- Plant data services
- Spare parts services
- Repair services
- On-site and maintenance services
- Retrofitting and modernization services
- Service programs and contracts

You can find detailed information on our range of services in the service catalog:

<https://support.industry.siemens.com/cs/sc>

#### Industry Online Support app

You will receive optimum support wherever you are with the "Siemens Industry Online Support" app. The app is available for Apple iOS, Android and Windows Phone:

<https://support.industry.siemens.com/cs/ww/en/sc/2067>

## 6.2 Links and Literature

Table 6-1

No.	Topic
\1\	Siemens Industry Online Support <a href="https://support.industry.siemens.com">https://support.industry.siemens.com</a>
\2\	Link to this entry page of this application example <a href="https://support.industry.siemens.com/cs/ww/en/view/109747750">https://support.industry.siemens.com/cs/ww/en/view/109747750</a>
\3\	SINAMICS V90 PN Operating Instruction <a href="https://support.industry.siemens.com/cs/ww/en/view/109742518">https://support.industry.siemens.com/cs/ww/en/view/109742518</a>

## 6.3 Contact

Siemens Ltd., China

DF M3-BF GMC

No. 18 Siemens Road  
Jiangning Development Zone

Nanjing, 211100

China

mailto: [mc\\_gmc\\_mp\\_asia.cn@siemens.com](mailto:mc_gmc_mp_asia.cn@siemens.com)

## 6.4 History

Table 6-2

Version	Date	Modifications
V1.0	06/2017	First version