

Industrial Controls

Soft starters and solid-state switching devices SIRIUS 3RW52 Soft Starter

Equipment Manual

Siemens Industry Online Support	1
Safety information	2
Description	3
Mounting and dismantling	4
Wiring	5
Parameter assignment	6
Commissioning	7
Functions	8
Messages and diagnostics	9
Maintenance and servicing	10
Technical specifications	11
Dimension drawings	12
Circuit diagrams	13
Example circuits	A
Third-party software	B

Legal information

Warning notice system

This manual contains notices you have to observe in order to ensure your personal safety, as well as to prevent damage to property. The notices referring to your personal safety are highlighted in the manual by a safety alert symbol, notices referring only to property damage have no safety alert symbol. These notices shown below are graded according to the degree of danger.

 DANGER
indicates that death or severe personal injury will result if proper precautions are not taken.

 WARNING
indicates that death or severe personal injury may result if proper precautions are not taken.

 CAUTION
indicates that minor personal injury can result if proper precautions are not taken.

NOTICE
indicates that property damage can result if proper precautions are not taken.

If more than one degree of danger is present, the warning notice representing the highest degree of danger will be used. A notice warning of injury to persons with a safety alert symbol may also include a warning relating to property damage.

Qualified Personnel

The product/system described in this documentation may be operated only by **personnel qualified** for the specific task in accordance with the relevant documentation, in particular its warning notices and safety instructions. Qualified personnel are those who, based on their training and experience, are capable of identifying risks and avoiding potential hazards when working with these products/systems.

Proper use of Siemens products

Note the following:

 WARNING
Siemens products may only be used for the applications described in the catalog and in the relevant technical documentation. If products and components from other manufacturers are used, these must be recommended or approved by Siemens. Proper transport, storage, installation, assembly, commissioning, operation and maintenance are required to ensure that the products operate safely and without any problems. The permissible ambient conditions must be complied with. The information in the relevant documentation must be observed.

Trademarks

All names identified by ® are registered trademarks of Siemens AG. The remaining trademarks in this publication may be trademarks whose use by third parties for their own purposes could violate the rights of the owner.

Disclaimer of Liability

We have reviewed the contents of this publication to ensure consistency with the hardware and software described. Since variance cannot be precluded entirely, we cannot guarantee full consistency. However, the information in this publication is reviewed regularly and any necessary corrections are included in subsequent editions.

Table of contents

1	Siemens Industry Online Support.....	9
1.1	Support Request	11
1.2	Additional documentation	11
2	Safety information.....	13
2.1	ESD Guidelines.....	13
2.2	Five safety rules for working in or on electrical systems.....	14
2.3	Reactive power compensation.....	15
2.4	Electromagnetic compatibility (EMC) according to IEC 60947-4-2	15
2.5	Security information	16
2.6	Protection against unauthorized actuation.....	16
2.7	Firmware update.....	16
2.8	Recycling and disposal	17
3	Description.....	19
3.1	Target group	19
3.2	History.....	19
3.3	Device design	20
3.4	Operating principle	20
3.5	Access options for the 3RW52 soft starter.....	23
3.6	Operating modes and master control function.....	24
3.6.1	Operating modes.....	24
3.6.2	Sets the operating mode.....	26
3.7	Device versions	30
3.8	Areas of application / load types	31
3.9	Selection of the soft starter using the Simulation Tool for Soft Starters.....	33
3.10	Structure of the article number	34
3.11	Accessories	36
3.11.1	Accessories for 3RW52 soft starter.....	36
3.11.2	3RW5 communication module	37
3.11.3	SIRIUS Soft Starter ES (TIA Portal)	38
3.11.4	3RW5 HMI	40
4	Mounting and dismantling	43
4.1	Installing the 3RW52 soft starter	43
4.2	Mounting the fan cover.....	43

4.3	Mounting the 3RW52 soft starter on a level surface	45
4.4	Installing, mounting and removing the 3RW5 HMI	47
4.4.1	Installing the Standard 3RW5 HMI in 3RW52 soft starter	47
4.4.2	Removing Standard 3RW5 HMI	48
4.4.3	Installing the High Feature 3RW5 HMI in the 3RW52 soft starter	49
4.4.4	Removing the High Feature 3RW5 HMI	50
4.4.5	Installing the Standard 3RW5 HMI into the control cabinet door	51
4.4.6	Installing the High Feature 3RW5 HMI in the control cabinet door	54
4.4.7	Installing the Standard 3RW5 HMI on a flat surface	58
4.4.8	Installing the High Feature 3RW5 HMI on a flat surface	59
4.4.9	Cut out the hinged cover for 3RW5 HMI	61
4.4.10	Replacing the hinged cover of the 3RW52 soft starter	62
5	Wiring	63
5.1	Connections	63
5.1.1	Overview of all connections	63
5.1.2	State diagrams of the inputs and outputs	65
5.2	Connecting the 3RW52 soft starter	66
5.3	Connect the 3RW52 soft starter to the main circuit connection (line side / motor side)	67
5.4	Mounting terminal covers on main circuit connections	68
5.5	Replacement of the box terminal blocks with size 2	69
5.6	Connecting the control terminals (screw terminals)	71
5.7	Disconnecting the control current form the screw-type terminals	72
5.8	Connecting the control terminals (spring-type terminals)	72
5.9	Disconnecting the control current from the spring-loaded terminals	74
5.10	Replacing the control terminals	74
5.11	Installing the cover for the control cable duct	76
5.12	Removing the cover of the control cable duct	77
6	Parameter assignment	79
6.1	Setting elements on the 3RW52 soft starter	79
6.2	Overview of parameters	81
6.3	Suggested settings	82
6.4	Parameterizing the 3RW52 soft starter	82
6.5	Setting RESET MODE and Soft torque	83
6.6	RESET MODE	85
6.7	Parameterize output 13, 14 (output signal ON or RUN)	85
6.8	Parameterize the response to bus errors and output 13, 14 (ON / RUN)	87
6.9	Design and operator controls of the High Feature 3RW5 HMI	90
6.10	Menu of the 3RW5 HMI High Feature	92
6.11	Parameterize analog output AQ via the 3RW5 HMI High Feature	99

6.12	Parameterizing the High Feature 3RW5 HMI	101
6.13	Parameterize 3RW5 HMI High Feature serially / identically.....	103
7	Commissioning	105
7.1	Commissioning the 3RW52 soft starter.....	105
7.2	Sealing the 3RW52 soft starter	105
7.3	First commissioning of the High Feature 3RW5 HMI.....	106
8	Functions	109
8.1	Soft starting	109
8.2	Current limiting function.....	111
8.3	Soft stopping	113
8.4	Motor protection.....	114
8.4.1	Electronic motor overload protection.....	115
8.4.2	Thermistor motor protection with temperature sensor (optional)	116
8.5	Intrinsic device protection	117
8.6	Soft Torque.....	117
8.7	Functions under "Additional parameters".....	119
8.8	Test mode.....	120
8.9	Test with small load	121
8.10	Response to bus errors / Control via digital input.....	123
8.11	Standard 3RW5 HMI	125
8.11.1	Design of the Standard 3RW5 HMI.....	125
8.11.2	Standard 3RW5 HMI menu	126
8.12	High Feature 3RW5 HMI	129
8.12.1	Monitoring	129
8.12.1.1	Monitoring the measured values of the 3RW52 soft starter with the 3RW5 HMI High Feature.....	129
8.12.1.2	Graphic display of measured values on the 3RW5 HMI High Feature.....	131
8.12.1.3	Monitoring the process image of the 3RW52 soft starter with the High Feature 3RW5 HMI... ..	132
8.12.2	Overview	134
8.12.3	Local access protection (PIN)	136
8.12.3.1	Define PIN.....	137
8.12.3.2	Change PIN.....	138
8.12.3.3	Delete PIN.....	139
8.12.4	Micro SD card	139
8.12.5	Reloading a language for the High Feature 3RW5 HMI	141
9	Messages and diagnostics	143
9.1	Diagnostics options.....	143
9.2	LED display	144
9.2.1	Overview of the device LEDs of the 3RW52 soft starter	144
9.2.2	Status and error displays	145
9.2.3	STATE / OVERLOAD LED.....	146

9.2.4	Overview of LEDs on Standard 3RW5 HMI.....	146
9.2.5	Overview of LEDs on High Feature 3RW5 HMI.....	147
9.3	Warnings and remedial actions of the 3RW52 soft starter	148
9.4	Faults and remedial actions of the 3RW52 soft starter.....	149
9.5	Faults and remedial actions of the 3RW5 HMI High Feature.....	154
9.6	Diagnostics of the 3RW52 soft starter with the 3RW5 HMI High Feature	155
9.7	Execute HMI diagnostics with the 3RW5 HMI High Feature.....	159
9.8	Performing diagnostics of the 3RW5 communication module with the 3RW5 HMI High Feature.....	159
9.9	Self-test (user-test)	160
9.10	Logbooks.....	164
9.11	Save service data to micro SD card	165
10	Maintenance and servicing	167
10.1	Maintenance and repairs.....	167
10.2	Replacing the fan	167
10.3	Firmware update.....	172
10.4	Performing firmware update with micro SD card (3RW5 HMI High Feature)	173
10.5	Restore factory setting	174
10.5.1	Restoring the factory settings via High Feature 3RW5 HMI	176
10.5.2	Restoring the factory settings with the Master RESET button via 3RW5 HMI High Feature...	176
10.5.3	Restoring the factory settings with the MODE and RESET / TEST keys.....	177
10.6	"Device change" function	178
10.6.1	Device change with micro SD card on the 3RW5 HMI High Feature.....	179
10.6.2	Device change with SIRIUS Soft Starter ES (TIA Portal).....	180
11	Technical specifications	183
11.1	Technical data in Siemens Industry Online Support.....	183
12	Dimension drawings.....	185
12.1	CAX data.....	185
12.2	Drilling pattern for 3RW5 HMI Standard	185
12.3	Drilling pattern for 3RW5 HMI High Feature	186
13	Circuit diagrams.....	187
13.1	CAX data.....	187
A	Example circuits.....	189
A.1	Main circuit connection.....	189
A.1.1	Feeder assembly, type of coordination 1 fuseless.....	189
A.1.2	Feeder assembly, type of coordination 1 with fuses	190
A.1.3	Feeder assembly, type of coordination 2.....	191
A.1.4	Inside-delta circuit	192
A.2	Control circuit connection	195

A.2.1	Control by pushbutton	195
A.2.2	Control by switch	196
A.2.3	Switching with supply voltage (control supply voltage).....	198
A.2.4	Control by PLC	200
A.2.5	Actuation of a line contactor	202
A.2.6	Wiring for remote RESET.....	204
A.2.7	Connecting the temperature sensor	204
A.2.8	Connecting the evaluation unit to the analog output	205
A.3	Special applications	206
A.3.1	Reversing circuit.....	206
A.3.2	Controlling a motor with a magnetic parking brake.....	208
A.3.3	EMERGENCY STOP shutdown to SIL 1 or PL c with a 3SK1 safety relay.....	209
A.3.4	EMERGENCY STOP shutdown to SIL 3 or PL e with a 3SK1 safety relay	214
A.3.5	Contactors for emergency start.....	220
A.3.6	Starting a Dahlander motor	221
A.3.7	External bypass	224
B	Third-party software	227
B.1	Information about third-party software	227
	Glossary	231
	Index	233

Siemens Industry Online Support

Information and service

At Siemens Industry Online Support you can obtain up-to-date information from our global support database:

- Product support
- Application examples
- Forum
- mySupport

Link: Siemens Industry Online Support (<https://support.industry.siemens.com/cs/ww/en>)

Product support

You can find information and comprehensive know-how covering all aspects of your product here:

- **FAQs**
Answers to frequently asked questions
- **Manuals/operating instructions**
Read online or download, available as PDF or individually configurable.
- **Certificates**
Clearly sorted according to approving authority, type and country.
- **Characteristics**
For support in planning and configuring your system.
- **Product announcements**
The latest information and news concerning our products.
- **Downloads**
Here you will find updates, service packs, HSPs and much more for your product.
- **Application examples**
Function blocks, background and system descriptions, performance statements, demonstration systems, and application examples, clearly explained and represented.
- **Technical data**
Technical product data for support in planning and implementing your project

Link: Product support (<https://support.industry.siemens.com/cs/ww/en/ps>)

mySupport

The following functions are available in your personal work area "mySupport":

- **Support Request**
Search for request number, product or subject
- **My filters**
With filters, you limit the content of the online support to different focal points.
- **My favorites**
With favorites you bookmark articles and products that you need frequently.
- **My notifications**
Your personal mailbox for exchanging information and managing your contacts. You can compile your own individual newsletter in the "Notifications" section.
- **My products**
With product lists you can virtually map your control cabinet, your system or your entire automation project.
- **My documentation**
Configure your individual documentation from different manuals.
- **CAX data**
Easy access to CAX data, e.g. 3D models, 2D dimension drawings, EPLAN macros, device circuit diagrams
- **My IBase registrations**
Register your Siemens products, systems and software.

Siemens Industry Online Support app

The Siemens Industry Online Support app provides you access to all the device-specific information available on the Siemens Industry Online Support portal for a particular article number, such as operating instructions, manuals, data sheets, FAQs etc.

The Siemens Industry Online Support app is available for Android and iOS:



Android



iOS

1.1 Support Request

After you have registered, you can use the Support Request form in the online support to send your question directly to Technical Support:

Support Request:	Internet (https://www.siemens.com/support-request)
------------------	--

1.2 Additional documentation

Manuals / online help

At this point, you will find further manuals and online help that may be of interest to you for your automation system. They are available to download from the Internet free of charge. You can create your own individual system documentation in mySupport.

- 3RW5 topic page (<https://support.industry.siemens.com/cs/ww/en/view/109747404>)
- Equipment Manual for the 3RW50 soft starter (<https://support.industry.siemens.com/cs/ww/en/view/109753750>)
- Equipment Manual for the 3RW52 soft starter (<https://support.industry.siemens.com/cs/ww/en/view/109753751>)
- Equipment Manual for the 3RW55 and 3RW55 Failsafe Soft Starters (<https://support.industry.siemens.com/cs/ww/en/view/109753752>)
- Equipment Manuals for the 3RW5 soft starter (<https://support.industry.siemens.com/cs/ww/en/ps/16212/man>)
- Equipment Manual for the 3RW5 PROFINET communication modules (<https://support.industry.siemens.com/cs/ww/en/view/109753754>)
- Equipment Manual for the 3RW5 PROFIBUS communication module (<https://support.industry.siemens.com/cs/ww/en/view/109753753>)
- Equipment Manual for the 3RW5 Modbus communication modules (<https://support.industry.siemens.com/cs/ww/en/view/109753755>)
- Equipment Manual for the 3RW5 EtherNet/IP communication module (<https://support.industry.siemens.com/cs/ww/en/view/109758201>)
- Online help for SIRIUS Soft Starter ES (TIA Portal)
- Online help for STEP 7
- The EMC Directive 2014/30/EU in practice (<http://www.siemens.com/emc-guideline>)
- Industrial Control Panels and Electronic Equipment of Industrial Machinery for North America (<http://www.siemens.com/UL508A>)
- Control Panels compliant with IEC Standards and European Directives (<http://www.siemens.com/iec60204>)

Interesting links

- Manuals in Siemens Industry Online Support (<https://support.industry.siemens.com/cs/ww/en/ps/man>)
- FAQs for soft starters 3RW5 (<https://support.industry.siemens.com/cs/ww/en/ps/16212/faq>)
- Downloads for soft starters 3RW5 (<https://support.industry.siemens.com/cs/ww/en/ps/16212/dl>)
- Catalog IC 10 (<https://support.industry.siemens.com/cs/ww/en/view/109747945>)
- Product support for STEP 7 (TIA Portal) (<https://support.industry.siemens.com/cs/ww/en/ps/14672>)

Safety information

2.1 ESD Guidelines

ESD

All electronic devices are equipped with large-scale integrated ICs or components. Due to their design, these electronic elements are highly sensitive to overvoltage, and thus to any electrostatic discharge.

The acronym ESD has become the established designation for such electrostatic sensitive components/devices. This is also the international abbreviation for such devices.

ESD devices are identified by the following symbol:



NOTICE

Electrostatic discharge

ESD devices can be destroyed by voltages well below the threshold of human perception. These static voltages develop when you touch a component or electrical connection of a device without having drained the static charges present on your body. The damage caused to a device by overvoltage is usually not immediately evident and is only noticed after an extended period of operation.

Electrostatic charging

Anyone who is not connected to the electrical potential of their surroundings can be electrostatically charged.

The diagram below shows the maximum electrostatic voltage which may build up on a person coming into contact with the materials specified in the diagram. These values correspond to IEC 801-2 specifications.

2.2 Five safety rules for working in or on electrical systems

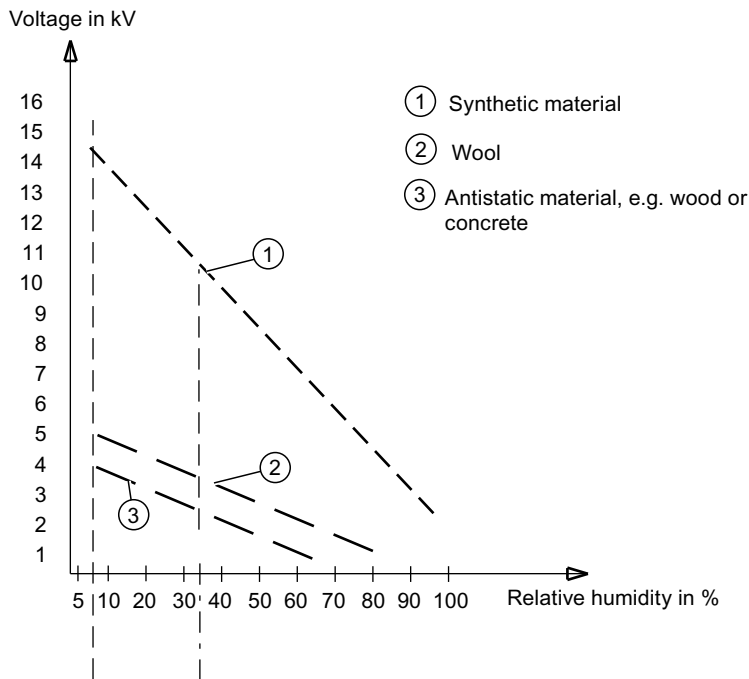

Basic protective measures against electrostatic discharge

- Make sure the grounding is good:
When handling electrostatic sensitive devices, ensure that your body, the workplace and packaging are grounded. In this way, you can avoid becoming electrostatically charged.
- Avoid direct contact:
As a general rule, only touch electrostatic sensitive devices when this is unavoidable (e.g. during maintenance work). Handle the devices without touching any chip pins or PCB traces. In this way, the discharged energy cannot reach or damage sensitive devices. Discharge your body before taking any necessary measurements on a device. Do so by touching grounded metallic parts. Use only grounded measuring instruments.

2.2 Five safety rules for working in or on electrical systems

A set of rules, which are summarized in DIN VDE 0105 as the "five safety rules", are defined for working in or on electrical systems as a preventative measure against electrical accidents:

1. Isolate
2. Secure against re-connection
3. Verify absence of operating voltage
4. Ground and short-circuit
5. Provide protection against adjacent live parts

These five safety rules must be applied in the above order prior to starting work on an electrical system. After completing the work, proceed in the reverse order.

It is assumed that every electrically skilled person is familiar with these rules.

Explanations

1. The isolating distances between live and de-energized parts of the system must vary according to the operating voltage that is applied.
"Isolate" refers to the all-pole disconnection of live parts.
All-pole disconnection can be achieved, e.g. by.:
 - Switching off the miniature circuit breaker
 - Switching off the motor circuit breaker
 - Unscrewing fusible links
 - Removing LV HRC fuses
2. The feeder must be locked against inadvertent reconnection to ensure that it remains isolated for the duration of the work. This can be achieved, for instance, by locking the motor and system circuit breakers in the OFF position or by unscrewing the fuses and using lockable elements to prevent them from being reinserted.
3. The de-energized state of the equipment should be verified using suitable test equipment, e.g. a two-pole voltmeter. Single-pole test pins are not suitable for this purpose. The absence of power must be established for all poles, phase to phase, and phase to N/PE.
4. Grounding and short-circuiting are only mandatory if the system has a nominal voltage greater than 1 kV. In this case, the system should always be grounded first and then connected to the live parts to be short-circuited.
5. These parts should be covered, or barriers erected around them, to avoid accidental contact during the work with adjacent parts that are still live.

2.3 Reactive power compensation

Capacitors for improving the power factor (reactive power compensation)

Do not connect any capacitors to the output terminals of the 3RW5 soft starter. If capacitors are connected to the output terminals, the 3RW5 soft starter will be damaged.

Do not operate active filters, e.g. for reactive power compensation, parallel to the 3RW5 soft starter.

If you use capacitors to correct the power factor (actively or passively), you must connect them on the line side of the 3RW5 soft starter. Make sure that the capacitors do not actively control the power factor during the starting and coasting down phases. If you use a contactor disconnect or main contactor together with the 3RW5 soft starter, the capacitors must be disconnected from the 3RW5 soft starter when the contactor is open.

You will find further information in the Internet (<https://support.industry.siemens.com/cs/ww/en/view/67131557>).

2.4 Electromagnetic compatibility (EMC) according to IEC 60947-4-2

This product is designed for Environment A. It may produce radio interference in domestic environments, in which case the user may be required to take adequate mitigation measures.

2.5 Security information

Siemens provides products and solutions with industrial security functions that support the secure operation of plants, systems, machines and networks.

In order to protect plants, systems, machines and networks against cyber threats, it is necessary to implement – and continuously maintain – a holistic, state-of-the-art industrial security concept. Siemens' products and solutions constitute one element of such a concept.

Customers are responsible for preventing unauthorized access to their plants, systems, machines and networks. Such systems, machines and components should only be connected to an enterprise network or the internet if and to the extent such a connection is necessary and only when appropriate security measures (e.g. firewalls and/or network segmentation) are in place.

For additional information on industrial security measures that may be implemented, please visit

<https://www.siemens.com/industrialsecurity>.

Siemens' products and solutions undergo continuous development to make them more secure. Siemens strongly recommends that product updates are applied as soon as they are available and that the latest product versions are used. Use of product versions that are no longer supported, and failure to apply the latest updates may increase customer's exposure to cyber threats.

To stay informed about product updates, subscribe to the Siemens Industrial Security RSS Feed under

<https://www.siemens.com/cert>.

2.6 Protection against unauthorized actuation

Protect freely accessible operator controls on your machine / system against unauthorized actuation if this could result in a risk or danger. Take suitable action in this regard, for example, a lockable key-operated switch.

2.7 Firmware update

To be able to use 3RW52 soft starters without any problem and with their full range of functions, ensure that all components have the latest firmware (Page 172):

- 3RW52 soft starter
- 3RW5 HMI High Feature (accessory)
- 3RW5 communication module (accessory)

You will find current downloads and a history of the versions with new features on the 3RW5 topic page (<https://support.industry.siemens.com/cs/ww/en/view/109747404>).

2.8 Recycling and disposal

For environmentally friendly recycling and disposal of your old device, please contact a company certified for the disposal of old electrical and/or electronic devices and dispose of the device in accordance with the regulations in your country.

Description

3.1 Target group

Target group

The manual is intended for everyone involved in the following tasks:

- Planning and configuring systems
- Installation
- Commissioning
- Service and maintenance

Requirements for use of 3RW5 soft starters

Basic knowledge of the following areas:

- General electrical engineering
- Drive technology
- Automation technology
- Handling the automation system and the software used

3.2 History

Release number	New features
03/2018	<ul style="list-style-type: none"> • Initial release
04/2018	<ul style="list-style-type: none"> • Revision of the Equipment Manual
01/2019	<ul style="list-style-type: none"> • Revision of the Equipment Manual • Addition of functions for the 3RW52 soft starter (e.g. Test with small load)
04/2020	<ul style="list-style-type: none"> • Revision of the Equipment Manual • Addition of functions for the 3RW52 soft starter (e.g. response to bus error / control via digital input, restoration of factory settings with the keys MODE and RESET / TEST)
03/2022	<ul style="list-style-type: none"> • Revision of the Equipment Manual

3.3 Device design

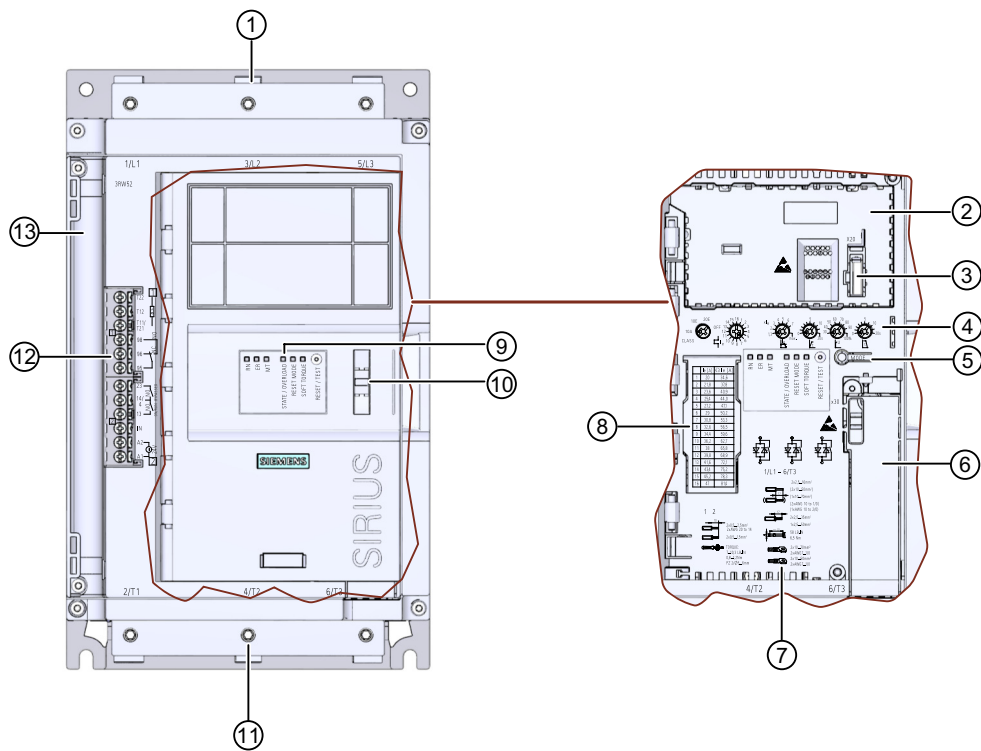

- ① Main circuit connection (mains supply)
- ② Slot for 3RW5 HMI Standard (accessory) or 3RW5 HMI High Feature (accessory)
- ③ Interface for 3RW5 HMI Standard (accessory) or 3RW5 HMI High Feature (accessory)
- ④ Setting elements for parameter assignment
- ⑤ MODE key
- ⑥ Slot for 3RW5 communication module (accessory)
- ⑦ Connectible conductor cross sections
You will also find the conductor cross-sections that can be connected in the Technical data (Page 183).
- ⑧ Scale of the setting element I_e
You will also find the applicable scale in the Technical data (Page 183).
- ⑨ Diagnostics LEDs and RESET / TEST key
- ⑩ Eye for lead seal
- ⑪ Main circuit connection (motor)
- ⑫ Control terminals (inputs/outputs)
- ⑬ Control cable duct with cover

3.4 Operating principle

Soft starters are used to start three-phase induction motors with reduced torque and reduced starting current.

The 3RW52 soft starter starts the motor as soon as the switch-on command is issued (t_1). During the ramp up time (t_1 to t_3), the current is conducted via power semiconductors (switching elements) which start the motor up smoothly.

The 3RW52 soft starter features internal ramp-up detection. If the 3RW52 soft starter detects that the motor has successfully reached its operating speed before the ramp up time has elapsed, the motor voltage is immediately increased to 100 % of the line voltage (t_2). The internal bypass contacts close and the power semiconductors are bypassed. The 3RW52 soft starter is then in bypass operation.

Canceling the switch-on command (t_4) activates the stopping mode and the motor is shut down. The power semiconductors also ensure that the motor coasts down smoothly to a stop. As long as the stopping time is active (t_4 to t_5), power is still supplied to the motor. It may take longer for the motor to actually coast down to standstill (t_6).

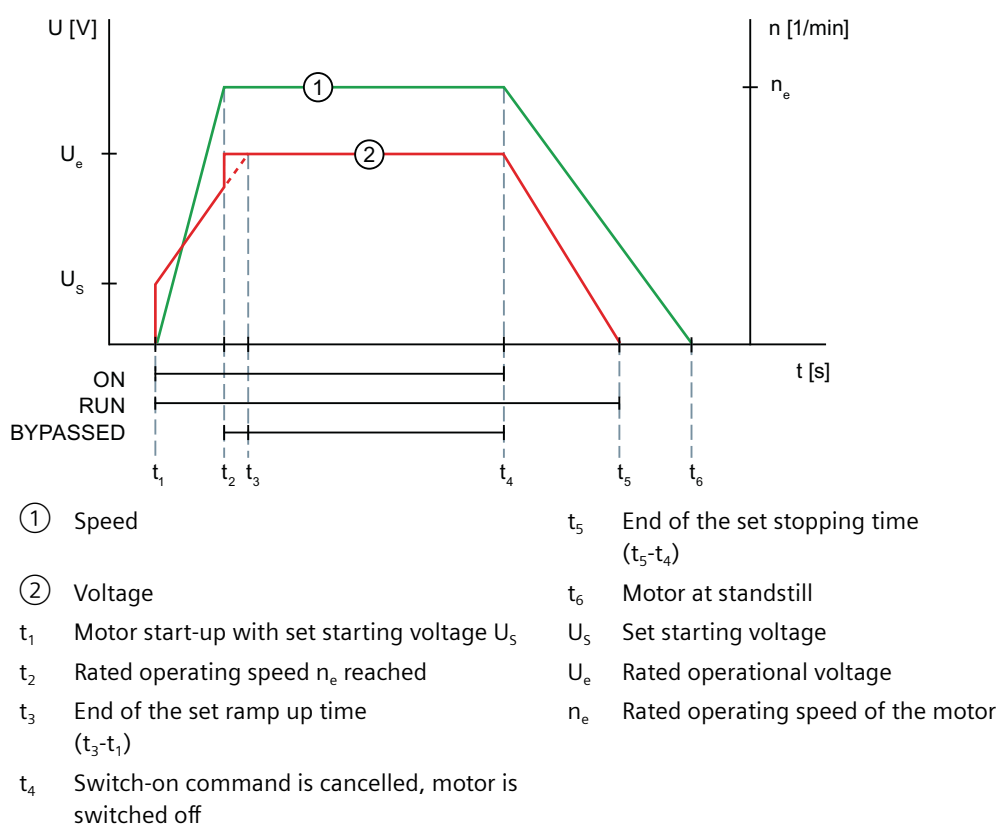

Functions

Note the information in chapter Firmware update (Page 16).

- **Soft starting** with parameterizable starting voltage and ramp up time for a smooth starting of the drive
- **Soft stopping** with parameterizable stopping time for a smooth run-down of the drive
- Parameterizable **current limit** for avoiding current peaks
- **Soft torque** for smooth ramp up and run-down (avoiding torque peaks by means of torque limitation)

3.4 Operating principle

- **Integrated electronic motor overload protection** with adjustable trip class (Off, CLASS 10A, 10E, 20E)
- **Intrinsic device protection** protects the 3RW52 soft starter against overload
- **Ramp-up detection**
- Extended operating and diagnostic functions provided by the optional **3RW5 HMI Standard** or **3RW5 HMI High Feature**
- Connection to the motor in **standard (inline) circuit** or in **inside-delta circuit**
- Adjustable **RESET MODE** (Manual RESET, Remote RESET, Auto RESET) for the functions of motor protection
- Extended full motor protection via optional **thermistor motor protection** for connection of a temperature switch (e.g. Thermoclick) or a thermistor (e.g. PTC type A) (alternative to analog output)
- Optional **analog output** for displaying a set measured value using an external evaluation unit (alternative to the thermistor motor protection)
- Optional **3RW5 communication module** for integration into bus systems
- **Firmware updates** upgrade the firmware of the respective device

Additional information

You will find an overview of all of the functions of the 3RW5 soft starter in the Catalog IC 10 (<https://support.industry.siemens.com/cs/ww/en/view/109747945>).

You will find further details of the functions in chapter Functions (Page 109).

3.5 Access options for the 3RW52 soft starter

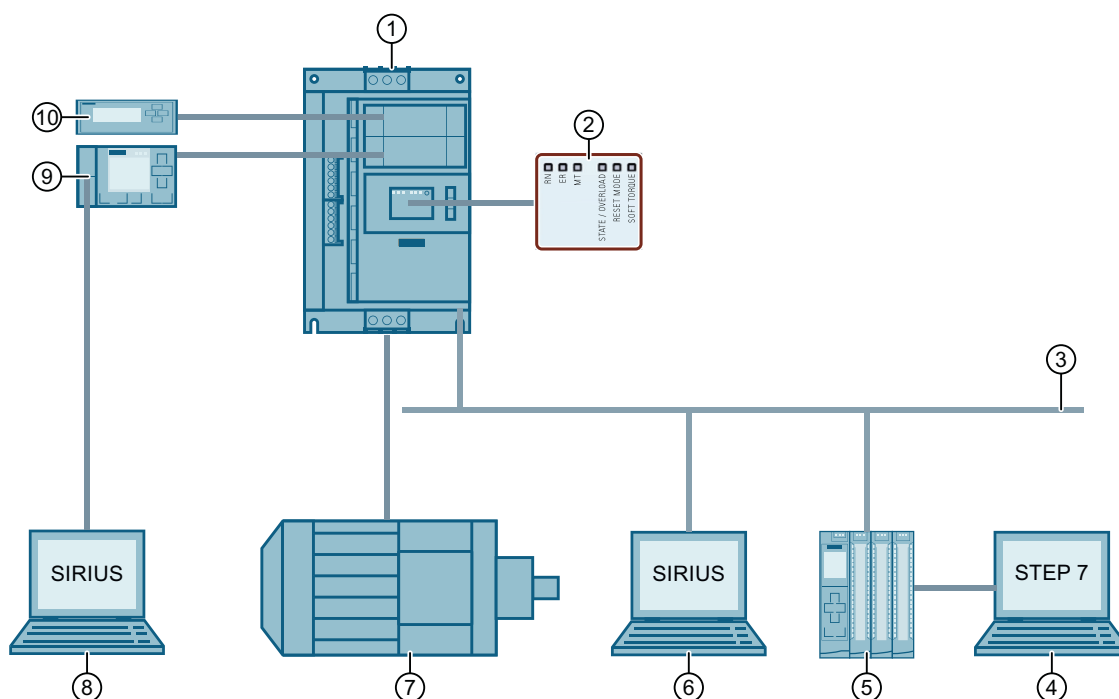

- ① SIRIUS 3RW52 soft starter
- ② LED display on 3RW52 soft starter
- ③ Fieldbus (via optional communication module)
- ④ PC or programming device with configuration software of the controller, e.g. STEP 7
- ⑤ Programmable logic controller, e.g. SIMATIC S7-1500
- ⑥ PC with SIRIUS Soft Starter ES (TIA Portal) Premium / Professional via an optional 3RW5 PROFINET or PROFIBUS communication module
- ⑦ Motor
- ⑧ PC with SIRIUS Soft Starter ES (TIA Portal) via local interface on 3RW5 HMI High Feature
- ⑨ 3RW5 HMI High Feature (accessory) (firmware version V1.1 or higher)
- ⑩ 3RW5 HMI Standard (accessory)

	Monitoring	Diagnostics	Control	Parameter setting
3RW5 HMI High Feature	✓	✓	✓	..2), 3)
3RW5 HMI Standard	✓	✓	✓	..4)
SIRIUS Soft Starter ES (TIA Portal) ¹⁾	✓	✓	✓	-
Fieldbus via 3RW5 communication module	✓ (via user program)	✓	✓	-
3RW52 soft starter	LEDs	LEDs	Via input IN	Setting elements

¹⁾ Via the local interface on the 3RW5 HMI High Feature or via a 3RW5 PROFINET or PROFIBUS communication module.

²⁾ Analog output (for device version with analog output only) and ON / RUN relay output can be set.

³⁾ Communication parameters of all compatible communication modules can be set.

⁴⁾ Station address can be set for a 3RW5 PROFIBUS and Modbus RTU communication module.

3.6 Operating modes and master control function

3.6.1 Operating modes

Control source and master control

The operating modes assign access rights to the various control sources (access sources). The control source that possesses the rights for controlling and writing access has control. As only one control source can ever have control at one time, different priorities are assigned to the operating modes. Read access is also possible without control.

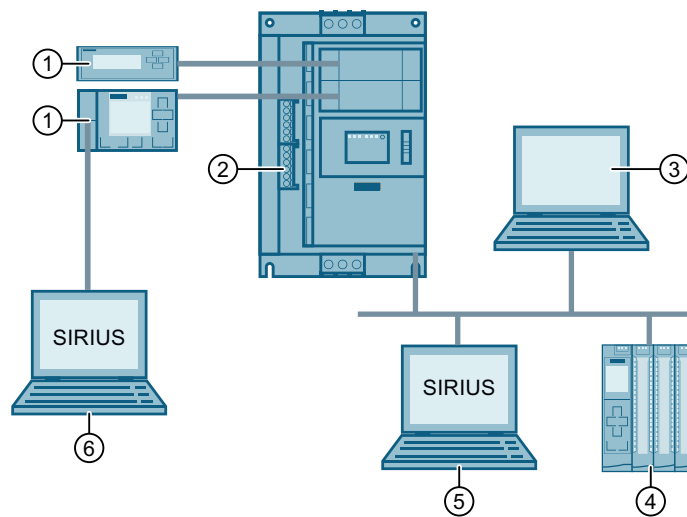

- ① Control source: 3RW5 HMI, operating mode: Manual operation local - HMI controlled
- ② Control source: Input IN, operating mode: Manual operation local - input controlled
- ③ Control source: Modbus client or Modbus master, operating mode: Automatic
- ④ Control source: PLC, operating mode: Automatic
- ⑤ Control source: SIRIUS Soft Starter ES (TIA Portal) Premium / Professional, operating mode: Manual - bus
- ⑥ Control source: SIRIUS Soft Starter ES (TIA Portal), operating mode: Manual operation local - PC controlled

"Automatic" mode

For the "Automatic" mode, you require a 3RW5 communication module and a higher-level control (e.g. PLC). The control source is connected to the 3RW52 soft starter via the 3RW5 communication module.

In "Automatic" mode, control is with a higher-level control:

- PROFINET, PROFIBUS, EtherNet/IP: Programmable logic controller (PLC)
- Modbus TCP: Modbus Client (e.g. PLC)
- Modbus RTU: Modbus Master (e.g. PLC)

Operating mode "Manual - bus"

For operating mode "manual - bus", you require a 3RW5 PROFINET or PROFIBUS communication module and a PC with SIRIUS Soft Starter ES (TIA Portal) Premium / Professional. The control source is connected to the 3RW52 soft starter via the 3RW5 communication module.

In operating mode "manual - bus", control is with the SIRIUS Soft Starter ES (TIA Portal) Premium software.

Operating mode "manual - local"

In operating mode "manual - local", control is with a control source directly on the 3RW52 soft starter:

- Input IN
- 3RW5 HMI (accessory)
- SIRIUS Soft Starter ES (TIA Portal) via local interface on the 3RW5 HMI High Feature (accessory)

Priorities of the operating modes

Mode	Control source	Priority
Automatic	Higher-level control (e.g. PLC)	Lowest
Manual - bus (depending on the 3RW5 communication module)	-	↓
	PC controlled	SIRIUS Soft Starter ES (TIA Portal) Premium / Professional ↓
Manual - local	Input controlled	Input IN ↓ ²⁾
	3RW5 HMI controls	3RW5 HMI ↓
	PC controlled	SIRIUS Soft Starter ES (TIA Portal) Highest

¹⁾ Explanation in text below

²⁾ Lowest priority without 3RW5 communication module

Connection abort

On failure of the bus connection or a CPU stop, the 3RW52 soft starter behaves as follows, irrespective of the mode:

- 3RW52 soft starter with firmware version earlier than V2.0.1: The 3RW52 soft starter remains in "Automatic" mode or switches to "Automatic" mode.

Note

Response of 3RW52 soft starter in the event of bus connection failure or CPU stop (3RW52 Soft Starter with firmware version earlier than V2.0.1)

To enable you to continue controlling the 3RW52 soft starter after failure of the bus connection or CPU stop, you will need a 3RW5 HMI (accessory), which enables you to switch to "Manual operation local" mode.

Without 3RW5 HMI, you cannot control the 3RW52 soft starter until the bus connection has been restored.

Alternatively, you can remove the 3RW5 communication module. Then restore the 3RW52 soft starter on the device to the factory setting (Page 177) in order to switch to "Manual operation local - Input controlled" mode.

- 3RW52 soft starter from firmware version V2.0.1: The 3RW52 soft starter behaves in accordance with the parameter "Control via digital input" (Page 123).

If other connections between the control source and 3RW52 soft starter are aborted, control automatically switches back to the lowest priority of the current mode.

- "Automatic" mode: The 3RW52 Soft Starter responds as it does upon failure of the bus connection or CPU stop.
- Operating mode "manual - bus": Control switches to "Manual - bus - Connection abort".
- Operating mode "manual - local": Control switches to "Manual - local - Input controlled".

Additional information

You will find further information on the 3RW5 communication modules in the manual for the 3RW5 communication module used.

3.6.2 Sets the operating mode

Fundamental response when changing the mode

A higher-priority mode can fetch control from a lower-priority mode at any time; the reverse is not possible. Master control can only be returned to the mode with the lowest priority. Control sources with higher priority must fetch master control from the mode with the lowest priority.

Requirements

- A mode with lower priority can only fetch back control while the motor is switched off.
- For the "Automatic" mode and operating mode "Manual - bus", you require a 3RW5 communication module.

"Automatic" mode

Note that the 3RW52 soft starter switch with a firmware version earlier than V2.0.1 switches to "Automatic" mode after the 3RW5 communication module has been installed in the 3RW52 soft starter. 3RW52 soft starters with firmware version V2.0.1 and later switch to "Automatic" mode only with the settings "Manual activation" or "No change on bus error" of the parameter "Control via digital input" (Page 123).

Receiving master control

"Automatic" mode receives control from the operating mode "manual - bus" or "manual - local" as follows:

- Command in SIRIUS Soft Starter ES (TIA Portal) Premium / Professional (fieldbus)
Brief overview: Window "Task Card" > Tab "Online Tools" > "SIRIUS Control Panel > Master Control > Release Control"
- By disabling the "Manual operation local - input controlled" bit in the process image output (PIQ) or in the data table "Process image output (PIQ)" (depending on the 3RW5 communication module), the "Automatic" mode receives control from the Input IN.
- "LOCAL / REMOTE" action on the 3RW5 HMI
- Command in SIRIUS Soft Starter ES (TIA Portal) (local interface on the 3RW5 HMI High Feature)
Brief overview: Window "Task Card" > Tab "Online Tools" > "SIRIUS Control Panel > Master Control > Release Control"

Withdrawal of master control by other control sources

In "Automatic" mode, control can be withdrawn by any control source.

Operating mode "Manual - bus"

Fetching control

SIRIUS Soft Starter ES (TIA Portal) Premium / Professional actively fetches control from "Automatic" mode in response to a command to this effect.

Brief overview: Window "Task Card" > Tab "Online Tools" > "SIRIUS Control Panel > Master Control > Get Control"

Giving back control

SIRIUS Soft Starter ES (TIA Portal) Premium / Professional actively passes control to "Automatic" mode in response to a command to this effect.

Brief overview: Window "Task Card" > Tab "Online Tools" > "SIRIUS Control Panel > Master Control > Release Control"

Withdrawal of master control by other control sources

Master control is withdrawn from the operating mode "manual - bus" by the operating mode "manual - local" as follows:

- Activation of the "Manual operation local - input controlled" bit in the process image output (PIQ) or in the data table "Process image output (PIQ)" (depending on the 3RW5 communication module).
- "LOCAL / REMOTE" action on the 3RW5 HMI
- Command in SIRIUS Soft Starter ES (TIA Portal) (local interface on the 3RW5 HMI High Feature)
Brief overview: Window "Task Card" > Tab "Online Tools" > "SIRIUS Control Panel > Master Control > Get Control"

Operating mode "Manual operation local - input controlled"

Fetching control

By enabling the "Manual operation local - input controlled" bit in the process image output (PIQ) or in the data table "Process image output (PIQ)" (depending on the 3RW5 communication module), the Input IN receives master control from the "Automatic" mode or operating mode "manual - bus".

If master control is on the 3RW5 HMI or, in the case of the local interface, on the 3RW5 HMI High Feature (higher priority), you must first actively give up master control. The Input IN can then fetch master control.

Giving back control

By disabling the "Manual operation local - input controlled" bit in the process image output (PIQ) or in the data table "Process image output (PIQ)" (depending on the 3RW5 communication module), the "Automatic" mode receives master control.

Withdrawal of master control by other control sources

Master control is withdrawn from the Input IN as follows:

- "LOCAL / REMOTE" action on the 3RW5 HMI
- Command in SIRIUS Soft Starter ES (TIA Portal) (local interface on the 3RW5 HMI High Feature)
Brief overview: Window "Task Card" > Tab "Online Tools" > "SIRIUS Control Panel > Master Control > Get Control"

Operating mode "Manual operation local - HMI controlled"

Fetching control

The 3RW5 HMI actively fetches master control via the action "LOCAL / REMOTE" from the lower priority control source.

If master control at the local interface on the 3RW5 HMI High Feature (higher priority), you must first actively give up master control in SIRIUS Soft Starter ES (TIA Portal). You can then get master control with the action "LOCAL / REMOTE".

Giving back control

The 3RW5 HMI actively gives up the master control function via the action "LOCAL / REMOTE" to the "Automatic" mode or alternatively to the Input IN. In the following cases, master control is given up to the Input IN:

- No 3RW5 communication module is installed in the 3RW52 soft starter.
- 3RW52 soft starter from firmware version V2.0.1: The parameter "Control via digital input" (Page 123) is set to "Permanent activation".

Withdrawal of master control by other control sources

If a command to this effect is issued in SIRIUS Soft Starter ES (TIA Portal) at the local interface on the 3RW5 HMI High Feature, master control is taken from the 3RW5 HMI.

Brief overview: Window "Task Card" > Tab "Online Tools" > "SIRIUS Control Panel > Master Control > Get Control"

Operating mode "Manual operation local - PC controlled"

Fetching control

In response to a command to this effect, SIRIUS Soft Starter ES (TIA Portal) actively fetches control from any control source.

Brief overview: Window "Task Card" > Tab "Online Tools" > "SIRIUS Control Panel > Master Control > Get Control"

Giving back control

If a command to this effect is issued, SIRIUS Soft Starter ES (TIA Portal) actively gives up the master control function to the "Automatic" mode or alternatively to the Input IN.

Brief overview: Window "Task Card" > Tab "Online Tools" > "SIRIUS Control Panel > Master Control > Release Control"

In the following cases, master control is given up to the Input IN:

- No 3RW5 communication module is installed in the 3RW52 soft starter.
- 3RW52 soft starter from firmware version V2.0.1: The parameter "Control via digital input" (Page 123) is set to "Permanent activation".

Withdrawal of master control by other control sources

The master control function cannot be withdrawn from SIRIUS Soft Starter ES (TIA Portal) by any control source.

Additional information

You will find more information on the process images and data tables in the manual for the 3RW5 communication module in question.

Further information on the operation of SIRIUS Soft Starter ES (TIA Portal) can be found in the online help of SIRIUS Soft Starter ES (TIA Portal).

3.7 Device versions

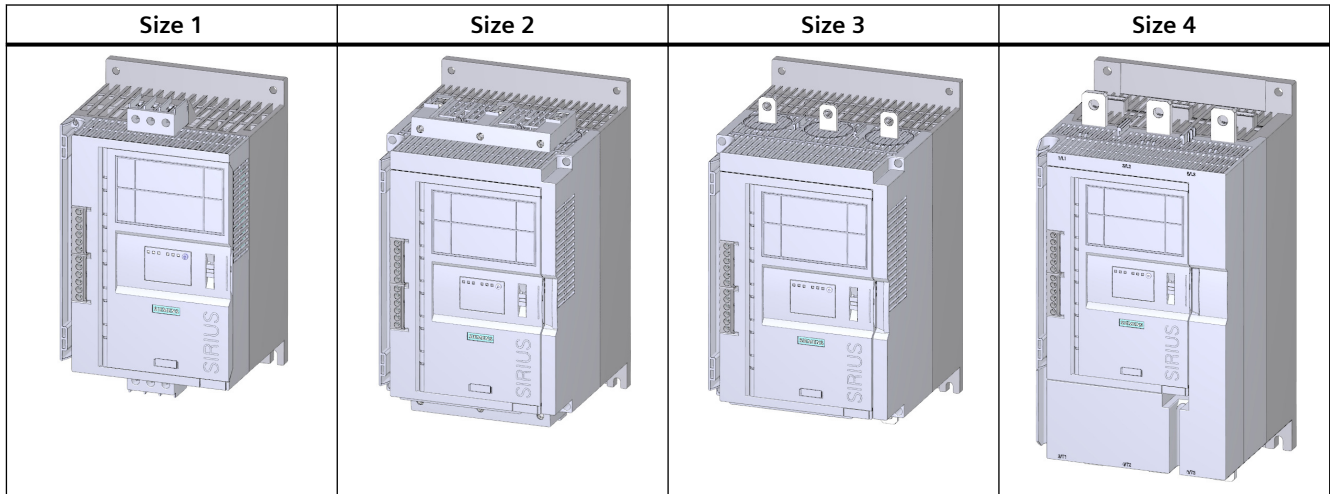

Rated operational current ranges

The stated power ratings apply to a rated operational voltage of $U_e = 400$ V in an inline circuit.

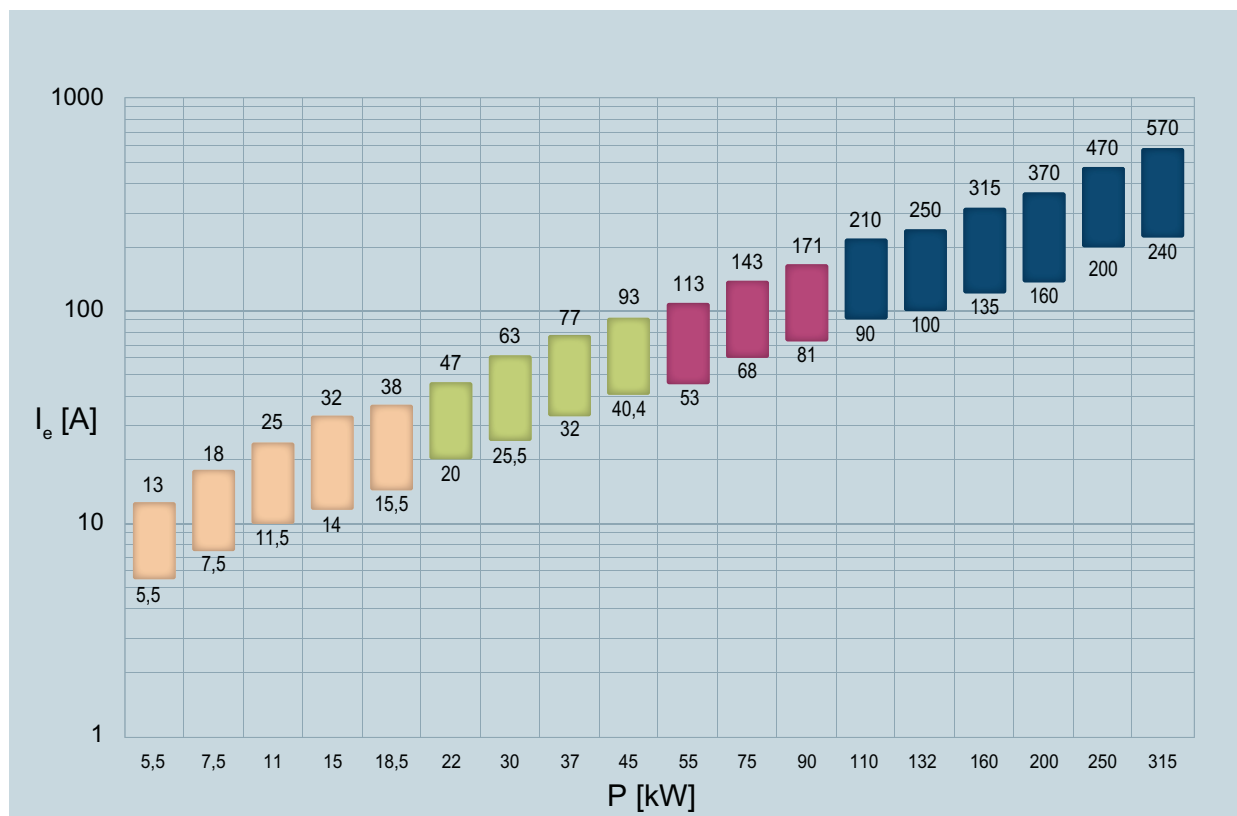

Size 1

Size 2

Size 3

Size 4

I_e Rated operational current

P Rated power

3.8 Areas of application / load types

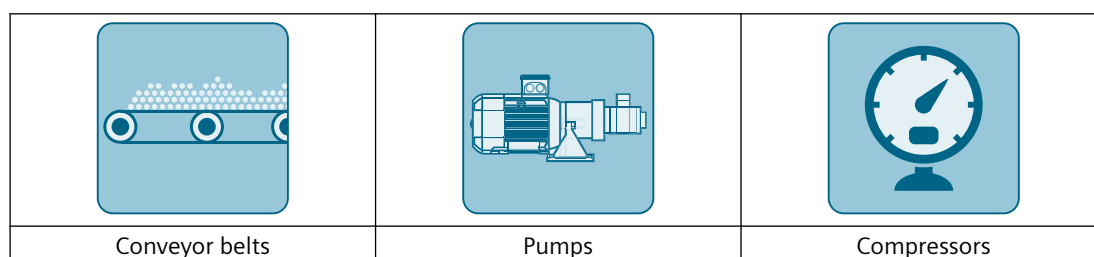

3.8 Areas of application / load types

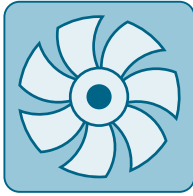
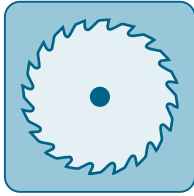
		
Agitators	Fans	Saws

Starting of a motor causes a rapid change in the load current. The resulting torque impulses place severe stresses on the mechanical parts of a machine or plant. Moreover, voltage dips can occur in the power supply system which can have a negative influence on other devices:

- Flicker in lights
- Influence on computer systems
- Contactors and relays dropping out

The 3RW52 soft starter controls the voltage continuously. The torque and the current are thus also increased continuously. The power supply system is safeguarded against peak loads and the drive train is protected against damage:

- Smooth starting / stopping, e.g. for conveyor belts
- No pressure surges, e.g. for pumps
- Increased service life of the pipe system, e.g. for compressors
- Reduced starting current, e.g. for agitators
- Reduced stress on gearbox and V belt, e.g. for saws

3.9 Selection of the soft starter using the Simulation Tool for Soft Starters

The screenshot shows the Siemens STS - Simulation Tool for Soft Starters interface. The main window displays the configuration for a 3RW5226 soft starter. The left sidebar lists several recommended soft starters with their parameters:

- 3RW5226**: Estimated starting time: 4,9 s, Max No. Starts / h: 25 x, Rated current: 77 A, Class 10A, Thermal load: 4 %.
- 3RW5224 (Inside Delta)**: Estimated starting time: 4,9 s, Max No. Starts / h: 25 x, Rated current: 81,4 A, Class 10A, Thermal load: 4 %.
- 3RW5526**: Estimated starting time: 4,9 s, Max No. Starts / h: 25 x, Rated current: 77 A, Class 10A, Thermal load: 4 %.
- 3RW5524 (Inside Delta)**: Estimated starting time: 4,9 s, Max No. Starts / h: 25 x, Rated current: 81,4 A, Class 10A, Thermal load: 4 %.

The main configuration area for the 3RW5226 shows the following details:

- Estimated starting time (application)**: 4,9 s
- Max No. Starts / h**: 25 x
- Rated current**: 77 A
- Thermal load**: 4 %
- CLASS**: Class 10A

Two graphs are displayed:

- Torque / Speed**: Shows Soft start motor torque (yellow), D.O.L. motor torque (blue), and Load torque (purple). Key values include 3,2, 2,93, and 238 Nm.
- Current / Speed**: Shows Soft start current (yellow) and D.O.L. current (blue). Key values include 8,4 and 67 A.

Control parameters and options:

- Control supply voltage [V]**: AC 110 - 250
- Rated operational voltage**: 200V-480V
- Type of terminals**: Screw terminals
- Final Article No.**: 3RW5226-1AC14

Buttons at the bottom include Save as, Order, and Report.

The soft starter can be configured with the STS (Simulation Tool for Soft Starters) software. The STS suggests suitable soft starters for the respective application based on the entered motor and load data and application requirements, as well as providing information on the parameterization.

You can download the Simulation Tool for Soft Starters (STS) for free on the 3RW5 topic page (<https://support.industry.siemens.com/cs/ww/en/view/109747404>).

3.10 Structure of the article number

Digit of the article number	1st-4th	5th	6th	7th	8th	9th	10th	11th	12th
SIRIUS 3RW soft starter	3RW5	2					C		
Size of the 3RW52 soft starter			x ^{*1)}						
Rated operational current I _e of the 3RW52 soft starter				x ^{**1)}					
Connection system	<ul style="list-style-type: none"> • Applies to sizes 1 / 2 • Main circuit: Screw terminals • Control circuit: Screw terminals 				1				
	<ul style="list-style-type: none"> • Applies to sizes 3 / 4 • Main circuit: Bus connection • Control circuit: Spring-loaded terminals 				2				
	<ul style="list-style-type: none"> • Applies to sizes 1 / 2 • Main circuit: Screw terminals • Control circuit: Spring-loaded terminals 				3				
	<ul style="list-style-type: none"> • Applies to sizes 3 / 4 • Main circuit: Bus connection • Control circuit: Screw terminals 				6				
Control terminals with	Analog output					A			
	Thermistor motor protection					T			
Rated control supply voltage U _s ²⁾	24 V AC/DC						0		
	110 V - 250 V AC						1		
Rated operational voltage U _e	200 - 480 V AC							4	
	200 - 600 V AC							5	

¹⁾ Explanation in the following table.

²⁾ When rating the control supply voltage, pay attention to the maximum starting current when closing the bypass contacts. Refer to the technical specifications for details.

The following table shows the size and rated operational current I_e for U_e = 400 V and TU = 40 °C in a standard (inline) circuit:

Size	Rated operational current I _e of the 3RW52 soft starter	Rated operating power P _e of the 3RW52 soft starter	x [*]	x ^{**}
Size 1	I _e = 13 A	P _e = 5.5 kW	1	3
	I _e = 18 A	P _e = 7.5 kW	1	4
	I _e = 25 A	P _e = 11 kW	1	5
	I _e = 32 A	P _e = 15 kW	1	6
	I _e = 38 A	P _e = 18.5 kW	1	7
Size 2	I _e = 47 A	P _e = 22 kW	2	4
	I _e = 63 A	P _e = 30 kW	2	5
	I _e = 77 A	P _e = 37 kW	2	6
	I _e = 93 A	P _e = 45 kW	2	7

3.10 Structure of the article number

Size 3	$I_e = 113 \text{ A}$	$P_e = 55 \text{ kW}$	3	4
	$I_e = 143 \text{ A}$	$P_e = 75 \text{ kW}$	3	5
	$I_e = 171 \text{ A}$	$P_e = 90 \text{ kW}$	3	6
Size 4	$I_e = 210 \text{ A}$	$P_e = 110 \text{ kW}$	4	3
	$I_e = 250 \text{ A}$	$P_e = 132 \text{ kW}$	4	4
	$I_e = 315 \text{ A}$	$P_e = 160 \text{ kW}$	4	5
	$I_e = 370 \text{ A}$	$P_e = 200 \text{ kW}$	4	6
	$I_e = 470 \text{ A}$	$P_e = 250 \text{ kW}$	4	7
	$I_e = 570 \text{ A}$	$P_e = 315 \text{ kW}$	4	8

3.11 Accessories

3.11.1 Accessories for 3RW52 soft starter

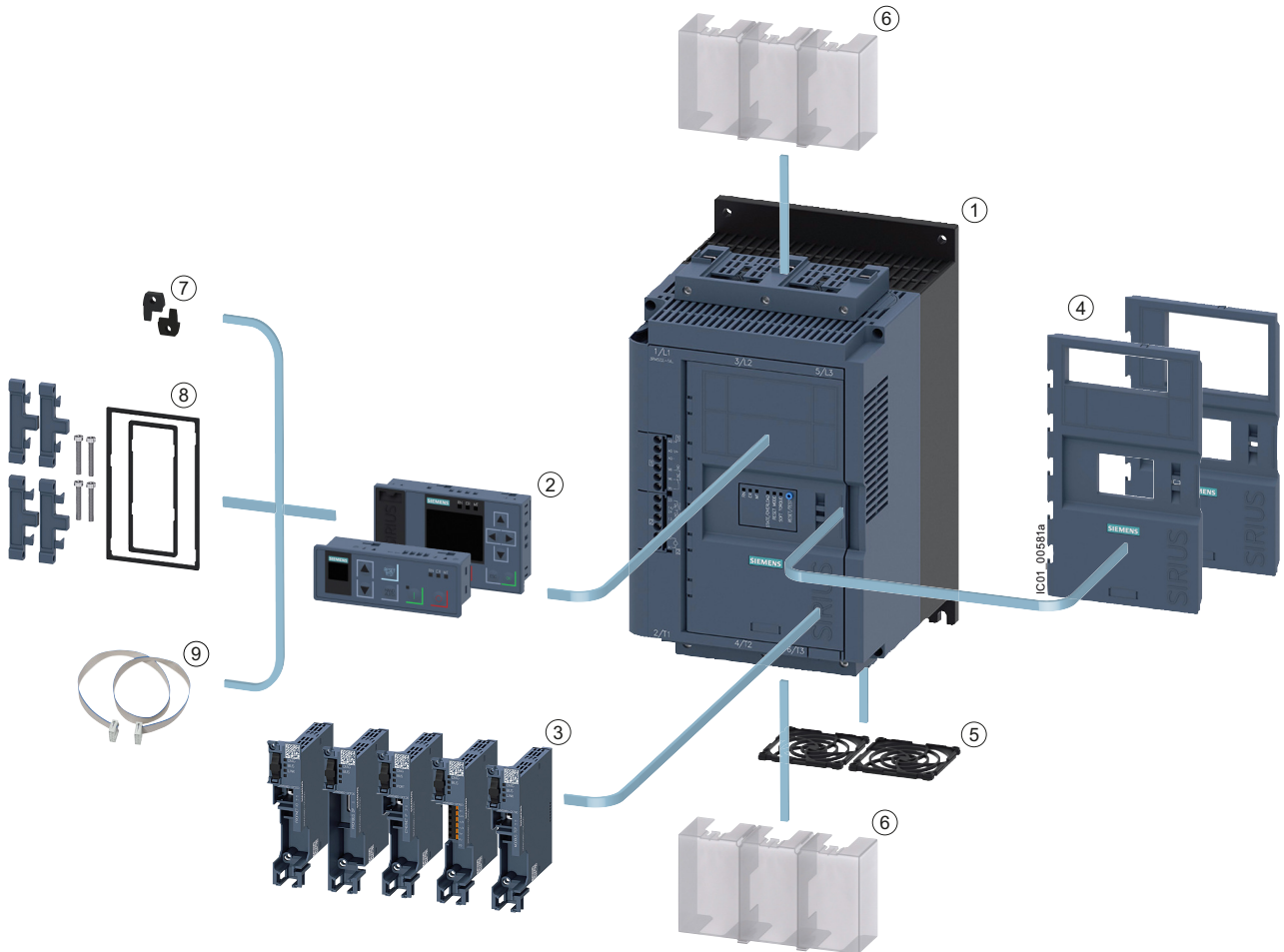

- ① 3RW52 soft starter
- ② 3RW5 HMI modules:
 - 3RW5 HMI Standard (3RW5980-0HS00)
 - 3RW5 HMI High Feature (3RW5980-0HF00)
(3RW52 soft starter with firmware version V1.1 and later)
- ③ 3RW5 communication modules:
 - PROFIBUS (3RW5980-0CP00)
 - PROFINET Standard (3RW5980-0CS00)
 - Modbus TCP (3RW5980-0CT00)
 - Modbus RTU (3RW5980-0CR00)
(3RW52 soft starter from firmware version V2.0)
 - EtherNet/IP (3RW5980-0CE00)
(3RW52 soft starter from firmware version V2.0)

- ④ Hinged cover:
 - Hinged cover with cutout for 3RW5 HMI Standard (3RW5950-0GL40)
 - Hinged cover with cutout for 3RW5 HMI High Feature (3RW5950-0GL30)
- ⑤ Fan cover:
 - Sizes 1, 2 and 3 (3RW5983-0FC00)
 - Size 4 (3RW5984-0FC00)
- ⑥ Terminal cover, top and bottom:
 - Sizes 2 and 3 (3RW5983-0TC20)
 - Size 4 (3RW5984-0TC20)
- ⑦ Push-in lugs for wall mounting (3ZY1311-0AA00)
- ⑧ IP65 door mounting kit (3RW5980-0HD00)
- ⑨ HMI connecting cable:
 - 0.1 m (3UF7931-0AA00-0)
 - 0.5 m (3UF7932-0BA00-0)
 - 1 m (3UF7937-0BA00-0)
 - 2.5 m (3UF7933-0BA00-0)
 - 5 m (3RW5980-0HC60)

Note the information in chapter Firmware update (Page 16).

3.11.2 3RW5 communication module

The following 3RW5 communication modules are available for integration of the 3RW52 soft starters in fieldbus systems:

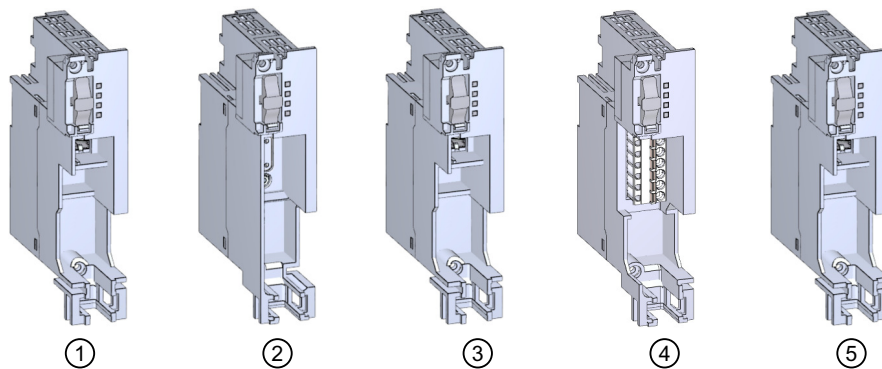

- ① 3RW5 PROFINET Standard communication module
- ② 3RW5 PROFIBUS communication module
- ③ 3RW5 communication module EtherNet/IP (3RW52 soft starter from firmware version V2.0)
- ④ 3RW5 communication module Modbus RTU (3RW52 soft starter from firmware version V2.0)
- ⑤ 3RW5 Modbus TCP communication module

Note the information in chapter Firmware update (Page 16).

Integration into the automation software

The 3RW52 soft starter can be integrated in an automation software, e.g. STEP 7 (TIA Portal) via GSD / GSDML or HSP.

You will find further information on operation of the 3RW5 communication module in the Manual for the 3RW5 communication module in question.

3.11.3 SIRIUS Soft Starter ES (TIA Portal)

SIRIUS Soft Starter ES (TIA Portal) as of V15 Update 2 is the central software for configuring, commissioning, operation, and diagnostics of 3RW5 soft starters. 3RW52 soft starters are supported depending on the firmware as of V15.1.

You connect your PC or your programming device to the 3RW5 soft starter via the local interface on the 3RW52 HMI High Feature (accessory). With the Premium or Professional license, you can also connect your PC or your programming device from a central point to the 3RW52 soft starter via the 3RW5 PROFINET or PROFIBUS communication module (accessory).

By displaying all operating data, service data and diagnostic data, SIRIUS Soft Starter ES (TIA Portal) provides reliable information, which helps you to avoid faults, or quickly locate and eliminate faults if they occur.

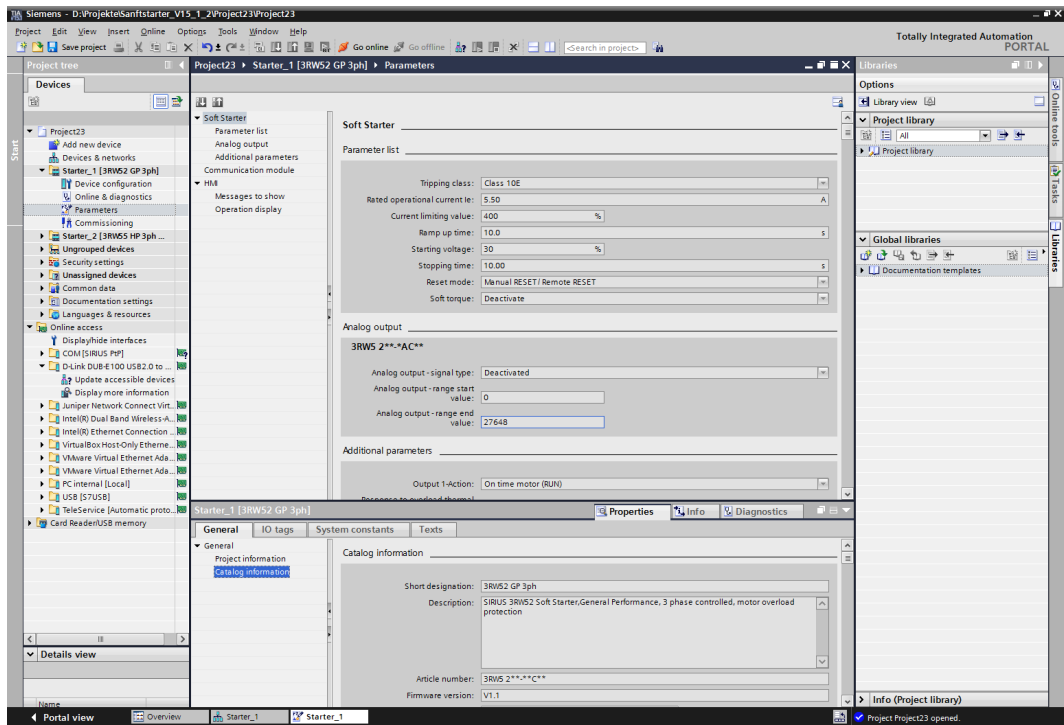

Illustration similar

Download

You can download SIRIUS Soft Starter ES (TIA Portal) via the following link (<https://support.industry.siemens.com/cs/ww/en/ps/24231/dl>).

Available versions for V15 and V15.1

Supported functions (V15.1)	SIRIUS Soft Starter ES (TIA Portal)		
	Basic	Standard	Premium
Access via local interface on the 3RW5 HMI High Feature	x	x	x
Parameter setting	x	x	x
Operator control	x	x	x
Diagnostics	x	x	x
Expert list	-	x	x
Parameter comparison	-	x	x
Service data (maximum pointer, statistic data)	-	x	x
Trace	-	x	x
Access via PROFIBUS or PROFINET	-	-	x
Teleservice via MPI	-	-	x
Routing	-	-	x
Bulk engineering (group function)	-	-	x

Versions available as of V16

Supported functions	SIRIUS Soft Starter ES (TIA Portal)	
	Basic	Professional ¹⁾
Access via local interface on the 3RW5 HMI High Feature	x	x
Parameter setting	x	x
Operator control	x	x
Diagnostics	x	x
Expert list	-	x
Parameter comparison	-	x
Service data (maximum pointer, statistic data)	-	x
Trace	-	x
Access via PROFIBUS or PROFINET	-	x
Teleservice via MPI	-	x
Routing	-	x
Bulk engineering (group function)	-	x

¹⁾ The "Professional" variant corresponds to the "Premium" version of V15.1

Additional information

You will find further information on SIRIUS Soft Starter ES (TIA Portal) and necessary versions and updates in Catalog IC 10 (<https://support.industry.siemens.com/cs/ww/en/view/109747945>) and on the 3RW5 topic page (<https://support.industry.siemens.com/cs/ww/en/view/109747404>).

3.11.4 3RW5 HMI

3RW5 HMI Standard

The 3RW5 HMI Standard can be used to monitor and control (motor ON / OFF) and the 3RW52 soft starter. The 3RW5 HMI Standard can be installed in the 3RW52 soft starter or in the control cabinet door or mounted on a wall using accessories. The 3RW5 HMI Standard has an LCD with red display illumination, LEDs for status display, and function and control keys.

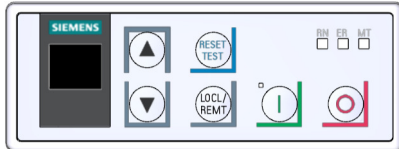

Functions

- Any changes of setting elements will be indicated immediately in the display.
- Error diagnostics are output as error numbers (Faults and remedial actions of the 3RW52 soft starter (Page 149)).
- Acknowledgment of faults and execution of user tests via the RESET / TEST key
- Starting and stopping the motor via control keys
- Switching modes via the LOCL/REMT (LOCAL / REMOTE) key.
- PROFIBUS station address setting
- Modbus RTU station address setting
- Display of the device LEDs of the 3RW5 HMI Standard shows the messages of the following devices:
 - 3RW52 soft starter
 - 3RW5 HMI Standard
 - Communication module (if there is one)

3RW5 HMI High Feature (HF)

The 3RW5 HMI High Feature can be used to parameterize, monitor and control (motor ON / OFF) the 3RW52 soft starter. The 3RW5 HMI High Feature can be installed in the 3RW52 soft starter or in the control cabinet door or mounted on a wall using accessories. It can be connected to the SIRIUS Soft Starter ES software (TIA Portal) via the local interface. The 3RW5 HMI High Feature has a TFT color display, LEDs for the status display, and function and control keys.

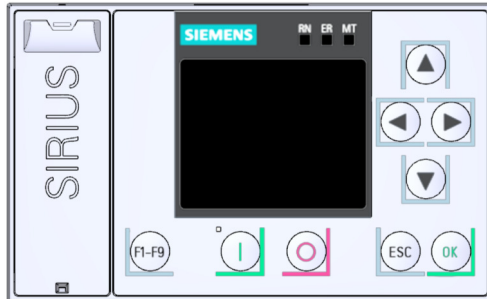

Functions

- Language selection
- Starting and stopping the motor via control keys
- Local interface
- Display of error diagnoses as plain-text messages
- Display of up to 5 measured values at the same time
- Analog output and ON / RUN relay output can be parameterized with the 3RW5 HMI High Feature.
- Setting communication parameters of 3RW5 communication modules:
 - PROFINET (device name and the IP parameters)
 - PROFIBUS (station address)
 - Modbus TCP (IP parameters)
 - Modbus RTU (station address)
 - EtherNet/IP (IP parameters)
- Backup of parameterization data on a micro SD card

3.11 Accessories

- The display of the device LEDs of the 3RW5 HMI High Feature shows the messages of the following devices:
 - 3RW52 soft starter
 - 3RW5 HMI High Feature
 - Communication module (if there is one)
- Firmware updates can be performed using the 3RW5 HMI High Feature and a micro SD card for the following devices:
 - 3RW52 soft starter
 - 3RW5 HMI High Feature
 - Communication module (if there is one)

Note the information in chapter Firmware update (Page 16).

Mounting and dismantling

4.1 Installing the 3RW52 soft starter

Procedure

1. Optionally mount the fan cover (Page 43).
2. Mount the 3RW52 soft starter on a level surface (Page 45).
3. Ensure that the permissible temperature range and the necessary clearances are complied with.
Technical data in Siemens Industry Online Support (Page 183)
4. Optionally install the 3RW5 HMI Standard (accessory) or 3RW5 HMI High Feature (accessory).
 - Installing the Standard 3RW5 HMI in 3RW52 soft starter (Page 47)
 - Installing the High Feature 3RW5 HMI in the 3RW52 soft starter (Page 49)
 - Installing the Standard 3RW5 HMI into the control cabinet door (Page 51)
 - Installing the High Feature 3RW5 HMI in the control cabinet door (Page 54)
 - Installing the Standard 3RW5 HMI on a flat surface (Page 58)
 - Installing the High Feature 3RW5 HMI on a flat surface (Page 59)
5. Optionally install the 3RW5 communication module (accessory).
You will find further information in the manual for the 3RW5 communication module in question.

Result

You have mounted the 3RW52 soft starter and can now connect it.

4.2 Mounting the fan cover

Requirements

- Screwdriver T20
- Fan cover (accessory) suitable for the size

Size	Article number of the 3RW52 soft starter	Article number of the fan cover	Number of required fan covers
Size 1	3RW521.-.....	3RW5983-0FC00	1 ¹⁾
Size 2	3RW522.-.....		2 ¹⁾
Size 3	3RW523.-.....		2
Size 4	3RW524.-.....	3RW5984-0FC00	1

¹⁾ Please observe the following notice.

Note

3RW52 soft starter without fan

The following 3RW52 soft starters do not require a fan cover:

- 3RW5213-.....
- 3RW5214-.....
- 3RW5215-.....
- 3RW5224-.....
- 3RW5225-.....

Procedure

NOTICE

Material damage due to mechanical load

Avoid a mechanical load on the fan hub when mounting the fan cover.

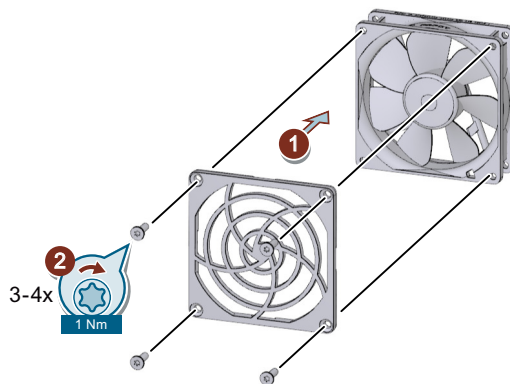

- Place the fan cover on the fan ① and fasten the fan cover ②.
 - Size 1: You require 1 fan cover and 4 of the screws packed with the product.
 - Sizes 2 and 3: You require 2 fan covers. Due to the design, 3 screws packed with the product are sufficient in each case.
 - Size 4: You require 1 fan cover and 4 of the screws packed with the product.

Result

The fan cover provides enhanced touch protection and prevents the fan from being blocked by foreign objects.

4.3 Mounting the 3RW52 soft starter on a level surface

Requirements

- Comply with the mounting positions and ambient conditions stated on the data sheet.
- Comply with the minimum clearances indicated in the following diagram.
- Level surface, e.g. sufficiently strong mounting plate
- 4 properly executed drill holes with thread or plug on the level surface.
- 4 screws of suitable size and with regular thread for insertion into the selected mounting plate or wall.
Use an additional 4 washers if the head of the screw is smaller than the specified diameter.
- Screwdriver (depending on the drive of the screws)
- If necessary, use shims and snap rings.

Size	Article number	Screws	Tightening torque
Size 1	3RW521.-.....	M6	5 Nm
Size 2	3RW522.-.....		
Size 3	3RW523.-.....		
Size 4	3RW524.-.....	M8	8 Nm

The following figure shows the minimum clearances for the 3RW52 soft starter:

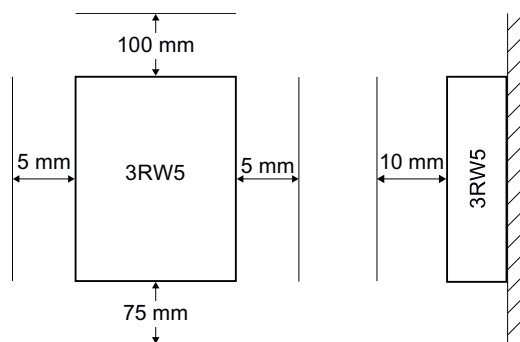

Procedure

CAUTION

Heavy device

Device can cause injury if it is dropped.

Always ask a second person to help you transport, install and remove a heavy device. Use suitable lifting equipment and wear personnel protective equipment.

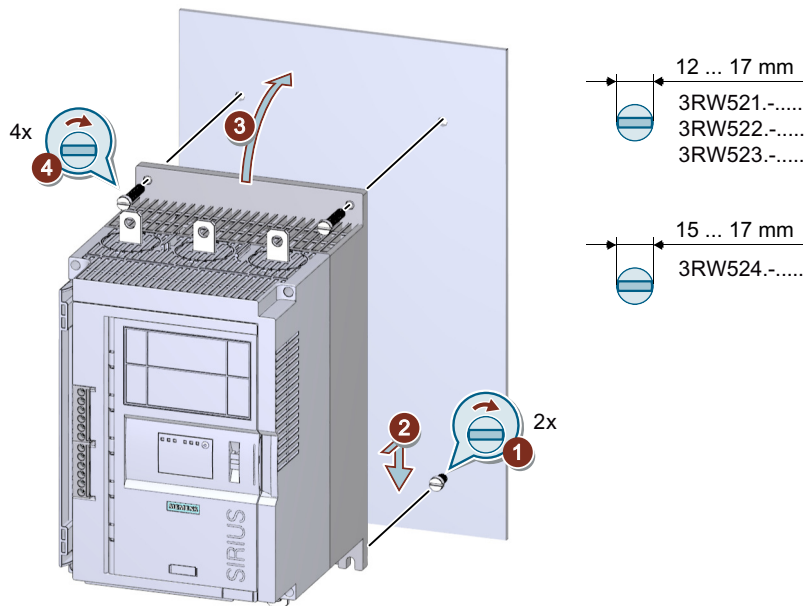

Illustration similar

- Screw the lower 2 screws into the mounting plate ①. Ensure that both screws of at least 1.5 cm (at least 2 cm for size 4) are protruding and then place the 3RW52 soft starter onto the 2 lowermost screws ② from above.
- Tilt the 3RW52 soft starter up so that it is resting level against the mounting plate ③ and tighten all 4 screws with the specified torque ④.

Result

You have mounted the 3RW52 soft starter on a level surface and can now connect (Page 66) it.

4.4 Installing, mounting and removing the 3RW5 HMI

4.4.1 Installing the Standard 3RW5 HMI in 3RW52 soft starter

Requirements

- 3RW5 HMI Standard (accessory)
- HMI connecting cable, 0.1 m (accessory)
- Hinged cover for 3RW52 with cutout for 3RW5 HMI Standard (accessory) or Cut out the hinged cover for 3RW5 HMI (Page 61)

Procedure



NOTICE

Material damage caused by electrostatic charge.

Note the information in chapter ESD Guidelines (Page 13).

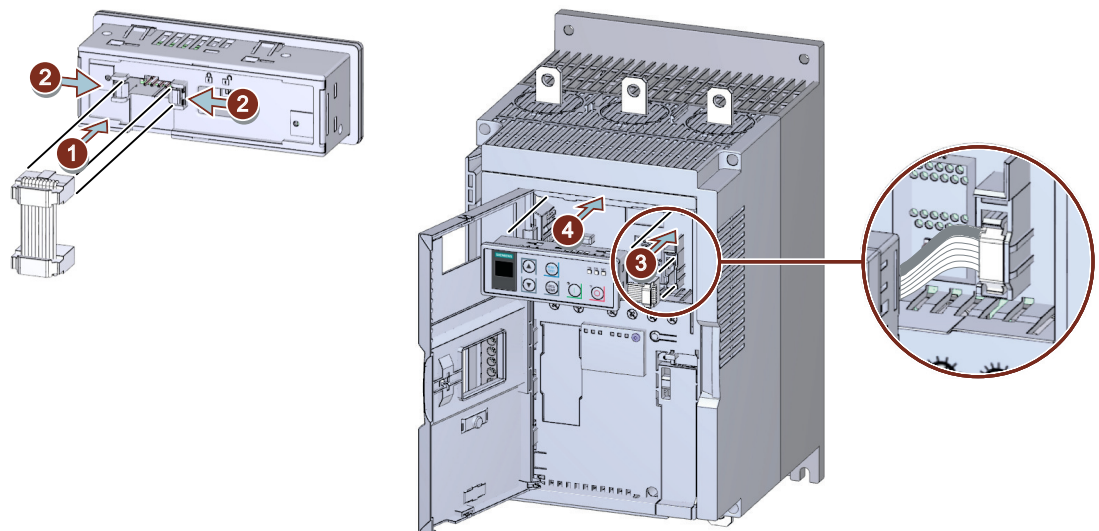

Illustration similar

- Make sure that the locking switch on the rear of the 3RW5 HMI Standard is in the required position.
You will find further information in chapter Standard 3RW5 HMI (Page 125).
- Observe the coding of the plug and socket ① / ③.
- Lock the connector in the socket ②.

4.4 Installing, mounting and removing the 3RW5 HMI

- Observe the cable routing:
 - ① Cable routing to the bottom
 - ③ Cable routing to the left
- Replace the hinged cover of the 3RW52 soft starter as required. (Page 62)

Result

You have installed the 3RW5 HMI Standard in the 3RW52 soft starter and can commission it.

4.4.2 Removing Standard 3RW5 HMI

Requirements

Installed 3RW5 HMI Standard (accessory) (Page 47).

Procedure

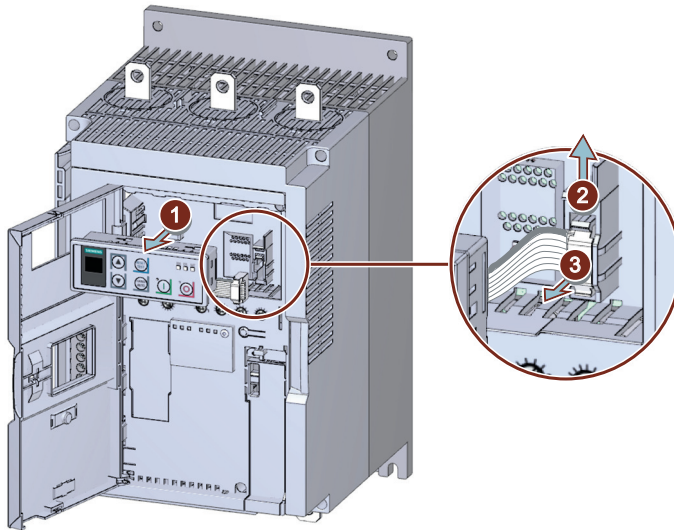

Illustration similar

- Pull the 3RW5 HMI Standard far enough out of the 3RW52 soft starter ① to gain access to the HMI connecting cable.
- Unfasten the retaining elements of the HMI connecting cable ② and pull the HMI connecting cable out of the 3RW52 soft starter ③.

Result

You have removed the 3RW5 HMI Standard. You can install the 3RW5 Standard on a surface (Page 58) or in a cabinet door (Page 51) or you can install a new 3RW5 HMI Standard (Page 47).

4.4.3 Installing the High Feature 3RW5 HMI in the 3RW52 soft starter

Requirements

- 3RW5 HMI High Feature (accessory)
- HMI connecting cable, 0.1 m (accessory)
- Hinged cover for 3RW52 with cutout for 3RW5 HMI High Feature (accessory) or Cut out the hinged cover for 3RW5 HMI (Page 61)

Procedure



NOTICE

Material damage caused by electrostatic charge

Note the information in chapter ESD Guidelines (Page 13).

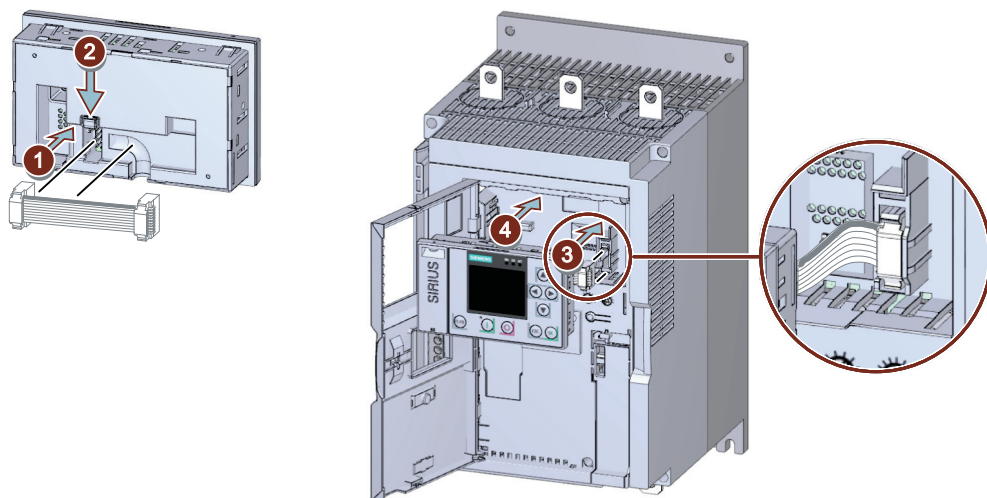

Illustration similar

- Observe the coding of the plug and socket ① / ③.
- Lock the connector in the socket ②.
- Observe the cable routing:
 - ① Cable routing to the right
 - ③ Cable routing to the left
- Replace the hinged cover of the 3RW52 soft starter as required. (Page 62)

Result

You have installed the 3RW5 HMI High Feature in the 3RW52 soft starter and can commission it (Page 106).

4.4.4 Removing the High Feature 3RW5 HMI

Requirements

- Installed 3RW5 HMI High Feature (accessory) (Page 49)
- Flat-bladed screwdriver

Procedure

NOTICE

Damage to sealing surfaces.

Make sure that the sealing surfaces are not damaged by the screwdriver.

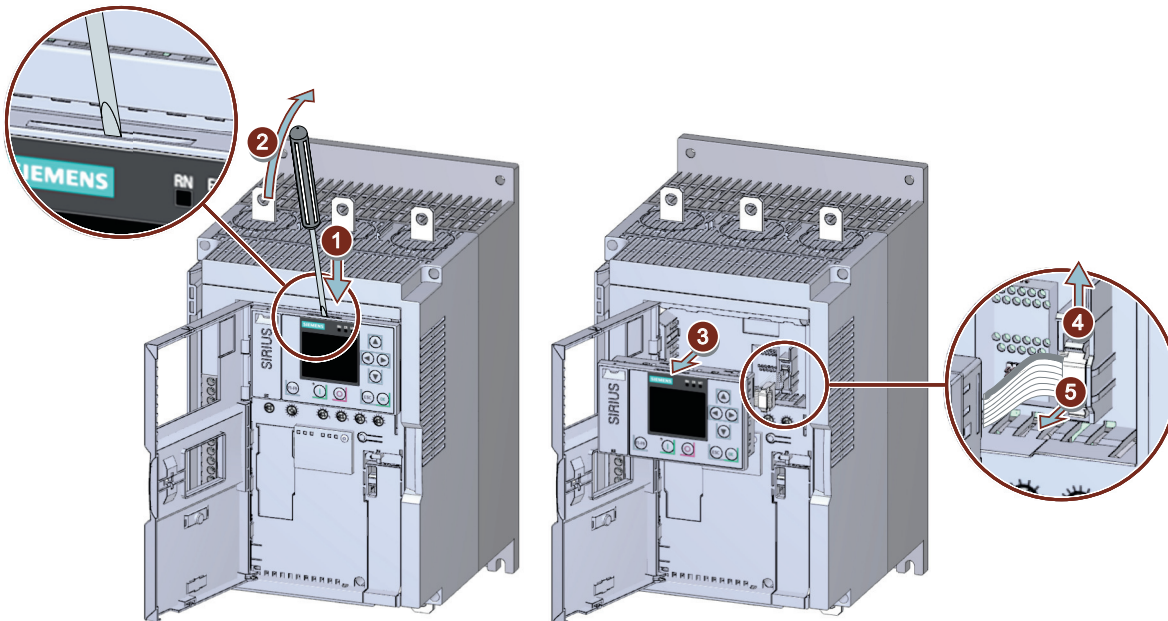

Illustration similar

- Release the 3RW5 HMI High Feature using a flat-bladed screwdriver in the groove provided ① / ②.
- Pull the 3RW5 HMI High Feature far enough out of the 3RW52 soft starter ③ to gain access to the HMI connecting cable.
- Unfasten the retaining elements of the HMI connecting cable ④ and pull the HMI connecting cable out of the 3RW52 soft starter ⑤.

Result

You have removed the 3RW5 HMI High Feature. You can install the 3RW5 HMI High Feature on a surface (Page 59) or in a cabinet door (Page 54) or you can install a new 3RW5 HMI High Feature (Page 49).

4.4.5 Installing the Standard 3RW5 HMI into the control cabinet door

Requirements

- Note the mounting positions, minimum clearances and ambient conditions stated on the data sheet.
- 3RW5 HMI Standard (accessory)
- HMI connecting cable (accessory) of suitable length connected to the 3RW52 soft starter
- Cutout of suitable size in the control cabinet door
- Device depth of the Standard 3RW5 HMI:
 - Total depth: 32 mm
 - Embedded depth: 29 mm
- Permissible wall thickness of the cabinet door:
 - Without IP65 door mounting kit: 1.5 to 3.0 mm
 - With IP65 door mounting kit: 1.0 to 7.0 mm

For using door mounting kit IP65:

- IP65 door mounting kit (accessory)
The fixing brackets with marking "001" are intended for a 3RW5 HMI Standard.
- Screwdriver PZ2

Procedure without door mounting kit IP65

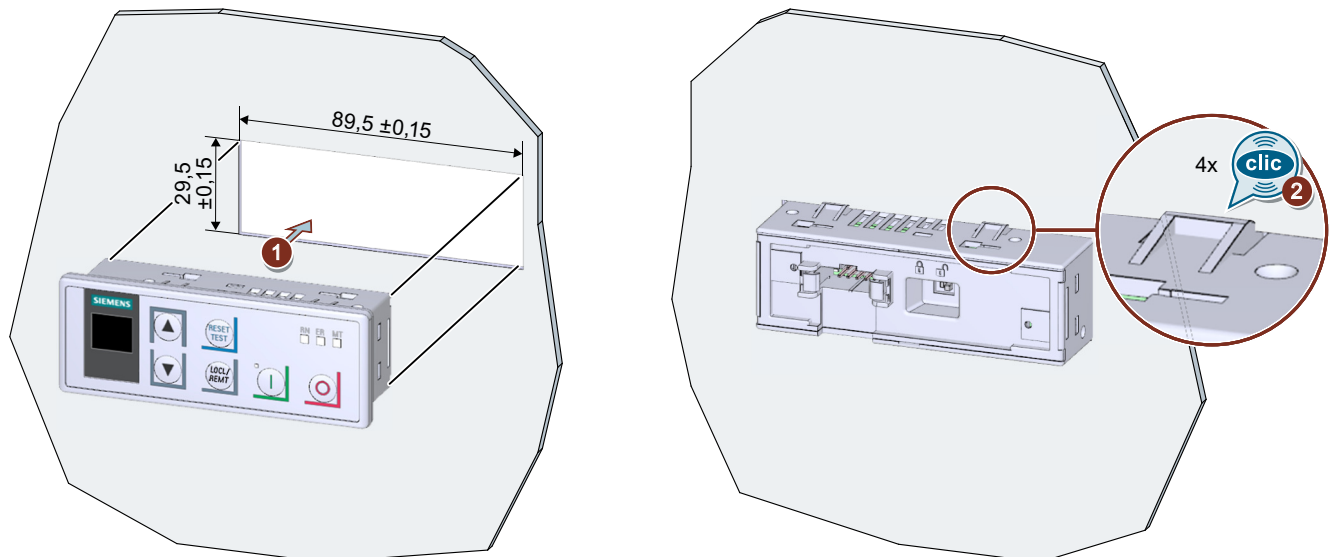

Place the 3RW5 HMI Standard in the cutout of the control cabinet door ①. Ensure that the 3RW5 HMI Standard engages audibly in the 4 fixtures ②.

Procedure with door mounting kit IP65

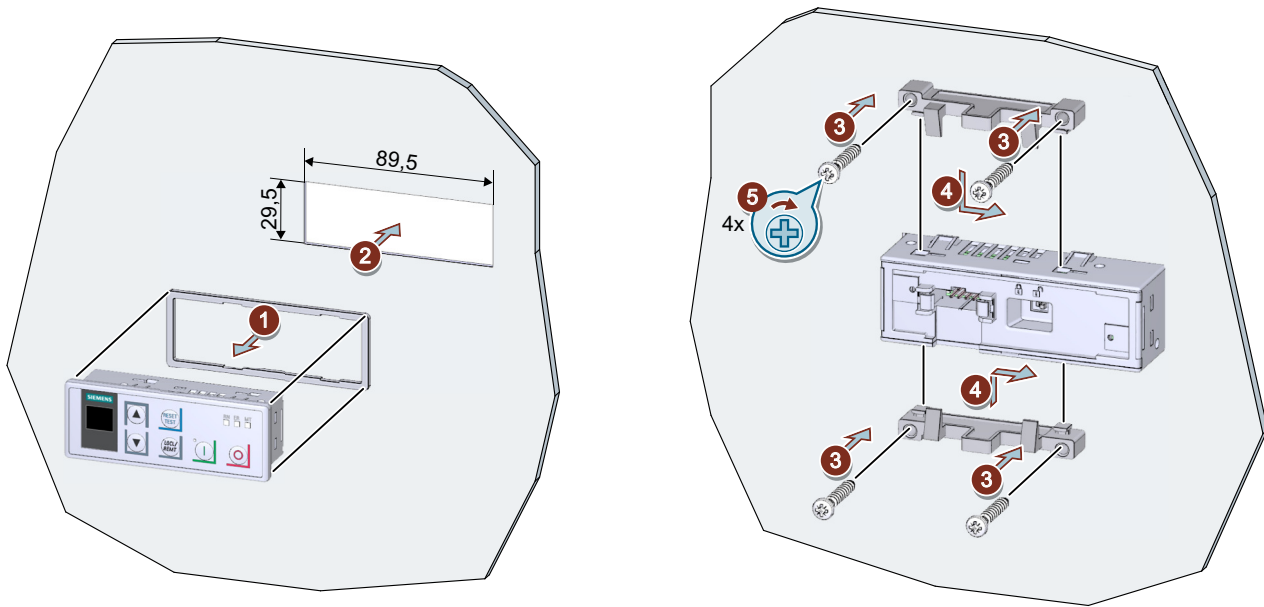

- Remove the protective film from the adhesive tape on the seal and secure the seal on the rear side of the 3RW5 HMI Standard ①.
Ensure that the seal does not overlap.
- Place the 3RW5 HMI Standard in the cutout of the control cabinet door ②.
- Continue to screw the screws into the fixing brackets ③ until they protrude approx. 10 mm at the front. Fasten the fixing brackets onto the 3RW5 HMI Standard ④.
- Tighten the 3RW5 HMI Standard with a tightening torque of 0.3 ... 0.35 Nm ⑤.
Ensure that all of the screw heads are in contact with the fixing bracket.

Procedure for installing the HMI connecting cable

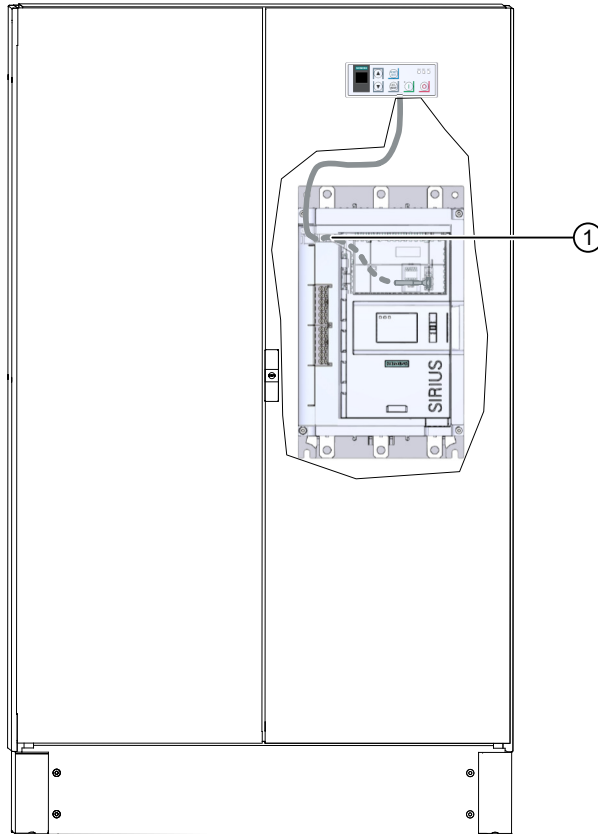

- Use the opening to the cable duct ① to install the cable in the 3RW52 soft starter.
- It is possible to route the cable up or down in the cable duct.
Make sure that you install the cable in accordance with EMC requirements. For example, install data cables separately from the motor cable. Connect both sides of shielded cables over a large surface area.

Procedure for connecting with the HMI connecting cable

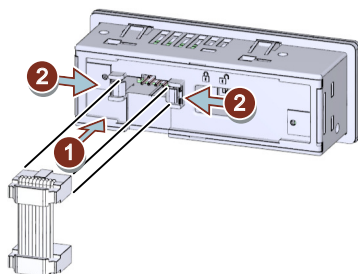

4.4 Installing, mounting and removing the 3RW5 HMI

- Observe the coding of the plug and socket ①.
- Lock the connector in the socket ②.
- The HMI connecting cable in the cable duct of the 3RW5 HMI Standard may only be routed downward.
Make sure that you install the cable in accordance with EMC requirements. For example, install data cables separately from the motor cable. Connect both sides of shielded cables over a large surface area.

Result

You have installed the 3RW5 HMI Standard in the cabinet door and can commission it.

4.4.6 Installing the High Feature 3RW5 HMI in the control cabinet door

Requirements

- Note the mounting positions, minimum clearances and ambient conditions stated on the data sheet.
- 3RW5 HMI High Feature (accessory)
- HMI connecting cable (accessory) of suitable length connected to the 3RW52 soft starter
- Cutout of suitable size in the control cabinet door
- Device depth of the High Feature 3RW5 HMI:
 - Total depth: 32 mm
 - Embedded depth: 26 mm
- Permissible wall thickness of the control cabinet door:
 - Without IP65 door mounting kit: 1.5 to 3.0 mm
 - With IP65 door mounting kit: 1.0 to 7.0 mm

For using door mounting kit IP65:

- IP65 door mounting kit (accessory)
The fixing brackets with marking "002" are intended for a 3RW5 HMI High Feature.
- Screwdriver PZ2

Procedure without door mounting kit IP65

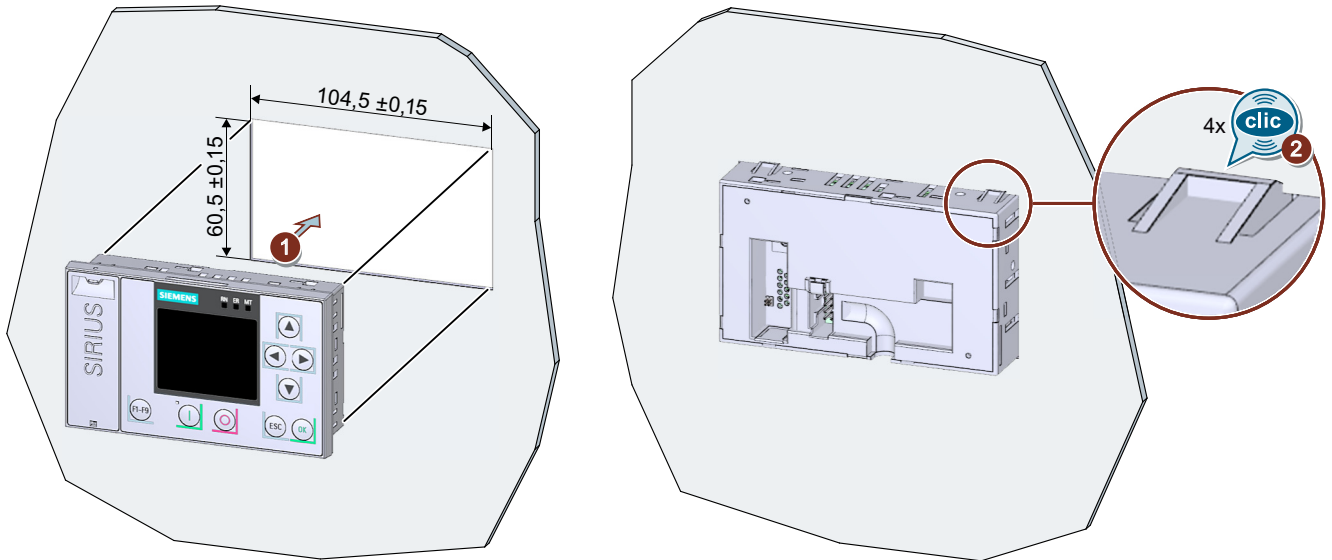

Place the 3RW5 HMI High Feature in the cutout of the control cabinet door ①. Ensure that the 3RW5 HMI High Feature engages audibly in the 4 fixtures ②.

Procedure with door mounting kit IP65

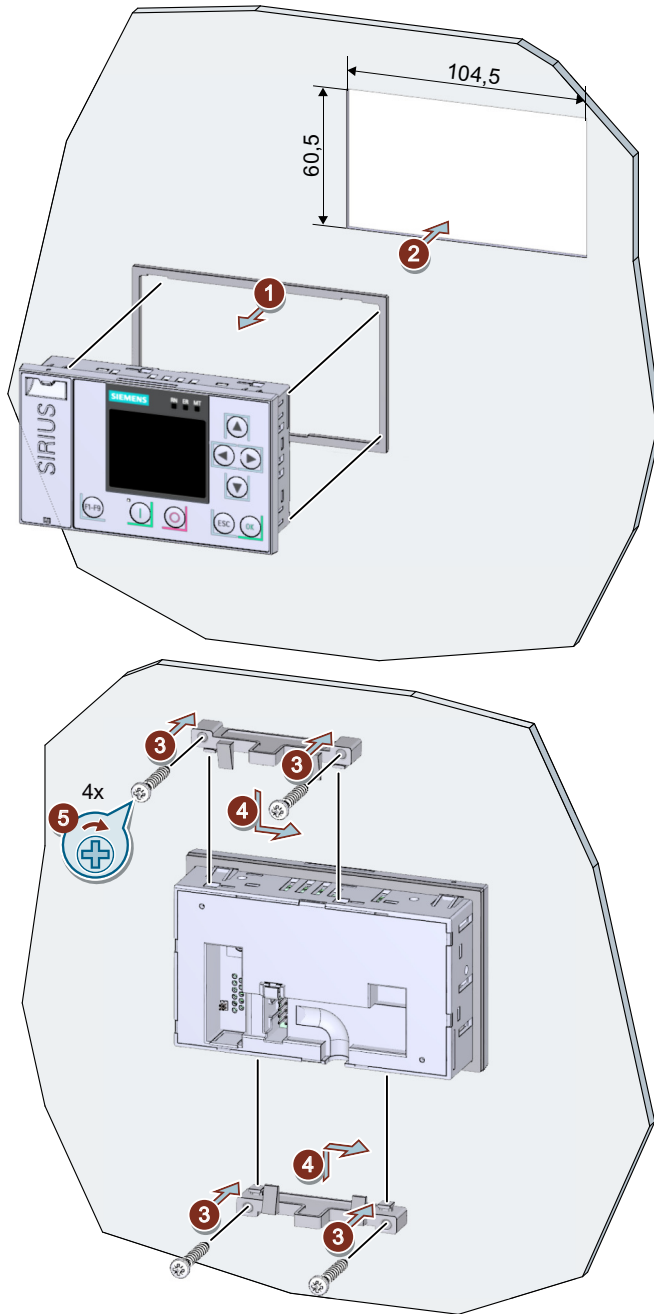

- Remove the protective film from the adhesive tape on the seal and secure the seal on the rear side of the 3RW5 HMI High Feature ①. Ensure that the seal does not overlap.
- Place the 3RW5 HMI High Feature in the cutout of the control cabinet door ②.

- Continue to screw the screws into the fixing brackets (3) until they protrude approx. 8 mm at the front. Fasten the fixing brackets onto the 3RW5 HMI High Feature (4).
- Tighten the 3RW5 HMI High Feature with a tightening torque of 0.3 ... 0.35 Nm (5). Ensure that all of the screw heads are in contact with the fixing bracket.

Procedure for installing the HMI connecting cable

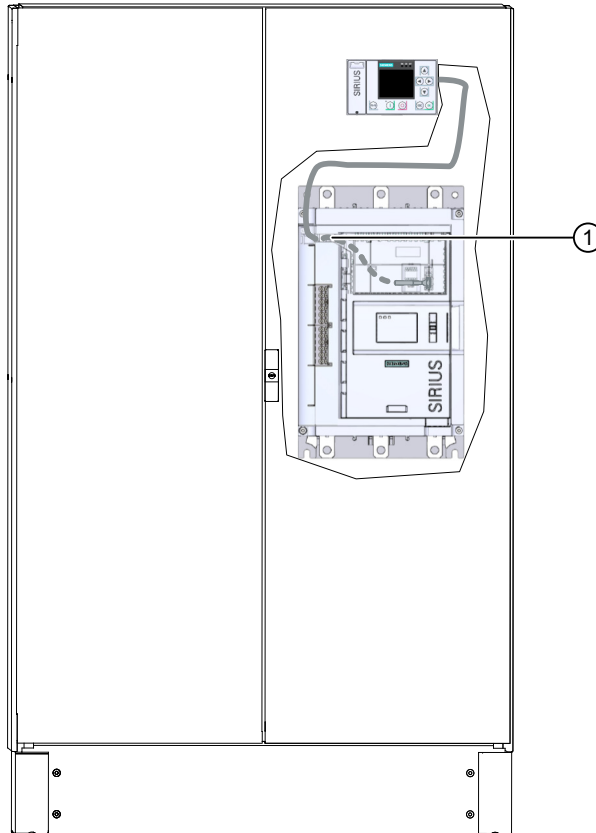

- Use the opening to the cable duct (1) to install the cable in the 3RW52 soft starter.
- It is possible to route the cable up or down in the cable duct. Make sure that you install the cable in accordance with EMC requirements. For example, install data cables separately from the motor cable. Connect both sides of shielded cables over a large surface area.

Procedure for connecting with the HMI connecting cable

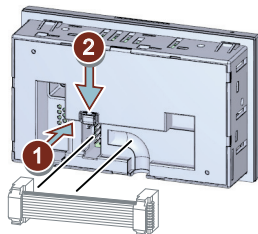

4.4 Installing, mounting and removing the 3RW5 HMI

- Observe the coding of the plug and socket ①.
- Lock the connector in the socket ②.
- The HMI connecting cable in the cable duct of the 3RW5 HMI High Feature may only be routed downward.
Make sure that you install the cable in accordance with EMC requirements. For example, route data cables separately from the motor cable. Connect both sides of shielded cables over a large surface area.

Result

You have installed the 3RW5 HMI High Feature in the cabinet door and can commission it (Page 106).

4.4.7 Installing the Standard 3RW5 HMI on a flat surface

Requirements

- Note the mounting positions, minimum clearances and ambient conditions stated on the data sheet.
- 3RW5 HMI Standard (accessory)
- Level surface, e.g. sufficiently strong mounting plate
- 2 properly executed drill holes with thread or plugs on the level surface. Refer to the drilling pattern (Page 185).
- 2 head screws M4 x 12 DIN ISO 7045 to fit the drill-holes
- Screwdriver (depending on the drive of the screws)
- 2 push-in lugs (accessory) for wall mounting
- HMI connecting cable (accessory) of suitable length connected to the 3RW52 soft starter

Procedure

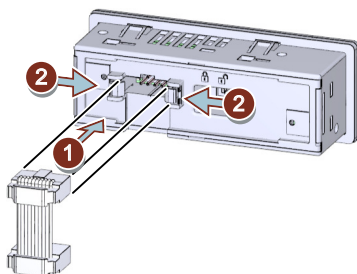

- Observe the coding of the plug and socket ①.
- Lock the connector in the socket ②.
- The HMI connecting cable in the cable duct of the 3RW5 HMI Standard may only be routed downward.
Make sure that you install the cable in accordance with EMC requirements. For example, install data cables separately from the motor cable. Connect both sides of shielded cables over a large surface area.

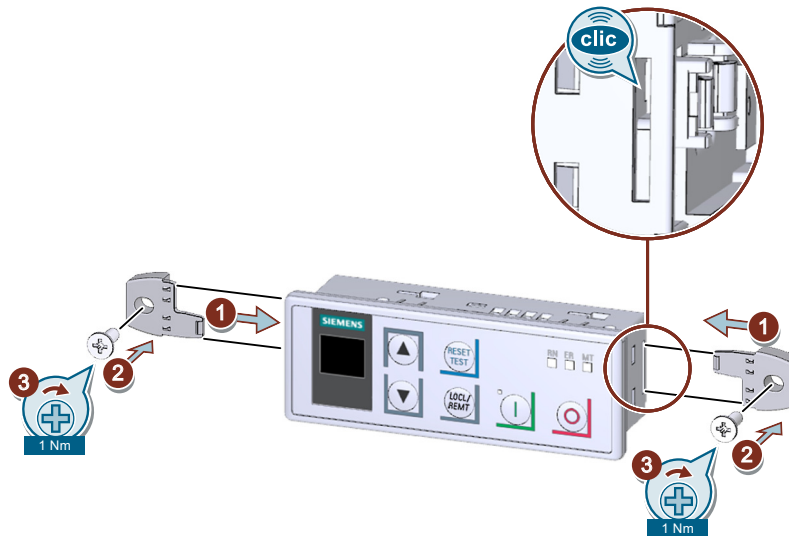

- Make sure that the locking switch on the rear of the 3RW5 HMI Standard is in the required position.
You will find further information in chapter Standard 3RW5 HMI (Page 125).
- Insert the push-in lugs into each side of the enclosure until you hear them engage ① and fix the 3RW5 HMI Standard on the wall ② / ③.

Result

You have installed the 3RW5 HMI Standard on a flat surface and can commission it.

4.4.8 Installing the High Feature 3RW5 HMI on a flat surface

Requirements

- Note the mounting positions, minimum clearances and ambient conditions stated on the data sheet.
- 3RW5 HMI High Feature (accessory)
- Level surface, e.g. sufficiently strong mounting plate
- 2 properly executed drill holes with thread or plugs on the level surface. Refer to the drilling pattern (Page 186).

4.4 Installing, mounting and removing the 3RW5 HMI

- 2 head screws M4 x 12 DIN ISO 7045 to fit the drill-holes
- Screwdriver (depending on the drive of the screws)
- 2 push-in lugs (accessory) for wall mounting
- HMI connecting cable (accessory) of suitable length connected to the 3RW52 soft starter

Procedure

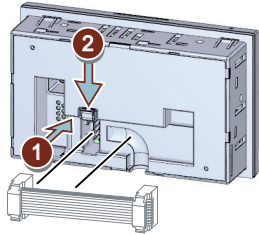

- Observe the coding of the plug and socket ①.
- Lock the connector in the socket ②.
- The HMI connecting cable in the cable duct of the 3RW5 HMI High Feature may only be routed downward.
Make sure that you install the cable in accordance with EMC requirements. For example, install data cables separately from the motor cable. Connect both sides of shielded cables over a large surface area.

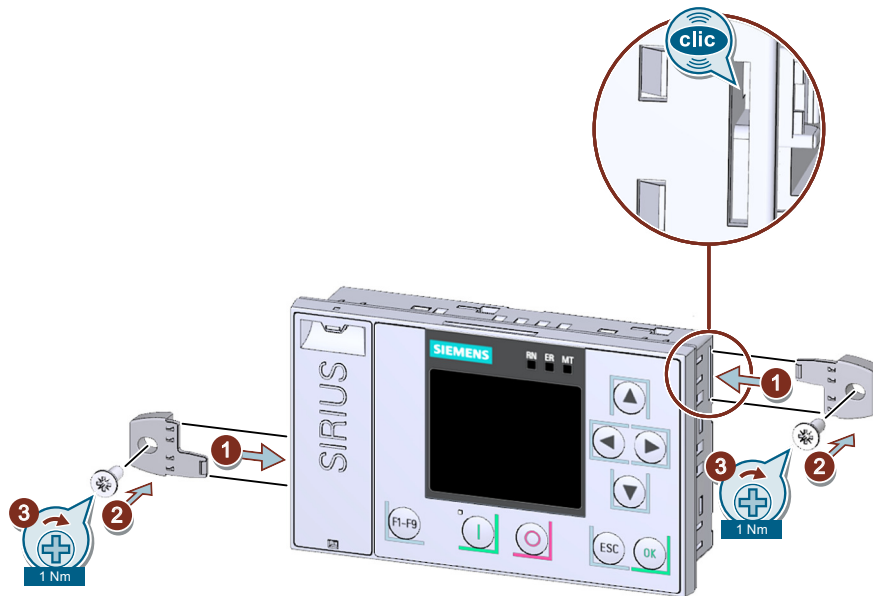

- Insert the push-in lugs into each side of the enclosure until you hear them engage ① and fix the 3RW5 HMI High Feature on the wall ② / ③.

Result

You have installed the 3RW5 HMI High Feature on a flat surface and can commission it (Page 106).

4.4.9 Cut out the hinged cover for 3RW5 HMI

Requirements

Note**Accessories**

Hinged covers with correctly sized cutout can be ordered as an accessory.

- 3RW5 HMI Standard (accessory) or 3RW5 HMI High Feature (accessory)
- Detached hinged cover without cutout (Page 62)
- Solid, sharp knife

Procedure

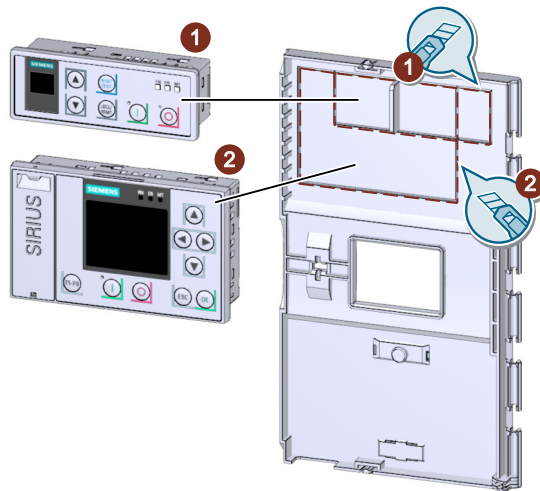

- Make sure that you know which 3RW5 HMI you require the cutout for.
Cutout 1: 3RW5 HMI Standard
Cutout 2: 3RW5 HMI High Feature
- Cut out the required cutout along the perforated line on the rear of the hinged cover using a solid, sharp knife.
- Deburr the cut edges of the hinged cover.

Result

You have cut out the hinged cover for a 3RW5 HMI and can installed a 3RW5 HMI High Feature (Page 49) or 3RW5 HMI Standard (Page 47) in the 3RW52 soft starter.

4.4.10 Replacing the hinged cover of the 3RW52 soft starter

Requirements

- Optional accessories:
 - Hinged cover with cutout for Standard 3RW5 HMI
 - Hinged cover with cutout for High Feature 3RW5 HMI

Procedure

NOTICE

Damage to the HMI display.

Ensure that the display of the 3RW5 HMI does not sustain damage when replacing the hinged cover.

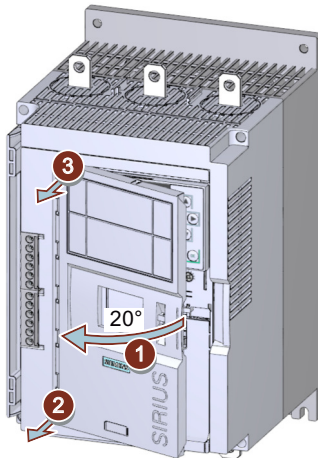

- Open the hinged cover ① at an angle of approx. 20°.
- Loosen the hinges vertical to the soft starter surface ② / ③ starting from the bottom.
- Take the cover off the 3RW52 soft starter.
- Follow the steps in reverse order to install the replacement hinged cover.

Wiring

5.1 Connections

5.1.1 Overview of all connections

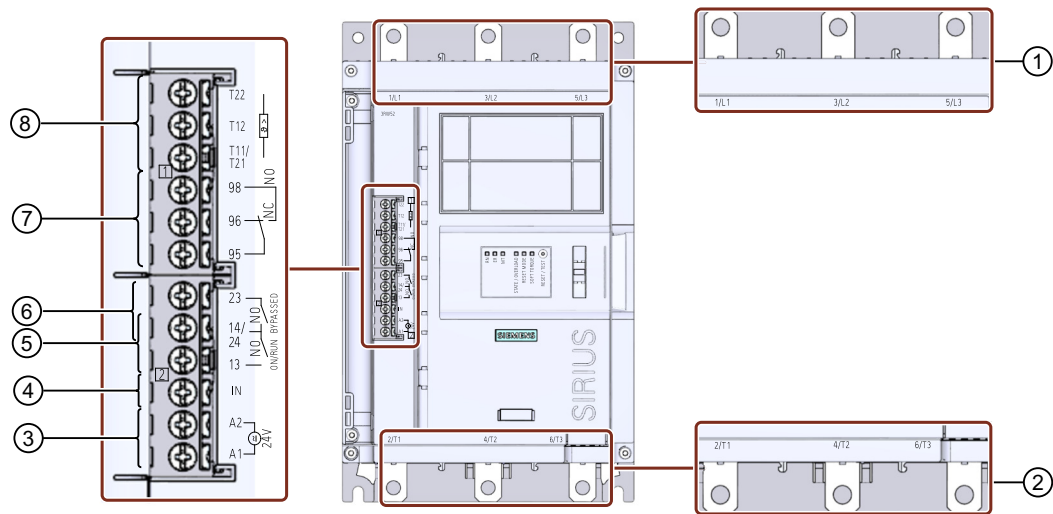

- ① Main circuit connection, line side 1/L1, 3/L2, 5/L3
- ② Main circuit connection, load (motor) side 2/T1, 4/T2, 6/T3
- ③ A1 / A2: Supply voltage (control supply voltage) for control terminals (24 V AC/DC or 110 - 250 V AC)
- ④ Input IN to switch the motor on and off
- ⑤ Output 13, 14 (output 1): For signaling the operating state ON or RUN (parameterizable (Page 85))
- ⑥ Output 23, 24 (output 2): To signal operating state BYPASSED
- ⑦ Output 95, 96 and 98 (output 3): For signaling faults
- ⑧ Dependent on the 3RW52 soft starter variant:
 - Thermistor motor protection T11 / T21, T12 and T22: Connection of a temperature sensor (optional)
 T11 / T21 - T22: Connection for Thermoclick
 T11 / T21 - T12: Connection for PTC Type A
 - Analog output AQ-, AQ I+ and AQ U+: Connection of an evaluation unit to display the motor current (optional, average phase current in %)
 AQ- / AQ U+: For signal type voltage, signal range 0 ... 10 V
 AQ- / AQ I+: For signal type current, signal range 4 - 20 mA (factory setting)

Note

Parameterizing the output 13, 14

You can parameterize the output 13, 14. You will find further information in chapters Parameterize output 13, 14 (output signal ON or RUN) (Page 85) and Parameterize the response to bus errors and output 13, 14 (ON / RUN) (Page 87).

Note

Parameterizing the analog output

You can parameterize the output of the analog output with the 3RW5 HMI High Feature (Page 99).

5.1.2 State diagrams of the inputs and outputs

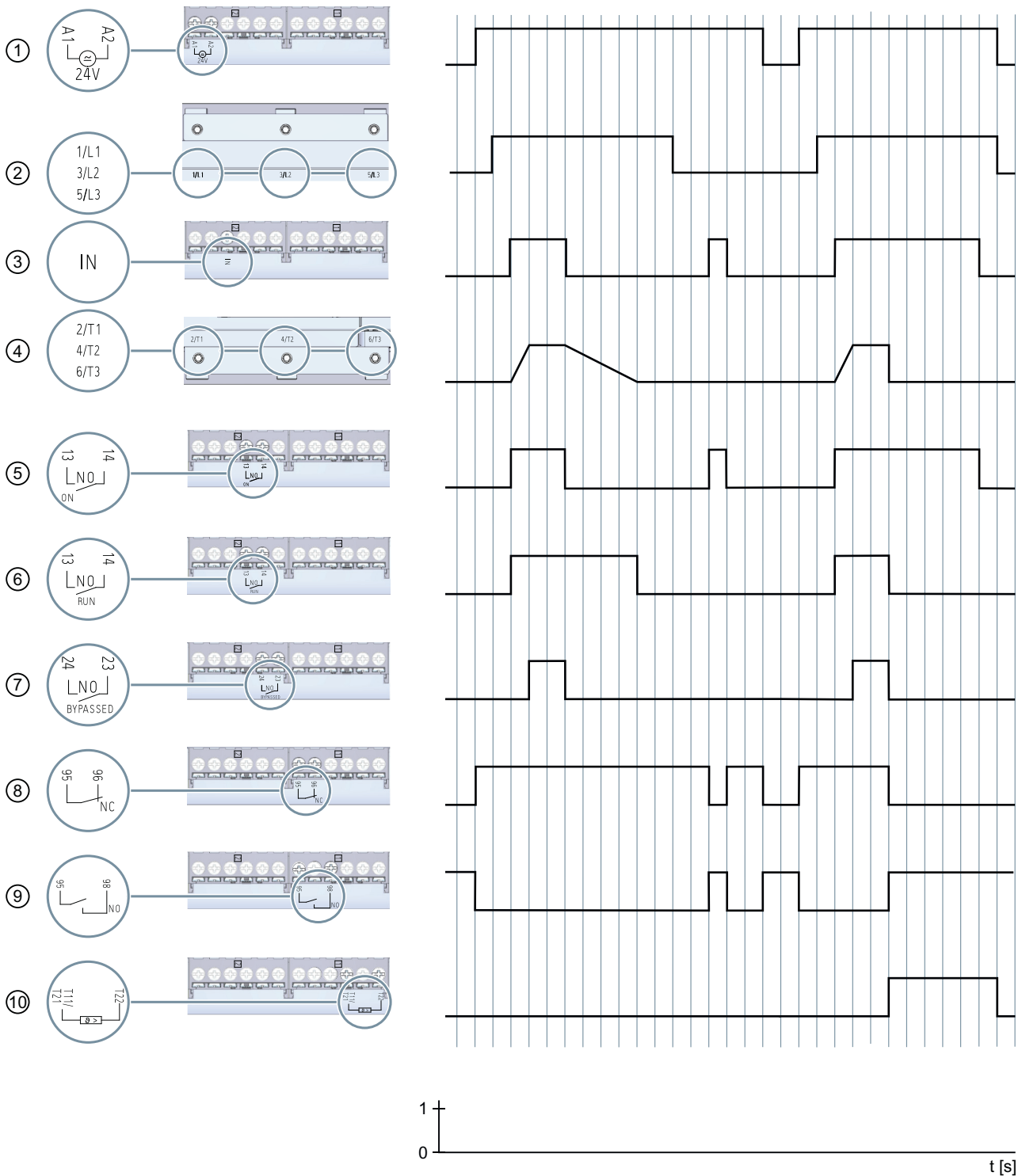

- ① Supply voltage (control supply voltage) for control terminals A1 and A2 (example model: 24 V)
- ② Main circuit connection, line side 1/L1, 3/L2, 5/L3

5.2 Connecting the 3RW52 soft starter

- ③ Input IN to switch the motor on and off
- ④ Main circuit connection, load (motor) side 2/T1, 4/T2, 6/T3
- ⑤ Output 13, 14 (output 1): Parameterized to signal operating state ON
- ⑥ Output 13, 14 (output 1): Parameterized to signal operating state RUN
- ⑦ Output 23, 24 (output 2): To signal operating state BYPASSED
- ⑧ Output 95, 96 (NC) (output 3): For signaling faults
- ⑨ Output 95, 98 (NO) (output 3): For signaling faults
- ⑩ Temperature sensor (Thermoclick)

5.2 Connecting the 3RW52 soft starter

Requirements

- Observe the conductor cross-sections and tightening torques in the data sheet or on the front of the 3RW52 soft starter beneath the hinged cover.
- Pay attention to the required tools indicated on the front of the 3RW52 soft starter beneath the hinged cover.
- Optional accessories:
 - Terminal cover for 3RW52 soft starter with sizes 2, 3, and 4

Procedure



! DANGER
Hazardous voltage. Will cause death or serious injury.
Turn off and lock out all power supplying this device before working on this device.

1. Connect the main circuit connections (line side / motor side) of the 3RW52 soft starter (Page 67).
2. Mount the terminal covers on sizes 2, 3, and 4 (Page 68).
3. Connect up the control terminals of the 3RW52 soft starter.
 - Connecting the control terminals (screw terminals) (Page 71)
 - Connecting the control terminals (spring-type terminals) (Page 72)
4. Mount the supplied cover for the control cable duct (Page 76).

Result

The 3RW52 soft starter is connected and ready to operate.

5.3 Connect the 3RW52 soft starter to the main circuit connection (line side / motor side)

Requirements

- Observe the conductor cross-sections and tightening torques in the data sheet or on the front of the 3RW52 soft starter beneath the hinged cover.
- Pay attention to the required tools indicated on the front of the 3RW52 soft starter beneath the hinged cover.
- When using a busbar connection (sizes 3 and 4), you require wrenches of width A/F of 13 and 17.

Size	Article number	Tightening torque
Size 1	3RW5.1.-....	2 ... 2.5 Nm
Size 2	3RW5.2.-....	4.5 ... 6 Nm
Size 3	3RW5.3.-....	10 ... 14 Nm
Size 4	3RW5.4.-....	14 ... 24 Nm

Procedure for screw connection - sizes 1 and 2



! DANGER

Hazardous voltage.
Will cause death or serious injury.

Turn off and lock out all power supplying this device before working on this device.

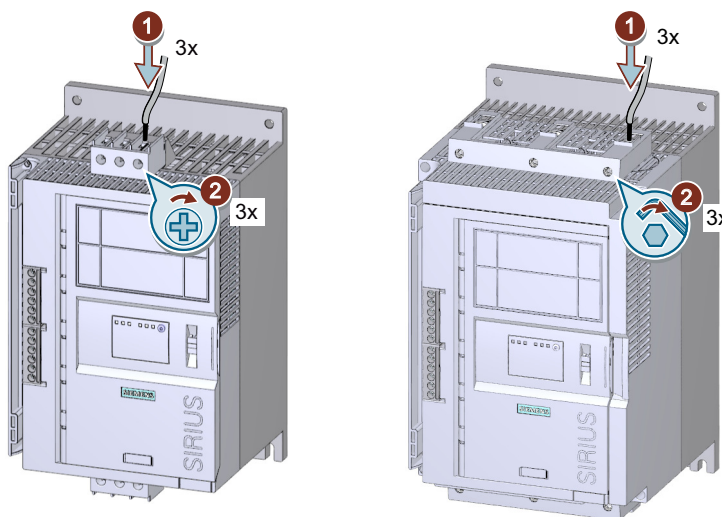

- Connect connection 1/L1, 3/L2, 5/L3 to the supply system ① and tighten the screws ②.
- Repeat steps ① / ② for connection 2/T1, 4/T2, 6/T3 with the motor.

5.4 Mounting terminal covers on main circuit connections

You can connect the 3RW52 soft starter with size 2 with bar connection even without the box terminal block.

Procedure for bar connection - sizes 3 and 4

Pay attention to the diagram on the packaging of the enclosed connection set.

- Connect the terminals 1/L1, 3/L2, 5/L3 to the power supply.
- Connect the terminals 2/T1, 4/T2, 6/T3 to the motor.

Example circuits

- Feeder assembly, type of coordination 1 fuseless (Page 189)
- Feeder assembly, type of coordination 1 with fuses (Page 190)
- Feeder assembly, type of coordination 2 (Page 191)
- Inside-delta circuit (Page 192)

5.4 Mounting terminal covers on main circuit connections

Requirements

- Terminal cover (accessory) for 3RW52 soft starter (sizes 2, 3, and 4)

Note

Touch protection by terminal cover.

Touch protection according to EN 50274 finger-safe only for vertical contact from the front.

Procedure



 DANGER
Hazardous voltage. Will cause death or serious injury.
Turn off and lock out all power supplying this device before working on this device.

5.5 Replacement of the box terminal blocks with size 2

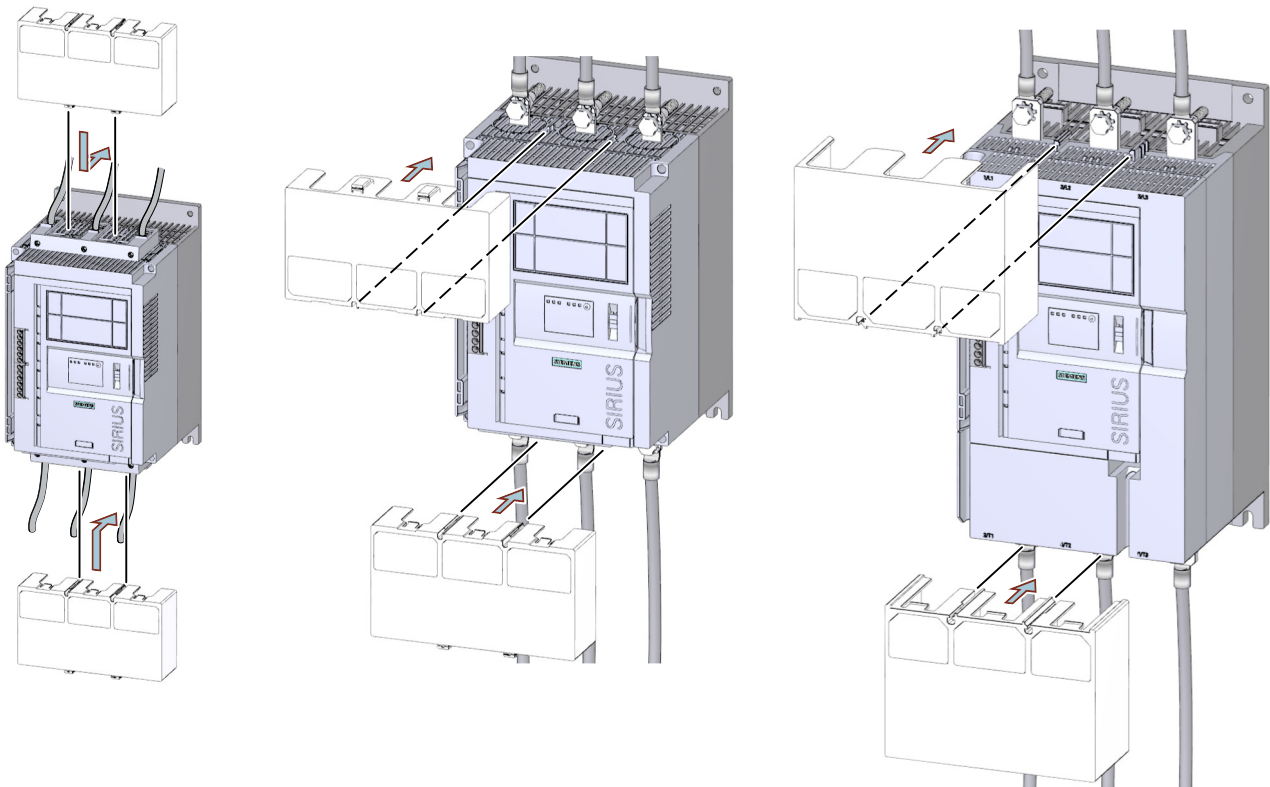

Illustration similar

- Make sure that you mount the terminal cover the right way round, as shown in the diagram.
- If you have to remove the terminal cover, proceed in the reverse order.

5.5 Replacement of the box terminal blocks with size 2

Requirements

- Pay attention to the required tools indicated on the front of the 3RW52 soft starter beneath the hinged cover.
- Main circuit connection (line supply /motor) is disconnected from the 3RW52 soft starter.

Dismantling procedure



! DANGER

**Hazardous voltage.
Will cause death or serious injury.**

Turn off and lock out all power supplying this device before working on this device.

5.5 Replacement of the box terminal blocks with size 2

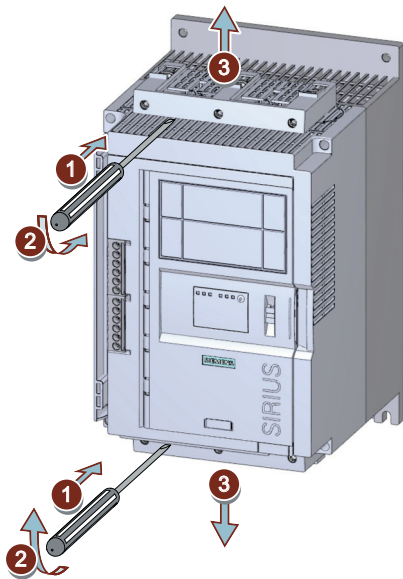

Illustration similar

- Pry the box terminal block off the main circuit connections ① / ②.
- Pull the box terminal block off the main circuit connections ③.

Assembly procedure

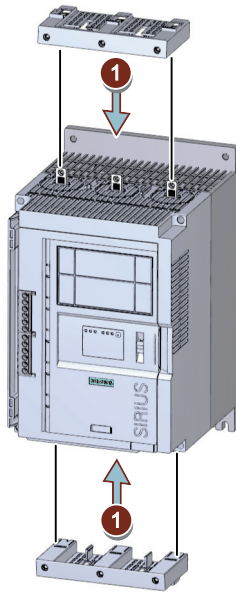

Illustration similar

- Plug the new box terminal block into the main circuit connections ①.

5.6 Connecting the control terminals (screw terminals)

Requirements

- Observe the conductor cross-sections and tightening torques in the data sheet or on the front of the 3RW52 soft starter beneath the hinged cover.
- Pay attention to the required tools indicated on the front of the 3RW52 soft starter beneath the hinged cover.

Procedure



! DANGER

Hazardous voltage.
Will cause death or serious injury.

Turn off and lock out all power supplying this device before working on this device.

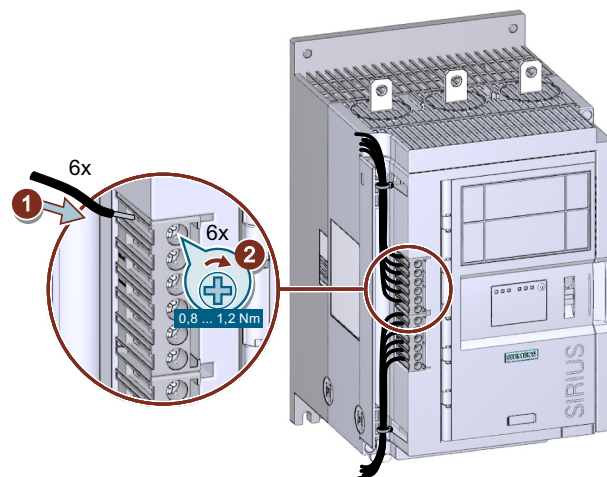

Illustration similar

Example circuits

- Control by pushbutton (Page 195)
- Control by switch (Page 196)
- Switching with supply voltage (control supply voltage) (Page 198)
- Control by PLC (Page 200)
- Actuation of a line contactor (Page 202)
- Wiring for remote RESET (Page 204)
- Connecting the temperature sensor (Page 204)
- Connecting the evaluation unit to the analog output (Page 205)

5.7 Disconnecting the control current from the screw-type terminals

Requirements

- Pay attention to the required tools indicated on the front of the 3RW52 soft starter beneath the hinged cover.

Procedure



! DANGER
Hazardous voltage.
Will cause death or serious injury.
Turn off and lock out all power supplying this device before working on this device.

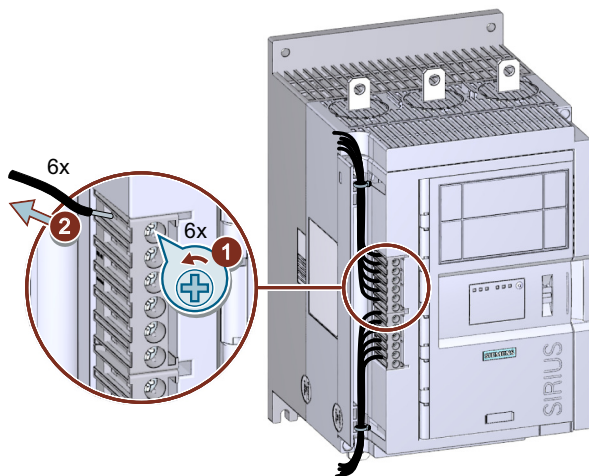

Illustration similar

5.8 Connecting the control terminals (spring-type terminals)

Requirements

- Observe the conductor cross-sections and tightening torques in the data sheet or on the front of the 3RW52 soft starter beneath the hinged cover.
- Pay attention to the required tools indicated on the front of the 3RW52 soft starter beneath the hinged cover.

Procedure

! DANGER

**Hazardous voltage.
Will cause death or serious injury.**

Turn off and lock out all power supplying this device before working on this device.

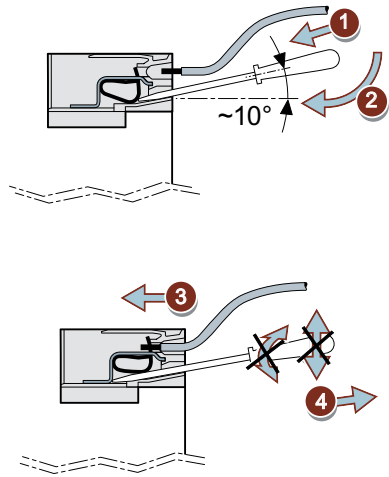
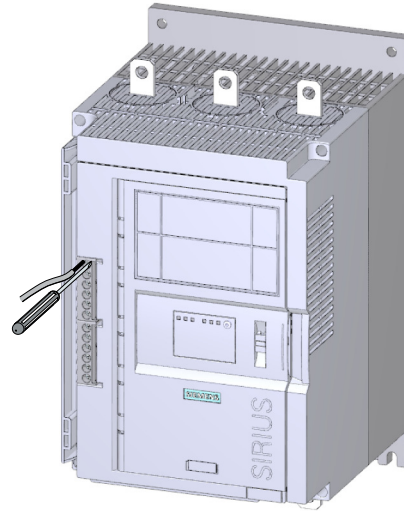

Illustration similar



Example circuits

- Control by pushbutton (Page 195)
- Control by switch (Page 196)
- Switching with supply voltage (control supply voltage) (Page 198)
- Control by PLC (Page 200)
- Actuation of a line contactor (Page 202)
- Wiring for remote RESET (Page 204)
- Connecting the temperature sensor (Page 204)
- Connecting the evaluation unit to the analog output (Page 205)

5.9 Disconnecting the control current from the spring-loaded terminals

Requirements

- Pay attention to the required tools indicated on the front of the 3RW52 soft starter beneath the hinged cover.

Procedure



! DANGER
Hazardous voltage.
Will cause death or serious injury.
 Turn off and lock out all power supplying this device before working on this device.

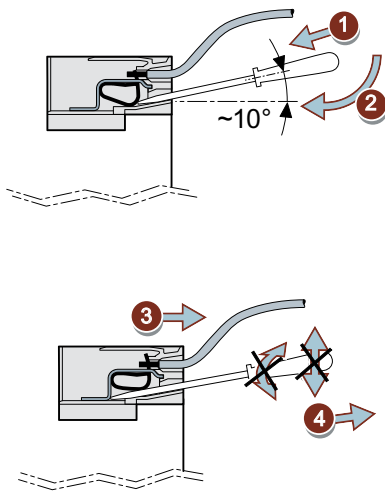
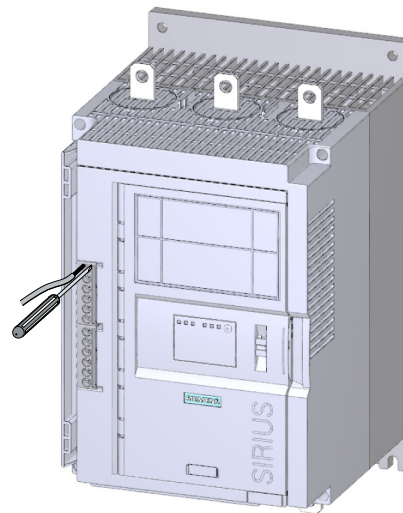

Illustration similar



5.10 Replacing the control terminals

Requirements

- Remove the cover over the control cable duct (Page 77).
- Control terminal as spare part

Type of connection	Article number
Screw terminals	3RW5980-1TR00
Spring-loaded terminals	3RW5980-2TR00

Dismantling procedure

! DANGER

Hazardous voltage.
Will cause death or serious injury.

Turn off and lock out all power supplying this device before working on this device.

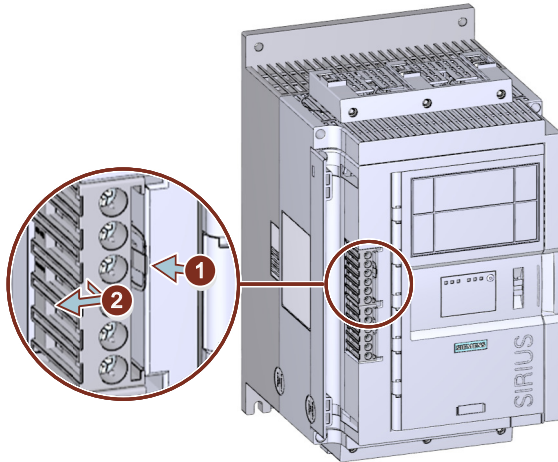

Illustration similar

- Press against the lock ① and pull the control terminal out ②.

Assembly procedure

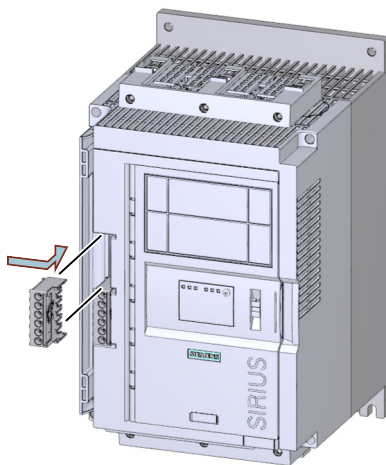

Illustration similar

- Place the control terminal onto the intended connection until the terminal engages.

5.11 Installing the cover for the control cable duct

Requirements

- 1 – 2 cable ties
- Cover for control cable channel (spare part: 3RW5950-0GD20)

Procedure

NOTICE

Damage to the cables

Make sure that the cables are not trapped prior to locking.

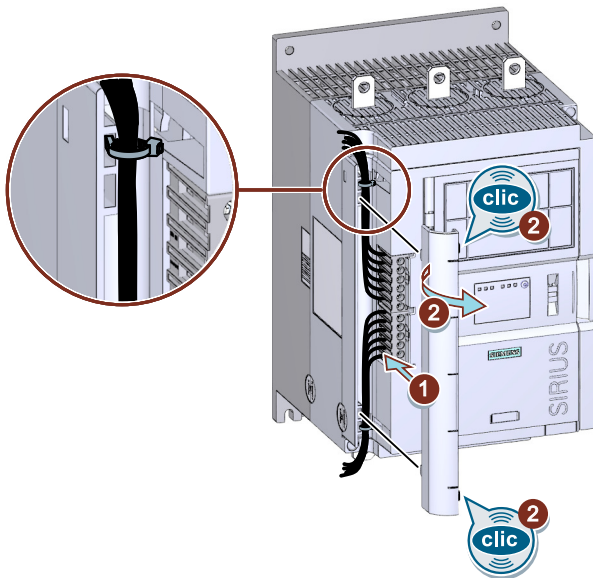

Illustration similar

- Lay the control cables in the control cable ducts and fix the control cables in place with cable ties.
- Press the cover for the control cable duct into the openings ① provided until it audibly engages ②.

5.12 Removing the cover of the control cable duct

Procedure

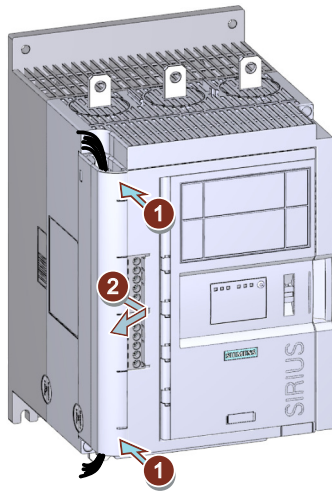
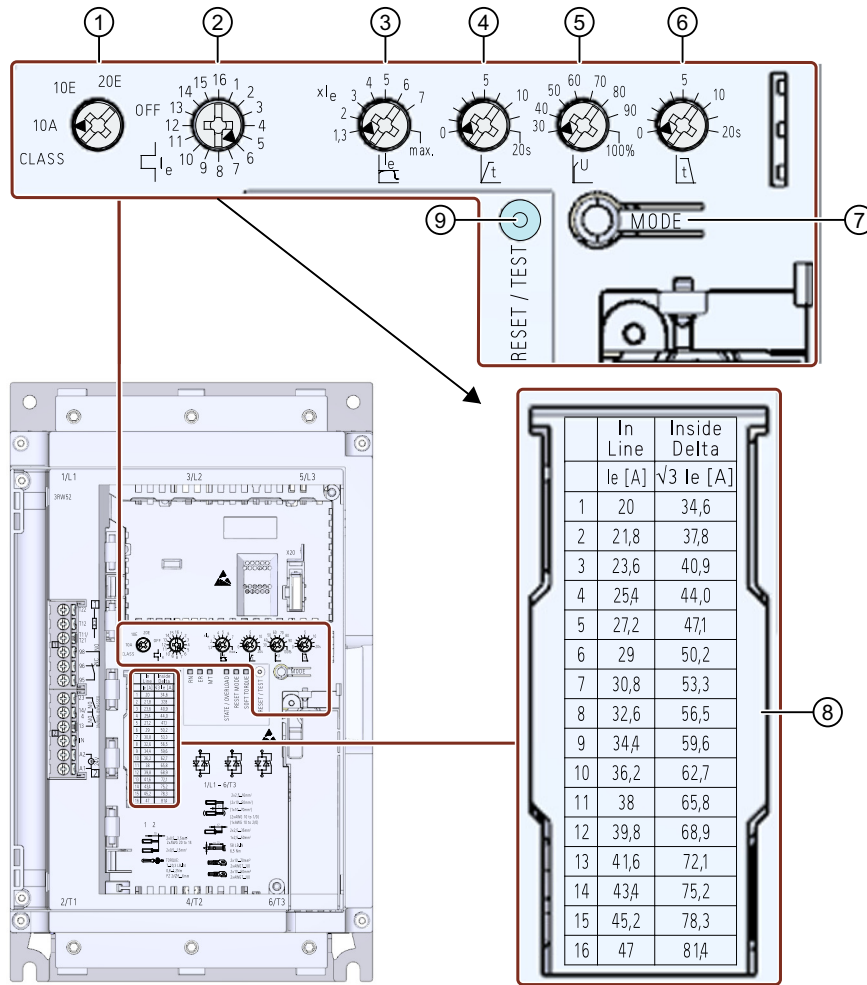

Illustration similar

- Press the cover of the control cable channel at top and bottom ① from the front and remove the cover for the control cable channel of the 3RW52 soft starter ②.

Parameter assignment

6.1 Setting elements on the 3RW52 soft starter



- ① CLASS setting for the motor overload protection
- ② Rated operational current I_e of the motor
- ③ Current limiting factor as a multiple of the set rated operational current I_e of the motor
- ④ Ramp up time
- ⑤ Starting voltage
- ⑥ Stopping time

6.1 Setting elements on the 3RW52 soft starter

- ⑦ MODE key
 - Parameterization of RESET MODE
 - Deactivation / activation of Soft torque
 - Parameterization of ON / RUN relay output
 - Parameterization of the response to bus errors
 - Restoring factory setting
- ⑧ Scale of rated operational current I_e of the motor
You will also find the applicable scale in the Technical data (Page 183).
- ⑨ RESET / TEST key
 - Acknowledges faults
 - Performing the self-test (user-test)
 - Parameterization of ON / RUN relay output
 - Parameterization of the response to bus errors
 - Restoring factory setting

Requirements

- Flat-bladed screwdriver or cross-tip screwdriver PZ1

Procedure

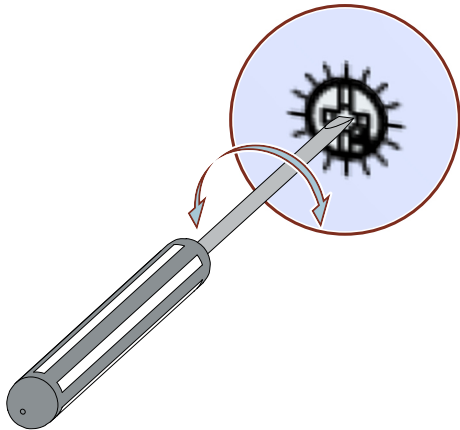

- Insert the flat-bladed screwdriver in the opening of the setting element.
- Turn the flat-bladed screwdriver until the arrow of the setting element points to the required parameter setting.

Tip

The displays on the setting elements are approximate values subject to manufacturing tolerances. To make detailed settings, use a 3RW5 HMI (accessory).

Display of the parameter value in the 3RW5 HMI (accessory)



- 3RW5 HMI Standard
While you are setting the parameters on the setting elements, the current value is shown and cyclically updated on the display of the 3RW5 HMI Standard.
- 3RW5 HMI High Feature
While you are setting the parameters on the setting elements, the current value is shown and cyclically updated on the display of the 3RW5 HMI High Feature in the "Parameters > Soft Starter > Parameter list" menu.

Display of the parameter values in SIRIUS Soft Starter ES (TIA Portal)

Brief overview: Window "Project Navigation" with current project under created Soft Starter > "Parameters" > Window "Work area" > "Soft Starter > Parameter list"

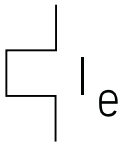
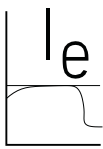
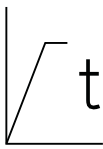
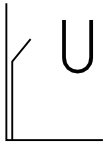
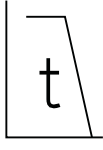
6.2 Overview of parameters

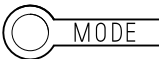
Parameter	Symbol	Setting range	Factory setting
Trip class for motor overload protection	CLASS	10A, 10E, 20E, OFF	10A
Rated operational current I_e of the motor ¹⁾		1 ... 16 ²⁾	16
Current limiting value as a multiple of the set rated operational current I_e of the motor.		<ul style="list-style-type: none"> • 1.3 ... 7 x I_e • max The "max" setting corresponds to 7 times the maximum rated operating current I_e of the 3RW52 soft starter. 	4 x I_e
Ramp up time		<ul style="list-style-type: none"> • 0 ... 20 s • With the setting "0 s", the motor is switched on with a ramp up time of approx. 100 ms. 	10 s
Starting voltage		30 ... 100%	30%
Stopping time		0 ... 20 s	0 s

Parameter	Symbol	Setting range	Factory setting
Soft torque	SOFT TORQUE <input type="checkbox"/> 	<ul style="list-style-type: none"> Off (LED off) On (LED on) 	Off
RESET MODE	RESET MODE <input type="checkbox"/> 	<ul style="list-style-type: none"> Manual RESET (LED off) Remote RESET (LED flashes green) Auto RESET (LED lit green) 	Manual RESET

- ¹⁾ The rated operational current I_e of the motor may, according to the standard, deviate by 20% from the rating plate specification of the manufacturer.
- ²⁾ For meaning of scale, refer to the laser-inscribed table on front panel of device or in the Technical Data.

6.3 Suggested settings

Application	Starting voltage [%]	Ramp up time [s]	Current limiting	Stopping time [s]
Conveyor belt (full)	70	5	$7 \times I_e$	10
Roller conveyor (full)	60	5	$7 \times I_e$	10
Compressor (without pressure)	50	4	$4 \times I_e$	Not relevant
Small ventilator (fan)	40	2	$4 \times I_e$	Not relevant
Pump ¹⁾	40	3	$4 \times I_e$	10
Hydraulic pump	40	2	$4 \times I_e$	Not relevant
Agitator	40	2	$4 \times I_e$	Not relevant
Milling machine	40	4	$4 \times I_e$	Not relevant

- ¹⁾ It is recommended that the "Soft torque" function is activated.

6.4 Parameterizing the 3RW52 soft starter

Requirements

- The 3RW52 soft starter is installed and connected.
- Supply voltage (control supply voltage) is present.
- Suggested settings (Page 82)

Note

Tips for parameterizing the 3RW52 soft starter.

Entering the motor and load data in the STS software (Page 33) will simulate the application and a suitable 3RW5 soft starter will be suggested. In addition, information regarding parameterization is also provided.

Procedure

1. You set the parameters on the setting elements of the 3RW52 soft starter (Page 79).
2. Set the motor overload protection on the setting elements "CLASS" and "I_e" (Page 115). The scale for rated operational current I_e is listed for each connection type in the table on the front of the 3RW52 soft starter and in the Technical Data (Page 183).
Make sure that the arrow of the "CLASS" setting element points to the required setting.
3. Set the soft starting on the setting elements "t" and "U" (Page 109).
4. Set the current limiting on the setting element "Current limiting value x I_e" (Page 111).
5. Set the soft stopping on the setting element "t" (Page 113).
6. Activate the Soft torque function, if required.
Note the information in chapters Setting RESET MODE and Soft torque (Page 83) and Soft Torque (Page 117).
7. Set the required RESET MODE (Page 83).
8. Set the signal of your choice at the ON / RUN relay output (Page 85).
9. Set the parameters in chapter Functions under "Additional parameters" (Page 119) if desired.

Result

The 3RW52 soft starter has been parameterized and is ready to operate. You can parameterize the signal of the analog output via a 3RW5 HMI High Feature (accessory) (Page 99).

6.5 Setting RESET MODE and Soft torque**RESET MODE and Soft torque**

With the MODE key you set the functions RESET MODE and Soft torque at the same time.

Procedure

 WARNING
<p>Automatic restart. Can cause death or serious injury.</p> <p>If a starting command is pending, a restart will be triggered automatically after the reset. This particularly applies if the motor protection has tripped. Dangerous states of the system can result.</p> <p>Reset the start command (e.g. via the PLC or switch) before performing a reset.</p> <p>To do this, for example, link the group error output (terminals 95 and 96) into the control.</p>

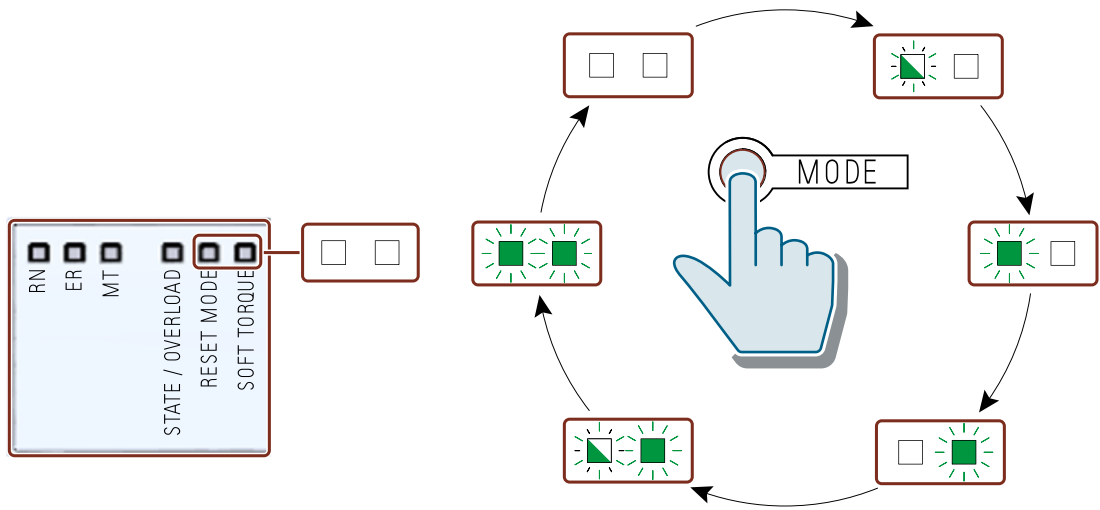

RESET MODE

Setting of the RESET MODE (Page 85) will only affect acknowledgment response of the motor overload protection.

You will find more information in chapter Faults and remedial actions of the 3RW52 soft starter (Page 149) with the comment "Depends on parameter RESET MODE".

RESET MODE LED	Set RESET MODE
□ Off	Manual RESET
⬢ Flashes green	Remote RESET
⬢ Lights up green	Auto RESET

Soft torque

You will find further information in chapter Soft Torque (Page 117).

Soft Torque LED	Set soft torque
□ Off	Off
⬢ Lights up green	On

6.6 RESET MODE

Effects of RESET MODE

Setting of the RESET MODE will only affect acknowledgment response of the motor overload protection.

You will find more information in chapter Faults and remedial actions of the 3RW52 soft starter (Page 149) with the comment "Depends on parameter RESET MODE".

Manual RESET

"Manual RESET" means that the following options are available for acknowledging faults:

- RESET / TEST Key on the 3RW52 soft starter
- RESET / TEST Key on the 3RW5 HMI Standard (accessory)
- Reset via bus interface (accessory)
- Reset via F key on 3RW5 HMI High Feature (accessory)
- Reset via 3RW5 HMI High Feature (accessory) (Diagnosis state)

Remote RESET

"Remote RESET" means that faults are acknowledged by switching the power supply (control supply voltage) off and on again. The power supply (control supply voltage) on the 3RW52 soft starter must be switched off for at least 4 seconds.

Auto RESET

"Auto RESET" means that faults are automatically reset as soon as the cause is eliminated.

6.7 Parameterize output 13, 14 (output signal ON or RUN)

Operating principle

One of these two states is output at output 13, 14:

- ON (factory setting)
- RUN

You will find further information in chapters Operating principle (Page 20) and State diagrams of the inputs and outputs (Page 65).

Use the **output function ON**, for instance, to implement latching if you selected pushbutton control.

Use the **Output function RUN** in order, for instance, to control a line contactor connected upstream.

6.7 Parameterize output 13, 14 (output signal ON or RUN)

Requirements

- Supply voltage (control supply voltage) is present.
- The 3RW52 soft starter does not signal any faults, the LED STATE / OVERLOAD is off.



Video instructions

Video instructions can be found in SIOS (<https://support.industry.siemens.com/cs/ww/en/view/109778873>):



Procedure

1. Start programming by pressing the MODE key longer than 2 seconds until the STATE / OVERLOAD LED flickers green.
Press and hold the MODE key.
2. Also press the RESET / TEST key longer than 2 seconds until the LED STATE / OVERLOAD illuminates red.
The set state of ON / RUN relay output is displayed on the SOFT TORQUE LED:

SOFT TORQUE LED	Signal set at output 13, 14
 Flashes green	ON (factory setting)
 Flickers green	RUN

3. Release the MODE and RESET / TEST keys.

6.8 Parameterize the response to bus errors and output 13, 14 (ON / RUN)

4. Switch the mode by pressing the MODE key briefly. The SOFT TORQUE LED switches between flickering green and flashing green.
You can switch between the modes at the output as often as you want.

Note

If you do not press a key in the programming mode for longer than 10 seconds, the 3RW52 soft starter automatically terminates the programming mode.

5. Terminate programming mode by pressing the RESET / TEST key for longer than 1 second until the STATE / OVERLOAD LED no longer shines red.

Further parameterization options

- 3RW5 HMI High Feature (accessory)
Menu: "Parameters > Soft Starter > ON / RUN relay output"
- Procedure in chapter Parameterize the response to bus errors and output 13, 14 (ON / RUN) (Page 87)

6.8 Parameterize the response to bus errors and output 13, 14 (ON / RUN)

Requirements



- 3RW52 soft starter from firmware version V2.0.1
- During the activation you must be able to switch off the supply voltage (control supply voltage).

Procedure







1. Press the MODE key during operation for longer than 2 seconds until the STATE / OVERLOAD LED flickers green and press and hold the MODE key.
2. Switch off the power supply (control supply voltage) of the 3RW52 soft starter for at least 5 seconds. After the 5 seconds have elapsed, you can release the MODE key.
3. Press and hold the MODE and TEST / RESET keys.
4. Switch on the power supply (control supply voltage) of the 3RW52 soft starter again. When the SOFT TORQUE and RESET MODE LEDs flicker green, the parameterization mode is active. You can release the MODE and TEST / RESET keys.

6.8 Parameterize the response to bus errors and output 13, 14 (ON / RUN)

- Select the desired parameter using the MODE key.
You can recognize your selection by the color of the STATE / OVERLOAD LED.

LED STATE / OVERLOAD	Parameters to be changed
<input type="checkbox"/> Off	No selection
 Lights up green	Control via digital input
 Lights up red	Output ON / RUN

- Change the setting of the selected parameter using the RESET / TEST key.
You can recognize your selection by the color combination of the three LEDs RN, ER and MT.
Setting the parameter "Control via digital input" (selection in Step 1):

Control via digital input / response to bus errors			
"RN" LED	"ER" LED	"MT" LED	Set parameter value
<input type="checkbox"/> Off	<input type="checkbox"/> Off	<input type="checkbox"/> Off	Manual activation
<input type="checkbox"/> Off	<input type="checkbox"/> Off	 Lights up yellow	Permanent activation
<input type="checkbox"/> Off	 Lights up red	 Lights up yellow	Activate on bus error (factory setting)
 Lights up green	 Lights up red	 Lights up yellow	No change on bus error

Setting of the parameter "Output ON / RUN" (selection in Step 1):

Output ON / RUN			
"RN" LED	"ER" LED	"MT" LED	Set parameter value
<input type="checkbox"/> Off	<input type="checkbox"/> Off	<input type="checkbox"/> Off	Output function ON
<input type="checkbox"/> Off	<input type="checkbox"/> Off	 Lights up yellow	Output function RUN

6.8 Parameterize the response to bus errors and output 13, 14 (ON / RUN)

7. Switch off the power supply (control supply voltage) of the 3RW52 soft starter for at least 5 seconds.
The set parameters and parameter values are stored.
8. Switch on the power supply (control supply voltage) of the 3RW52 soft starter again.
The set parameters and parameter values are now active.

Further parameterization options

- 3RW5 HMI High Feature (accessory)
 - Menu: "Parameters > Soft Starter > Additional parameters > Control via digital input" (3RW5 HMI High Feature with firmware version V3.0 and higher)
 - Menu: "Parameters > Soft Starter > ON / RUN relay output"
- Procedure in chapter Parameterize output 13, 14 (output signal ON or RUN) (Page 85)

Additional information

You will find further information on output 13, 14 in chapter Parameterize output 13, 14 (output signal ON or RUN) (Page 85).

You will find further information on parameter "Control via digital input" in chapter Response to bus errors / Control via digital input (Page 123).

6.9 Design and operator controls of the High Feature 3RW5 HMI

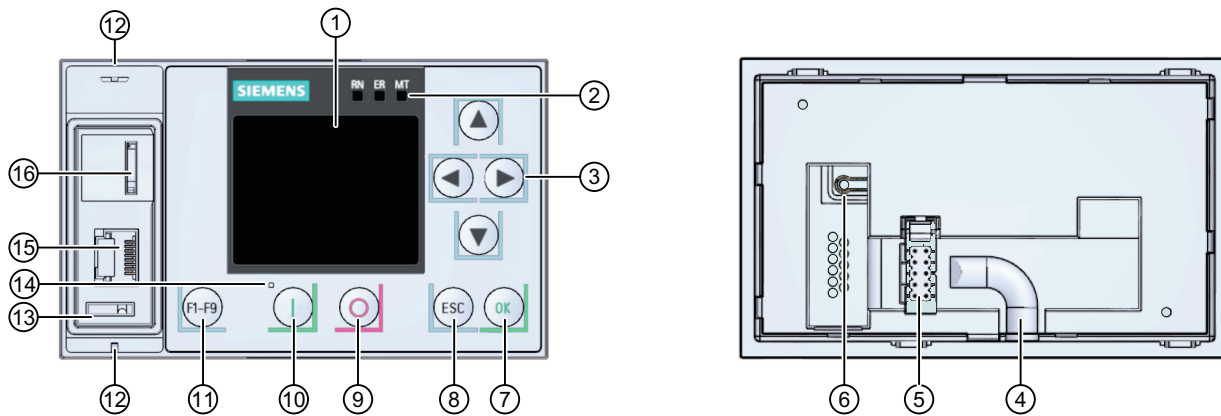











- ① Display
- ② Device LEDs (Page 145)
- ③ Navigation keys
- ④ Cable duct
- ⑤ Plug-in connection for HMI connecting cable
- ⑥ Master RESET key
- ⑦ OK key
- ⑧ ESC key
- ⑨ Motor stop key
- ⑩ Motor start key
- ⑪ Function selection key
- ⑫ Eyes for lead seals
- ⑬ Hole for mounting the interface cover
- ⑭ Status LED (Page 147)
- ⑮ Local interface (point-to-point connection between PC and 3RW5 HMI High Feature)
- ⑯ Slot for micro SD card (Page 139)

Navigating and setting

The keys are used for navigation, for selecting and setting menu items and for executing predefined actions.

Please note that parameters that are set manually using the 6 setting elements cannot be parameterized via the 3RW5 HMI High Feature.

Key	Actions
	<ul style="list-style-type: none"> Move one position to the right in the input field Displaying and switching over graphs. You will find further information in chapter Graphic display of measured values on the 3RW5 HMI High Feature (Page 131).
	<ul style="list-style-type: none"> Move one position to the left in the input field Switching over graphs. You will find further information in chapter Graphic display of measured values on the 3RW5 HMI High Feature (Page 131).
	<ul style="list-style-type: none"> Jump to next menu item Set number or letter
	<ul style="list-style-type: none"> Jump to previous menu item Set number or letter
	<ul style="list-style-type: none"> To confirm To open the menu Jump to selected menu item
	<ul style="list-style-type: none"> To exit the menu
	<ul style="list-style-type: none"> Motor stops as parameterized if the 3RW5 HMI High Feature is the master control
	<ul style="list-style-type: none"> Motor starts as parameterized if the 3RW5 HMI High Feature is the master control After an error has been acknowledged when using the 3RW5 HMI High Feature, you must repeat the ON command by pressing the "Motor Start" key.
	<ul style="list-style-type: none"> F1: LOCAL / REMOTE: Changes master control F2: Reset F3-F9 (not available for 3RW52 soft starters)
	Master RESET key for restoring the factory setting (Page 176).

Master control function of the 3RW5 HMI High Feature

The 3RW5 HMI High Feature supports you by fetching control if this is required for execution of a function. If the 3RW5 HMI High Feature does not have control, the following information appears on the display of the 3RW5 HMI High Feature when a function is entered:

"HMI does not have the control for the starter" - "Do you want the HMI to fetch the control?"

If you confirm the information with the OK key, the 3RW5 HMI High Feature fetches control (Local). To execute the function, you must then enter it again.







Refer to chapter Operating modes and master control function (Page 24).

6.10 Menu of the 3RW5 HMI High Feature

This chapter explains the full menu of the 3RW5 HMI High Feature. Depending on the following points, contents may or may not be available:

- Version of the 3RW52 soft starter
- Up-to-date status of the firmware (Page 16)
This chapter refers to the necessary firmware version of the 3RW5 HMI High Feature. If a newer firmware version of the 3RW52 soft starter is required, refer to the description of the respective function.
- 3RW5 communication module

Overview of the main menu options on the 3RW5 HMI High Feature

Monitoring	Diagnostics	Parameter
		
Overview	Security	Micro SD card ¹⁾
		

¹⁾ Only visible if a micro SD card is inserted.

Additional information

Menu item "Additional information" shows the following QR code. The link behind the QR code is the 3RW5 topic page (<https://support.industry.siemens.com/cs/ww/en/view/109747404>).



Menu of the 3RW5 HMI High Feature

	Monitoring [1/1]
↓	
Measured values	
<ul style="list-style-type: none"> - Phase currents (%) <ul style="list-style-type: none"> └ I L1 └ I L2 └ I L3 └ I L1-3 └ Show bar chart¹⁾ - Phase currents (rms) <ul style="list-style-type: none"> └ I L1 └ I L2 └ I L3 └ I L1-3 └ Show bar chart¹⁾ - Motor temperature rise - Remaining motor cooling time - Remaining switching element cooling time - Switching element heating 	
Process image	
<ul style="list-style-type: none"> - Process image input (PII) <ul style="list-style-type: none"> └ Ready (automatic) └ Motor On └ Group error └ [...] ²⁾ - Process image output (PIQ) <ul style="list-style-type: none"> └ Motor CW └ Reset └ Self-test (user-test) └ Manual operation local - input controlled 	
Additional information	

¹⁾ 3RW5 HMI High Feature firmware version V3.0 or higher

²⁾ Further menu items. Refer to chapter Monitoring the process image of the 3RW52 soft starter with the High Feature 3RW5 HMI (Page 132).

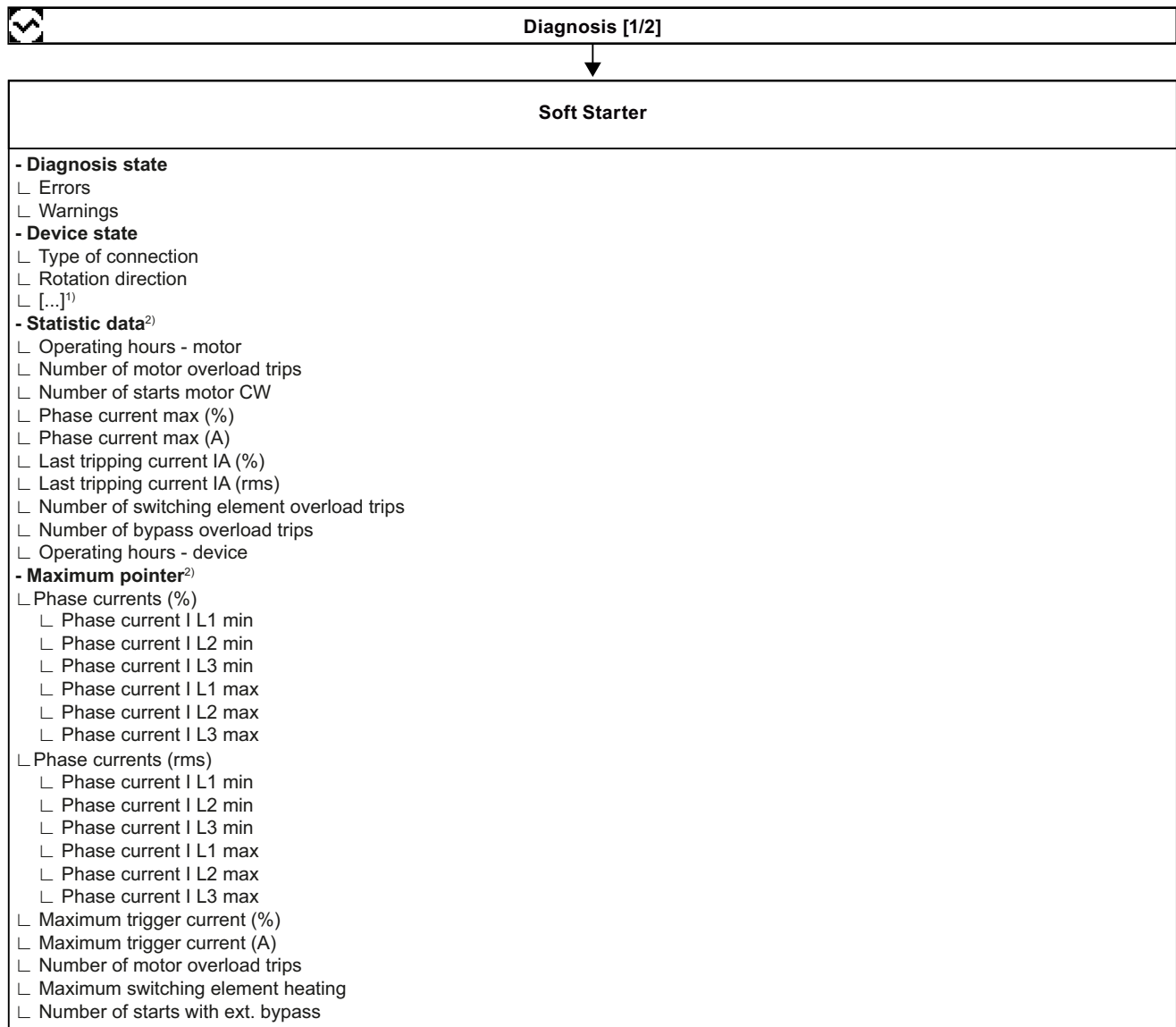

¹⁾ Further menu items. Refer to chapter Diagnostics of the 3RW52 soft starter with the 3RW5 HMI High Feature (Page 155).

²⁾ 3RW5 HMI High Feature firmware version V2.0 or higher

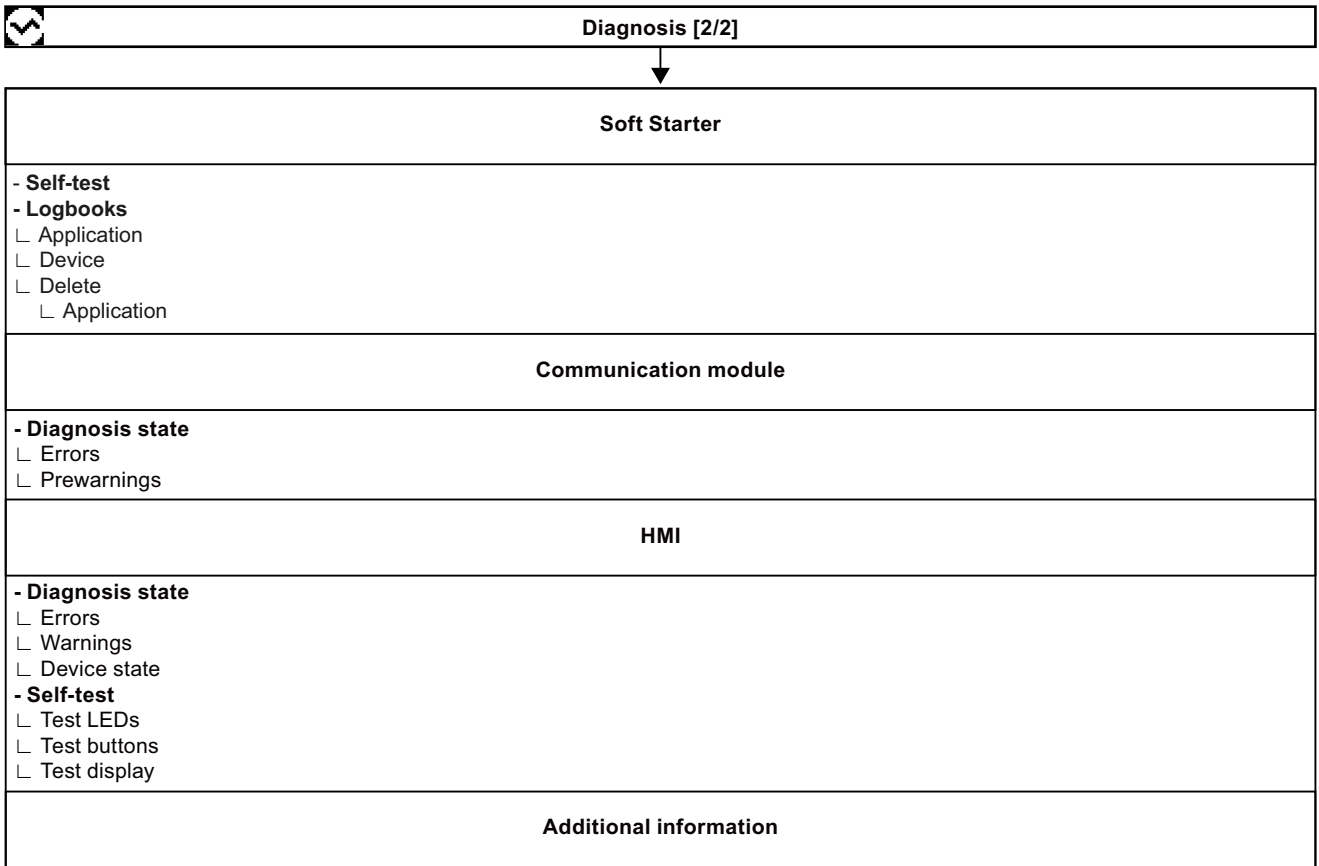

Parameter [1/3]		
Soft Starter	Setting Factory	Setting Customer
- Parameter list		
└ Trip class	CLASS 10E	
└ Rated operational current I_e	1	
└ Current limiting value	400 %	
└ Ramp up time	10 s	
└ Starting voltage	30 %	
└ Stopping time	0 s	
└ Reset mode		
└ Manual RESET	x	
└ Auto RESET		
└ Remote RESET		
└ Soft torque		
└ Deactivate	x	
└ Activate		
- Analog output		
└ Output signal type...		
└ Deactivated		
└ 4 ... 20 mA	x	
└ 0 ... 10 V		
└ Range start value	0	
└ Range end value	96	
- ON / RUN relay output	ON	
- Additional parameters		
└ Bypass operating mode	Internal bypass	
└ Typical ambient temperature	60 °C	
└ Test with small load ¹⁾		
└ Control via digital input ²⁾		
└ Manual activation		
└ Permanent activation		
└ Activate on bus error	x	
└ No change on bus error		
Communication module		
- PROFINET³⁾		
└ MAC address		
└ Device name		
└ IP address		
└ Subnet mask		
└ Router address		
- EtherNet/IP⁴⁾		
└ MAC address		
└ IP address setting		
└ IP address	0.0.0.0	
└ Subnet mask	255.255.255.0	
└ Router address	0.0.0.0	
- Modbus TCP⁵⁾		
└ MAC address		
└ IP address	192.186.42.99	
└ Subnet mask	255.255.255.15	
└ Router address	0.0.0.0	
└ Access monitoring time	5 s	

1) 3RW5 HMI High Feature firmware version V2.0 or higher

2) 3RW5 HMI High Feature firmware version V3.0 or higher

3) For 3RW5 PROFINET Standard communication module

- 4) For 3RW5 EtherNet/IP communication module
 5) For 3RW5 Modbus TCP communication module

Parameter [2/3]		
Communication module	Setting Factory	Setting Customer
- Modbus RTU¹⁾ L Station address L Baud rate L Port configuration L Access monitoring time L Silent interval time - Detected baud rate¹⁾ - Detected port configuration¹⁾ - PROFIBUS DP²⁾ L Station address L Baud rate - Group diagnostics^{2), 3)} L Group error ^{2), 3)} L Group warning ³⁾	126	
	5 s	
	126	
HMI		
- Local interface activated⁴⁾ - Local interface deactivated⁴⁾ - Timer lighting dark - Do control after log off L Continue with motor control L Stop motor and give back control - Messages to show L Errors L Enable L Disable L Warnings L Enable L Disable - Operation display L Measured value 1 L Phase current average (%) ⁵⁾ L Measured value 2 L Phase current average (rms) ⁵⁾ L Measured value 3 L Phase current I L1 (rms) ⁵⁾ L Measured value 4 L Phase current I L2 (rms) ⁵⁾ L Measured value 5 L Phase current I L3 (rms) ⁵⁾ - Languages⁶⁾	5 min	
	x	
	x	
	x	
	x	
	x	
	x	
	x	
	x	
	x	
	x	
	x	
	English	

- 1) For 3RW5 Modbus RTU communication module
 2) For 3RW5 PROFIBUS communication module
 3) For 3RW5 PROFINET Standard communication module
 4) Display depends on the current setting
 5) Further menu items. Refer to chapter Monitoring the measured values of the 3RW52 soft starter with the 3RW5 HMI High Feature (Page 129).
 6) Contains the lower level with settable languages.

Parameter [3/3]		
Factory settings	Setting Factory	Setting Customer
- Soft Starter		
- Communication module		
- HMI		
- All devices		
Additional information		

Overview [1/1]
Soft Starter
<ul style="list-style-type: none"> - Module <ul style="list-style-type: none"> L Article number L Hardware L Firmware - Module information <ul style="list-style-type: none"> L Tag function L Tag location L Installation date L Additional information - Manufacturer information <ul style="list-style-type: none"> L Manufacturer L Serial number
Communication module
<ul style="list-style-type: none"> - Module <ul style="list-style-type: none"> L Article number L Hardware L Firmware - Manufacturer information <ul style="list-style-type: none"> L Manufacturer L Serial number
HMI
<ul style="list-style-type: none"> - Module <ul style="list-style-type: none"> L Article number L Hardware L Firmware - Manufacturer information <ul style="list-style-type: none"> L Manufacturer L Serial number
Additional information

6.11 Parameterize analog output AQ via the 3RW5 HMI High Feature

Security [1/1]
<ul style="list-style-type: none"> - Local access protection <input type="checkbox"/> Define PIN¹⁾ <input type="checkbox"/> Change PIN¹⁾ <input type="checkbox"/> Delete PIN¹⁾ <input type="checkbox"/> Auto log off time <input type="checkbox"/> Log on <input type="checkbox"/> Log off
Additional information

Micro SD card [1/1]
<ul style="list-style-type: none"> - Load communication and HMI parameters to soft starter - Load communication and HMI parameters to micro SD card - Device change - Save logbooks to micro SD card - Save service data to micro SD card³⁾ - FW update <input type="checkbox"/> Soft Starter <input type="checkbox"/> HMI <input type="checkbox"/> Communication module - Download language²⁾ - Memory space <input type="checkbox"/> Complete memory <input type="checkbox"/> Free memory <input type="checkbox"/> Used memory
Additional information

¹⁾ Display depends on the current setting

²⁾ 3RW5 HMI High Feature firmware version V3.0 or higher

³⁾ 3RW5 HMI High Feature firmware version V2.0 or higher

6.11 Parameterize analog output AQ via the 3RW5 HMI High Feature

Operating principle

You can re-parameterize the output of the analog output with the 3RW5 HMI High Feature.

The actual average phase current L1 - L3 of the motor is displayed in % at the external evaluation unit via the analog output. Depending on the respective connecting terminal being used, the signal can be displayed either as current or voltage.

- Terminals: AQ- / AQ I+
Measuring range of current output: 4 - 20 mA
- Terminals: AQ- / AQ U+
Measuring range of voltage output: 0 - 10 V

Requirements

- 3RW5 HMI High Feature (accessory)
Menu: "Parameters > Soft Starter > Analog output"
- Access protection to 3RW5 HMI High Feature is not active or has been reset
- Device version with analog output
- Evaluation unit is connected properly (Page 205).

Parameters

Parameter	Description
Output signal type	<p>Via the "Output signal type" parameter, you can define with what type of signal the analog value will be output (current or voltage).</p> <ul style="list-style-type: none"> • Deactivated • 4 - 20 mA (factory setting) • 0 ... 10 mA
Range start value	<p>With parameters "Range start value" and "Range end value", you can define which value of the analog value to be output corresponds to the lower output signal value and which to the upper output signal value. The respective value depends on the coding of the measured value.</p> <p>Factory setting:</p> <ul style="list-style-type: none"> • Range start value: 0 Setting of the analog range, e.g. 4 mA = 0 • Range end value: 96 Setting of the analog range, e.g. 20 mA = 96, corresponds to 300 % of the average phase current (%).
Range end value	

Factor for calculating the output measured value

Measured value	Factor	Unit	Range of values	Coding
Phase current average (%)	3.125	%	0 ... 796.9%	0 ... 255

Example for calculating the parameters for the range start value and range end value

In this example, a pointer instrument indicates the measured value "Phase current average (%)" at the left stop with 50% (start value) and the right stop 200% (end value). You can divide the scale of the pointer instrument between the left stop and the right stop, depending on the desired resolution.

The following parameters are given as examples at this point:

- Output signal type: 4 ... 20 mA
- Range start value = desired start value (%) / factor of the measured value
- Range end value = desired end value (%) / factor of the measured value

Procedure

1. Parameterize the output signal type, e.g. 4 ... 20 mA.
2. Parameterize the range start value and the range end value taking the following factor into account:
 - Range start value (e.g. 50% / 3.125%) → 16
 - Range end value (e.g. 200% / 3.125%) → 64

Result

You have adjusted the output signal of the analog output.

PLC at analog output

You can connect the analog output of the 3RW52 soft starter to a free analog output of the PLC. Make sure that the analog input of the PLC is not connected to the supply voltage (control supply voltage) of the 3RW52 soft starter and is floating.

You will find further information in the application example in the FAQs (<https://support.industry.siemens.com/cs/ww/en/view/109778700>).

6.12 Parameterizing the High Feature 3RW5 HMI

Requirements

- 3RW5 HMI High Feature (accessory)

Setting options

- 3RW5 HMI High Feature
Menu: "Parameters > HMI"
Access protection to the 3RW5 HMI High Feature is not active or has been reset.
- With SIRIUS Soft Starter ES (TIA Portal) via the local interface on the 3RW5 HMI High Feature
Brief overview: Window "Project Navigation" with current project under created Soft Starter > "Parameters" > Window "Work area" > "HMI"
- With a fieldbus via a 3RW5 communication module:
 - With SIRIUS Soft Starter ES (TIA Portal) Premium / Professional (only via a 3RW5 PROFINET or PROFIBUS communication module)
Brief overview: See SIRIUS Soft Starter ES (TIA Portal) via the local interface on the 3RW5 HMI High Feature
 - Configuration software of the control system (e.g. STEP 7 with corresponding HSP)
 - User program

You can find further information on the parameters that can be set via the fieldbus in the manual of the respective 3RW5 communication module.

Parameters

Parameter	Description
Local interface activated (can only be set via 3RW5 HMI High Feature)	<p>The parameter is only visible if the local interface is enabled (factory setting). Disables the local interface of the 3RW5 HMI High Feature.</p> <p>Before you can connect a PC with SIRIUS Soft Starter ES (TIA Portal) to the 3RW52 soft starter via the local interface, the local interface must be enabled. You can prevent unauthorized access via SIRIUS Soft Starter ES (TIA Portal) by disabling the local interface.</p>
Local interface deactivated (can only be set via 3RW5 HMI High Feature)	<p>The parameter is only visible if the local interface is disabled. Enables the local interface of the 3RW5 HMI High Feature.</p>
Timer lighting dark	<p>If no keys on the 3RW5 HMI High Feature are pressed, the display will shut down after a specified time period has elapsed. The setting "0 min" deactivates shutdown of the display.</p> <ul style="list-style-type: none"> • Factory setting: 5 min • Setting range: 0 ... 60 min • Increment: 1 min
Do control after log off	<p>This parameter describes the response after logging off while the motor is running.</p> <ul style="list-style-type: none"> • Continue with motor control The master control is retained by the 3RW5 HMI High Feature. • Stop motor and give back control (factory setting) The motor stops and the master control is no longer with the 3RW5 HMI High Feature. Refer to chapter Operating modes and master control function (Page 24).
Messages to show	<p>If errors and/or warnings are enabled, they will appear as pop-up windows in the display of the 3RW5 HMI High Feature as soon as they occur.</p> <ul style="list-style-type: none"> • Errors <ul style="list-style-type: none"> – Enable (factory setting) – Disable • Warnings <ul style="list-style-type: none"> – Enable (factory setting) – Disable

Parameter	Description
Operation display	<p>You can select up to 5 different measured values from a list of measured values. These measured values are then shown in the operation display of the 3RW5 HMI High Feature. You will find further information on measured values in chapter Monitoring the measured values of the 3RW52 soft starter with the 3RW5 HMI High Feature (Page 129).</p> <ul style="list-style-type: none"> • Measured value 1: Phase current average (%) (factory setting) • Measured value 2: Phase current average (rms) (factory setting) • Measured value 3: Phase current I L1 (rms) (factory setting) • Measured value 4: Phase current I L2 (rms) (factory setting) • Measured value 5: Phase current I L3 (rms) (factory setting)
Languages	<p>The required language is set in the "Languages" menu.</p> <ul style="list-style-type: none"> • English (factory setting) • German • French • Spanish • Italian • Portuguese • Chinese • Additional language¹⁾ (Page 141)

¹⁾ Only visible if an additional language has been added.

6.13 Parameterize 3RW5 HMI High Feature serially / identically

If you want to parameterize multiple 3RW5 HMI High Features identically on different 3RW52 soft starters, you can parameterize them serially with a micro SD card.

Requirements

- 3RW5 HMI High Feature (accessory)
- Micro SD card (Page 139)

Procedure

1. Parameterize the 3RW5 HMI High Feature (Page 101).
2. Plug the micro SD card into the 3RW5 HMI High Feature.
3. Load the parameters of the 3RW5 HMI High Feature onto the micro SD card.
Menu: "Micro SD card > Load communication and HMI parameters to micro SD card"
Example of a folder name created on the micro SD card: "1P3RW5 xxx-xxxxx"
Note the information in chapter Micro SD card (Page 139).
4. Remove the micro SD card from the 3RW5 HMI High Feature.
5. Plug the micro SD card into the 3RW5 HMI High Feature that you want to parameterize identically with the original 3RW5 HMI High Feature.

6.13 Parameterize 3RW5 HMI High Feature serially / identically

6. Load the parameters of the 3RW5 HMI High Feature onto the 3RW5 HMI High Feature.
Menu: "Micro SD card > Load communication and HMI parameters to soft starter"
Note the information in chapter Micro SD card (Page 139).
7. If you wish, repeat the procedure for further 3RW5 HMI High Features.

Result

You have parameterized several 3RW5 HMI High Features identically on different 3RW52 soft starters.

Commissioning

7.1 Commissioning the 3RW52 soft starter

Procedure

1. Install the 3RW52 soft starter (Page 43).
2. Connect the 3RW52 soft starter (Page 66).
3. Parameterize the 3RW52 soft starter according to the application with the setting suggestions (Page 82).
If necessary, optimize the setting suggestions step by step (Page 82).
For example, you can continually adjust the current limiting factor while the motor is starting up.
4. Optionally, you can run diagnostics (Page 155) including Self-test (user-test) (Page 160) to test correct functioning of the 3RW52 soft starter.
5. Optionally seal the 3RW52 soft starter with a lead seal (Page 105).

Result

The 3RW52 soft starter is ready for operation and protected from external access.

You will find additional information on operating modes and the respective control priority in chapter Operating modes and master control function (Page 24).

7.2 Sealing the 3RW52 soft starter

Requirements

- Seal, sealing wire and a suitable sealing tool.

Procedure

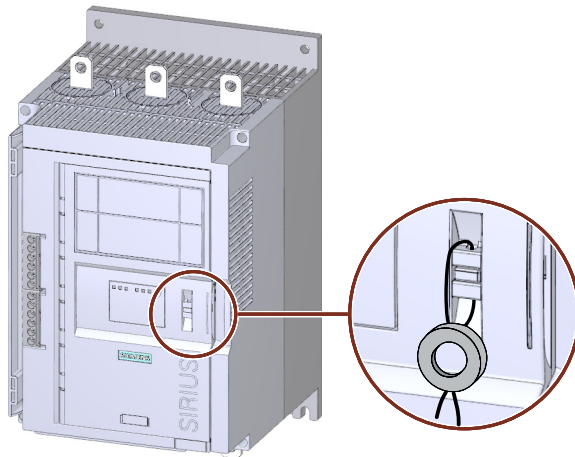

1. Push the wire through the openings provided.
2. Seal the wire to secure the hinged cover against unauthorized opening.

Result

By sealing the hinged cover, you protect the operator controls of the 3RW52 soft starter from unauthorized access. Acknowledging messages is still possible.

The interface cover of a 3RW5 HMI High Feature (accessory) can optionally also be protected from unauthorized access in this way. A 3RW5 HMI High Feature (accessory) and a 3RW5 communication module (accessory) are protected from unauthorized removal. Operation of a 3RW5 HMI (accessory) is still possible.

Tip

If you install the 3RW5 HMI High Feature (accessory) outside of the 3RW52 soft starter, use an anti-tamper seal on the interface cover to protect the local interface and the slot of the micro SD card from unauthorized access. Proceed in the same sequence as for sealing the hinged cover.

You will find further information in chapter Design and operator controls of the High Feature 3RW5 HMI (Page 90).

7.3 First commissioning of the High Feature 3RW5 HMI

Requirements

- 3RW5 HMI High Feature (accessory)
- Power supply (control supply voltage) is connected for the first time or the factory settings have been restored on the 3RW5 HMI High Feature.
- Design and operator controls of the High Feature 3RW5 HMI (Page 90)

Procedure

Set the desired language.

Result

The 3RW5 HMI High Feature is ready to use. You will find an overview of the functions in chapter 3RW5 HMI (Page 40). Note the menu structure in chapter Menu of the 3RW5 HMI High Feature (Page 92).

Functions

8.1 Soft starting

Operating principle

A voltage ramp is used to implement soft starting. The 3RW52 soft starter increases the motor voltage from a parameterizable starting voltage to the line voltage within a definable ramp up time.

Application

- Systems in which a startup of the drive without interfering jerky movements is required.
- E.g. pumps or small fans

Voltage characteristic

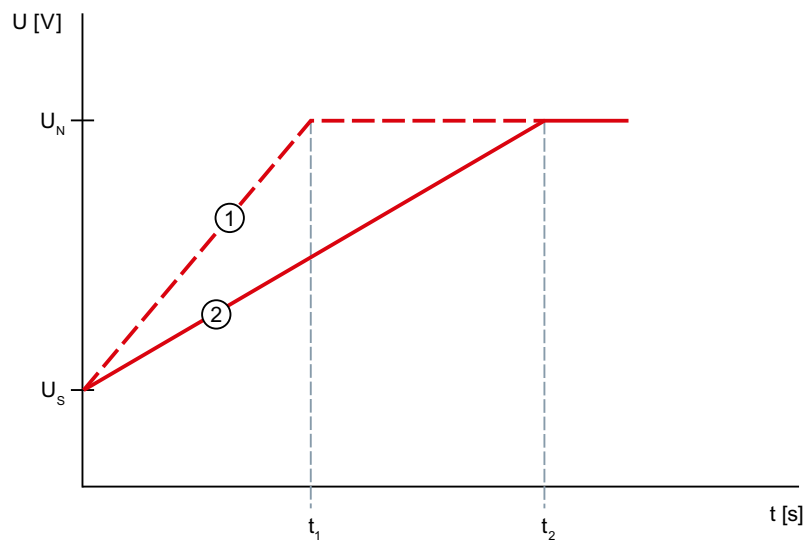

- ① Voltage ramp with short ramp up time t_1
- ② Voltage ramp with long ramp up time t_2
- U_N Line voltage
- U_s Parameterizable starting voltage
- t_1 Short ramp up time
- t_2 Long ramp up time

Torque curve

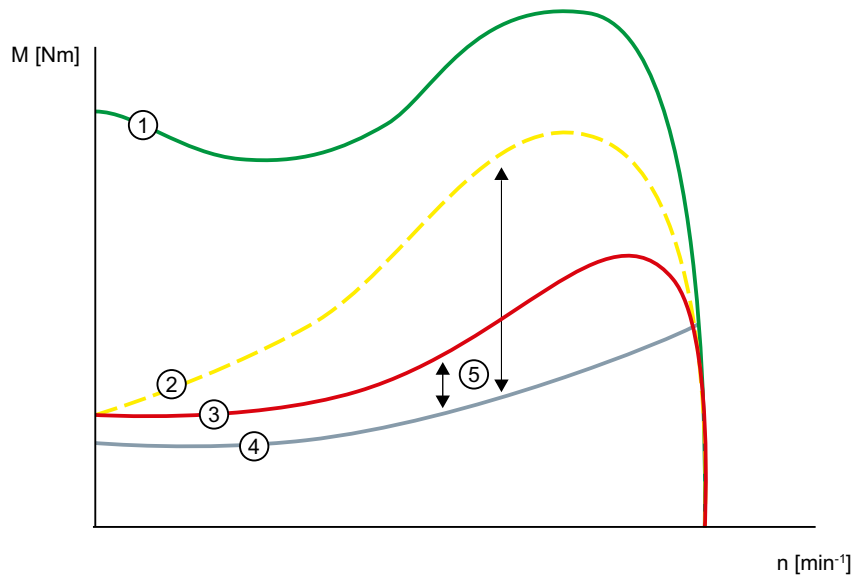

- ① Torque with direct-on-line starting without 3RW52 soft starter
- ② Torque with short ramp up time
- ③ Torque with long ramp up time
- ④ Torque of the load
- ⑤ Acceleration torque = Difference of activation torque and torque of load

Current path

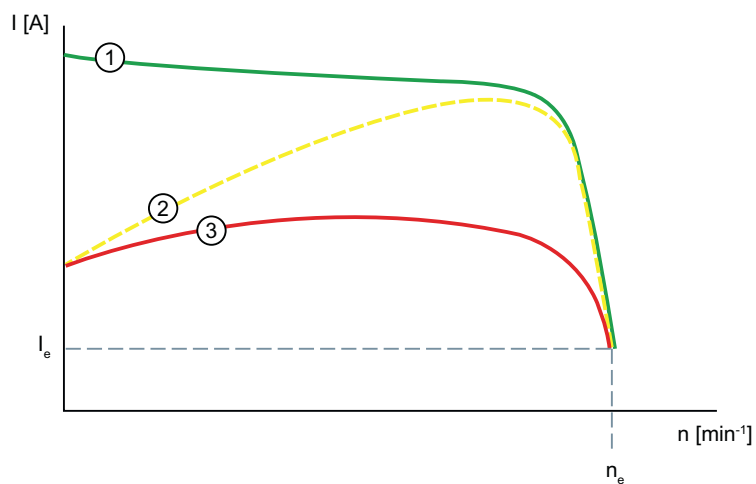

- ① Current characteristic with direct-on-line starting without 3RW52 soft starter
- ② Current characteristic with short ramp up time
- ③ Current characteristic with long ramp up time
- I_e Rated operational current
- n_e Rated operating speed of the motor

Parameters

Parameter	Description
Starting voltage	<p>The starting voltage determines the starting torque of the motor. A lower starting voltage results in a lower switch-on torque and a lower starting current. Set the starting voltage to a value that ensures that the motor starts up immediately and smoothly once the start command reaches the 3RW52 soft starter.</p> <ul style="list-style-type: none"> • Factory setting: 30% • Setting range: 30 ... 100%
Ramp up time	<p>The ramp up time determines the time taken to increase the motor voltage from the parameterized starting voltage to the line voltage. This has an influence on the motor's acceleration torque, which drives the load while the motor is starting up. A longer ramp up time results in a shorter acceleration torque across the motor ramp up time. The motor therefore runs up more slowly and smoothly.</p> <p>Set the length of the ramp up time so that the motor can reach its rated operating speed by the time the end of the ramp up reached. The actual motor starting time is load-dependent and can differ from the parameterized ramp up time.</p> <p>If you choose a time that is too short, the ramp up time ends before the motor has accelerated to speed. If the time selected is too short, a very high starting current that equals the direct starting current at the same speed will occur. In this case, the 3RW52 soft starter can switch itself off via the internal overload protection function and signal a fault.</p> <p>With the setting "0 s", the motor is switched on with a ramp up time of approx. 100 ms.</p> <ul style="list-style-type: none"> • Factory setting: 10 s • Setting range: 0 ... 20 s

8.2 Current limiting function

Operating principle

Activate the current limiting function if you want to ensure that a specific current value is not exceeded during motor starting. The motor is always started up with the voltage ramp. If the current exceeds the parameterized current limit $\times I_n$, the voltage ramp function is aborted and the current limitation function starts. The current limitation function remains active until the 3RW52 soft starter has detected the motor ramp up and the motor is in a normal operating state.

Application

- Avoiding current surges
- Reducing energy costs

Current path

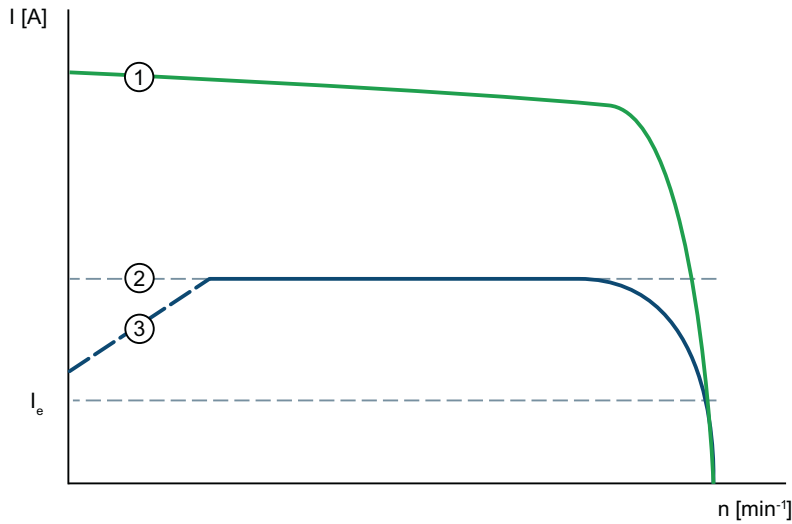

- ① Current characteristic with direct-on-line starting without 3RW52 soft starter
- ② Adjustable current limiting value
- ③ Voltage ramp
- I_e Rated operational current during rated operation

Parameters

Parameter	Description
Current limiting value	<p>In order to ensure that the drive can reach its rated speed, the minimum current limiting value that you select must be high enough to generate sufficient torque in the motor.</p> <p>A typical value is 3 to 4 times the rated operational current (I_e).</p> <p>As soon as the current limiting value is reached, the motor is started with this value until it has reached its rated operating speed. In this case, the motor starting times may be longer than the maximum parameterizable ramp up time.</p> <p>The maximum possible current limiting value for the 3RW52 soft starter ("max." position) is 7x the value of the maximum rated operational current for the 3RW52 soft starter, where this value is identical to 7 times the value of the maximum rated operational current I_e that can be set.</p> <p>This value is independent of the actual rated operational current I_e of the motor set at the 3RW52 soft starter.</p> <ul style="list-style-type: none"> • Factory setting: $4 \times I_e$ • Setting range: $1.3 \dots 7 \times I_e$ <p>The setting "max" corresponds to the 7-fold value of the maximum rated operational current I_e of the 3RW52 soft starter.</p>

Example

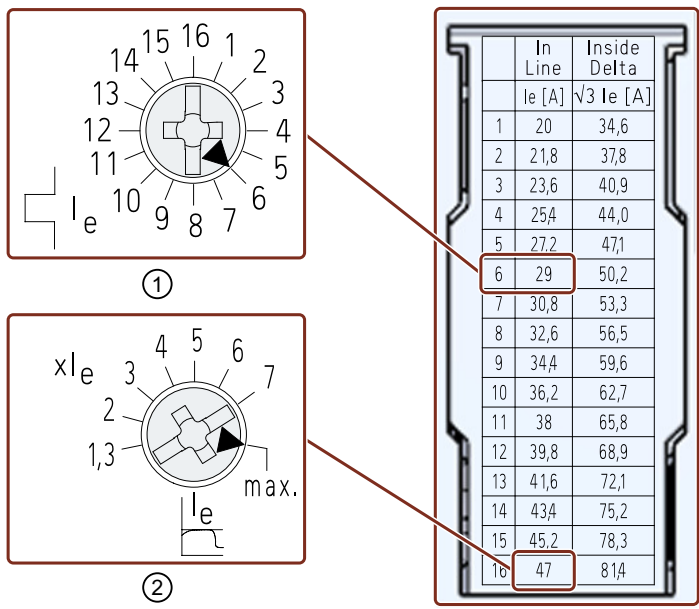

- ① Rated operational current I_e of the motor: $I_{e\ motor} = 29\ A$
- ② Maximum current limiting which can be set at this 3RW52 soft starter: $I_{max} = 7 \times 47\ A = 329\ A$

You will find the scale of the setting element I_e on the front of the 3RW52 soft starter under the hinged cover and in the Technical Data (Page 183).

8.3 Soft stopping

Operating principle

A voltage ramp is used to implement a smooth ramp-down. With the "voltage ramp" stopping function, the motor voltage is decreased along a linear, negative voltage ramp down to stop voltage.

Application

- Drives that abruptly come to a stop when switched off, thereby damaging the transported goods.
- E.g. bottle filling plants

Voltage characteristic

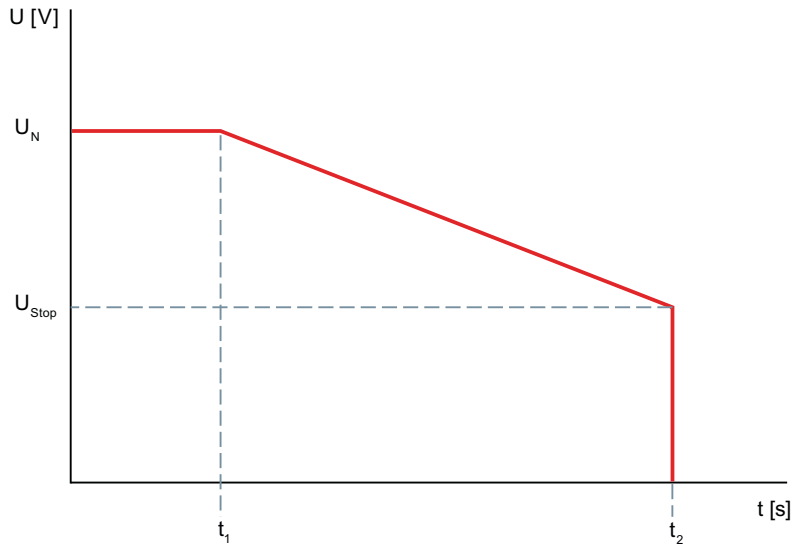

- $t_1 \dots t_2$ Stopping time
- U_N Line voltage
- U_{Stop} Stop voltage (50% of the line voltage)

Parameters

Parameter	Description
Stopping time	<p>The length of the stopping time defines the time within which the motor voltage is reduced from line voltage to 0 V. It may take longer for the motor to actually coast down to a standstill.</p> <p>The setting "0 s" causes the motor to be shut down immediately without a down ramp.</p> <ul style="list-style-type: none"> • Factory setting: 0 s • Setting range: 0 ... 20 s

8.4 Motor protection

The 3RW52 soft starter has 2 functions for protecting the motor:

- Electronic motor overload protection
- Thermistor motor protection with temperature sensor (optional)

Use a combination of both of these functions to implement full motor protection.

8.4.1 Electronic motor overload protection

Operating principle

The approximate temperature of the motor is calculated using the measured motor currents and the parameter settings "Rated operational current I_e " and "trip class". This indicates whether the motor is overloaded or is functioning in the normal operating range. When overload is detected, the 3RW52 soft starter shuts the motor down. The setting for RESET MODE determines how the motor is restarted.

Parameters

 WARNING
<p>Automatic restart following fault acknowledgment/restart. Can cause death or serious injury.</p> <p>The 3RW52 soft starter immediately continues to operate with the values specified by the control following fault acknowledgment/restart. Outputs are activated when the ON condition is met.</p> <p>Take appropriate measures (e.g. start key with monitored start) to prevent unintentional restarting and to ensure a defined start of the system.</p>

NOTICE
<p>Damage to property possible due to deactivated motor protection.</p> <p>If the motor is not monitored by a temperature sensor and the trip class is set to "CLASS OFF", no motor protection is provided.</p>

Parameter	Description
Trip class	<p>The trip class specifies the maximum time within which a protective device must trip from a cold state at 7.2 times the rated operational current I_e (motor protection to IEC 60947).</p> <ul style="list-style-type: none"> CLASS OFF: Deactivates the electronic motor overload protection CLASS 10A / 10E / 20E: Tripping times according to the trip class
Rated operational current I_e	<p>The rated operational current I_e is the current that can be continuously conducted by the feeder (switchgear and motor). This is normally the rated operational current I_e of the motor and depends on whether the motor is connected in an inline or an inside-delta circuit.</p>

Recovery time following motor overload protection tripping

The recovery time after the electronic overload protection is tripped is 5 minutes. With Auto RESET set, the error is automatically reset after the recovery time has elapsed. With Manual RESET or Remote RESET set, a RESET is only possible once the recovery time has elapsed.

You will find further information on resetting the faults in chapter RESET MODE (Page 85).

8.4.2 Thermistor motor protection with temperature sensor (optional)

Operating principle

 WARNING
Automatic restart following fault acknowledgment/restart. Can cause death or serious injury.
The 3RW52 soft starter immediately continues to operate with the values specified by the control following fault acknowledgment/restart. Outputs are activated when the ON condition is met.
Take appropriate measures (e.g. start key with monitored start) to prevent unintentional restarting and to ensure a defined start of the system.

You can connect the temperature sensor of the motor to the 3RW52 soft starter soft starter and evaluate it. If a specific motor-dependent temperature is exceeded, the 3RW52 soft starter recognizes this and reacts accordingly.

Two different types of measuring sensor can be connected to the 3RW52 soft starter:

- PTC thermistors type A
This sensor type is a temperature-dependent resistor.
- Thermoclick
This sensor type is a temperature-dependent switch.

When the thermistor motor protection has tripped, the 3RW52 soft starter cannot be restarted until the sensor installed in the motor has cooled down. The recovery time varies according to the temperature state of the sensor.

The sensor cables of PTC thermistors type A can be monitored for wire break and short-circuit.

Additional information

You will find further information on resetting the faults in chapter RESET MODE (Page 85).

You will find more information on the connection of the temperature sensor in chapter Connecting the temperature sensor (Page 204).

8.5 Intrinsic device protection

Operating principle

The integrated intrinsic device protection protects the power semiconductors as well as the bypass contacts against impermissible overload. If the internal warning limit is exceeded, a message is output on the 3RW52 soft starter. If the internal fault limit is exceeded, the 3RW52 soft starter will switch off automatically.

NOTICE

Damage to property due to short circuits

The intrinsic device protection system does not protect against irreparable equipment damage caused by short circuits.

Connect semiconductor fuses upstream in order to protect the power semiconductors against irreparable damage by short circuits (e.g. in case of cable damage or an interturn fault in the motor).

Recovery time after device protection is triggered

If the 3RW52 soft starter shuts down because the motor overload protection or the intrinsic device protection trips, you must wait a defined cooling-down period (recovery time) prior to acknowledging the fault or restarting the motor.

- In the event of power semiconductor overload: 30 s
- In the case of bypass overload: 60 s

8.6 Soft Torque

Operating principle of soft torque during starting

The Soft torque function reduces the drive acceleration rate shortly before the motor reaches its rated operating speed. This produces an almost linear speed curve. This helps to ensure smooth movement of a conveyor belt, for example, and so prevent fragile goods on the belt from tipping over.

Torque curve

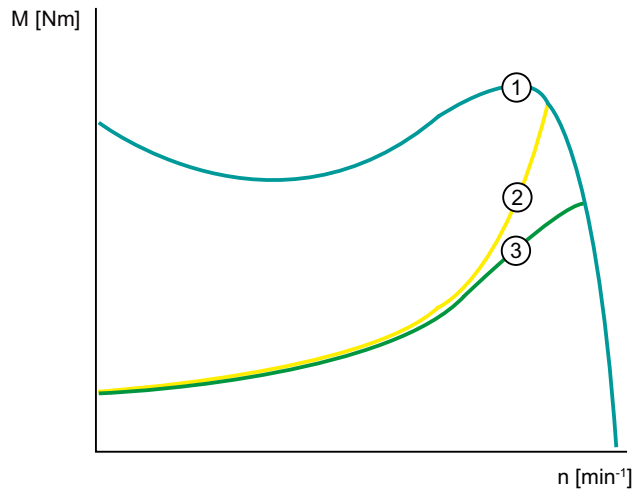

- ① Torque with direct-on-line starting
- ② Torque without Soft torque
- ③ Torque with Soft torque

Speed curve

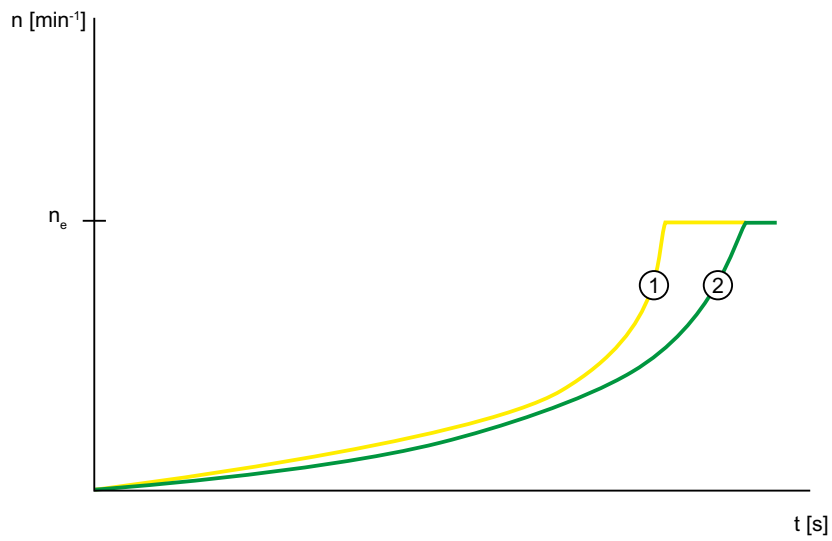

- n_e Rated operating speed of the motor
- ① Motor speed without Soft torque
- ② Motor speed with Soft torque

Operating principle of Soft torque during stopping

The Soft torque function enables the motor to coast down smoothly at an almost constant rate of deceleration. Ensuring that the motor coasts down smoothly is particularly useful for stopping pumps in order to prevent water hammers in the connected piping. The Soft torque function for stopping can only be activated when a stopping time of more than 3 seconds is set.

Speed curve

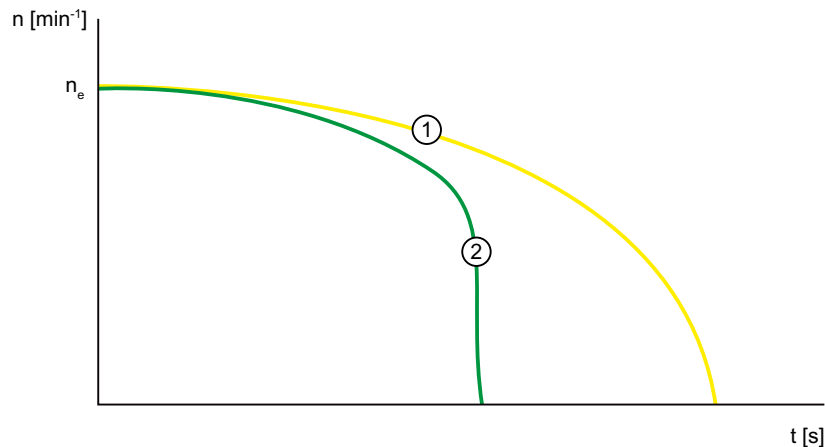

- n_e Rated operating speed of the motor
- ① Motor speed with Soft torque
- ② Motor speed without Soft torque

8.7 Functions under "Additional parameters"

Operating principle

The 3RW52 soft starter has additional functions and settable parameters that are to be found under "Additional parameters" in the 3RW5 HMI High Feature.

Setting options

- 3RW5 HMI High Feature (accessory)
Access protection to 3RW5 HMI High Feature is not active or has been reset.
Menu: "Parameters > Soft Starter > Additional parameters"
- You can find additional setting options, if they exist, in the associated chapter of the respective parameter.

Parameters

Parameter	Description
Typical ambient temperature (can only be set via 3RW5 HMI High Feature)	The 3RW52 soft starter is set to the predominant, typical ambient temperature actually present in the system. Ensure that the set typical ambient temperature is not exceeded. <ul style="list-style-type: none"> • 40 °C • 50 °C • 60 °C (factory setting)
Bypass operating mode	<ul style="list-style-type: none"> • Internal bypass (factory setting) • External bypass Please note that in this operating mode the soft starter can no longer measure the motor current. Functions that are based on this current measured value are deactivated (electronic motor overload protection, diagnostic messages, ...) For a typical circuit diagram example, see Chapter External bypass (Page 224). Contact Technical Support (Support Request (Page 11)) for operating with an external bypass. • No bypass Use the "No bypass" setting for applications with high switching frequency. Please note that the "No bypass" setting is not suitable for applications in continuous duty. Contact Technical Support (Support Request (Page 11)) for operating without a bypass.
Test with small load	The control and main circuit wiring is tested on a small load using a test motor. A direction of rotation test can be performed by monitoring the motor shaft or the load connected to it. <ul style="list-style-type: none"> • Activate • Deactivate For more setting options and more information, see Chapter Test with small load (Page 121).
Control via digital input	The parameter defines how the master control behaves on failure of the bus connection or a CPU stop. For more setting options and more information, see Chapter Response to bus errors / Control via digital input (Page 123).

8.8 Test mode

Requirements

- 3RW52 soft starter from firmware version V2.0
- Accessories, e.g. 3RW5 HMI High Feature or 3RW5 PROFINET or PROFIBUS communication module

Operating principle

For the test mode function "Test with small load" (Page 121), the 3RW52 soft starter must be in test mode. In test mode, the LED "RN" flashes green on the 3RW52 soft starter. For normal operation, the 3RW52 must be in Normal operation.

The parameters "Test mode" and "Normal operation" are not available in the 3RW5 HMI High Feature.

Setting options

- 3RW5 HMI High Feature (firmware version V2.0 or higher)
Access protection to 3RW5 HMI High Feature is not active or has been reset.
Menu: "Parameters > Soft Starter > Additional parameters"

Note

Activating test mode

If you activate or deactivate "Test with small load" on the 3RW5 HMI High Feature, you will automatically also switch to Test mode or Normal operation. For activation and deactivation on the 3RW5 HMI High Feature, the 3RW5 HMI High Feature must have master control.

- With SIRIUS Soft Starter ES (TIA Portal) via the local interface on the 3RW5 HMI High Feature
Brief overview: Window "Project Navigation" with current project under created Soft Starter > "Commissioning" > Window "Work area" > "Soft Starter > Functions > Test mode"
- With a fieldbus via a 3RW5 communication module (only via a 3RW5 PROFINET or PROFIBUS communication module):
 - With SIRIUS Soft Starter ES (TIA Portal) Premium / Professional
Brief overview: See SIRIUS Soft Starter ES (TIA Portal) via the local interface on the 3RW5 HMI High Feature
 - Configuration software of the control system (e.g. STEP 7 with corresponding HSP)
 - User program

8.9 Test with small load

Requirements

- 3RW52 soft starter from firmware version V2.0
- Accessories, e.g. 3RW5 HMI High Feature or 3RW5 PROFINET or PROFIBUS communication module
- The 3RW52 soft starter is connected to the main circuit.
- The test motor is connected to the 3RW52 soft starter.
- Permissible power range of the test motor:
 - < 10% of the rated power of the motor provided for the application
 - ≥ 1 kW

- The test motor is switched off prior to the activation of the test mode function "Test with small load".
 - The 3RW52 soft starter must be in Test mode (Page 120). In test mode, the LED "RN" flashes green on the 3RW52 soft starter.
-

Note

Activating test mode

If you activate or deactivate "Test with small load" on the 3RW5 HMI High Feature, you will automatically also switch to Test mode or Normal operation. For activation and deactivation on the 3RW5 HMI High Feature, the 3RW5 HMI High Feature must have master control.

For all other setting options, you must switch to test mode and can only then activate "Test with small load".

Operating principle

The test mode function "Test with small load" is helpful during commissioning and when troubleshooting, as the correct function of the application can be tested before installation in a control cabinet or before the use of a motor provided for the application. The "Test with small load" enables the wiring of the control and main circuit to be checked with the aid of a small motor (test motor).

In the test mode function "Test with small load", the motor operating states and all functions and messages can be executed and displayed by the 3RW52 soft starter as in normal operation.

If, during an active "Test with small load", the 3RW52 soft starter detects a lack of main current, a fault is generated with a shutdown command and the message text "Line voltage for test required". After connecting the 3RW52 soft starter to the main supply this error message can be acknowledged with RESET.

The error monitoring functions that are to be attributed to a missing or inadequate main supply are not active. The test mode function "Test with small load" remains active until the test mode function is deactivated.

The motor and intrinsic device protection functions of the 3RW52 soft starter remain active according to their parameterization and are not influenced by the test mode function "Test with small load".

Setting options

- 3RW5 HMI High Feature (firmware version V2.0 or higher)
Access protection to 3RW5 HMI High Feature is not active or has been reset.
Menu: "Parameters > Soft Starter > Additional parameters"
- With SIRIUS Soft Starter ES (TIA Portal) via the local interface on the 3RW5 HMI High Feature
Brief overview: Window "Project Navigation" with current project under created Soft Starter > "Commissioning" > Window "Work area" > "Soft Starter > Functions > Test mode"
- With a fieldbus via a 3RW5 communication module (only via a 3RW5 PROFINET or PROFIBUS communication module):
 - With SIRIUS Soft Starter ES (TIA Portal) Premium / Professional
Brief overview: See SIRIUS Soft Starter ES (TIA Portal) via the local interface on the 3RW5 HMI High Feature
 - Configuration software of the control system (e.g. STEP 7 with corresponding HSP)
 - User program

Parameters

Parameter	Description
Activate test with small load	The 3RW52 soft starter switches to the test mode function "Test with small load".
Deactivate test with small load	The test mode function "Test with small load" is terminated. The 3RW52 soft starter exits the test mode and switches back to the parametrized operating state.

8.10 Response to bus errors / Control via digital input

Requirements

- 3RW52 soft starter from firmware version V2.0.1

Note

3RW52 soft starter with firmware version earlier than V2.0.1:

The 3RW52 soft starter responds in accordance with the setting "Manual activation".

Operating principle

The parameter "Control via digital input" is only relevant when using a 3RW5 communication module. The parameter is helpful, for example, for applications in which the bus connection serves mainly for observation and monitoring purposes.

The parameter defines how the master control function behaves on failure of the bus connection or a CPU stop. A failure of the bus connection or a CPU stop can also occur in the operating mode "manual - local", for example when observing or monitoring via the bus connection. You can use

the parameter to disable a switchover to the "Automatic" mode and operating mode "manual - bus".

Setting options

- Parameterization via key combination on the 3RW52 Soft Starter (Page 87)
- 3RW5 HMI High Feature (accessory) with firmware version V3.0 or higher
Access protection to 3RW5 HMI High Feature is not active or has been reset.
Menu: "Parameters > Soft Starter > Additional parameters > Control via digital input"

Parameters

Parameter	Description
Control via digital input	<ul style="list-style-type: none"> • Manual activation On failure of the bus connection or a CPU stop the 3RW52 Soft Starter remains in the "Automatic" mode or the 3RW52 Soft Starter switches to the "Automatic" mode. • Permanent activation A switch to the "Automatic" mode and operating mode "manual - bus" is not possible. If the 3RW52 soft starter is in the "Automatic" or "manual - bus" mode, the 3RW52 soft starter switches to the "Manual operation local - input controlled" mode. Control by means of a higher-level control (e.g. PLC) is not possible. • Activate on bus error (factory setting) On failure of the bus connection or a CPU stop, the 3RW52 Soft Starter switches from the "Automatic" mode to the "Manual operation local - input controlled" mode or the 3RW52 Soft Starter remains in the operating mode "manual - local" mode. • No change on bus error On failure of the bus connection or a CPU stop the master control function does not switch, but the 3RW52 Soft Starter remains in the current mode.

Note that for the settings "Manual activation" and "No change on bus error", the 3RW52 soft starter switches to the "Automatic" mode after installation of the 3RW5 communication module to the 3RW52 soft starter.

If, on failure of the bus connection or CPU stop, the 3RW52 soft starter remains in the "Automatic" mode or switches to the "Automatic" mode, you can switch to the operating mode "manual - local" by means of the following procedures:

- Via a 3RW5 HMI or SIRIUS Soft Starter ES (TIA Portal) over the local interface on the 3RW5 HMI High Feature (Page 26).
- Change the setting of the parameter "Control via digital input" by means of a key combination on the 3RW52 soft starter (Page 87).
- Remove the 3RW5 communication module. Then restore the 3RW52 soft starter on the device to the factory setting (Page 177) in order to switch to the "Manual operation local - Input controlled" mode.

Additional information

You will find further information in chapter Operating modes and master control function (Page 24).

You will find further information about operation on failure of the bus connection to the control in the manual for the 3RW5 communication module in question.

You will find further information on removal of the 3RW5 communication module in the manual of the relevant 3RW5 communication module.

8.11 Standard 3RW5 HMI



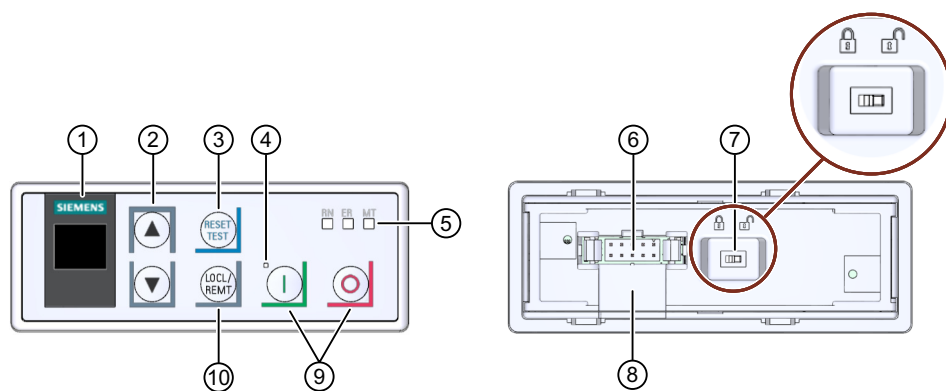



8.11.1 Design of the Standard 3RW5 HMI



- ① Display
- ② Navigation keys
- ③ RESET / TEST
- ④ Status LED (Page 146)
- ⑤ Device LEDs (Page 146)
- ⑥ Plug-in connection for HMI connecting cable
- ⑦ Locking switch
- ⑧ Cable duct
- ⑨ Start key
Stop key
- ⑩ LOCL/REMT

Navigating and setting

The keys are used for navigation, for selecting and setting menu items and for executing predefined actions.

Key	Actions
	<ul style="list-style-type: none"> Jump to next menu item Set digit
	<ul style="list-style-type: none"> Jump to previous menu item Set digit
	<ul style="list-style-type: none"> Identical to RESET key on 3RW52 soft starter
	<ul style="list-style-type: none"> Motor stops as parameterized if the 3RW5 HMI Standard is the master control.
	<ul style="list-style-type: none"> Motor starts as parameterized if the 3RW5 HMI Standard is the master control.
	<ul style="list-style-type: none"> Changes master control LOCL means that the 3RW5 HMI Standard is the master control. REMT means that the 3RW5 HMI Standard is not the master control.
	<ul style="list-style-type: none"> Locking switch Locked / Unlocked: To be able to operate the 3RW52 soft starter with the 3RW5 HMI Standard, the locking switch on the rear of the 3RW5 HMI Standard must be unlocked. If the locking switch on the rear of the 3RW5 HMI Standard is in the "Locked" switch position, the "RESET / TEST", "LOCL/REMT" and "Start" and "Stop" keys are disabled. Navigation through the menu using the navigation keys, however, is still possible.

8.11.2 Standard 3RW5 HMI menu

The following information is shown on the display of the 3RW5 HMI Standard:

- Operating state
- Measured values
- Parameters
While you are setting the parameters, the actual value is shown in the display.
- Diagnostics

Operating state

Display	Explanation
STATE	
ON STATE	The ramp up time comes to an end and the motor is running.
RAMP STATE	The ramp up time or the stopping time is active.
OFF STATE	The motor is switched off.

Display	Explanation	
ER O STATE	The motor is not ready to start because there is an error. More information is provided by the diagnostics display.	
OVLD (OVERLOAD)		
WN I OVLD	The motor is switched on. A motor overload protection warning is pending.	
WN O OVLD	The motor is switched off. A motor overload protection warning is pending.	
ER O OVLD	The motor is switched off. There is an error at the motor overload protection.	
---- OVLD	No motor overload exists.	
OVLD% (OVERLOAD in percent)		
...% OVLD%	Status of the electronic motor overload protection as a percentage.	
SCR % (silicon-controlled rectifier, power semiconductor temperature rise)		
...% SCR %	Status of the intrinsic device protection as a percentage. This measured value reflects the temperature rise of the power semiconductor. It comprises the measurement of the heat sink temperature and the calculated temperature rise of the junction (thermal model of the semiconductor).	
S-TRQ (Soft torque)		
ON S-TRQ	The Soft torque function is activated.	
OFF S-TRQ	The Soft torque function is deactivated.	
CNTRL (CONTROL)		
LOCL CNTRL	Manual mode	The master control function is with the 3RW5 HMI Standard ("Manual operation local - HMI controlled" mode).
REMT CNTRL	Automatic	Master control function is not with the 3RW5 HMI Standard. To make the unit the master control, press the LOCL/REMT key. Refer to Chapter Operating modes and master control function (Page 24).

Measured values

Display	Explanation
...A I AVG	The average of the 3 phase currents is displayed in amps.
...A I L1	Current measured value phase L1 is displayed in amps.
...A I L2	Current measured value phase L2 is displayed in amps.
...A I L3	Current measured value phase L3 is displayed in amps.

Parameter list

Display	Explanation	
.. xle	Current limiting value as a multiple of the set rated operational current I_e of the motor.	
...% U ON	Starting voltage	
...s t ON	Ramp up time	
...s t OFF	Stopping time	
... CLASS	Trip class for motor overload protection	
...A le	Rated operational current I_e of the motor	
.... RMode	AUTO	Auto RESET
	MAN	Manual RESET
	REMT	Remote RESET
... PBADR	Station address for PROFIBUS (only displayed if a 3RW5 PROFIBUS communication module is used)	
... MODBS	Station address for Modbus (only displayed if a 3RW5 Modbus RTU communication module is used)	

Diagnostics display

Display	Explanation
.... ERROR	Standard 3RW5 HMI menu (Page 126) Since the 3RW5 HMI Standard does not distinguish between warnings and errors, warnings are displayed as a warning on the 3RW52 soft starter, but as errors on the 3RW5 HMI Standard. Warnings and remedial actions of the 3RW52 soft starter (Page 148) Faults and remedial actions of the 3RW52 soft starter (Page 149)
NO COMM	No connection between the 3RW52 soft starter and the 3RW5 HMI Standard.

Display of the error number with 3RW5 HMI Standard

The 3RW5 HMI Standard can display up to 10 active errors (ER 0 ... 9) in the menu item "ERROR".

Procedure

1. Select the menu item "ERROR".
2. Press and hold a navigation key until the entry "ER 0" appears on the display.

3. Select the desired entry (ER 0 ... 9) using the navigation key.
If an entry contains an active error, the associated error number (Page 149) will appear above it.
If an entry contains no errors, the error number "0000" will appear.
4. To exit the menu, press and hold a navigation key until the entry "ERROR" appears on the display.
Alternatively, the 3RW5 HMI Standard automatically exits the menu after 5 seconds of inactivity.

8.12 High Feature 3RW5 HMI

Observe the hardware configuration in Chapter Design and operator controls of the High Feature 3RW5 HMI (Page 90).

8.12.1 Monitoring

8.12.1.1 Monitoring the measured values of the 3RW52 soft starter with the 3RW5 HMI High Feature

Requirements

- 3RW5 HMI High Feature (accessory)
Menu: "Monitoring > Measured values"

Operating principle

The measured values are provided by the respective device functions. Current measured values are stored in the measured value memory. These values can be read out and evaluated by the 3RW5 HMI High Feature. You can specify up to 5 measured values, which are shown on the operation display (Page 101).

Further display options of the measured values

- With SIRIUS Soft Starter ES (TIA Portal) via the local interface on the 3RW5 HMI High Feature
Brief overview: Window "Project Navigation" with current project under created Soft Starter > "Commissioning" > Window "Work area" > "Soft Starter > Measured values"
- With a fieldbus via a 3RW5 communication module:
 - With SIRIUS Soft Starter ES (TIA Portal) Premium / Professional (only via a 3RW5 PROFINET or PROFIBUS communication module)
Brief overview: See SIRIUS Soft Starter ES (TIA Portal) via the local interface on the 3RW5 HMI High Feature
 - Configuration software of the control system (e.g. STEP 7 with corresponding HSP)
 - User program

Measured values

Measured value		Description
Phase currents (%)	<ul style="list-style-type: none"> • I L1 • I L2 • I L3 • Average • Show bar chart¹⁾ 	<p>The phase currents are shown as a percentage relative to the rated operational current I_e. You can monitor each phase (L1/L2/L3) individually, or the average of all 3 phases.</p> <p>These measured values can be presented graphically as a bar or line chart on the display of the 3RW5 HMI High Feature.¹⁾</p> <p>You will find further information in chapters Design and operator controls of the High Feature 3RW5 HMI (Page 90) and Graphic display of measured values on the 3RW5 HMI High Feature (Page 131).</p>
Phase currents (rms)		<p>The phase currents are displayed in amperes. You can monitor each phase (L1/L2/L3) individually, or the average of all 3 phases.</p> <p>These measured values can be presented graphically as a bar or line chart on the display of the 3RW5 HMI High Feature.¹⁾</p> <p>You will find further information in chapters Design and operator controls of the High Feature 3RW5 HMI (Page 90) and Graphic display of measured values on the 3RW5 HMI High Feature (Page 131).</p>
Motor temperature rise		Current value of motor temperature rise in %. This measured value is calculated internally by the 3RW52 soft starter and indicates the relative temperature rise of the motor.
Remaining motor cooling time		Remaining recovery time in seconds still to be observed following activation of motor protection until the 3RW52 soft starter is once again ready for operation.
Remaining switching element cooling time		The remaining cooling-down period of the switching element depends on the thermal capacity of the power unit and the ambient conditions (temperature, air circulation, installation location, etc.). The remaining cooling-down period of the switching element is stated in seconds.
Switching element heating		The currently calculated switching element heating is continuously compared with the previously saved switching element heating and indicated in %.

¹⁾ 3RW5 HMI High Feature firmware version V3.0 or higher

8.12.1.2 Graphic display of measured values on the 3RW5 HMI High Feature

Requirements

- 3RW5 HMI High Feature (accessory) with firmware version V3.0 or higher

Operating principle

The 3RW52 soft starter supports the graphical display of the measured values "Phase currents (%)" and "Phase currents (rms)". These measured values can be presented as bar or line charts on the display of the 3RW5 HMI High Feature.

The following measured values can be displayed in the charts:

- Phase current IL1 (%) and (rms)
- Phase current IL2 (%) and (rms)
- Phase current IL3 (%) and (rms)
- Phase current average (%) and (rms)

Procedure for displaying bar charts

1. Select the menu item "Monitoring > Measured values > Phase currents (%) / Phase currents (rms) > Show bar chart".
Depending on the menu item selected, the current values of the 3 phase currents (%) or phase currents (rms) and the average value are displayed graphically in a bar chart.
2. Use the left and right navigations keys of the 3RW5 HMI High Feature to switch the view between Phase currents (%) and Phase currents (rms).
3. Press the ESC key to exit the bar chart view.

The example chart shows the current 3 phase currents (L1/L2/L3) and the associated average value as a percentage. The scaling of the x-axis is 200%.

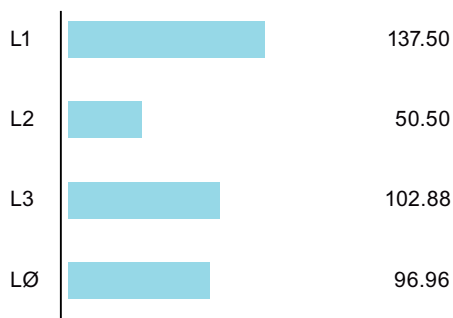

Procedure for displaying line charts

Operation display

1. Select the measured value to be displayed in the operation display and press the right navigation key of the 3RW5 HMI High Feature.
The selected measured value is shown graphically in a line chart.
2. Use the left and right navigations keys of the 3RW5 HMI High Feature to switch the view between Phase currents (%) and Phase currents (rms).
3. Press the ESC key to exit the line chart view.

"Monitoring" menu

1. Select the menu item "Monitoring > Measured values > Phase currents (%) / Phase currents (rms)".
2. Select the phase current to be displayed and press the right navigation key of the 3RW5 HMI High Feature.
The selected phase current is shown graphically in a line chart.
3. Use the left and right navigations keys of the 3RW5 HMI High Feature to switch the view between Phase currents (%) and Phase currents (rms).
4. Press the ESC key to exit the line chart view.

The sample chart shows the current phase current I L1 as a percentage. The scaling of the y-axis is 200%.

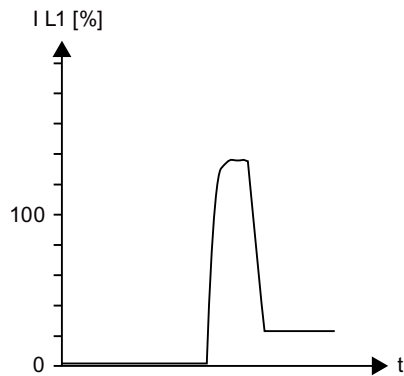

If the measured value exceeds the limit of the scaling (200% in the example), the line extends parallel with the x-axis and is displayed red in that area.

8.12.1.3 Monitoring the process image of the 3RW52 soft starter with the High Feature 3RW5 HMI

Requirements

- 3RW5 HMI High Feature (accessory)
Menu: "Monitoring > Process image"

Operating principle

The process image input (PII) contains current information about the soft starter and process state. The process image output (PIQ) contains current control commands to the 3RW5 soft starter. The control command states of the control source, which has control priority according to the operating mode controller, are entered in the data memory of the process image output.

Display of the process images on the 3RW5 HMI High Feature

In the process image input (PII) and process image output (PIQ), you can see which bits of the process image are active or inactive:

Checkbox	Status	Bit
<input type="checkbox"/>	inactive	0
<input checked="" type="checkbox"/>	active	1

Further display options

- With SIRIUS Soft Starter ES (TIA Portal) via the local interface on the 3RW5 HMI High Feature
Brief overview: Window "Task Card" > Tab "Online Tools" > "SIRIUS Control Panel"
- With a fieldbus via a 3RW5 communication module:
 - With SIRIUS Soft Starter ES (TIA Portal) Premium / Professional (only via a 3RW5 PROFINET or PROFIBUS communication module)
Brief overview: See SIRIUS Soft Starter ES (TIA Portal) via the local interface on the 3RW5 HMI High Feature
 - Configuration software of the control system (e.g. STEP 7 with corresponding HSP)
 - User program

Additional information

You will find further information on transferring the process images via a fieldbus in the device manual for the respective 3RW5 communication module.

Process image input (PII)

Process data	Process image
DI 0.0	Ready (automatic)
DI 0.1	Motor On
DI 0.2	Group error
DI 0.3	Group warning
DI 0.4	Input 1
DI 1.0	Motor current lact-bit0
DI 1.1	Motor current lact-bit1
DI 1.2	Motor current lact-bit2
DI 1.3	Motor current lact-bit3

Process data	Process image
DI 1.4	Motor current lact-bit4
DI 1.5	Motor current lact-bit5
DI 1.6	Operating mode manual - local
DI 1.7	Ramp operation
DI 2.0	Motor CW
DI 2.4	Starting mode active
DI 2.5	Operation / bypass active
DI 2.6	Stopping mode active
DI 2.7	Test mode active ¹⁾
DI 3.0	Thermal motor model overload
DI 3.1	Temperature sensor overload
DI 3.2	Switching element overload
DI 3.3	Cooling time active
DI 3.4	Device error
AI 4 (Float32)	Measured value 1 (factory setting: Phase current I L1 (rms)) ²⁾
AI 8 (Float32)	Measured value 2 (factory setting: Phase current I L2 (rms)) ²⁾
AI 12 (Float32)	Measured value 3 (factory setting: Phase current I L3 (rms)) ²⁾

¹⁾ 3RW52 Soft Starter from firmware version V2.0

²⁾ An overview of the measured values can be found in the following table.

Data format	Measured value	Unit
Float32	Phase current IL1 (rms)	A
Float32	Phase current IL2 (rms)	A
Float32	Phase current IL3 (rms)	A

Process image output (PIQ)

Process data	Process image
DQ 0.0	Motor CW
DQ 0.3	Reset
DQ 0.5	Self-test (user-test)
DQ 3.0	Manual operation local - input controlled

8.12.2 Overview

Requirements

- 3RW5 HMI High Feature (accessory)
Menu: "Overview"

Operating principle

The "Overview" menu displays the connected components and their device-related information (I&M data).

Note

Device-related information

Note that, with the 3RW5 HMI High Feature, it is only possible to edit the displayed device name of the 3RW5 soft starter.

Additional display options of the device-related information (I&M data)

- With SIRIUS Soft Starter ES (TIA Portal) via the local interface on the 3RW5 HMI High Feature
Brief overview: Window "Project Navigation" with current project under created Soft Starter > "Online & Diagnostics" > Window "Work area" > "Soft Starter / 3RW5 communication module used / HMI > Diagnosis > General"
- With a fieldbus via a 3RW5 communication module:
 - With SIRIUS Soft Starter ES (TIA Portal) Premium / Professional (only via a 3RW5 PROFINET or PROFIBUS communication module)
Brief overview: See SIRIUS Soft Starter ES (TIA Portal) via the local interface on the 3RW5 HMI High Feature
 - Configuration software of the control system (e.g. STEP 7 with corresponding HSP)
 - User program

Note

I&M data

I&M0 data is assigned for all of the devices (3RW5 soft starter, 3RW5 HMI High Feature, and 3RW5 communication module) and can be read out. Only the proxy for the "Station" (slot 0) has adjustable and readable I&M1, I&M2 and I&M3 data. The "Station" comprises the following devices:

- 3RW5 communication module (slot 1)
 - 3RW5 soft starter (slot 2)
 - 3RW5 HMI High Feature (slot 3)
-

Parameters

Parameter		Description
Soft starter	Module	<ul style="list-style-type: none"> • Article number¹⁾ • Hardware¹⁾ • Firmware¹⁾
	Module information	<ul style="list-style-type: none"> • Tag function²⁾
		<ul style="list-style-type: none"> • Tag location²⁾
		<ul style="list-style-type: none"> • Installation date³⁾ • Additional information⁴⁾ Assign a device name to the 3RW5 soft starter via SIRIUS Soft Starter ES (TIA Portal) or with the 3RW5 HMI High Feature. The device name appears in the top line of the display of the 3RW5 HMI High Feature. If you do not assign any name to the 3RW5 soft starter, the 3RW5 soft starter retains its short code. If the set device name is too long, only the first part of the device name is displayed.
Manufacturer information	<ul style="list-style-type: none"> • Manufacturer¹⁾ • Serial number¹⁾ 	
HMI	Module	<ul style="list-style-type: none"> • Article number¹⁾ • Hardware¹⁾ • Firmware¹⁾
	Manufacturer information	<ul style="list-style-type: none"> • Manufacturer¹⁾ • Serial number¹⁾
Communication module (if existing)	Module	<ul style="list-style-type: none"> • Article number¹⁾ • Hardware¹⁾ • Firmware¹⁾
	Manufacturer information	<ul style="list-style-type: none"> • Manufacturer¹⁾ • Serial number¹⁾

¹⁾ Part of the I&M0 data

²⁾ Part of the I&M1 data

³⁾ Part of the I&M2 data

⁴⁾ Part of the I&M3 data

8.12.3 Local access protection (PIN)

Requirements

- 3RW5 HMI High Feature (accessory)
Menu: "Security > Local access protection"

Operating principle

With the PIN, you can protect the 3RW5 HMI High Feature from unauthorized access. The menus of the 3RW5 HMI High Feature can still be viewed with local access protection activated. It is not possible to issue a control command or to set a parameter. If you issue a control command or change a parameter when local access protection is enabled, you will automatically receive an entry prompt for the current PIN beforehand.

The PIN remains even after the power supply has been interrupted. You can reset the local access protection to the factory setting with the master RESET key on the rear of the 3RW5 HMI High Feature (Page 176). Protect the master RESET key from unauthorized access.

Parameters

Parameter		Description
Local access protection	Define PIN ¹⁾	PIN is set up and active (Page 137). In the factory setting, no PIN is set up and the local access protection is not active.
	Change PIN ²⁾	Existing PIN is changed (Page 138).
	Delete PIN ²⁾	PIN is deactivated and deleted (Page 139).
	Auto log off time ²⁾	If you do not regularly press a key on the 3RW5 HMI High Feature, the current session will be terminated after the auto logoff time has elapsed. <ul style="list-style-type: none"> Factory setting: 0 min = deactivated Setting range: 0 ... 60 min
	Log on ³⁾	Remove the local access protection by logging on with your 4-digit PIN.
	Log off ⁴⁾	Log out of your current session. The local access protection is activated again. Alternatively, the session will be terminated after the auto logoff time.

¹⁾ Menu entry is displayed if no PIN has been defined.

²⁾ Menu entry is displayed if a PIN has been defined.

³⁾ Menu entry is displayed after logging off with an active PIN.

⁴⁾ Menu entry is displayed after logging on with an active PIN.

8.12.3.1 Define PIN

Requirements

- 3RW5 HMI High Feature (accessory)
Menu: "Security > Local access protection"
- No PIN is defined (factory setting).

Procedure

1. Select the menu item "Define PIN".
2. Using the navigation keys, set a 4-digit PIN and confirm your entry with the OK key.
3. The user information "HMI PIN defined" appears on the display of the 3RW5 HMI High Feature. Confirm by pressing the OK key.
The 3RW5 HMI High Feature then returns to the "Local access protection" menu.

Result

You have defined the PIN and the set PIN is active.

8.12.3.2 Change PIN

Requirements

- 3RW5 HMI High Feature (accessory)
Menu: "Security > Local access protection"
- A PIN is defined.

Procedure

1. Select the menu item "Change PIN".
2. Log on using the current 4-digit PIN and confirm your entry with the OK key.
If the entry is correct, the user information "Log on was successful" appears on the display of the 3RW5 HMI High Feature. Confirm by pressing the OK key.
3. Using the navigation keys, set a 4-digit PIN and confirm your entry with the OK key.
The user information "HMI PIN changed" appears on the display of the 3RW5 HMI High Feature. Confirm by pressing the OK key. The 3RW5 HMI High Feature then returns to the "Local access protection" menu.
4. Select the menu item "Log on".
5. Log on using the current 4-digit PIN and confirm your entry with the OK key.
If the entry is correct, the user information "Log on was successful" appears on the display of the 3RW5 HMI High Feature. Confirm by pressing the OK key.

Result

You have changed the PIN and the changed PIN is active.

8.12.3.3 Delete PIN

Requirements

- 3RW5 HMI High Feature (accessory)
Menu: "Security > Local access protection"
- A PIN is defined.

Procedure

1. Select the menu item "Delete PIN".
2. Log on using the current 4-digit PIN and confirm your entry with the OK key.
If the entry is correct, the user information "HMI PIN deleted" appears on the display of the 3RW5 HMI High Feature. Confirm by pressing the OK key. The 3RW5 HMI High Feature then returns to the "Local access protection" menu.

Resetting the PIN via the factory setting

You can reset the local access protection to the factory setting with the master RESET key on the rear of the 3RW5 HMI High Feature (Page 176).

Result

You have deactivated and deleted the current PIN.

8.12.4 Micro SD card

Requirements

- 3RW5 HMI High Feature (accessory)
Menu: "Micro SD card"
The "micro SD Card" menu appears after you have inserted a micro SD card into the 3RW5 HMI High Feature.
- Access protection to the 3RW5 HMI High Feature is not active or has been reset.
- Inserted micro SD card, e.g. micro SDHC Class 10
 - File format: FAT32
 - Capacity: max. 32 GB

Operating principle

Together with a micro SD card, the 3RW5 HMI High Feature can perform firmware updates, exchange configuration files and service data, and store logbooks.

Parameters

Action	Description
Load communication and HMI parameters to soft starter	<p>The parameters of the 3RW5 HMI High Feature are transferred from the micro SD card to the 3RW52 soft starter. The following data is transferred:</p> <ul style="list-style-type: none"> • Device parameters of the 3RW5 HMI High Feature <p>Application: Parameterize 3RW5 HMI High Feature serially / identically (Page 103)</p>
Load communication and HMI parameters to micro SD card	<p>The parameters of the communication and the 3RW5 HMI High Feature are transferred from the 3RW52 soft starter to the micro SD card. The data is saved in an automatically generated folder (e.g. "1P3RW5 xxx-xxxx"). The following data is transferred:</p> <ul style="list-style-type: none"> • I&M 1 data (Page 134) • I&M 3 data (Page 134) • Device parameters of the 3RW5 HMI High Feature • Communication parameters <p>Applications: Parameterize 3RW5 HMI High Feature serially / identically (Page 103) "Device change" function (Page 178)</p>
Device change	<p>When a device is replaced, the parameters for communication and of the 3RW5 HMI High Feature can be transferred to the new device. The following data is transferred:</p> <ul style="list-style-type: none"> • I&M 1 data (Page 134) • I&M 3 data (Page 134) • Device parameters of the 3RW5 HMI High Feature • Communication parameters <p>Application: "Device change" function (Page 178)</p>
Save logbooks to micro SD card	<p>The logbooks are backed up on the micro SD card. You will find further information in chapter Logbooks (Page 164).</p>
Save service data to micro SD card ^{1), 2)}	<p>The 3RW52 soft starter records service data during starting and stopping. If problems occur in the system in conjunction with the 3RW52 soft starter, you can save the service data on the micro SD card and have them evaluated by the service personnel. You will find further information in chapter Save service data to micro SD card (Page 165).</p>
FW update	<ul style="list-style-type: none"> • Soft starter • Communication module • HMI <p>The firmware update is carried out if a valid firmware file is stored on the micro SD card. The 3RW5 HMI High Feature automatically detects which firmware file the micro SD card contains. You can find more information on the firmware update in Chapter Performing firmware update with micro SD card (3RW5 HMI High Feature) (Page 173).</p>

Action	Description
Download language ³⁾	You can load additional languages onto the 3RW5 HMI High Feature via the micro SD card. You will find further information in chapter Reloading a language for the High Feature 3RW5 HMI (Page 141).
Memory space	<ul style="list-style-type: none"> • Complete memory • Free memory • Used memory The memory capacity is displayed.

1) 3RW52 Soft Starter from firmware version V2.0

2) 3RW5 HMI High Feature firmware version V2.0 or higher

3) 3RW5 HMI High Feature firmware version V3.0 or higher

8.12.5 Reloading a language for the High Feature 3RW5 HMI

Requirements

- 3RW5 HMI High Feature (accessory) with firmware version V3.0 or higher
Menu: "Micro SD card"
- Micro SD card (Page 139) with valid language file in the 3RW5 HMI High Feature
The first two digits of the version of the language file must match the first two digits of the firmware version (Vx.y) of the 3RW5 HMI High Feature.
You will find the current language files on the Internet (<https://support.industry.siemens.com/cs/ww/en/view/109772736>).
- The valid language file is located in the root directory (topmost level).
- Access protection to 3RW5 HMI High Feature is not active or has been reset.

Operating principle

The 3RW5 HMI High Feature supports the subsequent loading of an additional language. The additional language is transferred from the micro SD card to the 3RW5 HMI High Feature and can then be selected. Loading an additional language overwrites or deletes an already loaded additional language. If the additional language is active when the language update is performed, it will be retained until another language is selected. It is only possible to return to this additional language if this language is updated. The following languages contained in the factory setting of the 3RW5 HMI High Feature are not provided for downloading and are always part of the firmware update for the 3RW5 HMI High Feature:

- English (factory setting)
- German
- French
- Spanish
- Italian

8.12 High Feature 3RW5 HMI

- Portuguese
- Chinese

Procedure

1. Choose the menu item "Download language" and confirm with OK.
2. Select the required language file on the micro SD card and confirm with OK.

Result

You have loaded an additional language onto the 3RW5 HMI High Feature and can set it with the selection "Additional language" (Page 101).

Messages and diagnostics

9.1 Diagnostics options

The 3RW52 soft starter offers the following diagnostics options:

- LEDs on the 3RW52 soft starter
 - 3RW5 HMI Standard (accessory)
 - 3RW5 HMI High Feature (accessory)
 - SIRIUS Soft Starter ES (TIA Portal) (accessory) via local interface on the 3RW5 HMI High Feature
- Brief overview: Window "Project Navigation" with current project under created Soft Starter > "Commissioning" > Window "Work area" > "Soft Starter / HMI > Diagnosis"

Further diagnostics options

You will find further diagnostics options via the fieldbus in the manual for the respective 3RW5 communication module.

9.2 LED display

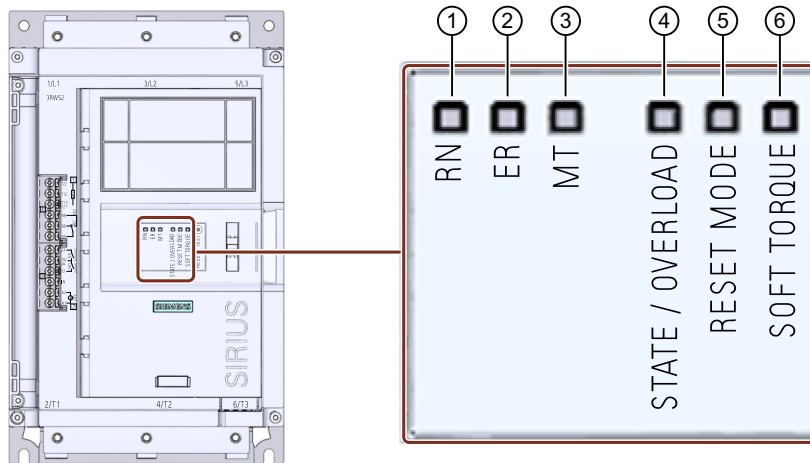

9.2.1 Overview of the device LEDs of the 3RW52 soft starter



- | | |
|---|--|
| ① RUN (green) | Indicates whether the 3RW52 soft starter is ready for operation. |
| ② ERROR (red) | Indicates whether there is an error. |
| ③ MAINTAINANCE (amber) | Indicates whether a message is present. |
| ④ STATE / OVERLOAD with LED (green / yellow-orange / red) | Indicates the motor operating state. |
| ⑤ RESET MODE with LED (green) | Indicates the selected RESET MODE (Page 83). |
| ⑥ SOFT TORQUE with LED (green) | Indicates whether Soft torque (Page 83) is activated or deactivated. |

9.2.2 Status and error displays

LED "RN" - RUN

State	Meaning
 Lights up green	The 3RW52 soft starter is ready for operation.
 Flashes green	The 3RW52 soft starter is not ready, e.g. due to: <ul style="list-style-type: none"> • System startup • The 3RW52 soft starter being reset to the factory settings. • Self-test (user-test) active • Firmware update • Test mode active



LED "ER" - ERROR

State	Meaning
<input type="checkbox"/> Off	No errors are present.
 Flashes red	There is at least one error.







LED "MT" - MAINTENANCE / WARNING

State	Meaning
<input type="checkbox"/> Off	No alarm is active.
 Lights up yellow	At least one warning exists. The cause has not been eliminated.

LED combinations

State			Meaning
RN	ER	MT	
 Flashes green	 Flashes red	 Flashes yellow	<ul style="list-style-type: none"> • The 3RW52 soft starter is not ready for operation. • Device error detected

9.2.3 STATE / OVERLOAD LED

"ST/OL" LED	Status of the 3RW52 soft starter	Motor operating state
 Lights up green	Operation	The ramp up time comes to an end and the motor is running.
 Flashes green	Starting or stopping time active	Motor is ramping up or ramping down.
 Off	Stop	<ul style="list-style-type: none"> • Motor is switched off but might still be rotating. • Motor is ready to start.
 Flashes yellow-orange	Stop - not ready to start	<ul style="list-style-type: none"> • Motor is switched off but might still be rotating. • Motor is not ready to start. An ON command will cause an error while at least one of the starting conditions is not fulfilled, e.g.: <ul style="list-style-type: none"> – Supply voltage of motor missing.
 Flashes alternately green / yellow-orange	Operation with motor overload warning	<p>Motor has started up and is running. A motor overload warning exists, e.g.:</p> <ul style="list-style-type: none"> • Motor is too hot
 Lights up yellow-orange	Stop with motor overload warning	<p>Motor has decelerated to zero speed and shut down. A motor overload warning exists, e.g.:</p> <ul style="list-style-type: none"> • Motor is too hot
 Flashes red	Stop with motor overload error	<p>Motor has decelerated to zero speed and shut down due to an overload error. A motor overload error exists, e.g.:</p> <ul style="list-style-type: none"> • Motor is too hot • Temperature sensor wire break • Temperature sensor short circuit

9.2.4 Overview of LEDs on Standard 3RW5 HMI

Device LEDs (RN, ER, MT)



The display of the device LEDs of the 3RW5 HMI Standard (Page 125) shows the status summary for the following devices:

- 3RW52 soft starter
- 3RW5 communication module (if there is one)

Please note that the display of the device LEDs of the 3RW5 HMI Standard does not have to correlate with the display of the device LEDs of the 3RW52 soft starter.

Status LED

The display on the status LEDs of the 3RW5 HMI Standard (Page 125) indicates the state of the 3RW52 soft starter and the operating state of the motor.

Status LED	Status of the 3RW52 soft starter	Motor operating state
 Lights up green	Operation	The ramp up time comes to an end and the motor is running.
 Flashes green	Starting or stopping time active	Motor is ramping up or ramping down.

Additional information

You will find more information on the messages of the 3RW52 soft starter in the chapter Status and error displays (Page 145).

You will find further information on the messages of the 3RW5 communication module in the manual for the 3RW5 communication module in question.

9.2.5 Overview of LEDs on High Feature 3RW5 HMI

Device LEDs (RN, ER, MT)



The display of the device LEDs of the 3RW5 HMI High Feature (Page 90) shows the status summary for the following devices:

- 3RW52 soft starter
- 3RW5 communication module (if there is one)
- 3RW5 HMI High Feature

Please note that the display of the device LEDs of the 3RW5 HMI High Feature does not have to correlate with the display of the device LEDs of the 3RW52 soft starter.

Status LED

The display on the status LEDs of the 3RW5 HMI High Feature (Page 90) indicates the state of the 3RW52 soft starter and the operating state of the motor.

Status LED	Status of the 3RW52 soft starter	Motor operating state
 Lights up green	Operation	The ramp up time comes to an end and the motor is running.
 Flashes green	Starting or stopping time active	Motor is ramping up or ramping down.

Additional information

You will find more information on the messages of the 3RW52 soft starter in the chapter Status and error displays (Page 145).

You will find further information on the messages of the 3RW5 communication module in the manual for the 3RW5 communication module in question.

9.3 Warnings and remedial actions of the 3RW52 soft starter

Display of warnings

The 3RW52 soft starter signals warnings by means of the following displays:

- LED "MT" (yellow)
- 3RW5 HMI High Feature (accessory)
- 3RW5 HMI Standard (accessory)

Display of warnings on the 3RW5 HMI High Feature

Detailed information about warnings and remedial actions appears in plain text on the display of the 3RW5 HMI High Feature.

Display of warnings on the 3RW5 HMI Standard

Since the 3RW5 HMI Standard does not distinguish between warnings and errors, warnings are displayed as a warning on the 3RW52 soft starter, but as errors on the 3RW5 HMI Standard. The display of the 3RW5 HMI Standard shows error numbers that you can assign to the respective warning using the following table.

Warnings and remedial measures

Error no.	Warning	Cause	Remedy
360	Connection abort in manual mode	Connection to a local control station (e.g. device HMI) has been interrupted.	<ul style="list-style-type: none"> Check the connection between the HMI and the device. Check the connection between the PC and the local device interface.
1416	Switching element too hot for Start	Switching element (switch contact, power semiconductors) too hot.	<ul style="list-style-type: none"> Check the ambient conditions associated with cooling. You may want to consider lowering the operating characteristics. Check the number of switching operations.
1539	Motor heating warning limit exceeded	<ul style="list-style-type: none"> The motor feeder has been overloaded. The motor temperature rise has exceeded a limit. 	<ul style="list-style-type: none"> Check the motor and the applications driven by the motor. You can switch on the motor again after the cooling-down period has expired or after deleting the thermal motor model.
1629	Check fan	<ul style="list-style-type: none"> Internal fan is dirty (not rotating freely). Connecting cable has fallen off or is defective. Internal fan faulty 	<ul style="list-style-type: none"> Check the function of the fan. Clean the fan. Check the wiring. Replace the fan.

9.4 Faults and remedial actions of the 3RW52 soft starter

Display of errors

The 3RW52 soft starter signals errors by means of the following displays:

- LED "ER" (red)
- 3RW5 HMI Standard (accessory)
- 3RW5 HMI High Feature (accessory)

Display of errors on the 3RW5 HMI

- 3RW5 HMI Standard: The display shows error numbers that you can assign to the respective error using the following table.
- 3RW5 HMI High Feature: Detailed information about errors and remedial actions appears in plain text on the display.

Errors and remedial actions

Error No. ¹⁾	Error	Cause	Remedy	RESET MODE		
				Man-ual ²⁾	Re-mote ³⁾	Auto ⁴⁾
303	Bus error	Fault in the fieldbus communication. You will find more information in the Equipment Manual for the 3RW5 communication module in question.	<ul style="list-style-type: none"> • Check the bus connection. • Check the bus parameters. 	-	-	x
308	Switching element defective	<ul style="list-style-type: none"> • Switching element defective • This error is also generated if the defective switching element (bypass or power semiconductor) cannot be accurately identified. 	Check the switching elements L1, L2, and L3 and replace any that are defective.	-	-	-
309	Switching element overload	Switching element (switch contact, power semiconductors) too hot.	<ul style="list-style-type: none"> • Check the ambient conditions associated with cooling. You may want to consider lowering the operating characteristics. • Check the number of switching operations. • Acknowledgment after cooling down 	x	x	-
317	Electronics supply voltage too low	The supply voltage (control supply voltage) is below the permissible value.	Check the power supply (load dimensioning, voltage range).	-	-	x
319	No main power	<ul style="list-style-type: none"> • The power switch or the power supply is not correctly connected. • No current 	Check the cables and the cable connections and replace any defective components.	x	x	-

9.4 Faults and remedial actions of the 3RW52 soft starter

Error No. ¹⁾	Error	Cause	Remedy	RESET MODE		
				Man-ual ²⁾	Re-mote ³⁾	Auto ⁴⁾
324	Temperature sensor overload	The temperature of the motor is too high.	<ul style="list-style-type: none"> Check the motor and the application that is driven by the motor. After triggering, the motor can only be switched on again if the temperature has reached the release position of the temperature sensor. 	x ⁵⁾	x ⁵⁾	x ⁵⁾
325	Temperature sensor wire break	A wire has broken in the sensor cable of the temperature sensor.	Check the sensor cable and the temperature sensor.	x ⁵⁾	x ⁵⁾	x ⁵⁾
326	Temperature sensor short-circuit	A short circuit has occurred in the temperature sensor cable.	Check the sensor cable and the temperature sensor.	x ⁵⁾	x ⁵⁾	x ⁵⁾
327	Thermal motor model overload	<ul style="list-style-type: none"> The motor feeder has been overloaded. 	<ul style="list-style-type: none"> Check the motor and the applications driven by the motor. 	x ⁵⁾	x ⁵⁾	x ⁵⁾
328	Motor overload protection - shutoff	<ul style="list-style-type: none"> The motor temperature rise has exceeded a limit. 	<ul style="list-style-type: none"> You can switch on the motor again after the cooling-down period has expired or after deleting the thermal motor model. 	x ⁵⁾	x ⁵⁾	x ⁵⁾
360	Warning, shown in 3RW59 HMI Standard as an error, see Chapter Warnings and remedial actions of the 3RW52 soft starter (Page 148)	-	-	-	-	-
378	FW update faulty	The firmware is incomplete and / or the firmware expansions are incomplete or incompatible.	<ul style="list-style-type: none"> Execute a complete firmware update. Check any error messages that occur. Check to see whether or not the firmware update has been interrupted. 	-	-	x
381	Self-test error	Irrecoverable error detected following self-diagnostics (self-test, contactor contacts, switching element, etc.).	<p>Switch off the power supply (control supply voltage) for at least 5 seconds and switch it on again. If the error is still present, proceed as follows:</p> <ul style="list-style-type: none"> Please contact Technical Support (Support Request (Page 11)). Replace the device. 	-	-	-

9.4 Faults and remedial actions of the 3RW52 soft starter

Error No. ¹⁾	Error	Cause	Remedy	RESET MODE		
				Man-ual ²⁾	Re-mote ³⁾	Auto ⁴⁾
1408	Missing load	<p>No current flow is detected in the motor feeder after an ON command.</p> <ul style="list-style-type: none"> • Main circuit interrupted (fuse, motor starter protector) • Motor contactor or contactor control is defective • No load 	Acknowledgment once the cause has been rectified.	x	x	-
1409	Loss of phase L1	The main power monitoring detects a phase failure.	Acknowledgment once the cause has been rectified.	x	x	-
1410	Loss of phase L2					
1411	Loss of phase L3					
1416	Warning, shown in 3RW59 HMI Standard as an error, see Chapter Warnings and remedial actions of the 3RW52 soft starter (Page 148)	-	-	-	-	-
1417	Bypass defective	<ul style="list-style-type: none"> • Bypass defective • The error can also be generated by successive, brief interruptions of the supply voltage (control supply voltage). 	<p>Switch off the power supply (control supply voltage) for at least 5 seconds and switch it on again. If the error is still present, proceed as follows:</p> <ul style="list-style-type: none"> • Please contact Technical Support (Support Request (Page 11)). • Check bypasses for L1, L2 and L3 and replace defective bypasses. 	-	-	-
1418	Bypass protective shut-off	An excessively high current has occurred in bypass mode.	<ul style="list-style-type: none"> • Check the motor. • Check the dimensioning of the soft starter. • Acknowledgment after cooling down 	x	x	-
1454	Preset unequal actual configuration	There is a difference between a real slot and a slot configured in the SIRIUS Soft Starter ES (TIA Portal).	<ul style="list-style-type: none"> • Ensure consistency between plugged and configured module. Possibly the referenced module has a wiring error. • After the cause is eliminated, the error self-acknowledges. 	-	-	-

9.4 Faults and remedial actions of the 3RW52 soft starter

Error No. ¹⁾	Error	Cause	Remedy	RESET MODE		
				Man-ual ²⁾	Re-mote ³⁾	Auto ⁴⁾
1466	Switching element L1 failed	Switching element defective	Switch off the power supply (control supply voltage) for at least 5 seconds and switch it on again. If the error is still present, proceed as follows: <ul style="list-style-type: none"> • Please contact Technical Support (Support Request (Page 11)). • Check the switching elements for L1, L2, and L3 and replace any that are defective. 	-	-	-
1467	Switching element L2 failed					
1468	Switching element L3 failed					
1479	Phase control failure	<ul style="list-style-type: none"> • Error appears without motor start: <ul style="list-style-type: none"> – Motor incorrectly connected – Inside-delta circuit incorrectly configured – Ground fault • Error appears while motor is starting: <ul style="list-style-type: none"> – Starting voltage too high 	<ul style="list-style-type: none"> • Check and correct the wiring. • Adapt parameters. 	x	x	-
1482	Current measuring range exceeded	<ul style="list-style-type: none"> • With sensors: The measured value has exceeded the range limits. • With actuators: The output value has exceeded an upper limit. 	Check the interaction between the module and the sensor or actuator.	x	x	-
1523	Device error	Irrecoverable error detected following self-diagnostics (self-test, contactor contacts, switching element, etc.).	Switch off the power supply (control supply voltage) for at least 5 seconds and switch it on again. If the device error is still present proceed as follows: <ul style="list-style-type: none"> • Please contact Technical Support (Support Request (Page 11)). • Replace the device. 	-	-	-

9.5 Faults and remedial actions of the 3RW5 HMI High Feature

Error No. ¹⁾	Error	Cause	Remedy	RESET MODE		
				Man-ual ²⁾	Re-mote ³⁾	Auto ⁴⁾
1539	Warning, shown in 3RW59 HMI Standard as an error, see Chapter Warnings and remedial actions of the 3RW52 soft starter (Page 148)	-	-	-	-	-
1605	Line voltage for test required	<ul style="list-style-type: none"> The power switch or the power supply is not correctly connected. No current 	Check the cables and the cable connections and replace any defective components.	x	x	-
1629	Warning, shown in 3RW59 HMI Standard as an error, see Chapter Warnings and remedial actions of the 3RW52 soft starter (Page 148)	-	-	-	-	-
1755	Operating temperature too high	The temperature in the components has exceeded the highest permissible limit.	Check the ambient temperature or the control cabinet ventilation.	-	-	x

- 1) Visible on the display of the 3RW5 HMI Standard.
- 2) Acknowledgment via Manual RESET.
- 3) Acknowledgment via Remote RESET.
- 4) Acknowledgment via Auto RESET.
- 5) Acknowledgment depends on parameter RESET MODE.

9.5 Faults and remedial actions of the 3RW5 HMI High Feature

Display of the faults on the 3RW5 HMI High Feature

Detailed information about faults and remedial actions appears in plain text on the display.

Faults and remedial actions

Error	Cause	Remedy
Error HMI	Unrecoverable error detected after internal diagnostics (self-test, etc.).	Replace the device.
FW update not successful	The firmware is incomplete and/or the firmware expansions are incomplete or incompatible.	<ul style="list-style-type: none"> • Run a complete firmware update. • Check any error messages that occur. • Check to see whether or not the firmware update was aborted.
Error during self-test	Unrecoverable error detected after internal diagnostics (self-test, etc.).	Replace the device.
Write Error	File cannot be written to the micro SD card.	<ul style="list-style-type: none"> • Check whether the micro SD card is inserted. • Check whether the micro SD card is write-protected.
FWUpdateInvalidSignature	The firmware is incomplete and/or the firmware expansions are incomplete or incompatible.	<ul style="list-style-type: none"> • Run a complete firmware update. • Check any error messages that occur. • Check to see whether or not the firmware update was aborted.
No device answer	The connection to the connected soft starter has been interrupted.	Check the connection between the HMI and the device.
Loading language unsuccessful ¹⁾	Subsequently loading the language is incomplete and/or the loaded language is incomplete or incompatible.	<ul style="list-style-type: none"> • Ensure the languages are loaded completely. • Check any error messages that occur. • Check to see whether or not loading the language has been interrupted.
Invalid signature 'Load additional language' ¹⁾		

¹⁾ 3RW5 HMI High Feature firmware version V3.0 or higher

9.6 Diagnostics of the 3RW52 soft starter with the 3RW5 HMI High Feature

With the diagnosis, you can display different statuses (Diagnosis state, Device state), Statistic data and Maximum pointer of the 3RW52 soft starter. There is also the Self-test (user-test) (Page 160) and Logbooks (Page 164).

Requirements

- 3RW5 HMI High Feature (accessory)
- Menu: "Diagnosis > Soft Starter"

Parameters

Diagnostic value	Description
Diagnosis state	Shows all active warnings and faults. You can acknowledge errors here (Manual RESET).

9.6 Diagnostics of the 3RW52 soft starter with the 3RW5 HMI High Feature

Diagnostic value		Description
Device state	Type of connection	If the 3RW52 soft starter is supplied with main voltage (operating voltage) and a motor is connected, the type of connection is automatically detected. <ul style="list-style-type: none"> Type of motor connection unknown Type of motor connection standard (inline) Motor connection type inside delta
	Rotation direction	<ul style="list-style-type: none"> Unknown main power direction (direction of phase rotation of the power system of the main voltage (operating voltage) at terminals L1/L2/L3 not detected) Clockwise Counter-clockw.
	Ready (automatic)	
	Motor CW	
	Starting mode active	
	Stopping mode active	
	Cooling time active	
	Current limiting active	
	Input control	
	Input 1	
	Maximum pointer reset	
	CPU/Master STOP	
	Automatic mode	
	Operating mode manual - bus	
	Operating mode manual - local	
	Factory settings restored	
	Main power rotation right	
	Main power rotation left	
	Output 1 active	
	Output 2 active	
	Output 3 active	
	Ready to start for motor ON	
	Thermal motor model deactivated	
	Switching element cooling time active	
	Manual operation bus - PC controlled	
	Manual operation local - input controlled	
	Manual operation local - HMI controlled	
	Manual operation local - PC controlled	
	FW update rejected	
	FW update active	
	FW update successful	
	Operation / bypass active	
	Normal operation active	
	Test mode active	

9.6 Diagnostics of the 3RW52 soft starter with the 3RW5 HMI High Feature

Diagnostic value	Description	
	Missing initialization after maintenance	
	Test with small load active	
	Logbook application - error deleted	
Statistic data ^{1), 3)}	Phase current max (%)	
	Last trip current I _A (%)	
	Device operating hours	
	Number of starts motor CW	
	Number of motor overload trips	
	Phase current max (rms)	
	Last trip current I _A (rms)	
	Motor operating hours	
	Number of switching element overload trips	
	Number of bypass overload trips	
Maximum pointer ^{2), 3)}	Phase currents (%)	Phase current I L1 min (%)
		Phase current I L2 min (%)
		Phase current I L3 min (%)
		Phase current I L1 max (%)
		Phase current I L2 max (%)
		Phase current I L3 max (%)
	Phase currents (rms)	Phase current I L1 min (rms)
		Phase current I L2 min (rms)
		Phase current I L3 min (rms)
		Phase current I L1 max (rms)
		Phase current I L2 max (rms)
		Phase current I L3 max (rms)
	Maximum trigger current	
	Number of motor overload trips	
	Maximum trigger current	
	Maximum switching element heating	
	Number of starts with ext. bypass ³⁾	
Self-test (user-test)	Initiate here the self-test functions of the 3RW52 soft starter. You will find further information in chapter Self-test (user-test) (Page 160).	
Logbooks	The logbook is a history memory in which events, warnings and faults are shown with a real-time stamp and stored in a list. The logbook can be stored on a micro SD card (Page 139). You will find further information in chapter Logbooks (Page 164).	

- ¹⁾ The statistic data is based primarily on operating states relating to operating hours and operating frequency of the 3RW52 soft starter in the past.
- ²⁾ Maximum pointers are based on measured values and represent the highest or smallest measured value that occurred in the past.
- ³⁾ 3RW52 soft starter from firmware version V2.0

9.7 Execute HMI diagnostics with the 3RW5 HMI High Feature

With the diagnosis, you can display the diagnosis state of the 3RW5 HMI High Feature and check correct functioning of the 3RW5 HMI High Feature with various tests.

Requirements

- 3RW5 HMI High Feature (accessory)
Menu: "Diagnosis > HMI"

Note

Self-tests

To be able to start the self-tests with a 3RW5 HMI High Feature with firmware version V3.1, the motor connected to the 3RW5 soft starter must be switched off.

3RW5 HMI High Feature with firmware version V3.1 or earlier: During the self-test, you cannot switch off the motor on the 3RW5 HMI High Feature. If you are controlling the motor via the 3RW5 HMI High Feature, switch off the motor before a self-test.

Parameters

Diagnostic value		Comment
Diagnosis state		Shows all active diagnostic messages (faults, warnings, device state).
Self-test	Test LEDs	The device LEDs of the 3RW5 HMI High Feature are tested one after the other. The display shows which device LED is currently being controlled. Navigate through the test operation with the OK key.
	Test buttons	The 3RW5 HMI High Feature keys are tested one after the other. The display shows which keys must be actuated in sequence in order to perform the test.
	Test display	The 3RW5 HMI High Feature runs a color program on the display. Navigate through the test operation with the OK key.

9.8 Performing diagnostics of the 3RW5 communication module with the 3RW5 HMI High Feature

With the diagnosis, you can display the diagnosis state of the 3RW5 communication module.

Requirements

- 3RW5 HMI High Feature (accessory)
Menu: "Diagnosis > Communication module"
- 3RW5 communication module (accessory)

Parameter

Diagnostic value	Comment
Diagnosis state	Shows all active prewarnings and faults. You can acknowledge faults here.

Additional information

You will find further information on the diagnostics of the 3RW5 communication module in the Equipment Manual for the respective 3RW5 communication module.

9.9 Self-test (user-test)

With the Self-test (user-test), you can test correct functioning of the 3RW52 soft starter (LEDs, current measurement, electronic motor overload protection).

Requirements

- The 3RW52 soft starter is in a fault-free condition.
- Perform the test with the motor switched off.

Activation options

- Using the RESET / TEST key on the 3RW52 soft starter
- 3RW5 HMI High Feature (accessory)
Menu: "Diagnosis > Soft Starter > Self-test"
The 3RW5 HMI High Feature (LOCAL) has master control. Access protection to 3RW5 HMI High Feature is not active or has been reset.
Here the self-test (user-test) is run through completely.

Procedure - Activation with the RESET / TEST key

Depending on how long the RESET / TEST keys are held pressed, the following tests are performed in the specified sequence. Thus, if the key is held pressed for longer than 8 seconds, all 4 tests are performed. If you press and hold the key for only 3 seconds, for example, the first 2 tests are conducted.



Operating time	Explanation
0.15 ... 2 s	LED test All LEDs are controlled.
2 ... 5 s	Visual display of the position of the rotary coding switch 16 different positions are available for the rotary coding switch for setting the rated operational current I_e of the motor. The table "Visual display of the position of the rotary coding switch" displays the exact position of the rotary coding switch based on a combination of 5 LEDs. You will find more information in chapter Setting elements on the 3RW52 soft starter (Page 79).
5 ... 8 s	Current detection test The current detection is tested in all 3 phases. In the case of 3RW52 soft starters with thermistor motor protection, the thermistor evaluation unit is also tested.
> 8 s	Motor overload protection test The entire control circuit is tested, including the contact blocks and the error signaling output. If the 3RW52 soft starter responds correctly, no overload trip occurs. This can be reset immediately without a cooling-down period by pressing the TEST / RESET key again.

Test result





The test results are provided in the following tables. If the 3RW52 soft starter does not respond as shown in the tables below during the function test, check the external connections, their function, and the wiring. If the error persists even though the connections are correct, the 3RW52 soft starter must be replaced.

If a 3RW5 HMI is connected to the 3RW52 soft starter, the 3RW5 HMI indicates "Motor overload protection - shutoff" when it passes the function test. If the 3RW5 soft starter does not pass the function test, the 3RW5 HMI indicates a device error.



















LED test































LED	Display of test result	
	pass	fail
"RN"	 Lights up green	<input type="checkbox"/> Off
"ER"	 Lights up red	<input type="checkbox"/> Off

9.9 Self-test (user-test)

LED	Display of test result	
	pass	fail
"MT"	 Lights up yellow	<input type="checkbox"/> Off
"STATE / OVERLOAD"	 Lights up yellow-orange	<input type="checkbox"/> Off
"RESET MODE"	 Lights up green	<input type="checkbox"/> Off
"SOFT TORQUE"	 Lights up green	<input type="checkbox"/> Off

Visual display of the position of the rotary coding switch



Position of the rotary coding switch "Rated operational current I _e of the motor"	LED					
	"RN"	"ER"	"MT"	"STATE / OVERLOAD"	"RESET MODE"	"SOFT TORQUE"
1	 Flickers green	<input type="checkbox"/> Off	<input type="checkbox"/> Off	<input type="checkbox"/> Off	<input type="checkbox"/> Off	 Lights up green
2	 Flickers green	<input type="checkbox"/> Off	<input type="checkbox"/> Off	<input type="checkbox"/> Off	 Lights up green	<input type="checkbox"/> Off
3	 Flickers green	<input type="checkbox"/> Off	<input type="checkbox"/> Off	<input type="checkbox"/> Off	 Lights up green	 Lights up green
4	 Flickers green	<input type="checkbox"/> Off	<input type="checkbox"/> Off	 Lights up green	<input type="checkbox"/> Off	<input type="checkbox"/> Off
5	 Flickers green	<input type="checkbox"/> Off	<input type="checkbox"/> Off	 Lights up green	<input type="checkbox"/> Off	 Lights up green
6	 Flickers green	<input type="checkbox"/> Off	<input type="checkbox"/> Off	 Lights up green	 Lights up green	<input type="checkbox"/> Off
7	 Flickers green	<input type="checkbox"/> Off	<input type="checkbox"/> Off	 Lights up green	 Lights up green	 Lights up green

Position of the rotary coding switch "Rated operational current I_e of the motor"	LED					
	"RN"	"ER"	"MT"	"STATE / OVERLOAD"	"RESET MODE"	"SOFT TORQUE"
8	 Flickers green	<input type="checkbox"/> Off	 Lights up yellow	<input type="checkbox"/> Off	<input type="checkbox"/> Off	<input type="checkbox"/> Off
9	 Flickers green	<input type="checkbox"/> Off	 Lights up yellow	<input type="checkbox"/> Off	<input type="checkbox"/> Off	 Lights up green
10	 Flickers green	<input type="checkbox"/> Off	 Lights up yellow	<input type="checkbox"/> Off	 Lights up green	<input type="checkbox"/> Off
11	 Flickers green	<input type="checkbox"/> Off	 Lights up yellow	<input type="checkbox"/> Off	 Lights up green	 Lights up green
12	 Flickers green	<input type="checkbox"/> Off	 Lights up yellow	 Lights up green	<input type="checkbox"/> Off	<input type="checkbox"/> Off
13	 Flickers green	<input type="checkbox"/> Off	 Lights up yellow	 Lights up green	<input type="checkbox"/> Off	 Lights up green
14	 Flickers green	<input type="checkbox"/> Off	 Lights up yellow	 Lights up green	 Lights up green	<input type="checkbox"/> Off
15	 Flickers green	<input type="checkbox"/> Off	 Lights up yellow	 Lights up green	 Lights up green	 Lights up green
16	 Flickers green	 Lights up red	<input type="checkbox"/> Off	<input type="checkbox"/> Off	<input type="checkbox"/> Off	<input type="checkbox"/> Off

Current detection test

LED	Display of test result	
	pass	fail
"STATE / OVERLOAD"	 Flickers red	<input type="checkbox"/> Off In case of error: System LEDs (RN, ER, MT) flashing. Device error, replace device.

Motor overload protection test

	Display of test result	
	pass	fail
"STATE / OVERLOAD" LED	 Flashes red	<input type="checkbox"/> Off In case of error: System LEDs (RN, ER, MT) flashing. Device error, replace device.
"ER" LED	 Flashes red	In case of error: System LEDs (RN, ER, MT) flashing. Device error, replace device.
Error signaling output	Active	Not active
Contact blocks / motor	Deactivated	Unchanged

Self-test of the 3RW5 HMI High Feature

You will find more information on the self-test of the 3RW5 HMI High Feature in Chapter Execute HMI diagnostics with the 3RW5 HMI High Feature (Page 159).

9.10 Logbooks

Operating principle

The logbook lists events, warnings, and errors in chronological order. Each entry is stamped with the real time. For the 3RW52 soft starter there are the following logbooks:

- Logbook application
- Logbook device

The logbook is designed as a circular buffer.

Display and editing options

- 3RW5 HMI High Feature (accessory)
Menu: "Diagnosis > Soft Starter > Logbook"
- With SIRIUS Soft Starter ES (TIA Portal) via the local interface on the 3RW5 HMI High Feature
Brief overview: Window "Project Navigation" with current project under created Soft Starter > "Commissioning" > Window "Work area" > "Soft Starter > Logbook"
- With a fieldbus via a 3RW5 communication module (only via a 3RW5 PROFINET or PROFIBUS communication module):
 - With SIRIUS Soft Starter ES (TIA Portal) Premium / Professional
Brief overview: See SIRIUS Soft Starter ES (TIA Portal) via the local interface on the 3RW5 HMI High Feature
 - Configuration software of the control system (e.g. STEP 7 with corresponding HSP)

Logbook application

The logbook application contains all messages relating to functions and parameters. The logbook application can be deleted.

Logbook device

The following messages are recorded in the device logbook:

- Errors
- Warnings
- Events

The device logbook is available in every module (3RW52 soft starter, 3RW5 HMI High Feature, 3RW5 communication module) and cannot be deleted.

Saving logbooks

- You can save the logbooks on a micro SD card (Page 139) if a micro SD card is inserted in the HMI HF:
 - Menu: "Micro SD card > Save logbooks to micro SD card"
 - Click "OK". A *.csv file is stored on the micro SD card, which you can read out with Microsoft Excel, for example.

9.11 Save service data to micro SD card

Requirements

- 3RW52 soft starter from firmware version V2.0
- 3RW5 HMI High Feature (accessory) from firmware version V2.0
Menu: "Micro SD card"
The "micro SD Card" menu appears after you have inserted a micro SD card into the 3RW5 HMI High Feature.
- Inserted micro SD card (Page 139)
- Access protection to the 3RW5 HMI High Feature is not active or has been reset.
- Motor switched off

Operating principle

The 3RW52 soft starter records service data during starting and stopping. If problems occur in the system in conjunction with the 3RW52 soft starter, you can save the service data on the micro SD card. The service data can help Technical Support to handle the case in the event of a Support Request (Page 11). The service data contain the following data, for example:

- Parameters
- Logbooks

9.11 Save service data to micro SD card

- Statistic data
- Maximum pointer
- I&M data

Procedure

Save the service data on the 3RW5 HMI High Feature onto the micro SD card.

Menu: "Micro SD card > Save service data to micro SD card"

Saving the service data can take a little time (> 1 minute). At the top level of the micro SD card, a folder is created with the serial number of the 3RW52 soft starter in which the service data are stored. Example of a created folder name: "1P3RW5 xxx-xxxxx+SLO..."

Note

Save service data to micro SD card

While the service data are being saved to the micro SD card, the color of the micro SD card icon changes from blue to red on the display 3RW5 HMI High Feature. If the service data have been saved completely, the color of the icon changes back to blue.

Icon of the micro SD card on the display of the 3RW5 HMI High Feature:



Result

You have stored the service data on the micro SD card.

These service data can help Technical Support to handle the case in the event of a Support Request (Page 11). If necessary, read the micro SD card in at a PC and send the folder of service data as a ZIP file.

Maintenance and servicing

10.1 Maintenance and repairs



! WARNING

**Hazardous voltage.
Can cause death or serious injury.**

The present device/part conducts hazardous voltages.

Touching live components will result in death or severe injury.

Installation, commissioning, and maintenance only by qualified specialist personnel.

Repair of the devices is only permissible by qualified personnel. Please contact the authorized Siemens service partner for this.

10.2 Replacing the fan

Requirements

- Replacement fan incl. connector
- Optional: The fan cover is disassembled.
- Flat-head screwdriver (size 1)
- Diagonal cutter
- Wire cutter

Procedure size 1 (3RW521.-.....)



! DANGER

**Hazardous voltage.
Will cause death or serious injury.**

Disconnect the system and the device from the power supply before starting work.

10.2 Replacing the fan

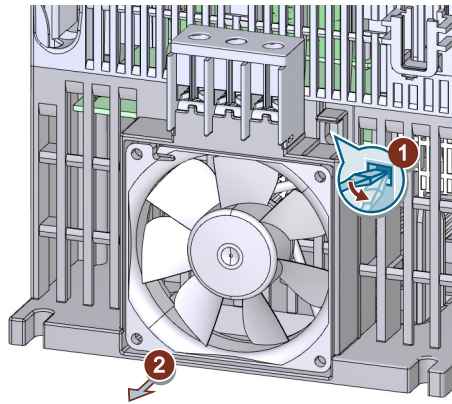

On the underside of the soft starter, insert a flat-head screwdriver into the opening on the right above the fan. Press the flat-head screwdriver down ① until the tab opens upward. Remove the defective fan ② and cut the cables at the fan.

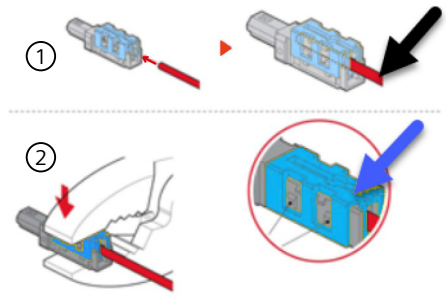

Connect the cables using the connector supplied as a separate item ① and ②. Carefully check the correct polarity (red and black).

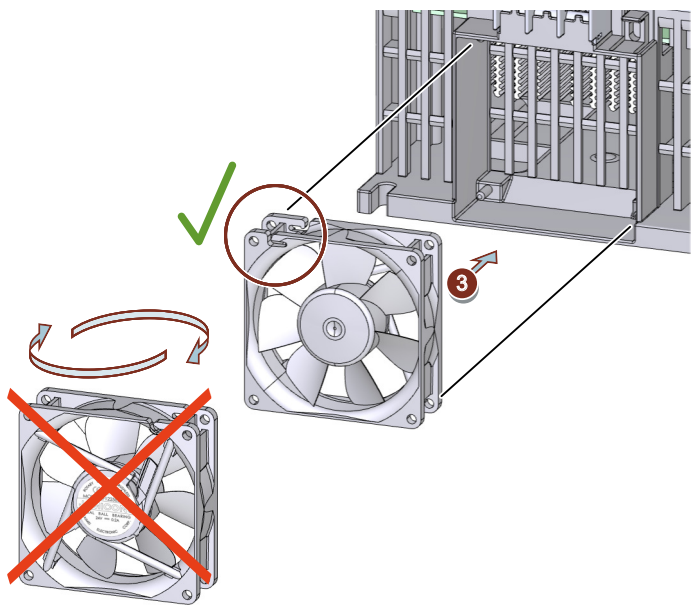

Figure 10-1 M_Fan_3RW55 BG-1

Fit the replacement fan ③ until it engages:

- The adhesive label faces inward.
- The cable guide is top left to ensure that the cable is correctly routed.
- Take care that the cable is not crushed.

Procedure size 2 and 3 (3RW522.-..... and 3RW523.-.....)



! DANGER

**Hazardous voltage.
Will cause death or serious injury.**

Disconnect the system and the device from the power supply before starting work.

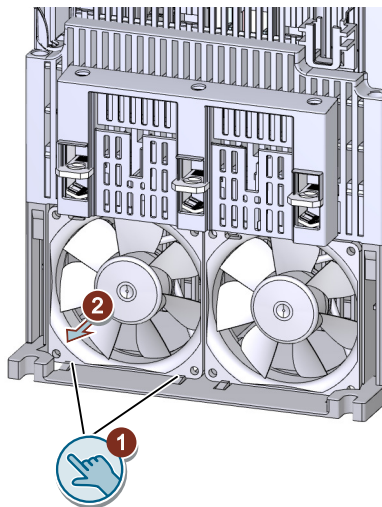

On the base of the soft starter, push the lugs to the left and right of the fan downward ①.
Remove the defective fan ② and cut the cable at the fan.

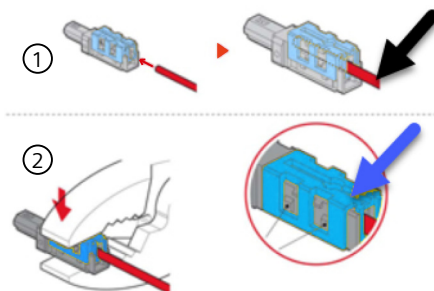

Connect the cables using the connector supplied as a separate item ① and ②. Carefully check the correct polarity (red and black).

10.2 Replacing the fan

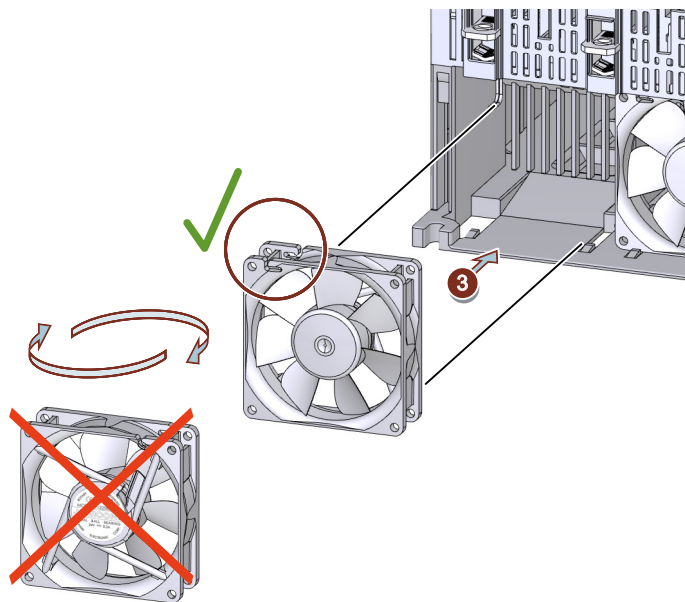

Figure 10-2 M_Fan_3RW55-BG-2-3

Fit the replacement fan ③ until it engages:

- The adhesive label faces inward.
- The cable guide is top left.
- Take care that the cable is not crushed.

Procedure size 4 (3RW524.-.....)



! DANGER

**Hazardous voltage.
Will cause death or serious injury.**

Disconnect the system and the device from the power supply before starting work.

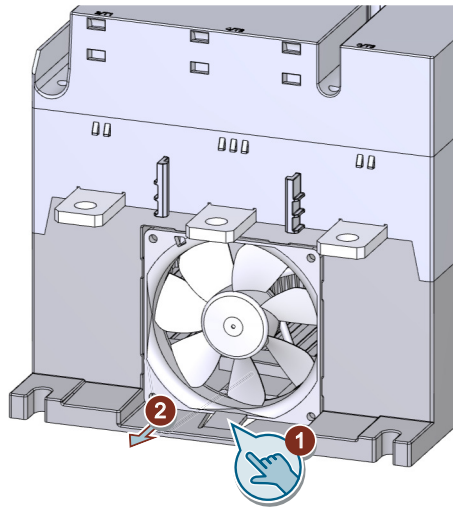

On the base of the soft starter, push the lug at the bottom center of the fan downward ①.
Remove the defective fan ② and cut the cable at the fan.

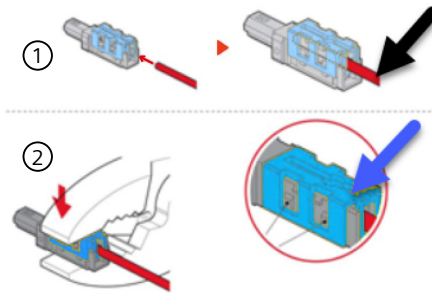

Connect the cables using the connector supplied as a separate item ① and ②. Carefully check the correct polarity (red and black).

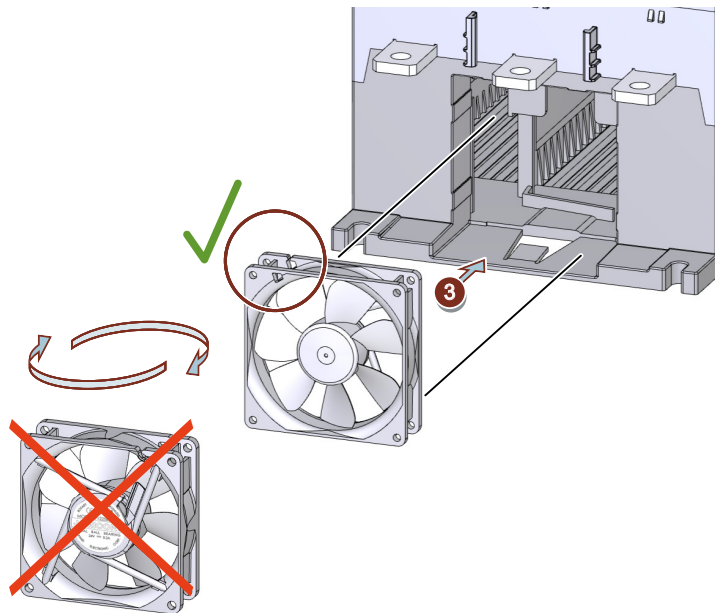

Fit the replacement fan ③ until it engages:

- The adhesive label faces inward.
- The cable guide is top left.
- Take care that the cable is not crushed.

10.3 Firmware update

During operation, it may be necessary to update the firmware (e.g. to extend the available functions). You update the firmware of the respective device with the help of device-specific firmware files. The retentive data is retained after the firmware has been updated.

Firmware updates and a history of the versions with the innovations are provided to you on the Internet. Depending on what firmware updates are available, you can update the devices individually or together.

You can perform a firmware update for the following devices:

- 3RW52 soft starter
- 3RW5 HMI High Feature (accessory) (not possible via fieldbus)
- 3RW5 communication module (accessory)

Requirements

- Valid firmware update
You will find the latest firmware files on the 3RW5 topic page (<https://support.industry.siemens.com/cs/ww/en/view/109747404>).

Procedure

1. Make sure that the motor is switched off and you do not start the motor during the firmware update.
A control command for starting the motor is not supported during the firmware update. To ensure the quickest and most fault-free firmware update, it is recommended that you disconnect the main voltage (operating voltage) of the 3RW52 soft starter and set the CPU / PLC to STOP operating state.
2. Perform the update of the device firmware.
The following procedures are possible:
 - With a micro SD card via the 3RW5 HMI High Feature (Page 173)
 - Via the local interface of the 3RW5 HMI High Feature with SIRIUS Soft Starter ES (TIA Portal)
Brief overview: Window "Project Navigation" with current project under created Soft Starter > "Online & Diagnostics" > Window "Work area" > "Soft Starter / 3RW5 communication module used / HMI > Functions > Firmware Update"
 - With a fieldbus via a 3RW5 communication module with SIRIUS Soft Starter ES (TIA Portal) Premium / Professional or the configuration software of the controller (e.g. STEP 7 with corresponding HSP) (via a 3RW5 PROFINET or PROFIBUS communication module only)

Result

You have performed a firmware update for the selected device. The selected device automatically restarts.

Note

Firmware update of the 3RW5 HMI High Feature:

Please note that the display switches off for about 30 seconds when the firmware is activated.

10.4 Performing firmware update with micro SD card (3RW5 HMI High Feature)

Requirements

- Micro SD card with valid firmware file (*.upd)
- The valid firmware file is located in the root directory (topmost level)
- 3RW5 HMI High Feature
Menu: "Micro SD card > FW update"
- Access protection to 3RW5 HMI High Feature is not active or has been reset.

Procedure

Note

Access to micro SD card.

Please note that the micro SD card is inserted in the 3RW5 HMI High Feature during updating of the firmware.

Premature removal of the micro SD card from the 3RW5 HMI High Feature is not permissible and will terminate updating of the firmware. Data could also be lost.

1. Select the folder of the respective device.
 2. Select the firmware file of the device and confirm with the OK key.
You can see the firmware update is being performed from the progress bar on the display. Following successful updating of the firmware, the respective device then restarts automatically.
-

Note

Firmware update of the 3RW5 HMI High Feature:

Please note that the display switches off for about 30 seconds when the firmware is activated.

3. Check the new firmware version in the "Overview" menu.

Result

You have performed a firmware update for the selected device using the micro SD card.

10.5 Restore factory setting

Effects of the factory setting

The following devices can be reset to the factory setting:

- 3RW52 soft starter
 - The parameters of the 3RW52 soft starter that were not set via the setting elements are reset.
- 3RW5 communication module
 - The parameters of the 3RW5 communication module are reset.
- 3RW5 HMI High Feature
 - The parameters of the 3RW5 HMI High Feature and the PIN for access protection are reset to the factory setting.
- All devices
 - The 3RW52 soft starter, the 3RW5 communication module, and the 3RW5 HMI High Feature are reset to the factory settings, as described above.

Requirements

The master control lies with the source of the command to restore the factory setting.

Procedure

1. Make sure that the motor is switched off and that you do not start the motor while restoring the factory settings.
To ensure the quickest and most fault-free restoration of the factory setting, it is recommended that you disconnect the main voltage (operating voltage) at the 3RW52 soft starter.
2. Restore the factory settings.
The following procedures are possible:
 - With the MODE and RESET / TEST (Page 177) keys.
 - Via the 3RW5 HMI High Feature (accessory):
Restoring the factory settings via High Feature 3RW5 HMI (Page 176)
Restoring the factory settings with the Master RESET button via 3RW5 HMI High Feature (Page 176)
 - Via the local interface on the 3RW5 HMI High Feature with SIRIUS Soft Starter ES (TIA Portal)
Brief overview: Window "Project Navigation" with current project under created Soft Starter > "Commissioning" > Window "Work area" > "Soft Starter > Functions > Commands > Factory settings"
 - With a fieldbus via a 3RW5 communication module with SIRIUS Soft Starter ES (TIA Portal) Premium / Professional (only via a 3RW5 PROFINET or PROFIBUS communication module)
Brief overview: See SIRIUS Soft Starter ES (TIA Portal) via local interface on the 3RW5 HMI High Feature
 - With a fieldbus via a 3RW5 communication module with the command "Factory settings" in data set 93 (only via a 3RW5 PROFINET or PROFIBUS communication module):
 - With a fieldbus via a 3RW5 communication module with the configuration software of the control (only via a 3RW5 PROFINET or EtherNet/IP communication module). Only the communication parameters are reset here.

Result

The factory setting of the selected device or all devices is restored.

10.5.1 Restoring the factory settings via High Feature 3RW5 HMI

Requirements

- Make sure that the motor is switched off and that you do not start the motor while restoring the factory settings. To ensure the quickest and most fault-free restoration of the factory setting, it is recommended that you disconnect the main voltage (operating voltage) at the 3RW52 soft starter.
- 3RW5 HMI High Feature (accessory)
Menu: "Parameters > Factory settings"
- Access protection to 3RW5 HMI High Feature is not active or has been removed.
- The 3RW5 HMI High Feature (LOCAL) has master control.

Procedure

1. Select the desired menu item.
 - Soft starter
 - Communication module
 - HMI High Feature
 - All devices
2. Confirm the menu item by pressing the OK key.

Result

The factory setting of the selected device or all devices is restored.

Note the effects of the factory settings (Page 174).

10.5.2 Restoring the factory settings with the Master RESET button via 3RW5 HMI High Feature

Requirements

- 3RW5 HMI High Feature (accessory)
- Make sure that the motor is switched off and that you do not start the motor while restoring the factory settings. To ensure the quickest and most fault-free restoration of the factory setting, it is recommended that you disconnect the main voltage (operating voltage) at the 3RW52 soft starter.
- Free access to the Master RESET key of the 3RW5 HMI High Feature.
Removing the High Feature 3RW5 HMI (Page 50)
- 3RW5 HMI High Feature is connected with the 3RW52 soft starter via the HMI connecting cable.

Procedure

1. Press the Master RESET key on the rear of the 3RW5 HMI High Feature.
The menu for restoring the factory setting appears on the display.
2. Select the desired menu item.
 - Soft starter
 - Communication module
 - HMI High Feature
 - All devices
3. Confirm the menu item by pressing the OK key.

Result

The factory setting of the selected device or all devices is restored.

Note the effects of the factory settings (Page 174).

10.5.3 Restoring the factory settings with the MODE and RESET / TEST keys

Requirements

- 3RW52 soft starter from firmware version V2.0
- Make sure that the motor is switched off and that you do not start the motor while restoring the factory settings. To ensure the quickest and most fault-free restoration of the factory setting, it is recommended that you disconnect the main power supply (operational voltage) at the 3RW52 soft starter.
- The 3RW5 communication module must be isolated from the 3RW52 soft starter.

Video instructions

Video instructions can be found in SIOS (<https://support.industry.siemens.com/cs/ww/en/view/109778874>):



Procedure

1. Start the restoration of the factory settings by pressing the MODE key longer than 2 seconds until the STATE / OVERLOAD LED flickers green.
Press and hold the MODE key.
2. Simultaneously press the RESET / TEST key down for at least 10 seconds.
After 2 seconds, the STATE / OVERLOAD LED begins to illuminate red.
After 10 s the STATE / OVERLOAD LED goes dark and switches back to displaying the motor operating state (e.g. flashing yellow-orange if there is no main power supply (operational voltage)).
3. Release the MODE and RESET / TEST keys.

Result

The factory setting of the 3RW52 soft starter is restored.

Note the effects of the factory settings (Page 174).

10.6 "Device change" function



! WARNING

**Hazardous voltage.
Can cause death or serious injury.**

The present device/part conducts hazardous voltages.

Touching live components will result in death or severe injury.

Installation, commissioning, and maintenance only by qualified specialist personnel.

The device replacement is only permissible by qualified personnel.

Operating principle

If the 3RW5 soft starter, the 3RW5 HMI High Feature (accessory) or the 3RW5 communication module (accessory) has to be replaced because of a fault, you can transfer data to your new device (identical type) using the "Device change" function or SIRIUS Soft Starter ES (TIA Portal). To be able to transfer data, you must first save it.

The following data are transferred with the "Device change" function:

- I&M 1 data
- I&M 3 data
- Device parameters of the 3RW5 HMI High Feature
- Communication parameters

Transmission options

- Device change with micro SD card on the 3RW5 HMI High Feature (Page 179)
- Device change with SIRIUS Soft Starter ES (TIA Portal) (Page 180)

10.6.1 Device change with micro SD card on the 3RW5 HMI High Feature

Requirements

- 3RW5 HMI High Feature (accessory)
- Micro SD card with the saved data (Page 139)
 - The folder (e.g. "1P3RW5 xxx-xxxxx+SLO...") is located in the root directory (top level).
 - The article number in the name of the folder must match the article number of the 3RW5 soft starter. The serial number in the name of the folder ("SLO...") does not need to match.
 - Menu: "Micro SD card > Load communication and HMI parameters to micro SD card"
The data is saved in an automatically generated folder (e.g. "1P3RW5 xxx-xxxxx+SLO...").

Procedure

1. Plug the micro SD card into the 3RW5 HMI High Feature.
2. Transfer the data to the device (3RW5 soft starter, 3RW5 HMI High Feature, 3RW5 communication module).
Menu: "Micro SD card > Device change"

Note

Device change

The current data of all devices (3RW5 soft starter, 3RW5 HMI High Feature, 3RW5 communication module) are overwritten by the data on the micro SD card.

3. Check the transferred data.

Result

You have transferred your saved data to your devices (3RW5 soft starter, 3RW5 HMI High Feature, 3RW5 communication module) with the "Device change" function.

10.6.2 Device change with SIRIUS Soft Starter ES (TIA Portal)

Requirements

- Accessories, e.g. 3RW5 HMI High Feature or 3RW5 PROFINET or PROFIBUS communication module
- Connection of the 3RW5 soft starter to SIRIUS Soft Starter ES (TIA Portal)
The 3RW5 soft starter must not be connected online to SIRIUS Soft Starter ES (TIA Portal).
- Project in SIRIUS Soft Starter ES (TIA Portal) with saved data (identical type)
Button: "Upload from device" on the toolbar.
In the "Project navigation" window, the 3RW5 soft starter must be selected in the current project so that the button can be operated.

Procedure

1. Transfer the data to the device (3RW5 soft starter, 3RW5 HMI High Feature, 3RW5 communication module) with SIRIUS Soft Starter ES (TIA Portal).
Button: "Load to device" on the toolbar.
In the "Project navigation" window, the 3RW5 soft starter must be selected in the current project so that the button can be operated.

Note

Device change

The current data of all devices (3RW5 soft starter, 3RW5 HMI High Feature, 3RW5 communication module) are overwritten by the transferred data.

2. Check the transferred data.

Result

You have transferred your saved data to your devices (3RW5 soft starter, 3RW5 HMI High Feature, 3RW5 communication module) with SIRIUS Soft Starter ES (TIA Portal).

Technical specifications

11.1 Technical data in Siemens Industry Online Support

Technical data sheet

You can also find the technical data of the product at Siemens Industry Online Support (<https://support.industry.siemens.com/cs/ww/en/ps/16212/td>).

1. Enter the full article number of the desired device in the "Product" field, and confirm with the Enter key.
2. Click the "Technical data" link.

The screenshot shows the Siemens Industry Online Support search interface. At the top, there is a search bar with the text "Enter keyword...". Below the search bar, there are three input fields: "Product", "Entry type", and "Date". The "Product" field contains the text "3RV2031-4BA10" and is highlighted with a red box. The "Entry type" field contains the text "Technical data (1)" and is also highlighted with a red box. The "Date" field is empty. Below the search bar, there is a button labeled "> Search product". Below the search bar, there is a search result for the product "3RV2031-4BA10". The result includes a small image of the product and the following text: "3RV2031-4BA10", "CIRCUIT BREAKER, SCREW TYPE, 20 A", "CIRCUIT BREAKER SIZE S2, FOR MOTOR PROTECTION, CLASS 10, A-RELEASE 14...30A, N-RELEASE 20DA, SCREW TERMINAL, STANDARD BREAKING CAPACITY". Below the text, there are three links: "> Product details", "> Technical data" (highlighted with a red box), and "> CAx data".

Overview tables technical data

You will find overview tables with technical data in the "Product information" tab in our online ordering system (<https://mall.industry.siemens.com/mall/en/WW/Catalog/Products/10024029?tree=CatalogTree>).

Dimension drawings

12.1 CAx data

You can find the CAx data in the Siemens Industry Online Support (<https://support.industry.siemens.com/cs/ww/en/ps/16212/td>).

1. Enter the full article number of the desired device in the "Product" field, and confirm with the Enter key.
2. Click the "CAx data link.

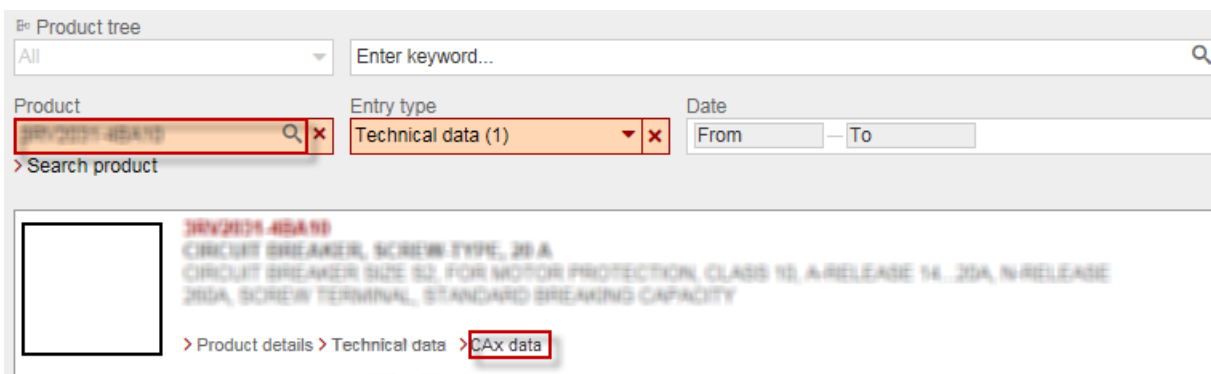

12.2 Drilling pattern for 3RW5 HMI Standard

The drilling pattern below supports you when installing a 3RW5 HMI Standard with push-in lugs on a level surface.

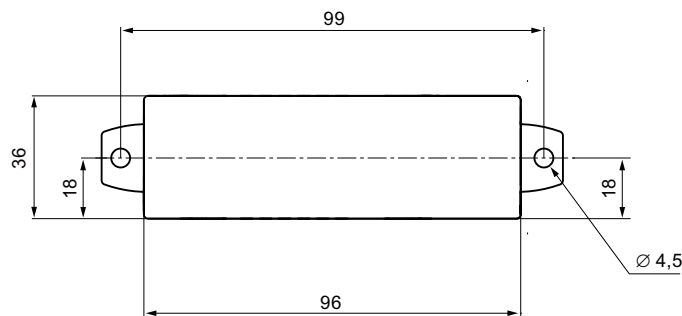

12.3 Drilling pattern for 3RW5 HMI High Feature

The drilling pattern below supports you when installing a 3RW5 HMI High Feature with push-in lugs on a level surface.

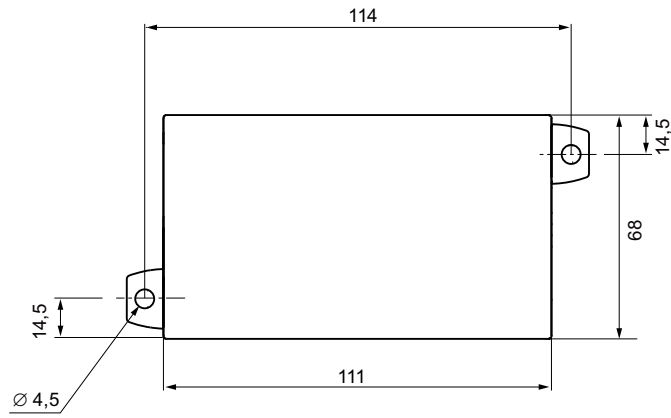

Circuit diagrams

13.1 CAx data

You can find the CAx data in the Siemens Industry Online Support (<https://support.industry.siemens.com/cs/ww/en/ps/16212/td>).

1. Enter the full article number of the desired device in the "Product" field, and confirm with the Enter key.
2. Click the "CAx data link.

The screenshot shows the Siemens Industry Online Support search interface. At the top, there is a search bar with the text "Enter keyword..." and a magnifying glass icon. Below the search bar, there are three main sections: "Product", "Entry type", and "Date". The "Product" field contains the text "3RV2031-4BA10" and has a magnifying glass icon and a close button (X). The "Entry type" field contains the text "Technical data (1)" and has a dropdown arrow and a close button (X). The "Date" field contains the text "From" and "To" with a dropdown arrow. Below these fields, there is a "Search product" button. The search results are displayed in a table with a single entry for the product "3RV2031-4BA10". The entry includes a small image of the product, the product name, and a description: "CIRCUIT BREAKER, SCREW TYPE, 20 A, CIRCUIT BREAKER SIZE S2, FOR MOTOR PROTECTION, CLASS 10, A-RELEASE 14...30A, N-RELEASE 20DA, SCREW TERMINAL, STANDARD BREAKING CAPACITY". Below the description, there are navigation links: "> Product details", "> Technical data", and "> CAx data". The "CAx data" link is highlighted with a red box.

Example circuits

A.1 Main circuit connection

A.1.1 Feeder assembly, type of coordination 1 fuseless

Feeder assembly

Connect the 3RW52 soft starter at its terminals to the motor feeder between the motor starter protector and the motor. This achieves type of coordination 1.

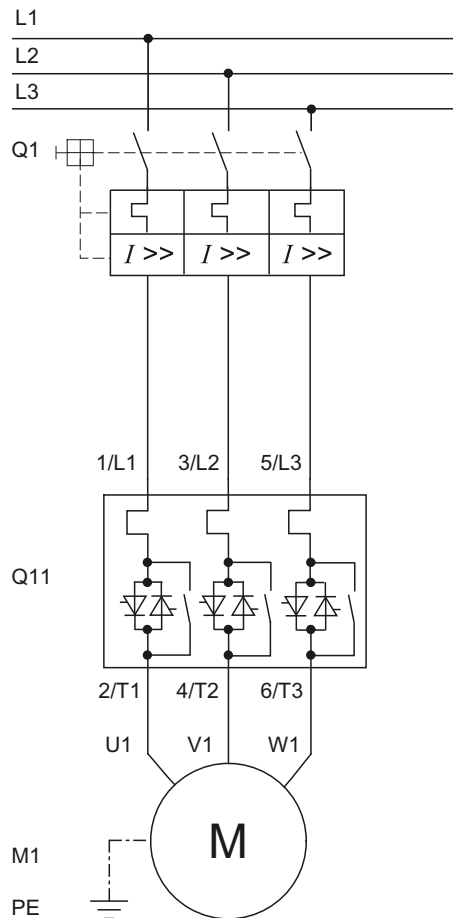

Q1 Motor starter protector (e.g. 3RV2 or 3VA)

Q11 3RW52 soft starter

A.1 Main circuit connection

- M1 Motor
- PE Protective conductor

A.1.2 Feeder assembly, type of coordination 1 with fuses

Feeder assembly

If galvanic isolation is required, install a main or line contactor between the 3RW52 soft starter and the fuses.

Do not connect the main and line contactor between the 3RW52 soft starter and the motor. The 3RW52 soft starter could otherwise indicate a "Missing load" fault in case of a start command and delayed connection of the contactor.

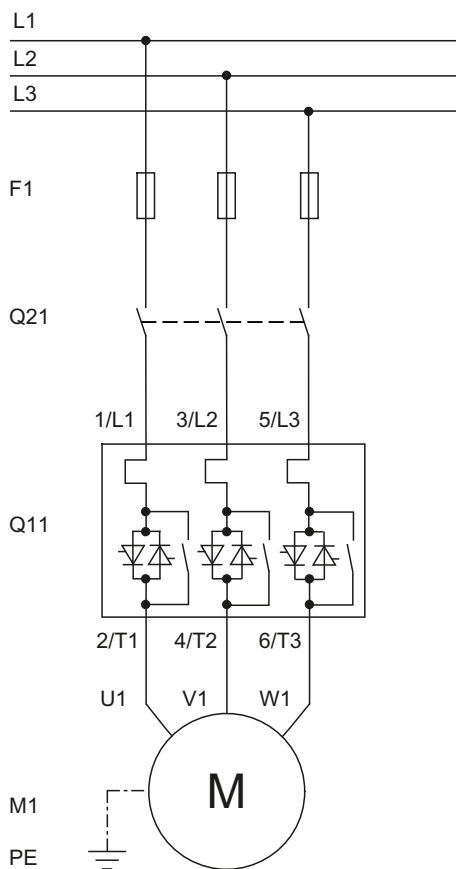

- F1 gG full-range fuse for cable and line protection (e.g. 3NA3)
- Q21 Main or line contactor for galvanic isolation
- Q11 3RW52 soft starter
- M1 Motor
- PE Protective conductor

A.1.3 Feeder assembly, type of coordination 2

Feeder assembly

You must provide protection for all thyristors against short circuits by means of special semiconductor fuses (e.g. SITOR fuses from Siemens) to achieve type of coordination 2. A short circuit can occur, for instance, as a result of a defect in the motor windings or in the motor's power supply cable.

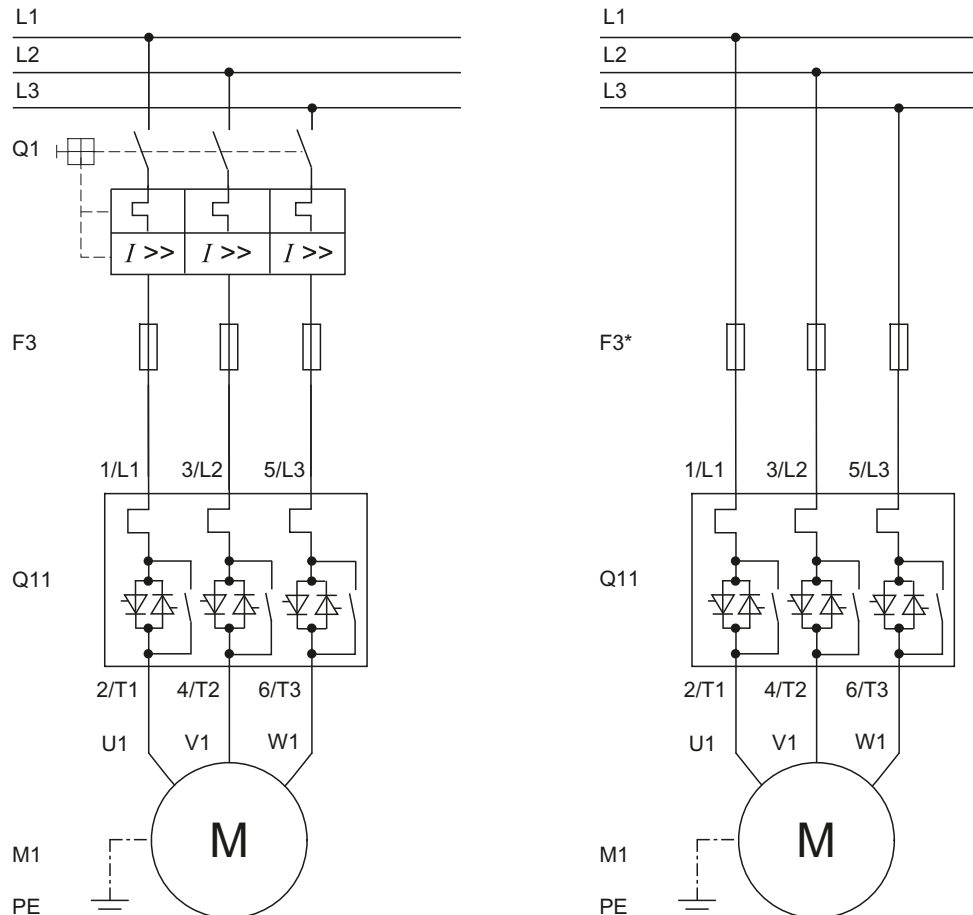

- Q1 Motor starter protector
- F3 aR partial-range fuse for protection of semiconductors (e.g. SITOR 3NE3/4 or 3NC3)
- F3* gR full-range fuse for protection of semiconductors (e.g. SITOR 3NE1)
- Q11 3RW52 soft starter
- M1 Motor
- PE Protective conductor

A.1.4 Inside-delta circuit

If the 3RW52 soft starter is operated in an inside-delta circuit, the motor power output of the individual devices is increased by a factor of root 3. On the 3RW52 soft starter behind the hinged cover, you will find a value table with increased current values for an inside-delta circuit.

If the main voltage (operating voltage) is connected and the motor is connected to the 3RW52 soft starter, the 3RW52 soft starter automatically detects the motor connection type.

Requirements

Motor with windings that can be connected in a delta with line voltage predominating.

Motor rotation in line phase direction

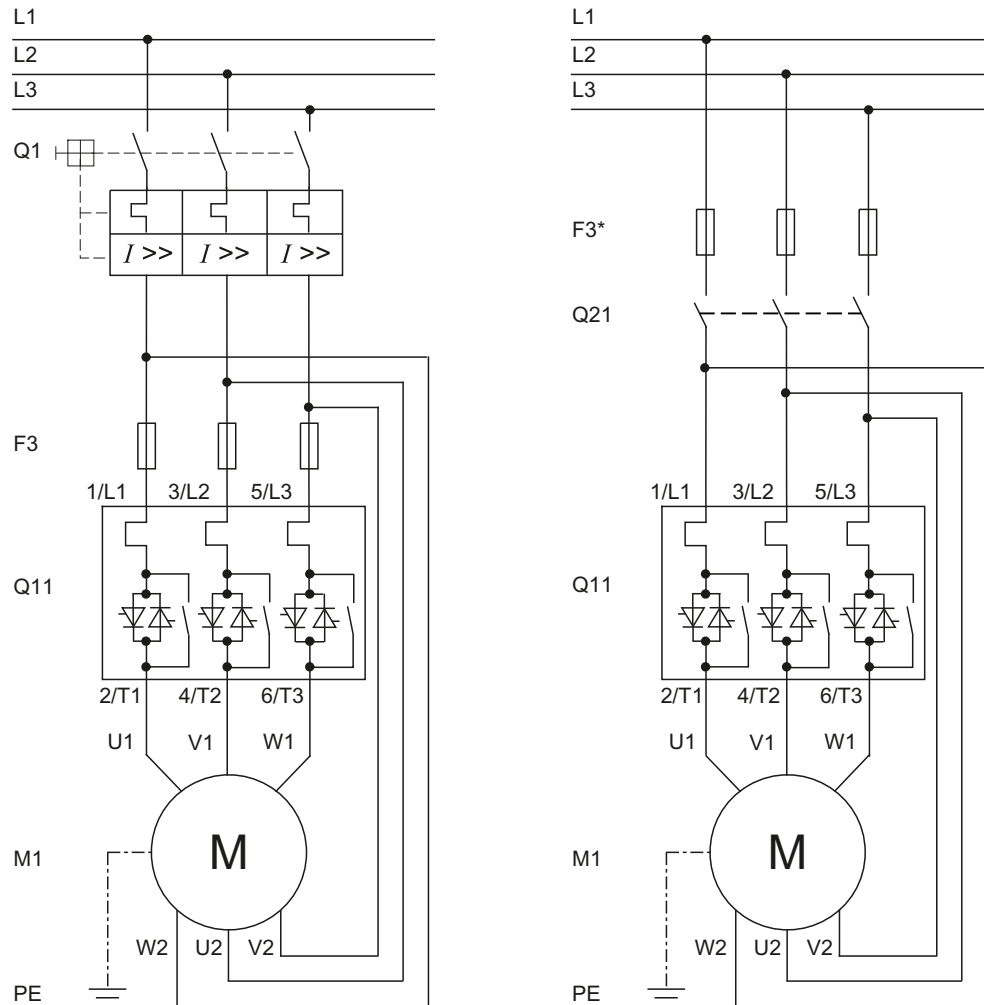

- Q1 Motor starter protector
- F3 aR partial-range fuse for protection of semiconductors (e.g. SITOR 3NE3/4 or 3NC)
- F3* gR full-range fuse for protection of semiconductors (e.g. SITOR 3NE1)
- Q11 3RW52 soft starter
- Q21 Main or line contactor for galvanic isolation
- M1 Motor
- PE Protective conductor

Motor rotation contrary to the line phase direction

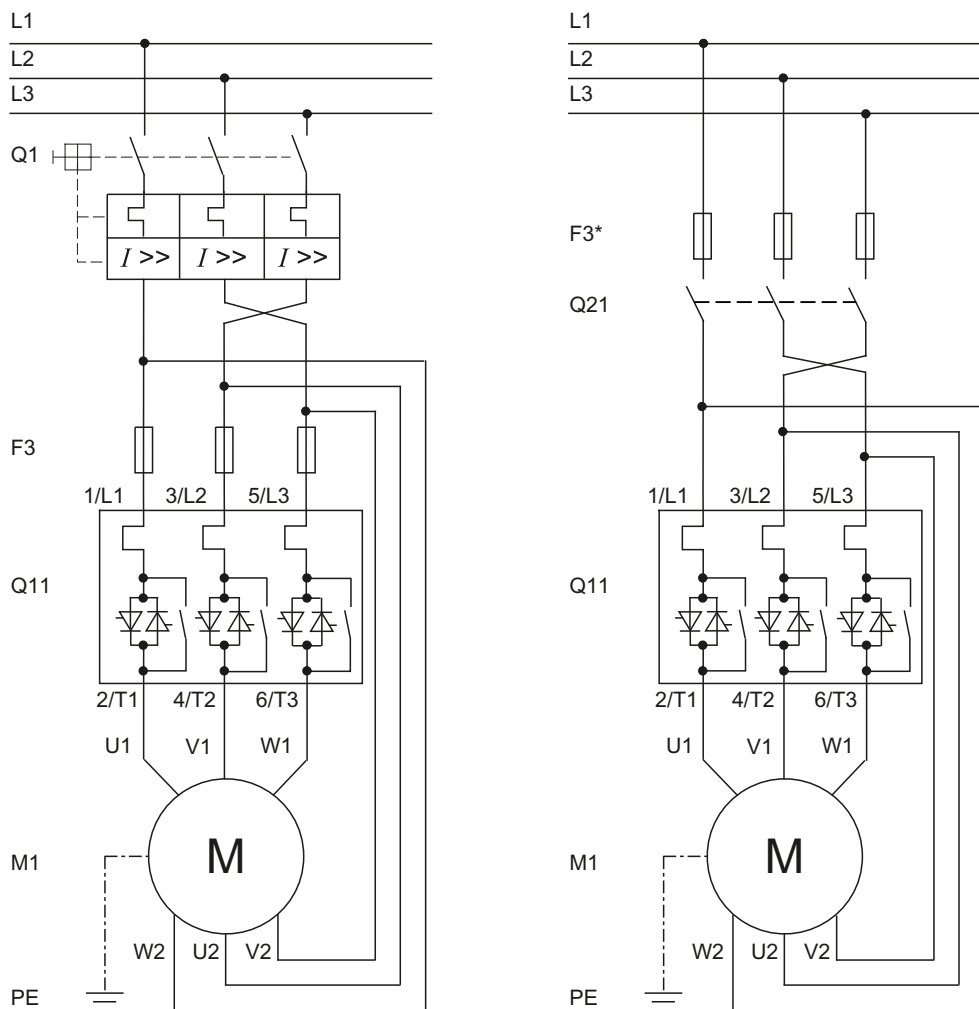

- Q1 Motor starter protector
- F3 aR partial-range fuse for protection of semiconductors (e.g. SITOR 3NE3/4 or 3NC)
- F3* gR full-range fuse for protection of semiconductors (e.g. SITOR 3NE1)
- Q11 3RW52 soft starter
- Q21 Main or line contactor for galvanic isolation
- M1 Motor
- PE Protective conductor

A.2 Control circuit connection

A.2.1 Control by pushbutton

Requirements

ON / RUN relay output was parameterized to ON.

Wiring of control circuit for control by pushbutton

The example shows the 3RW52 soft starter in the inline circuit.

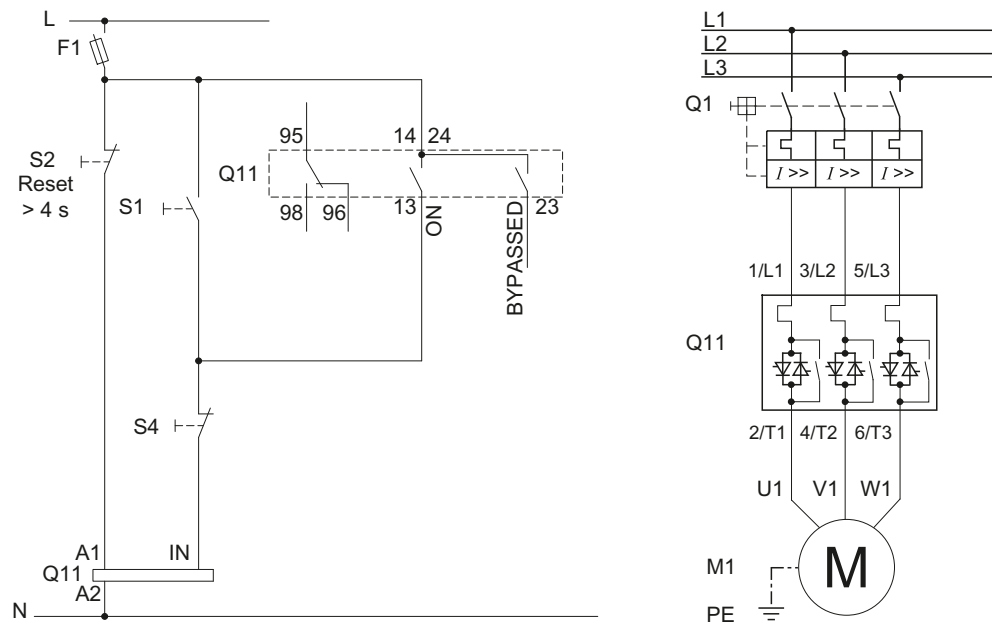

- F1 Fuse
- S1 Pushbutton: Start motor
- S2 Pushbutton: Reset > 4 s
- S4 Pushbutton: Stop motor
- Q1 Motor starter protector
- Q11 3RW52 soft starter
- M1 Motor
- PE Protective conductor

A.2.2 Control by switch

Requirements



WARNING

Automatic restart.

Can cause death or serious injury.

If a starting command is pending, a restart will be triggered automatically after the reset. This particularly applies if the motor protection has tripped. Dangerous states of the system can result.

Reset the start command (e.g. via the PLC or switch) before performing a reset.

To do this, for example, link the group error output (terminals 95 and 96) into the control.

Wiring of control circuit for control by switch

The example shows the 3RW52 soft starter in the inline circuit.

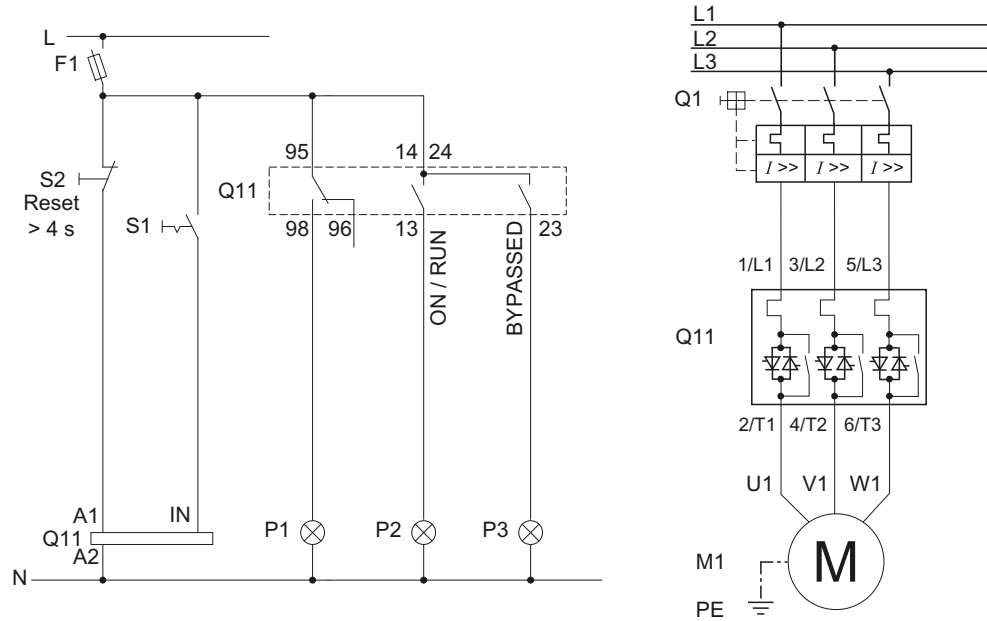

- F1 Fuse
- S1 Switch: Start/stop
- S2 Pushbutton: Reset > 4 s
- Q1 Motor starter protector
- Q11 3RW52 soft starter
- M1 Motor
- P1 Indicator light
- P2 Indicator light
- P3 Indicator light
- PE Protective conductor

A.2.3 Switching with supply voltage (control supply voltage)

Requirements

Because of the intrinsic protection, allow an interval of at least 5 minutes to elapse before restarting the device if the device is switched on and off in normal operation by means of the supply voltage (control supply voltage).

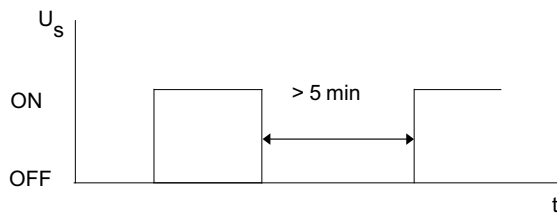

<p>⚠ WARNING</p> <p>Automatic restart. Can cause death or serious injury.</p> <p>If a starting command is pending, a restart will be triggered automatically after the reset. This particularly applies if the motor protection has tripped. Dangerous states of the system can result.</p> <p>Reset the start command (e.g. via the PLC or switch) before performing a reset.</p> <p>To do this, for example, link the group error output (terminals 95 and 96) into the control.</p>
--

Wiring control circuit on switching with the supply voltage (control supply voltage)

The example shows the 3RW52 soft starter in the inline circuit.

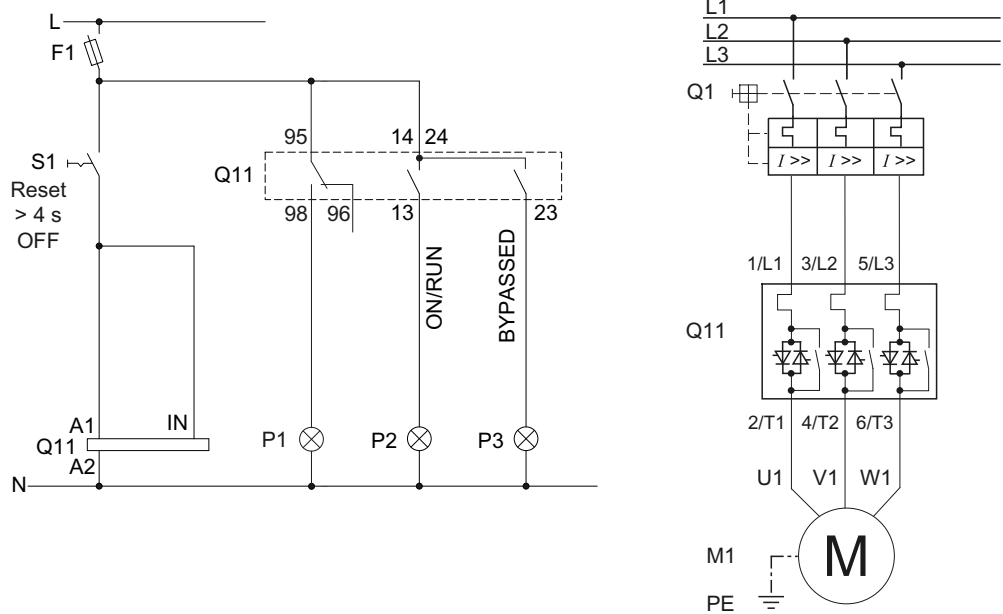

- F1 Fuse
- S1 Switch: Reset > 4 s OFF
- Q1 Motor starter protector
- Q11 3RW52 soft starter
- M1 Motor
- P1 Indicator light
- P2 Indicator light
- P3 Indicator light
- PE Protective conductor

A.2.4 Control by PLC

Requirements

Utilization of a 3RW52 soft starter...4 (24 V) and power supply with DC voltage.

 **WARNING**

Automatic restart.

Can cause death or serious injury.

If a starting command is pending, a restart will be triggered automatically after the reset. This particularly applies if the motor protection has tripped. Dangerous states of the system can result.

Reset the start command (e.g. via the PLC or switch) before performing a reset.

To do this, for example, link the group error output (terminals 95 and 96) into the control.

Wiring of control circuit for control by PLC

The example shows the 3RW52 soft starter in the inline circuit.

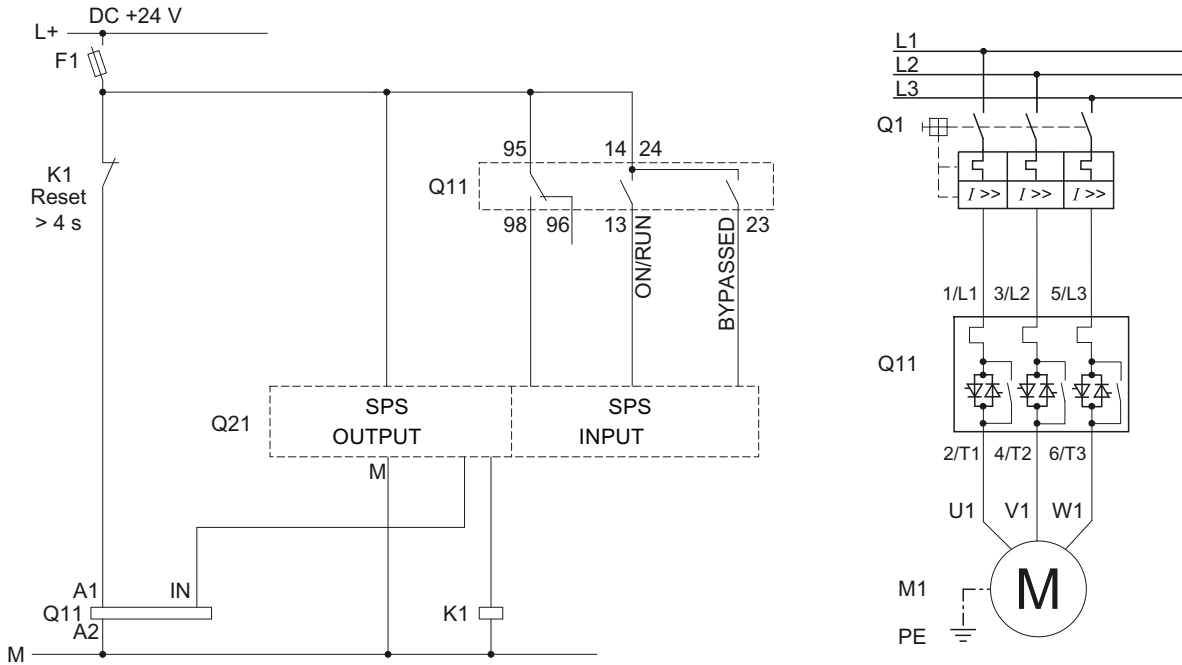

- F1 Fuse
- K1 Coupling relay control for reset > 4 s
- Q1 Motor starter protector
- Q11 3RW52 soft starter
- Q21 PLC
- M1 Motor
- PE Protective conductor

A.2.5 Actuation of a line contactor

Requirements

ON / RUN relay output was parameterized to RUN.



WARNING

Automatic restart.

Can cause death or serious injury.

If a starting command is pending, a restart will be triggered automatically after the reset. This particularly applies if the motor protection has tripped. Dangerous states of the system can result.

Reset the start command (e.g. via the PLC or switch) before performing a reset.

To do this, for example, link the group error output (terminals 95 and 96) into the control.

Wiring of control circuit for controlling a line contactor

The example shows the 3RW52 soft starter in the inline circuit.

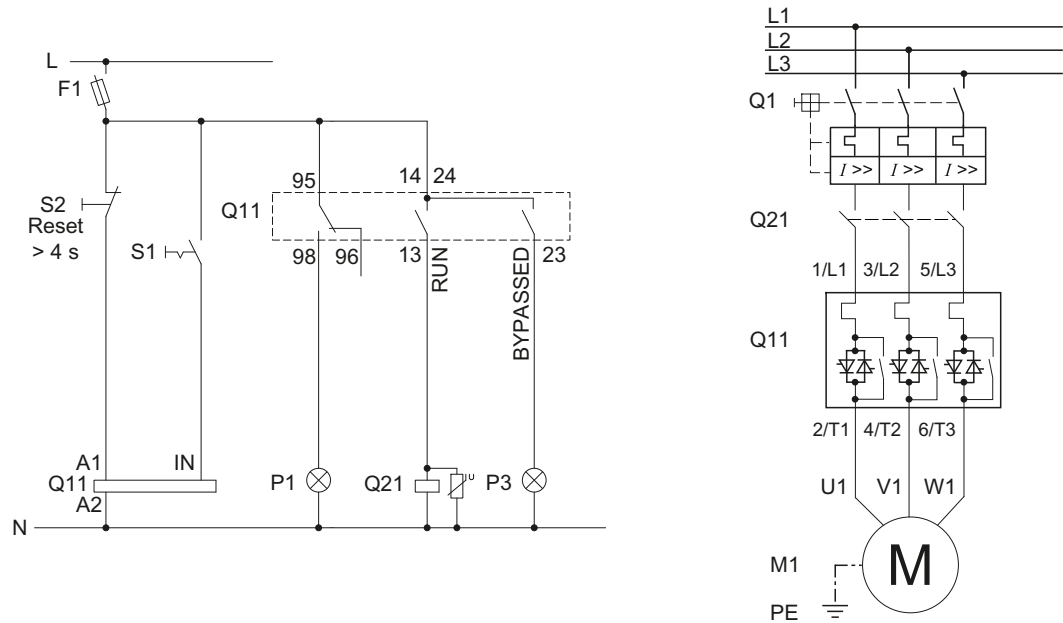

- F1 Fuse
- S1 Switch: Start/stop
- S2 Pushbutton: Reset > 4 s
- Q1 Motor starter protector
- Q11 3RW52 soft starter
- Q21 Line contactor
- M1 Motor
- P1 Indicator light
- P3 Indicator light
- PE Protective conductor

A.2.6 Wiring for remote RESET

Procedure

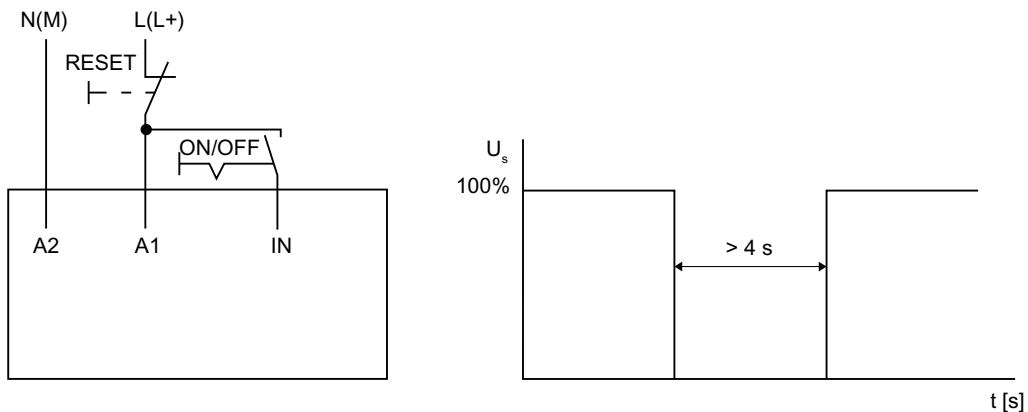

Result

You can reset a pending error message by operating the reset button for > 4 s.

A.2.7 Connecting the temperature sensor

Requirements

- 3RW52 soft starter with thermistor motor protection
- Motor with temperature switch (e.g. Thermoclick) or thermistor (e.g. PTC type A)

Procedure

1. Remove the copper link between terminals and T11 / T21 and T22.
2. Connect the temperature sensor:

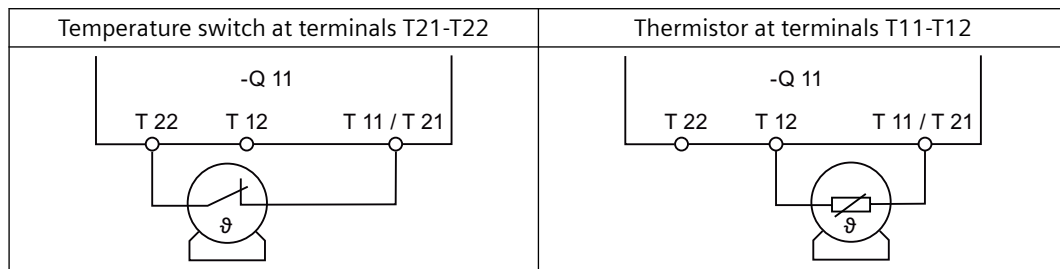

Result

The 3RW52 soft starter monitors the motor for excessive temperature. The motor is shut down if the maximum temperature limit is exceeded. The setting for RESET MODE (Page 85) determines how the motor is restarted.

A.2.8 Connecting the evaluation unit to the analog output

Requirements

- 3RW52 soft starter with analog output
- Evaluation unit for displaying the analog output signal
- Parameterized analog output (Page 99)

Procedure

Connect the evaluation unit:

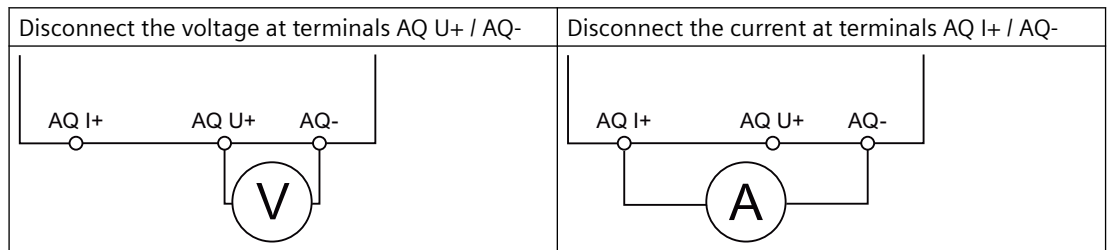

Result

The actual average phase current of the motor is displayed in % at the evaluation unit via the analog output.

A.3 Special applications

A.3.1 Reversing circuit

Requirements

Soft stopping is not possible. Set the stopping time on the setting element of the 3RW52 soft starter to "0 s" (factory setting).



WARNING

Automatic restart.

Can cause death or serious injury.

If a starting command is pending, a restart will be triggered automatically after the reset. This particularly applies if the motor protection has tripped. Dangerous states of the system can result.

Reset the start command (e.g. via the PLC or switch) before performing a reset.

To do this, for example, link the group error output (terminals 95 and 96) into the control.

Wiring

The example shows the 3RW52 soft starter in the inline circuit.

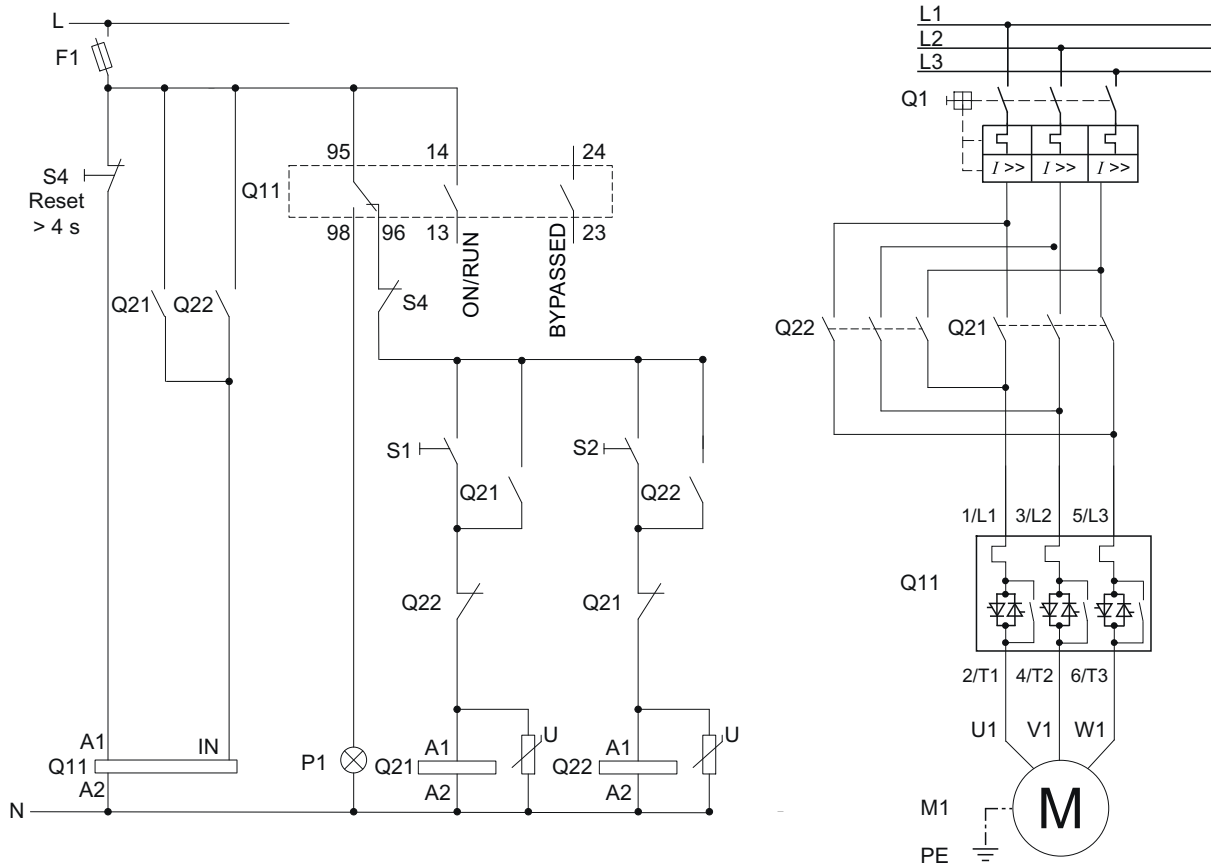

- F1 Fuse
- S1 Pushbutton: Motor ON - RIGHT
- S2 Pushbutton: Motor ON - LEFT
- S4 Pushbutton: Reset > 4 s
- Q1 Motor starter protector
- Q11 3RW52 soft starter
- Q21 Contactor right
- Q22 Contactor left
- P1 Indicator light
- M1 Motor
- PE Protective conductor

A.3.2 Controlling a motor with a magnetic parking brake

Requirements

ON / RUN relay output was parameterized to RUN.



WARNING

Automatic restart.

Can cause death or serious injury.

If a starting command is pending, a restart will be triggered automatically after the reset. This particularly applies if the motor protection has tripped. Dangerous states of the system can result.

Reset the start command (e.g. via the PLC or switch) before performing a reset.

To do this, for example, link the group error output (terminals 95 and 96) into the control.

Wiring

The example shows the 3RW52 soft starter in the inline circuit.

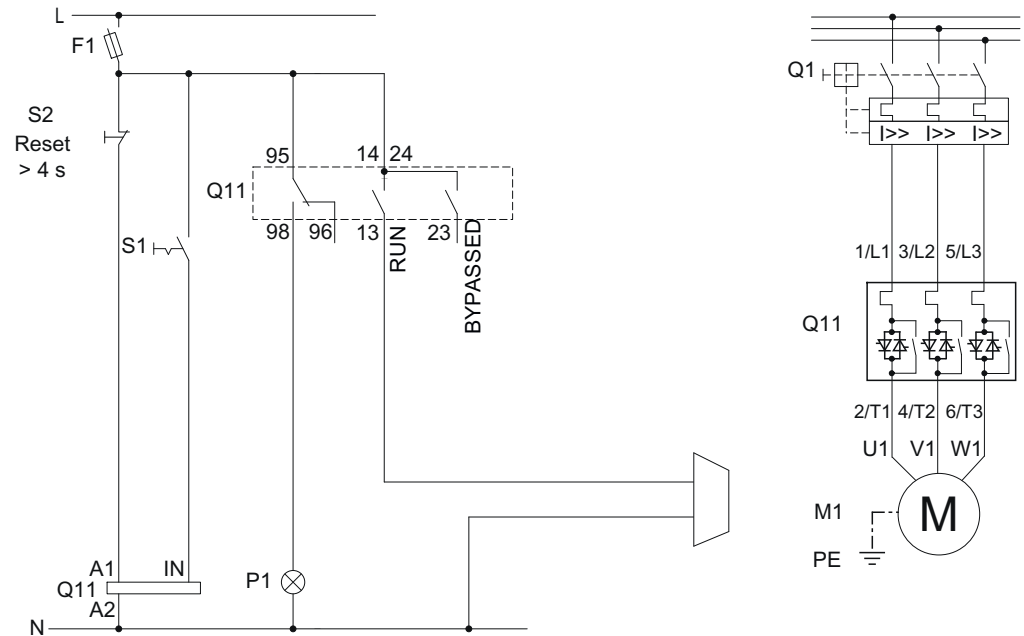

- F1 Fuse
- S1 Switch: Start/stop
- S2 Pushbutton: Reset > 4 s
- Q1 Motor starter protector
- Q11 3RW52 soft starter
- P1 Indicator light, fault
- M1 Motor
- PE Protective conductor

A.3.3 EMERGENCY STOP shutdown to SIL 1 or PL c with a 3SK1 safety relay

The 3RW52 soft starter has no effect or influence on the safety function of the application. For this reason, it is neither positively nor negatively considered in the safety application, and also does not have to be included in the calculation for proof according to the standards.

Requirements



WARNING

Automatic restart.

Can cause death or serious injury.

If a starting command is pending, a restart will be triggered automatically after the reset. This particularly applies if the motor protection has tripped. Dangerous states of the system can result.

Reset the start command (e.g. via the PLC or switch) before performing a reset.

To do this, for example, link the group error output (terminals 95 and 96) into the control.

Tripping of the EMERGENCY STOP circuit

If the soft stop function is set (Stopping time setting element set to > 0 s) and the emergency stop circuit is tripped, a "Missing load" fault message may be indicated on the 3RW52 soft starter. In this case, the 3RW52 soft starter must be reset according to the selected RESET MODE (Page 85).

Basic configuration

If achievement of SILCL 1 according to IEC 62061 / PL c according to EN ISO 13849-1 is required, the series connection of an additional contactor with the 3RW52 soft starter, together with a suitable safety relay (e.g.: 3SK1111), is required, as well as monitoring of the contactor's auxiliary contacts.

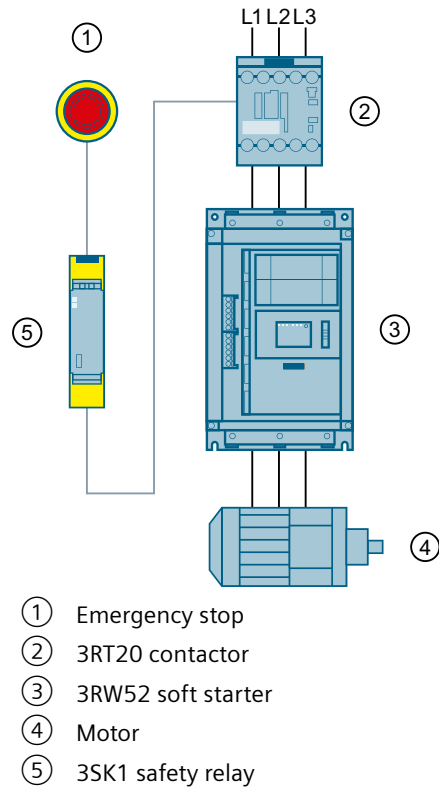

Wiring of the 3RW52 soft starter

The example shows the 3RW52 soft starter in the inline circuit.

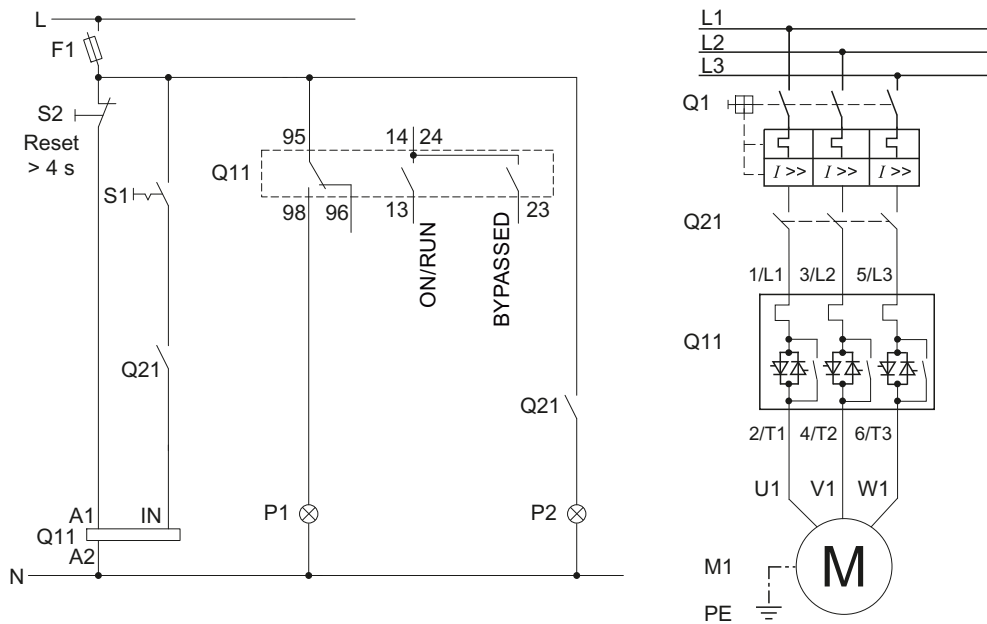

- F1 Fuse
- S1 Switch: Start / stop
- S2 Pushbutton: Reset > 4 s
- Q1 Motor starter protector
- Q11 3RW52 soft starter
- Q21 Contactor
- P1 Indicator light
- P2 Indicator light
- M1 Motor
- PE Protective conductor

Wiring of the 3SK1 safety relay SIL 1 with line contactor

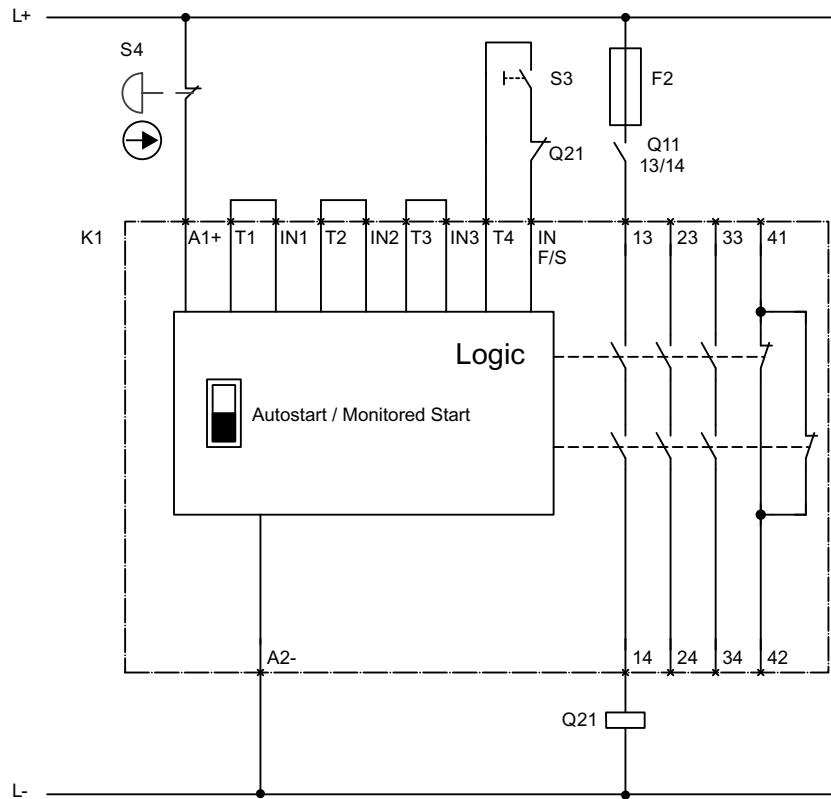

- F2 Fuse
- Q11 Line contactor
- Q21 Contactor
- S3 Start button
- S4 EMERGENCY STOP
- K1 3SK1111 safety relay

Wiring of the 3SK1 safety relay SIL 1 without line contactor

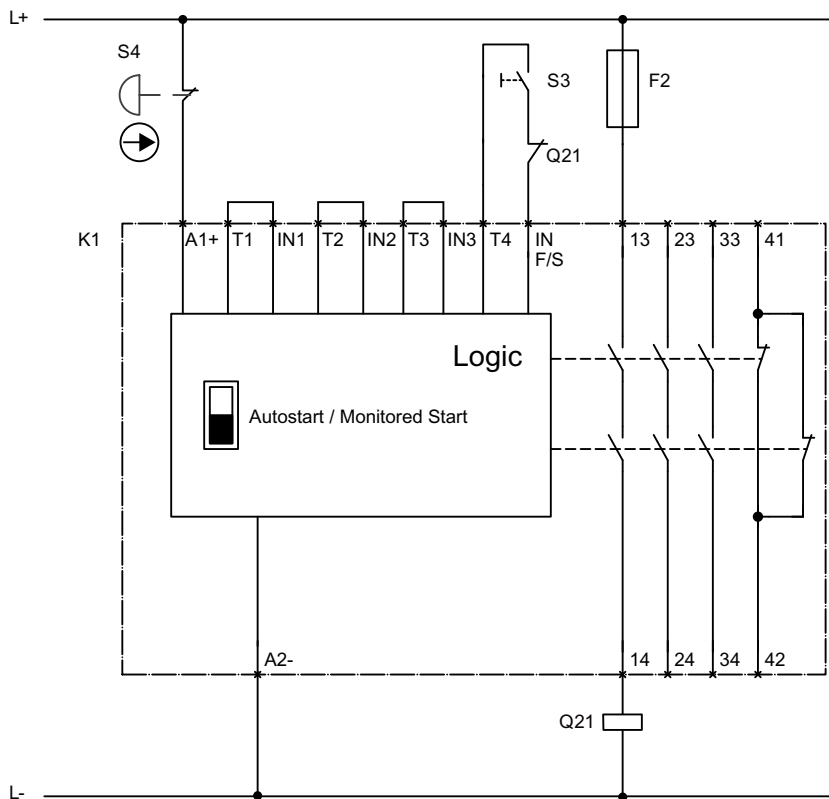

- F2 Fuse
- Q21 Contactor
- S3 Start button
- S4 EMERGENCY STOP
- K1 3SK1111 safety relay

A.3.4 EMERGENCY STOP shutdown to SIL 3 or PL e with a 3SK1 safety relay

The 3RW52 soft starter has no effect or influence on the safety function of the application. For this reason, it is neither positively nor negatively considered in the safety application, and also does not have to be included in the calculation for proof according to the standards.

Requirements



WARNING

Automatic restart.

Can cause death or serious injury.

If a starting command is pending, a restart will be triggered automatically after the reset. This particularly applies if the motor protection has tripped. Dangerous states of the system can result.

Reset the start command (e.g. via the PLC or switch) before performing a reset.

To do this, for example, link the group error output (terminals 95 and 96) into the control.

Tripping of the EMERGENCY STOP circuit

If the soft stop function is set (Stopping time setting element set to > 0 s) and the emergency stop circuit is tripped, a "Missing load" fault message may be indicated on the 3RW52 soft starter. In this case, the 3RW52 soft starter must be reset according to the selected RESET MODE (Page 85).

Basic configuration

Safe shutdown up to SILCL 3 according to IEC 62061 / PL e according to EN ISO 13849-1 requires the use of 2 redundant contactors and monitoring of the auxiliary contacts of both contactors. Two-channel monitoring of the EMERGENCY STOP is also required here.

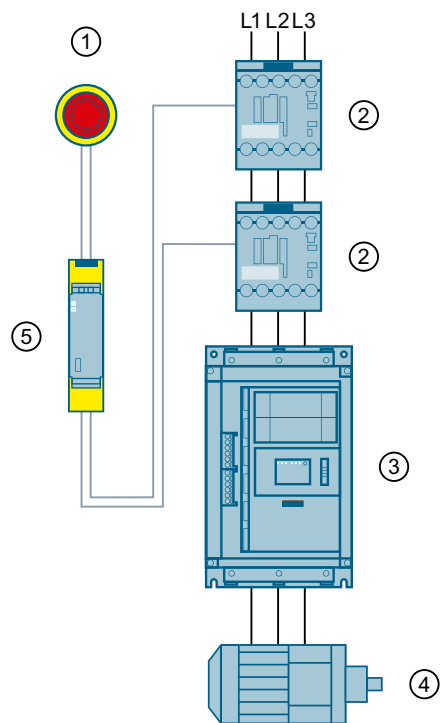

- ① Emergency stop
- ② 3RT20 contactors
- ③ 3RW52 soft starter
- ④ Motor
- ⑤ 3SK1 safety relay

Wiring of the 3RW52 soft starter

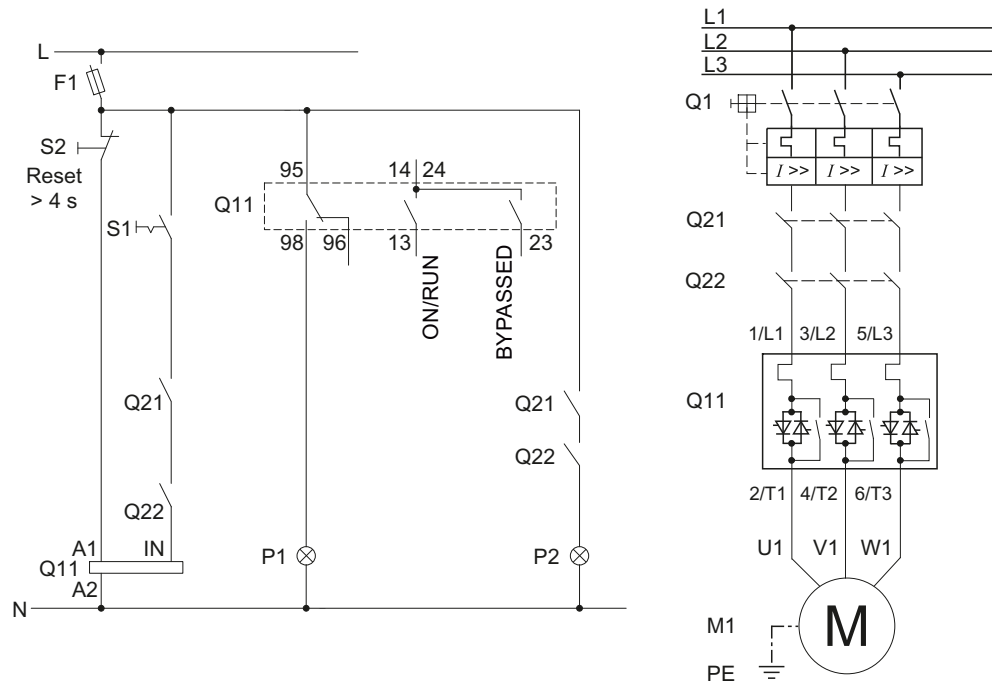

- F1 Fuse
- S1 Switch: Start / stop
- S2 Pushbutton: Reset > 4 s
- Q1 Motor starter protector
- Q11 3RW52 soft starter
- Q21 Contactor
- Q22 Contactor
- P1 Indicator light
- P2 Indicator light
- M1 Motor
- PE Protective conductor

Wiring of the 3SK1 safety relay SIL 3 with line contactor

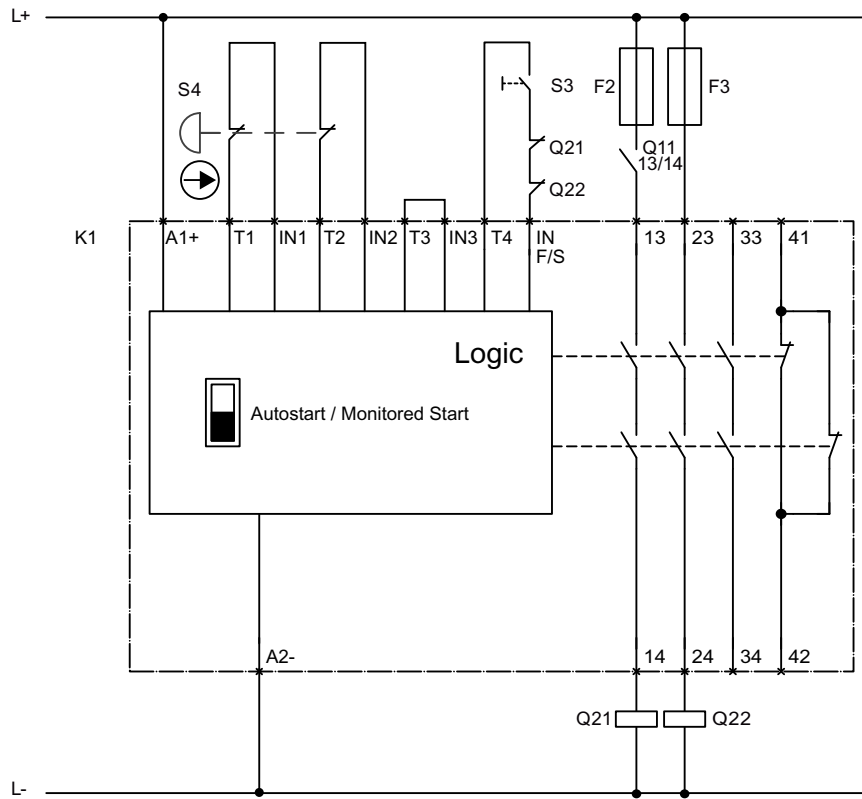

- F2 Fuse
- F3 Fuse
- Q11 Line contactor
- Q21 Contactor
- Q22 Contactor
- S3 Start button
- S4 EMERGENCY STOP
- K1 3SK1111 safety relay

Wiring of the 3SK1 safety relay SIL 3 without line contactor

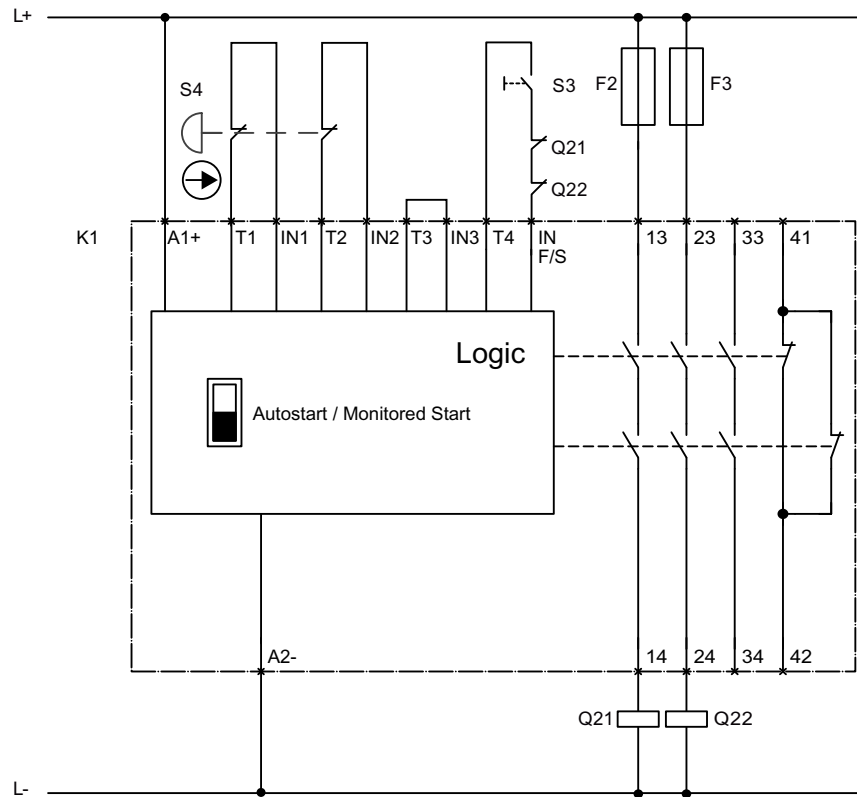

- F2 Fuse
- F3 Fuse
- Q21 Contactor
- Q22 Contactor
- S3 Start button
- S4 EMERGENCY STOP
- K1 3SK1111 safety relay

A.3.5 Contactor for emergency start

Requirements

 **WARNING**

Automatic restart.

Can cause death or serious injury.

If a starting command is pending, a restart will be triggered automatically after the reset. This particularly applies if the motor protection has tripped. Dangerous states of the system can result.

Reset the start command (e.g. via the PLC or switch) before performing a reset.

To do this, for example, link the group error output (terminals 95 and 96) into the control.

Wiring

The example shows the 3RW52 soft starter in the inline circuit.

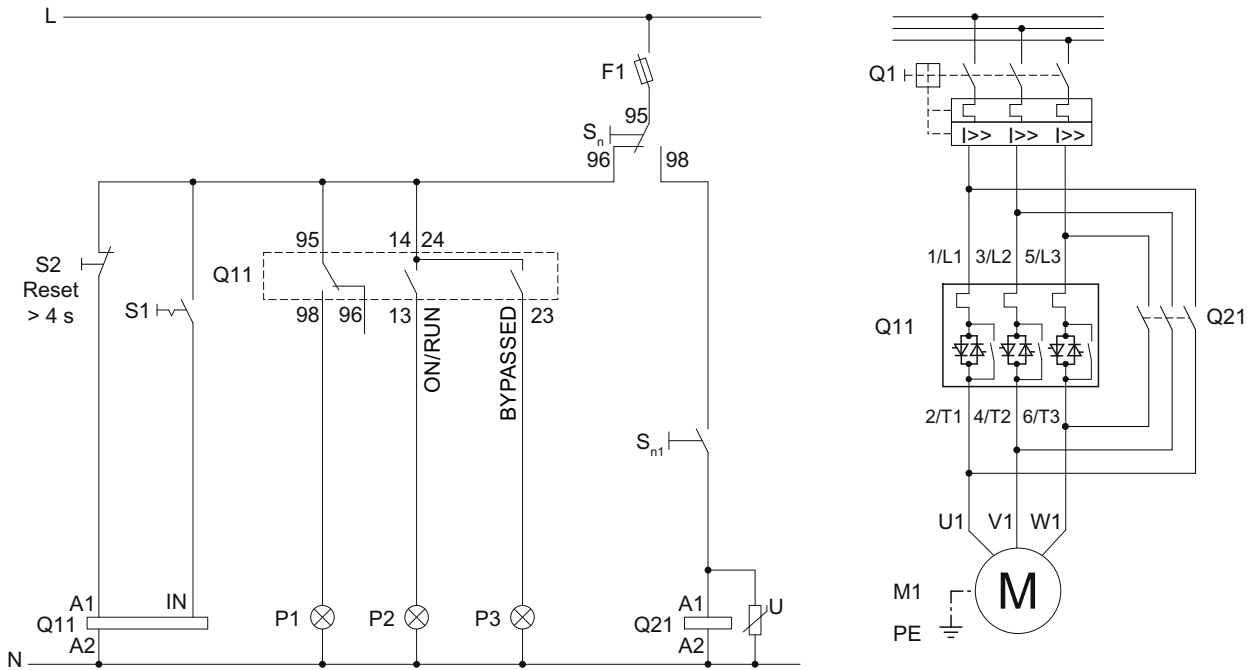

- | | |
|-----------------|--|
| F1 | Fuse |
| S1 | Switch: Start/stop |
| S2 | Pushbutton: Reset > 4 s |
| S _n | Soft start selector button |
| S _{n1} | Start / stop (direct-on-line starting) |
| Q1 | Motor starter protector |
| Q11 | Soft starter |
| Q21 | Direct-on-line starting contactor |
| P1 | Indicator light, fault |
| P2 | Indicator light |
| P3 | Indicator light |
| M1 | Motor |
| PE | Protective conductor |

A.3.6 Starting a Dahlander motor

Requirements

- ON / RUN relay output was parameterized to ON.
- No soft stop possible. Set the stopping time to 0 s at the setting element

 **WARNING**

Automatic restart.

Can cause death or serious injury.

If a starting command is pending, a restart will be triggered automatically after the reset. This particularly applies if the motor protection has tripped. Dangerous states of the system can result.

Reset the start command (e.g. via the PLC or switch) before performing a reset.

To do this, for example, link the group error output (terminals 95 and 96) into the control.

Wiring

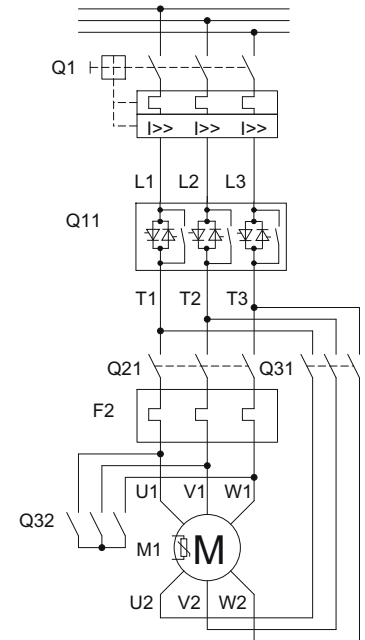
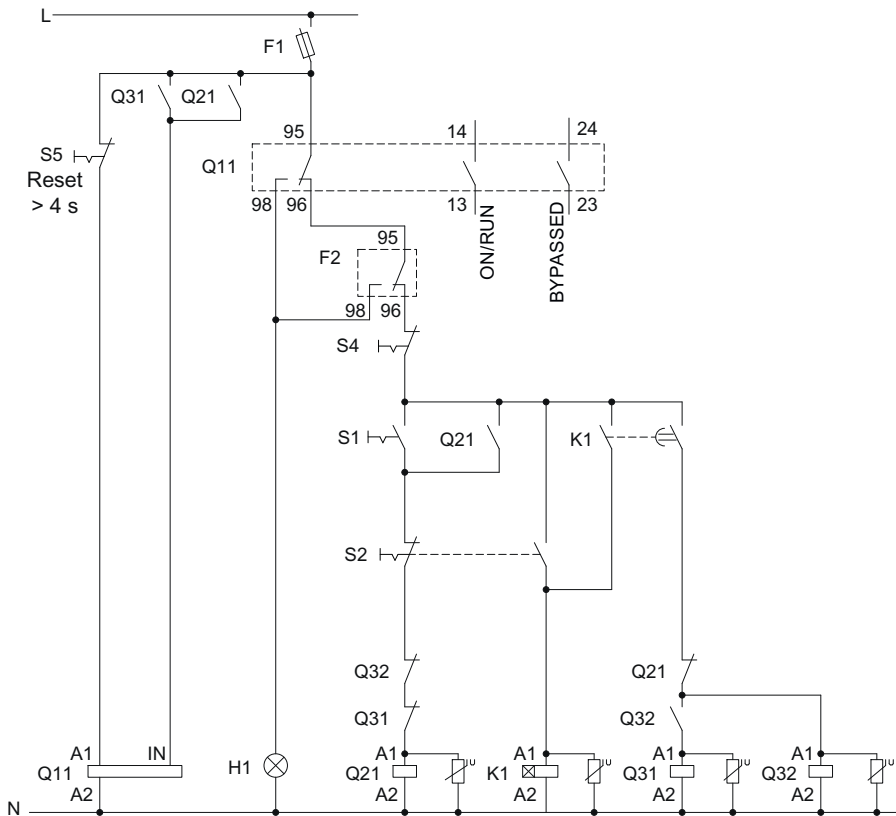

- F1 Fuse
- F2 Fuse: for motor overload protection, set the rated operational current of the low speed
- K1 Contactor relay for switching delay (response delay 500 ms)
- S1 Pushbutton: Start, low speed
- S2 Pushbutton: Start, high speed
- S4 Pushbutton: Motor stop
- S5 Pushbutton: Reset > 4 s
- Q1 Motor starter protector
- Q11 3RW5 soft starter: for motor overload protection, set rated operational current of the high speed
- Q21 Line contactor: Low speed
- Q31 Line contactor: High speed
- Q32 Star (wye) contactor: High speed
- H1 Indicator light: Fault
- M1 Motor

A.3.7 External bypass

Requirements

- Parameter "Trip class" is set to "CLASS OFF".
- The "Bypass operating mode" parameter (in the "Additional parameters" menu) is set to "External bypass".
- External bypass contactor
- External overload relay

NOTICE
Material damage due to overload
If an external bypass is used, the intrinsic device protection and the motor overload protection will be deactivated. This can result in damage to the soft starter or the motor due to overload.
Use an additional external overload protection to protect the soft starter and the motor from damage due to overload.

Wiring

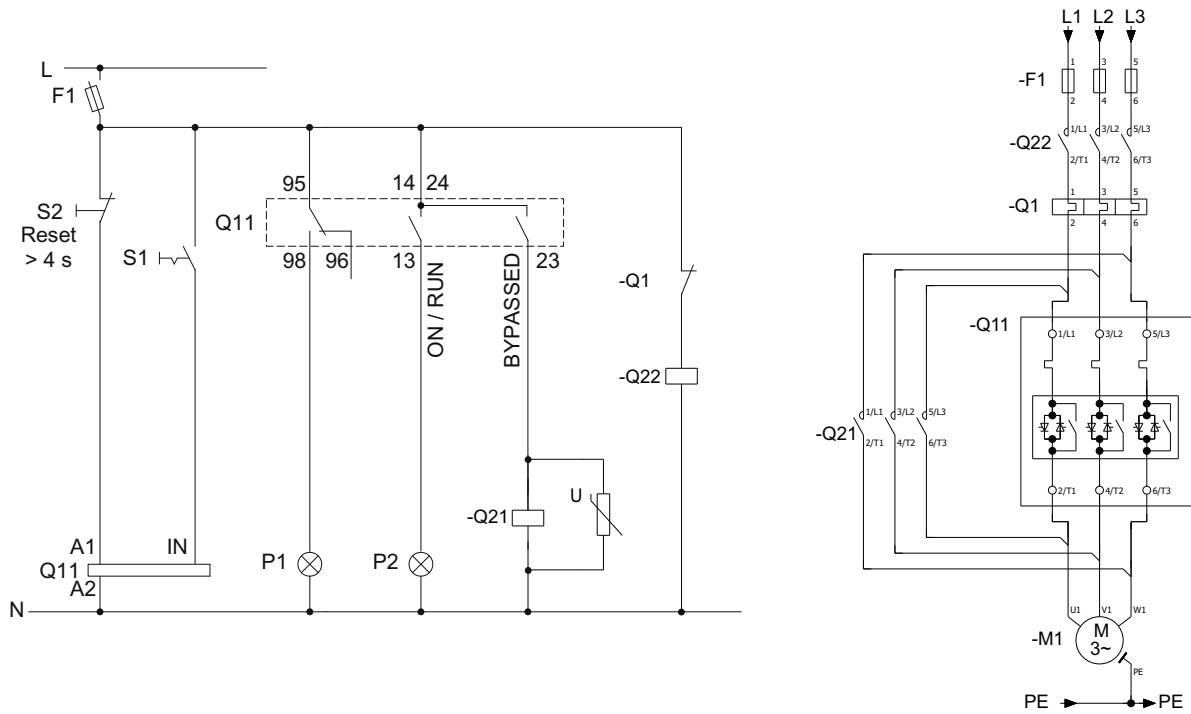

- F1 Fuse
- S1 Switch: Start/stop
- S2 Pushbutton: Reset > 4 s
- Q1 External overload relay
- Q11 3RW52 soft starter
- Q21 External bypass contactor
- Q22 Main contactor
- P1 Indicator light
- P2 Indicator light
- M1 Motor
- PE Protective conductor

Third-party software

B.1 Information about third-party software

Note to resellers: Please pass on this document to your customers to avoid license infringements.

Third-party software information

This product, solution or service ("Product") contains third-party software components listed in this document. These components are Open Source Software licensed under a license approved by the Open Source Initiative (<http://www.opensource.org>) or similar licenses as determined by SIEMENS ("OSS") and/or commercial or freeware software components. With respect to the OSS components, the applicable OSS license conditions prevail over any other terms and conditions covering the Product. The OSS portions of this Product are provided royalty-free and can be used at no charge.

If SIEMENS has combined or linked certain components of the Product with/to OSS components licensed under the GNU LGPL version 2 or later as per the definition of the applicable license, and if use of the corresponding object file is not unrestricted ("LGPL Licensed Module, whereas the LGPL Licensed Module and the components that the LGPL Licensed Module is combined with or linked to is the "Combined Product"), the following additional rights apply, if the relevant LGPL license criteria are met: (i) you are entitled to modify the Combined Product for your own use, including but not limited to the right to modify the Combined Product to relink modified versions of the LGPL Licensed Module, and (ii) you may reverse-engineer the Combined Product, but only to debug your modification. The modification right does not include the right to distribute such modifications and you shall maintain in confidence any information resulting from such reverse-engineering of a Combined Product.

Certain OSS licenses require SIEMENS to make source code available, for example, the GNU General Public License, the GNU Lesser General Public License and the Mozilla Public License. If such licenses are applicable and this Product is not shipped with the required source code, a copy of this source code can be obtained by anyone in receipt of this information during the period required by the applicable OSS licenses by contacting the following address.

SIEMENS may charge a handling fee of up to 5 Euro to fulfil the request.

Warranty regarding further use of the Open Source Software

SIEMENS' warranty obligations are set forth in your agreement with SIEMENS. SIEMENS does not provide any warranty or technical support for this Product or any OSS components contained in it if they are modified or used in any manner not specified by SIEMENS. The license conditions listed below may contain disclaimers that apply between you and the respective licensor. For the avoidance of doubt, SIEMENS does not make any warranty commitment on behalf of or binding upon any third-party licensor.

Open Source Software and/or other third-party software contained in this Product

If you like to receive a copy of the source code, please contact SIEMENS at the following address:

B.1 Information about third-party software

Siemens AG
LC TE SL
Werner-von-Siemens Str. 60
91052 Erlangen
Germany

Subject: Open Source Request (please specify Product name and version)

Please note the following license conditions and copyright notices applicable to Open Source Software and/or other components (or parts thereof):

Table with 4 columns: Component, Open Source Software [Yes/No], Acknowledgements/ Comments, License conditions and copyright notices. Row 1: TivaWare Peripheral Driver Library - 2.1.4, YES, (empty), LICENSE AND COPY-RIGHT INFORMATION FOR COMPONENT TIVA WARE PDL - 2.1.4

LICENSE CONDITIONS AND COPYRIGHT NOTICES

Open Source Software: TivaWare Peripheral Driver Library - 2.1.4
Enclosed you'll find license conditions and copyright notices applicable for Open Source Software TivaWare Peripheral Driver Library - 2.1.4

License conditions:

```
//
// Redistribution and use in source and binary forms, with or without
// modification, are permitted provided that the following conditions
// are met:
//
// Redistributions of source code must retain the above copyright
// notice, this list of conditions and the following disclaimer.
//
// Redistributions in binary form must reproduce the above copyright
// notice, this list of conditions and the following disclaimer in the
// documentation and/or other materials provided with the
// distribution.
//
// Neither the name of Texas Instruments Incorporated nor the names of
// its contributors may be used to endorse or promote products derived
// from this software without specific prior written permission.
//
// THIS SOFTWARE IS PROVIDED BY THE COPYRIGHT HOLDERS AND CONTRIBUTORS
// "AS IS" AND ANY EXPRESS OR IMPLIED WARRANTIES, INCLUDING, BUT NOT
// LIMITED TO, THE IMPLIED WARRANTIES OF MERCHANTABILITY AND FITNESS
// FOR
// A PARTICULAR PURPOSE ARE DISCLAIMED. IN NO EVENT SHALL THE
// COPYRIGHT
// OWNER OR CONTRIBUTORS BE LIABLE FOR ANY DIRECT, INDIRECT,
// INCIDENTAL,
// SPECIAL, EXEMPLARY, OR CONSEQUENTIAL DAMAGES (INCLUDING, BUT NOT
```

// LIMITED TO, PROCUREMENT OF SUBSTITUTE GOODS OR SERVICES; LOSS OF
USE,
// DATA, OR PROFITS; OR BUSINESS INTERRUPTION) HOWEVER CAUSED AND ON
ANY
// THEORY OF LIABILITY, WHETHER IN CONTRACT, STRICT LIABILITY, OR TORT
// (INCLUDING NEGLIGENCE OR OTHERWISE) ARISING IN ANY WAY OUT OF THE
USE
// OF THIS SOFTWARE, EVEN IF ADVISED OF THE POSSIBILITY OF SUCH
DAMAGE.

Copyrights:

Copyright © 2014-2017 Texas Instruments Incorporated
Copyright © 2015-2017 Texas Instruments Incorporated
Copyright © 2013-2017 Texas Instruments Incorporated
Copyright © 2012-2017 Texas Instruments Incorporated
Copyright © 2011-2017 Texas Instruments Incorporated
Copyright © 2010-2017 Texas Instruments Incorporated
Copyright © 2008-2017 Texas Instruments Incorporated
Copyright © 2007-2017 Texas Instruments Incorporated
Copyright © 2006-2017 Texas Instruments Incorporated
Copyright © 2005-2017 Texas Instruments Incorporated

.

Glossary

Auto RESET

"Auto RESET" means that faults are automatically reset as soon as the cause is eliminated.

Ground fault

Fault whereby an external conductor comes into contact with ground or the grounded neutral point.

GSD

Device master file

This file is required to be able to configure a device as a DP standard slave in the HW Config of a Siemens or external system.

GSDML

Device master file

This file is required to be able to configure a device as a DN device in the HW Config of a Siemens or external system.

HSP

Hardware support package

The hardware support packages allow you to configure modules that are not listed in the hardware catalog of your TIA Portal installation.

Manual RESET

"Manual RESET" means that the following options are available for acknowledging faults:

- RESET / TEST key on the 3RW52 soft starter
- RESET / TEST key on the 3RW5 HMI Standard
- Reset via bus interface
- Reset via F key on 3RW5 HMI High Feature
- Reset via 3RW5 HMI High Feature (Diagnosis state)

PII / PIQ

Process image input/process image output

Process image

Image of the signal states of the digital inputs and outputs in the memory of a controller.

The process images can be transferred as follows:

- Cyclically in the fieldbus protocol
- Acyclically using data sets

Remote RESET

"Remote RESET" means that faults are acknowledged by switching the power supply (control supply voltage) off and on again. The power supply (control supply voltage) on the 3RW52 soft starter must be switched off for at least 4 seconds.

STS

Simulation Tool for Soft Starters

The soft starter can be configured with the STS (Simulation Tool for Soft Starters) software. The STS suggests suitable soft starters for the application based on the motor and load data and application requirements that you enter.

Index

3

- 3RW5 HMI, 61
- 3RW5 HMI High Feature, 41
 - Communication diagnostics, 159
 - Control cabinet door, 54
 - Device design and controls, 90
 - Device LEDs, 147
 - Diagnostics of the soft starter, 155
 - Diagnostics on the 3RW5 HMI High Feature, 159
 - Disassembling, 50
 - Download languages, 141
 - Factory setting, 176
 - Faults and remedial actions, 154
 - Firmware update, 173
 - First commissioning, 106
 - Graphic display of measured values, 131
 - Installing, 49, 54
 - Level surface, 59
 - Logbooks, 164
 - Micro SD card, 139
 - Monitoring, 129, 132
 - Mounting, 59
 - Overview, 134
 - Parameter setting, 101
 - Save service data to micro SD card, 165
- 3RW5 HMI Standard, 40
 - Control cabinet door, 51
 - Device LEDs, 147
 - Disassembling, 48
 - Hardware configuration, 125
 - Installing, 47, 51
 - Level surface, 58
 - Menu, 126
 - Mounting, 58
- 3RW52 soft starter
 - Connect main circuit connection (line supply/motor), 67
 - Connecting, 66
 - Connecting the control terminals (screw terminals), 71
 - Connecting the control terminals (spring-loaded terminals), 72
 - Device LEDs, 144, 145
 - Disconnecting the control current from the screw terminals, 72
 - Disconnecting the control current from the spring-loaded terminals, 74

- First commissioning, 105
- Logbooks, 164
- Maintenance and repairs, 167
- Mounting, 43
- Mounting on a level surface, 45
- Mounting terminal covers, 68
- Mounting the cover of the control cable duct, 76
- Parameter setting, 82
- Removing the cover of the control cable duct, 77
- Replacement of the box terminal blocks with size 2, 69
- Replacing the control terminals, 74
- Sealing, 105
- Setting elements, 79

A

- Access protection, 105
- Accessories, 36
 - 3RW5 HMI High Feature, 41
 - 3RW5 HMI Standard, 40
- Actuation of a line contactor, 202
- Additional parameters, 119
- Analog output AQ
 - Parameter setting, 99
 - PLC, 101
- Applications, 32
- Auto RESET, 85

B

- Box terminal block
 - Replacing, 69

C

- Catalog, 12
- Circuit diagram example, 221, 224
 - Actuation of a line contactor, 202
 - Connecting the evaluation unit to the analog output, 205
 - Connecting the temperature sensor, 204
 - Contact for emergency start, 220
 - Control by PLC, 200
 - Control by pushbutton, 195
 - Control by switch, 196
 - Control of a motor with a magnetic parking brake, 208

- EMERGENCY STOP shutdown to SIL 1 or PL c with a 3SK1 safety relay, 209
- EMERGENCY STOP shutdown to SIL 3 or PL e with a 3SK1 safety relay, 214
- Feeder assembly, type of coordination 1 fuseless, 189
- Feeder assembly, type of coordination 1 with fuses, 190
- Feeder assembly, type of coordination 2, 191
- Reversing circuit, 206
- Switching with supply voltage (control supply voltage), 198
- Wiring for remote RESET, 204
- Communication modules, 37
- Connecting the evaluation unit to the analog output, 205
- Connecting the temperature sensor, 204
- Connections
 - Overview, 63
- Contactors for emergency start, 220
- Control by PLC, 200
- Control by pushbutton, 195
- Control by switch, 196
- Control of a motor with a magnetic parking brake, 208
- Control via digital input, 87, 123
- Current limiting, 111

D

- Device change, 179
 - Micro SD card, 179
 - SIRIUS Soft Starter ES (TIA Portal), 180
- Device versions, 30
- Device-related information, 134
- Diagnostics options, 143
- Disassembling
 - Cover for control cable duct, 77
- Download languages, 141

E

- Electronic motor overload protection, 115
- EMERGENCY STOP shutdown to SIL 1 or PL c with a 3SK1 safety relay, 209
- EMERGENCY STOP shutdown to SIL 3 or PL e with a 3SK1 safety relay, 214
- Errors and remedial actions, 149
- Example circuits
 - Inside-delta circuit, 192

F

- Factory setting, 174
 - 3RW5 HMI High Feature, 176
 - Master RESET key, 176
 - MODE and RESET / TEST keys, 177
 - Options, 175
 - Restore, 178
- Fan cover
 - Mounting, 43
- FAQs, 12
- Faults and remedial actions
 - 3RW5 HMI High Feature, 154
- Feeder assembly, type of coordination 1 fuseless, 189
- Feeder assembly, type of coordination 1 with fuses, 190
- Feeder assembly, type of coordination 2, 191
- Firmware update, 16, 172
- First commissioning, 105
- Function test, 160
- Functions, 21
 - Additional parameters, 119
 - Control via digital input, 123
 - Current limiting, 111
 - Soft starting, 109, 113
 - Thermistor motor protection with temperature sensor, 116

G

- Graphic display of measured values
 - Bar chart, 131
 - Line chart, 131

H

- Hardware configuration, 20
- Hinged cover
 - Cut, 61
 - Replacing, 62
- History, 19

I

- I&M data, 134
- Inside-delta circuit, 192
- Interaction interfaces, 23
- Intrinsic device protection, 117

K

Knowledge, 19

L

LED test, 160

LEDs

 Status and error displays, 145

LICENSE CONDITIONS AND COPYRIGHT NOTICES, 228

Local access protection (PIN), 136

 Change, 138

 Defining, 137

 Delete, 139

Logbooks, 164

M

Main circuit connection (line supply/motor)

 Connecting, 67

Main menu

 Monitoring, 132

Maintenance, 167

Manual RESET, 85

Manuals, 11

Master RESET key

 Factory setting, 176

Measured values

 Monitoring, 129

Messages and diagnosis

 Communication diagnostics, 159

 Diagnostics on the 3RW5 HMI High Feature, 159

 Faults and remedial actions of the 3RW5 HMI High

 Feature, 154

 Logbooks, 164

 Status and error displays, 145

Micro SD card, 139

Micro SD card, 173

Mode, 24

MODE and RESET / TEST keys

 Factory setting, 177

Monitoring

 Measured values, 129

 Process image, 132

Motor protection

 Full motor protection, 114

 Motor overload protection, 115

 Thermistor motor protection with temperature
 sensor, 116

Mounting, 43

 Cover for control cable duct, 76

Mounting on a level surface, 45

O

Online help, 11

Output 13, 14

 Parameter setting, 85, 87

Output signal ON or RUN, 85

Overview

 Device-related information, 134

P

Parameters

 Additional parameters, 119

 Control via digital input, 123

 Overview, 81

Process image

 Monitoring, 132

R

Reactive power compensation, 15

References, 11

Remote RESET, 85

Repairs, 167

RESET MODE, 83

Response to bus errors, 87, 123

Reversing circuit, 206

S

Save service data to micro SD card, 165

Screw terminals

 Connecting, 71

 Disconnect the control power supply, 72

Sealing, 105

Self-test (user-test), 160

Setting the mode, 26

Simulation Tool for Soft Starters, 33

SIRIUS Soft Starter ES (TIA Portal), 38

Soft starting, 109, 113

Soft torque, 83, 117

Spring-loaded terminals

 Connecting, 72

 Disconnect the control power supply, 74

STATE / OVERLOAD LED, 146

Status and error displays, 145

Status graphs, 65
Structure of the article number, 34
Suggested settings, 82
Switching with supply voltage (control supply voltage), 198

T

Target group, 19
Terminal cover, 68
Test
 Current acquisition, 160
 Motor overload protection, 160
Test with small load, 121
Thermistor motor protection with temperature sensor, 116
Third-party software information, 227

W

Warnings and remedial measures, 148
Wiring for remote RESET, 204