

SIEMENS

SIMATIC HMI

HMI devices Unified Comfort Panels

Operating Instructions



<u>Preface</u>	
<u>Overview</u>	1
<u>Safety instructions</u>	2
<u>Mounting and connecting the device</u>	3
<u>Operating the device</u>	4
<u>Operating the Control Panel</u>	5
<u>Transferring data</u>	6
<u>Device maintenance and repair</u>	7
<u>Technical information</u>	8
<u>Technical Support</u>	A
<u>Markings and symbols</u>	B
<u>Abbreviations</u>	C

Legal information

Warning notice system

This manual contains notices you have to observe in order to ensure your personal safety, as well as to prevent damage to property. The notices referring to your personal safety are highlighted in the manual by a safety alert symbol, notices referring only to property damage have no safety alert symbol. These notices shown below are graded according to the degree of danger.

DANGER

indicates that death or severe personal injury **will** result if proper precautions are not taken.

WARNING

indicates that death or severe personal injury **may** result if proper precautions are not taken.

CAUTION

indicates that minor personal injury can result if proper precautions are not taken.

NOTICE

indicates that property damage can result if proper precautions are not taken.

If more than one degree of danger is present, the warning notice representing the highest degree of danger will be used. A notice warning of injury to persons with a safety alert symbol may also include a warning relating to property damage.

Qualified Personnel

The product/system described in this documentation may be operated only by **personnel qualified** for the specific task in accordance with the relevant documentation, in particular its warning notices and safety instructions. Qualified personnel are those who, based on their training and experience, are capable of identifying risks and avoiding potential hazards when working with these products/systems.

Proper use of Siemens products

Note the following:

WARNING

Siemens products may only be used for the applications described in the catalog and in the relevant technical documentation. If products and components from other manufacturers are used, these must be recommended or approved by Siemens. Proper transport, storage, installation, assembly, commissioning, operation and maintenance are required to ensure that the products operate safely and without any problems. The permissible ambient conditions must be complied with. The information in the relevant documentation must be observed.

Trademarks

All names identified by ® are registered trademarks of Siemens AG. The remaining trademarks in this publication may be trademarks whose use by third parties for their own purposes could violate the rights of the owner.

Disclaimer of Liability

We have reviewed the contents of this publication to ensure consistency with the hardware and software described. Since variance cannot be precluded entirely, we cannot guarantee full consistency. However, the information in this publication is reviewed regularly and any necessary corrections are included in subsequent editions.

Preface

Purpose of the operating instructions

These operating instructions contain information based on the requirements for mechanical engineering documentation. This information relates to the location, transport, storage, mounting, use and maintenance.

These operating instructions are intended for:

- Users
- Commissioning engineers
- Maintenance personnel

Observe especially the information in the "Safety instructions" (Page 21) section.

You can find more information in the TIA Portal Information System.

Basic knowledge required

General knowledge of automation technology and process communication is needed to understand the operating instructions. Knowledge of personal computers and Microsoft operating systems is required.

Scope of the operating instructions

The operating instructions apply to the following HMI devices in conjunction with the SIMATIC WinCC Unified V18 software or higher:

Name	Type	Article number, device with Siemens logo	Article number, device without Siemens logo
MTP700 Unified Comfort	7" device	6AV2128-3GB06-0AX0	6AV2128-3GB36-0AX0
		6AV2128-3GB06-0AX1	6AV2128-3GB36-0AX1
MTP1000 Unified Comfort	10" device	6AV2128-3KB06-0AX0	6AV2128-3KB36-0AX0
		6AV2128-3KB06-0AX1	6AV2128-3KB36-0AX1
MTP1200 Unified Comfort	12" device	6AV2128-3MB06-0AX0	6AV2128-3MB36-0AX0
		6AV2128-3MB06-0AX1	6AV2128-3MB36-0AX1
MTP1500 Unified Comfort	15" device	6AV2128-3QB06-0AX0	6AV2128-3QB36-0AX0
		6AV2128-3QB06-0AX1	6AV2128-3QB36-0AX1
MTP1900 Unified Comfort	19" device	6AV2128-3UB06-0AX0	6AV2128-3UB36-0AX0
		6AV2128-3UB06-0AX1	6AV2128-3UB36-0AX1
MTP2200 Unified Comfort	22" device	6AV2128-3XB06-0AX0	6AV2128-3XB36-0AX0
		6AV2128-3XB06-0AX1	6AV2128-3XB36-0AX1

NOTICE
<p>Manual belongs to the HMI device</p> <p>This manual belongs to the HMI device and is also required for recommissioning. Store all supplied and supplementary documentation for the entire service life of the HMI device.</p> <p>Provide all stored documents to subsequent owners of the HMI device.</p>

Trademarks

The following designations marked with the symbol ® are registered trademarks of Siemens AG:

- HMI®
- SIMATIC®
- WinCC®

Style conventions

Text description	Example	Meaning
Text in quotation marks: "Text"	"Add screen"	<ul style="list-style-type: none"> • Terminology that appears in the user interface, for example dialog names, tabs, buttons, menu commands • Required inputs, for example, limits, tag values. • Path information
Text in quotation marks, separated by a 'greater than' symbol: "Text > Text"	"File > Edit"	Operating sequences, for example, menu commands, shortcut menu commands.
Texts in angle brackets: <Text>	<F1>, <Alt+P>	Keyboard operation
	<ip>, <date>, <time>	Tag values in URLs, path information, folder names, file names or in the user interface

Please observe notes labeled as follows:

Note

A note contains important information about the product described in the manual and its use, or a specific section of the manual to which you should pay particular attention.

Naming conventions

This document uses the following naming conventions.

Term	Applies to
Plant	<ul style="list-style-type: none"> • System • Machining center • One or more machines
Comfort HMI device, HMI device, Device	<ul style="list-style-type: none"> • MTP700 Unified Comfort • MTP1000 Unified Comfort • MTP1200 Unified Comfort • MTP1500 Unified Comfort • MTP1900 Unified Comfort • MTP2200 Unified Comfort
WinCC	SIMATIC WinCC Unified V18 or higher

Instead of the full product name, the short product name is also used without the suffix "Unified Comfort", for example:

"MTP700" representative for "MTP700 Unified Comfort"

Figures

This manual contains figures of the described devices. The figures can deviate from the delivered device in detail.

Picture components are marked with black position numbers on a white background:

①, ②, ③, ...

Steps in the figures are identified with white process numbers on a black background according to the sequence in which they have to be executed:

❶, ❷, ❸, ...

Table of contents

	Preface	3
1	Overview	11
1.1	Product description.....	11
1.2	Scope of delivery	13
1.3	Design of the devices.....	14
1.4	Interfaces	15
1.5	Accessories.....	16
1.6	The HMI device in the operating process	18
1.7	Apps and software options.....	19
2	Safety instructions	21
2.1	General safety instructions.....	21
2.2	Security management for HMI devices	23
2.3	Data protection.....	23
2.4	Notes about usage.....	24
2.5	Use in hazardous areas	26
3	Mounting and connecting the device	27
3.1	Preparing for installation.....	27
3.1.1	Checking the delivery.....	27
3.1.2	Checking the operating conditions	27
3.1.3	Permitted mounting positions	28
3.1.4	Checking clearances	30
3.1.5	Preparing the mounting cutout	31
3.2	Mounting the device.....	32
3.2.1	Notes on installation.....	32
3.2.2	Positions of the mounting clips	33
3.2.3	Fastening the built-in device with mounting clips.....	35
3.3	Installing a strain relief.....	36
3.4	Connecting the device	38
3.4.1	Notes on connection.....	38
3.4.2	Equipotential bonding	40
3.4.3	Connecting the power supply.....	42
3.4.4	Connecting the configuration PC.....	44
3.4.5	Connecting the controller	45
3.4.6	Connecting a USB device.....	47
3.4.7	Connecting a printer	49
3.4.8	Switching on, testing and switching off the device	50
3.4.9	Securing the cables.....	51
3.4.10	Securing cables for use in hazardous areas	53
3.5	Removing the device.....	54

- 4 Operating the device 55**
 - 4.1 Operator input options 55
 - 4.2 Important notes on touch screen 55
 - 4.3 Supported gestures..... 58
 - 4.3.1 Supported gestures in the Control Panel..... 58
 - 4.3.2 Supported gestures in the runtime project 58
 - 4.4 Using the screen keyboard 61
 - 4.4.1 The screen keyboards 61
 - 4.4.2 Control keys on the screen keyboard 64
 - 4.5 Using the taskbar 65
 - 4.6 Commissioning the HMI device 66
 - 4.7 Memory concept and memory cards 67
 - 4.7.1 Memory concept..... 67
 - 4.7.2 Changing the memory card..... 70
 - 4.8 Web access to the HMI device 71
 - 4.9 Notes on operation 76
- 5 Operating the Control Panel..... 77**
 - 5.1 Opening the settings 77
 - 5.2 Overview of functions..... 80
 - 5.3 System Properties 81
 - 5.3.1 Panel information 81
 - 5.3.2 Display 82
 - 5.3.3 Screensaver 83
 - 5.3.4 Update OS 84
 - 5.3.5 Reboot 86
 - 5.3.6 Performance..... 88
 - 5.3.7 Taskbar..... 89
 - 5.3.8 Event Logger 89
 - 5.4 Runtime Properties 91
 - 5.4.1 Project information 91
 - 5.4.2 Automatic runtime start..... 91
 - 5.4.3 Alarm buffer 92
 - 5.4.4 Web client 93
 - 5.4.5 Load project from storage..... 94
 - 5.5 Network and Internet..... 97
 - 5.5.1 Network settings 97
 - 5.5.1.1 Overview 97
 - 5.5.1.2 PN-X1 97
 - 5.5.1.3 PN-X2 99
 - 5.5.1.4 General 101
 - 5.5.2 Remote connection..... 101
 - 5.5.3 Network drive 103
 - 5.6 Security 107
 - 5.6.1 User management 107
 - 5.6.2 Certificates 115
 - 5.6.3 Control panel access 119
 - 5.6.4 UMAC settings 120

5.7	External Devices and Input.....	122
5.7.1	Hardware interfaces.....	122
5.8	Language, Region and Formats	123
5.8.1	Date and time	123
5.9	Service and Commissioning	125
5.9.1	Transfer	125
5.9.2	Update OS	126
5.9.3	Backup	128
5.9.4	Automatic backup.....	130
5.9.5	Restore	134
5.9.6	Trace forwarder	136
5.10	Apps.....	137
5.10.1	SIMATIC Apps	138
5.10.2	Add-ons.....	140
5.10.3	App Management.....	143
6	Transferring data	145
6.1	Overview	145
6.2	Operating modes.....	146
6.3	Using existing projects	147
6.4	Data transmission options.....	147
6.5	Setting the PG/PC interface	148
6.6	Transferring a project with WinCC	149
6.7	Backup and restore	152
6.8	Updating the operating system	155
6.8.1	Overview and important notes.....	155
6.8.2	Updating the operating system via WinCC	156
6.8.3	Resetting an HMI device to factory settings via ProSave	158
7	Device maintenance and repair.....	161
7.1	General information on maintenance and servicing.....	161
7.2	Clean the glass front of the HMI device.	161
7.3	Using the maintenance mode	162
7.4	Spare parts and repairs	164
7.5	Recycling and disposal	164
8	Technical information.....	165
8.1	Software license agreements	165
8.2	Labels, certificates and approvals	165
8.3	Electromagnetic compatibility.....	171
8.4	Mechanical ambient conditions.....	173
8.4.1	Storage conditions.....	173
8.4.2	Operating conditions	173
8.5	Climatic ambient conditions.....	173
8.5.1	Long-term storage	173
8.5.2	Transport and short-term storage.....	174
8.5.3	Operating conditions	174

8.5.4	Climate diagram	175
8.6	Information on insulation tests, protection class and degree of protection	175
8.7	Dimension drawings	176
8.7.1	Dimension drawings of the MTP700 Unified Comfort	176
8.7.2	Dimension drawings of the MTP1000 Unified Comfort	177
8.7.3	Dimension drawings of the MTP1200 Unified Comfort	178
8.7.4	Dimension drawings of the MTP1500 Unified Comfort	179
8.7.5	Dimension drawings of the MTP1900 Unified Comfort	180
8.7.6	Dimension drawings of the MTP2200 Unified Comfort	181
8.8	Technical specifications	182
8.8.1	MTP700, MTP1000, MTP1200 Unified Comfort.....	182
8.8.2	MTP1500, MTP1900, MTP2200 Unified Comfort.....	184
8.9	Description of the interfaces	186
8.9.1	DC24V X80.....	186
8.9.2	RS422/485 X20.....	186
8.9.3	PROFINET (LAN) X1	187
8.9.4	PROFINET (LAN) X2	187
8.9.5	USB X61/X62/X63/X64	188
8.10	Communication with controllers	188
8.11	Scope of functions with WinCC	190
A	Technical Support.....	193
A.1	Service and support	193
A.2	Troubleshooting	194
A.3	Application examples and FAQs	194
A.4	System alarms	195
A.5	Information about the manufacturer.....	195
B	Markings and symbols.....	197
B.1	Safety-relevant symbols.....	197
C	Abbreviations	199
	Glossary	201

Overview

1.1 Product description

SIMATIC HMI Unified Comfort Panels offer you all the freedom and options you need to implement your innovative operating concepts.

In addition to significantly increased performance, the user benefits from the new possibilities of the panels in conjunction with the SIMATIC WinCC Unified visualization software as well as the functional expandability with apps via the built-in Industrial Edge functionality.

The industrial-grade multi-touch glass front of all devices from 7 to 22" offers convenient operation with an impressive high-quality display.

The most important advantages at a glance:



- Maximum user-friendliness through better legibility as well as more brilliant colors and high contrast of the display, combined with significantly higher ruggedness of the multi-touch technology.
- Integrated functionality for all device sizes from 7 to 22".
- Increased hardware performance as well as higher system limits for significantly larger applications based on a panel-based system than before. High level of IT security to protect the system against hacker attacks through a proprietary operating system.
- Project-specific requirements can be implemented quickly and easily thanks to the integrated Industrial Edge functionality for simple expansion of standard functionality through apps.
- Visualization based on SIMATIC WinCC Unified, the new web-based visualization system in the TIA Portal for scalable solutions from machine-level applications to distributed SCADA solutions.
- All devices are available in standard design with Siemens logo and in neutral design without Siemens logo.

Features of the Unified Comfort Panels

Enclosure	Rugged aluminum die-cast housing
Mounting format	Mounting and operation in landscape and portrait format The respective format must be selected during the configuration of the user interface. The display orientation must also be changed in the Control Panel of the HMI device.
Interfaces	Two PROFINET interfaces that support PROFINET basic services: <ul style="list-style-type: none"> • One PROFINET interface X1 with two ports • One Gigabit PROFINET interface X2 with one port Four USB interfaces USB 3.1 Gen. 1 (Type A) One RS422/485 interface
Display	High-resolution TFT display in widescreen format with 16 million colors Wide viewing angle Dimmable from 10 to 100%.
Operation	Capacitive multi-touch screen
Software	Web browser for displaying Internet pages Viewer for PDF documents Editor for Word and Excel documents and other formats File manager Media Player Runtime software with logging and scripting functionality, system diagnostics for SIMATIC controllers, display of trends (f(x), f(t)), etc.
Data storage	Two slots for memory cards: <ul style="list-style-type: none"> • One "data memory card" slot for saving user data Recommendation: Use the SIMATIC SD memory card with 32 GB or more. • One "system memory card slot" for using the service concept for simplified recommissioning in the event of service. Project data and device settings are updated continuously on the system memory card. Use the SIMATIC SD memory card with 32 GB or more.
Controller	The system diagnostics of SIMATIC controllers can be read from the HMI device, which means that no additional programming device is required.

1.2 Scope of delivery

The scope of delivery of the HMI device includes the following components:

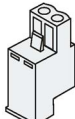
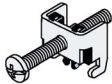
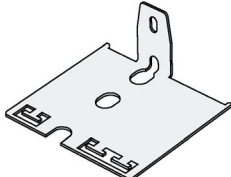
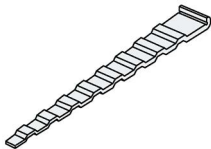
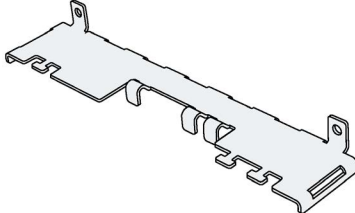
Name	Figure	Quantity	
HMI device		1	
Installation instructions (Quick Install Guide)		1	
Power supply connector		1	
Mounting clips steel, captive		8	MTP700
		12	MTP1000, MTP1200 MTP1500, MTP1900 MTP2200
Strain relief element	Strain relief 	1	MTP700 MTP1000 MTP1200
	Plastic strain relief element 	3	MTP700 MTP1000 MTP1200
	Strain relief 	1	MTP1500 MTP1900 MTP2200

1.3 Design of the devices

This section describes the design of the Unified Comfort Panels, using the MTP1900 Unified Comfort with Siemens logo as an example. The remaining Unified Comfort Panels differ in the size of the front, the interfaces are identical for all Unified Comfort Panels.

Front view and side view



- ① Display and capacitive multi-touch screen
- ② Recesses for mounting clips
- ③ Mounting seal

Bottom view

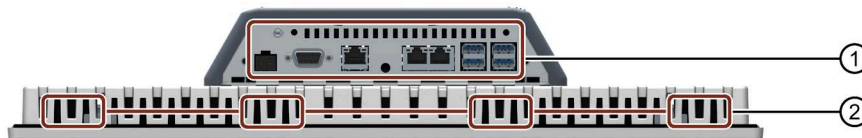

- ① Interfaces, detailed description (Page 15)
- ② Recesses for mounting clips

Rear view

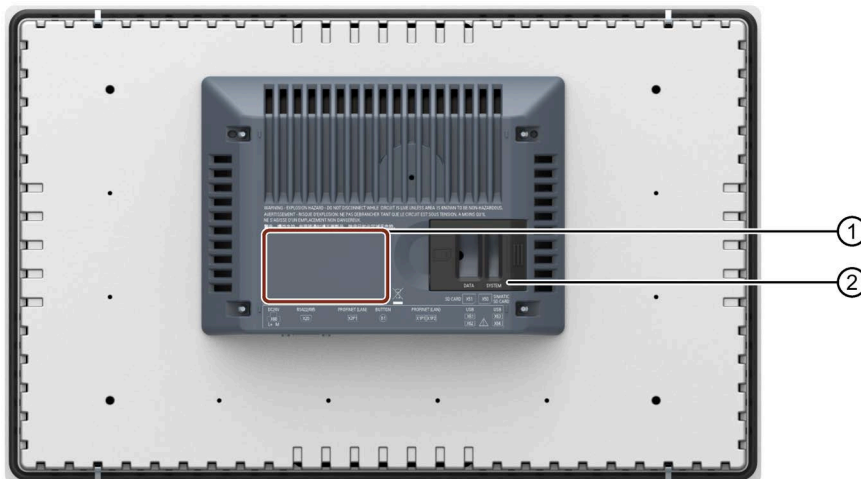

- ① Position of rating plate
 - ② Safety lock for the SD memory card slot cover
 - X51: Slot for the data memory card, left
 - X50: Slot for the system memory card, right
- For a detailed description, see section "Memory concept and memory cards (Page 67)"

1.4 Interfaces

The figure below shows the interfaces of the Unified Comfort Panels using the interface plate of the devices with display diagonal $\geq 15"$ as an example.

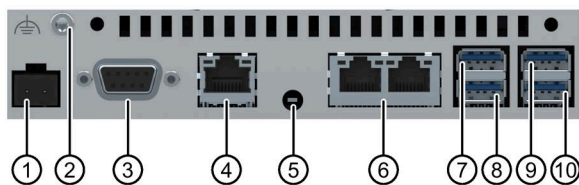

- | | |
|-------------------------------------|----------------------------------|
| ① X80 power supply connector | ⑥ X1 PROFINET (LAN), 10/100 Mbit |
| ② Connection for functional ground | ⑦ X61 USB |
| ③ X20 RS422/485 (SUB-D) | ⑧ X62 USB |
| ④ X2 PROFINET (LAN), 10/100/1000 Mb | ⑨ X63 USB |
| ⑤ B1 button "Maintenance" | ⑩ X64 USB |

For devices with display diagonal $\leq 12"$, there is another threaded hole above the "Maintenance" button for fixing the strain relief plate.

See also

Description of the interfaces (Page 186)

1.5 Accessories

An accessory kit with the necessary accessories is included with the HMI device.

Note

This section contains a selection of accessories that is suitable for your HMI device. You can find additional variants of this selection and the complete accessories portfolio in the Industry Mall on the Internet

(<https://mall.industry.siemens.com/mall/en/WW/Catalog/Products/10144445>). Details such as the delivery quantity and technical specifications of accessories can be found in the Industry Mall under the respective article numbers.

You can find an overview of the status and compatibility of the accessories portfolio in the "Cross-list" on the Internet (<https://support.industry.siemens.com/cs/ww/en/view/40466415>).

HMI I/O components

Name	Article number
Converter RS 422 to RS 232 for connecting third-party controllers	6AV6671-8XE00-....
90° bracket adapter for RS422/RS485 interface	6AV6671-8XD00-....
Plug for the power supply of the HMI device, 2-pin, screw technology	6AV6671-8XA00-....

"...." stands for the variant key of the article number.

Protective films

Name	Article number
7" front protective film for MTP700 Unified Comfort	6AV6881-0GJ22-....
10" front protective film for MTP1000 Unified Comfort	6AV6881-0KJ22-....
12" front protective film for MTP1200 Unified Comfort	6AV6881-0MJ22-....
15" front protective film for MTP1500 Unified Comfort	6AV6881-0QJ22-....
19" front protective film for MTP1900 Unified Comfort	6AV6881-0UJ22-....
22" front protective film for MTP2200 Unified Comfort	6AV6881-0VJ22-....

"...." stands for the variant key of the article number.

Storage media

Use only the following storage media for the HMI device.

Name	Article number
SIMATIC SD memory card	6AV6881-0AP40-....
SIMATIC HMI USB stick	6AV6881-0AS42-....

"...." stands for the variant key of the article number.

Observe the notes on using the memory media in the section "Memory concept (Page 67)".

Fasteners

Name	Article number
Set with steel mounting clips	6AV6881-6AD10-....
Memory card interlock	6AV2181-4XM00-....

"...." stands for the variant key of the article number.

Adapter frame

Name	Article number
Adapter frame widescreen 15"	6AV6881-6QD41-....
Adapter frame widescreen 19"	6AV6881-6UD41-....
Adapter frame widescreen 22"	6AV6881-6VD41-....

"...." stands for the variant key of the article number.

Input help

Name	Article number
Touch pen systems ELO and V2A	6AV6881-0AV2.-....

"...." stands for the variant key of the article number.

Readers

Name	Article number	
RFID reader SIMATIC RF1040R including USB connection cable	6GT2831-6CA50	
RFID reader SIMATIC RF1060R including USB connection cable	6GT2831-6AA50	
RFID reader SIMATIC RF1070R including USB connection cable	6GT2831-6BA50	
Mobile handheld reader ("barcode scanner")	SIMATIC MV320	6GF3320-OHT01
	SIMATIC MV340	6GF3340-OHT01

Additional USB accessories

Additional USB accessories can be found on the Internet in the following entry:
FAQ 19188460 (<https://support.industry.siemens.com/cs/ww/en/view/19188460>)

Other accessories

You can find additional accessories for SIMATIC HMI devices on the Internet at the following link:

Accessories (<https://mall.industry.siemens.com/mall/en/WW/Catalog/Products/10144445>)

1.6 The HMI device in the operating process

The HMI device is part a technical process. The following two phases are key to the way the HMI device is integrated in the process:

- Configuration
- Process management

Configuration

During the configuration phase, you create the user interfaces for operating and monitoring of the technical process on a configuration PC with WinCC. Project design comprises:

- Creating project data
- Saving project data
- Testing project data
- Simulating project data

Transfer

After compiling the configuration, you download the project to the HMI device.

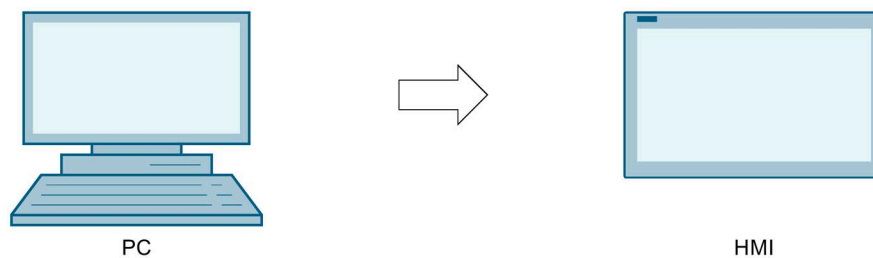

Process management

Process management is marked by two-way communication between HMI device and controller.

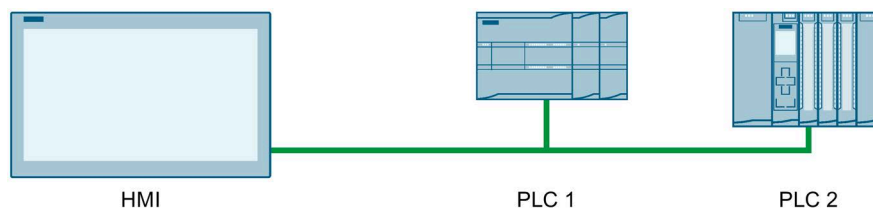

You then use the HMI device to operate and monitor the process.

1.7 Apps and software options

SIMATIC Apps

Under "SIMATIC Apps" you will find apps developed by Siemens especially for the HMI device.

SIMATIC app	Description
SIMATIC Edge	Via "SIMATIC Edge" you start the local edge management web page on the HMI device.

Add-ons

Under "Add-ons" you can find apps that were not developed by Siemens. The following apps are pre-installed license-free on the HMI device:

App	Description
Doc Viewer	With the "Doc Viewer" you can view and edit documents such as text or Word files.
E-Mail Client	With the "E-Mail Client" you can connect to your e-mail accounts, receive e-mails, send e-mails and import mail files from other applications.
File Browser	With the "File Browser" you can display and manage files on the HMI device.
Media Player	You can use the "Media Player" to play audio and video files.
PDF Viewer	You can use the "PDF Viewer" to view PDF documents.
Printer Configuration	You can display and manage pre-installed printers with the "Printer Configuration".
Web Browser	The "Web Browser" provides you with access to the Internet.

Additional information on "SIMATIC Apps", "Add-ons" and the "App Management" is available in the section "Apps (Page 137)".

Software options

In addition to the apps, software options are available for the HMI devices. Options usually have version-independent license keys. The available software options can be found on the Internet (<https://mall.industry.siemens.com/mall/en/en/Catalog/Products/10360581>).

Safety instructions

2.1 General safety instructions

The device is designed for operation in industrial areas for operating and monitoring of plant processes.

Observe the safety and accident prevention instructions applicable to your application in addition to the safety information given in the device documentation.

Open equipment

 WARNING
The device constitutes open equipment on the back side
The device constitutes open equipment on the back side. This means that you must integrate the device in an enclosure or cabinet where the device is operated via its front side. The enclosure or the cabinet must provide protection against electric shock and the spread of fire. The enclosure or the cabinet must meet the requirements for mechanical strength and the degree of protection for the relevant application.
Access to the enclosure or cabinet in which the device is installed should only be possible by means of a key or tool and only for qualified personnel.

 WARNING
Electrocution risk when control cabinet is open
When you open the control cabinet, there may be a dangerous voltage at certain areas or components.
Touching these areas or components can cause electrocution.
Disconnect the cabinet from the mains before opening it. Do not plug in or pull out plant components during operation.

Safety of the plant or the system

NOTICE
Safety is the responsibility of the assembler
The safety of any plant or system incorporating the equipment is the responsibility of the assembler of the plant or system.

2.1 General safety instructions

ESD



An electrostatically sensitive device is equipped with electronic components. Due to their design, electronic components are sensitive to overvoltage and thus to the discharge of static electricity. Observe the corresponding regulations when handling ESD.

Industrial Security

Siemens provides products and solutions with industrial security functions that support the secure operation of plants, systems, machines and networks.

In order to protect plants, systems, machines and networks against cyber threats, it is necessary to implement – and continuously maintain – a holistic, state-of-the-art industrial security concept. Siemens' products and solutions constitute one element of such a concept.

Customers are responsible for preventing unauthorized access to their plants, systems, machines and networks. Such systems, machines and components should only be connected to an enterprise network or the internet if and to the extent such a connection is necessary and only when appropriate security measures (e.g. firewalls and/or network segmentation) are in place.

For additional information on industrial security measures that may be implemented, please visit (<https://www.siemens.com/industrialsecurity>).

Siemens' products and solutions undergo continuous development to make them more secure. Siemens strongly recommends that product updates are applied as soon as they are available and that the latest product versions are used. Use of product versions that are no longer supported, and failure to apply latest updates may increase customer's exposure to cyber threats.

To stay informed about product updates, subscribe to the Siemens Industrial Security RSS Feed under (<https://www.siemens.com/cert>).

Disclaimer for third-party software updates

This product includes third-party software. Siemens AG only provides a warranty for updates/patches of the third-party software, if these have been distributed as part of a Siemens software update service contract or officially released by Siemens AG. Otherwise, updates/patches are undertaken at your own risk. You can find more information about our Software Update Service offer on the Internet at Software Update Service (<https://support.industry.siemens.com/cs/ww/en/view/109759444>).

Notes on protecting administrator accounts

A user with administrator privileges has extensive access and manipulation options in the system.

Therefore, ensure there are adequate safeguards for protecting the administrator accounts to prevent unauthorized changes. To do this, use secure passwords and a standard user account for normal operation. Other measures, such as the use of security policies, should be applied as needed.

2.2 Security management for HMI devices

Data security

Data from external sources

The HMI device has external interfaces and can be connected to the Internet. Edge management allows you to install apps from any source.

Data from untrusted sources represents a significant security risk.

Customers are responsible for transferring only data from trusted sources to the HMI device and only opening trusted files and web pages on the HMI device.

Entering passwords

If you enter passwords via an external keyboard, they can be logged and passed on unnoticed via a keylogger.

Use only the screen keyboard of the HMI device to input passwords.

Data backup to external data storage media

Data from the HMI device can be saved on USB or SD storage media via the external interfaces.

Customers are responsible for protecting HMI device data stored on external storage media against unauthorized access. For example, use a suitable encryption or password protection for external storage media. Store the external storage media in a safe place.

Additional information

You can find additional information on security management of HMI devices on the Internet at the following address:

Panel Security Guidelines (<https://support.industry.siemens.com/cs/de/en/view/109481300>)

2.3 Data protection

Siemens observes the data protection guidelines, especially the requirements regarding data minimization (privacy by design). This means the following for this SIMATIC product: The product does not process / save any personal information, but only technical functional data (e.g. time stamps). If the user links this data to other data (e.g. shift plans) or if the user saves personal information on the same medium (e.g. hard disk) and therefore creates a personal reference in the process, the user has to ensure meeting the guidelines regarding data protection.

2.4 Notes about usage

NOTICE
The HMI device is approved for indoor use only.
The HMI device may be damaged if it is operated outdoors.
Operate the HMI device indoors only.

Note

Operate the device only in a normal atmospheric environment

The technical characteristics of the device described in the operating instructions are guaranteed if you operate the device in normal ambient air conditions with usual air composition.

Note

The device is intended for operation in an SELV/PELV circuit according to IEC/EN 61131 or IEC/EN 61010-2-201 in a dry environment, which means a dry environment on the rear of the device.

Additional information is available in the section "Operating conditions (Page 174)".

Industrial applications

The HMI device is designed for industrial applications. It conforms to the following standards:

- Requirements for interference emissions EN IEC 61000-6-4:2019
- Requirements for interference immunity EN IEC 61000-6-2:2019

Use in mixed-use zone

Under certain circumstances you can use the HMI device in a mixed-use zone. A mixed-use zone is used for housing and commercial operations that do not have a significant impact on residents.

When you use the HMI device in a mixed-use zone, you must ensure that the limits of the generic standard EN 61000-6-3 regarding emission of radio frequency interference are observed. Suitable measures for achieving these limits for use in a mixed-use zone include:

- Installation of the HMI device in grounded control cabinets
- Use of filters in electrical supply lines

Individual acceptance is required.

Use in residential areas

Note

HMI device not intended for use in residential area

The HMI device is not intended for use in residential areas. Operation of an HMI device in residential areas can have a negative influence on radio or TV reception.

Use with additional measures

The HMI device should not be used at the following locations unless additional measures are taken:

- In locations with a high degree of ionizing radiation
- In locations with severe operating conditions, for example, due to:
 - Corrosive vapors, gases, oils or chemicals
 - Strong electrical or magnetic fields of high intensity
- At locations that require special monitoring, e.g. in:
 - Elevators
 - Highly hazardous areas

TFT displays

NOTICE
Burn-in effect
A permanently displayed two-color or multi-color picture can cause a burn-in effect, i.e. the picture remains dimly visible for a certain period of time. The longer the image is burned in, the longer the image will last. In extreme cases, the image is permanently displayed.
The image outline usually disappears on its own when the screen remains switched off for some time. Screensavers that use active black when the backlight is on reduce the burn-in effect.

Note

Backlight

The brightness of the backlight decreases incrementally during operational life. You can extend the service life of the display and backlight by taking the following measures:

- Reduce the backlight (Page 82).
 - Observe the operating hours of the backlight, see section "Technical specifications (Page 182)".
-

2.5 Use in hazardous areas

The following warnings apply to operating a device with Ex approval in hazardous areas.

 WARNING
Do not plug or pull connectors in potentially explosive atmospheres When you plug or pull the plug-in connector during operation, there is a risk of a flashover. A flashover can cause an explosion in a hazardous area, resulting in death or severe injuries. Plugging or pulling of plug-in connectors, for example, of a 24 V DC power supply connector or even of a memory card, is prohibited in a hazardous area. Do not plug or pull a connector or a memory card until one of the two following requirements is met: The area is no longer hazardous or the device and its plug-in connections are de-energized. To shut down the device, close all open apps and the running project, and turn off the power to the device.

Note for using the HMI device within the scope of UL approval:

 WARNING
Explosion Hazard Do not disconnect while circuit is live unless area is known to be non-hazardous. Substitution of components may impair suitability for Class I, Division 2 or Zone 2. Risque d'Explosion Ne pas déconnecter pendant que le circuit est sous tension, sauf si la zone est non-dangereuse. Le remplacement de composants peut compromettre leur capacité à satisfaire à la Classe I, Division 2 ou Zone 2.

Also observe the enclosed documentation on using in potentially explosive areas and the information on the Ex approval in section "Labels, certificates and approvals (Page 165)".

Mounting and connecting the device

3.1 Preparing for installation

3.1.1 Checking the delivery

Check the package content for visible signs of transport damage and for completeness.

Note**Damaged parts**

A damaged part will cause the HMI device to malfunction.

Do not install parts damaged during shipment. In the case of damaged parts, contact your Siemens representative.

Check the scope of delivery of the HMI device, see section "Scope of delivery (Page 13)".

Additional documents may be included in the scope of delivery.

The documentation is part of the HMI device and is required for subsequent commissioning. Keep all enclosed documentation for the entire service life of the HMI device. You must pass along the enclosed documentation to any subsequent owner or user of the HMI device. Make sure that every supplement to the documentation that you receive is stored together with the operating instructions.

3.1.2 Checking the operating conditions

Observe the following aspects before installing the HMI device:

1. Familiarize yourself with the standards, approvals, EMC parameters and technical specifications for operation of the HMI device. This information is available in the following sections:
 - "Labels, certificates and approvals (Page 165)"
 - "Electromagnetic compatibility (Page 171)"
2. Check the mechanical and climatic ambient conditions for operation of the HMI device according to the following sections:
 - " Mechanical ambient conditions (Page 173)"
 - " Climatic ambient conditions (Page 173)"
3. Observe the notes on the local use of the HMI device in section "Notes about usage (Page 24)".
4. Observe the permissible rated current: +24 V DC

3.1 Preparing for installation

3.1.3 Permitted mounting positions

The HMI device is suitable for installation in:

- Mounting cabinets
- Control cabinets
- Switchboards
- Consoles

In the following, all of these mounting options are referred to by the general term "cabinet".

The device is self-ventilated and approved for inclined mounting at angles up to $\pm 35^\circ$ from the vertical.

NOTICE
Damage due to overheating
An inclined installation reduces the convection by the HMI device and therefore the maximum permitted ambient temperature for operation.
If there is sufficient convection from forced ventilation, the HMI device can also be operated in the inclined mounting position up to the maximum permitted ambient temperature for vertical mounting. The HMI device may otherwise be damaged and its certifications and warranty will be void.
The working temperature ranges listed in this section apply to the rear and the front of the HMI device.

For detailed information regarding the permitted ambient temperatures, refer to section "Climatic ambient conditions (Page 173)".

Mounting position

Select one of the permitted mounting positions for your HMI device. The approved mounting positions are described in the following sections using the MTP1900 Unified Comfort HMI device as an example.

Mounting in landscape format

All Unified Comfort HMI devices are suitable for installation in landscape format.

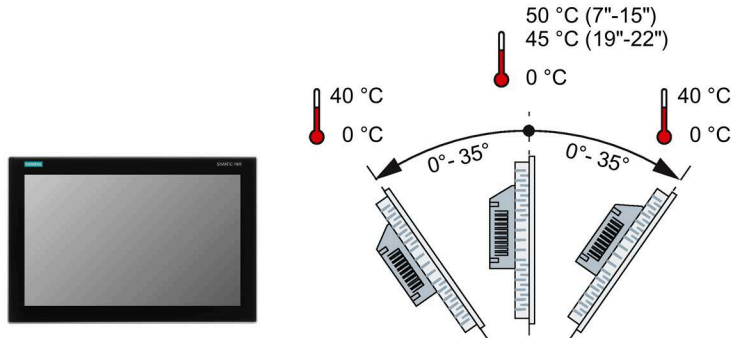

Mounting in portrait format

All Unified Comfort HMI devices are suitable for installation in portrait format. Select the appropriate screen format during configuration.

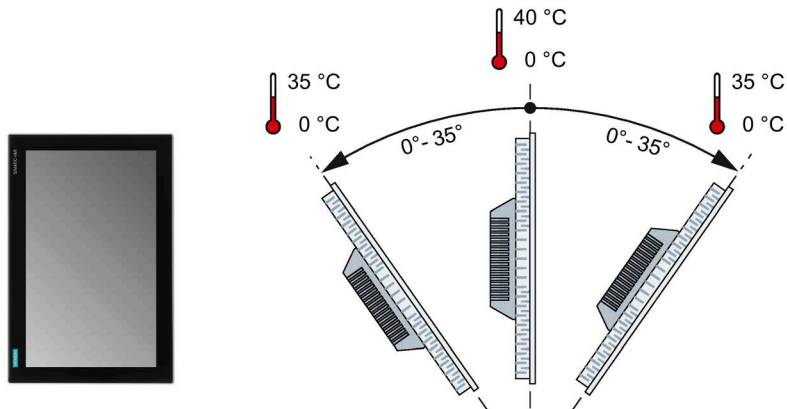

See also

Climate diagram (Page 175)

3.1.4 Checking clearances

The following clearances are required around the HMI device to ensure sufficient self-ventilation:

- At least 15 mm to both the right and left of the mounting cutout (in x direction) to allow for insertion of the mounting clips during installation
- At least 50 mm above and 50 mm below the mounting cutout (in the y direction) for ventilation
- At least 10 mm behind the rear panel of the HMI device (in the z direction)

The following figure shows the clearances for mounting the HMI devices in landscape format and portrait format using MTP1900 Unified Comfort as an example:

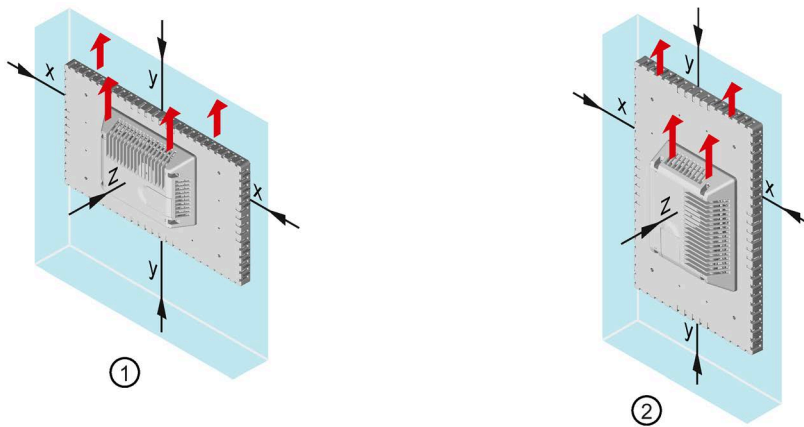

- ① Clearance for mounting in landscape format
- ② Clearance for mounting in portrait format
- x At least 15 mm distance
- y At least 50 mm distance
- z At least 10 mm distance

Note

Ensure that the maximum ambient temperature is not exceeded when mounting the device in a cabinet and especially in a closed enclosure.

3.1.5 Preparing the mounting cutout

Note

Stability of the mounting cutout

The material in the area of the mounting cutout must provide sufficient strength to guarantee lasting and safe mounting of the HMI device.

To achieve the degrees of protection described below, it must be ensured that deformation of the material cannot occur due to the force of the mounting clips or operation of the device.

Degrees of protection and installation area

The degrees of protection of the HMI device can only be guaranteed if the following requirements are met:

- Material thickness at the mounting cutout for a degree of protection IP65 or Front face only Type 4X/Type 12 (indoor use only): 2 mm to 6 mm
- Permissible deviation from plane at the mounting cutout: ≤ 0.5 mm
This condition must also be fulfilled for the mounted HMI device.
- Permissible surface roughness in the area of the seal: ≤ 120 μm ($R_z 120$)
- The installation area is dry and free from contamination, such as dust or lubricant.

Compatibility of the mounting cutout to other HMI devices

The Unified Comfort HMI devices are mounting-compatible with standard SIMATIC Industrial PCs, Industrial Flat Panels and Industrial Thin Clients with identical display diagonals.

Please note that although the dimensions for the mounting cutout are the same, the device depth of the Unified Comfort HMI devices may differ from that of compatible devices.

In addition, the following installation compatibility with the predecessor devices applies:

HMI device	Mounting cutout compatible with
MTP700 Unified Comfort	TP700 Comfort
MTP1200 Unified Comfort	TP1200 Comfort

For Unified Comfort HMI devices with display diagonal ≥ 15 ", adapter frames are available for mounting in the mounting cutout of a Comfort HMI device with the corresponding display diagonal, see section "Accessories (Page 16)".

Dimensions of the mounting cutout

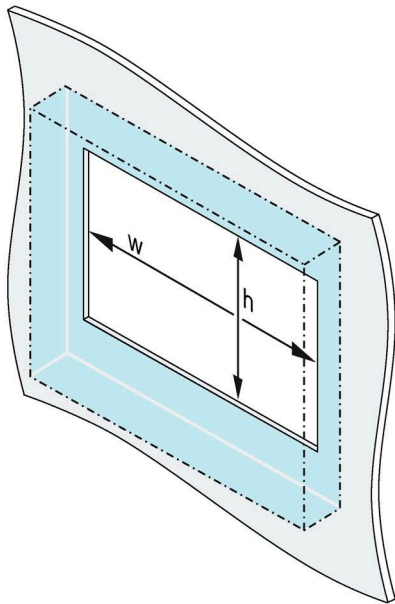

	w_0^{+1}	x	h_0^{+1}
MTP700	197	x	141 mm
MTP1000	264	x	189 mm
MTP1200	310	x	221 mm
MTP1500	382	x	241 mm
MTP1900	448	x	278 mm
MTP2200	513	x	315 mm

Width and height should be reversed accordingly when mounting in portrait format.

3.2 Mounting the device

3.2.1 Notes on installation

Before installing the device, please ensure that the installation location complies with the following:

NOTICE

Use according to IEC 61010-2-201 requires an appropriate enclosure

The rear of the built-in device is classified as "Open Equipment" according to IEC 61010-2-201 for use in industrial control equipment.

For approval and operation according to IEC 61010-2-201, the device must be installed in an enclosure or integrated in a cabinet. The enclosure or the cabinet must provide protection against electric shock and the spread of fire. The enclosure or the cabinet must meet the requirements for mechanical strength and the degree of protection for the relevant application.

- Position the device so that it is not exposed to direct sunlight.
- Position the device so that it is easily accessible for the operator. Choose a suitable installation height.
- Ensure that the air vents of the device are not covered as a result of installation.
- Observe the permitted mounting positions (Page 28).

3.2.2 Positions of the mounting clips

You fasten the built-in devices with the mounting clips from the accessory pack, which are also available as accessories (Page 16).

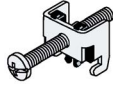

For the 7" device MTP700 Unified Comfort you need 7 mounting clips, for all other devices 12 mounting clips.

To achieve degree of protection IP65 for the respective device, the mounting clips must be installed at the positions shown below.

Device	Positions of the mounting clips
7" device	
10" device	
12" device	

3.2 Mounting the device

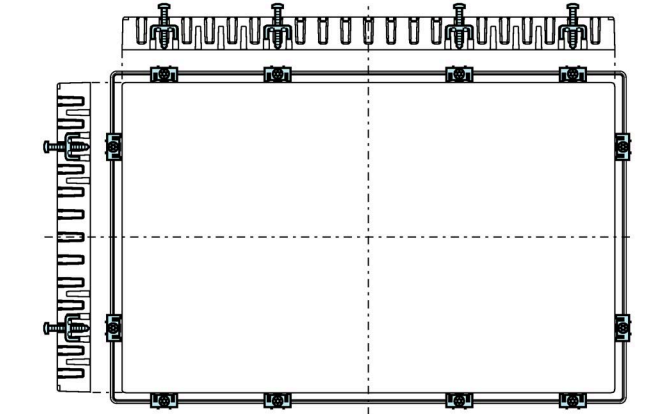
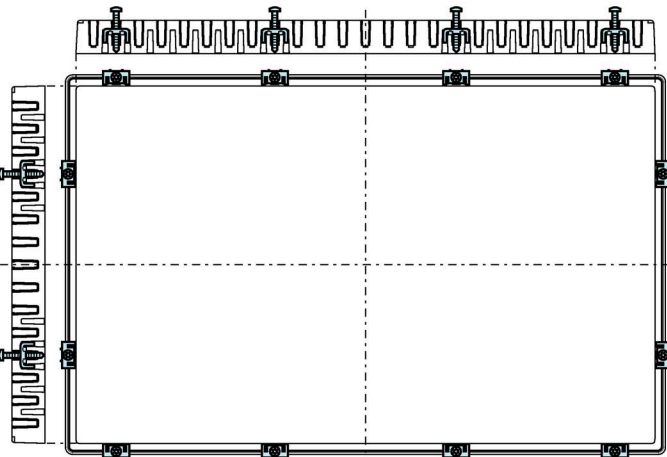
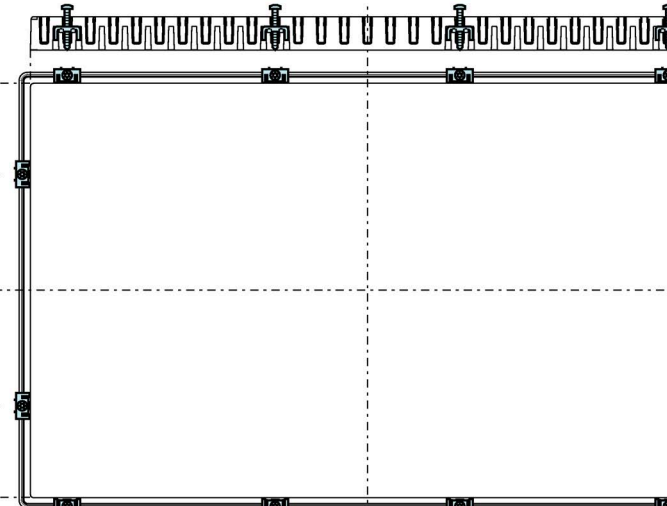
Device	Positions of the mounting clips
15" devices	
19" devices	
22" devices	

3.2.3 Fastening the built-in device with mounting clips

Requirement

- All packaging components and protective films have been removed from the device.
- The following material and tools are available:
 - The mounting clips from the accessory kit
 - One torque screwdriver with cross-tip insert, size 2

Procedure

Note

If the mounting seal is damaged, the degree of protection is not guaranteed.

1. Insert the device into the mounting cutout from the front.

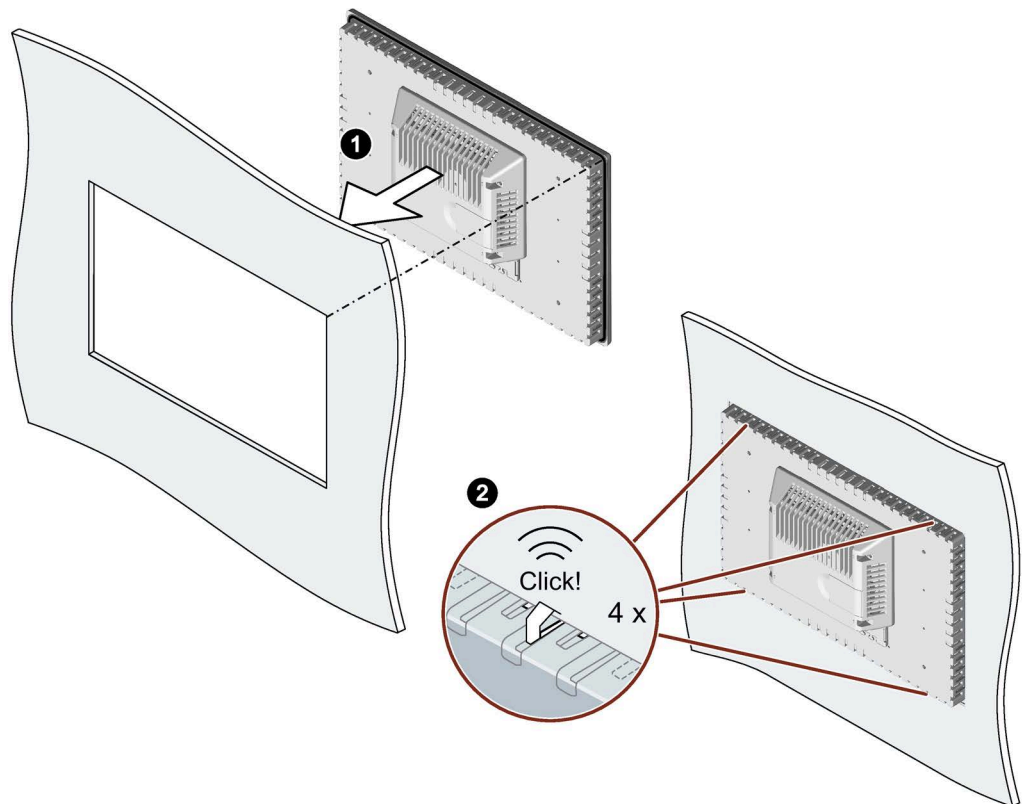

2. Make sure that all four spring locks on the top and bottom of the device fully engage. If necessary, gently press the device into the recess if it is not fully engaged.

3.3 Installing a strain relief

3. Insert a mounting clip into the cutout provided on the device. Make sure it is in the correct position; see the section "Positions of the mounting clips (Page 33)".

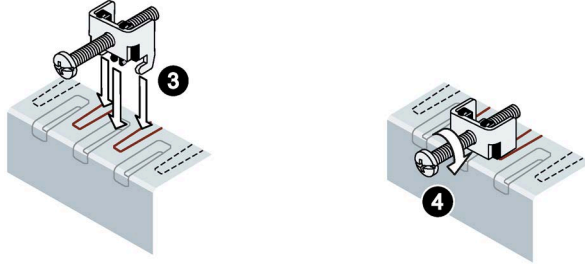

4. To secure the mounting clip, tighten the grub screw with the screwdriver, torque 0.5 Nm.
5. Repeat step 3 and 4 for all mounting clamps until all clamps are fastened.
6. Check the fit of the mounting seal.

3.3 Installing a strain relief

The device's scope of delivery includes a strain relief plate with the required number of fixing screws.

Note

If the strain relief plate of devices with display diagonal ≤ 12 " is mounted, then the strain relief plate projects beyond the outer dimensions of the device. Screw on the strain relief plate of the devices with display diagonal ≤ 12 " only after the device has been installed.

The strain relief plate of the devices with display diagonal ≥ 15 " can be screwed on before or after the device has been installed.

Requirement

For mounting of the strain relief plate you need:

- The strain relief plate from the scope of delivery
- The supplied fixing screws
- A torque screwdriver with T20 insert

HMI devices with display diagonal $\leq 12"$

Fasten the strain relief plate to the device with a torque of 0.8 Nm using the two screws supplied.

The figure below shows the installation using the MTP700 Unified Comfort HMI device as an example.

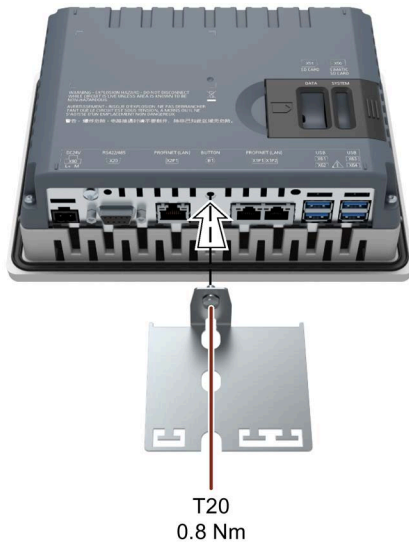

HMI devices with display diagonal $\geq 15"$

Fasten the strain relief plate to the device with a torque of 0.8 Nm using the two screws supplied.

The figure below shows the installation using the MTP1900 Unified Comfort HMI device as an example.

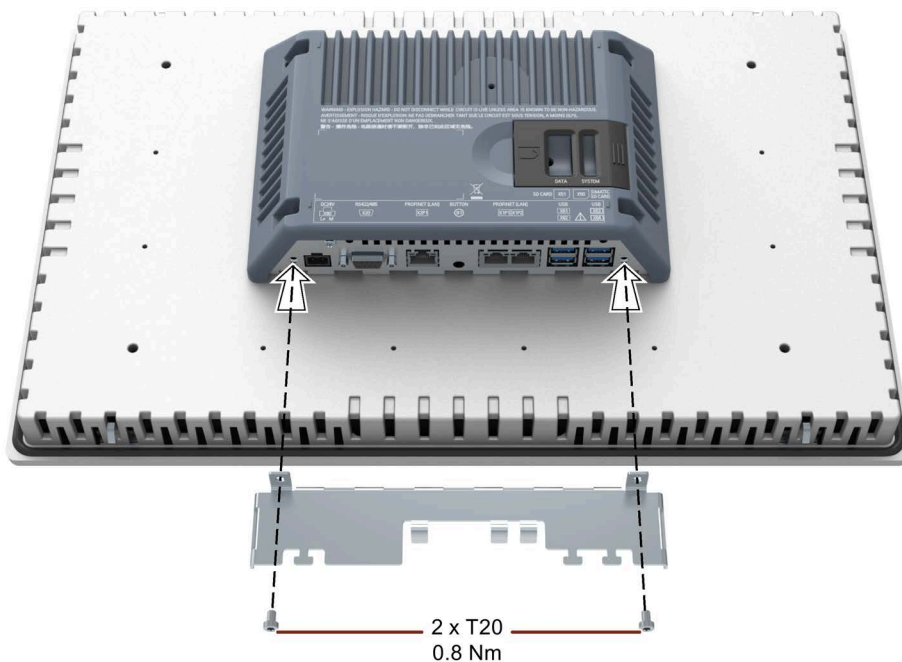

3.4 Connecting the device

3.4.1 Notes on connection

Requirement

- The HMI device must be mounted according to the specifications of these operating instructions.

Connecting cables

Use only shielded standard cables as data connecting cables, order information is available on the Internet (<https://mall.industry.siemens.com>).

Note

Separate SELV/PELV circuits from other electric circuits or insulate the cables

The wiring of SELV/PELV circuits must either be separated from the wiring of other non-SELV/PELV electric circuits, or the insulation of all conductors must be rated for the higher voltage. Alternatively, a grounded shielding or additional insulation must be installed around the wiring for SELV/PELV circuits or the other electric circuits, based on IEC 60364-4-41.

Note for using the HMI device within the scope of UL approval:

Note

Use copper cables at connectors with terminal connections

Use copper (Cu) cables for all supply lines that are connected to the device with terminals, e.g. 24 V DC power supply cables to the 24 V DC power supply connectors.

Utiliser des câbles en cuivre sur les connexions à bornes

Utilisez des câbles en cuivre (Cu) pour tous les câbles d'alimentation qui sont raccordés à l'appareil par des bornes, par exemple les câbles d'alimentation 24 V CC sur le connecteur d'alimentation 24 V CC.

Connection sequence

NOTICE

Damage to the HMI device

If you do not keep to the connection sequence you could damage the HMI device.
--

It is crucial that you connect the HMI device in the following order:

1. Equipotential bonding
2. Power supply
Perform a power-up test to ensure the power supply is connected with the correct polarity.
3. Controller
4. Configuration PC if needed
5. I/Os if needed

Disconnect the HMI device by completing the above steps in reverse order.

Connecting the cables

NOTICE

Observe local installation regulations

Observe the local installation regulations and the local installation conditions, such as protective wiring for power supply lines, when connecting the cables.

NOTICE

Thermal stability and insulation of the cables

Use cables with a maximum permissible operating temperature that is at least 20 °C higher than the maximum ambient temperature.

The insulation of the cables must be suitable for the operating voltage.
--

NOTICE

Short-circuit and overload protection
--

Different measures for short-circuit and overload protection are required when setting up an entire plant. The type of components and the level of obligation for the protective measures depends on the regulation that applies to your plant configuration.

- When connecting the cables, make sure that you do not bend the contact pins.
- Secure the cable connectors by fastening the connector to the socket with screws.
- Provide adequate strain relief for all connecting cables.
- The pin assignment of the ports is described in the technical specifications.

3.4.2 Equipotential bonding

Differences in electrical potential

Differences in electrical potential can develop between spatially separate plant components. Such electrical potential differences can lead to high equalizing currents across the data cables and therefore to the destruction of their interfaces. Equalizing currents can develop if the cable shielding is terminated at both ends and grounded to different plant components.

Differences in potential may develop when a system is connected to different mains supplies.

General requirements for equipotential bonding

Differences in potential must be reduced by means of equipotential bonding in order to ensure trouble-free operation of the relevant components of the electronic system. The following must therefore be observed when installing the equipotential bonding circuit:

- The effectiveness of equipotential bonding increases as the impedance of the equipotential bonding conductor decreases or as its cross-section increases.
- If two plant components are interconnected by means of shielded data cables and their shielding is bonded at both ends to the grounding/protective conductor, the impedance of the additionally installed equipotential bonding cable must not exceed 10% of the shielding impedance.
- The cross-section of an equipotential bonding conductor must be capable of handling the maximum equalizing current. Equipotential-bonding cables are required between two control cabinets with a minimum conductor cross-section of 16 mm².
- Use equipotential bonding conductors made of copper or galvanized steel. Establish a large surface contact between the equipotential bonding conductors and the grounding/protective conductor and protect them from corrosion.
- Clamp the shield of the data cable from the HMI device flush at the equipotential bonding rail using suitable cable clamps. The equipotential bonding rail should be as close to the HMI device as possible.
- Route the equipotential bonding conductor and data cables in parallel and with minimum clearance in between.

Note

Equipotential bonding cable

Cable shields are not suitable for equipotential bonding. Always use the prescribed equipotential bonding conductors for this. An equipotential bonding conductor between control cabinets must have a minimum cross-section of 16 mm². The cable between the ground bar and HMI device must have a minimum cross-section of 4 mm².

Wiring diagram

The following figure shows the connection of the functional ground for equipotential bonding with MTP1900 Unified Comfort as an example and similarly applies to the other Unified Comfort HMI devices.

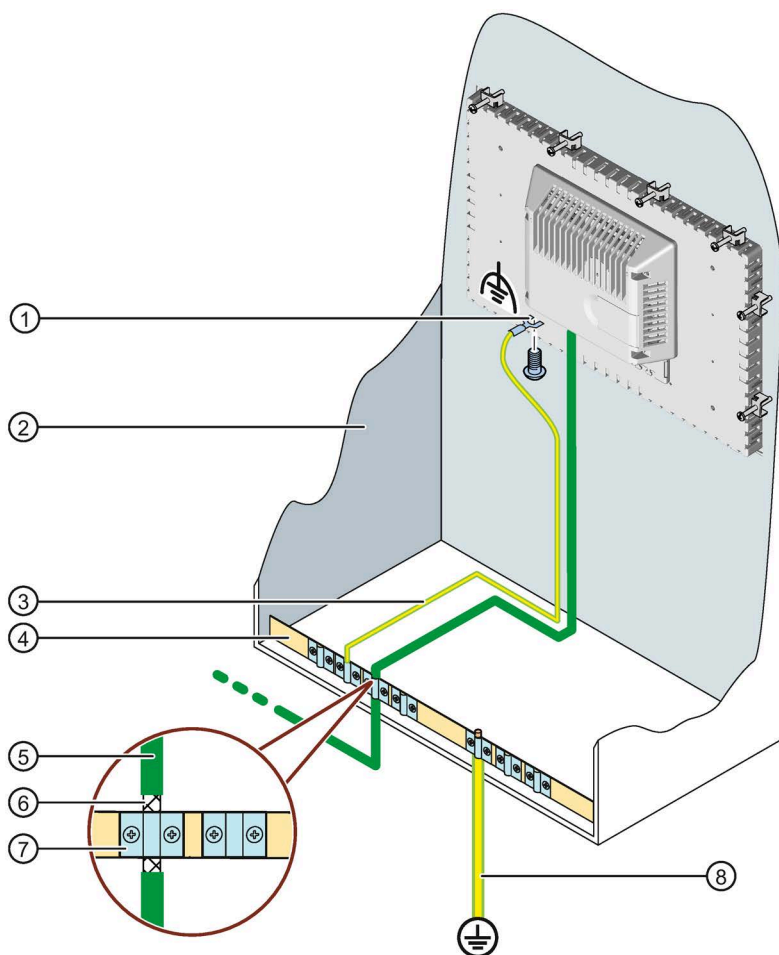

- ① Connection for functional ground
- ② Control cabinet
- ③ Equipotential bonding cable, 4 mm²
- ④ Equipotential busbar for equipotential bonding cables, grounding connection and shield support of the data cables
- ⑤ PROFINET data cable
- ⑥ Shield of the PROFINET data cable, connected to the equipotential busbar
- ⑦ Cable clip
- ⑧ Ground bar, 16 mm²

3.4.3 Connecting the power supply

NOTICE

Safe electrical isolation

For the 24 V DC supply, only use power supply units with safe electrical isolation (SELV/PELV) in line with IEC 61010-2-201.

The supply voltage must be within the specified voltage range. Otherwise, malfunctions at the HMI device cannot be ruled out.

The following applies for a non-isolated system design: Connect the GND 24 V connection from the 24 V power supply output to equipotential bonding for uniform reference potential. You should always select a central point of termination.

Wiring diagram

The following figure shows the connection between the power supply and the HMI device with the Unified Comfort Panel with display diagonal $\geq 15"$ as an example.

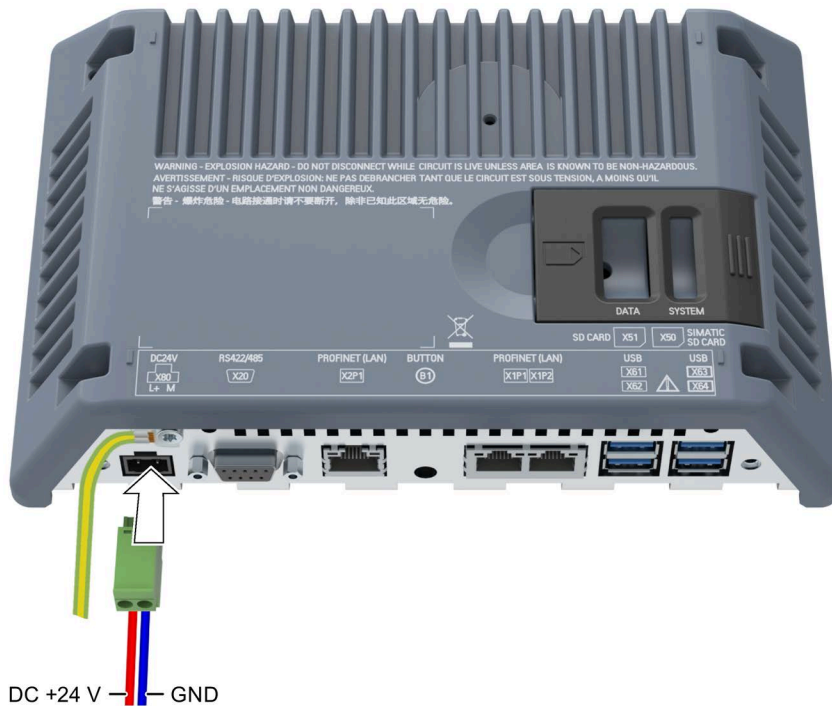

Note when connecting

The power supply connector is contained in the accessory kit. The power supply connector is designed for cables with a maximum cross-section of 1.5 mm². Torque for the screws: 0.5 to 0.6 Nm.

Connecting the power supply connector

NOTICE**Do not damage the socket**

Do not tighten the screws of the power supply connector when it is plugged into the HMI device. The pressure from the screwdriver could damage the HMI device socket.

Connect the power supply cables when the power supply connector is unplugged from the HMI device.

1. Switch off the power supply.
2. Connect the power supply cables to the power supply connector as shown in the above figure, torque 0.5 to 0.6 Nm.
3. Connect the power supply connector to the corresponding socket of the HMI device as shown in the above figure. Check the correct polarity of the cables using the interface marking on the back of the HMI device.

Reverse polarity protection

The HMI device comes with electronic reverse polarity protection which prevents the device from being damaged in case the power supply cables are connected incorrectly.

3.4.4 Connecting the configuration PC

Wiring diagram

The following figure shows how to connect the HMI device to a configuration PC with a Unified Comfort Panel with display diagonal $\geq 15"$ as an example.

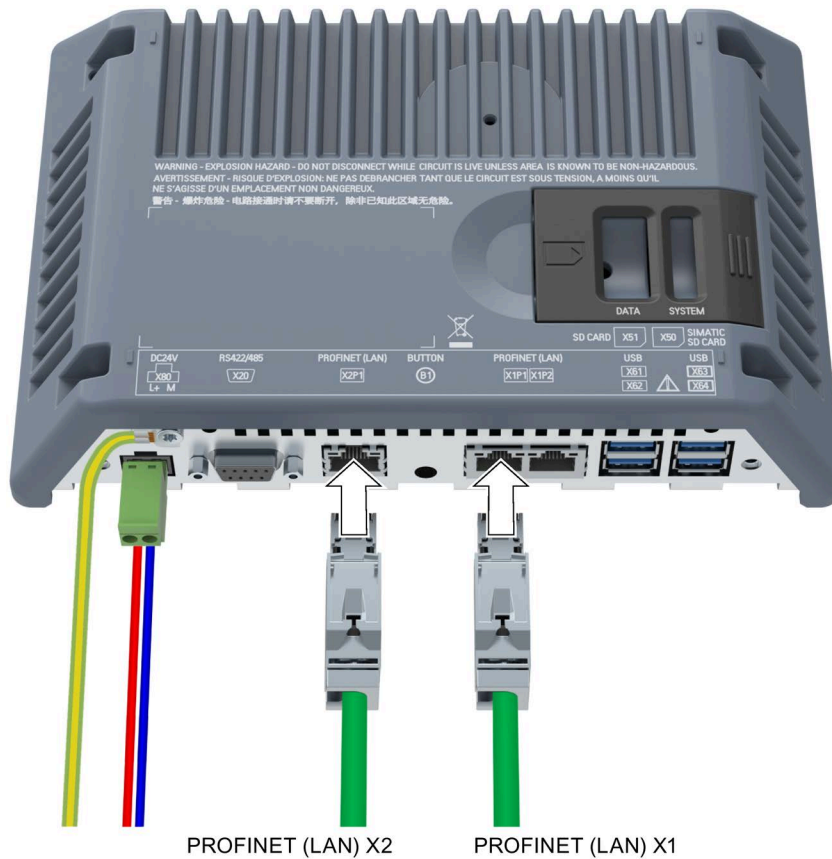

Procedure

Proceed as follows:

1. Switch off the HMI device.
2. Switch on the configuration PC.
3. Connect the HMI device to the configuration PC via the X1 or X2 interface.

Note

The technology on which the X2 is based allows a higher data transfer rate than the X1 interface.

4. Switch on the HMI device.

Result

The configuration PC and HMI device are connected. In the connection, assign an IP address to the HMI device.

Note

Updating the operating system

If there is no serviceable HMI device image on the HMI device, you can only update the operating system by restoring the factory settings via one of the two PROFINET (LAN) interfaces.

3.4.5 Connecting the controller

Wiring diagram

The following figure shows how to connect the HMI device to a controller with a Unified Comfort Panel with display diagonal $\geq 15"$ as an example.

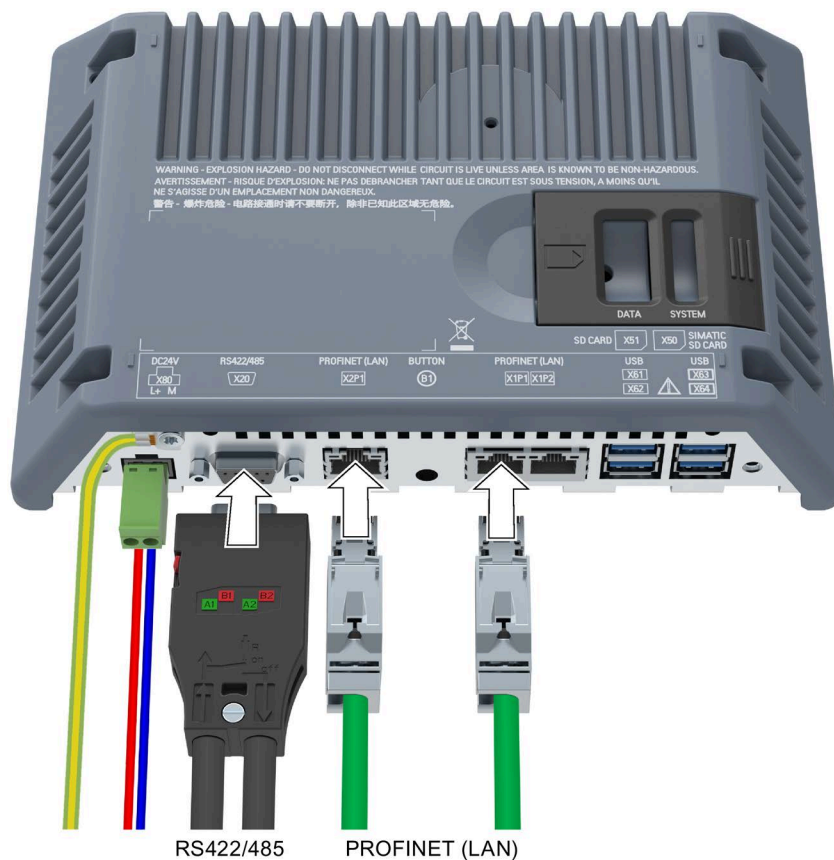

Use the PROFINET (LAN) X1 or X2 interface for SIMATIC process connection. Use the RS 422/485 interface for controllers from other manufacturers that are connected at the serial interface. Additional information on compatible controllers is available in the section "Communication with controllers (Page 188)".

Note

Use approved cables only

If you do not use approved cables to connect a SIMATIC S7 controller, you may experience malfunctions.

Use only approved cables to connect a SIMATIC S7 controller.

Note

Use only straight connectors

Use only straight cables whenever possible to connect a controller. Bent connectors can cover adjacent interfaces.

Standard cables are available for the connection. You can find order information in the Industry Mall (<https://mall.industry.siemens.com>).

PROFINET

Note

Observe the instructions regarding the installation of PROFINET networks, in the "PROFINET System Description (<https://support.industry.siemens.com/cs/ww/en/view/19292127>)" manual.

Both interfaces X1 and X2 support PROFINET basic services.

The HMI device has an internal switch. You can set up a ring topology, for example, with the HMI device without an external switch. Use the interface X1 to set up a ring topology.

3.4.6 Connecting a USB device

Below are examples of industrial grade devices you can connect to the USB type A interfaces of the HMI device:

- External mouse
- External keyboard
- Printer
- USB stick
- Industrial USB Hub 4, article number 6AV6671-3AH00-0AX0
- Mobile handheld readers ("barcode scanners"):
 - SIMATIC MV320, article number 6GF3320-0HT01
 - SIMATIC MV340, article number 6GF3340-0HT01
- RFID readers:
 - SIMATIC RF1040R, article number 6GT2831-6CA50
 - SIMATIC RF1060R, article number 6GT2831-6AA50
 - SIMATIC RF1070R, article number 6GT2831-6BA50

Note**USB cable length maximum 1.5 m**

USB cables with lengths of more than 1.5 m do not ensure secure data transfer.

The cable may not be longer than 1.5 m.

Note**Functional problem with the USB interface**

If you connect a USB device with its own power supply to the USB port, make sure that the USB ground terminal of the external device is connected to ground.

Note**Excessive rated load of the USB interface**

A USB device with too high a power load may possibly cause functional problems.

Observe the values for the maximum load rating of the USB interface, see section "Technical specifications (Page 182)".

Note**Potential loss of data**

If the HMI device accesses its data when a USB storage medium is removed, the data on the storage medium cannot be fully read or written, or it may even be destroyed.

If your process requires you to change the USB storage medium during operation, you need to take this into account by employing suitable mechanisms in the configuration.

Do not remove the USB storage medium during operation while data is being accessed.

Formatting of USB sticks

The following file systems are supported for USB sticks:

- NTFS
- FAT32

We recommend using the "NTFS" formatting method which offers greater data consistency and flexibility regarding the size of the saved files.

Wiring diagram

The following figure shows the example of a Unified Comfort Panel with a screen diagonal ≥ 15 " as you connect a USB device.

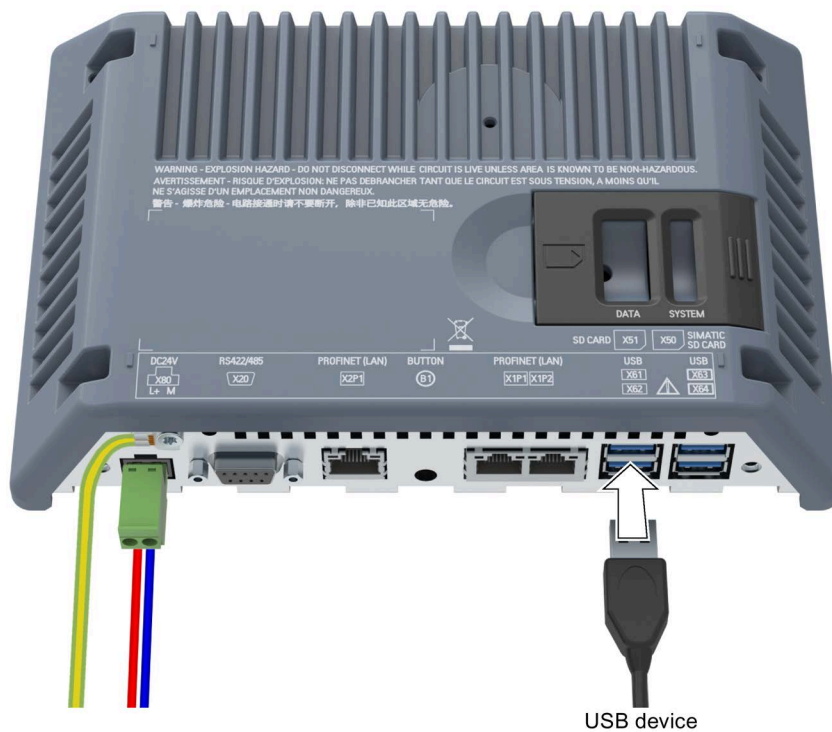

3.4.7 Connecting a printer

Wiring diagram

The following figure shows how to connect the HMI device to a printer with a Unified Comfort Panel with display diagonal $\geq 15"$ as an example.

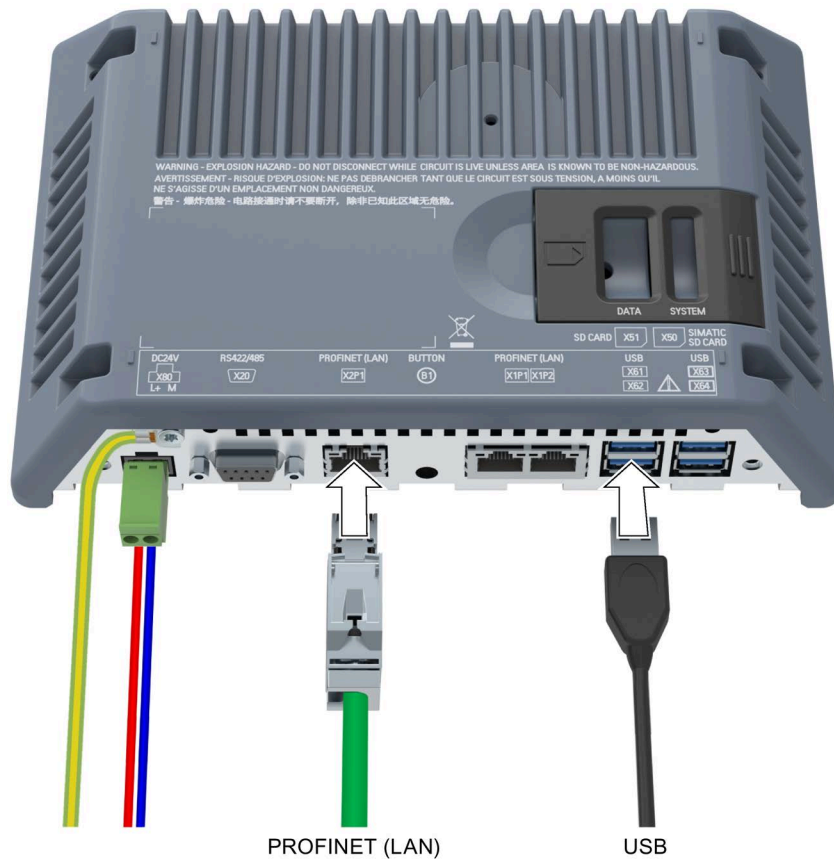

Note when connecting

Note

Cables for data exchange

If you use cables without a metallic netting shield between the HMI device and printer, you may experience functional problems.

Use cables with metal-braided shielding grounded at both ends only for connecting the HMI device and the printer.

Note

Some printers may require that you also set the ASCII character set used in the project on the printer.

Observe the supplied printer documentation when you connect the printer.

Managing printers

The connected printers are managed using the "Printer Configuration" app, see section "Add-ons (Page 140)".

3.4.8 Switching on, testing and switching off the device

Switch on the HMI device

1. Switch on the power supply. The display lights up.
If the HMI device fails to start after a longer period, you may have crossed the cables on the power supply connector. Check the connected cables and correct the polarity if necessary.
If a project is available on the HMI device, then the project is started after the defined delay time.
If there is no project on the HMI device, the Control Panel is displayed.

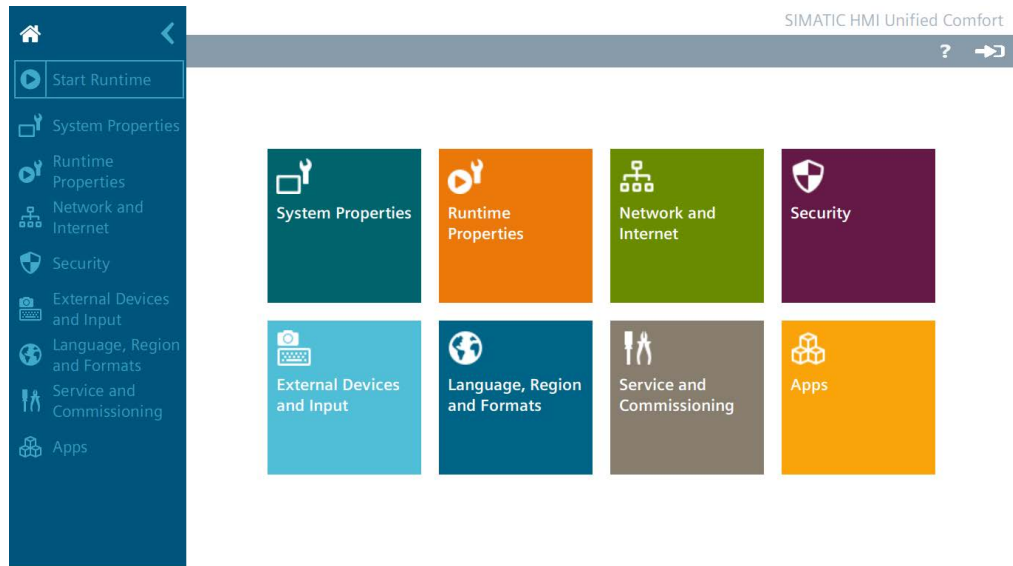

2. If desired, operate the project or configure the HMI device via the Control Panel.
If you no longer need the HMI device, switch it off.

Switching off the HMI device

1. Close the project on the HMI device.
2. Switch off the power supply.

3.4.9 Securing the cables

After the power-up test, secure the connected cables with a strain relief.

Requirement

The strain relief plate is mounted, see section "Installing a strain relief (Page 36)".

HMI devices with display diagonal $\leq 12"$

For devices with $\leq 12"$ display diagonal, secure the cables to the strain relief plate and to the plastic strain relief elements supplied.

The following figures use the MTP700 Unified Comfort as an example to show how to install the plastic strain relief elements.

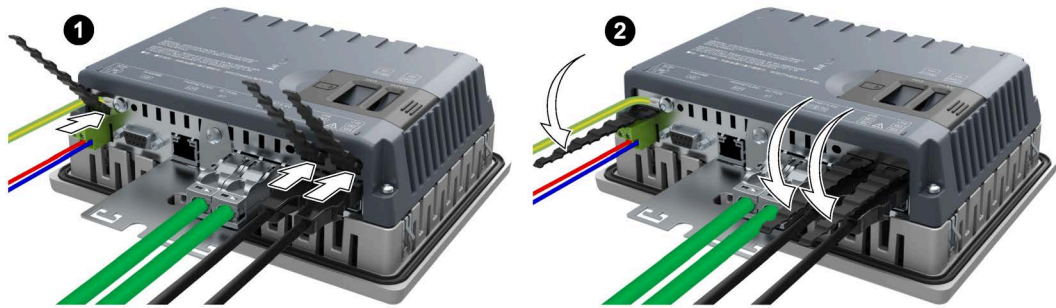

Next, use cable ties to secure the cables to the marked fastening points.

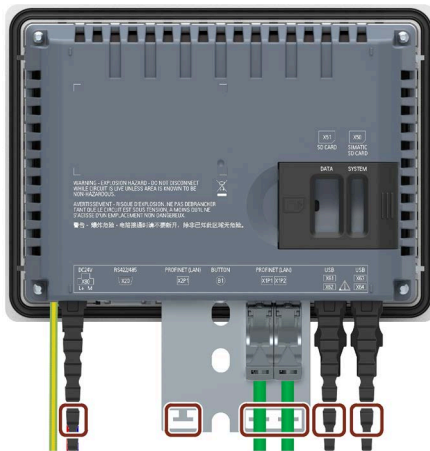

HMI devices with display diagonal ≥ 15 "

For devices with display diagonal ≥ 15 ", secure the cables to the marked fastening points of the strain relief plate.

The figure below shows the fastening points using the MTP1900 Unified Comfort as an example.

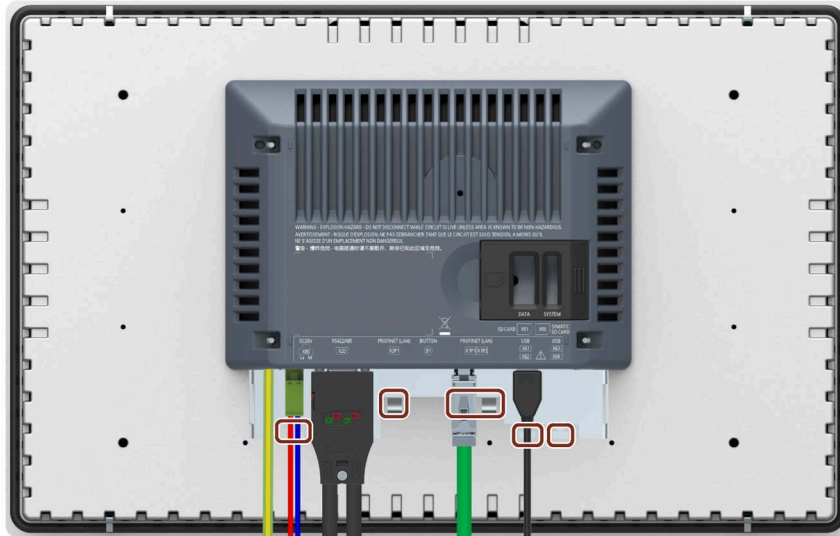

3.4.10 Securing cables for use in hazardous areas

When devices with Ex approval are used in hazardous areas, note that the connectors must be secured in a captive manner at the interfaces.

<p>! WARNING</p> <p>Explosion hazard from sparks when connectors come loose</p> <p>If a plug connector comes loose from the associated device interface during operation in a hazardous area, a spark over at the interface may cause an explosion. Death or serious physical injury as well as property damage may result.</p> <p>For use in hazardous areas, it must be ensured that the plug connectors of the cables are fully connected to the respective interface and cannot come loose from the interfaces in any case. For SIMATIC HMI Unified Comfort Panels, this risk only exists at the USB interfaces.</p> <p>Secure all connected USB cables directly at the transition between plug and cable to the nearest mounting element using a cable tie. Tighten up all cable ties in such a way that they fully wrap around the respective cable but do not damage the cable.</p>
--

Use the appropriate mounting elements to secure the connected USB cables, as described in the previous chapter.

The following figure shows an example of how to captively secure a USB plug.

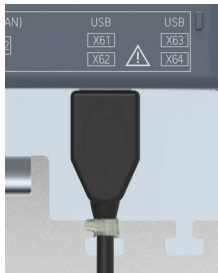

3.5 Removing the device

The HMI device is generally removed in the reverse order used for installing and connecting.

Procedure

Proceed as follows:

1. If a project is running on the HMI device, close the project with the HMI device configured for this purpose. Wait until the Control Panel is displayed.
2. Switch off power to the HMI device.
3. When you use the HMI device in a hazardous area, make sure that one of the two following requirements is met: The area is no longer hazardous or the device and its plug-in connections are de-energized.
4. Remove all cable ties on the HMI device used for strain relief.
5. Remove all plug-in connectors and the equipotential bonding cable from the HMI device.
6. Secure the HMI device so that it cannot fall out of the mounting cutout.
7. Loosen the screws of the mounting clips and remove all mounting clips.
8. Take the HMI device out of the mounting cutout.

See also

Connecting the device (Page 38)

Fastening the built-in device with mounting clips (Page 35)

Operating the device

4.1 Operator input options

Depending on the connected peripheral devices, the following operator input options are available:

- Capacitive multi-touch screen
- Screen keyboard
- External keyboard, connected via USB
- External mouse, connected via USB

If you need an external keyboard or mouse during operation, then use industrial grade devices. Devices that are not industrial grade are approved only for the commissioning.

As an alternative, you can also operate or monitor the device via remote access.

- Access via the SmartClient application or a VNC client, see section "Remote connection (Page 101)".
- Access via browser, see section "Web access to the HMI device (Page 71)".

4.2 Important notes on touch screen

You operate the capacitive multi-touch screen with one finger or with two-finger gestures.



WARNING

Personal injury or property damage due to no earth connection

An inadequate ground connection or the lack of one will cause malfunction of the capacitive multi-touch screen. Functions may not work properly. This can result in personal injury or property damage.

- Always connect the HMI device to a ground conductor.
- The ground conductor from the HMI device must be connected directly to ground with low impedance (short connection, minimum conductor cross-section 4 mm²).

You can find additional information on connecting the earth conductor in the section "Equipotential bonding (Page 40)".

 WARNING
Personal injury or property damage due to maloperation
Incorrect operation of touch devices cannot be ruled out. This can result in personal injury or property damage.
Take the following precautions:
<ul style="list-style-type: none">• Configure the plant so that safety-related functions are not operated with the touch screen.• Only carry out an operator action if a plant screen is shown on the HMI device screen.• Switch off the HMI device for cleaning and maintenance.

NOTICE
Damage to the touch screen
The following operation significantly reduces the service life of the touch screen and can lead to total failure:
<ul style="list-style-type: none">• Touching with pointed or sharp objects• Shock contact with hard objects.
Only touch the touch screen with a finger or a touch pen.

 WARNING
Danger of malfunctions due to incorrect execution of gestures on the touch screen
If gestures are executed incorrectly on the touch screen with multi-touch function, these gestures may not be recognized or could be recognized incorrectly. The entries made are then not implemented by the touch device or are implemented incorrectly or in an unintended manner.
Incorrect execution of multi-touch functions can lead to errors in the operation of the plant and thus to physical injury.
Observe when operating the capacitive multi-touch screen:
<ul style="list-style-type: none">• The touch screen reacts to contact on its surface, not to pressure.• When using a touch pen: Operate the touch screen only with a touch pen for capacitive touch.• Avoid unintended multiple touches, for example, with your knuckles.
Before using the HMI device, familiarize yourself with the supported multi-touch functions of the operating system and the applications. Ensure that the gestures which the user executes on the multi-touch screen are recognized by the application. It is possible that certain gestures need to be trained beforehand.

Notes on operation

Note

Do not touch the capacitive multi-touch screen during startup

The HMI device automatically calibrates the capacitive multi-touch screen during startup. The touch screen is locked during calibration.

Do **not** touch the touch screen during startup. Make sure that you do **not** rest on the touch screen with the palm of your hand during startup.

Make sure that there are **no** conductive liquids on the touch screen during startup.

Note when operating the capacitive multi-touch screen:

- Surface contact with a diameter of about 5 to 20 mm is required for an operator action to be detected.
- An operation with gloves with a material thickness of < 2 mm is detected in most cases. However, check the usefulness of the gloves you are using.
- To avoid incorrect operation, certain inputs are ignored and blocked from further entry:
 - Simultaneous operation with more than 5 fingers.
 - Surface contact with a diameter of > 3 cm, for example, resting the palm of the hand on the touch screen
 - As soon as the touch screen is no longer touched, input is possible again.

Functions of the capacitive multi-touch screen

General functions

- Detection of up to 5 finger touches at a time.
- Recognition of the gestures supported by the operating system and the runtime software.
- You do not need to calibrate the capacitive multi-touch screen.

Security functions in an industrial environment

The capacitive multi-touch screen is locked for security reasons when the following disturbances occur:



- There is a conductive liquid on the touch screen with ground contact via the enclosure or the operator, for example.
- An electromagnetic disturbance that exceeds the specification in the technical data of the device exerts an influence, see section "Electromagnetic compatibility (Page 171)".

Once the interference is over, the capacitive multi-touch screen is no longer locked.

4.3 Supported gestures

4.3.1 Supported gestures in the Control Panel

The following touch gestures are available in the Control Panel.

Icon	Gesture	Behavior
	Tap	To activate an input object (such as input box, option button, drop-down list), tap on the input object.
	Vertical dragging with one finger	To scroll vertically in the window pane or in lists, drag vertically in the corresponding area with one finger.
	Horizontal dragging with one finger	To scroll horizontally in the window pane or in lists or to set a slider, drag horizontally in the corresponding area with one finger.

Apps

When you open an app installed on the HMI device, the gestures supported by the app are also available, for example, the "Zoom" and "Keep pressed" functions in the "Web Browser".

4.3.2 Supported gestures in the runtime project

Various touch gestures are available for the runtime operation. Some touch gestures have different effects in plant screens than in operating elements.

Note





No operation with three or more fingers.

Use only one or two fingers when operating with touch gestures.

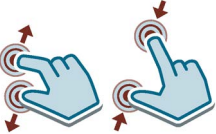

If you use more than two fingers with touch gestures, this can cause incorrect operation.

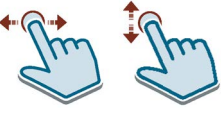

In the case of multitouch operation with several fingers, you only operate the respectively configured objects.

Touch gestures supported in plant screens

Icon	Gesture	Function
	Tap	To select an object, tap on the corresponding location in the plant screen.
	Zooming	To zoom in or out of a display in a plant screen, drag with two fingers in an area in which there are no operating elements.
	Drag with one finger	To move the zoomed area of a plant screen, drag it with a finger to an area in which no operating elements are located.
		To move objects with a window, drag the object in the desired direction using its title bar.
	Swipe	To switch between plant screens, swipe horizontally or vertically with one finger. A touch area must be configured for this function.
	Keep pressed	The function corresponds to a right-click. To trigger the event configured for the right-click, press the object or link for more than one second.

Touch gestures supported in operating elements

Icon	Gesture	Behavior	Supported WinCC operating elements
	Tap	To select a row, tap the row. With corresponding configuration of the operating element: To select a cell.	Alarm control
	Drag with two fingers	To move window contents, such as zoomed tables or trends, drag the window of the operating element with two fingers.	<ul style="list-style-type: none"> Trend control Process control Ruler window Browser

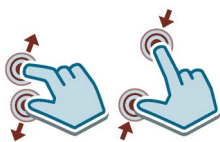
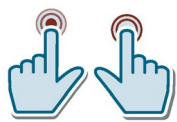
Icon	Gesture	Behavior	Supported WinCC operating elements
	Vertical swiping	Vertical scrolling using list entries	Drop-down list box
	Drag with one finger	To shift the X axis or Y axis. To navigate within a list or table.	<ul style="list-style-type: none"> • Trend control • Process control • Ruler window
		To select multiple rows, tap a row and drag your finger up or down. With corresponding configuration of the operating element: To select multiple cells.	Alarm control
		To adapt the column width, tap a column grid line and drag your finger to the right or left.	
		To change the order of the columns, tap a column header and drag your finger to another column header.	
	Zooming	To zoom in or out of a display in an operating element, drag the window of the operating element with two fingers.	Trend view, browser, screen window
			

4.4 Using the screen keyboard

4.4.1 The screen keyboards

When you touch an operating element in Runtime or in the Control Panel on the touch screen of the HMI device that requires input, the screen keyboard is displayed.

If the screen keyboard is not displayed automatically during data input, use the floating screen keyboard described at the end of this section.

The alphanumeric screen keyboard

The key layout of the screen keyboard is based on the layout of a PC keyboard in the corresponding language. The figures below show the different levels of the screen keyboard using the English layout ("QWERTY") as an example.

Lowercase letter level



The <SHIFT> button is used to switch to uppercase level.

Use the <&123> button to switch to the special character level.

Use the <Polyline> button to switch to the graphic input level.

Uppercase letter level



The <SHIFT> button is used to switch to lowercase level.

Use the <&123> button to switch to the special character level.

Use the <Polyline> button to switch to the graphic input level.

Special character level 1

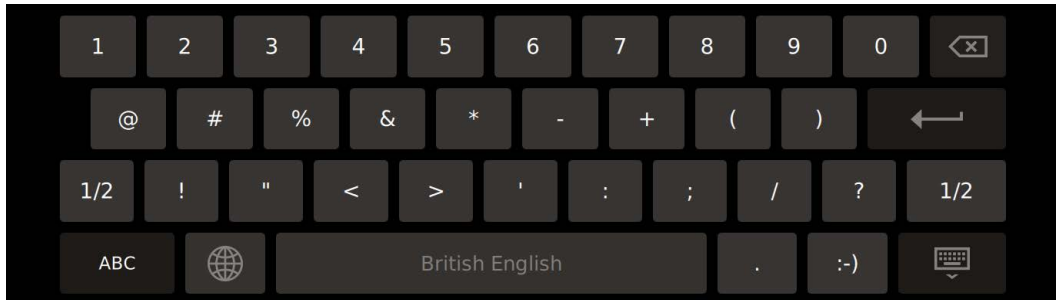

Use the <1/2> button to switch to special character level 2.

Use the <ABC> button to switch to the last used letter level.

Special character level 2



Use the <2/2> button to switch to special character level 1.

Use the <ABC> button to switch to the last used letter level.

Graphic input level

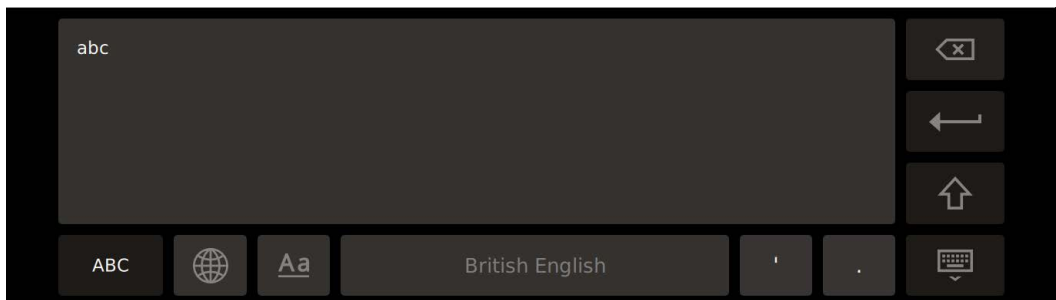

The graphic input level is only available in conjunction with the "British English" language setting.

In the graphic input level you can draw numbers or letters in a large touch area. The drawn numbers or letters are recognized and transferred to the active input box.

The <ABC> button is used to switch to the input of letters in the touch area.

The <123> button is used to switch to the input of numbers in the touch area.

The <Aa> button to switch to the last used letter level.

Numerical screen keyboard

If a numeric value is to be entered in a input box, the numerical screen keyboard is displayed.

Numeric screen keyboard in the Control Panel



If, for example, only numeric values are to be input for a PIN, then only the numeric keypad of the screen keyboard is displayed.



Numerical screen keyboard in Runtime



Checking numerical value limits

Tags can be assigned limit values. Any entry of a value outside this limit is rejected. If an alarm view is configured, a system alarm is triggered and the original value is displayed again.

Decimal places of numerical values

The configuration engineer can define the number of decimal places for a numerical text box. The number of decimal places is checked when you enter a value in this field.

- Decimal places that exceed the limit are ignored.
- Unused decimal places are padded with "0" entries.

The floating screen keyboard

The floating screen keyboard is used for data input in apps. The floating screen keyboard requires less display area and can be moved around the display.

You can also open the floating screen keyboard by clicking on the following icon in the taskbar of the HMI device:



The levels and keys of the floating keyboard correspond to the levels and keys of the alphanumeric keyboard.

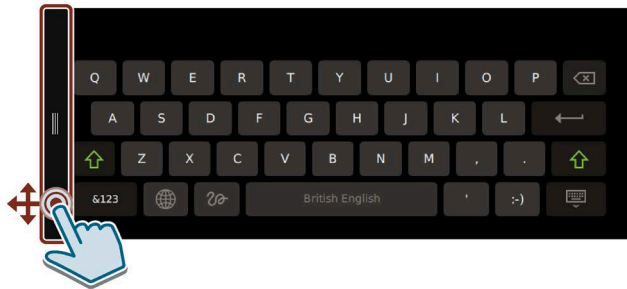

To move the floating screen keyboard, drag the floating keyboard by its left bar to the desired position.

You cannot enter data in the touch area of the graphic input level with the floating screen keyboard.

4.4.2 Control keys on the screen keyboard

The following control keys are available on the screen keyboard:

	Switch to lowercase level		Switch to special character level 1 in a letter level
	Switch to uppercase level		Switch to special character level 2 in special character level 1.
	Toggle language		Switch to special character level 1 in special character level 2.
	Delete character left of cursor		Switch to the last letter level used in a special character level Switch to letter input in the graphic input level
	Switch to graphic input level		Switch to numeric input in the graphic input level
	Switch to the last used letter level in the graphic input level.		Close screen keyboard, confirm input
	Creates a "smiley" in the active input box		Confirm entry, close the screen keyboard
	Creates three points in the active input box		

4.5 Using the taskbar

A taskbar is available for fast access to functions or apps.

Depending on the settings in the Control Panel under "Taskbar (Page 89)", the taskbar is available and is located at the bottom, top, left or right edge of the display.

You open the taskbar with a swiping gesture from the edge of the display to the center of the display. If there is no operation in the taskbar for more than two seconds, the taskbar is hidden again. The following figure shows an example of the default setting "Taskbar enabled", located at the bottom edge of the display.

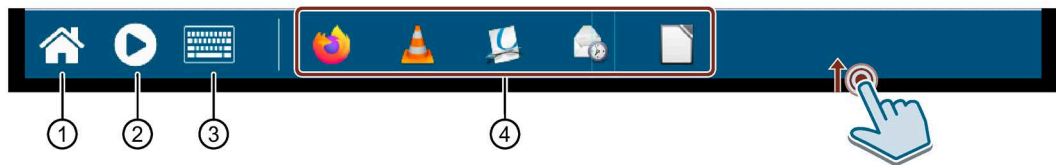

- ① Icon for opening the Control Panel from the Runtime project.
- ② "Start Runtime" icon to start the Runtime project.
- ③ Icon for opening the floating screen keyboard.
- ④ Symbols of all currently opened apps. The example shows from left to right the icons "Web Browser", "Media Player", "PDF Viewer", "E-Mail Client" and "Doc Viewer".

The buttons ① to ③ are always displayed in the taskbar, the number of app icons varies depending on the number of opened apps.

Touch a button or icon to activate the corresponding function or bring the corresponding app to the foreground.

If you operate your HMI device via an industrial grade mouse or remotely operate the HMI device via a client with mouse, then you can right-click the apps in the taskbar to close them again. If you operate the HMI device without a mouse, then close apps via the corresponding menu function or via the icon "x" on the far right in the app's title bar.

Note

Best performance

Each app takes up a specific amount of work memory. The greater the number of apps and tabs open in the "Web Browser" app, the smaller the amount of available work memory.

Note the following recommendations to achieve the best performance of your HMI device:

- Keep the number of apps that are open simultaneously as small as possible.
- Close any apps that you no longer need.
- If possible, open only one tab in the "Web Browser" app.

The floating screen keyboard is designed for data input in apps. Additional information is available in the section "Using the screen keyboard (Page 61)".

4.6 Commissioning the HMI device

Requirement

The HMI device is mounted and connected according to these operating instructions.

Procedure

The following procedure describes how to typically include the HMI device during operation.

1. If you want to use the service concept with automatic backup, then insert a SIMATIC SD memory card ≥ 32 GB into the "X50 SYSTEM" slot.
Activate the automatic backup in the Control Panel under "Service and Commissioning" > "Automatic Backup" via the "Start" button.
2. Configure the HMI device in WinCC. When configuring, consider your security concept in the security settings. Configure a user administration. Define a user with the "Control Panel access" function right who can protect the HMI device against unauthorized access to the Control Panel.
3. Make sure that the network address of the HMI device corresponds to the configured network address.
4. Transfer your project including user administration via WinCC from the configuration PC to the HMI device.
5. If necessary, have the Control Panel protected against unauthorized access by an HMI device administrator under "Security" > "Control panel access".
6. Check the authorizations of the operators in the Control Panel under "Security" > "User management" and adjust the settings if necessary.
7. If necessary, deactivate one or more interfaces for storage media under "Devices And Input" > "Hardware interfaces".
8. Check date and time under "Language, Region and Formats" > "Date and time".
9. Set the required delay time for the start of the project under "Runtime Properties" > "Automatic runtime start".
10. Check in the Control Panel under "Apps" whether all apps required for the operation are available.
If additional apps are required, then install these via "Apps" > "App Management".

Result

Commissioning has been completed, the HMI device is ready to use. Depending on your application, further individual settings may be required in addition to the steps described.

4.7 Memory concept and memory cards

4.7.1 Memory concept

The HMI devices use the following memory types:

- **Internal memory**
- **Data memory card** for user data and logs
- **System memory card** for "automatic backup"
- USB port for a **USB storage medium** with data

Note**Use the memory card for logs**

Due to the high number of read/write cycles, we recommend that you use the memory card rather than the USB interface for logs.

Internal memory

The following data is saved in the internal memory:

- Operating system
- Project file
- User management
- Parameter sets
- Other data, such as documents or media files

Note**Cyclic write access to the internal memory is not permitted**

Cyclic write access to internal memory is not permitted, because it reduces the service life of the internal memory and thus of the HMI device, for example, a configuration in which permanent system alarms or user-defined messages are generated in the alarm buffer.

Configure an alarm window, check the number and frequency of the alarms that occur. If you expect a permanent load on the internal memory from alarms, adjust the configuration accordingly.

If the alarms do not have to be stored permanently, you can disable the retentivity of the alarm buffer, see section "Alarm buffer (Page 92)".

To prolong the service life of your HMI device, you should preferably use external memory cards, e.g. the SIMATIC SD Memory Card ≥ 32 GB, to store and log data.

In addition, you can activate the monitoring of the internal flash memory, see section "Performance (Page 88)".

Data memory card

The following data can be saved to the data memory card.

- Logs
- Data backups
- User data
- Parameter sets¹
- Data for the reporting

¹ To store parameter sets on the memory card, select "\\Storage Card SD\" as the path in WinCC.

You can use commercially available memory cards with "SD(IO/HC)" format as data memory card. For reasons of data consistency, Siemens recommends the use of the SIMATIC SD memory card ≥ 32 GB as data memory card, see section "Accessories (Page 16)".

Note

Data consistency

When the HMI device is switched off, the consistency of the stored data is ensured only for the SIMATIC SD memory card ≥ 32 GB.

With commercially available memory cards, switching off the device may result in the loss of saved data, for example, due to a power failure.

Note

Frequency

Logs are stored at a frequency of approx. 0.2 Hz. This may result in small amounts of data not being saved shortly before a power failure.

Use a UPS to avoid data loss even shortly before a power failure.

System memory card

The system memory card is part of the service concept of the HMI devices. If you enable the "Automatic backup (Page 130)" function, all data from the internal memory of the HMI device is transferred to the system memory card. If the HMI device fails, you insert the system memory card into a replacement device. Once the replacement device starts, you can continue working on your project. This way you reduce your plant downtimes to a minimum.

The system memory card is not visible in the user interface of the HMI device and it cannot be used for data storage. In order for the HMI device to recognize the system memory card, you have to insert the system memory card into the slot designed for it.

Note

Type of system memory card

Only the SIMATIC SD memory card ≥ 32 GB is permitted for use as a system memory card. Other memory cards are not recognized as system memory card by the HMI device.

Slots for data and system memory cards

The slots for data memory card and system memory card are on the back of the HMI device. The memory cards are protected by a safety catch.

The figure below shows the slots with safety catch.



- ① Slot X51 for the data memory card in the format "SD(IO/HC)", recommendation for the card: SIMATIC SD memory card \geq 32 GB
- ② Slot X50 for the system memory card, permissible card: SIMATIC SD memory card \geq 32 GB
- ③ Safety catch, two-stage

Formatting the data memory card

The following file systems are supported for formatting the data memory card:

- FAT32
- NTFS

Use one of the supported file systems when formatting the data memory card.

Note

Using system memory card as data memory card

A memory card that has already been used as a system memory card in conjunction with the "Automatic backup" function can no longer be used as a data memory card. To use a system memory card as a data memory card, format the memory card with one of the supported file systems, preferably NTFS.

Formatting the system memory card

When you insert a SIMATIC SD memory card with 32 GB or more in slot X50 and activate the "Automatic backup (Page 130)" function, the memory card is formatted automatically.

Note

Using the data memory card as system memory card

A memory card that has been used as a data memory card must be formatted before it can be used as a system memory card. Formatting takes place automatically when you activate the "Automatic backup (Page 130)" function. All data is lost on the memory card during formatting. If necessary, back up the data on a data memory card before you use this memory card as a system memory card.

4.7.2 Changing the memory card

The memory cards are protected by a safety catch.

 WARNING
Do not plug or pull a memory card in a hazardous area
If you plug or pull a memory card during operation, you run the risk of a flashover. A flashover can cause an explosion in a hazardous area, resulting in death or severe injuries.
Plugging or pulling of a memory card in a hazardous area is prohibited .
Do not plug or pull a memory card until one of the two following requirements is met: The area is no longer hazardous or the device and its plug-in connections are de-energized.

Note

Potential loss of data

If the HMI device accesses its data when the memory card is removed, the data on the memory card cannot be fully read, written or it may even be destroyed.

If your process requires you to change the memory card during operation, you need to take this into account by employing suitable mechanisms in the configuration.

Do not remove the memory card during operation while data is being accessed. Observe the corresponding alarms on the screen.

Note

Do not remove the system memory card for "automatic backup" during operation

If the "Automatic backup (Page 130)" function is activated, the system memory card may only be removed when the HMI device is switched off.

Note

Removing the system memory card while the project is running

If you remove the system storage card while a project is running, the project is ended.

Requirement

There are currently no read or write accesses to the memory card.

Procedure

Note

Only use SIMATIC SD memory card ≥ 32 GB as system memory card

Only the SIMATIC SD memory card ≥ 32 GB is permitted for use as a system memory card. All other memory cards are not recognized as system memory card by the HMI device.

The following procedure describes the replacement of the system memory card as an example and applies in the same way to the data memory card.

1. Slide the safety catch to the desired position to replace the memory card.
2. To remove the memory card, briefly press-in the corresponding card. The card is released and can be removed.

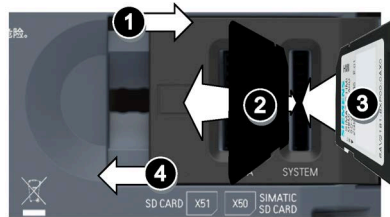

3. Insert the new memory card so that it clicks into place audibly and tangibly.
4. Slide the safety catch back into its original position.

If you have inserted the system memory card, the "System memory card plugged" dialog box is displayed. This dialog box is used to open the Control Panel and enable the "Automatic backup" function there.

4.8 Web access to the HMI device

As an alternative to direct operation on the device, you can access the following applications of the HMI device via a browser:

- The runtime project
- The user management
- The local "SIMATIC Edge" edge management
- "SIMATIC Extensions"

Requirement

- The device on which the browser is running is connected to the HMI device in the same subnet.
- The browser used supports HTML5 and accepts self-signed certificates.
- The following applies depending on the application you want to access:
 - "WinCC Unified RT": Web access to the runtime project is activated, see section "Web client (Page 93)". The runtime software has been started.
 - "User Management": The settings for the user management were loaded to the HMI device, see sections "User management (Page 107)" and "UMAC settings (Page 120)".
 - "SIMATIC Edge Management", "SIMATIC Extensions": The associated service is activated in the Control Panel of the HMI device, see section "SIMATIC Apps (Page 138)".

Opening applications via the homepage

The HMI device has a convenient homepage for applications with web access.

To open the homepage, enter the following URL in the browser: "**https://<ip>**"

Use the IP address of the HMI device instead of the placeholder "<ip>". When you use a browser that runs directly on the HMI device, you can also use "localhost" instead of the IP address.

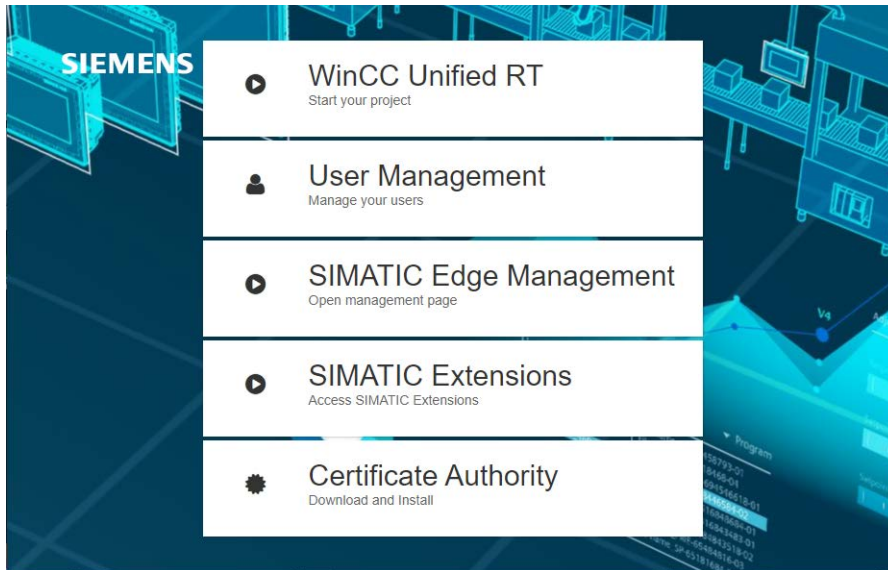

- "WinCC Unified RT": Button for opening the "Sign in" dialog for runtime.
- "User Management": Button for opening the "Sign in" dialog for the user management.
You can find detailed information on web-based user management via a browser in the TIA information system under "Visualizing processes (RT Unified) > Configuring users and roles (RT Unified) > Using the user management on the Unified Comfort Panel > Managing local users > Managing local users in runtime".
- "SIMATIC Edge Management": Button for opening the "Sign in" dialog for the "SIMATIC Edge" application.
- "SIMATIC Extensions": Button for opening the "Sign in" dialog for the "SIMATIC Extensions" application.
- "Certificate Authority": Button for downloading the HMI device certificate for a secure connection.

Opening applications without the homepage

Use the following URLs to open the "Sign in" dialog in the respective application without the homepage.

- "WinCC Unified RT": "https://<ip>/device/WebRH", note the uppercase/lowercase spelling.
- "User Management": "https://<ip>/umc"
- "SIMATIC Edge Management": "https://<ip>/device/edge"
- "SIMATIC Extensions": "https://<ip>/device/simatic-extensions"

Use the IP address of the HMI device instead of the placeholder "<ip>". When you use a browser that runs directly on the HMI device, you can also use "localhost" instead of the IP address.

Installing a certificate

The following applies when you open an application with web access for the first time via a browser: To set up a secure connection between browser and application, you must download the certificate of the application and install it in your browser as "trusted".

NOTICE

Use CA certificates generated via the WinCC Unified Certificate Manager

If you use a self-signed certificate from a non-trustworthy source, the data transfer is not protected from attacks.

For web access to the HMI device, use CA-certificates that were generated via the WinCC Unified Certificate Manager. To do so, proceed as follows:

1. Generate a CA certificate with the WinCC Unified Certificate Manager .
2. Copy the CA certificate to a USB flash drive.
3. Import the CA certificate in the Control Panel via "Security">"Certificates" as "Trusted Certificate Authority".
4. Install the certificate in your browser as described in the following sections.

Download certificate

You have the following options to download the certificate:

- Using the "Certificate Authority" button on the homepage.
- Using the "Certificate" link in the "Sign in" dialog of the applications "SIMATIC Edge" and "SIMATIC Extensions".
- By clicking on the icon or the "Not secure" message in the address bar of the browser.

Installing the certificate as "trusted" in the "Web Browser"

Follow the instructions in the browser documentation to import the application certificate and classify it as "trusted".

A secure connection to the website is set up immediately with the trusted certificate.

Note

Certificate is valid for all applications with web access

For a secure connection to the applications with web access, the HMI device certificate must only be downloaded once and classified as "trusted".

Sign in using the "Sign in" dialog

You use the "Sign in" dialog to sign in to an application with web access.

"Sign in dialog" for runtime-related applications

The following figure shows the "Sign in" dialog for the following applications.

- "WinCC Unified RT"
- "User Management"

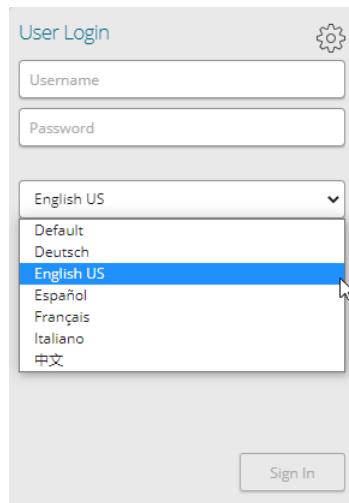

Procedure:

1. Select the required runtime language.
2. Enter the user name and password.
3. Click "Sign in".

If the selected language is not available in the runtime project, the default language is used.

"Sign in dialog" for "SIMATIC Apps"

The following figure shows the "Sign in" dialog for the following applications.

- "SIMATIC Edge Management"
- "SIMATIC Extensions"



Procedure:

1. If not done yet, download the certificate of the application using the "Certificate" button and install the certificate in your browser, see the "Installing a certificate" subsection in this section.
2. Enter the user name and password.
3. Click "Sign in".

Notes on web access

After signing in, read the following notes on web access in the various applications:

"WinCC Unified RT"

After successful login, a user session is active. Note the following for user sessions:

- A maximum of three user sessions are permitted on one HMI device.
- User management is used in a user session when signing in. Changes to the user management of the HMI device have no effect on the session in progress.
- You have the following options to completely close a user session:
 - Configure an operating element with the system function "Log off".
 - Close all instances, that is, all open browser windows.

For more information on remote access via "Web client", refer to the TIA information system under: "Visualizing processes (RT Unified) > Configuring remote access > Web client".

"User Management"

- The user list is only visible and editable for users who have been assigned the "User Management" function right.
- You can find detailed information on web-based access to the user management in the TIA information system under "Visualizing processes (RT Unified) > Configuring users and roles (RT Unified) > Using the user management on the Unified Comfort Panel > Managing local users > Managing local users in runtime".

"SIMATIC Edge Management"

- Access to the application requires a user with the "HMI Administrator" role.
- You can find detailed information on the local Edge Management on the Edge Management website in the programming and operating manual "Siemens Industrial Edge (<https://support.industry.siemens.com/cs/ww/en/view/109773259>)".

"SIMATIC Extensions"

- Access to the application requires a user with the "HMI Administrator" role.
- You can find detailed information on the use of SIMATIC Extensions using the "UserManual" link at the top left in the header of the SIMATIC Extensions website.

4.9 Notes on operation

Storage media

Note

Storage media displayed multiple times

The operating system of the HMI device supports multiple mount points. This means that USB and SD storage media may be displayed multiple times in file browser dialogs. This does not affect the functionality of the HMI device and the apps.

Note

Directory for storage media in Runtime and in apps

In file browser dialogs of the Runtime software and in apps that use the same file browser dialogs, you can find the storage media under "/media".

SIMATIC Edge

Note

Activating SIMATIC Edge

The option "Apps" > "SIMATIC Apps" > "SIMATIC Edge" > "Enable SIMATIC Edge" can only be activated upon the first start of the HMI device when the start process has been completed. After starting the HMI device for the first time, wait for approx. 1-2 minutes. Then you can activate the option "Enable SIMATIC Edge".

Operating the Control Panel

5.1 Opening the settings

The Control Panel can be opened as follows:

- After switching on the device, if there is no project on the HMI device.
- Via an appropriately configured operating element in your project.
- By terminating the project running on the HMI device.

The following figure shows the open main window of the Control Panel:

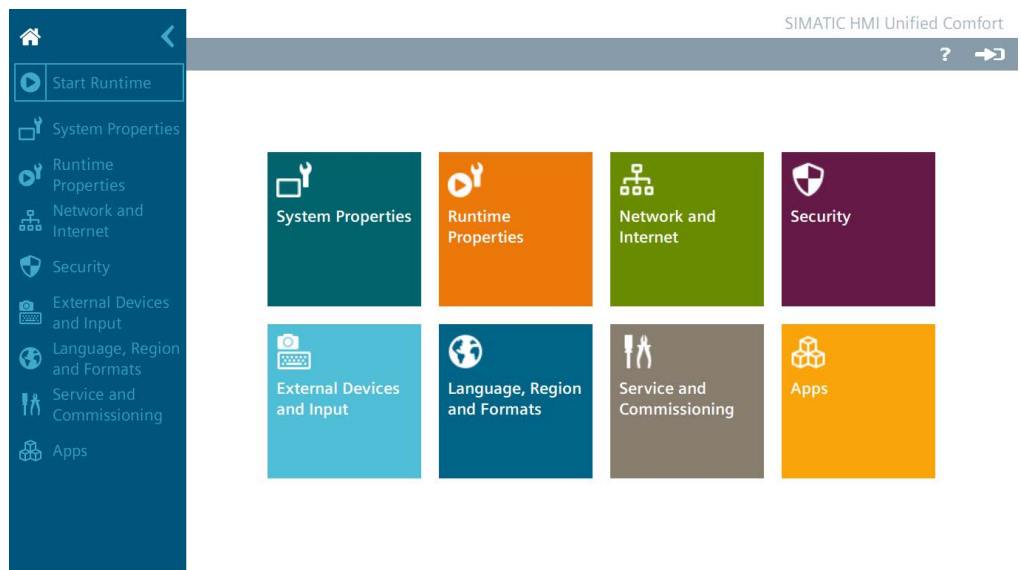

To make the corresponding settings, select an entry in the navigation area or a tile in the window pane.

Note

Enabling password protection for the Control Panel

The password protection for the Control Panel is deactivated when the HMI device is delivered, which means that all users can make changes in the Control Panel.

To protect your HMI device against unauthorized changes, you can activate password protection for the Control Panel, see section "Control panel access (Page 119)".

NOTICE

Do not change settings during configuration PC communication

If you change settings in the Control Panel while the HMI device is being addressed by the configuration PC, a malfunction may occur.

Do not change the settings when the HMI device is being addressed by the configuration PC, for example during project download or via the "Flash LED" function.

Logging on in the Control Panel

The "Login" button is located on the right of Control Panel title bar.



If user management has been configured for the HMI device and transferred to the HMI device, you can log in using the "Login" button. After logging in, you have the authorizations that were defined for your login in the configuration. To access all functions in the Control Panel, a user needs the "Control Panel access" function right.

Note

Number of login attempts

The number of login attempts is 19. After 19 failed attempts, the user involved is locked out on the next attempt. The user must be deleted and recreated, or you must reload the User Management into the HMI device.

Ensure you enter the login credentials correctly.

Alternatively, you can log in via an RFID card if your user has been assigned an RFID login. Hold the RFID card just in front of the RFID reader and input your PIN if required.

After you have logged in, the "Logout" button is displayed in the title bar instead of the "Login" button.



Switching the navigation area

You can switch the navigation area from the maximized display to the minimized display as follows.

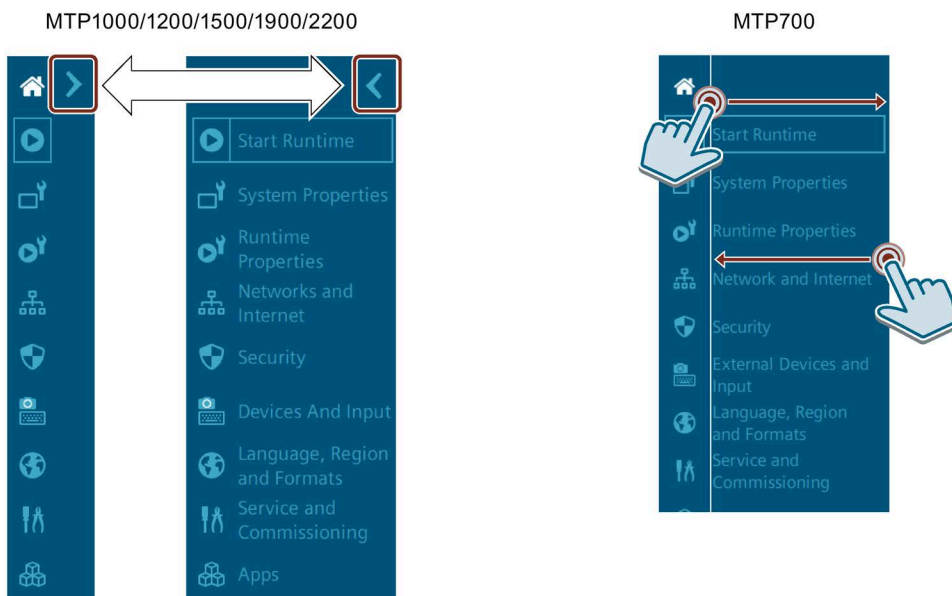

Control Panel help

In the title bar, you will find the "Help" button to the left of the "Login" button.



Open the "Unified Comfort Panels Help" dialog using the "Help" button.













You have the following options in the "Unified Comfort Panels Help" dialog to open the Control Panel help:

- Scan the QR Code or enter the link below the QR Code in the browser of an external device with Internet connection.
The help opens on the external device. You can read the help on the external device and navigate in the Control Panel of the HMI device at the same time.
- If your HMI device has an Internet connection, click on the link below the QR Code.
The help opens on the HMI device.

5.2 Overview of functions

The table below shows the icons of the Control Panel and provides links to the corresponding function descriptions in the appropriate sections.

Icon	Name	Assigned functions
	-	Open the main window of the Control Panel
	Start Runtime	Start project on the HMI device See also "Automatic runtime start (Page 91)"
	System Properties	Panel information (Page 81) Display (Page 82) Screensaver (Page 83) Update OS (Page 84) Reboot (Page 86) Performance (Page 88) Taskbar (Page 89) Event Logger (Page 89)
	Runtime Properties	Project information (Page 91) Automatic runtime start (Page 91) Alarm buffer (Page 92) Web client (Page 93) Load project from storage (Page 94)
	Network and Internet	Network settings (Page 97) Remote connection (Page 101) Network drive (Page 103)
	Security	User management (Page 107) Certificates (Page 115) Control panel access (Page 119) UMAC settings (Page 120)
	External Devices and Input	Hardware interfaces (Page 122)
	Language, Region and Formats	Date and time (Page 123)
	Service and Commissioning	Transfer (Page 125) Update OS (Page 84) Backup (Page 128) Automatic backup (Page 130) Restore (Page 134) Trace forwarder (Page 136)
	Apps	Apps (Page 137)

Some settings, such as interface parameters, runtime settings, settings for remote access or user management, can be configured in WinCC and loaded to the HMI device. After loading, you can adjust the settings as needed in the Control Panel of the HMI device.

5.3 System Properties

5.3.1 Panel information

Under "Panel information" you will find information specific to your HMI device, which you will need, for example, if you contact Technical Support.

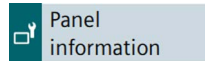

Properties

The following figure shows an example. Variable display values are shown with the wildcard character "#" or between angle brackets "<>".

Device type:	MTP1500 Unified Comfort
Article number:	6AV2128-3QB06-0AX0
Serial number:	V-00000015
Firmware/Image version:	V18.00.00.01_0#.0#
Runtime version:	18.0.0.#
Bootloader version:	V05.0#.00.00_01.01.01.01
Bootloader release date:	<dd>/<mm>/<yyyy>
PN-X1 MAC address:	08-00-06-00-02-b0
PN-X2 MAC address:	08-00-06-00-00-b0

- "Device type": HMI device type designation
- "Article number": Article number of the HMI device
- "Serial number": HMI device serial number
- "Firmware/Image version": Version of the firmware and operating system.
- "Runtime version": Version of the runtime software located on the HMI device
- "Bootloader version": Version of the bootloader
- "Bootloader release date": Bootloader release date
- "PN-X1 MAC address": MAC address of the HMI device interface X1
- "PN-X2 MAC address": MAC address of the HMI device interface X2

5.3.2 Display

Under "Display" you define the display orientation and the display brightness via the intensity of the backlight.

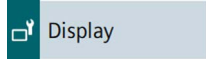

NOTICE
Backlight reduction The brightness of the backlight decreases with increasing service life. To avoid shortening the service life of the backlight unnecessarily, reduce the backlight.

Orientation



- "0° (Landscape)" (default setting): Select this option for HMI devices that have been installed and configured in landscape format.
- "90° (Portrait)": Select this option for HMI devices that have been installed and configured in portrait format.

Note

Display orientation and Runtime project

The display orientation in the Control Panel should match the display orientation of the HMI device in the WinCC configuration. After switching the orientation in the Control Panel, adjust the configuration and reload the project into the HMI device.

The display orientation in the Control Panel should only be switched if no runtime project is running on the HMI device.

If you switch the display orientation while a Runtime project is running on the HMI device, the project may not be displayed correctly on the HMI device display after switching. To display the project correctly, restart the Runtime software or the HMI device.

Brightness

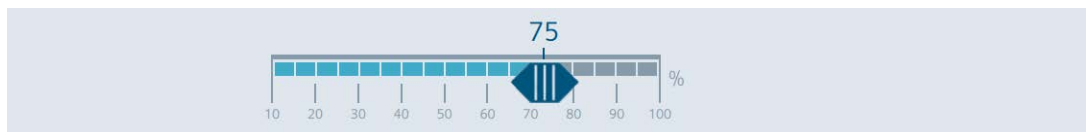

Set the desired display brightness using the slider.

Value range: 10 to 100%. Default setting: 70%

The display brightness can also be set within the value range via the configuration.

5.3.3 Screensaver

Under "Screensaver" you define the time until the automatic activation of the screensaver and the brightness of the backlight when the screensaver is active.

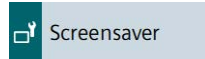

NOTICE

Activating the screensaver

If an image is displayed on the screen for long time, its outline may remain dimly visible on the display.

This effect is reversible when you use a screensaver.

General Settings

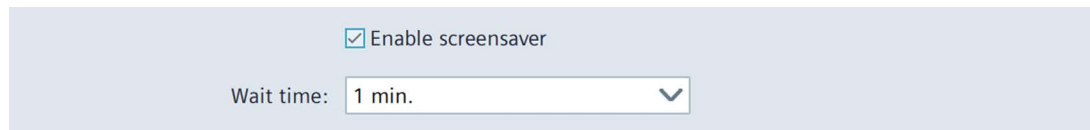

- "Enable screensaver": Select this option to activate the screensaver. Default setting: "deactivated".
- "Wait time": Time to activate the screensaver, value range 1 to 120 minutes. Default setting is "1 min."

The screensaver is automatically activated if the HMI device is not operated within the specified period of time.

Brightness of screensaver

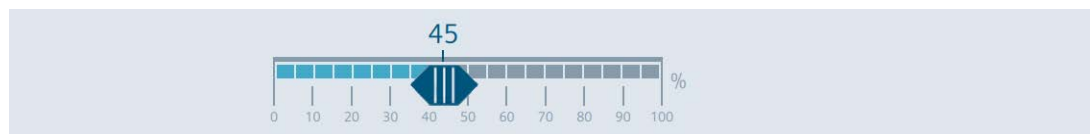

Use the slider to set the desired display brightness of the screensaver, value range 0 to 100%. Default setting is "30 %".

To deactivate the screensaver, tap the touch screen briefly. For safety reasons, this touch is not evaluated as an operator action. Therefore, no unintentional functions can be triggered.

The screensaver is also deactivated when the HMI device is accessed remotely, for example, via SmartClient or the configuration PC.

5.3.4 Update OS

The firmware and operating system version of the HMI device must be compatible with the firmware and operating system version of the installed WinCC software. If this is not the case, then you must update the operating system.

Use "Update OS" to update the operating system of the HMI device. The operating system is contained in several firmware files. The master file has the extension ".fwf". The number of additional files varies; these files have the file name of the master file and a sequential number (".0", ".1", ".2", etc.) as an extension.

The "Update OS" function is available under both "System Properties" and "Service and Commissioning".

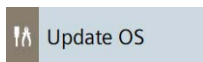
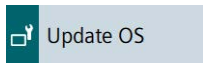

NOTICE

Updating the operating system deletes data on the HMI device

Project, parameter sets and user administration will be deleted when you update the operating system on the HMI device.

Before updating the operating system, backup the data on the HMI device, if necessary.

All settings, except the following settings which you changed in the Control Panel before updating the operating system, are retained even after the update of the operating system:

- The external interfaces become activated again (default setting), see section "Hardware interfaces (Page 122)".
- The time zone is reset to the default setting "(UTC) Coordinated Universal Time", see section "Date and time (Page 123)".
- The credentials for connected network drives must be entered again, see section "Network drive (Page 103)".

NOTICE

Automatic backup and updating the operating system

When the "Automatic backup" function is activated while the operating system is being updated, the HMI device may not start up again correctly.

If you want to update the operating system of the HMI device and have activated the "Automatic backup" function, follow these steps:

1. Deactivate the "Automatic backup" function.
2. Update the operating system.
3. Activate the "Automatic backup" function.

Leave the system memory card in the HMI device before and during the entire update.

Use a SIMATIC SD memory card with 32 GB or more or an industrial USB flash drive to load the firmware.

Firmware files for the HMI devices can be downloaded from the Internet (<https://support.industry.siemens.com/cs/ww/en/view/109746530>). Observe the documentation included with the download.

Note**Do not rename firmware files**

If you change the name of the firmware files, the operating system can no longer be updated with these firmware files. The firmware files become unusable. Leave the name of the firmware files unchanged.

Note**Copy firmware files completely**

If you copy the firmware files, be sure to also copy the master file ".fwf" together with all associated firmware files (".0", ".1", ".2", etc.).

If one of the files is missing, the operating system cannot be loaded.

Alternatively to the "Update OS" function in the Control Panel, you can use the "Update OS" function in WinCC.

Panel Information

Device type:	<input type="text" value="MTP1500 Unified Comfort"/>
Image version:	<input type="text" value="V18.00.00.01_04.01"/>

- "Device type": HMI device type designation.
- "Image version": Version of the firmware and operating system.

Select storage media for OS update

<input type="text" value="X61 (Size:7.6 GB/Free:5.04 GB)"/>	▼
---	---

Use the selection list to select the storage medium on which the firmware file is located.

Firmware files on external storage

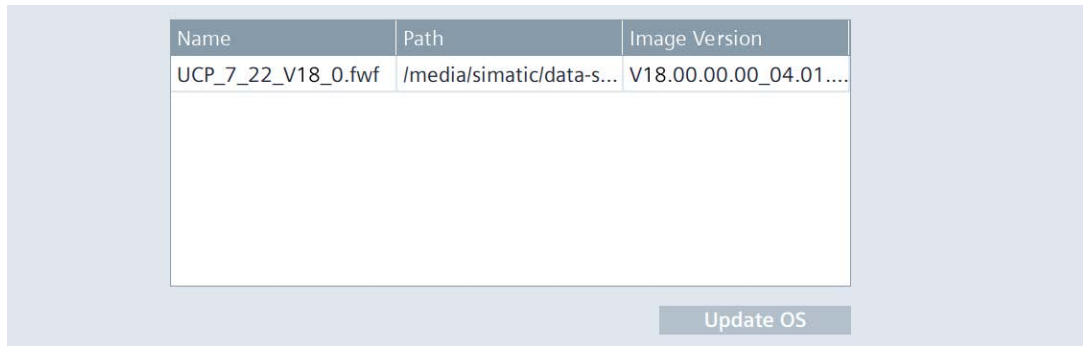

- The list shows all firmware files that can be loaded into the HMI device. Select the desired firmware master file (.fwf) from the list.
- "Update OS": Button for starting the loading process. The HMI device restarts after the "Update OS" button is pressed. The loading process then begins. A dialog with a progress bar is displayed on the HMI device for each firmware file. The HMI device is restarted again after the completion of the loading process. The main window of the Control Panel is displayed after the restart. The operating system on the HMI device is updated.

5.3.5 Reboot

You can restart the HMI device manually under "Reboot". The restart can be carried out normally or in maintenance mode.

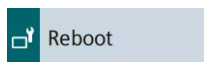

In the following cases the HMI device is automatically restarted after confirmation:

- You have made changes to the PN-X1 interface under "Ethernet parameters Port 1" or "Ethernet parameters Port 2", see section "PN-X1 (Page 97)".
- You have made changes under "General network settings", see section "General (Page 101)".
- You have switched the "Enable alarm buffer" option, see section "Alarm buffer (Page 92)".

A manual restart of the HMI device is required in the following case:

- You have changed the interface parameters under "Media redundancy" in the configuration and loaded the project to the HMI device again.

NOTICE**Data loss**

All volatile data is lost with a restart.

Make sure that no project is running on the HMI device and no data is being written to the flash memory.

Reboot panel

By carrying out this function panel will be restarted

Reboot panel

"Reboot panel": Button for a simple restart of the HMI device ("soft reboot").

Reboot in maintenance mode

By carrying out this function panel will be restarted and booted in device maintenance mode

Reboot in maintenance mode

"Reboot in maintenance mode": Button for a restart in maintenance mode. The restart in maintenance mode is required to reset the HMI device to factory settings.

The HMI device restarts after the "Reboot in maintenance mode" button is pressed. The "Maintenance Mode" dialog box is displayed for a period of 10 minutes. In this period you can connect the HMI device to a configuration PC and reset the HMI device to factory settings with the ProSave software.

See also

Resetting an HMI device to factory settings via ProSave (Page 158)

5.3.6 Performance

Under "Performance" you can activate the monitoring of the internal flash memory.

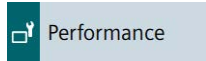

Flash Memory Monitoring Section



"Show Alarm if life of flash memory is reducing fast": Option to activate flash memory monitoring. The default setting is "activated".

If the option is activated, the state of the flash memory is checked cyclically. If the cyclical check results in a high load on the flash memory, the message "Flash memory life time reducing fast" is displayed regularly.

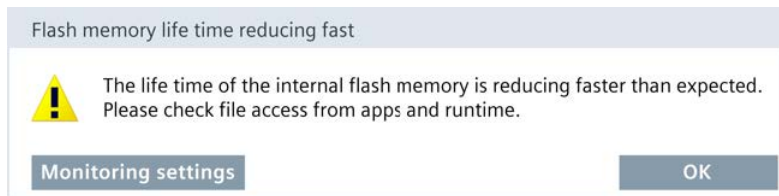

- "Monitoring Settings": Button for opening the "Performance" settings in the Control Panel. Press the button, note the cause specified under "Source" and contact the corresponding administrator or project engineer.
- "OK": Button for acknowledging the alarm.

Last alarm

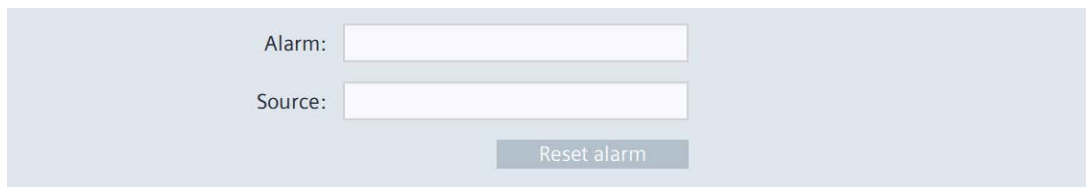

- "Alarm": Display panel with the last alarm that was displayed about the status of the flash memory.
- "Source": Display field with information on the cause of the last alarm. Pass this information on to the administrator or project engineer, who can change the settings in the corresponding app or the configuration of the HMI device so that the "Flash memory life time reducing fast" alarm no longer appears.
- "Reset alarm": Button for deactivating the regularly occurring "Flash memory life time reducing fast" alarm. The button can only be operated by users with the "Control Panel Administrator" authorization. After pressing the button, the "Flash memory life time reducing fast" alarm is only displayed again when the next cyclic check results in a high load on the flash memory.

5.3.7 Taskbar

Under "Taskbar", you specify whether the taskbar is displayed on the HMI device and at which position.

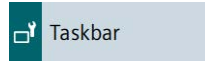

General Settings

Enable taskbar

"Enable taskbar": Option to enable or disable the taskbar. The default setting is "enabled".

Position of taskbar

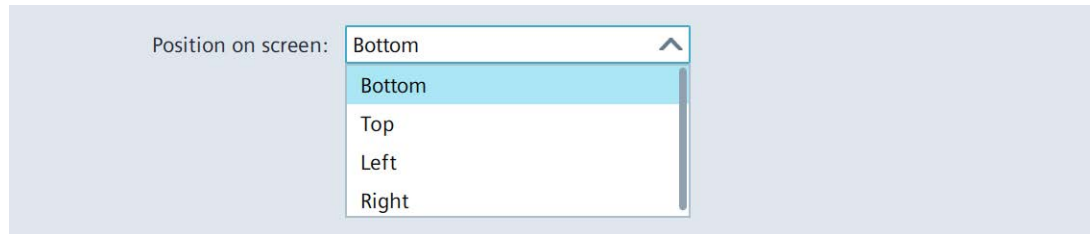

"Position on screen": Drop-down list to specify the position of the taskbar on the display. The drop-down list is only active when the "Enable taskbar" option is selected.

Selection options:

- "Bottom": The taskbar is displayed at the very bottom on the display.
- "Top": The taskbar is displayed at the very top on the display.
- "Left": The taskbar is displayed at the very left on the display.
- "Right": The taskbar is displayed at the very right on the display.

Default setting is "Bottom".

5.3.8 Event Logger

The "Event Logger" function gives you the option of recording complete runtime operating scenarios on a storage medium.

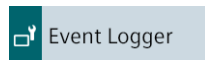

The recorded data includes all "tracing" information, screen contents, screen changes and operator actions. The recorded data can be used, for example, to analyze the cause of errors by the Technical Support.

General Settings



- "Enable Event logger": Option to enable or disable the "Event Logger" function. The default setting is "deactivated".
- "Storage Medium": Storage medium on which the recorded data is saved (USB storage medium or SD card).

Starting and stopping the recording

1. Connect an external storage medium to the HMI device.

Note

The external storage medium must be connected to the HMI device before the "Event Logger" function is enabled.

2. Select the storage medium for the recording under "Storage Medium".
3. Select the "Enable Event logger" option.
4. If a project is still running on the HMI device, close Runtime.
5. Start Runtime. The following data is included in the recording:

- All "tracing" information
- All screen contents and screen changes
- All operator actions

The recorded data is stored encrypted in a file in the root directory of the storage medium.

Syntax for the file name of a recording: "telemetry_<date>_<time>_<id>"

- <date>: Date in the format "yyyymmdd" (year, month, day)
- <time>: Time in the format "hhmmss" (hour, minute, second)
- <id>: Unique number for the recording

Depending on the amount of data recorded, a recording can be comprised of multiple files.

Recording is ended if the storage space on the storage medium is insufficient for the recording. Make sure that enough free storage space is present on the storage medium.

6. To stop the recording, clear the "Enable Event logger" option.

Switching to another storage medium

If multiple storage media are connected to the HMI device and you want to continue recording on a different storage medium, proceed as follows:

1. Clear the "Enable Event logger" option.
2. Select another storage medium under "Storage Medium".
3. Select the "Enable Event logger" option.
4. Start Runtime.

See also

Trace forwarder (Page 136)

5.4 Runtime Properties

5.4.1 Project information

Under "Project information" you can view the project-specific information that uniquely identify the project on the HMI device.

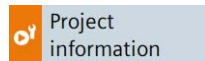

Project information

Name:	Line 1 Station 1
Device name:	HMI_RT_1
Project ID:	fc949e4a-aaf1-493d-8d6e-01e9883052ae

- "Name": Name of the project is equivalent to the name of the project in WinCC (TIA Portal).
- "Device name": Automatically generated name of the runtime project on the HMI device.
- "Project ID": Unique identification of the runtime project is equivalent to the "Runtime ID" of the project in WinCC (TIA Portal).

5.4.2 Automatic runtime start

Under "Automatic runtime start" you define whether the project on the HMI device starts automatically or not after a defined delay time.

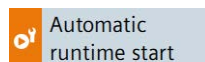

Automatic runtime start

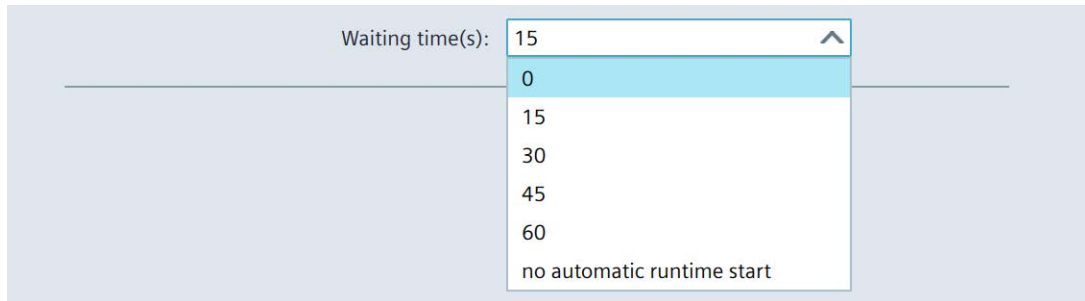

"Waiting time(s)": Drop-down list for determining whether the project on the HMI device starts automatically after a specified delay time or not.

Selection options:

- "0": The project is started directly after the operating system.
- "15" to "60": The project starts after a delay time of 15 to 60 seconds. During the delay time, the dialog "Runtime Start" is displayed with a countdown and the following buttons:
 - "Cancel": The dialog is closed, Runtime does not start.
 - "Skip": The delay time is skipped, Runtime is started.
- "no automatic runtime start" (default setting): The project is not started automatically, but via the "Start Runtime" button in the Control Panel.

Starting Runtime

While Runtime starts on the HMI device, the dialog box "Runtime Start" is displayed with an initialization message. The Control Panel cannot be operated while Runtime is starting.

Note

Once the project has started, you have the following options to open the Control Panel:

- Via the taskbar (Page 65).
 - Via an operating element for which the "ShowControlPanel" or "StopRuntime" function has been configured.
-

5.4.3 Alarm buffer

Under "Alarm buffer" you can activate or deactivate the retentive alarm buffer. The default setting is "deactivated".

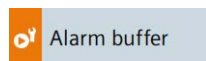

Note

Back up data before deactivating the retentivity

When you deactivate the retentivity of the alarm buffer and still need the data in the alarm buffer, back up this data before deactivating the retentivity in a log.

Alarm buffer configuration

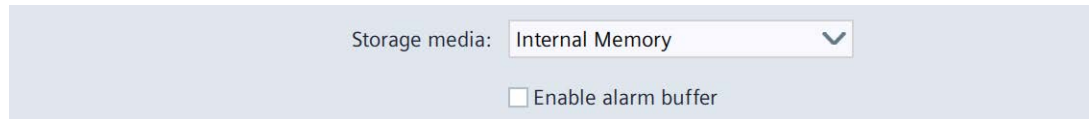

- "Storage media": Selection list for defining the storage medium for the retentive alarm buffer. Selection options:
 - "Internal Memory": Alarms are written to the internal flash memory.
- "Enable alarm buffer": Option to enable or disable the retentive alarm buffer. The default setting is "deactivated".

When the retentivity of the alarm buffer is activated, the retentive alarm data is backed up every two seconds to the selected storage medium. With a high number of alarms, the storage medium is subject to an equally high number of read and write cycles.

If the retentivity of the alarm buffer is deactivated, the alarm buffer is emptied and the retentive alarm data is no longer backed up to the selected storage medium. This means the storage medium is used less with a high number of alarms.

Switching the "Enable alarm buffer" option requires a restart, the "Enable alarm buffer" dialog is displayed. Restart the system using the "OK" button.

5.4.4 Web client

Under "Web client", you can enable web-based client access to the runtime project. Operator control in runtime via a client is asynchronous, that is, the display content of the server does not change while the client is operating in runtime.

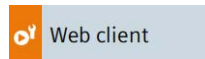

Web client configuration



- "Enable web access to runtime": Option to enable web access to the runtime project.

Web access to the runtime project

When web access is enabled, you can access the runtime project via a browser, see section "Web access to the HMI device (Page 71)".

For more information on remote access via "Web client", refer to the TIA information system under: "Visualizing processes (RT Unified) > Configuring remote access > Web client".

5.4.5 Load project from storage

Under "Load project from storage", you can load into the HMI device a project that was backed up on an external storage medium in WinCC (TIA Portal).

You generate the necessary project data in WinCC by configuring the HMI device and then using drag-and-drop to move the folder of the HMI device (e.g. "HMI_1 [<DeviceType>]") to an external storage medium ( icon) under "Card Reader/USB memory".

Recommendation: The Runtime and firmware versions of the project should match those of the HMI device.

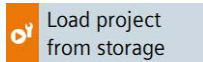

Select storage media for project transfer



Select the storage medium on which the backed-up project is stored.

Projects on external storage

Project Name	Device Type	RT Version
HMI_RT_1[Line 1 Station 1]...	MTP1500 Unified Comfort	18.0.0.0
HMI_RT_1[Line 1 Station 2]...	MTP1900 Unified Comfort	18.0.0.1
HMI_RT_1[Line 2 Station 1]...	MTP2200 Unified Comfort	18.0.1.1

- The list includes all projects that are located on the external storage medium.
- "Show details": Button for displaying additional information on a selected project.
- "Load project": Button for loading the selected project.

Displaying details and checking compatibility

If you have selected a project you can use the "Show details" button to display more information about the selected project and check whether the project can be loaded into the HMI device.

The screenshot shows a dialog box titled "Project details" with the following fields:

Name:	Line 1 Station 1
Device:	HMI_RT_1
RT Version:	18.0.0.0
Project path:	/media/simatic/X61/Simatic.HMI/RT_Projects/HMI_RT_1[Line 1 Station 1] - Full 2022-11-22 - 11.11.11.zip
Project ID:	fc949e4a-aaf1-493d-8d6e-01e9883052ae
Date created:	22/11/2022 11:11:11
Size:	4419 Kbs
Compatibility:	Compatible

A "Close" button is located at the bottom right of the dialog box.

- "Name": Name of the project.
- "Device": Name of the HMI device in the project.
- "RT Version": Runtime version of the project.
- "Project path": Path of the project on the external storage medium.
- "Project ID": Unique identification of the runtime project is equivalent to the "Runtime ID" of the project in WinCC (TIA Portal).
- "Date created": Date on which the project in WinCC (TIA Portal) was saved to a storage medium.
- "Size": Size of the project on the storage medium.
- "Compatibility": A message about the compatibility of the project and the HMI device is displayed in this output field. Depending on the degree of compatibility, the message is highlighted in color.

The following messages can be displayed in the "Compatibility" output field:

- The message "Compatible": Project and HMI device are compatible, the project can be loaded without any problem.
- Messages of the "Warning" type highlighted in orange: Firmware and/or runtime version of project and HMI device differ. The versions are compatible, an "Upgrade" or "Downgrade" is optional. The project can be loaded.
- Messages of the "Error" type highlighted in red: The project cannot be loaded for one of the following reasons.
 - Project and device type are incompatible, i.e. the project was created for a different device type. To load the project, replace the device in WinCC.
 - Firmware and/or Runtime version of project and HMI device are incompatible, an "Upgrade" or "Downgrade" is required. To load the project, update the operating system of the HMI device.

You can find information on updating the operating system at the end of this section and under "See also".

Load project

The "Load preview" dialog is displayed via the "Load project" button.

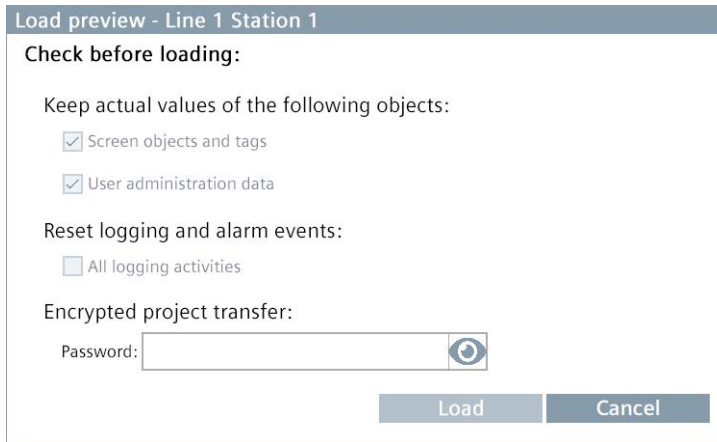

- Under "Keep actual values of the following objects", you specify whether the process values of the following objects are to be retained:
 - "Screen objects and tags": Option for keeping the process values of screen objects and tags on the HMI device.
 - "User administration data": Option for keeping the user management on the HMI device.

Under "Reset logging and alarm events", you specify whether data in logs and alarm events are to be deleted:

- "All logging activities": Option for deleting all logs and alarm events.

The "Encrypted project transfer" area is displayed when encrypted transfer is enabled for the selected project. In this case, enter the password that was set in WinCC for the encrypted transfer.

- The "Load" button loads the project into the HMI device, taking the selected settings into account.
After the loading process, you can start the project via the "Start Runtime" function on the HMI device.

Activation of the options that are currently grayed out is envisaged in a later firmware version.

See also

Update OS (Page 126)

Updating the operating system (Page 155)

5.5 Network and Internet

5.5.1 Network settings

5.5.1.1 Overview

Under "Network settings", you change settings for the network and for the network interfaces X1 and X2. Both interfaces support PROFINET basic services.

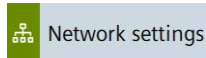

The following buttons take you to the corresponding settings.

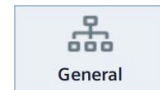

- "PN-X1": Settings for X1 interface (Page 97)
- "PN-X2": Settings for X2 interface (Page 99)
- "General": General settings (Page 101)

The settings under "Network settings" are retained after a restart or update of the operating system.

In the following cases, the settings under "Network settings" are not retained:

- If the HMI device is reset to factory settings, all settings will be reset to their default values.
- When a project with changed network settings is loaded to the HMI device, the values from the project are applied.

5.5.1.2 PN-X1

Under "PN-X1" you define the parameters for the X1 interface and both X1P1 and X1P2 connections.



PROFINET

Device name:	<input type="text" value="mtp1500.x1"/>
Converted name:	<input type="text" value="mtp1500.x1"/>
MAC address:	<input type="text" value="08-00-06-00-02-b0"/>

- "Device name": PROFINET name of the interface may not contain any spaces and must be unique in the local network.
- "Converted name": Display field with the PROFINET name of the interface, contains the entry under "Device name", automatically converted according to PROFINET naming conventions.
- "MAC address": Display field with the MAC address of X1 interface of the HMI device.

IP address

- "Specify an IP address": Option to manually assign the IP address.
- "IP address": IP address of X1 interface for the X1P1 and X1P2 ports. The IP address must be unique in the local network. If this is not the case, the IP address of the HMI device is automatically set to the value "0.0.0.0". The IP addresses of X1 and X2 interfaces must be located in different subnets.
- "Subnet mask": Subnet mask for the IP address of X1 interface.
- "Default gateway": IP address of the gateway (router) if several different local networks are used.
- "Set IP address": Button for saving the specified IP address parameters.

Ethernet parameters Port 1, Ethernet Parameters Port 2

- "Activate this port for use": Option to activate or deactivate the X1P1 or X1P2 ports. The default setting is "Activated".
- "Mode and speed": List for selecting the transmission type and transmission rate for the interface; selection options: "Automatic" (default setting) or "100Mbps / FDX" (100 Mbps, full-duplex). Use the default setting "Automatic" preferably.
- "Boundaries":
 - "End of detection of accessible nodes": DCP frames for detecting accessible nodes are not forwarded. Nodes located beyond this interface are no longer accessible.
 - "End of topology discovery": LLDP frames for topology discovery are not forwarded.

Changes under "Ethernet parameters Port 1" and "Ethernet parameters Port 2" require a restart, the "PROFINET Port Settings" dialog box is displayed. Restart the system using the "Restart" button.

5.5.1.3 PN-X2

Under "PN-X2" you define the parameters for the X2 interface.



PROFINET

Device name:	<input type="text" value="mtp1500.x2"/>
Converted name:	<input type="text" value="mtp1500.x2"/>
MAC address:	<input type="text" value="08-00-06-00-00-b0"/>

- "Device name": PROFINET name of the interface may not contain any spaces and must be unique in the local network.
- "Converted name": Display field with the PROFINET name of the interface, contains the entry under "Device name", automatically converted according to PROFINET naming conventions.
- "MAC address": Display field with the MAC address of X2 interface of the HMI device.

IP address

Obtain an IP address via DHCP
 Specify an IP address

IP address:	<input type="text" value="169.254.139.199"/>
Subnet mask:	<input type="text" value="255.255.0.0"/>
Default gateway:	<input type="text"/>

- "Obtain an IP address via DHCP" (default setting): Option to automatically assign the IP address via the DHCP server.
- "Specify an IP address": Option to manually assign the IP address.
- "IP address": IP address of the X2 interface. The IP address must be unique in the local network. The IP addresses of X2 and X1 interfaces must be located in different subnets.
- "Subnet mask": Subnet mask for the IP address of X2 interface.
- "Default gateway": IP address of the gateway (router) if several different local networks are used.
- "Set IP address": Button for saving the specified IP address parameters.

Note

When you select the option "Specify an IP address via DHCP", this setting is not overwritten when the project is loaded. When you select the option "Specify an IP address", you can also configure the network address in the WinCC device configuration and load it to the HMI device together with the project.

Ethernet parameters Port

☑ Activate this port for use

Mode and speed: Automatic

- "Activate this port for use": Option to enable or disable the port. The default setting is "Activated".
- "Mode and speed": List for selecting the transmission type and transmission rate for the port.

Selection options:

- "Automatic" (default setting)
- "10Mbps / HDX" (10 Mbps, half duplex)
- "10Mbps / FDX" (10 Mbps, full duplex)
- "100Mbps / HDX" (100 Mbps, half duplex)
- "100Mbps / FDX" (100 Mbps, full duplex)

Use the default setting "Automatic" preferably.

Name servers

Name server address may be automatically assigned if DHCP is enabled on this adapter.

Primary DNS:

Secondary DNS:

- "Primary DNS": Address of the DNS server.
- "Secondary DNS": Address of the secondary DNS server.

If you have activated the "Obtain an IP address via DHCP" option under "IP address", the specifications under "Name servers" are optional.

5.5.1.4 General

You define the general network parameters under "General".

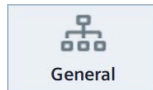

General network settings

Enable simple network management protocol (SNMP)

- "Enable simple network management protocol (SNMP)": Option to enable or disable the Simple Network Management Protocol for data transmission. The default setting is "enabled".

Note

Disabling this option increases the information security because less information is exchanged with other devices in the network.

5.5.2 Remote connection

Change the settings for remote access to the HMI device under "Remote connection". You can define two passwords for remote access, for example, a password for the "Operate" right and a password for the "Monitor" right. Operator control in the Control Panel or in runtime is synchronous, that is, the display content of the server changes at the same time as the display content of the client.

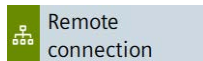

Change the settings under "Remote connection" only if no client is connected to the SmartServer, because changing the settings disconnects all client connections.

Smart Server

Enable Smart Server

"Enable Smart Server": Option to activate or deactivate the SmartServer on the HMI device. The default setting is "deactivated". This option can only be activated if two different passwords have been set under "Users".

If the SmartServer is started on an HMI device, you can access the HMI device via the SmartClient application or a VNC client, such as Tigervnc. Depending on the settings under "Users", the client can operate or monitor the server device.

Note

Depending on the bandwidth of the connection and the number of connected clients, the performance on the clients may be different than the performance on the SmartServer.

Each client that connects to the SmartServer and operates or monitors the runtime project, uses resources on the SmartServer device. For high performance and low consumption of resources, you should have as few clients as possible connected to the SmartServer at the same time.

Users

In this area you define the passwords and access rights for two users. The passwords of the two users must not be identical. Several users can access the SmartServer simultaneously via one password.

- "Password for user1": First password for access to the HMI device. Default setting: "empty".
 - "User1 is allowed to remote control the panel": Option to activate the "Operate" right for a user who logs in with password 1. The default setting is "deactivated".
- "Password for user2": Second password for access to the HMI device. The password must be different from the "Password for user1". Default setting: "empty".
 - "User2 is allowed to remote control the panel": Option to activate the "Operate" right for a user who logs in with password 2. The default setting is "deactivated".

Password guidelines for the SmartServer

The passwords under "Users" must have a length of **exactly 8 characters** and include the following characters:

- At least one capital letter (A - Z)
- At least one lowercase letter (a - z)
- At least one number (0 - 9)
- At least one special character (! \$ % & () * + , - . / : ; < = > ? @ [\] _ { | } ~ ^)

Communication

- "Secure communication via self-signed certificate": Option to enable secure communications via SSL encryption. Default setting: "activated". Client access is only possible if the client application supports SSL encryption. For access via the SmartClient application, this option must be cleared.
- "Port Configuration"
 - "Automatic" (default setting): Option to enable automatic port assignment. The default value "5900" for the port number remains unchanged.
 - "Manual": Option to enable manual port assignment.
- "Port for access from desktop application": Port number for access via the SmartClient application. Default value is "5900".

5.5.3 Network drive

Under "Network drive", you manage a network drive that can be accessed by the HMI device.



The network drive must be on a server PC in the subnet of the HMI device and be enabled for access. The operating system of the server PC must support the network protocol SMB 3.0.

You can use a network drive only for the data exchange between the server PC and HMI device.

This means that a network drive **cannot** for example, be used for the following functions:

- Updating, backing up and restoring the operating system
- Transferring a project
- Importing user management from a file or exporting it to a file
- Runtime functions, for example, logging or reporting
- Importing certificates

Network Drive



- The following buttons with the following functions are located above the list:
 - "Add": Add network drive
The "Add" button is disabled as soon as a network drive is entered in the list.
 - "Edit": Edit the properties of a network drive
 - "Remove": Disconnect network drive
 - "Refresh": Refresh the status of the network drive
The entries in the "Status" column are displayed for about 60 seconds. By using the "Refresh" function you import the latest status information again.
- The following properties of the network drive are displayed in the list:
 - "Network Path": Path of the network drive
 - "User Name": User name used to connect to the network drive
 - "Local Path": Local path for accessing the network drive, for example, "/net/mount"
 - "Status": Information on the connection status of the network drive, see paragraph "Status alarms" at the end of the section.

Note

"Reboot" and "Update OS"

The network drive remains in the list after a restart of the HMI device.

When updating the operating system, the entries under "Network Path" are retained, the credentials "Username" and "Password" must be entered again for security reasons.

Add network drive

1. Press "Add" to open the "Network Drive Parameters" dialog.

The screenshot shows a dialog box titled "Network Drive Parameters". It contains three text input fields: "Network Path:", "Username:", and "Password:". The "Password:" field has a small circular icon with an eye to its right, used for toggling password visibility. At the bottom of the dialog are two buttons: "OK" and "Cancel".

The maximum permissible number of characters in the three input fields is 255.

The input fields "Network Path" and "Username" are mandatory fields; the following characters are permitted in these input fields:

- Capital letters (A - Z)
- Lowercase letters (a - z)
- Numbers (0 - 9)
- Special characters (_ . -)

The special character */* is permitted for the input field "Network Path".

The special character ** is permitted for the input field "Username".

The input field "Password" does not have any character restrictions.

2. Under "Network Path", enter the path to an enabled network drive in the subnet of the HMI device.

Syntax: `\\<IP address of the server PC>\<Enable name of the network drive>`

Example: `\\169.254.139.190/mounttest`

Always use the IP address; specification of the computer name is not supported.

3. Under "Username" and "Password", enter the credentials of a user who has access to the network drive.

Use the following button to make the password visible for the display duration of the dialog:



4. Confirm your entries with "OK".

The "Network Drive Parameters" dialog box closes.

When the connection was set up successfully, the "Connected" information is displayed in the "Status" column of the "Network Drive" list.

When the connection could not be set up, the "Failed" information is displayed under "Status". In this case, check the connection to the server PC and the enable properties of the network drive.

Status messages

The following table shows the status messages, their meaning and the possible remedy in case of errors.

Status message	Meaning	Remedy
Connecting	The connection to the network drive is being established.	-
Connected	The network drive was successfully connected.	-
No such file or directory	The path specified under "Network Path" does not exist.	Make sure that the specified network path exists and check the spelling in the input field "Network Path".
Authentication failed	The credentials are incorrect.	Make sure that the specified user has access to the network drive. Check the spelling in the input fields "Username" and "Password".
Input/Output error	Unable to connect the network drive.	Check the connection between PC and HMI device. Establish the connection to the network drive again.
Timeout	There are synchronization problems with the added network drive.	Check the connection between PC and HMI device. Try to connect the network again with "Edit" and "OK".

5.6 Security

5.6.1 User management

A convenient user management is available to you under "User management". The user management is configured in WinCC, transferred to the HMI device and managed on the HMI device.

Web access is also available for user management, see "Web access to the HMI device (Page 71)". Note that the functions for RFID assignment are not available via web access.

Note

Important information on the configuration and project transfer

- If you do not assign a user a role or a role and no function right in the configuration, the user or the role is not loaded to the device.
In WinCC, configure all roles required on the HMI device with all function rights required on the HMI device. Assign each role required on the HMI device to at least one user.
- To transfer the user management from WinCC to the HMI device, the option "Keep current user management data in runtime" must be **disabled** in the "Load preview" dialog during project transfer (Page 149).

You can find detailed information on the configuration in the TIA information system under "Visualizing processes (RT Unified) > Configuring users and roles (RT Unified)".

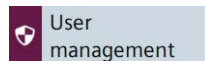

The complete user list is only visible and editable for users who have been assigned the "User management" function right in the configuration.

Users with other function rights see their own entry in the user list and should only use the buttons in the "Current user" area.

When password protection is enabled for the Control Panel, only users with the "Control Panel access" function right can access the Control Panel.

The password guidelines are specified during configuration. The function rights of a user are valid for the Control Panel as well as for the runtime software.

Current user

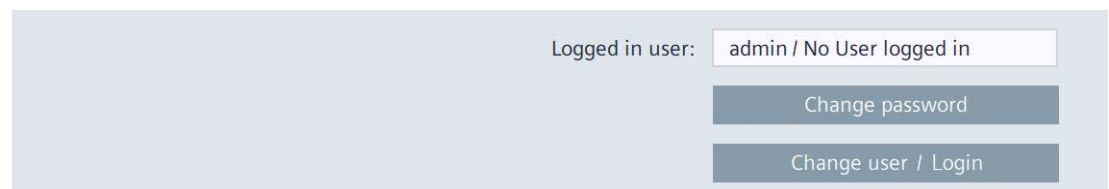

- "Logged in user": Displays the login name of the user currently logged in. If no user is logged in yet, then "No User logged in" is displayed.

- "Change password": Button to change the password for the user currently logged in. After pressing the button, the "Change password" dialog is displayed.

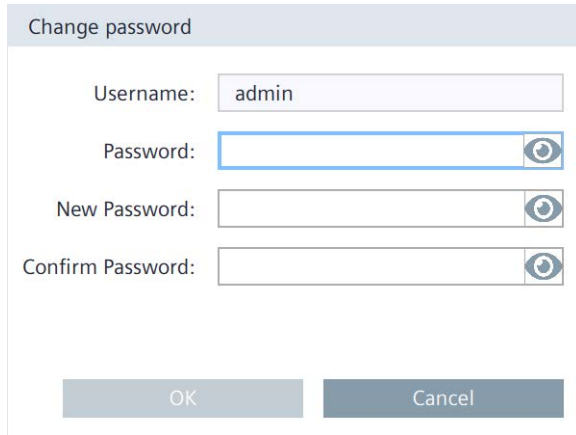

The "Change password" dialog box features a title bar with the text "Change password". Below the title bar, there are four input fields: "Username:" with the value "admin", "Password:", "New Password:", and "Confirm Password:". Each password field has a small eye icon to its right, which is currently closed. At the bottom of the dialog, there are two buttons: "OK" and "Cancel".

Enter the previous password once and the new password twice. The following button can be used to make the passwords visible for the display duration of the dialog box:



- "Change user": Button for changing the current user.
"Login": Button for logging in a user.

After pressing the button, the "User Login" dialog is displayed.

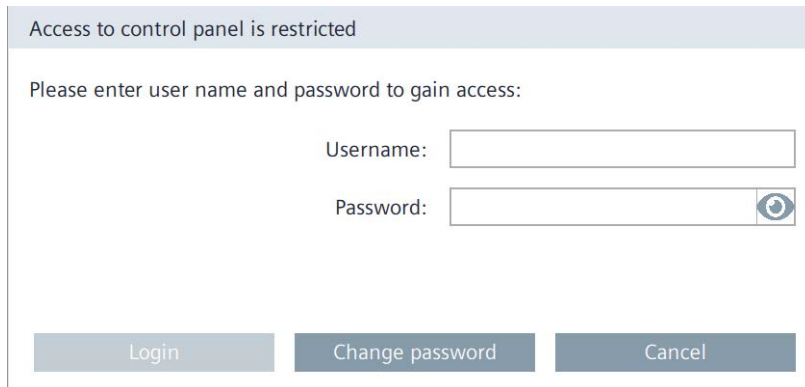

The "User Login" dialog box has a title bar that reads "Access to control panel is restricted". Below the title bar, it says "Please enter user name and password to gain access:". There are two input fields: "Username:" and "Password:". The "Password:" field has an eye icon to its right. At the bottom, there are three buttons: "Login", "Change password", and "Cancel".

Enter the desired login name with the associated password and log in using the "Login" button.

Note

Number of login attempts

The number of login attempts is 19. After 19 failed attempts, the user involved is locked out on the next attempt. The user must be deleted and recreated, or you must reload the User Management into the HMI device.

Ensure you enter the login credentials correctly.

Alternatively, you can log in via an RFID card if your user has been assigned an RFID login. Hold the RFID card just in front of the RFID reader and input your PIN if required.

Users

Name	Role	Maximum session tim...	RFID	PIN	Comment
dieter	HMI Administrator;HMI Operator	30 min	YES		
admin	HMI Administrator	30 min	YES	YES	
hans	HMI Operator	30 min			

- The following buttons with the following functions are located above the user list:

	Create a new user.
	Edit data of the user currently selected in the list.
	Delete the user currently selected in the list.
	Assign an RFID login to the user currently selected in the list. ¹
	Delete the RFID assignment for the user currently selected in the list. ¹
	Import complete user management from a ".json" file on an external storage medium. ² Note: Import completely overwrites the user management on the HMI device.
	Export complete user management to a ".json" file on an external storage medium. ²

¹ Only use this button if you have the "User management" function rights.

² For importing and exporting the user management, the "User management" function right is required; the "Importing and exporting users" function right, which can be configured in WinCC, is not required.

- The user list displays the users available on the HMI device with the following user characteristics:
 - "Name": Login name of the user.
 - "Role": Roles assigned to the user.
 - "Maximum session timeout": This value indicates the number of minutes after which the user is automatically logged off if they no longer perform any operator action. Value range: 0 to 600 minutes (0 = automatic logout disabled).
 - "RFID": Information whether the user has been assigned an RFID card. "YES" means: RFID card assigned.
 - "PIN": Information whether a PIN has been assigned to the user for the RFID login. "YES" means: PIN assigned.
 - "Comment": Comment text for the user.

Note

You cannot edit or delete yourself as a user.

To ensure that at least one user with the "User management" function right remains on the HMI device, users cannot edit or delete themselves. A second user with the "User management" function right is required for this purpose.

Note

Maximum session timeout

In the Engineering System, you can configure a maximum session duration for a role as well as for a user. If these values differ, only the smaller of the two values is transferred to the Panel during loading.

Creating or editing users

The editing functions are only available for users who have been assigned the "User management" function right in the configuration.

Use the following button to create a new user:



With the following button you edit the data of a user:



After pressing one of the two buttons, the dialog "Add user" or the dialog "Edit user" is displayed. Both dialog boxes are identical in content.

The following figure shows an example of the "Edit user" dialog box.

The screenshot shows a dialog box titled "Edit user". It contains the following fields and controls:

- Login user name:
- Role: (dropdown menu)
- Password: (with eye icon for visibility)
- Confirm password: (with eye icon for visibility)
- Maximum session timeout:
- Enable authentication via RFID card
- PIN required for authentication with RFID card
- PIN:
- Comment:

At the bottom right, there are two buttons: "Edit user" and "Cancel".

- "Login user name": Display field with the login name of the user.
- "Role": Drop-down list for assigning the user to one or more roles. The roles are defined in the WinCC project for the HMI device and assigned the corresponding function rights.
The following system-defined roles are always transferred to the HMI device:

Role designation	Authorization in the Control Panel	Authorization in Runtime
HMI Operator	-	Web access, Operate, Monitor
HMI Monitor	-	Web access, Monitor
HMI Monitor Client	-	Web access, monitoring without influencing the processes in the controller
HMI Administrator	User management, Import and export users, Control panel access	Remote access, Monitor, Operate, Web access

The drop-down list also contains the configured roles that were transferred from the WinCC project to the HMI device.

Note

The HMI role "HMI Monitor Client" is superior to all other roles and their function rights. A user to whom the role "HMI Monitor Client" is assigned gets the function rights of only that role. Any superior function rights of other roles that are assigned to the user will be lost.

You can find detailed information on users, roles and function rights in the TIA Portal Information System.

- "Password": Text box for the password of the user. If you do not enter anything, the user's existing password remains unchanged.
- "Confirm password": Text box for confirming the password.
- "Maximum session timeout": This value indicates the number of minutes after which the user is automatically logged off if they no longer perform any operator action.
Value range: 0 to 600 minutes (0 = automatic logout disabled).
- "Enable authentication via RFID card": Option to enable the RFID login for the user.
- "PIN required for authentication with RFID card": Option for activating 2-factor authentication with PIN for RFID login.
- "PIN": Text box for the PIN. Only digits are allowed, the maximum length is 6 digits.
- "Comment": Note on changing the user.
- "Edit user" or "Add user" Button for saving the user.
- "Cancel": Button for discarding the changes.

Peculiarities with RFID login

Take into consideration the following notes in conjunction with the RFID login:

- The RFID login only works with an RFID reader that is directly connected to the HMI device.
- The RFID login only works for the local user management.
- You can use the RFID login both in Control Panel as well as in Runtime.

- The RFID assignments remain in place even after the operating system has been updated, provided that the currently existing users are transferred to the HMI device when the project is loaded.

RFID assignment in the "Add new user" dialog

1. Ensure that you are logged in as a user with the "User management" function rights in the Control Panel.

2. Press the "Create user" button.



3. Enter a user name under "Login user name".

4. Under "Role", select the desired authorizations for the user from the list.

5. Enter the password for the user login under "Password" and "Confirm password".

6. If necessary, change the value under "Maximum session timeout".

7. Select the "Enable authentication via RFID card" option.

8. To use the RFID login without a PIN, leave the "PIN required for authentication with RFID card" option disabled.

For 2-factor authentication, enable the "PIN required for authentication with RFID card" option and enter a code with 1 to 6 digits under "PIN".

9. Select "OK". The following dialog is displayed:

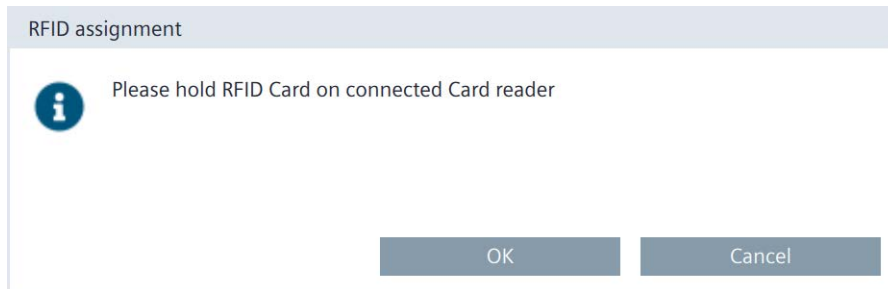

10. Select "OK". The "OK" button is shown with a colored background.

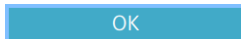

11. Take an RFID card that is not yet assigned to a user.

12. Hold the RFID card in front of the RFID reader until the following dialog is displayed:

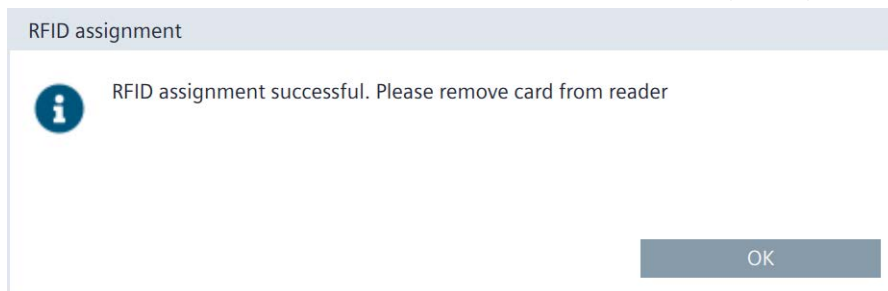

13. Remove the RFID card from the reader and select "OK".

A new user has been created and an RFID login has been assigned to the user. The user can log in by holding their RFID card briefly in front of the RFID reader.

Change the RFID assignment using the "Edit user" dialog

To change the RFID assignment of a user from the user list, follow the steps below:

1. Ensure that you are logged in as a user with the "User management" function rights in the Control Panel.
2. Select a user in the user list.
3. Press the "Edit user" button.



4. Enable or disable the "Enable authentication via RFID card" option.
5. If you have enabled the "Enable authentication via RFID card" option and want to use the RFID login without a PIN, leave the "PIN required for authentication with RFID card" option disabled. For 2-factor authentication, enable the "PIN required for authentication with RFID card" option and enter a code with 1 to 6 digits under "PIN".

Note

Changing the PIN

You can also use the "PIN" text box to change the existing PIN of the user.

6. Select "Edit user". The following dialog is displayed:

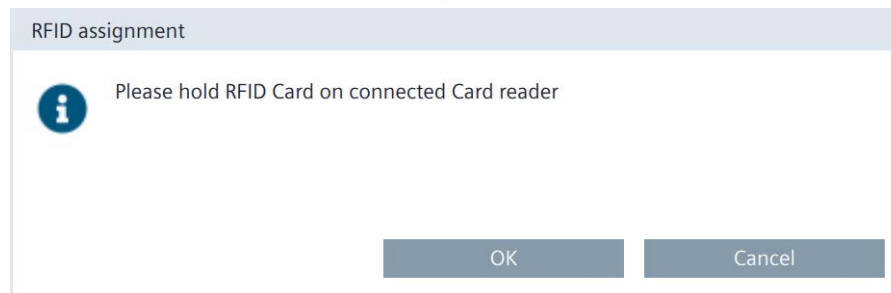

7. Select "OK". The "OK" button is shown with a colored background.

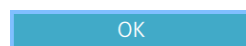

8. If the user has not yet been assigned an RFID login, take an RFID card that has not yet been assigned to a user.
If the user has already been assigned an RFID login, take the previous RFID card of this user.

9. Hold the RFID card in front of the RFID reader until the following dialog is displayed:

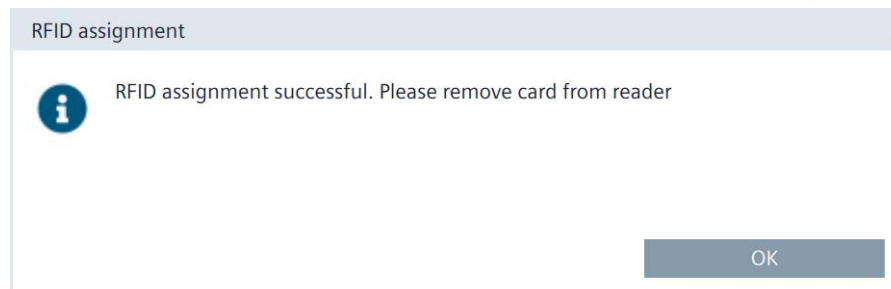

10. Remove the RFID card from the reader and select "OK".

The RFID assignment of the user has been changed.

The "Assign RFID login" button

You can also use the "Assign RFID login" button for the RFID assignment. The button only works for users who have not yet been assigned an RFID login.

Proceed as follows:

1. Ensure that you are logged in as a user with the "User management" function rights in the Control Panel.
2. Select a user in the user list to whom an RFID login has not yet been assigned.
3. Press the "Assign RFID login" button.



The "RFID assignment" dialog is displayed.

4. To use the RFID login without a PIN, leave the "PIN" text box blank. For 2-factor authentication, enter a code with 1 to 6 digits under "PIN".
5. Select "OK". The "OK" button is shown with a colored background.

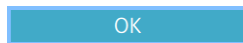

6. Take an RFID card that is not yet assigned to a user.
7. Hold the RFID card in front of the RFID reader until the following dialog is displayed:

8. Select "OK".

The RFID login has been assigned to the user. The user can log in by holding their RFID card briefly in front of the RFID reader.

The "Delete RFID assignment" button

You can also use the "Delete RFID login" button to remove the RFID assignment. The button only works for users to whom an RFID login has been assigned.

Proceed as follows:

1. Ensure that you are logged in as a user with the "User management" function rights in the Control Panel.
2. Select a user in the user list to whom an RFID login has been assigned.
3. Press the "Delete RFID assignment" button.



The "Disable authentication via RFID card" dialog box is displayed.

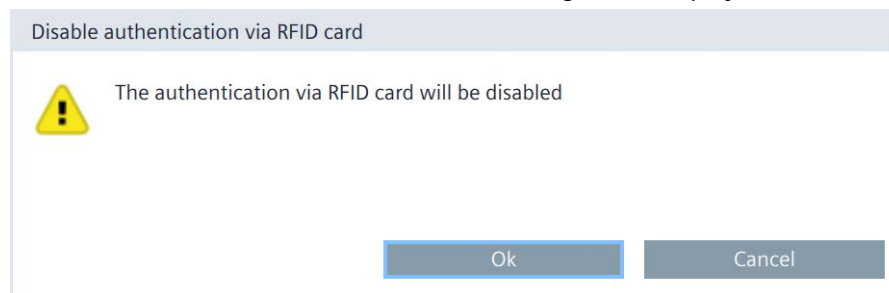

4. Select "OK".

The user can no longer log in with the RFID card.

5.6.2 Certificates

You can use this function to import, display and delete certificates and certificate revocation lists.



A digital certificate consists of structured data, which confirms ownership and other properties of a public key.

When handling certificates, note the information on Industrial Security (Page 21).

Certificates on the device

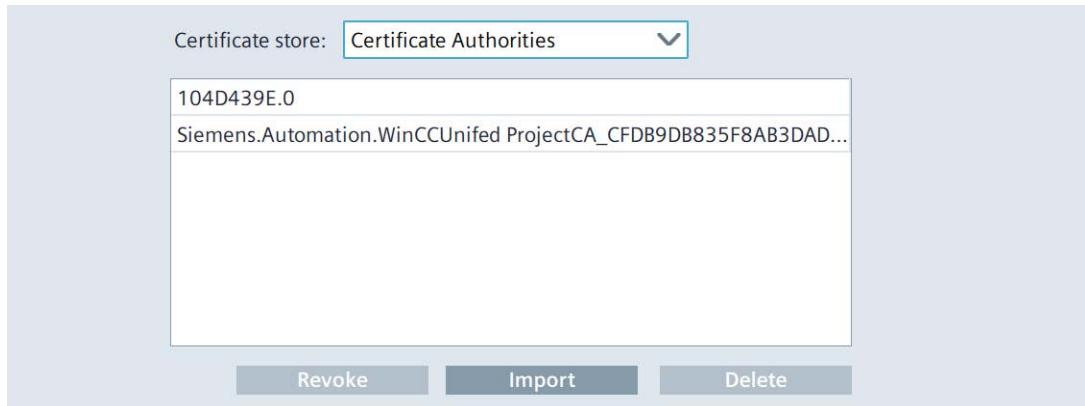

- "Certificate store": Drop-down list for the following certificate categories:
 - "Certificate Authorities": Trusted root certificate authorities and intermediate certificate authorities.
 - "My Certificates": Certificates of HMI device applications, mostly server certificates, such as OPC UA server.
 - "Other Certificates": Self-signed end entity certificates and trusted end entity certificates.
 - "Certificate Revocation Lists" for certificate revocation lists.
- The certificate list displays the certificates of the selected category. If you select an entry in the list, then the "Certificate details" for certificates or the "CRL details" for certificate revocation lists are displayed below the list.
- "Revoke": Button to mark a certificate as not trustworthy. This function is only available in the "Other Certificates" certificate category.
- "Trust": Button to mark a certificate as trustworthy. This function is only available in the "Other Certificates" certificate category.
- "Import": Button for importing one or more certificates from a data storage medium.

Note

Supported file formats for certificates

The import function supports certificate files of type ".enc", ".der", ".crl" and ".pem".

Files of type ".enc" are exported from the "WinCC Unified Certificate Manager" and contain a collection of keys, certificates and CRLs.

If you want to import an individual cryptographic file, the supported formats for CER and CRL files end in ".pem" and ".der". The individual file should have a CA certificate or a CRL with extension ".der", ".crl" or ".pem".

The "Import certificate" dialog is displayed after the "Import" button has been pressed.

Select the storage medium and certificate file and import the certificate file using the "Import" button.

When you import an encrypted certificate with the ".enc" file extension, enter the following additional data:

- "Password": The encryption password that was specified when the certificate was generated.
- "Iteration": The iteration count that was specified when the certificate was created.
- "Delete": Button to delete the currently selected certificate in the certificate list.

Note

The selected certificate is deleted immediately without prompt.

Certificate details

Certificate name	CA_STEP7
Status:	Trusted
Thumbprint:	43:88:F4:2F:DC:4C:DB:DC:DD:8E 1E:53:0D:76:C4:9E:84:DB:A6:C6
Valid from:	Oct 15 13:41:58 2020 GMT
Valid to:	Oct 12 13:41:58 2029 GMT
Issued to:	SecureHMICommunication
Issued by:	Siemens.Automation.STEP7_CA

- "Certificate name": Name of the certificate.
- "Status": Status of the certificate on the HMI device ("Trusted" or "Revoked"). This display field is only available in the certificate category "Other Certificates".
- "Thumbprint": Character string to prove the authenticity of the certificate.
- "Valid from": Start of the validity of the certificate.

- "Valid to": End of the validity of the certificate.
- "Issued to": Recipient of the certificate.
- "Issued by": Issuer of the certificate.

CRL details

CRL name	Siemens_Automation_CA_2019
Issuer:	Siemens Automation CA 2019
CRL number	3
Last update	Mar 29 00:00:00 2020 GMT
Next update	Mar 27 23:59:59 2029 GMT
Thumbprint:	9D:B2:1D:7A:E9:7A:70:29:BD:C3 49:22:7E:F9:0A:27:FC:4C:47:D9
CRL count	16

- "CRL name": Designation of the certificate revocation list.
- "Issuer": Issuer of the certificate revocation list.
- "CRL number": Consecutive version number of the certificate revocation list.
- "Last update": Time of creation of this certificate revocation list.
- "Next update": Time of creation of the next certificate revocation list.
- "Thumbprint": Character string to prove the authenticity of the certificate revocation list.
- "CRL count": Number of entries in the certificate revocation list.

5.6.3 Control panel access

Under "Control panel access" you can protect access with a password on the Control Panel. Only users who have been assigned the "Control Panel access" function right in the configuration can change the password protection.

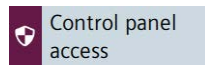

Control panel access

Enable password protection for control panel

- "Enable password protection for control panel": Option to enable password protection for the Control Panel.

The password protection can only be activated or deactivated by users who have been assigned the "Control Panel access" function right in the configuration.

If you are not yet logged in as a user with the "Control Panel access" function right and enable the option "Enable password protection for control panel", the "Access to control panel is restricted" dialog is displayed.

Access to control panel is restricted

Please enter user name and password to gain access:

Username:

Password: 

Log in as a user with the "Control Panel access" function right to activate the password protection for the Control Panel. Use the following button to make the password visible for the display duration of the dialog:



Note

Number of login attempts

The number of login attempts is 19. After 19 failed attempts, the user involved is locked out on the next attempt. The user must be deleted and recreated, or you must reload the User Management into the HMI device.

Ensure you enter the login credentials correctly.

Alternatively, you can log in via an RFID card if an RFID card has been assigned to your user. Hold the RFID card just in front of the RFID reader and input your PIN if required.

Note

Password protection of the Control Panel and project transfer

When access to the Control Panel is protected, you must ensure that the user management has been configured correctly in the TIA Portal before transferring a project again. This means:

- A user with "Control Panel access" right has been configured.
- When central user management is being used, all data for accessing the UMC server has been entered correctly.

Recommendation:

- Before loading again, disable the "Enable password protection for control panel" option.
 - After loading, verify that the user with "Control Panel access" right can log in. If this is not the case, correct the configuration of the user management.
 - Enable the "Enable password protection for control panel" option again.
-

If you are logged in as a user with the "Control Panel access" functional right, the "Access to control panel is restricted" dialog is no longer displayed when accessing the Control Panel.

If you are not logged in or do not have the "Control Panel access" function right, the "Access to control panel is restricted" dialog is displayed when accessing the Control Panel.

Access to the Control Panel can be triggered directly in the Control Panel or via a system function of the Runtime software.

5.6.4 UMAC settings

Under "UMAC settings", you can see whether local or central user management is used on the HMI device.

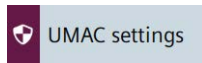

The local or central user management is configured in WinCC and transferred to the HMI with the download.

Note

You can only switch between local and central user management in WinCC.

When loading the central user management, all local users on the HMI device are deleted.

The RFID assignment can only be used in conjunction with the local user management.

Configuration of user management

Use local user management (users stored on this device)
 Use central user management (users taken from server)

Server address:

Server-ID:

Generate address of identity provider automatically

Address of identity provider:

Connection status:

- "Use local user management (users stored on this device)": Information that local user management is used. The data in this window cannot be edited; the users are managed locally under "Security" > "User management".
- "Use central user management (users taken from server)": Information that central user management is used. The connection settings are configured in WinCC and transferred to the device during loading. The settings on the HMI device can be adjusted, if required.

Meaning of the connection settings for central user management:

- "Server address": IP address or device name of the UMC server.
- "Server-ID": Unique string for identification of the UMC server. You can enter the server ID manually or have it determined automatically during connection setup.
- "Generate address of identity provider automatically": Option for automatic generation of the address of the ID provider on the UMC server. The default setting is "enabled". Disable this option if you do not want to use the UMC server but a different server as ID provider. This may be necessary when using a server farm, for example.
- "Address of identity provider": Address of the ID provider either generated automatically via the option "Generate address of identity provider automatically" or entered manually, if necessary.
- "Connection status": Connection status to the UMC server, possible values:
 - <empty>: The connection to the UMC server has not been tested yet.
 - "Connected": The connection to the UMC server has been established and tested.
 - "Not connected" - <error message>: There is no connection to the UMC server. The <error message> provides information about the possible cause.
 - "Connection not possible" - <error message>: The connection to the UMC server could not be set up. The <error message> provides information about the possible cause.
- "Check connection": Button to check the connection to the UMC server.
- "Connect to server": Button to set up the connection to the UMC server.
- "Reset configuration": Button to delete the connection settings.

Establishing a connection to the central user management

When all connection settings have been configured correctly and transferred with the project to the HMI device, the HMI device is automatically connected to the central user management. No value is specified under "Connection status" because the connection has not been checked yet. Press the "Check connection" button to check the connection.

When the central user management has not been configured completely or is incorrect, you can adjust the settings on the HMI device. Press the "Connect to Server" button to connect the device to the central user management.

When the connection was set up successfully, the "Connected" information is displayed under "Connection status". The "Connect to server" button turns into "Check connection".

More information is available in the TIA information system under "Visualizing processes (RT Unified) > Configuring users and roles (RT Unified)".

5.7 External Devices and Input

5.7.1 Hardware interfaces

Under "Hardware interfaces", change the settings for accessing the storage media interfaces.

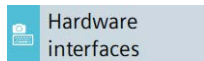

You can deactivate one or more interfaces to protect the HMI device from unauthorized external access.

The system memory card interface cannot be deactivated.

Data memory card slot

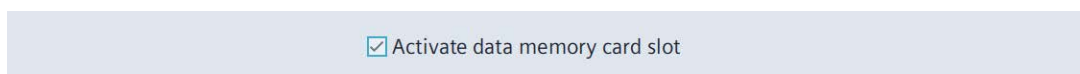
A screenshot of a software interface showing a checkbox labeled "Activate data memory card slot". The checkbox is checked, and the text is displayed in a light blue background.

Activate data memory card slot

- "Activate data memory card slot": Option to enable or disable the interface for the data memory card. The default setting is "Activated".

Activate USB ports



- "X61": Option to activate or deactivate the USB port X61.
- "X62": Option to activate or deactivate the USB port X62.
- "X63": Option to activate or deactivate the USB port X63.
- "X64": Option to activate or deactivate the USB port X64.

Default setting for all USB ports is "activated".

5.8 Language, Region and Formats

5.8.1 Date and time

Under "Date and time", set the date, time, and time zone for the HMI device manually or via a time server on the network.

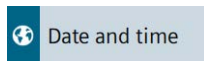

NOTICE

Setting the date and time correctly

When the date and time are not set correctly, malfunctions may occur in the plant. To prevent malfunctions, set the date and time of the HMI device and all controllers connected to the HMI device to the correct values or use an NTP server for time synchronization. Check the correct settings for date and time after every update of the operating system.

NOTICE

Time synchronization required for time-dependent reactions

A malfunction may occur in the plant if the date and time are not synchronized and time-dependent reactions are triggered in the plant via the HMI device. To avoid malfunctions, use automatic time synchronization via one or more NTP servers.

Date and time

Date: 22 November 2022
Current Time: 09:50:12
Time zone: (UTC) Coordinated Universal ...
 Set date and time manually
 Synchronize time with a NTP (Network Time Protocol) server

- "Date": Display field with the current date.
- "Current Time": Display field with the current clock time.
- "Time zone": Selection list for the desired time zone.

Note

Automatic daylight saving/standard time switchover

If you select a time zone in which there is a switchover between daylight saving and standard time, the switchover takes place automatically on the relevant date.

- "Set date and time manually" (default setting): Option for manual time setting on the HMI device. If you select this option, the following list is displayed below the options:

19	August	2019	06	47
20	September	2020	07	48
21	October	2021	08	49
22	November	2022	09	50
23	December	2023	10	51
24	January	2024	11	52
25	February	2025	12	53

Set Date and Time

Set the day, month, year and time by scrolling the respective list column so that the desired date and time are displayed in the framed line in the middle of the list. The "Set Date and Time" button is used to save the setting.

- "Synchronize time with a NTP (Network Time Protocol) server": Option for automatic time synchronization via an NTP server. If you select this option, the following parameters for specifying time synchronization via NTP servers are displayed below the options:

Update rate: 1024 sec

Server 1

Address: 0.0.0.0

Add Server

Enter the desired synchronization interval under "Update rate", value range 10 to 86400 seconds (1 day). After the input, the value is rounded to the nearest power of two based on the internal format.

Add at least one and a maximum of four NTP servers using the "Add Server" button. Specify the IP address for each NTP server and make sure that the device is set up as an NTP server.

5.9 Service and Commissioning

5.9.1 Transfer

Under "Transfer" you define whether and how data is transferred from a configuration PC to the HMI device.



Transfer mode

Enable transfer

- "Enable transfer": Option to enable or disable data transfer to the HMI device. The default setting is "enabled".

If you disable the transfer, you protect the HMI device against unintended update of the operating system and overwriting the project data.

Encrypted project transfer

Password:

Set Password

- "Password": Password for the encrypted transfer of the project. The password must match the password that was specified in the configuration under the runtime settings of the HMI device.

To enter the password, tap the entry field.

- "Set Password": Button to save the password for the encrypted project transfer.

As an alternative, you can transfer the password unencrypted during the initial loading of the project.

5.9.2 Update OS

The firmware and operating system version of the HMI device must be compatible with the firmware and operating system version of the installed WinCC software. If this is not the case, then you must update the operating system.

Use "Update OS" to update the operating system of the HMI device. The operating system is contained in several firmware files. The master file has the extension ".fwf". The number of additional files varies; these files have the file name of the master file and a sequential number (".0", ".1", ".2", etc.) as an extension.

The "Update OS" function is available under both "System Properties" and "Service and Commissioning".

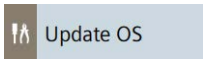
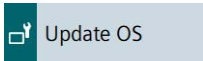

NOTICE
Updating the operating system deletes data on the HMI device
Project, parameter sets and user administration will be deleted when you update the operating system on the HMI device.
Before updating the operating system, backup the data on the HMI device, if necessary.
All settings, except the following settings which you changed in the Control Panel before updating the operating system, are retained even after the update of the operating system:
<ul style="list-style-type: none">• The external interfaces become activated again (default setting), see section "Hardware interfaces (Page 122)".• The time zone is reset to the default setting "(UTC) Coordinated Universal Time", see section "Date and time (Page 123)".• The credentials for connected network drives must be entered again, see section "Network drive (Page 103)".

NOTICE
Automatic backup and updating the operating system
When the "Automatic backup" function is activated while the operating system is being updated, the HMI device may not start up again correctly.
If you want to update the operating system of the HMI device and have activated the "Automatic backup" function, follow these steps:
<ol style="list-style-type: none">1. Deactivate the "Automatic backup" function.2. Update the operating system.3. Activate the "Automatic backup" function.
Leave the system memory card in the HMI device before and during the entire update.

Use a SIMATIC SD memory card with 32 GB or more or an industrial USB flash drive to load the firmware.

Firmware files for the HMI devices can be downloaded from the Internet (<https://support.industry.siemens.com/cs/ww/en/view/109746530>). Observe the documentation included with the download.

Note

Do not rename firmware files

If you change the name of the firmware files, the operating system can no longer be updated with these firmware files. The firmware files become unusable. Leave the name of the firmware files unchanged.

Note

Copy firmware files completely

If you copy the firmware files, be sure to also copy the master file ".fwf" together with all associated firmware files (".0", ".1", ".2", etc.).

If one of the files is missing, the operating system cannot be loaded.

Alternatively to the "Update OS" function in the Control Panel, you can use the "Update OS" function in WinCC.

Panel Information

Device type:	<input type="text" value="MTP1500 Unified Comfort"/>
Image version:	<input type="text" value="V18.00.00.01_04.01"/>

- "Device type": HMI device type designation.
- "Image version": Version of the firmware and operating system.

Select storage media for OS update

<input type="text" value="X61 (Size:7.6 GB/Free:5.04 GB)"/>

Use the selection list to select the storage medium on which the firmware file is located.

Firmware files on external storage

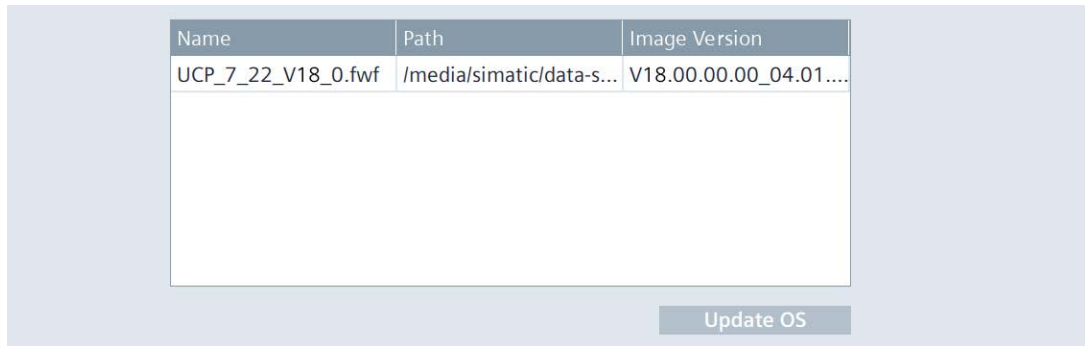

- The list shows all firmware files that can be loaded into the HMI device. Select the desired firmware master file (.fwf) from the list.
- "Update OS": Button for starting the loading process. The HMI device restarts after the "Update OS" button is pressed. The loading process then begins. A dialog with a progress bar is displayed on the HMI device for each firmware file. The HMI device is restarted again after the completion of the loading process. The main window of the Control Panel is displayed after the restart. The operating system on the HMI device is updated.

5.9.3 Backup

Under "Backup" you can back up the operating system, applications and data from the flash memory of the HMI device to an external storage medium.

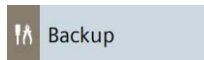

Use a SIMATIC SD memory card ≥ 32 GB or an industrial grade USB stick as storage medium.

Depending on the amount of data on the HMI device, a backup may require up to 20 GB of memory. Make sure that the storage medium has sufficient free space. Recommendation: At least 5 GB of free space on the storage medium.

Remote access to the HMI device is not possible during the backup process.

Do not turn off the HMI device during the backup process.

Select storage media

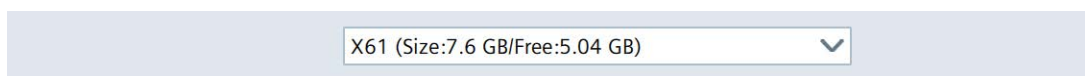

Select the storage medium on which you want to back up the data.

Complete backup file



File name:

- "File name": Name of the backup. Select a name that best identifies the backup. A backup includes multiple files. The master file has the extension ".brf". The number of additional files varies; these files have the file name of the master file and a sequential number (".0", ".1", ".2", etc.) as an extension.
- "Create backup": Button to start the backup process.

After the "Create backup" button has been pressed, the system checks whether a backup with the name specified under "File name" already exists on the storage medium. If yes, then a warning is displayed. Select "OK" to overwrite the backup or "Cancel" to specify a different name for the backup.

The backup process starts with a restart of the HMI device, followed by the data backup. During the data backup, a folder with the name of the backup is created in the root directory of the selected storage medium. The backup files are saved in this folder. A dialog with a progress bar is displayed for each backup file.

The HMI device is restarted again after the completion of the backup process.

The main window of the Control Panel is displayed after the restart.

The data of the HMI device are saved on the storage medium.

Note

Do not rename backup files on the data storage medium

If you change the name of the backup files on the data storage medium, these backup files can no longer be loaded into the HMI device using the "Restore" function.

Leave the name of the backup files on the data storage medium unchanged.

Note

Copy backup files completely

If you copy the backup files, be sure to also copy the master file ".brf" together with all associated backup files (".0", ".1", ".2", etc.).

If one of the files is missing, the backup cannot be loaded.

See also

Accessories (Page 16)

Backup and restore (Page 152)

5.9.4 Automatic backup

Under "Automatic backup" you can activate or deactivate the "Automatic backup" function.

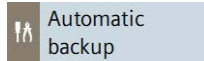

If the "Automatic backup" function is activated the data of the HMI device is automatically backed up to the system memory card during operation in form of a backup including firmware. The data on the system memory card are permanently synchronized with the data of the HMI device. You can insert the system memory card into any HMI device of the same type. After data is copied and a restart has been performed, the HMI device of the same type is operational.

Note

Only use SIMATIC SD memory card ≥ 32 GB as system memory card

Only the SIMATIC SD memory card ≥ 32 GB is permitted for use as a system memory card. Other memory cards are not recognized as system memory card by the HMI device.

Note

System memory card in a device of a different type

If you use the system memory card of an HMI device in an HMI device of a different type, an error message is displayed.
When servicing, use a system memory card only in HMI devices of the same type.

NOTICE
Do not remove the system memory card for "automatic backup" during operation
If the "Automatic backup" function is activated, the system memory card may only be removed when the HMI device is switched off.

NOTICE
Automatic backup and updating the operating system
When the "Automatic backup" function is activated while the operating system is being updated, the HMI device may not start up again correctly.
If you want to update the operating system of the HMI device and have activated the "Automatic backup" function, follow these steps:
1. Deactivate the "Automatic backup" function.
2. Update the operating system.
3. Activate the "Automatic backup" function.
Leave the system memory card in the HMI device before and during the entire update.

In the delivery state of the device, the function "Automatic backup" is disabled.

The "System memory card plugged" dialog box is displayed as soon as you insert a memory card into the system memory card slot. To go to the Control Panel, click "OK". There you can activate a new system memory card or restore data from a prepared system memory card.

Automatic backup

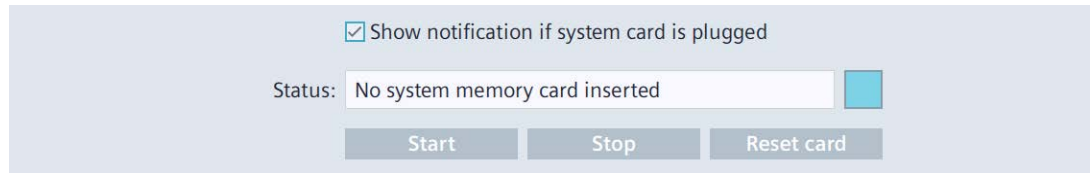

- "Show notification if system card is plugged": Option to enable or disable the automatic message "System memory card plugged".
- "Status": Status information on the system memory card in slot X50.
 - "No system memory card inserted": There is no system memory card in slot X50.
 - "System memory card is invalid": There is an unsupported or incorrectly formatted system memory card in slot X50.
 - "Backup on system memory card is not device compatible": The system memory card of a non-identical HMI device or an HMI device with different HMI device image is located in slot X50.
 - "Ready for automatic backup": There is a correctly formatted SIMATIC SD memory card in slot X50.
 - "Starting automatic backup": Status message after pressing the button "Start", the system memory card is being prepared.
 - "Synchronizing data": Status message during preparation of the system memory card.
 - "Automatic backup active": Status message when preparation of the system memory card has been completed, the "Automatic backup" function was successfully activated.
 - "Resetting system memory card": The system memory card is formatted.
- "Start": Button to activate the "Automatic backup" function.
- "Stop": Button to deactivate the "Automatic backup" function.
- "Reset card": Button for formatting the system memory card.

Use cases

We differentiate between the following use cases, depending on whether the system memory card was previously used for automatic backup.

Activating automatic backup for an empty system memory card

1. Insert the SIMATIC SD memory card without automatically saved data into slot X50. The "System memory card plugged" dialog box is displayed.

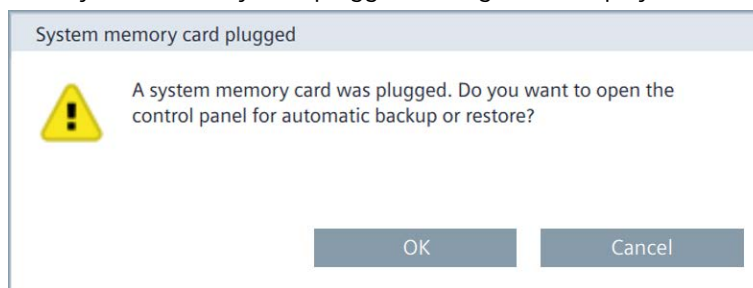

2. Press "OK".
The window "Service and Commissioning" > "Automatic backup" opens in the Control Panel. "Ready for automatic backup" is displayed in the "Status" field.

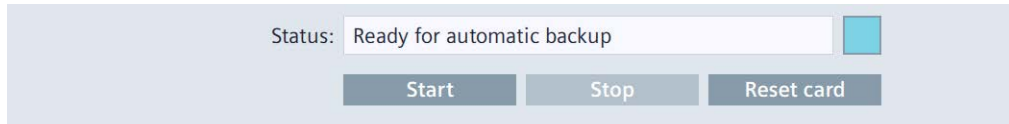

3. Press the "Start" button.
The "Start automatic backup" dialog box is displayed.

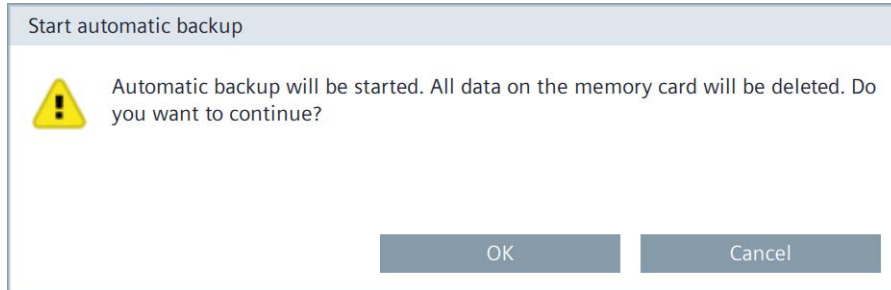

4. Press "OK".
The status message "Starting automatic backup" is displayed. The system memory card is being prepared.

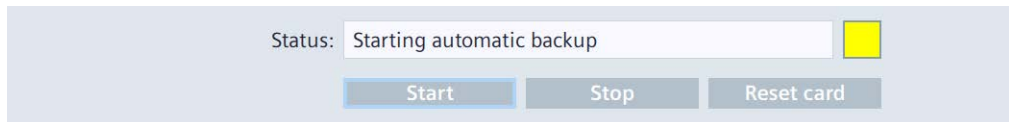

Note

Do not remove the system memory card during the preparation.

If you remove the system memory card from the HMI device during the preparation, the system memory card cannot be used for automatic backup. Leave the system memory card in its slot during the preparation process.

The status message "Synchronizing data" is displayed during the preparation.



When the preparation is complete, the status message "Automatic backup active" is displayed.

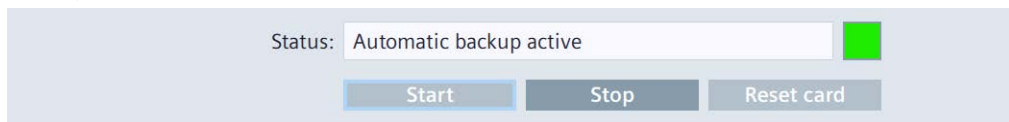

You have successfully activated the "Automatic backup" function.

Using automatic backup of a system memory card

If a system memory card already contains automatically backed-up data, the corresponding backup must first be loaded. Automatic backup can then be continued.

1. Insert the SIMATIC SD memory card with automatically backed-up data in slot X50.
The "System memory card plugged" dialog box is displayed.

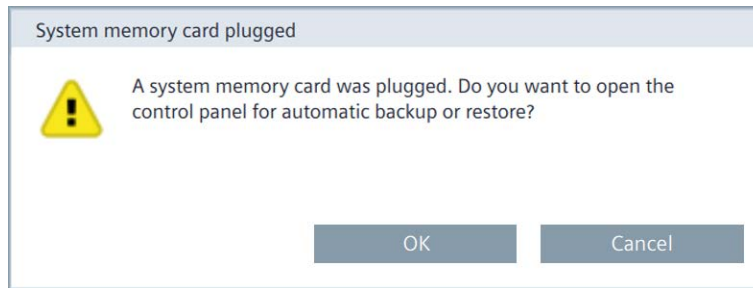

2. Press the "OK" button.
The window "Service and Commissioning" > "Restore" opens in the Control Panel.

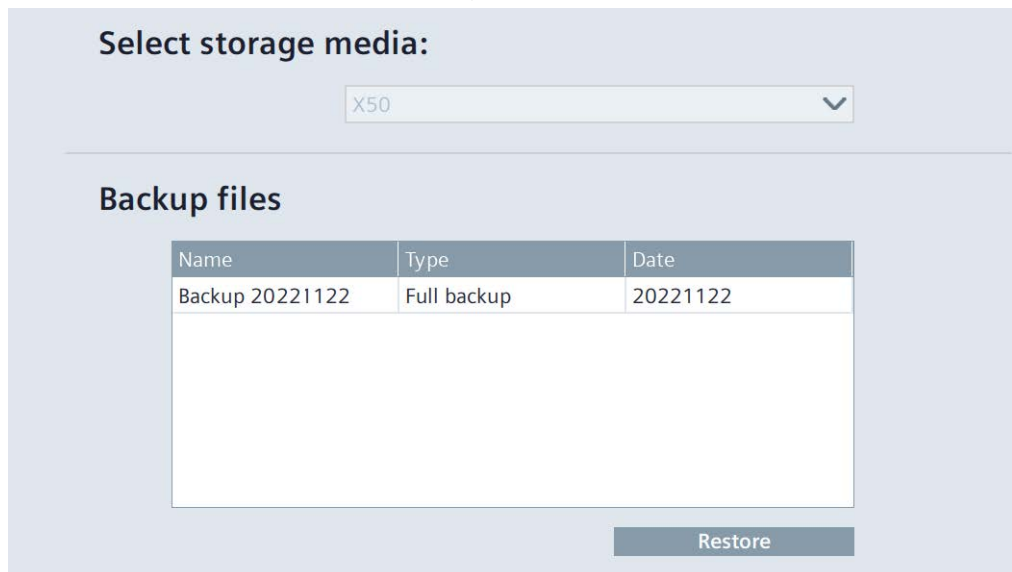

3. Select a backup file and press the "Restore" button.
The following dialog box indicates that all data on the device will be overwritten.

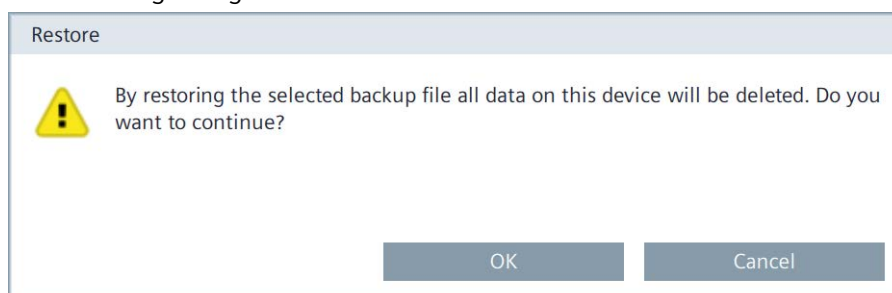

- 4. Start the restore process via the "OK" button or cancel the process via the "Cancel" button. The HMI device restarts after the "OK" button is pressed. The restore process then begins. During the restore process, the "Automatic backup restore" dialog box is displayed with a progress bar. The HMI device is restarted again after the completion of the restore process. The main window of the Control Panel is displayed after the restart.

After the data transfer, the state of the HMI device is the same as that of the HMI device used to generate the automatic backup.

To continue the automatic backup on the HMI device, reactivate the "Automatic backup" function under "Service and Commissioning" > "Automatic backup" in the Control Panel.

See also

- Accessories (Page 16)
- Backup (Page 128)
- Changing the memory card (Page 70)

5.9.5 Restore

Under "Restore", you can restore the backup of an HMI device from a storage medium.



Remote access to the HMI device is not possible during the restore process.

A restore operation deletes the flash memory of the HMI device on confirmation. The data backed up on the storage medium is then transferred.

NOTICE
Data loss All data on the HMI device, including the project and HMI device password, is deleted during a restore operation. License keys are only deleted after a security prompt. Back up your data before the restore operation, if necessary.

Select storage media



Select the storage medium on which the backed-up data is stored.

Backup files

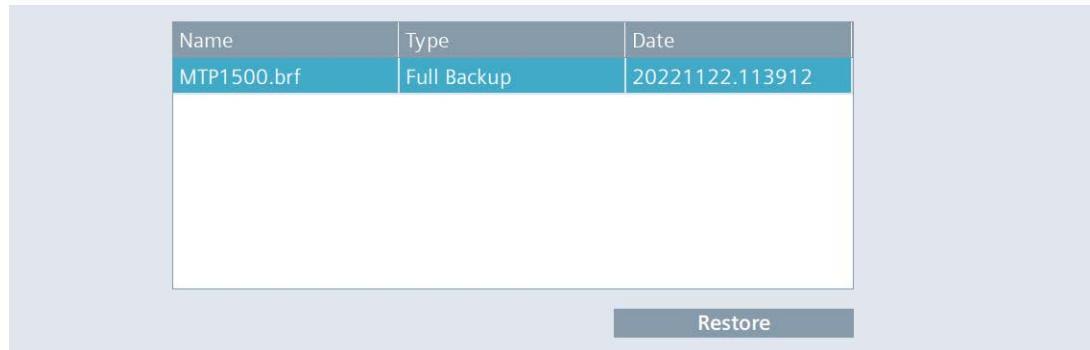

Name	Type	Date
MTP1500.brf	Full Backup	20221122.113912

Restore

- The list shows all backups that can be loaded to the HMI device. Select the desired backup from the list.
- "Restore": Button to start the restore process.
The HMI device restarts after the "Restore" button is pressed. The restore process then begins.
Do **not** switch off the HMI device during the restore process and do **not** disconnect the data source from the HMI device.
During the restore process, a dialog with a progress bar is displayed for each backup file loaded.
The HMI device is restarted again after the completion of the restore process.
The main window of the Control Panel is displayed after the restart.
The data from the storage medium is now restored on the HMI device.

Note

System behavior when the process is interrupted

If the restore process cannot be completed due to a power failure or an interrupted data connection, for example, the HMI device starts in maintenance mode and the factory settings must be restored.

See also

Resetting an HMI device to factory settings via ProSave (Page 158)

5.9.6 Trace forwarder

You specify whether or not trace outputs are displayed and backed up on an external storage medium under "Trace forwarder".



Trace forwarder

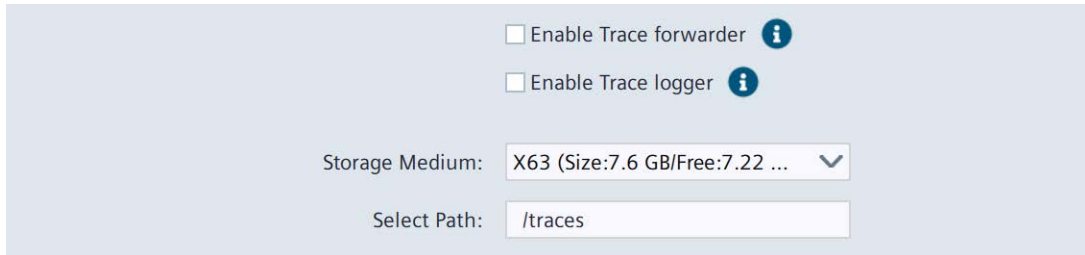

- "Enable Trace forwarder": Option to enable or disable the "tracing" service. The default setting is "deactivated".
Enable "Tracing" for diagnostics and service purposes, e.g. to display trace outputs from scripts. If you start the HMI device in maintenance mode, the "Tracing" function is automatically enabled. You can find additional information in FAQ Entry 109777593 on the Internet (<https://support.industry.siemens.com/cs/ww/en/view/109777593>).
- "Enable Trace logger": Option to back up "tracing" information on an external storage medium. The default setting is "deactivated".
 - "Storage Medium": Storage medium on which the "tracing" information is to be backed up.
 - "Select Path" (optional): Path to location where the "tracing" information is to be backed up. The name of the path must begin with "/" and may contain only Latin characters and **none** of the following special characters:
! # \$ % & () * + , ; < = > ? @ [] _ { | } ~ ^

Note

When the HMI device restarts, both options are disabled for security reasons.

See also

Event Logger (Page 89)

5.10 Apps

The following options are available for managing apps on the HMI device under "Apps":

- Start apps that were especially developed for SIMATIC under "SIMATIC Apps" or adjust their settings.
- Start pre-installed apps under "Add-ons" or adjust their settings.
- Uninstall and start pre-installed apps via the "App management" under "Settings" or change their settings.

The following figure shows an example of the delivery state of an HMI device.

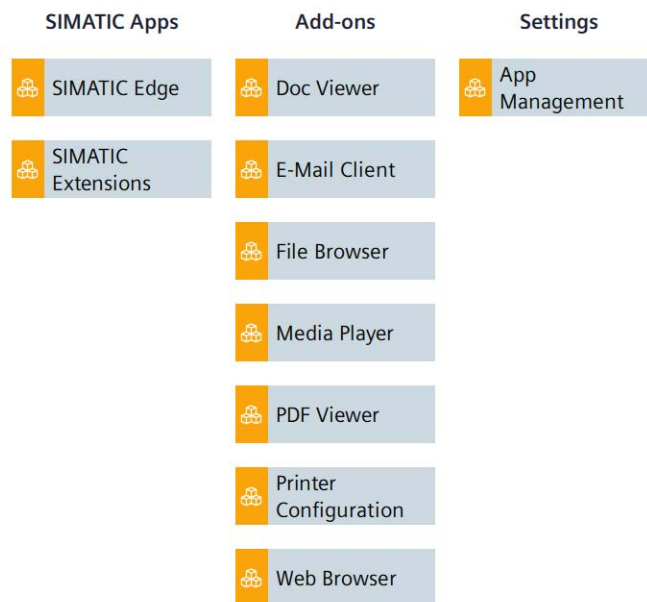

To open an app, to change the settings of an app or to uninstall an app, select an entry under the category "SIMATIC Apps", "Add-ons" or "Settings".

The entries under the categories are described in the following sections:

- **SIMATIC Apps** (Page 138)
- **Add-ons** (Page 140)
- **Settings** (Page 143)

Note

Best performance

Each app takes up a specific amount of work memory. The greater the number of apps and tabs open in the "Web Browser" app, the smaller the amount of available work memory.

Note the following recommendations to achieve the best performance of your HMI device:

- Keep the number of apps that are open simultaneously as small as possible.
 - Close any apps that you no longer need.
 - If possible, open only one tab in the "Web Browser" app.
-

5.10.1 SIMATIC Apps

Under "SIMATIC Apps", you can find apps that were specifically developed for the SIMATIC environment, such as "SIMATIC Edge" and "SIMATIC Extensions".



If the screen keyboard does not open automatically during data input on the web page of a SIMATIC app, open the screen keyboard using the following icon in the taskbar.



SIMATIC Edge

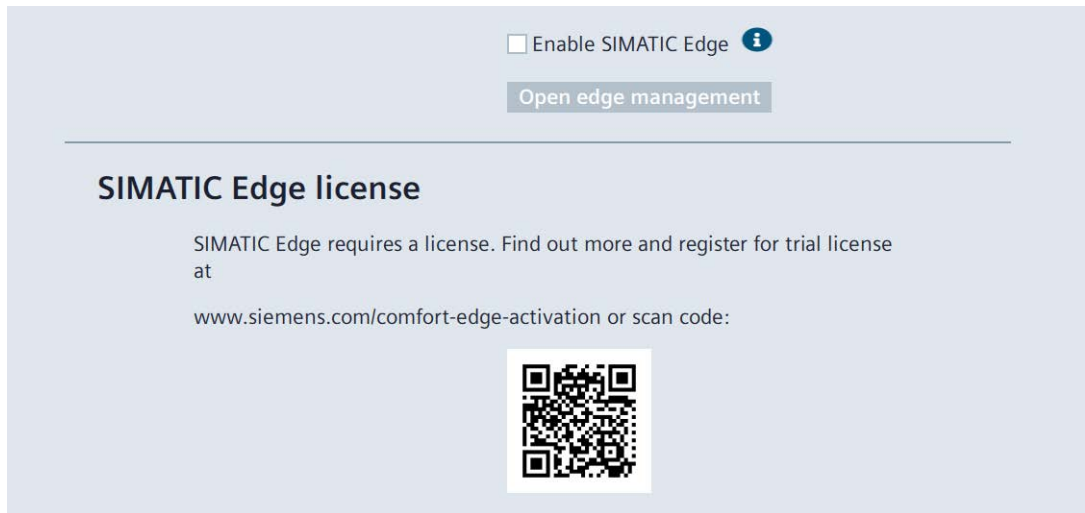

- "Enable SIMATIC Edge": Option to enable or disable the Edge Management. The default setting is "disabled". Observe section "Notes on operation (Page 76)".
- "Open edge management": Button to open the Edge Management web page in the "Web Browser" app on the HMI device.

The first time you click the button, the "Activate Edge Device" dialog is displayed. In this dialog you decide whether you want to use the local Edge Management or central Edge Management in the future.



Select "Standalone" for local Edge Management or "Central Managed" for central Edge Management IEM.

Under "Settings" you can make network settings for the Edge Management, if necessary.

Once you have decided whether you want to use the local Edge Management or central Edge Management, the "Activate Edge Device" dialog is no longer displayed in the future.

The "Sign in" dialog is displayed for logging in to the Edge Management.

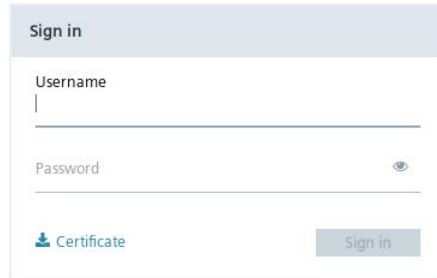

The image shows a "Sign in" dialog box with a light blue header. Below the header, there are two input fields: "Username" and "Password". The "Password" field has a small eye icon to its right. At the bottom left, there is a "Certificate" link with a small icon. At the bottom right, there is a "Sign in" button.

Log in to the Edge Management as a user with the required authorizations.

The Edge Management website is opened in the "Web Browser" app.

Alternatively, you can open "SIMATIC Edge" via web access, see "Web access to the HMI device (Page 71)".

You can find detailed information about the Edge Management for Unified Comfort Panels in the following document: Operating manual "Unified Comfort Panels Industrial Edge Device - Operation" (<https://support.industry.siemens.com/cs/ww/en/view/109804671>)

SIMATIC Extensions

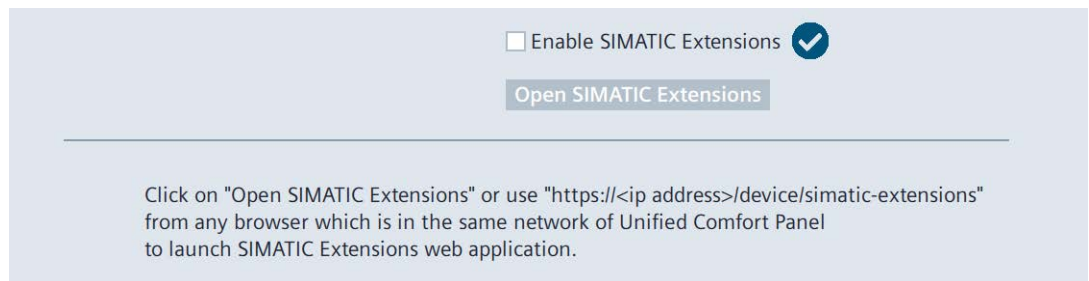

- "Enable SIMATIC Extensions": Option to enable or disable the SIMATIC Extensions. The default setting is "disabled".
- "Open SIMATIC Extensions": Button for opening the SIMATIC Extensions in the "Web Browser" app on the HMI device.

SIMATIC Extensions is a web-based application with which you can change in runtime the configuration of the project running on a Unified Comfort Panel.

To change the configuration of the SIMATIC Extensions locally, enable the option "Enable SIMATIC Extensions" and select "Open SIMATIC Extensions".

Alternatively, you can open "SIMATIC Extensions" via web access, see "Web access to the HMI device (Page 71)".

The SIMATIC Extensions website with the "Sign in" window is displayed. Log in as a user with the "HMI Administrator" role.

You can find detailed information on the use of SIMATIC Extensions using the "UserManual" link at the top left in the header of the SIMATIC Extensions website.

5.10.2 Add-ons

Under "Add-ons" you will find pre-installed apps such as "Doc Viewer", "E-Mail Client", "File Browser", "Media Player", "PDF Viewer", "Printer Configuration" and "Web Browser". The following figure shows the symbol of the "Doc Viewer" as an example.



All pre-installed apps under "Add-ons" have a "Start" button, the "Autostart" function is also available for most apps.

<App name>

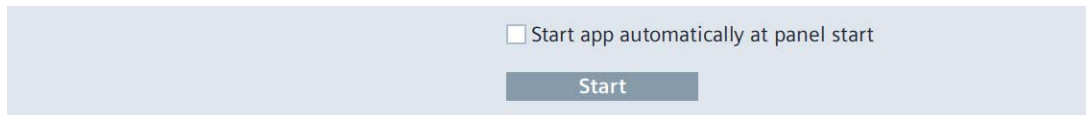

- "Start app automatically at panel start": Option to activate or deactivate the "Autostart" function for the respective app, not available for all apps. If this option is selected, the app starts immediately after the start of the Control Panel. The app is displayed in the foreground of the Control Panel.
- "Start": Button for manually starting the respective app.

The following table shows a short description of the pre-installed apps.

App	Description	"Autostart" available
Doc Viewer	With the "Doc Viewer" you can view and edit documents such as text or Word files. Note: Do not use the "Doc Viewer" to edit files that have been saved via the Runtime software or a system function. These files include, for example, parameter sets that were exported to a .tsv file. When printing to a file, leave the default setting "Portable Document Format" (.pdf) for the file type unchanged.	Yes
E-Mail Client	With the "E-Mail Client" you can connect to your e-mail accounts, receive e-mails, send e-mails and import mail files from other applications. The first time the "E-Mail Client" is called, a configuration wizard is started. During configuration, enable SSL encryption for sending and receiving e-mail.	Yes
File Browser	With the "File Browser", you can find and manage files in the internal memory and on storage media of the HMI device. Note: The function "Eject storage medium" is not supported in the "File Browser". Use the "EjectStorageMedium" system function instead.	Yes
Media Player	You can use the "Media Player" to play audio and video files.	Yes
PDF Viewer	You can use the "PDF Viewer" to view PDF documents.	Yes
Printer Configuration	You open the local web page "CUPS" for the printer management via the "Printer Configuration".	No
Web Browser	The "Web Browser" provides you with access to the Internet.	Yes

Managing printers

The printer settings of the HMI device are managed via the local web page "CUPS" (Common Unix Printing System) under "localhost:631".

To open the printer administration, proceed as follows:

1. Open the printer management via "Apps" > "Printer Configuration" > "Start".
2. In the header, select "Printers".

Queue Name	Description	Location	Make and Model	Status
BrGenML1	BrGenML1		Brother BrGenML1 for CUPS	Idle
CUSTOM_Engineering_PLUS_USB	CUSTOM Engineering PLUS USB	PLUS2 rel 2.01 (S.Code:01DV000000181)		Idle
HL4150CDN	HL4150CDN		Brother HL-4150CDN series CUPS	Idle
HLL2360D	HLL2360D		Brother HLL2360D for CUPS	Idle
HLL5100DN	HLL5100DN		Brother HLL5100DN for CUPS	Idle
HLL5200DW	HLL5200DW		Brother HLL5200DW for CUPS	Idle
HLL8250CDN	HLL8250CDN		Brother HL-L8250CDN series CUPS	Idle
HLL8260CDW	HLL8260CDW		Brother HL-L8260CDW CUPS	Idle
HLL8360CDW	HLL8360CDW		Brother HL-L8360CDW CUPS	Idle
QL-650TD	QL-650TD		Brother QL-650TD CUPS v1.1	Idle
QL-820NWB	QL-820NWB		Brother QL-820NWB CUPS	Idle
QL700	QL700		Brother QL-700 CUPS	Idle

The "Printers" page shows the pre-installed printers.

To change the properties of a printer or to display its print jobs, click on the printer name in the "Queue Name" column.

The figure below shows the properties of the "HLL8250CDN" printer.

HLL8250CDN
HLL8250CDN (Idle, Accepting Jobs, Not Shared)

Maintenance: [v] Set Default Options: [v]

Description: HLL8250CDN

Location:
 Driver: Local Raw Printer (grayscale, 2-sided printing)

Connection: usb:///Brother/HL-L8250CDN%20series

Defaults: job-sheets=none, none media=unknown

Jobs

Search in HLL8250CDN: [] [Search] [Clear]

Show Completed jobs Show All jobs

Jobs listed in print order; held jobs appear first.

The following functions are available in the following two selection lists:

- "Maintenance": Printing a test page, pausing the printer, canceling print jobs, canceling all print jobs
- "Administration":
 - "Set Default Options": Specifying settings for the printout
 - "Set As Server Default": Defining the printer as the default printer

The "Jobs" list displays the print jobs.

Starting pre-installed apps from the project

However, you can also start the pre-installed apps via an operating element in the project. To do this, use the "StartProgram" system function in your configuration.

Enter the following command under "Program name":
 "/opt/siemens/App_Restriction/<Name of start script>"

Depending on the desired app, use of the following scripts for the "<Name of start script>":

App to be started	Associated start script
Doc Viewer	runLibreoffice.sh
E-Mail Client	runEvolution.sh
File Browser	runThunar.sh
Media Player	runVLC.sh
PDF Viewer	runEvince.sh
Web Browser	runFirefox.sh

Under "Program parameters", you can specify all parameters permitted for calling the app, for example, which file is to be opened. You can find the permitted parameters on the Internet by searching for the name of the app specified under "Help" > "About ...".

Examples

- Open the "MyPDFfile.pdf" from a USB stick connected to interface X61:
 - "Program name": "/opt/siemens/App_Restriction/runEvince.sh"
 - "Parameter": "/media/simatic/X61/MyPDFfile.pdf"
- Print ".odt" files to PDF files from Runtime using the "Doc Viewer" app
 To print all ".odt" files in the /home/industrial folder to PDF files using the "Doc Viewer", use the "StartProgram" system function with the following values:
 - "Program name": /opt/siemens/App_Restriction/runLibreoffice.sh
 - "Program parameters": --convert-to pdf --outdir /home/industrial /home/industrial/*.odt -headless

See also

App Management (Page 143)

5.10.3 App Management

You can uninstall pre-installed apps or change their settings under "App Management".

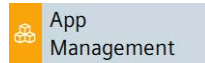

Manage Apps



- The list shows all apps installed under "Add-ons".
- "Uninstall": Button to uninstall the selected app. Recommendation: Uninstall apps that you do not need.

Note

Uninstallation cannot be undone

An uninstalled app cannot be installed again. To get back all apps pre-installed in the delivery state, you must restore the factory settings of the HMI device.

- "Configure": Button to change the settings of the selected app, see section "Add-ons (Page 140)".

See also

Resetting an HMI device to factory settings via ProSave (Page 158)

Transferring data

6.1 Overview

Configuration phase

In the configuration phase, the automation process is visualized with the configuration software in the form of a project. The plant screens of the project contain operating elements and display controls for values and alarms which provide information about process statuses. After the configuration phase, the project is transferred to HMI device, followed by the process control phase.

Transferring the project to the HMI device

The project must be transferred to the HMI device to be used in process control. You have the following options for the transfer:

- Transfer the project from a configuration PC to the HMI device, see section "Transferring a project with WinCC (Page 149)".
- Transfer of the project from an external storage medium, see section "Load project from storage (Page 94)".
- Insert a prepared system memory card from an identical HMI device, see section "Automatic backup (Page 130)".
- Restore the backup file of an identical HMI device from an external storage medium, see section "Restore (Page 134)".

Updating the operating system of the HMI device

The firmware and operating system version of the HMI device must be compatible with the firmware and operating system version of the installed WinCC software. If this is not the case, an error message is output before the transfer.

You can update the operating system of the HMI device in the following ways:

- Transfer of the operating system together with the project from a configuration PC to the HMI device, see section "Transferring a project with WinCC (Page 149)".
- Transfer of the operating system from a configuration PC to the HMI device, see section "Updating the operating system via WinCC (Page 156)".
- Transfer of the operating system from a data storage medium to the HMI device, see section "Update OS (Page 126)".
- Insert a prepared system memory card from an identical HMI device, see section "Automatic backup (Page 130)".
- Restore the backup file of an identical HMI device from an external storage medium, see section "Restore (Page 134)".

6.2 Operating modes

If the operating system cannot be updated with the above options, then you must reset the HMI device to factory settings.

You can reset the HMI device to the factory settings in the following ways:

- If the HMI device starts and you have access to the Control Panel, proceed as described in section "Resetting an HMI device to factory settings via ProSave (Page 158)".
- If the HMI device does not start or you do not have access to the Control Panel of the HMI device, then start the HMI device in maintenance mode, see section "Using the maintenance mode (Page 162)".

Process control phase

In the process control phase, the HMI device is connected online to a controller, and you can operate and monitor the plant.

Commissioning and recommissioning

Initial commissioning and recommissioning differ as follows:

- During initial commissioning, no project is available on HMI device. The HMI device has this status when delivered and after updating of the operating system.
- When recommissioning, the project already on the HMI device is replaced.

6.2 Operating modes

Operating modes

The HMI device can be in the following operating modes:

- Offline
- Online
- Transfer

Changing the operating mode

The configuration engineer must have configured appropriate operating elements to allow a change of the operating mode on the HMI device during ongoing operation.

If available, you can find additional information in your plant documentation.

"Offline" operating mode

In this mode, there is no communication between the HMI device and the controller. Even though the HMI device can be operated, it cannot exchange data with the controller.

"Online" operating mode

In this operating mode, there is a communication connection between HMI device and the controller or between HMI device and the configuration PC.

- In online operation between HMI device and controller, operate the plant with the HMI device according to the configuration.
- In online operation between HMI device and configuration PC, extended functions such as "Online & diagnostics" are available.

"Transfer" mode

In this mode, you can transfer a project from the configuration PC to the HMI device or backup and restore HMI device data, for example.

6.3 Using existing projects

Information and support for migration of existing projects is available:

- In the TIA information system under "Editing projects > Compatibility of projects > Upgrading projects".
- In the guidelines for switching from Comfort Panels to Unified Comfort Panels on the Internet (<https://support.industry.siemens.com/cs/ww/en/view/109768002>).
- In the entry "Data2Unified Add-in" for switching to SIMATIC WinCC Unified on the Internet (<https://support.industry.siemens.com/cs/ww/en/view/109770510>).

6.4 Data transmission options

The following table shows the options for data transmission between an HMI device and the configuration PC.

Interface	PROFINET (LAN)			USB	SD
	Protocol	X1	X2	X61 ... X64	X51
Backup and Restore	PN/IE	-	-	x	x
	Ethernet	x ¹	x		
Update operating system	PN/IE	-	-	x	x
	Ethernet	x ¹	x		
Update operating system and Reset to factory settings	PN/IE	-	-	-	-
	Ethernet	-	x		
Transfer a project	PN/IE	x	x	x	x
	Ethernet	x	x		
S7 communication	PN/IE	x	x	-	-
NTP, Web Client, Internet access, Unified Collaboration, SmartServer/SmartClient, Industrial Edge	Ethernet	x	x	-	-

- ¹ Only for devices with the following function version ("F-State", see nameplate):
- MTP700/1000/1200 Unified Comfort: F-State ≥ 7
 - MTP1500/1900/2200 Unified Comfort: F-State ≥ 5

6.5 Setting the PG/PC interface

Notes on data transfer

If possible, use the "Ethernet" protocol for data transfer, which offers a higher speed than PN/IE.

Always use the "Ethernet" protocol for the "Update operating system via WinCC" function.

If possible, use the X2 interface with the highest bandwidth for the following functions

- Backup and Restore
- Update operating system
- Transfer a project

The X20 RS422/485 interface is designed for connecting controllers from other manufacturers. Do not use the X20 interface for data transfer between the configuration PC and the HMI device.

6.5 Setting the PG/PC interface

To establish Ethernet communication between the configuration PC and the HMI device, the PG/PC interface must be set correctly.

Procedure

1. Open the Control Panel of the configuration PC.
2. Click on "Set PG/PC interface".
3. Select the entry "S7ONLINE (STEP 7)" in the first tab under "Application access point".
4. Select your Ethernet adapter with the name suffix ".TCPIP.Auto.1" under "Used interface parameterization".

Result

The PG/PC interface is set, you can connect the configuration PC to the HMI device via Ethernet and transfer data.

6.6 Transferring a project with WinCC

This section describes how to transfer a project to the HMI device via the configuration software WinCC . Before the transfer, the software checks whether the project can be loaded onto the HMI device. The result of the check is displayed in the "Load preview" dialog box. If it is not possible to load the project, you can change the transfer settings in the "Load preview" dialog box. To load the project, use the configuration software with which the HMI device was configured.

Note

Existing parameter sets are deleted during loading

When loading a project into an HMI device, all parameter sets that were saved in the internal memory or on an external storage medium from the previous project are deleted. Before loading the project, save the parameter sets entered from the previous project.

Procedure

1. If a project is running on the HMI device, close the project.
2. Connect the HMI device to the configuration PC via the X1 or X2 interface. If possible, use the X2 interface with the highest bandwidth.
3. In the Control Panel of the HMI device, select "Network and Internet".
Ensure that the port selected for data transmission is activated for the interface used ("Activate this port for use").
4. In the Control Panel of the HMI device, select "Service and Commissioning" > "Transfer".
5. Make sure that the "Enable transfer" option is activated.
6. Open the configuration software with which the HMI device was configured.
7. Open the project you want to transfer to the HMI device.
Make sure that the port of the interface used for data transfer is activated in the project configuration. You can find this setting under the advanced options of the interface parameters in the device configuration.
8. In the project tree, select the HMI device whose project you want to transfer.
9. Select the "Download to device > Software" command in the shortcut menu of the HMI device.
10. If there is no connection to the HMI device, the connection dialog box is displayed. In this case, enter the connection settings for your HMI device. Click the "Connect" button and then click "Load".
If the connection was established successfully, the "Load preview" dialog box is displayed. The following figure shows an example.

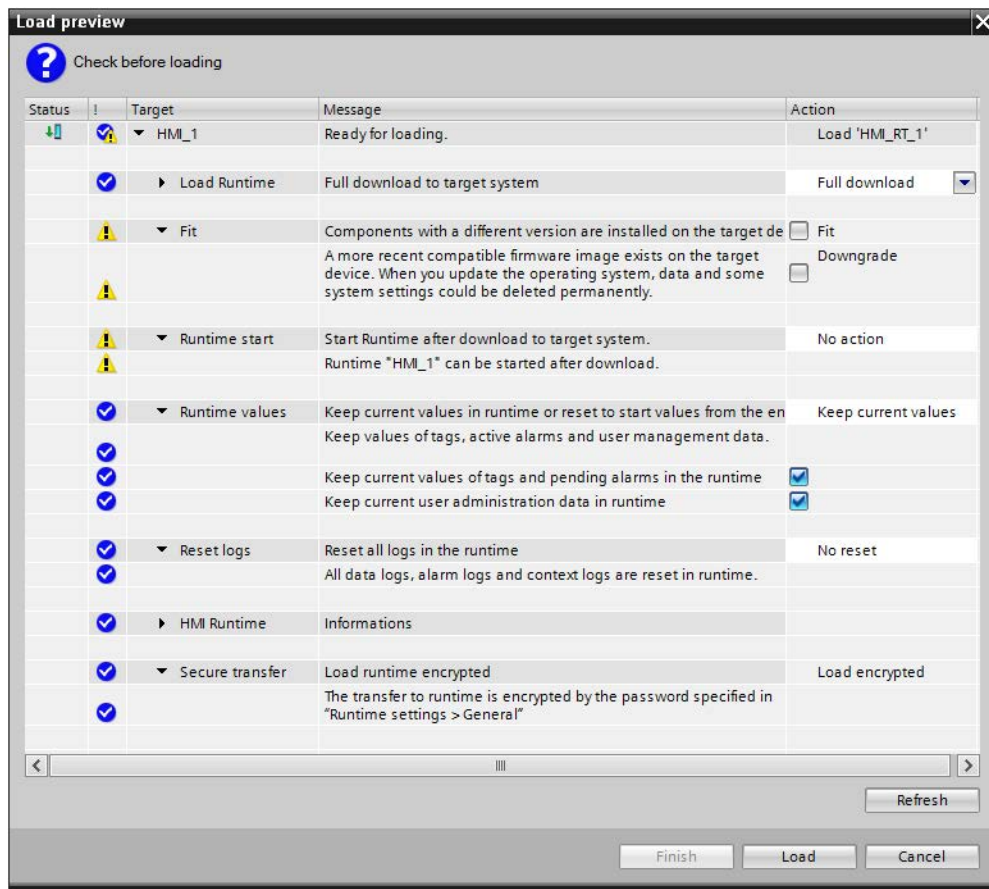

The "Load preview" dialog box contains alarms of type "Information" and "Warning".

	Information	The setting is compatible, the project can be loaded.
	Warning It is not possible to change the setting in the "Action" column.	The setting on the HMI device differs from the settings in the configuration software. The project can still be loaded with this setting.
	Warning The setting in the "Action" column can be changed.	Note that the setting on the HMI device is different from the setting in the configuration software. The project can be loaded after the setting in the "Action" column has been changed.
	Error It is not possible to change the setting in the "Action" column.	The project cannot be loaded. Adapt the setting in the configuration or on the HMI device.
	Error The setting in the "Action" column can be changed.	The project cannot be loaded. The project can be loaded after the setting in the "Action" column has been changed.

11. In the "Load preview" dialog box, specify the options for the loading process.
 - "Load Runtime": Selection list for overwriting or keeping the runtime software on the HMI device.
 - "Fit": In this area you define whether the version of individual components should be adjusted if the version of the component in the configuration differs from the version of the component on the HMI device. If the version on the HMI device is more recent, you can select "Downgrade", otherwise "Upgrade".

When you update the operating system via "Upgrade", observe the Important notes on updating the operating system (Page 155).
 - "Runtime start": Selection list that allows you to specify whether the runtime software is started on the HMI device after loading or not.
 - "Runtime values": In this area you define whether the data of tags, alarms and the user administration should be retained on the HMI device or not. If the respective option is selected, the data on the HMI device will be retained. If the respective option is cleared, then the data on the HMI device will be deleted or overwritten by the data in the configuration. If you want to update user administration on the HMI device, the "Keep current user administration data in runtime" option must be cleared.
 - "Reset logs": Selection list for resetting or keeping all logs. If you select "Reset all", the data of all data logs, alarm logs and context logs are deleted on the HMI device.
 - "HMI Runtime": This area contains information about runtime and firmware/operating system version of the HMI device.
 - "Secure transfer": In this area you determine whether the project is transferred encrypted or not. Additional information is available in the section "Transfer (Page 125)".

If a warning with light red text is no longer displayed, the "Download" icon in the left "Status" column of the "Load preview" dialog is displayed in green and the "Load" button is activated.
12. Click "Load" to transfer the project to the HMI device.

The project is transferred to the HMI device. If errors or warnings occur during the transfer, alarms are displayed in the Inspector window under "Info> Download". After the successful transfer, the alarm "Load finished (errors: 0; warnings: 0)" is displayed.
13. In the Control Panel of the HMI device, select "Service and Commissioning" > "Transfer".
14. Clear the "Enable Transfer" option to protect the HMI device from an unintended transfer.

Result

The project is located on the HMI device and can be started. After the transfer, test the operating elements and screen changes in the "offline" mode. If all operating elements and screen changes function correctly, you can switch the HMI device to "online" mode.

6.7 Backup and restore

During data backup, the contents of the internal memory are saved in a backup on a configuration PC or on an external storage medium. Alarm logs and process value archives are not included in the backup. These archives are stored separately on an external storage medium. Back up these logs manually if required. If the HMI device is integrated in a network, you can also back up the data on a network drive.

The following data are saved in a backup:

- Operating system
- Control Panel settings
- Installed apps
- SIMATIC Edge data
- Project and parameter sets
- User management

A backup includes several files. The master file has the extension ".brf". The number of additional files varies; these files have the file name of the master file and a sequential number (".0", ".1", ".2", etc.) as an extension.

Backup to the configuration PC

To back up the data of the HMI device, follow these steps:

1. If a project is running on the HMI device, close the project.
2. Connect the HMI device to the configuration PC via the X1 or X2 interface. If possible, use the X2 interface with the highest bandwidth.
3. In the Control Panel of the HMI device, select "Network and Internet".
Ensure that the port selected for data transmission is activated for the interface used ("Activate this port for use").
4. In the Control Panel of the HMI device, select "Service and Commissioning" > "Transfer".
5. Make sure that the "Enable transfer" option is activated.
6. Open the configuration software with which the HMI device was configured.
7. In the project tree, select the HMI device whose data are to be backed up.
8. Select the "Backup" command in the menu "Online > HMI Device maintenance" .
9. If there is no connection to the HMI device, the connection dialog box is displayed. In this case, enter the connection settings for your HMI device. Click on the "Connect" button and then on "Create".
If the connection was successfully established, the "Complete backup" dialog box with information about the project and the HMI device is displayed.
10. Click on the "Backup" button.
The "SIMATIC ProSave [Backup]" dialog box is displayed.

11. Under "Data type", select which data of the HMI device should be saved.
12. Enter the file name of the backup in the "Save as" field.
13. Click "Start Backup".

The backup process is started. A dialog with a progress bar is displayed for each backup file both in ProSave and on the HMI device. The update operation can take time, depending on the connection selected.

Note

Do not rename backup files on the data storage medium

If you change the name of the saved backup files, these backup files can no longer be loaded into the HMI device using the "Restore" function. The backup files become unusable.

Leave the name of the backup files on the data storage medium unchanged.

Note

Copy backup files completely

If you copy the backup files, be sure to also copy the master file ".brf" together with all associated backup files (".0", ".1", ".2", etc.).

If one of the files is missing, the backup cannot be loaded.

Backup to data storage medium on the HMI device

As an alternative to the configuration PC, you can also save the data via the Control Panel of the HMI device on a data storage medium that is directly connected to the HMI device, see section "Backup (Page 128)".

Restore from the configuration PC

To restore the data of the HMI device, follow these steps:

1. If a project is running on the HMI device, close the project.
2. Connect the HMI device to the configuration PC via the X1 or X2 interface. If possible, use the X2 interface with the highest bandwidth.
3. In the Control Panel of the HMI device, select "Network and Internet". Ensure that the port selected for data transmission is activated for the interface used ("Activate this port for use").
4. In the Control Panel of the HMI device, select "Service and Commissioning" > "Transfer".
5. Make sure that the "Enable transfer" option is activated.
6. Open the configuration software with which the HMI device was configured.
7. In the project tree, select the HMI device whose data you want to restore.

8. Select the "Restore" command in the menu "Online > HMI Device maintenance" .
9. If there is no connection to the HMI device, the connection dialog box is displayed. In this case, enter the connection settings for your HMI device. Click the "Connect" button and then click "Load".
If the connection was established successfully, the "Complete restore" dialog box with information about the project and the HM device is displayed.
10. Click the "Restore" button.
The "SIMATIC ProSave [Restore]" dialog is displayed.
11. Under "Open from ..." enter path and file name of the backup.
12. Click "Start Restore".

The restore process is started. A dialog with a progress bar is displayed both in ProSave and on the HMI device for each backup file loaded. The update operation can take time, depending on the connection selected.

Do **not** switch off the HMI device during the restore process and do **not** disconnect the data source from the HMI device.

Note

System behavior when the process is interrupted

If the restore process cannot be completed due to a power failure or an interrupted data connection, for example, the HMI device starts in maintenance mode and the factory settings must be restored.

In this case, follow the procedure starting with step 6 in section "Resetting an HMI device to factory settings via ProSave (Page 158)".

Restore from a data storage medium on the HMI device

As an alternative to the configuration PC, you can also restore the data via the Control Panel of the HMI device from a data storage medium that is directly connected to the HMI device, see section "Restore (Page 134)".

6.8 Updating the operating system

6.8.1 Overview and important notes

The firmware and operating system version of the HMI device must be compatible with the firmware and operating system version of the installed WinCC software. If this is not the case, then you must update the operating system. If the operating system on the HMI device is no longer functional, you must reset the HMI device to factory settings.

NOTICE

Updating the operating system deletes data on the HMI device

Project, parameter sets and user administration will be deleted when you update the operating system on the HMI device.

Before updating the operating system, backup the data on the HMI device, if necessary.

All settings, except the following settings which you changed in the Control Panel before updating the operating system, are retained even after the update of the operating system:

- The external interfaces become activated again (default setting), see section "Hardware interfaces (Page 122)".
- The time zone is reset to the default setting "(UTC) Coordinated Universal Time", see section "Date and time (Page 123)".

When the operating system is reset to factory settings, all data of the HMI device is deleted and all settings in the Control Panel are reset to factory settings.

NOTICE

Automatic backup and updating the operating system

When the "Automatic backup" function is activated while the operating system is being updated, the HMI device may not start up again correctly.

If you want to update the operating system of the HMI device and have activated the "Automatic backup" function, follow these steps:

1. Deactivate the "Automatic backup" function.
2. Update the operating system.
3. Activate the "Automatic backup" function.

Leave the system memory card in the HMI device before and during the entire update.

The operating system is contained in several firmware files. The master file has the extension ".fwf". The number of additional files varies; these files have the file name of the master file and a sequential number (".0", ".1", ".2", etc.) as an extension.

Firmware files for the HMI devices can be downloaded from the Internet (<https://support.industry.siemens.com/cs/ww/en/view/109746530>). Observe the documentation included with the download.

Note

Do not rename firmware files

If you change the name of the firmware files, the operating system can no longer be updated with these firmware files. The firmware files become unusable. Leave the name of the firmware files unchanged.

Note

Copy firmware files completely

If you copy the firmware files, be sure to also copy the master file ".fwf" together with all associated firmware files (".0", ".1", ".2", etc.).

If one of the files is missing, the operating system cannot be loaded.

You have the following options for updating the operating system or restoring the factory settings of the HMI device, provided that access to the Control Panel of the HMI device is working:

- Updating the operating system via WinCC (Page 156)
- Updating the operating system via external storage medium (Page 126)
- Resetting an HMI device to factory settings via ProSave (Page 158)

If access to the Control Panel of the HMI device no longer works, follow the procedure described in the section "Using the maintenance mode (Page 162)".

6.8.2 Updating the operating system via WinCC

The firmware and operating system version of the HMI device must be compatible with the firmware and operating system version of the installed WinCC software. If this is not the case, then you must update the operating system.

NOTICE
Do not switch off the HMI device during data transfer
If you switch off the HMI device while the operating system of the HMI device is being updated, the HMI device no longer starts. You must repeat the procedure.
Do not turn off the HMI device during data transfer.

Procedure

To update the operating system, follow these steps:

1. If a project is running on the HMI device, close the project.
2. Connect the HMI device to the configuration PC via the X1 or X2 interface. If possible, use the X2 interface with the highest bandwidth.
3. In the Control Panel of the HMI device, select "Network and Internet".
Ensure that the port selected for data transmission is activated for the interface used ("Activate this port for use").
4. In the Control Panel of the HMI device, select "Service and Commissioning" > "Transfer".
5. Make sure that the "Enable transfer" option is activated.
6. Open the configuration software with which the HMI device was configured.
7. In the project tree, select the HMI device whose operating system you want to update.
8. Select the "Update operating system" command in the menu "Online > HMI Device maintenance" .
9. If there is no connection to the HMI device, the connection dialog box is displayed. In this case, select the "Ethernet" interface protocol, enter the IP address or name of the target device and click the "Connect" button and then "Update".
If the connection was established successfully, the "Update operating system" dialog box is displayed.
10. Under "Firmware file path ..." enter the path and file name of the firmware master file (.fwf) that contains the desired operating system.
11. Click "Update OS".

The update of the operating system is started. A dialog with a progress bar is displayed on the HMI device for each firmware file. The update operation can take time, depending on the connection selected.

Result

The operating system of the HMI device has been updated to the version of the selected firmware.

See also

Overview and important notes (Page 155)

Update OS (Page 126)

6.8.3 Resetting an HMI device to factory settings via ProSave

If the operating system on the HMI device is no longer functional, you must reset the HMI device to factory settings.

NOTICE

Do not switch off the HMI device during data transfer
--

If you turn off HMI device while the HMI device is being reset to factory settings, the HMI device will not start. You must repeat the procedure.

Do not turn off the HMI device during data transfer.
--

Procedure

To reset the HMI device to factory settings, follow these steps:

1. If a project is running on the HMI device, close the project.
2. Connect the HMI device to the configuration PC via the X2 interface.
3. In the Control Panel of the HMI device, select "Network and Internet".
Ensure that the port selected for data transmission is activated for the interface used ("Activate this port for use").
4. In the Control Panel of the HMI device, select "System Properties" > "Reboot".
5. Press the "Reboot in maintenance mode" button. The HMI device starts. The "Maintenance Mode" dialog box is displayed for a period of 10 minutes. In this period you can connect the HMI device to a configuration PC and reset the HMI device to factory settings with the ProSave software. If the "Maintenance Mode" dialog is not displayed, start the HMI device while pressing the "Maintenance" button, see section "Using the maintenance mode (Page 162)".
6. Open the "ProSave" software on the configuration PC in the WinCC installation directory.
7. Enter the following data in the "General" tab:
 - "Device type": Select the type of your HMI device.
 - "Connection": Select "Ethernet".
 - "Connection parameters": Specify an IP address or computer name for the HMI device. The IP address must be located in the subnet of the configuration PC.

8. Enter the following data in the "OS Update" tab:
 - Under "Opening ...", select the path and file name of the firmware master file (.fwf) containing the desired operating system.
 - Select the option "Reset to factory settings".
 - Under "MAC", enter the MAC address which is shown at the top right of the HMI device display.
 - Use the "Device status" button to display information about the device and the selected firmware.
9. Click "Update OS". A dialog box with the warning that all data on the HMI device will be overwritten is displayed.
10. Confirm the dialog box.

The update of the operating system with "Reset to factory settings" is started. The progress of the update is displayed both in ProSave and on the HMI device. The update operation can take time, depending on the connection selected. The HMI device restarts at the end of the process.

Result

The operating system of the HMI device has been updated to the version of the selected firmware and the HMI device is reset to factory settings.

See also

Overview and important notes (Page 155)

Device maintenance and repair

7.1 General information on maintenance and servicing

Observe the following when servicing and repairing protective equipment such as ground circuits or overvoltage protection components:

- Observe the maintenance and replacement intervals specified by the manufacturer.
- Replace plant components, including external cables, fuses and batteries only with equivalent components approved by the respective manufacturer.

7.2 Clean the glass front of the HMI device.

The HMI device is designed for low-maintenance operation. However, you should clean the glass front regularly.

Observe the information on chemical resistance (<https://support.industry.siemens.com/cs/ww/en/view/39718396>).

Important notes

Note**Avoid unintentional responses during cleaning**

If you clean the glass front when it is switched on, you may cause inadvertent operations via the touch screen.

Switch off the HMI device during cleaning.

Note**Avoid damage to the front**

The glass front may be damaged if compressed air or a steam jet is used and if aggressive solvents or abrasives are used.

Do not clean the glass front using compressed air or steam cleaners. Do not use aggressive solvents or scouring agents.

Requirement

- Damp cleaning cloth
- Dishwashing liquid or foaming screen cleaning agent

Procedure

Proceed as follows:

1. If a project is running on the HMI device, close the project.
2. Switch off the HMI device.
3. Spray cleaning agent onto the cleaning cloth.
Do not spray cleaning agent directly onto the HMI device.
4. Clean the glass front.
When cleaning the glass front, wipe from the inside to the outside.

7.3 Using the maintenance mode

Maintenance mode is used to reset the HMI to the factory settings.

When the operating system starts and the Control Panel is displayed after the HMI device is switched on, you can start the HMI device in maintenance mode by clicking the "Reboot in maintenance mode" button. Follow the description in section "Resetting an HMI device to factory settings via ProSave (Page 158)".

If the HMI starts with the boot splash screen and detects the corrupt operating system, the HMI automatically switches to maintenance mode. The "Maintenance Mode" dialog box is displayed. In this case, follow the procedure from step 6 in section "Resetting an HMI device to factory settings via ProSave (Page 158)".

If the HMI device starts with the boot splash screen and does not detect the corrupt operating system, the HMI device does **not** switch to maintenance mode. The "Maintenance Mode" dialog is **not** displayed. You must reset the HMI device to the factory settings. In this case, start the HMI device while pressing the "Maintenance" button as described in this section.

NOTICE

The operating system must be updated in maintenance mode

If you start the HMI device while pressing the "Maintenance" button, the HMI device is in maintenance mode. In maintenance mode, the "Maintenance Mode" dialog is displayed. The operating system **must** be updated.

Only start the HMI device while pressing the "Maintenance" button if you are sure that you want to update the operating system.

Procedure

Proceed as follows:

1. Turn off the power supply of the HMI device.
2. Press the "Maintenance" button. Use a blunt, sufficiently sturdy tool made of non-conductive material, diameter approx. 5 mm.

You will find the "Maintenance" button in the opening between the two interfaces X1 and X2.

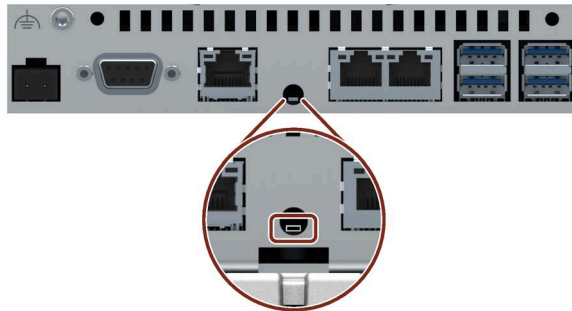

Be sure to hit the button accurately and do not slide the tool off the button.

3. Switch on the power supply of the HMI device and keep the "Maintenance" button pressed until the boot splash screen appears.

The HMI device restarts, the "Maintenance Mode" dialog box is displayed. Connect the HMI device to a configuration PC and reset the HMI device to the factory settings using the ProSave software. Follow the procedure from step 6 in the section "Resetting an HMI device to factory settings via ProSave (Page 158)".

7.4 Spare parts and repairs

Repairs

Contact your Siemens representative (<https://www.siemens.com/aspa>). Filter by expertise, product and region.

Your contact person will let you know if a product can be repaired and how to return it.

Contact your representative before returning a product, including when you would like to request prioritized handling of your repair, a cost estimate, a repair report or an examination report.

The representative can also provide information about spare parts, if available.

Spare parts

Spare parts and accessories for the HMI device can be found in section "Accessories (Page 16)".

7.5 Recycling and disposal

Due to the low levels of pollutants in the HMI devices described in these operating instructions, they can be recycled.

Contact a certified disposal service company for electronic scrap for environmentally sustainable recycling and disposal of your old devices and dispose of the device according to the relevant regulations in your country.

Technical information

8.1 Software license agreements

Open Source Software

Observe the software license agreements for Open Source Software on the supplied "Open Source Software License Conditions" data medium.

8.2 Labels, certificates and approvals

Note

Approvals on the rating plate

The following overview shows possible approvals.

Only the approvals specified on the rating plate apply to the device.

CE marking



The devices meet the general and safety-related requirements of the following EU directives and conform with the harmonized European standards (EN) published in the official gazettes of the European Union and confirmed in the EU Declarations of Conformity:

- 2014/30/EU "Electromagnetic Compatibility Directive" (EMC Directive)
- 2011/65/EU "Directive of the European Parliament and of the Council of 8 June 2011 on the restriction of the use of certain hazardous substances in electrical and electronic equipment" (RoHS Directive)

When the device has Ex approval, the following also applies:

- 2014/34/EU "Equipment and protective systems intended for use in potentially explosive atmospheres" (Directive for Explosion Protection)

EU Declarations of Conformity

The EU Declarations of Conformity are available to the relevant authorities at the following address:

Siemens AG
 Digital Industries
 Factory Automation
 DI FA TI COS
 P.O. Box 1963
 D-92209 Amberg

You can also download these on the Internet using the keyword "Declaration of Conformity" at the following address: Unified Comfort Panels certificates

(<https://support.industry.siemens.com/cs/ww/en/ps/26033/cert>)

UKCA marking



The devices fulfil the general and safety-related requirements of the following regulations and related amendments, and complies with the designated British standards (BS) published in the official consolidated list of the British Government.

- Electromagnetic Compatibility Regulations 2016 (EMC)
- The Restriction of the Use of Certain Hazardous Substances in Electrical and Electronic Equipment Regulations 2012 (RoHS)

When the device has Ex approval, the following also applies:

- Equipment and Protective Systems Intended for use in Potentially Explosive Atmospheres Regulations 2016 (Explosion Protection)

UK Declarations of Conformity

The UK Declarations of Conformity are available to the relevant authorities at the following address:

Siemens AG
Digital Industries
Factory Automation
DI FA TI COS
P.O. Box 1963
D-92209 Amberg

You can also download these on the Internet using the keyword "Declaration of Conformity" at the following address: Unified Comfort Panels certificates (<https://support.industry.siemens.com/cs/ww/en/ps/26033/cert>)

UL approval



Observe the following notes:

- The device shall be supplied from an isolating source.
- Only for use in LAN, not for connection to telecommunication circuits.

Underwriters Laboratories Inc. (E116536) in accordance with

- UL 61010-1 and UL 61010-2-201
- CAN/CSA C22.2 No. 61010-1 and 61010-2-201

or

Underwriters Laboratories Inc. (E222109) in accordance with

- UL 61010-1 and UL 61010-2-201
- CAN/CSA C22.2 No. 61010-1 and 61010-2-201
- UL 121201 (Hazardous Location)
- CAN/CSA C22.2 No. 213 (Hazardous Location)

Approved for use in

- Class I, II, III, Division 2, Group A, B, C, D, E, F, G; T4
- Class I, Zone 2, Group IIC T4
- Class II, Zone 22, Group IIIA, IIIB, IIIC T135
- non-hazardous locations

FM Approval

Factory Mutual Research (FM) conforming to

- Approval Standard Class number 3611, 3600, 3810
- ANSI/ISA 61010-1
- ANSI/UL 121201
- ANSI/NEMA 250
- CAN/CSA C22.2 No. 213
- CAN/CSA C22.2 No. 61010-1

Approved for use in

- Class I, II, III, Division 2, Group A, B, C, D, E, F, G; T4
- Class I, Zone 2, Group IIC T4
- Class II, Zone 22, Group IIIA, IIIB, IIIC T135

Installation Instructions for cFMus:

WARNING – Do not remove or replace while circuit is live when a flammable or combustible atmosphere is present.

WARNING – Substitution of components may impair suitability of the equipment.

CAUTION – To prevent injury, read the manual before use.

WARNING – The equipment is intended to be installed within an enclosure/control cabinet. The inner service temperature of the enclosure/control cabinet corresponds to the ambient temperature of the module. Use cables with a maximum permitted operating temperature of at least 20 °C higher than the maximum ambient temperature.

ATEX/UKEX/IECEX approval**Notes on use in hazardous areas**

Observe the following FAQ regarding the use of an HMI device in hazardous areas: FAQ 291285 (<https://support.industry.siemens.com/cs/ww/en/view/291285>)

When using the device in hazardous areas, ensure that all plugs connected to the device are secured in a captive manner, see section "Securing cables for use in hazardous areas (Page 53)".

You can find more information about explosion protection, EU/UK Declarations of Conformity and other certificates on the Internet at the following address:

Unified Comfort Panels certificates
(<https://support.industry.siemens.com/cs/ww/en/ps/26033/cert>)

ATEX/UKEX approval

For an HMI device with "Ex" marking, the following approvals apply according to the following standards.

- Standards:
 - EN IEC 60079-0
 - EN IEC 60079-7
 - EN 60079-31
- Approvals:

	II 3 G	Ex ec IIC T4 Gc
	II 3 D	Ex tc IIIC T 70 °C Dc

IECEx approval

For an HMI device with "IECEx" marking, the following approvals apply according to the following standards.

- Standards:
 - IEC 60079-0
 - IEC 60079-7
 - IEC 60079-31
- Approvals:

	Ex ec IIC T4 Gc
	Ex tc IIIC T70°C Dc

CCCEX approval



The following approvals according to the following standards are valid for a device with the "CCC" marking.

- Standards:
 - GB/T 3836.1 (Explosive atmospheres - Part 1: Equipment - General requirements)
 - GB/T 3836.3 (Explosive atmospheres - Part 3: Equipment protection by increased safety "e")
 - GB/T 3836.31 (Explosive atmospheres - Part 31: Equipment dust ignition protection by enclosure "t")
- Approvals:
 - Ex ec IIC T4 Gc
 - Ex tc IIIC T70°C Dc

Special conditions of use

- The front of the HMI device provides a degree of protection of at least IP65.
The front of the HMI device must be installed in a certified enclosure which offers a degree of protection of at least IP54 in accordance with GB/T 3836.1 for Group II, IP54 in accordance with GB/T 3836.1 for Group IIIA and IIIB and IP6X in accordance with GB/T 3836.1 for Group IIIC.
During use, make allowances for the ambient conditions.
- The HMI device shall be protected from mechanical loads > 7 J and > 4 J in the region of the display.
- To avoid an electrostatic charge, wipe the enclosure surface with a damp cloth only.
- The ambient temperature within the enclosure specified in the design examination certificate under "Ratings" must be measured and monitored at 25 mm away from the device.
- When used in an area requiring the use of equipment with EPL Gc, the following additional conditions apply:
 - The equipment shall only be used in an area of not more than pollution degree 2, as defined in GB/T 16935.1.
 - Provisions shall be made to prevent the rated voltage from being exceeded by transient disturbances of more than 119 V.
- If the devices are used in conjunction with the optional 15", 19" or 22" accessories adapter frames, the following additional condition applies:
 - The devices must be installed in such a way that the risk of mechanical danger is low.

IEC 61010-2-201

The devices meet the requirements and criteria of the IEC 61010 standard, Safety Requirements for Electrical Equipment for Measurement, Control, and Laboratory Use - Part 2-201: Special requirements for control equipment.

IEC 61131

The devices meet the requirements and criteria of IEC 61131-2, Programmable Logic Controllers, Part 2: Operating resource requirements and tests.

RCM AUSTRALIA/NEW ZEALAND



This product meets the requirements of the standard EN 61000-6-4 Generic standards – Emission standard for industrial environments.

KOREA



This product satisfies the requirement of the Korean Certification (KC Mark).

이 기기는 업무용(A급) 전자파 적합기기로서 판매자 또는 사용자는 이 점을 주의하시기 바라며 가정 외의 지역에서 사용하는 것을 목적으로 합니다.

Note that this device conforms to Limit Class A for emission of radio interference. This device can be used in all areas except the residential area.

Identification for Eurasian Customs Union



EAC (Eurasian Conformity)

- Customs union of Russia, Belarus and Kazakhstan
- Declaration of conformity according to Technical Regulations of the Customs Union (TR CU)

WEEE label (European Union)



Disposal instructions, observe the local regulations and the section "Recycling and disposal (Page 164)".

Marine approvals

The following marine approvals are provided for the device.

- ABS (American Bureau of Shipping)
- BV (Bureau Veritas)
- DNV (Det Norske Veritas)
- LRS (Lloyds Register of Shipping)
- Class NK (Nippon Kaiji Kyokai)
- KR (Korean Register of Shipping)
- CCS (China Classification Society)
- RINA (Registro Italiano Navale)

After acceptance you will find the certificates on the Internet (<https://support.industry.siemens.com/cs/ww/en/ps/26033/cert>).

8.3 Electromagnetic compatibility

The device fulfills, amongst others, the requirements of the EMC directive applicable to the European domestic market.

Installing the device according to EMC directive

EMC-compliant mounting of the device and the use of interference-proof cables provide the basis for interference-free operation.

Observe the following manuals in addition to these operating instructions:

- Designing interference-free controllers
(<https://support.industry.siemens.com/cs/ww/en/view/59193566>)
- Industrial Ethernet/PROFINET – Passive network components
(<https://support.industry.siemens.com/cs/ww/en/view/84922825>)

Pulse-shaped disturbance

The following table shows the electromagnetic compatibility of the modules with regard to pulse-shaped interference. The precondition for electromagnetic compatibility is that the device meets the specifications and guidelines for electrical installation.

Pulse-shaped interference	Tested with	Test level equivalence
Electrostatic discharge in accordance with IEC 61000-4-2	Air discharge: 8 kV	3
	Contact discharge: 6 kV (front)	
	Contact discharge: 4 kV (rear)	2
Bursts (high-speed transient interference) in accordance with IEC 61000-4-4	2 kV supply cable 1 kV signal line, < 30 m	3
	2 kV signal line, > 30 m	4
High-energy single pulse (surge) according to IEC 61000-4-5	Asymmetrical coupling (line to ground):	
	• 1 kV supply line, DC voltage	2
	• 1 kV signal line/data cable, > 30 m	
	Symmetrical coupling (line to line):	
	• 0.5 kV power cable, DC voltage	2
• 1 kV signal line, > 30 m,	3	

Sinusoidal interference

The following table shows the EMC behavior of the modules with respect to sinusoidal interference. This requires the device to meet the specifications and directives for electrical installation.

Sinusoidal interference	Test values
HF radiation (electromagnetic fields) according to IEC 61000-4-3	80% amplitude modulation at 1 kHz <ul style="list-style-type: none"> • to 10 V/m from 80 MHz to 1 GHz • to 3 V/m from 1.4 GHz to 6 GHz
HF current feed on cables and cable shields according to IEC 61000-4-6	Test voltage 10 V, with 80% amplitude modulation of 1 kHz in the 150 kHz to 80 MHz range
Magnetic field strength according to IEC 61000-4-8	50/60 Hz; 30 A/m rms

Emission of radio interference

The following table shows the interference emission from electromagnetic fields according to EN 61000-6-4, measured at the following distance.

Radiated emission (emitted interference)

Frequency range	Measuring distance	Interference emission
30 MHz to 230 MHz	10 m	< 40 dB (µV/m) quasi-peak
230 MHz to 1000 MHz	10 m	< 47 dB (µV/m) quasi-peak
1 GHz to 3 GHz	3 m	< 76 dB peak and < 56 dB average
3 GHz to 6 GHz	3 m	< 80 dB peak and < 60 dB average

Emission of radio interference voltages

Frequency range	Interference emission
0.150 MHz to 0.5 MHz	< 79 dB quasi-peak and < 66 dB average
0.5 MHz to 30 MHz	< 73 dB quasi-peak and < 60 dB average

See also

EMC information in section "Notes about usage (Page 24)".

8.4 Mechanical ambient conditions

8.4.1 Storage conditions

The following information is valid for a device that is transported and stored in its original packaging.

The device was tested according to IEC 60721-3-2:2018 Class 2M4 with the following amendments and limitations:

Type of condition	Permitted range
Free fall	≤ 0.3 m
Vibration according to IEC 60068-2-6	5 ... 8.4 Hz, displacement 3.5 mm 8.4 ... 500 Hz, acceleration 1 g
Shock according to IEC 60068-2-27	250 m/s ² , 6 ms, 1000 shocks

8.4.2 Operating conditions

The following information applies to a device installed according to the specifications in these operating instructions.

The device was tested based on IEC 60721-3-3:2002 Class 3M3 with the following amendments and limitations:

Type of condition	Permitted range
Vibration according to IEC 60068-2-6	5 ... 8.4 Hz, deflection 3.5 mm 8.4 ... 200 Hz, acceleration 1 g
Shock according to IEC 60068-2-27	150 m/s ² , 11 ms, 3 shocks

Shock pulses within the specified range can be transferred to the display but do not impact the functionality of the device.

8.5 Climatic ambient conditions

8.5.1 Long-term storage

The following information applies to a device that is stored in its original packaging for longer than two weeks.

The device meets the requirements of IEC 60721-3-1:2018 Class 1K21.

8.5.2 Transport and short-term storage

The following information applies to a device that is transported in the original packaging and weather-proof packaging and stored for some time.

The device was tested according to IEC 60721-3-2:2018 Class 2K11 with the following amendments and limitations:

Type of condition	Permitted range
Temperature	-20 ... 60 °C
Atmospheric pressure	1140 ... 660 hPa, corresponds to an elevation of -1000 to 3500 m
Relative humidity	10 ... 90 %
Pollutant concentration	According to ANSI/ISA-71.04-2013 severity level G3

Note

If dewing has developed, wait until the HMI device has dried completely before switching it on.

Do not expose the HMI device to direct radiation from a heater.

8.5.3 Operating conditions

The following information applies to a device installed according to the specifications in these operating instructions.

The HMI device is designed for weatherproof and stationary operation according to IEC 60721-3-3.

The device was tested according to IEC 60721-3-3:2019 Class 3K22 with the following amendments and limitations:

Type of condition	Mounting position	MTP700-1500	MTP1900-2200
Temperature, Mounting in landscape format	Vertical	0 ... 50 °C	0 ... 45 °C
	Inclined, maximum inclination 35°	0 ... 40 °C	
Temperature, Mounting in portrait format	Vertical	0 ... 40 °C	
	Inclined, maximum inclination 35°	0 ... 35 °C	
Air pressure ¹ , operation elevation	1140 ... 795 hPa, corresponds to an elevation of -1000 to 2000 m		
Relative humidity	From 10 ... 90%, no condensation at the rear of the device		
Pollutant concentration	According to ANSI/ISA-71.04-2013 severity level G3		

¹ No pressure difference is allowed inside and outside the enclosure / control cabinet

Observe the Notes on use (Page 24) and section "Permitted mounting positions (Page 28)".

Also observe the climate diagram in the following section.

Note

The system components connected to the HMI device, the power supply for example, must also be suited to the respective operating conditions.

8.5.4 Climate diagram

The diagram below shows the extended range for temperature and humidity during continuous operation based on IEC 60721-3-3:2019 Class 3K22.

The information applies to a device installed in landscape format without inclination.

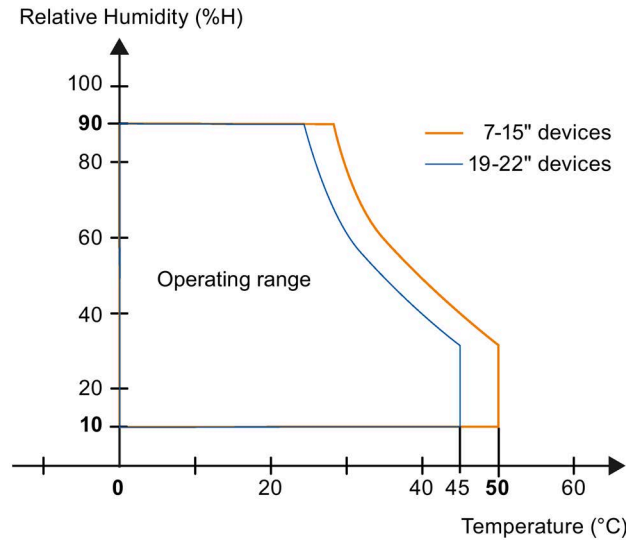

8.6 Information on insulation tests, protection class and degree of protection

Insulation test

The insulation strength is demonstrated in the type test with the following test voltages in accordance with IEC 61010-2-201:

Circuit	Insulation tested with (type test)
Rated voltage U_e 24 V	707 V DC to other circuits / to ground
Ethernet connector	1500 V AC

Degree of pollution and overvoltage category

The device meets the following requirements according to IEC 61010-2-201:

Degree of pollution	3 (front) 1 (rear)
Overtoltage category	II

Protection class

Protection class III according to IEC 61010-2-201.

Protection against foreign objects and water

The device meets the requirements according to IEC 60529 and UL50.

Device side	Degree of protection
Front	When mounted: <ul style="list-style-type: none"> • IP65 according to IEC 60529 • Type 4X/Type 12 (indoor use only, front face only) according to UL50
Rear	IP20 Protection against contact with standard test probes. There is no protection against the ingress of water, dust and noxious gas.

The degree of protection at the front can only be guaranteed if the mounting seal lies flush against the mounting cutout. Observe the corresponding information in section "Preparing the mounting cutout (Page 31)".

8.7 Dimension drawings

8.7.1 Dimension drawings of the MTP700 Unified Comfort

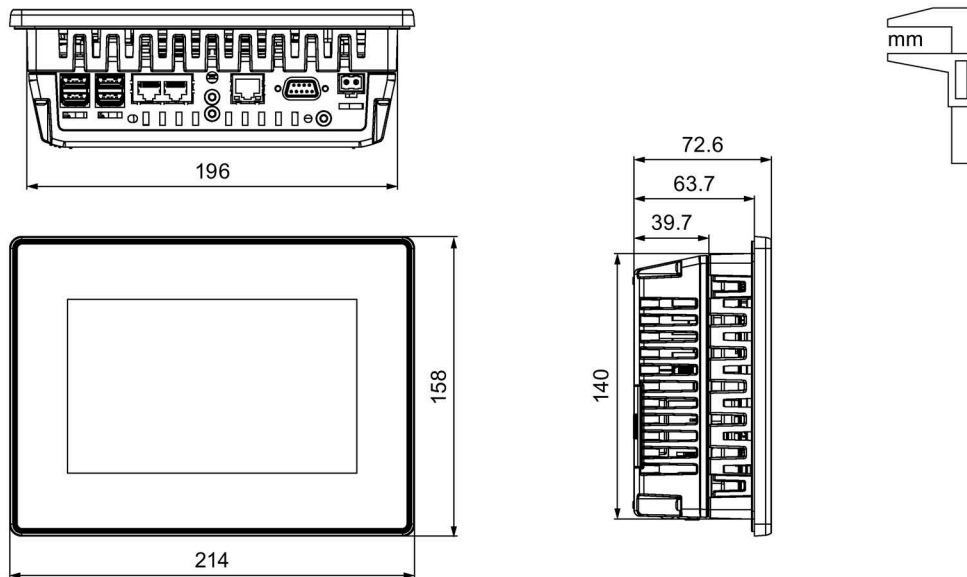

8.7.2 Dimension drawings of the MTP1000 Unified Comfort

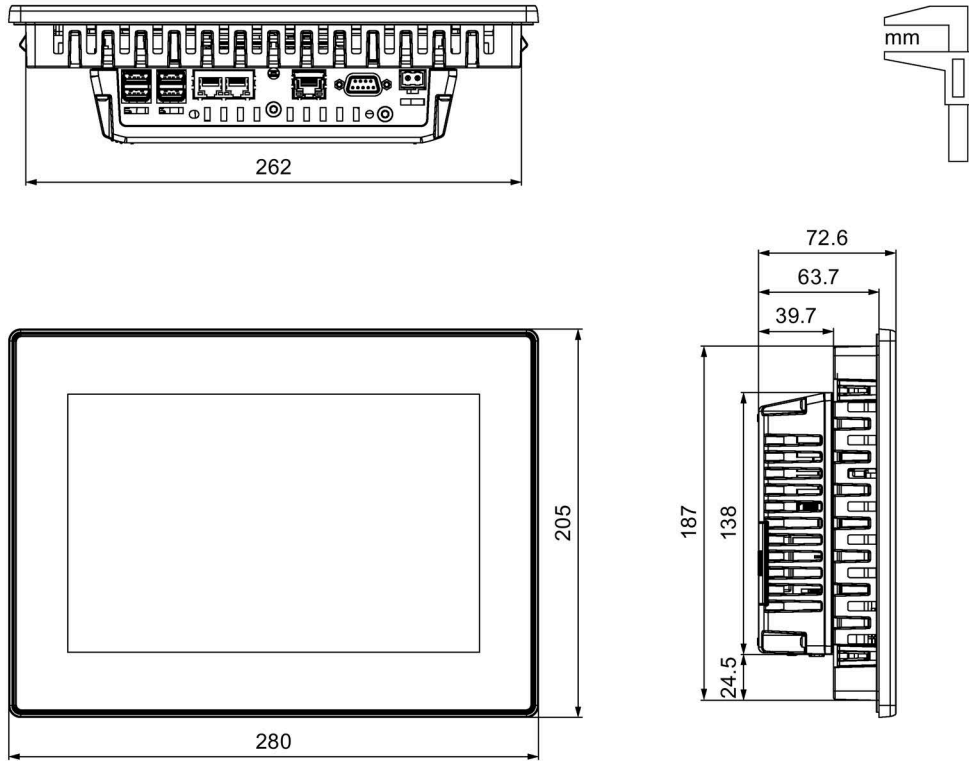

8.7.3 Dimension drawings of the MTP1200 Unified Comfort

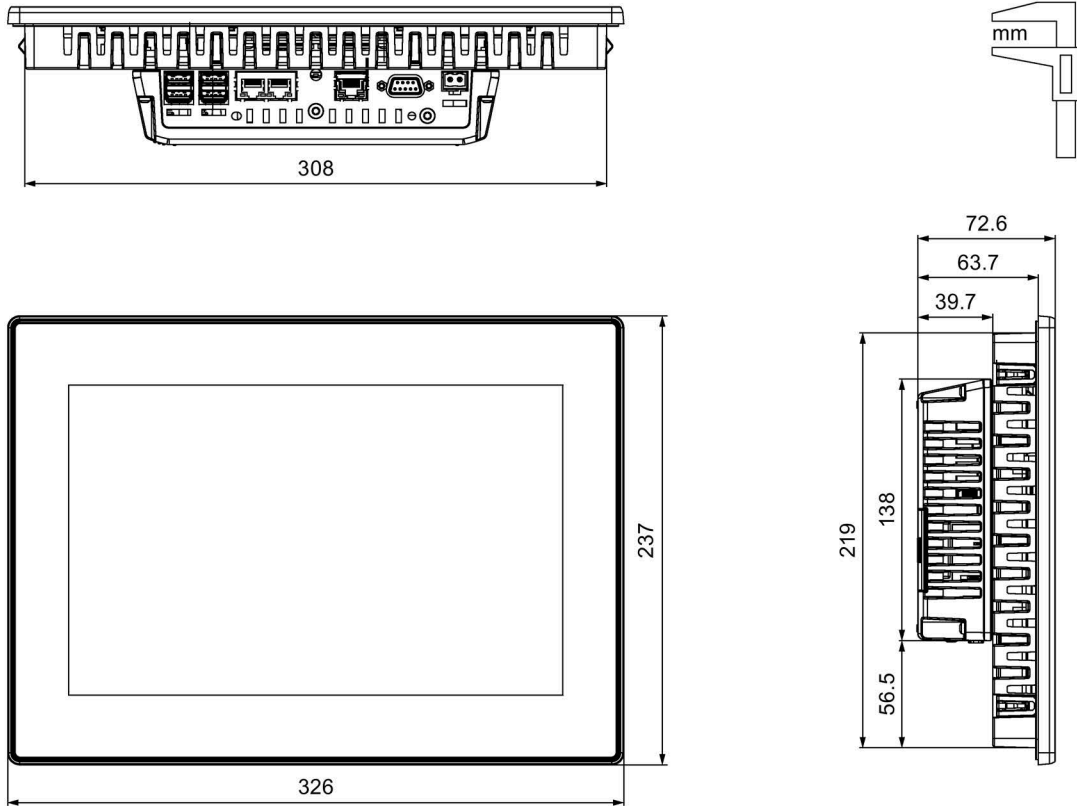

8.7.4 Dimension drawings of the MTP1500 Unified Comfort

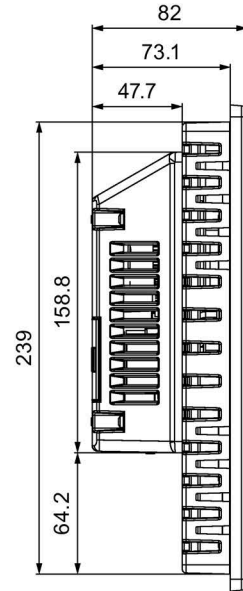
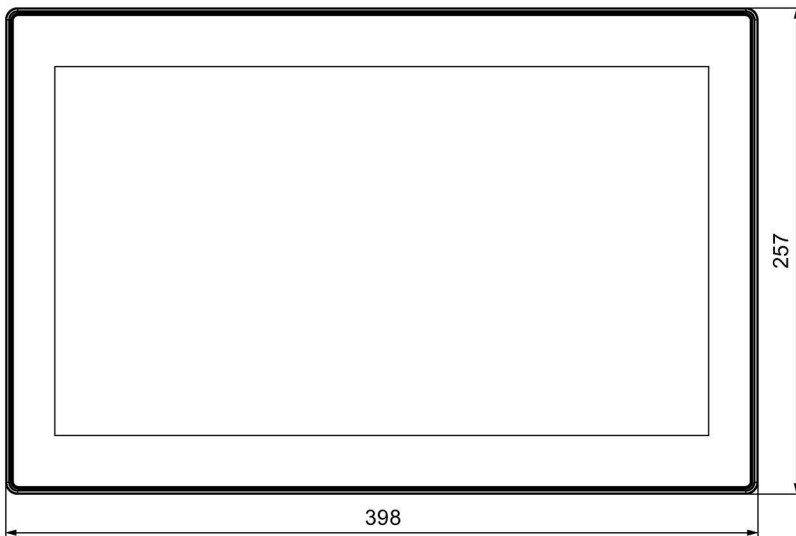
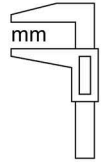
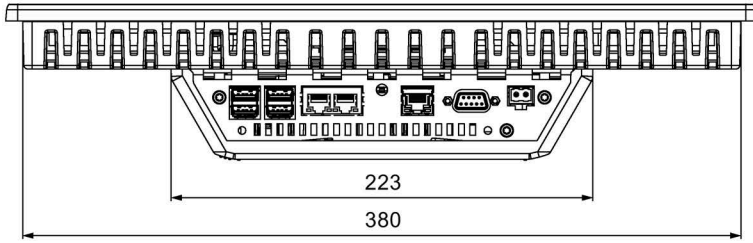

8.7.5 Dimension drawings of the MTP1900 Unified Comfort

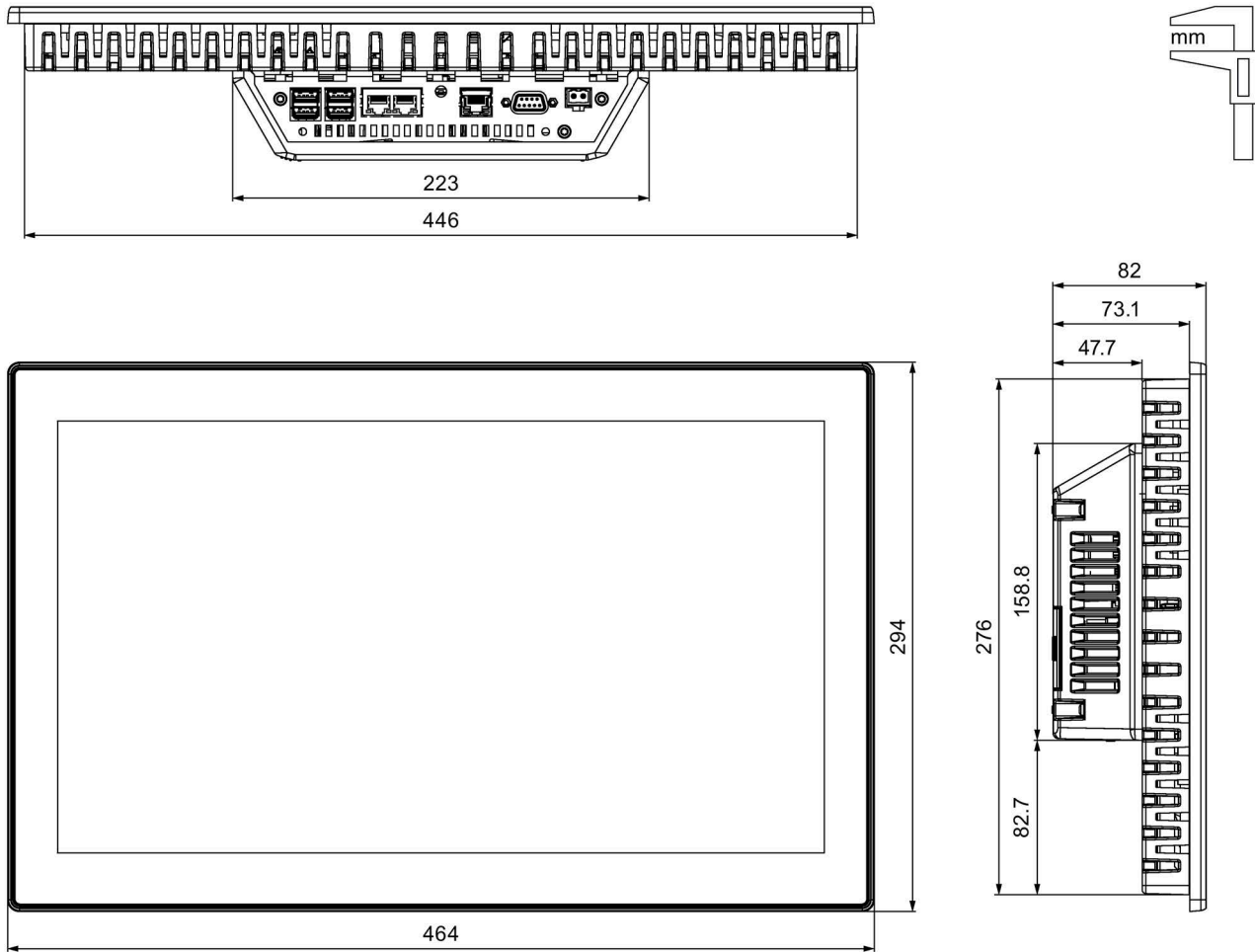

8.7.6 Dimension drawings of the MTP2200 Unified Comfort

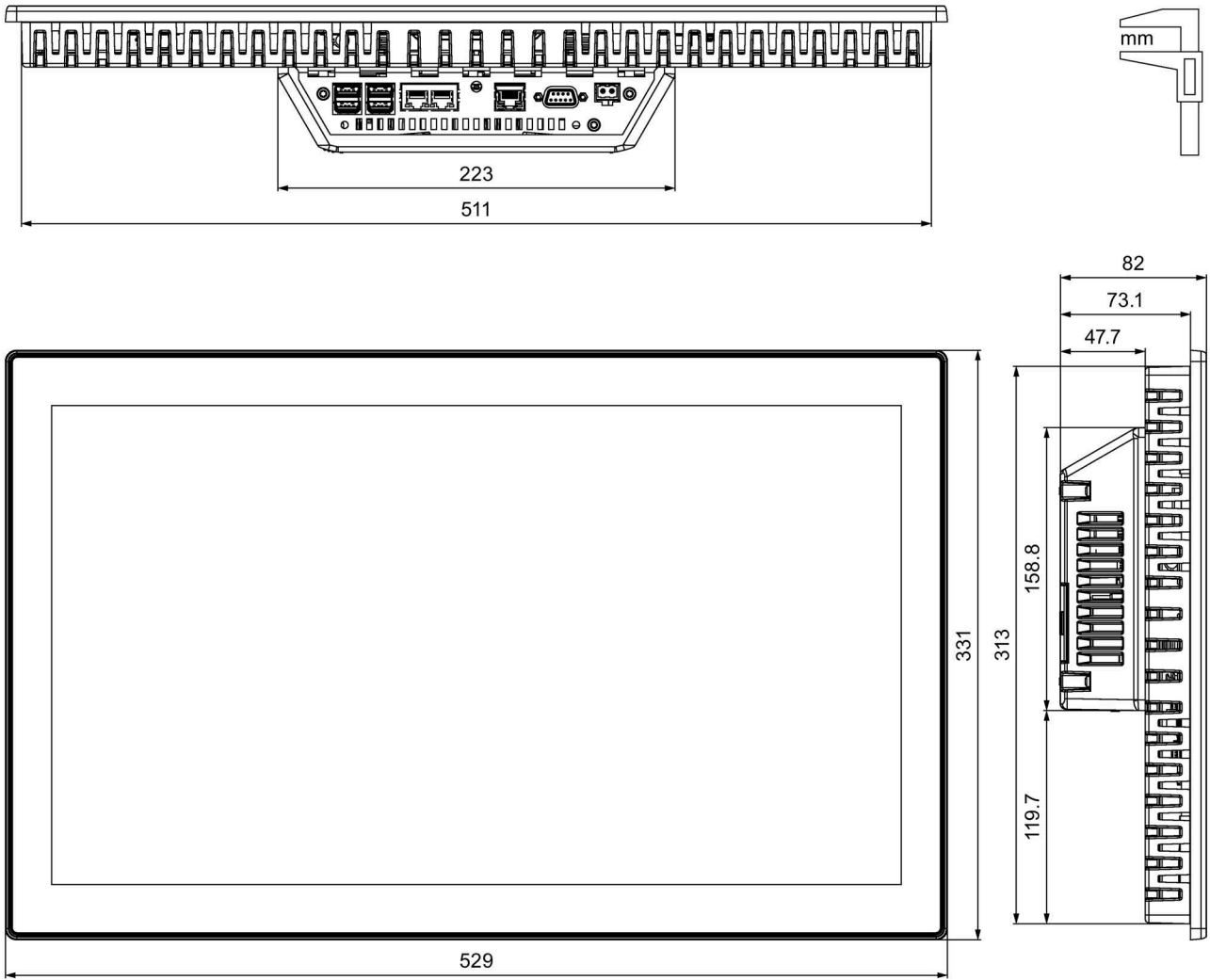

8.8 Technical specifications

8.8.1 MTP700, MTP1000, MTP1200 Unified Comfort

Weight

Unified Comfort HMI device	MTP700	MTP1000	MTP1200
Weight without packaging	1.4 kg	2.1 kg	2.8 kg

Display

Unified Comfort HMI device	MTP700	MTP1000	MTP1200
Type	LCD TFT		
Display diagonal	7.0"	10.1 "	12.1"
Active display area	152 x 91 mm	217 x 136 mm	261 x 163 mm
Resolution/pixels	800 x 480	1280 x 800	
Possible colors	Up to 16.7 million		
Brightness control via Control Panel, value range	5 ... 100 %		
Brightness control via WinCC, value range	0 ... 100 %, values below 5% are set to 5%		
Backlight	LED		
Half Brightness Life Time (MTBF ¹)	50000 h		
Pixel error class in accordance with ISO 9241-307	I		

¹ MTBF: Operating hours after which the maximum brightness is reduced by half compared to the original value. MTBF is increased by using the integrated dimming function, for example, time-controlled via screensaver or centrally via PROFlenergy.

Input device

Unified Comfort HMI device	MTP700	MTP1000	MTP1200
Multi-touch screen (capacitive)	Yes		

Memory

Unified Comfort HMI device	MTP700	MTP1000	MTP1200
Random access memory	4 GB LPDDR4-SDRAM		
Internal flash memory	32 GB eMMC pSLC		
Usable memory for application data	1 GB RAM, 2 GB flash memory		
Internal parameter set memory ¹	12 MB		
Data memory card and system memory card ²	2 x SD/SDHC/SDXC combination slot		

¹ Expandable via memory card in slot X51 or USB flash drive at interface X61 or X62

² Memory cards are available as SIMATIC HMI accessories

Interfaces

Unified Comfort HMI device	MTP700	MTP1000	MTP1200
RS 422/485	1 x SUB-D		
PROFINET (LAN)	2 x RJ45 10/100 Mbps ¹		
	1 x RJ45 10/100/1000 Mbps		
USB 3.1 Gen. 1 (Type A)	4 x Host ²		

¹ With integrated switch (one IP address only)

² USB Type A; maximum load per interface: 900 mA; maximum total load of all interfaces: 1.2 A

Power supply

Unified Comfort HMI device	MTP700	MTP1000	MTP1200
Rated voltage	24 V DC		
Permitted voltage range	+19.2 V ... +28.8 V		
Mains and voltage buffering time	20 ms, corresponds to PS2 according to IEC 61131-2		
Rated current at 24 V DC, without loads	0.45 A	0.5 A	0.6 A
Rated current (min. ... max.), load-dependent	0.45 ... 1.0 A	0.52 ... 1.1 A	0.6 ... 1.3 A
Power consumption, without loads ¹	10.8 W	12.5 W	14.5 W
Inrush current I ² t	0.5 A ² s		
Maximum permitted transient	35 V (500 ms)		
Minimum time between two transients	50 s		
Internal protection	Yes		

¹ The power loss generally corresponds to the specified value for power consumption.

The current and power specifications apply without a high permanent processor load by apps.

Miscellaneous

Unified Comfort HMI device	MTP700	MTP1000	MTP1200
Buffered real-time clock ¹	Yes		

¹ Buffering time typically 6 weeks

8.8.2 MTP1500, MTP1900, MTP2200 Unified Comfort

Weight

Unified Comfort HMI device	MTP1500	MTP1900	MTP2200
Weight without packaging	4.3 kg	5.5 kg	6.9 kg

Display

Unified Comfort HMI device	MTP1500	MTP1900	MTP2200
Type	LCD TFT		
Display diagonal	15.6"	18.5"	21.5"
Active display area	344 x 193 mm	409 x 230 mm	476 x 268 mm
Resolution/pixels	1366 x 768	1920 x 1080	
Possible colors	Up to 16.7 million		
Brightness control via Control Panel, value range	10 ... 100%		
Brightness control via WinCC, value range	0 ... 100 %, values below 10% are set to 10%		
Backlight	LED		
Half Brightness Life Time (MTBF ¹)	50000 h	30000 h	
Pixel error class in accordance with ISO 9241-307	I		

¹ MTBF: Operating hours after which the maximum brightness is reduced by half compared to the original value. MTBF is increased by using the integrated dimming function, for example, time-controlled via screensaver or centrally via PROFlenergy.

Input device

Unified Comfort HMI device	MTP1500	MTP1900	MTP2200
Multi-touch screen (capacitive)	Yes		

Memory

Unified Comfort HMI device	MTP1500	MTP1900	MTP2200
Random access memory	4 GB LPDDR4-SDRAM		
Internal flash memory	32 GB eMMC pSLC		
Usable memory for application data	1 GB RAM, 2 GB flash memory		
Internal parameter set memory ¹	12 MB		
Data memory card and system memory card ²	2 x SD/SDHC/SDXC combination slot		

¹ Expandable via memory card in slot X51 or USB flash drive at interface X61 or X62

² Memory cards are available as SIMATIC HMI accessories

Interfaces

Unified Comfort HMI device	MTP1500	MTP1900	MTP2200
RS 422/485	1 x SUB-D		
PROFINET (LAN)	2 x RJ45 10/100 Mbps ¹		
	1 x RJ45 10/100/1000 Mbps		
USB 3.1 Gen. 1 (Type A)	4 x Host ²		

¹ With integrated switch (one IP address only)

² USB Type A; maximum load per interface: 900 mA; maximum total load of all interfaces: 1.2 A

Power supply

Unified Comfort HMI device	MTP1500	MTP1900	MTP2200
Rated voltage	24 V DC		
Permitted voltage range	+19.2 V ... +28.8 V		
Mains and voltage buffering time	20 ms, corresponds to PS2 according to IEC 61131-2		
Rated current at 24 V DC, without loads	0.7 A	1.2 A	1.0 A
Rated current (min. ... max.), load-dependent	0.7 ... 1.3 A	1.2 A ... 1.7 A	1.0 ... 1.5 A
Power consumption, without loads ¹	16.8 W	28.8 W	24.0 W
Inrush current I ² t	0.5 A ² s		
Maximum permitted transient	35 V (500 ms)		
Minimum time between two transients	50 s		
Internal protection	Yes		

¹ The power loss generally corresponds to the specified value for power consumption.

The current and power specifications apply without a high permanent processor load by apps.

Miscellaneous

Unified Comfort HMI device	MTP1500	MTP1900	MTP2200
Buffered real-time clock ¹	Yes		

¹ Buffering time typically 6 weeks

8.9 Description of the interfaces

8.9.1 DC24V X80

Power supply 24 V DC 2-pin

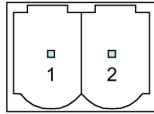

Pin	Meaning
1	+24 V DC
2	Ground

8.9.2 RS422/485 X20

Serial interface, 9-pin sub-D socket, female

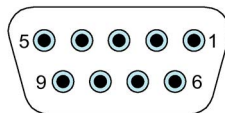

Pin	Assignment for the RS422	Assignment for the RS485
1	NC	NC
2	NC	NC
3	TxD+	Data signal B (+)
4	RxD+	RTS
5	GND 5 V, floating	GND 5 V, floating
6	+5 VDC, floating	+5 VDC, floating
7	NC	NC
8	TxD-	Data signal A (-)
9	RxD-	NC

8.9.3 PROFINET (LAN) X1

PROFINET (LAN) 10/100 Mbps, RJ45 socket

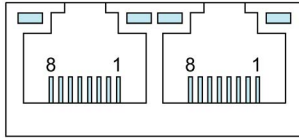

Pin	Name	Meaning
1	Tx+	Data output +
2	Tx-	Data output -
3	Rx+	Data input +
4	NC	Not assigned
5	NC	Not assigned
6	Rx-	Data input -
7	NC	Not assigned
8	NC	Not assigned

8.9.4 PROFINET (LAN) X2

PROFINET (LAN) 10/100/1000 Mbps, RJ45 socket

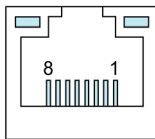

Pin	Name	Meaning
1	D1+	Bi-directional data 1+
2	D1-	Bi-directional data 1-
3	D2+	Bi-directional data 2+
4	D3+	Bi-directional data 3+
5	D3-	Bi-directional data 3-
6	D2-	Bi-directional data 2-
7	D4+	Bi-directional data 4+
8	D4-	Bi-directional data 4-

8.9.5 USB X61/X62/X63/X64

USB Type A

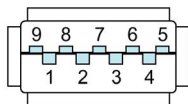

Pin	Name	Meaning
1	VBUS	+5 V, fused
2	D-	Data channel USB 2.0, bidirectional
3	D+	Data channel USB 2.0, bidirectional
4	GND	Ground
5	RX-	Data input USB 3.1 Gen. 1
6	RX+	Data input USB 3.1 Gen. 1
7	GND	Ground
8	TX-	Data output USB 3.1 Gen. 1
9	TX+	Data output USB 3.1 Gen. 1

8.10 Communication with controllers

Number of connections

The Unified Comfort Panels support a maximum of 16 connections to S7 controllers.

Controllers

The following controllers and communication drivers are supported by the HMI devices:

- SIMATIC S7-1200/1500
- SIMATIC S7-300/400
- OPC UA server
- OPC UA client

In addition, the following controllers and communication drivers are supported via TIA-integrated CSPs:

- Allen Bradley Ethernet/IP
- Mitsubishi iQR/iQF
- Mitsubishi MC TCP/IP
- OMRON Ethernet/IP
- Standard Modbus TCP/IP
- Standard Modbus RTU

Additional CSPs can be downloaded from the Internet

(<https://support.industry.siemens.com/cs/ww/en/view/109739698>). Observe the documentation in the respective download.

Using Secure HMI Communication

The HMI devices support Secure HMI Communication in conjunction with a controller that also supports Secure HMI Communication.

You can find detailed information on Secure HMI Communication in the:

- TIA Information System under "Editing devices and networks > Configuring devices and networks > Configuring networks > Secure communication"
- S7-1500, ET200 Communication Manual (<https://support.industry.siemens.com/cs/ww/en/view/59192925>)

The following sections describe the most important steps to use Secure HMI Communication on the HMI device.

Configuring Secure HMI communication

1. Configure the HMI device with an alarm view.

Note

You cannot detect errors when establishing a connection without the alarm view.

2. Configure the CPU with the necessary security settings. Select a PLC communication certificate to secure the HMI connection or have a PLC communication certificate generated by the TIA Portal.
3. Configure the HMI connection between CPU and HMI device.
4. Load the project onto the CPU and the HMI device. During the project transfer, the PLC communication certificate and if necessary a required CA certificate (certification authority) as well is transferred to the CPU and to the HMI device.

Note

Updating and loading the CPU configuration requires a new download to the HMI device

If the configuration of the CPU is changed and downloaded to the controller, the PLC communication certificate of the controller is updated. In this case, the PLC communication certificate of the HMI device must also be updated by means of a new project download.

Trusting the PLC communication certificate

During the connection setup, the CPU transfers the PLC communication certificate to the HMI device. Distinguish between the following cases:

- If the PLC communication certificate on the HMI device already has the "trusted" status, Secure HMI Communication between CPU and HMI device is automatically established.
- If the PLC communication certificate on the HMI device is not yet available with "trusted" status, the alarm view of the HMI device shows a message indicating that the CPU is not trusted along with an error code.

In this case, you have to mark the PLC communication certificate on the HMI device as "trusted".

To mark the PLC communication certificate as "trusted", do the following.

1. Open the Control Panel.
2. Select "Security > Certificates".
3. Select the entry "Other Certificates" from the "Certificate store" drop-down list.
4. Select the PLC communication certificate of the CPU in the "Other certificates" list.
5. Press the "Trust" button.
6. Start the HMI runtime software again.

If the PLC communication certificate on the HMI device has the "trusted" status, Secure HMI Communication can be established.

See also

Certificates (Page 115)

8.11 Scope of functions with WinCC

Performance features

The following tables of performance features help you to assess whether your project conforms to the system limits of an HMI device.

The specified maximum values are not additive. It cannot be guaranteed that configurations running on the devices at the full system limits will be functional.

In addition, the complexity of configuring the images, such as number of objects per screen, number of tag connections, cycle times and scripts, has a decisive influence on the image opening times and the performance in runtime.

In addition to the specified limits, observe the restrictions imposed by configuration memory resources.

More information on the performance features is available in the information system under "Visualizing processes (RT Unified) > Performance features > SIMATIC Unified Comfort Panel".

Tags

Unified Comfort HMI device	Display diagonal ≤ 12"	Display diagonal ≥ 15"
Number of tags in the project	8000	
Number of elements per array	1600	

Alarms

Unified Comfort HMI device	Display diagonal ≤ 12"	Display diagonal ≥ 15"
Number of alarm classes	32	
Number of discrete alarms	9000	
Number of analog alarms	300	
Length of an alarm in characters	512	
Number of alarm texts per interrupt	10	
Number of process values per alarm	10	
Number of queued alarm events	750	
Alarm buffer	Yes, configured as an alarm log	

Note

Observe the notes on using the internal memory

If too many alarms are written to the alarm buffer in short time intervals, the life of the internal memory and thus the service life of the HMI device will be reduced.

When configuring alarms, observe the notes on the internal memory in the section "Memory concept (Page 67)".

Screens

Unified Comfort HMI device	Display diagonal ≤ 12"	Display diagonal ≥ 15"
Number of screens	1200	
Number of lower-level screen windows	10	
Number of objects per screen	800	1200
Number of objects from the "Controls" area per screen	40	80
Number of tags per screen	600	800

Parameter sets

Unified Comfort HMI device	Display diagonal ≤ 12"	Display diagonal ≥ 15"
Number of parameter set types	750	
Number of parameter set type elements	1000	
Number of parameter sets	2000	
Reserved memory for data records in the internal flash ¹	12 MB	

¹ Expansion via memory card in slot X51 or USB flash drive at interface X61 or X62

Logs

Unified Comfort HMI device	Display diagonal ≤ 12"	Display diagonal ≥ 15"
Number of logs	50	
Number of logging tags, SQLite	5000	
Number of logging tags, Microsoft SQL	--	

Observe the notes on using logs in the section "Memory concept (Page 67)".

Trends

Unified Comfort HMI device	Display diagonal ≤ 12"	Display diagonal ≥ 15"
Number of trends	600	
Number of trends per trend view	20	
Number of trend areas per trend view	2	5

Text lists and graphics lists

Unified Comfort HMI device	Display diagonal ≤ 12"	Display diagonal ≥ 15"
Number of graphics lists	750	
Number of text lists	750	
Number of entries per text or graphics list	750	
Number of graphic objects	6000	
Number of text elements	60000	

Scripts

Unified Comfort HMI device	Display diagonal ≤ 12"	Display diagonal ≥ 15"
Number of Java scripts	600	
Number of functions per function list	25	

Scheduler

Unified Comfort HMI device	Display diagonal ≤ 12"	Display diagonal ≥ 15"
Number of tasks, time- or event-triggered	70	

Communication

Unified Comfort HMI device	Display diagonal ≤ 12"	Display diagonal ≥ 15"
Number of S7 connections	16	

Languages

Unified Comfort HMI device	Display diagonal ≤ 12"	Display diagonal ≥ 15"
Number of runtime languages	32	

User administration

Unified Comfort HMI device	Display diagonal ≤ 12"	Display diagonal ≥ 15"
Number of roles	50	
Number of predefined function rights	20	
Number of users	200	

Project

Unified Comfort HMI device	Display diagonal ≤ 12"	Display diagonal ≥ 15"
Size of the project files on the device	< 100 MB	

Technical Support

A.1 Service and support

You can find additional information and support for the products described on the Internet at the following addresses:

- Technical support (<https://support.industry.siemens.com>)
- Support request form (<https://www.siemens.com/supportrequest>)
- After Sales Information System SIMATIC IPC/PG (<https://www.siemens.com/asis>)
- SIMATIC Documentation Collection (<https://www.siemens.com/simatic-tech-doku-portal>)
- Your local representative (https://www.automation.siemens.com/aspa_app)
- Training center (<https://siemens.com/sitrain>)
- Industry Mall (<https://mall.industry.siemens.com>)
- TIA Selection Tool (<https://www.siemens.com/tia-selection-tool>)

When contacting your local representative or Technical Support, please have the following information at hand:

- MLFB of the device
- BIOS version for industrial PC or image version of the device
- Other installed hardware
- Other installed software

Firmware and software

Firmware and software for your HMI device are constantly being further developed. Check regularly whether software updates or patches are available for your HMI device and install the latest versions.

You can find the latest updates and patches for your HMI device on the Internet at the following addresses:

- HMI Panel Firmware (<https://support.industry.siemens.com/cs/ww/en/view/109746530>)
- WinCC (TIA Portal) Downloads (<https://support.industry.siemens.com/cs/ww/en/ps/24212/dl>)

Current documentation

Always use the current documentation available for your product. You can find the latest edition of this manual and other important documents by entering the article number of your device on the Internet (<https://support.industry.siemens.com>). If necessary, filter the entries by entry type "Manual".

A.2 Troubleshooting

This section contains information on localizing and rectifying possible faults.

Error message	Possible cause	Remedy
"Reset system memory card failed" "Start automatic backup failed"	System memory card is defective or wrong system memory card is inserted.	Replace the defective system memory card with a new SIMATIC SD memory card ≥ 32 GB.
"System card error"	The system memory card from a device of a different type has been inserted.	Replace the system memory card with the system memory card of a device of the same type. You can use the system memory card with the device without using the data of the system memory card. In this case, all the data in the "System Card\SIMATIC.HMI\Active" folder will be deleted.

A.3 Application examples and FAQs

Application examples

You can find application examples on the Internet at the following address:
Application Examples Unified Comfort Panels
(<https://support.industry.siemens.com/cs/ww/en/ps/26032/ae>).

FAQs

Frequently asked questions on Unified Comfort Panels are available on the Internet at the following address: FAQs Unified Comfort Panels
(<https://support.industry.siemens.com/cs/ww/en/ps/26032/faq>)

A.4 System alarms

System alarms on the HMI device provide information about internal states of the HMI device and the controller.

Note

System alarms are only displayed if an alarm window was configured. System alarms are output in the language currently set on your HMI device.

System alarm parameters

System alarms may contain encrypted parameters which are relevant to troubleshooting because they provide a reference to the source code of the runtime software. These parameters are output after the text "Error code:".

Observe the notes on configuring system alarms and using the alarm buffer in the section "Memory concept (Page 67)".

Description of the system alarms

You can find a list of system events for your HMI device in the TIA Portal information system.

A.5 Information about the manufacturer

Siemens AG is the manufacturer of the HMI devices described in this document.











The manufacturer address is:

Siemens AG
Digital Industries
Postfach 48 48
90026 NÜRNBERG
GERMANY





Markings and symbols

B.1 Safety-relevant symbols

The following table describes symbols that can be added to your SIMATIC device, to its packaging or to an enclosed document in addition to the symbols described in the manuals.

Symbol	Meaning	Reference
	General danger sign Caution / Attention You must following the operating instructions. The operating instructions contain information on the type of the potential hazard and enable you to identify risks and implement countermeasures.	ISO 7000 No. 0434B, DIN ISO 7000 No. 0434B
 ONLY EX MODULES	Attention, only relevant for modules with Ex approval	
	Follow the instructions	ISO 7010 M002
	May be installed by qualified electricians only	IEC 60417 No. 6182
 F<2N DISPLAY F<4N HOUSING	Mechanical load for HMI devices	
 CABLE SPEC.	Connection cables must be designed for the ambient temperature	
 EMC	EMC-compliant installation	
 U = 0V	No mounting or pulling & plugging under voltage	
 230V MODULES	Dangerous electrical voltage for 230V modules	ANSI Z535.2
 24V MODULES	Protection class III, supply only with protective low voltage (SELV/PELV)	IEC 60417-1-5180 "Class III equipment"

B.1 Safety-relevant symbols

Symbol	Meaning	Reference
 <p>INDOOR USE ONLY INDUSTRIAL USE ONLY</p>	<p>Only for industrial applications and indoor areas (control cabinet)</p>	
	<p>Device is to be integrated or installed in a control cabinet</p>	
 <p>ZONE 2 USE CABINET IP54</p>	<p>Integrate or install devices approved for Ex Zone 2 in a control cabinet with at least IP54</p>	
 <p>ZONE 22 USE CABINET IP6x</p>	<p>Integrate or install devices approved for Ex Zone 22 in a control cabinet with at least IP6x</p>	

Abbreviations

ANSI	American National Standards Institution
CA	Certificate Authority
CER	Internet security Certificate
CPU	Central Processing Unit
CRL	Certificate Revocation List
CSP	Communication Service Package
CSV	Comma Separated Values
CTS	Clear To Send
CUPS	Common Unix Printing System
DC	Direct Current
DCD	Data Carrier Detect
DHCP	Dynamic Host Configuration Protocol
DIL	Dual-in-Line (electronic chip housing design)
DNS	Domain Name System
DP	Distributed I/O
DSN	Data Source Name
DSR	Data Set Ready
DTR	Data Terminal Ready
IO	Input and Output
ESD	Components and modules endangered by electrostatic discharge
EMC	Electromagnetic Compatibility
EN	European standard
ES	Engineering System
ESD	Components and modules endangered by electrostatic discharge
GND	Ground
HF	High Frequency
HMI	Human Machine Interface
IEC	International Electronic Commission
IEM	Industrial Edge Management
IF	Interface
IP	Internet Protocol
LED	Light Emitting Diode
MAC	Media Access Control
MOS	Metal Oxide Semiconductor
MPI	Multipoint Interface (SIMATIC S7)
MS	Microsoft
MTBF	Mean Time Between Failures
n. c.	Not connected
OP	Operator Panel

PC	Personal Computer
PG	Programming device
PPI	Point-to-Point Interface (SIMATIC S7)
RAM	Random Access Memory
PELV	Protective Extra Low Voltage
RJ45	Registered Jack Type 45
RTS	Request to send
RxD	Receive Data
SD Memory Card	Abbreviation for Secure Digital Memory Card
SMB	Server Message Block
SELV	Safety Extra Low Voltage
SP	Service Pack
SUB-D	Subminiature D (plug)
TAB	Tabulator
TCP/IP	Transmission Control Protocol/Internet Protocol
TFT	Thin Film Transistor
TxD	Transmit Data
UL	Underwriter's Laboratory
UMAC	User Management and Access Control
UMC	User Management Component
USB	Universal Serial Bus
UPS	Uninterruptible power supply
WINS	Windows Internet Naming Service

Glossary

Alarm

An alarm may be a system alarm or a user-defined alarm. A user-defined alarm typically indicates a particular operating state of the plant, a system alarm typically contains information about the state of the HMI device.

Boot loader

The bootloader is used to start the operating system and is started automatically after the power on of the HMI device power. The Control Panel opens after the operating system has loaded.

Configuration PC

A configuration PC is a programming device or PC on which plant projects are created using engineering software.

Configuration software

Configuration software is used to create projects used for the purpose of process visualization. WinCC represents such configuration software, for example.

Controller

Controller is a general term for devices and systems with which the HMI device communicates, for example SIMATIC S7.

Degree of protection

The degree of protection specifies a standard of electronic equipment for a variety of ambient conditions – and the protection of humans against potential danger when using this equipment.

The degree of protection classified by IP differs from the protection class. But both involve protection against touching dangerous electric voltage. The IP degree of protection also classifies the protection of equipment against dirt and moisture.

Display duration

The display duration defines whether and for how long a message or a dialog box is displayed on the HMI device.

EMC

Electromagnetic compatibility (EMC) refers to a usually desirable state, in which technical equipment does not disturb one another with unwanted electrical or electromagnetic effects. Electromagnetic compatibility deals with technical and regulatory questions of undesired, mutual influence in electrical engineering.

Event

Functions are triggered by defined incoming events. Events can be configured. Events which can be assigned to a button include "Press" and "Release", for example.

Field

Area reserved in configured screens for the input and output of values.

Flash memory

Flash memory is a non-volatile memory with EEPROM chips that is implemented either as mobile storage medium, or as permanently installed memory module on the motherboard.

Half Brightness Life Time

Time period after which brightness is reduced to 50% of the original value. The specified value depends on the operating temperature.

HMI device

An HMI device is a device used for the operation and monitoring of machines and plants. The machine or plant states are visualized on the HMI device by means of graphic objects. The operator controls of the HMI device allow the operator to interact with the processes of the machine or plant.

HMI device image

The HMI device image is a file that can be transferred from the configuration PC or from an external storage medium to the HMI device. The HMI device image contains the operating system for the HMI device and the elements of the runtime software which are required to start and visualize the project file.

Input box

Use the input box to enter characters and values that are stored in the HMI device or transferred to the controller.

Job mail

A job mail triggers a function for the controller on the HMI device.

Object

An object is a project element such as a screen or an alarm. Objects are used to view or enter texts and values on the HMI device.

Operating element

An operating element is a component of a project used to enter values and trigger functions. A button, for example, is an operating element.

Parameter set

A parameter set is a combination of tags forming a fixed data structure. The configured data structure can be assigned data in the configuration software or on the HMI device and is then referred to as a record. The use of parameter sets ensures that all data assigned to a data record is transferred synchronously to the controller.

Plant

General term referring to machines, processing centers, systems and processes which are operated and monitored on an HMI device.

Process visualization

Process visualization is the representation of technical processes by means of text and graphic elements. Configured plant screens allow the operator to use input and output information to intervene in active plant processes.

Project

A project contains information on the visualization of the automation process and is created using a configuration software. The project normally contains several screens with embedded plant-specific objects, basic settings and alarms. A project configured with WinCC is saved in a file with extension "*.ap1x", where "x" stands for the version key. Example: "MyProject.ap16" for a WinCC V16 project.

Protection class

The protection class is used in electrical engineering to classify and identify electrical equipment in relation to existing safety measures designed to prevent electric shock. There are three protection classes for electrical equipment.

Runtime software

A project is started and visualized on the HMI device via the runtime software.

Screen

A screen is a form of visualization for all logically related process data in a plant. The representation of the process data can be visually supported by graphic objects.

Screen object

A screen object refers to objects such as rectangles, input boxes or alarm views which are configured for visualization or operation of the plant.

Tag

A tag is a defined memory location to which values can be written and from which values can be read. This can be done from the controller or the HMI device. We distinguish between external tags (process tags) and internal tags, depending on whether or not the tag is interconnected with the controller.

Trade goods

In addition to their own accessories, Siemens AG also offers high-quality accessories from well-known manufacturers as trade goods. Trade goods are qualified in a brief power-up test but do not undergo a system test by Siemens AG. The technical properties of trade goods can deviate from the properties guaranteed by comparable products of the Siemens AG. Trade goods are identified as such in the online catalog of the Siemens AG. Technical specifications, drivers, certificates, test verification documents, etc. are supplied by the respective manufacturer to Siemens AG and are also available for download in the online catalog or technical support of the Siemens AG.

Transfer

In "Transfer" mode, data is transferred from a configuration PC to the HMI device.

WinCC

WinCC (TIA Portal) is an engineering software for configuring SIMATIC HMI devices.