

SIEMENS

SITRANS L

Radar transmitters SITRANS LR560



Compact Operating Instructions

<u>Introduction</u>	1
<u>Safety notes</u>	2
<u>Installing/mounting</u>	3
<u>Connecting</u>	4
<u>Commissioning</u>	5
<u>Remote operation</u>	6
<u>Service and maintenance</u>	7
<u>Technical data</u>	8
<u>Product documentation and support</u>	A

Legal information

Warning notice system

This manual contains notices you have to observe in order to ensure your personal safety, as well as to prevent damage to property. The notices referring to your personal safety are highlighted in the manual by a safety alert symbol, notices referring only to property damage have no safety alert symbol. These notices shown below are graded according to the degree of danger.

 DANGER
indicates that death or severe personal injury will result if proper precautions are not taken.
 WARNING
indicates that death or severe personal injury may result if proper precautions are not taken.
 CAUTION
indicates that minor personal injury can result if proper precautions are not taken.
NOTICE
indicates that property damage can result if proper precautions are not taken.

If more than one degree of danger is present, the warning notice representing the highest degree of danger will be used. A notice warning of injury to persons with a safety alert symbol may also include a warning relating to property damage.

Qualified Personnel

The product/system described in this documentation may be operated only by **personnel qualified** for the specific task in accordance with the relevant documentation, in particular its warning notices and safety instructions. Qualified personnel are those who, based on their training and experience, are capable of identifying risks and avoiding potential hazards when working with these products/systems.

Proper use of Siemens products

Note the following:

 WARNING
Siemens products may only be used for the applications described in the catalog and in the relevant technical documentation. If products and components from other manufacturers are used, these must be recommended or approved by Siemens. Proper transport, storage, installation, assembly, commissioning, operation and maintenance are required to ensure that the products operate safely and without any problems. The permissible ambient conditions must be complied with. The information in the relevant documentation must be observed.

Trademarks

All names identified by ® are registered trademarks of Siemens AG. The remaining trademarks in this publication may be trademarks whose use by third parties for their own purposes could violate the rights of the owner.

Disclaimer of Liability

We have reviewed the contents of this publication to ensure consistency with the hardware and software described. Since variance cannot be precluded entirely, we cannot guarantee full consistency. However, the information in this publication is reviewed regularly and any necessary corrections are included in subsequent editions.

Table of contents

1	Introduction	6
1.1	Industrial use note	6
1.2	Purpose of this documentation	6
1.3	Security information	7
1.4	Checking the consignment.....	7
1.5	Transportation and storage	8
1.6	Notes on warranty	8
2	Safety notes	9
2.1	Preconditions for use	9
2.1.1	Safety marking symbols	9
2.1.2	Laws and directives.....	9
2.1.3	Improper device modifications	10
2.1.4	Federal Communications Commission (FCC) conformity (US).....	10
2.1.5	Radio equipment compliance (Europe and UK)	11
2.1.6	Industry Canada.....	11
2.1.7	Conformity with European directives.....	12
2.1.8	Conformity with UK regulations	12
2.2	Use in hazardous areas	13
2.3	Requirements for special applications.....	13
3	Installing/mounting	14
3.1	Basic safety notes	14
3.1.1	Exceeded maximum permissible operating pressure	15
3.1.2	Installation location requirements	16
3.1.3	Proper mounting	17
3.1.3.1	Incorrect mounting.....	17
3.2	Installation instructions.....	18
3.2.1	Environment.....	18
3.2.2	Nozzle location	18
3.2.3	Aimer adjustment	19
3.2.4	Air purging system.....	19
3.2.5	Pressure equipment directive (PED, 2014/68/EU) and UK Pressure Equipment Regulations 2016 (SI 2016/1105).....	20
3.3	Disassembly.....	21

4	Connecting	22
4.1	Basic safety notes	22
4.1.1	Incorrect connection to power source	23
4.1.2	Note on electromagnetic compatibility.....	24
4.2	Device status icons	25
4.3	Connecting SITRANS LR560.....	25
4.4	Nameplates for hazardous area installations.....	27
4.5	Instructions specific to hazardous area installations.....	29
4.5.1	European ATEX Directive 2014/34/EU, Annex II, 1.0.6 and UK Regulation SI 2016/1107	29
4.5.2	Special conditions of use.....	30
5	Commissioning	31
5.1	Basic safety notes	31
5.2	Activating the radar device.....	32
5.3	The LCD display	33
5.4	Commissioning via local display	34
5.4.1	Local operation.....	34
5.4.2	Quick Start Wizard via the local display push buttons.....	35
5.5	Commissioning via handheld programmer	36
5.5.1	Handheld programmer (Part No. 7ML1930-1BK)	36
5.5.2	Lithium batteries	36
5.5.3	Key functions in measurement mode	37
5.5.4	Programming	38
5.5.4.1	Quick Start Wizard via the handheld programmer.....	41
6	Remote operation.....	45
6.1	Operating via SIMATIC PDM	45
6.2	Operating via AMS Device Manager.....	45
6.3	Operating via FDT (Field Device Tool).....	45
6.4	Communication	45
6.4.1	HART	46
6.4.2	PROFIBUS PA.....	46
6.4.3	FOUNDATION FIELDBUS.....	46
7	Service and maintenance	47
7.1	Basic safety notes	47
7.1.1	Maintenance	47
7.1.2	Leaks in the sample gas path.....	48
7.2	Cleaning.....	48
7.3	Maintenance and repair work.....	49
7.3.1	Enclosure open.....	50
7.4	Return procedure.....	51
7.4.1	Return procedure.....	51
7.5	Disposal.....	51

8	Technical data.....	52
8.1	Performance	52
8.2	Power.....	53
8.3	Construction.....	53
8.4	Operating conditions	54
8.5	Process	55
8.6	Approvals	56
8.7	Communication	57
A	Product documentation and support.....	58
A.1	Product documentation	58
	Index.....	60

Introduction

1.1 Industrial use note

Note**Use in a domestic environment**

This Class B Group 1 equipment is intended for use in industrial areas.

1.2 Purpose of this documentation

These instructions are a brief summary of important features, functions and safety information, and contain all information required for safe use of the device. Read the instructions carefully prior to installation and commissioning. In order to use the device correctly, first review its principle of operation.

The instructions are aimed at persons who install and commission the device.

To realize optimum performance from the device, read the complete operating instructions.

1.3 Security information

Siemens provides products and solutions with industrial security functions that support the secure operation of plants, systems, machines and networks.

In order to protect plants, systems, machines and networks against cyber threats, it is necessary to implement – and continuously maintain – a holistic, state-of-the-art industrial security concept. Siemens' products and solutions constitute one element of such a concept.

Customers are responsible for preventing unauthorized access to their plants, systems, machines and networks. Such systems, machines and components should only be connected to an enterprise network or the internet if and to the extent such a connection is necessary and only when appropriate security measures (e.g. firewalls and/or network segmentation) are in place.

For additional information on industrial security measures that may be implemented, please visit

<https://www.siemens.com/industrialsecurity>.

Siemens' products and solutions undergo continuous development to make them more secure. Siemens strongly recommends that product updates are applied as soon as they are available and that the latest product versions are used. Use of product versions that are no longer supported, and failure to apply the latest updates may increase customer's exposure to cyber threats.

To stay informed about product updates, subscribe to the Siemens Industrial Security RSS Feed under

<https://www.siemens.com/industrialsecurity>.

1.4 Checking the consignment

1. Check the packaging and the delivered items for visible damages.
2. Report any claims for damages immediately to the shipping company.
3. Retain damaged parts for clarification.
4. Check the scope of delivery by comparing your order to the shipping documents for correctness and completeness.

 WARNING
Using a damaged or incomplete device
Risk of explosion in hazardous areas.
<ul style="list-style-type: none">• Do not use damaged or incomplete devices.

1.5 Transportation and storage

To guarantee sufficient protection during transport and storage, observe the following:

- Keep the original packaging for subsequent transportation.
- Devices/replacement parts should be returned in their original packaging.
- If the original packaging is no longer available, ensure that all shipments are properly packaged to provide sufficient protection during transport. Siemens cannot assume liability for any costs associated with transportation damages.

NOTICE
Insufficient protection during storage
The packaging only provides limited protection against moisture and infiltration.
<ul style="list-style-type: none">• Provide additional packaging as necessary.

Special conditions for storage and transportation of the device are listed in Operating conditions (Page 54).

1.6 Notes on warranty

The contents of this manual shall not become part of or modify any prior or existing agreement, commitment or legal relationship. The sales contract contains all obligations on the part of Siemens as well as the complete and solely applicable warranty conditions. Any statements regarding device versions described in the manual do not create new warranties or modify the existing warranty.

The content reflects the technical status at the time of publishing. Siemens reserves the right to make technical changes in the course of further development.



Safety notes

2.1 Preconditions for use

This device left the factory in good working condition. In order to maintain this status and to ensure safe operation of the device, observe these instructions and all the specifications relevant to safety.

Observe the information and symbols on the device. Do not remove any information or symbols from the device. Always keep the information and symbols in a completely legible state.

2.1.1 Safety marking symbols

In manual	On product	Description
	 (Label on product: yellow back- ground.)	WARNING: refer to accompanying documents (manual) for details.

2.1.2 Laws and directives

Observe the safety rules, provisions and laws applicable in your country during connection, assembly and operation. These include, for example:

- National Electrical Code (NEC - NFPA 70) (USA)
- Canadian Electrical Code (CEC Part I) (Canada)

Further provisions for hazardous area applications are for example:

- IEC 60079-14 (international)
- EN 60079-14 (EU and UK)

2.1.3 Improper device modifications

 WARNING
Improper device modifications Risk to personnel, system and environment can result from modifications to the device, particularly in hazardous areas. <ul style="list-style-type: none">• Only carry out modifications that are described in the instructions for the device. Failure to observe this requirement cancels the manufacturer's warranty and the product approvals.

2.1.4 Federal Communications Commission (FCC) conformity (US)

US Installations only: Federal Communications Commission (FCC) rules

- This device has been tested and found to comply with the limits for a Class B digital device, pursuant to Part 15 of the FCC Rules. These limits are designed to provide reasonable protection against harmful interference when the equipment is operated in a commercial environment.
- This device has also been tested and found to comply with the limits §15.256, Subpart C- Intentional radiators, pursuant to Part 15 of the FCC Rules. These limits are designed to provide reasonable protection against harmful interference when the equipment is operated in a commercial environment.
- This device generates, uses, and can radiate radio frequency energy and, if not installed and used in accordance with the instruction manual, may cause harmful interference to radio communications, in which case the user will be required to correct the interference at his/her own expense.
- This device may be used to measure levels in open air environments or outside enclosed tanks, subject to the following conditions:
 - Devices shall be installed and maintained to ensure a vertically downward orientation of the transmit antenna's main beam.
 - Devices shall be installed only at fixed locations. Devices shall not operate while being moved or while inside a moving container.
 - Hand-held applications and residential use are prohibited.

2.1.5 Radio equipment compliance (Europe and UK)

Hereby, Siemens declares that the SITRANS LR560 is in compliance with the essential requirements and other relevant provisions of Directive 2014/53/EU and Regulation SI 2017/1206.

The LR560 complies with EN 302 372 for use in closed storage vessels, when installed according to the installation requirements of EN 302 372, and may be used in all EU countries and the UK.

For the receiver test that covers the influence of an interferer signal to the device, the performance criterion has at least the following level of performance according to ETSI TS 103 361 [6]:

- Performance criterion: measurement value variation Δd over time during a distance measurement
- Level of performance: $\Delta d \leq \pm 50$ mm

The LR560 complies with ETSI EN 302 729 for use outside of closed tanks in most EU countries. (For a list of exceptions, see the LR560 Declaration to EN 302 729, which can be accessed online here (www.siemens.com/LR560).) For open air installations, the following conditions must be observed:

- Installation and maintenance is performed by suitably qualified and trained personnel.
- The LR560 shall be installed only in a permanent fixed position pointing downwards. Its location shall comply with the following two restrictions:
 - It shall be installed with a minimum separation distance of 4 km from radio astronomy sites listed here (<http://www.craf.eu/radio-observatories-in-europe/>) unless special authorization has been provided by the responsible national regulatory authority.
 - If it is installed at a location between 4 and 40 km from any radio astronomy site listed here (<http://www.craf.eu/radio-observatories-in-europe/>), the LR560 shall be installed at a height not exceeding 15m from the ground.

2.1.6 Industry Canada

The SITRANS LR560 complies with Industry Canada standard RSS211 (March 2015).

1. The installation of the SITRANS LR560 shall be done by trained installers, in strict compliance with the manufacturer's instructions.
2. The use of this device is on a "no-interference, no-protection" basis. That is, the user shall accept operations of high-powered radar in the same frequency band which may interfere with or damage this device. However, devices found to interfere with primary licensing operations will be required to be removed at the user's expense.
3. The installer/user of this device shall ensure that it is at least 10 km from the Penticton radio astronomy station (British Columbia latitude: 49° 19' 12" N, longitude: 119° 37'12" W). For devices not meeting this 10 km separation (e.g. the Okanagan Valley, British Columbia) the installer/ user must coordinate with and obtain the written concurrence of the Director of the Penticton radio astronomy station before the equipment can be installed or operated. The Director of the DRAO may be contacted at 250-497-2300 or at NRC.DRAO-OFR.CNRC@nrc-cnrc.gc.ca. (Alternatively, the Manager, Regulatory Standards, Industry Canada, may be contacted.)

2.1.7 Conformity with European directives

The CE marking on the device symbolizes the conformity with the following European directives:

Electromagnetic compatibility EMC 2014/30/EU	Directive of the European Parliament and of the Council on the harmonisation of the laws of the Member States relating to electromagnetic compatibility
Low voltage directive LVD 2014/35/EU	Directive of the European Parliament and of the Council on the harmonisation of the laws of the Member States relating to the making available on the market of electrical equipment designed for use within certain voltage limits
Atmosphère explosible ATEX 2014/34/EU	Directive of the European Parliament and the Council on the harmonisation of the laws of the Member States relating to equipment and protective systems intended for use in potentially explosive atmospheres
Pressure equipment directive PED 2014/68/EU	Directive of the European Parliament and of the Council on the harmonisation of the laws of the Member States relating to the making available on the market of pressure equipment
Radio equipment directive RED 2014/53/EU	Directive of the European Parliament and of the Council on the harmonisation of the laws of the Member States relating to the making available on the market of radio equipment and repealing Directive 1999/5/EC

The applicable directives can be found in the EC conformity declaration of the specific device.

2.1.8 Conformity with UK regulations

The UKCA marking on the device symbolizes the conformity with the following UK regulations:

Electromagnetic compatibility SI 2016/1091	Electromagnetic Compatibility Regulations 2016
Low Voltage SI 2016/1101	Electrical Equipment (Safety) Regulations 2016
Explosive atmosphere UKEX SI 2016/1107	Equipment and Protective Systems Intended for use in Potentially Explosive Atmospheres Regulations 2016
Radio equipment SI 2017/1206	Radio Equipment Regulations 2017
RoHS SI 2012/3032	The Restriction of the Use of Certain Hazard- ous Substances in Electrical and Electronic Equipment Regulations 2012

The applicable regulations can be found in the UKCA declaration of conformity of the specific device.

2.2 Use in hazardous areas

Qualified personnel for hazardous area applications

Persons who install, connect, commission, operate, and service the device in a hazardous area must have the following specific qualifications:

- They are authorized, trained or instructed in operating and maintaining devices and systems according to the safety regulations for electrical circuits, high pressures, aggressive, and hazardous media.
- They are authorized, trained, or instructed in carrying out work on electrical circuits for hazardous systems.
- They are trained or instructed in maintenance and use of appropriate safety equipment according to the pertinent safety regulations.

 WARNING
Use in hazardous area Risk of explosion. <ul style="list-style-type: none">• Only use equipment that is approved for use in the intended hazardous area and labeled accordingly.• Do not use devices that have been operated outside the conditions specified for hazardous areas. If you have used the device outside the conditions for hazardous areas, make all Ex markings unrecognizable on the nameplate.

2.3 Requirements for special applications

Due to the large number of possible applications, each detail of the described device versions for each possible scenario during commissioning, operation, maintenance or operation in systems cannot be considered in the instructions. If you need additional information not covered by these instructions, contact your local Siemens office or company representative.

Note

Operation under special ambient conditions

We highly recommend that you contact your Siemens representative or our application department before you operate the device under special ambient conditions as can be encountered in nuclear power plants or when the device is used for research and development purposes.

Installing/mounting

3.1 Basic safety notes

 CAUTION**Hot surfaces resulting from hot process media**

Risk of burns resulting from surface temperatures above 65 °C (149 °F).

- Take appropriate protective measures, for example contact protection.
- Make sure that protective measures do not cause the maximum permissible ambient temperature to be exceeded. Refer to the information in Operating conditions (Page 54).

Note**Material compatibility**

Siemens can provide you with support concerning selection of parts wetted by process media. However, you are responsible for the selection of parts. Siemens accepts no liability for faults or failures resulting from incompatible materials.

 WARNING**Unsuitable connecting parts**

Risk of injury or poisoning.

In case of improper mounting, hot, toxic, and corrosive process media could be released at the connections.

- Ensure that connecting parts (such as flange gaskets and bolts) are suitable for connection and process media.

3.1.1 Exceeded maximum permissible operating pressure

 WARNING
Exceeded maximum permissible operating pressure Risk of injury or poisoning. The maximum permissible operating pressure depends on the device version, pressure limit and temperature rating. The device can be damaged if the operating pressure is exceeded. Hot, toxic and corrosive process media could be released. Ensure that maximum permissible operating pressure of the device is not exceeded. Refer to the information on the nameplate and/or in Technical data (Page 52).

 WARNING
Pressure applications Danger to personnel, system and environment can result from improper installation. <ul style="list-style-type: none">• Improper installation may result in loss of process pressure.

 CAUTION
External stresses and loads Damage to device by severe external stresses and loads (e.g. thermal expansion or pipe tension). Process media can be released. <ul style="list-style-type: none">• Prevent severe external stresses and loads from acting on the device.

3.1.2 Installation location requirements

NOTICE
Strong vibrations Damage to device. <ul style="list-style-type: none">• In installations with strong vibrations, mount the transmitter in a low vibration environment.

NOTICE
Aggressive atmospheres Damage to device through penetration of aggressive vapors. <ul style="list-style-type: none">• Ensure that the device is suitable for the application.

NOTICE
Direct sunlight Damage to device. The device can overheat or materials become brittle due to UV exposure. <ul style="list-style-type: none">• Protect the device from direct sunlight.• Make sure that the maximum permissible ambient temperature is not exceeded. Refer to the information in Operating conditions (Page 54).

 WARNING
Insufficient air supply The device may overheat if there is an insufficient supply of air. <ul style="list-style-type: none">• Install the device so that there is sufficient air supply in the room.• Observe the maximum permissible ambient temperature. Refer to the information in the section Operating conditions (Page 54).

3.1.3 Proper mounting

3.1.3.1 Incorrect mounting

NOTICE
Incorrect mounting The device can be damaged, destroyed, or its functionality impaired through improper mounting. <ul style="list-style-type: none">• Before installing ensure there is no visible damage to the device.• Make sure that process connectors are clean, and suitable gaskets and glands are used.• Mount the device using suitable tools.

3.2 Installation instructions

3.2.1 Environment

- Provide easy access for viewing the display and programming via the local push buttons or the handheld programmer.
- Provide an environment suitable to the housing rating and materials of construction.

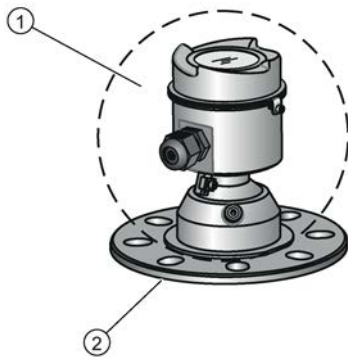

- ① ambient temperature: $-40\text{ }^{\circ}\text{C}$ to $+80\text{ }^{\circ}\text{C}$ ($-40\text{ }^{\circ}\text{F}$ to $+176\text{ }^{\circ}\text{F}$)
- ② process temperature: -40 to $+100\text{ }^{\circ}\text{C}$ (-40 to $+212\text{ }^{\circ}\text{F}$) or -40 to $+200\text{ }^{\circ}\text{C}$ (-40 to $+392\text{ }^{\circ}\text{F}$) depending on the version

For more detail, refer to the complete operating instructions.

NOTICE

Damage to the flange

If mating flange faces are not flat and free of distortion, then bolting the flanged process connection may produce a bending load on the device's flange. Cracking or other damage may occur.

Use only 'full-face' flat gaskets surrounding the bolt holes. Ensure mating flange faces are flat and free of distortion.

3.2.2 Nozzle location

Avoid central locations on tall, narrow vessels

Beam angle

- Beam angle is the width of the cone where the energy density is half of the peak energy density.
- The peak energy density is directly in front of and in line with the antenna.
- There is a signal transmitted outside the beam angle, therefore false targets may be detected.

Emission cone

Keep emission cone free of interference from ladders, pipes, I-beams, or filling streams.

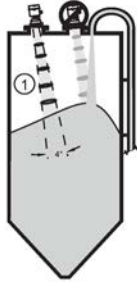

① Emission cone

3.2.3 Aimer adjustment

Note

Measuring material in the cone

Aiming will assist in measuring material in the cone.

		<ol style="list-style-type: none"> 1. For 4 and 6" Aimer: loosen the set screws in the locking ring. <ul style="list-style-type: none"> – Holding the electronics enclosure firmly, loosen the Aimer locking ring using the supplied C spanner, until the LR560 drops down slightly. The enclosure can then be turned freely. 2. Direct SITRANS LR560 so the antenna is pointed at an angle perpendicular to the material surface, if possible. 3. When the desired position is reached, re-tighten the locking ring using the C spanner, and tighten set screws.
<p>① 3" flange ② 4" and 6" flange</p>	<p>① Aiming is not required for signal optimization with 78 GHz frequency. ② Aiming will assist in measuring material in the cone.</p>	

3.2.4 Air purging system

The purge airflow is designed to create a strong vortex of air that rapidly cleans the face of the lens. Refer to the complete operating instructions for details.

3.2.5 Pressure equipment directive (PED, 2014/68/EU) and UK Pressure Equipment Regulations 2016 (SI 2016/1105)

Note

Pressure-rated version only

- SITRANS LR560 units are pressure tested, meeting or exceeding the requirements of the ASME Boiler and Pressure Vessel Code and the European Pressure Equipment Directive.
 - The serial numbers stamped in each process connection body provide a unique identification number indicating date of manufacture.
Example: MMDDYY – XXX (where MM = month, DD = day, YY = year, and XXX= sequential unit produced)
 - Further markings (space permitting) indicate flange configuration, size, pressure class, material, and material heat code.
-

SITRANS LR560 radar level measurement instrument falls below the limits of Article 4, sections 1&2 of the Pressure Equipment directive (2014/68/EU), as a category I pressure accessory. However, in accordance with PED, 2014/68/EU, Article 4, section 3, this equipment has been designed and manufactured in accordance with Sound Engineering Practice (SEP) (see EU Commission Guideline A-05).

3.3 Disassembly

DANGER

Pressure applications

Danger to personnel, system and environment will result from improper disassembly.

- Never attempt to loosen, remove, or disassemble process connection while vessel contents are under pressure.

WARNING

Incorrect disassembly

The following risks may result from incorrect disassembly:

- Injury through electric shock
- Risk through emerging media when connected to the process
- Risk of explosion in hazardous area

In order to disassemble correctly, observe the following:

- Before starting work, make sure that you have switched off all physical variables such as pressure, temperature, electricity etc. or that they have a harmless value.
- If the device contains hazardous media, it must be emptied prior to disassembly. Make sure that no environmentally hazardous media are released.
- Secure the remaining connections so that no damage can result if the process is started unintentionally.

Connecting

4.1 Basic safety notes

 WARNING
Unsuitable cables, cable glands and/or plugs Risk of explosion in hazardous areas. <ul style="list-style-type: none">• Use only cable glands/plugs that comply with the requirements for the relevant type of protection.• Close unused cable inlets for the electrical connections.• When replacing cable glands use only cable glands of the same type.• After installation check that the cables are seated firmly.

 WARNING
Hazardous contact voltage Risk of electric shock in case of incorrect connection. <ul style="list-style-type: none">• For the electrical connection specifications, refer to the information in Power (Page 53).• At the mounting location of the device observe the applicable directives and laws for installation of electrical power installations with rated voltages below 1000 V.

NOTICE
Condensation in the device Damage to device through formation of condensation if the temperature difference between transportation or storage and the mounting location exceeds 20 °C (36 °F). <ul style="list-style-type: none">• Before taking the device into operation, let the device adapt for several hours in the new environment.

! WARNING**Missing PE/ground connection**

Risk of electric shock.

Depending on the device version, connect the power supply as follows:

- **Power plug:** Ensure that the used socket has a PE/ground conductor connection. Check that the PE/ground conductor connection of the socket and power plug match each other.
- **Connecting terminals:** Connect the terminals according to the terminal connection diagram. First connect the PE/ground conductor.

4.1.1 Incorrect connection to power source

! WARNING**Incorrect connection to power source**

Risk to personnel, system and environment can result from improper power connection.

- The DC input terminals shall be supplied from a source providing electrical isolation between the input and output, in order to meet the applicable safety requirements of IEC 61010-1. For example, Class 2 or Limited Energy Source.
- All field wiring must have insulation suitable for rated voltages.

NOTICE**Ambient temperature too high**

Damage to cable sheath.

- At an ambient temperature $\geq 60\text{ °C}$ (140 °F), use heat-resistant cables suitable for an ambient temperature at least 20 °C (36 °F) higher.

! WARNING**Unprotected cable ends**

Risk of explosion through unprotected cable ends in hazardous areas.

- Protect unused cable ends in accordance with IEC/EN 60079-14.

 **WARNING**

Improper laying of shielded cables

Risk of explosion through compensating currents between hazardous area and the non-hazardous area.

- Shielded cables that cross into hazardous areas should be grounded only at one end.
- If grounding is required at both ends, use an equipotential bonding conductor.

 **WARNING**

Incorrect selection of type of protection

Risk of explosion in areas subject to explosion hazard.

This device is approved for several types of protection.

1. Decide in favor of one type of protection.
2. Connect the device in accordance with the selected type of protection.
3. In order to avoid incorrect use at a later point, make the types of protection that are not used permanently unrecognizable on the nameplate.

4.1.2 Note on electromagnetic compatibility

Note

Electromagnetic compatibility (EMC)

For metal housings there is an increased electromagnetic compatibility compared to high-frequency radiation. This protection can be increased by grounding the housing.

Note

Improvement of interference immunity

- Lay signal cables separate from cables with voltages > 60 V.
- Use cables with twisted wires.
- Keep device and cables at a distance from strong electromagnetic fields.
- Take account of the conditions for communication specified in the Communication (Page 57).
- Use shielded cables to guarantee the full specification according to HART/PA/FF/Modbus/EIA-485/Profibus DP.

4.2 Device status icons

For a complete list of the device status icons that appear on the LCD display, as well as what they mean, please refer to the **Diagnosing and Troubleshooting** section of the full operating instructions.

4.3 Connecting SITRANS LR560

Note

- Check the device label on your instrument, to verify the approval rating.
 - Use appropriate conduit seals to maintain IP or NEMA rating.
 - Use twisted pair cable: AWG 22 to 14 (0.34 mm² to 2.5 mm²).
 - Separate cables and conduits may be required to conform to standard instrumentation wiring practices or electrical codes.
-

1. Loosen locking screw.
2. Remove LR560 lid.
3. Remove optional display by gently turning the display a quarter turn counter-clockwise until it is free.
4. Strip the cable jacket for approximately 70 mm (2.75") from the end of the cable.
5. Thread the wires through the gland¹⁾.
6. Strip/remove conductor jacket to 8mm from end.
7. Connect the wires to the terminals as shown: the polarity is identified on the terminal block.
8. Tighten screws on Terminal Block. Suggested screw torque: 7.0 lb-in.
9. Ground the instrument according to local regulations.
10. Tighten the gland to form a good seal.
11. Replace optional display and device lid.
12. Tighten locking screw.

¹⁾ If cable is routed through conduit, use only approved suitable-size hubs for waterproof applications.

Removing the lid and display



Terminal block

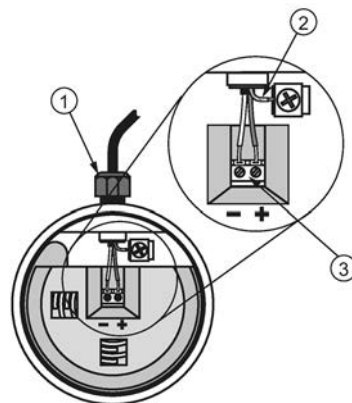

① cable gland (or NPT cable entry)

② cable shield

③ instrument connection

4.4 Nameplates for hazardous area installations

Note

Sample nameplate

The serial number and assembly location shown on the nameplate are given as examples only.

HART

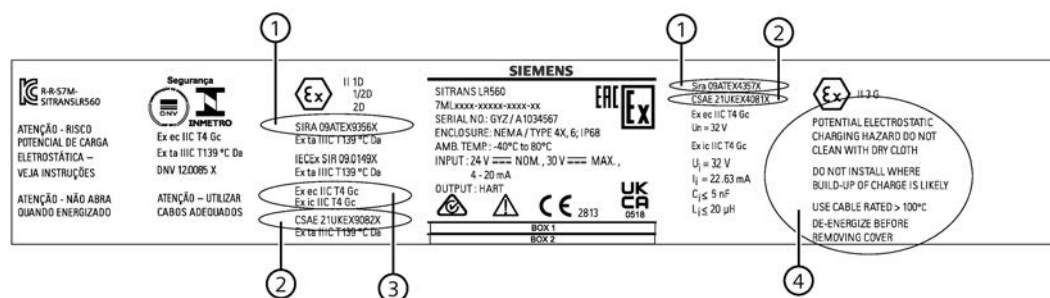

- ① ATEX certificate number
The ATEX certificates can be found on the product website. Go to LR560 (www.siemens.com/LR560) > **Support** > **Certificates**. For more information on hazardous area approvals, see Approvals (Page 56).
- ② UKEX certificate number
The UKEX certificates can be found on the product website. Go to LR560 (www.siemens.com/LR560) > **Support** > **Certificates**. For more information on hazardous area approvals, see Approvals (Page 56).
- ③ IECEx certificate number
The IECEx certificate can be found on the IECEx website. Go to IECEx (<https://www.iecex.com/>) > View certificates and licenses.
- ④ Safety notes
Potential electrostatic charging hazard. Do not clean with dry cloth. Do not install where build-up of charge is likely. Use suitably rated cable. De-energize before removing cover.

4.4 Nameplates for hazardous area installations

PROFIBUS PA

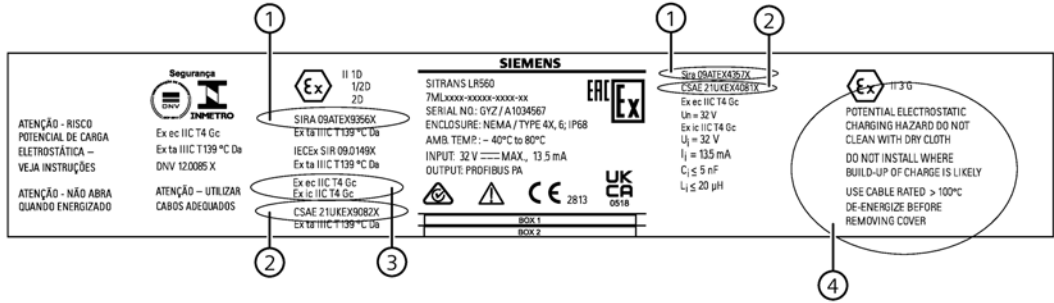

- ① ATEX certificate number The ATEX certificates can be found on the product website. Go to LR560 (www.siemens.com/LR560) > **Support** > **Certificates**. For more information on hazardous area approvals, see Approvals (Page 56).
- ② UKEX certificate number The UKEX certificates can be found on the product website. Go to LR560 (www.siemens.com/LR560) > **Support** > **Certificates**. For more information on hazardous area approvals, see Approvals (Page 56).
- ③ IECEx certificate number The IECEx certificate can be found on the IECEx website. Go to IECEx (<https://www.iecex.com/>) > View certificates and licenses.
- ④ Safety notes Potential electrostatic charging hazard. Do not clean with dry cloth. Do not install where build-up of charge is likely. Use suitably rated cable. De-energize before removing cover.

FOUNDATION FIELDBUS

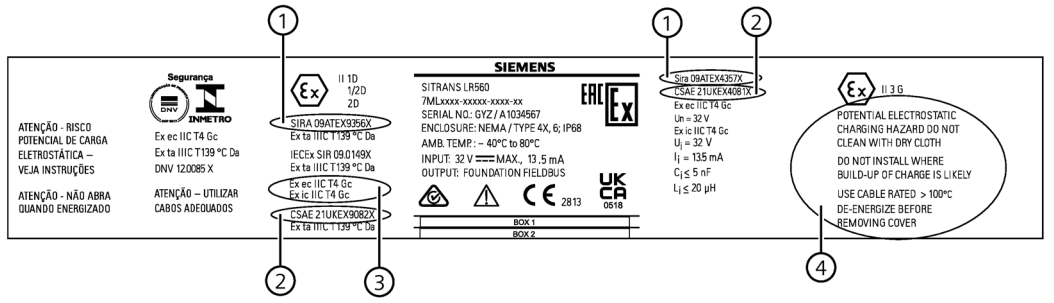

- ① ATEX certificate number The ATEX certificates can be found on the product website. Go to LR560 (www.siemens.com/LR560) > **Support** > **Certificates**. For more information on hazardous area approvals, see Approvals (Page 56).
- ② UKEX certificate number The UKEX certificates can be found on the product website. Go to LR560 (www.siemens.com/LR560) > **Support** > **Certificates**. For more information on hazardous area approvals, see Approvals (Page 56).
- ③ IECEx certificate number The IECEx certificate can be found on the IECEx website. Go to IECEx (<https://www.iecex.com/>) > View certificates and licenses.
- ④ Safety notes Potential electrostatic charging hazard. Do not clean with dry cloth. Do not install where build-up of charge is likely. Use suitably rated cable. De-energize before removing cover.

4.5 Instructions specific to hazardous area installations

4.5.1 European ATEX Directive 2014/34/EU, Annex II, 1.0.6 and UK Regulation SI 2016/1107

The following instructions apply to equipment covered by certificate number SIRA 09ATEX9356X & CSAE 21UKEX9082X and SIRA 09ATEX4357X & CSAE 21UKEX4081X.

1. For use and assembly and details of marking/coding, refer to the main instructions.
2. The equipment is certified for use as Category 1D, 1/2D and 2D equipment per certificate SIRA 09ATEX9356X and CSAE 21UKEX9082X and may be used in hazardous zones 20, 21 and 22. The equipment is also certified for use as Category 3G equipment per certificate SIRA 09ATEX4357X and CSAE 21UKEX4081X and may be used in hazardous zone 2.
3. This equipment has a maximum surface temperature of 139 °C (in an 80 °C ambient). Refer to the applicable code of practice for selection of this equipment with respect to specific dust ignition temperatures.
4. The equipment is certified for use in an ambient temperature range of -40 °C to 80 °C.
5. The equipment has not been assessed as a safety related device (as referred to by Directive 2014/34/EU, Annex II, clause 1.5 and UK Regulation SI 2016/1107).
6. Installation and inspection of this equipment shall be carried out by suitably trained and authorized personnel in accordance with the applicable code of practice.
7. The equipment shall be installed such that the supply cable is protected from mechanical damage. The cable shall not be subjected to tension or torque. The equipment manufacturer is not responsible for providing the supply cable.
8. Repair of this equipment shall be carried out by suitably trained and authorized personnel in accordance with the applicable code of practice.

4.5.2 Special conditions of use

The 'X' suffix to certificate numbers Sira 09ATEX4357X and CSAE 21UKEX4081X relates to the following Special Conditions of Use:

- Parts of the enclosure may be non-conducting and may generate an ignition capable level of electrostatic charge under certain extreme conditions. The user should ensure that the equipment is not installed in a location where it may be subjected to external conditions (such as high-pressure steam), which might cause a build-up of electrostatic charge on non-conducting surfaces.
- The supply to the equipment shall be rated for a prospective short-circuit current of not more than 10 kA and shall be protected by a suitably-rated fuse.
- Any glands, conduit entry devices or blanking elements fitted to the equipment shall suitably Certified and installed in compliance with IEC 60079-14 for the explosive environment, method of protection, and environmental conditions applicable for end use.

The `X' suffix to certificate numbers Sira Sira 09ATEX9356X and CSAE 21UKEX9082X relates to the following Special Conditions of Use:

- Parts of the enclosure may be non-conducting and may generate an ignition capable level of electrostatic charge under certain extreme conditions. The user should ensure that the equipment is not installed in a location where it may be subjected to external conditions (such as high-pressure steam), which might cause a build-up of electrostatic charge on non-conducting surfaces.
- The supply to the equipment shall be rated for a prospective short-circuit current of not more than 10 kA and shall be protected by a suitably-rated fuse.

Commissioning

5.1 Basic safety notes

 WARNING
Improper commissioning in hazardous areas Device failure or risk of explosion in hazardous areas. <ul style="list-style-type: none">• Do not commission the device until it has been mounted completely and connected in accordance with the information in Installing/mounting (Page 14).• Before commissioning take the effect on other devices in the system into account.

 WARNING
Commissioning and operation with pending error If an error message appears, correct operation in the process is no longer guaranteed. <ul style="list-style-type: none">• Check the gravity of the error.• Correct the error.• If the error still exists:<ul style="list-style-type: none">– Take the device out of operation.– Prevent renewed commissioning.

 WARNING
Loss of type of protection Risk of explosion. Damage to device if the enclosure is open or not properly closed. The type of protection specified on the nameplate or in Approvals (Page 56) is no longer guaranteed. <ul style="list-style-type: none">• Make sure that the device is securely closed.

 WARNING
Hazardous contact voltage Risk of injury through hazardous contact voltage when the device is open or not completely closed. The degree of protection specified on the nameplate or in Approvals (Page 56) is no longer guaranteed if the device is open or not properly closed. <ul style="list-style-type: none">• Make sure that the device is securely closed.

 **DANGER**

Toxic gases and liquids

Danger of poisoning when venting the device: if toxic process media are measured, toxic gases and liquids can be released.

- Before venting ensure that there are no toxic gases or liquids in the device, or take the appropriate safety measures.

 **WARNING**

Loss of explosion protection

Risk of explosion in hazardous areas if the device is open or not properly closed.

- Close the device as described in Installing/mounting (Page 14).

5.2 Activating the radar device

Power up the instrument. A transition screen showing first the Siemens logo and then the current firmware revision is displayed while the first measurement is being processed. The first time the device is configured, you will be prompted to select a language (English, German, French, Spanish or Chinese).

Press **Mode**  to toggle between Measurement and Program mode.

5.3 The LCD display

Measurement mode display¹⁾²⁾: Normal operation

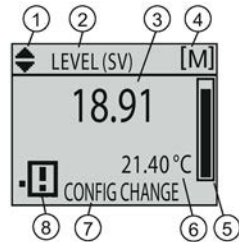

- | | | | |
|---|---|---|--|
| ① | toggle indicator ¹⁾ for PV or SV (primary or secondary values) | ⑦ | text area displays status messages |
| ② | selected operation: level, space, or distance | ⑦ | text area displays a fault code and an error message |
| ③ | measured value (level, space, or distance) | ⑧ | device status indicator |
| ④ | units | ⑧ | service required icon appears |
| ⑤ | bar graph indicates level | | |
| ⑥ | secondary region indicates on request ²⁾ electronics temperature, echo confidence, loop current, or distance | | |

Fault present:
S: 0 LOE



PROGRAM mode display

Navigation view

- A visible menu bar indicates the menu list is too long to display all items.
- The depth of the item band on the menu bar indicates the length of the menu list: a deeper band indicates fewer items.
- The position of the item band indicates the approximate position of the current item in the list. A band halfway down the menu bar indicates the current item is halfway down the list.

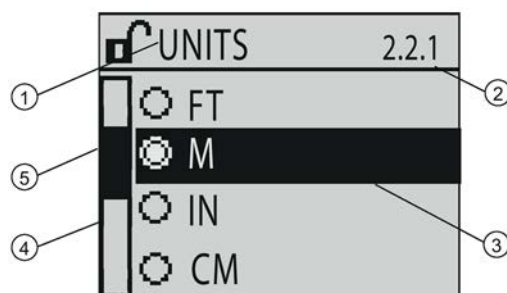

- | | | | |
|---|---------------------|---|-----------|
| ① | current menu | ④ | menu bar |
| ② | current item number | ⑤ | item band |
| ③ | current item | | |

Parameter view

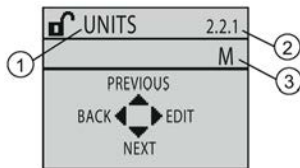

Edit view

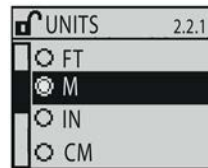

- ① parameter name
- ② parameter number
- ③ parameter value/selection

1) Press UP or DOWN arrow to switch

2) In response to a key press request. For details, see Key functions in measurement mode (Page 37).

5.4 Commissioning via local display



5.4.1 Local operation

SITRANS LR560 carries out its level measurement tasks according to settings made via parameters. The settings can be modified locally via the optional local graphical display which consists of an LCD display with buttons. You can use either the push buttons or an infrared handheld programmer to make changes.



- ① push buttons







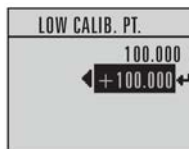

5.4.2 Quick Start Wizard via the local display push buttons

1. Press RIGHT  to enter Program Mode.
2. Choose Quick Start (1.), and then Quick Start Wizard (1.1.).
3. Follow the steps then choose Finish to save Quick Start parameter changes and return to Program menu, or press LEFT  to return to Measurement mode.

To add or delete digits using the push buttons:

When the enter icon  is lit, press UP  to insert a digit on the right, DOWN  to delete the right-most digit, RIGHT  to accept the value, or LEFT  to cancel.



1. Navigate to the parameter you wish to modify and press RIGHT  to edit it. The value will be highlighted.
2. Press UP  or DOWN  to delete the highlighted value, or LEFT  to modify the value from the left-most digit, starting with the plus/minus sign.
3. With the plus or minus sign highlighted, press up or down arrow to change it. Press right arrow to highlight the next digit to the right.
4. Use UP  or DOWN  to modify the highlighted digit. Scroll past 9 to reach the decimal point.
5. When the value is complete, press RIGHT  until the Enter icon is highlighted, then press RIGHT  to accept the value.

To modify a text string:

1. Navigate to the parameter you wish to modify and press RIGHT  to edit it. The string will be highlighted.
2. Follow the same steps as above, to add, delete, or modify characters.

5.5 Commissioning via handheld programmer

5.5.1 Handheld programmer (Part No. 7ML1930-1BK)

The programmer is ordered separately.



The handheld programmer used with this device contains lithium batteries that are non-replaceable.

For more detail, refer to the complete operating instructions.









5.5.2 Lithium batteries

Lithium batteries are primary power sources with high energy content designed to provide the highest possible degree of safety.

! WARNING
Potential hazard
Lithium batteries may present a potential hazard if they are abused electrically or mechanically. Observe the following precautions when handling and using lithium batteries:
<ul style="list-style-type: none">• Do not short-circuit, recharge or connect with false polarity.• Do not expose to temperatures beyond the specified temperature range.• Do not incinerate.• Do not crush, puncture or open cells or disassemble.• Do not weld or solder to the battery's body.• Do not expose contents to water.

5.5.3 Key functions in measurement mode

Key functions in measurement mode









Key	Function	Result
	Updates the loop current	New value is shown in secondary region of local display.
	Updates internal enclosure temperature reading	
	Updates echo confidence value	New value is shown in secondary region of local display.
	Updates distance measurement	
	Mode opens PROGRAM mode	Opens the menu level last displayed in this power cycle, unless power has been cycled since exiting PROGRAM mode or more than 10 minutes have elapsed since PROGRAM mode was used. Then top level menu will be displayed.
	Home toggles local display	Local display toggles between % or linear units
	RIGHT arrow opens PROGRAM mode	Opens the top level menu.
 	UP or DOWN arrow toggles between linear units and percent	Local display shows measured value in either linear units or percent.

5.5.4 Programming

Parameter menus

Note

For the complete list of parameters with instructions, and Dimension drawings, see the full operating instructions.







<p>1. Enter PROGRAM mode</p>	<p>Using local display buttons:</p> <ul style="list-style-type: none"> Press RIGHT  <p>Using handheld programmer:</p> <ol style="list-style-type: none"> Point the programmer at the display from a maximum distance of 300 mm (1 ft). RIGHT  activates PROGRAM mode and opens menu level 1. Mode opens the menu level last displayed in PROGRAM  within the last 10 minutes, or menu level 1 if power has been cycled since then.
<p>2. Editing in PROGRAM mode</p>	<p>To select a listed option:</p> <ol style="list-style-type: none"> Navigate to the desired parameter. Press RIGHT  to open parameter view. Press RIGHT  again to open Edit mode. The current selection is highlighted. Scroll to a new selection. Press RIGHT  to accept it. The local display returns to parameter view and displays the new selection. <p>To change a numeric value:</p> <ol style="list-style-type: none"> Navigate to the desired parameter. Press RIGHT  to open parameter view. The current value is displayed. Press RIGHT  again to open Edit mode. The current value is highlighted. Key in a new value. Press RIGHT  to accept it. The local display returns to parameter view and displays the new selection.

Note











Navigation

- In Navigation mode, ARROW keys move to the next menu item in the direction of the arrow.
- For Quick Access to parameters via the handheld programmer, press Home , and then enter the menu number, for example: 3.2. Echo Profile.

Key functions in Navigation mode

Key	Name	Menu level	Function
	UP or DOWN arrow	menu or parameter	Scroll to previous or next menu or parameter.
			
	RIGHT arrow	menu	Go to first parameter in the selected menu, or open next menu.
		parameter	Open Edit mode.
	LEFT arrow	menu or parameter	Open parent menu.
	Mode	menu or parameter	Change to MEASUREMENT mode.
	Home	menu or parameter	Open top level menu: menu 1.

Key functions in Program mode









Key	Name		Function
	UP or DOWN arrow	Selecting options	Scrolls to item.
		Alphanumeric editing	<ul style="list-style-type: none"> • Increments or decrements digits • Toggles plus and minus sign
			
	RIGHT arrow	Selecting options	<ul style="list-style-type: none"> • Accepts the data (writes the parameter) • Changes from Edit to Navigation mode
		Numeric editing	<ul style="list-style-type: none"> • Moves cursor one space to the right • Or with cursor on Enter sign, accepts the data and changes from Edit to Navigation mode
	LEFT arrow	Selecting options	Cancels Edit mode without changing the parameter
		Numeric editing	<ul style="list-style-type: none"> • Moves cursor to plus/minus sign if this is the first key pressed • Or moves cursor one space to the left. • Or with cursor on Enter sign, cancels the entry
	Clear	Numeric editing	Erases the display
	Decimal point	Numeric editing	<ol style="list-style-type: none"> 1. In Edit mode, enter a decimal point. 2. In Parameter View, press  to store menu path to that parameter, and create custom Secondary Value to be displayed in secondary region of LCD.
	Plus or minus sign	Numeric editing	Changes the sign of the entered value.
 to 	Numerals	Numeric editing	Enters the corresponding character. Editing in PROGRAM mode

5.5.4.1 Quick Start Wizard via the handheld programmer

Note

- A reset to factory defaults should be performed before running the Quick Start Wizard if the device has been used in a previous application. See Quick Start Wizard via the local display push buttons (Page 35).
- The Quick Start wizard settings are inter-related and changes apply only after you select **Finish** in the Wizard Complete step.
- Do not use the Quick Start wizard to modify parameters. Instead refer to "Parameter reference" in the full operating instructions. Perform customization for your application only after the Quick Start has been completed.

Quick Start Wizard

1. Point the programmer at the display from a maximum distance of 300 mm (1 ft.), then press RIGHT  to activate PROGRAM mode and open menu level 1.
2. Press RIGHT  twice to navigate to menu item 1.1 and open parameter view.
3. Press RIGHT  to open Edit mode or DOWN  to accept default values and move directly to the next item.
4. To change a setting, scroll to the desired item or key in a new value.
5. After modifying a value, press RIGHT  to accept it and press DOWN  to move to the next item.
6. At any time, you can press UP  to go back, or LEFT  to cancel and return to Measurement mode.



Vessel

Factory setting:	STEEL
Setting range:	STEEL or CONCRETE
Purpose:	Select vessel construction material.
Description:	<ul style="list-style-type: none"> • Selecting either STEEL or CONCRETE does a functional reset; see MASTER RESET. • Selecting STEEL changes the setting for POSITION DETECT to Rising Edge and for ALGORITHM to F. • Selecting CONCRETE changes the setting for POSITION DETECT to Rising Edge and for ALGORITHM to ALF.

Parameter view

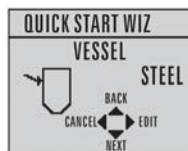

Edit mode



Response rate

Factory setting:	MED		
Setting range:	Response rate	Fill rate per Minute/Empty rate per Minute	Damping Filter
	SLOW	0.1 m/min (0.32 ft/min)	600 s
	MED	1.0 m/min (3.28 ft/min)	60 s
	FAST	10.0 m/min (32.8 ft/min)	0 s
Purpose:	Sets the reaction speed of the device to measurement changes in the target range. Selecting SLOW changes setting for AVERAGE AMOUNT to 0.9.		
Description:	Use a setting just faster than the maximum vessel filling or vessel emptying rate (whichever is greater).		

Parameter view



Edit mode

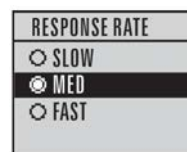

Units

Factory setting:	m
Setting range:	m, cm, mm, ft, in
Purpose:	Sensor measurement units.

Parameter view

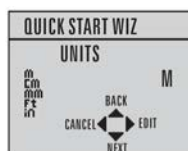

Edit mode

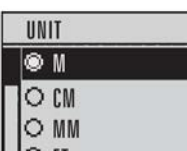

Operation

Factory setting:	LEVEL	
Setting range:	LEVEL	Distance to material surface referenced from Low calibration point
	SPACE	Distance to material surface referenced from High calibration point
	DISTANCE	Distance to material surface referenced from Sensor reference point
Purpose:	Sensor measurement units.	

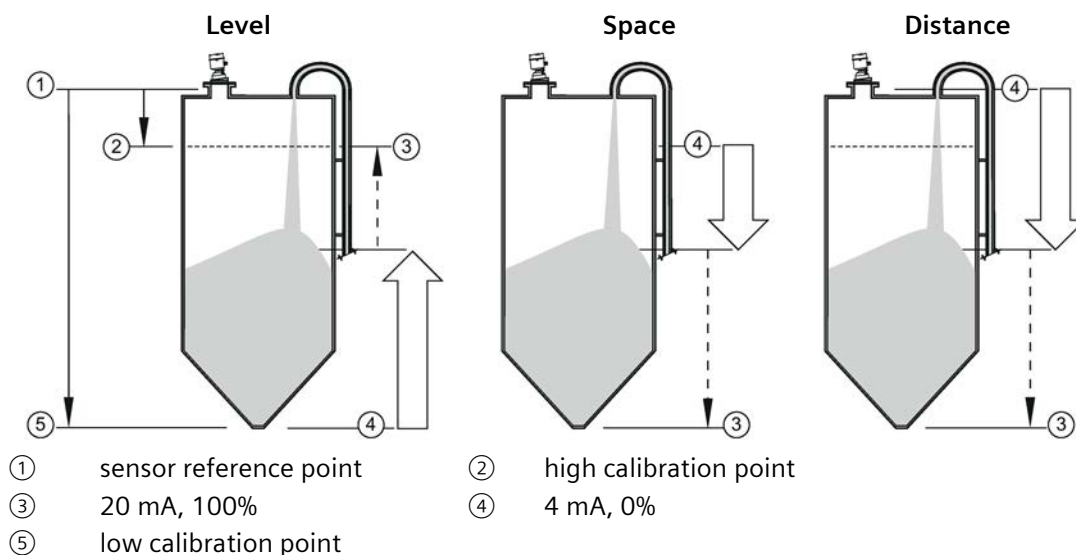
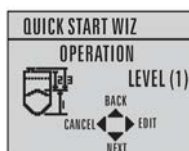

Low calibration point

Factory setting:	40.000 m or 100.000 m
Setting range:	0.000 to 40.000 m or 0.000 to 100.000 m
Purpose:	Distance from Sensor Reference to Low Calibration Point: usually process empty level.

Parameter view



Edit mode

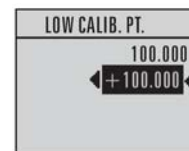

High calibration point

Factory setting:	0.000 m
Setting range:	0.000 to 40.000 m or 0.000 to 100.000 m
Purpose:	Distance from Sensor Reference Point to High Calibration Point: usually process full level.



Parameter view

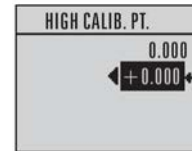

Edit mode



Wizard complete

Setting range:	BACK, CANCEL, FINISH (Display returns to 1.1 Quick Start Wizard menu when Quick Start is successfully completed.)
Description:	To transfer Quick Start values to the device and return to Program menu, press DOWN  (Finish). Then press LEFT  to return to Measurement mode.

Remote operation

6.1 Operating via SIMATIC PDM

SIMATIC PDM is a software package used to commission and maintain process devices. Please consult the operating instructions or online help for details on using SIMATIC PDM. You can find more information on versions and compatibility at our website.

6.2 Operating via AMS Device Manager

AMS Device Manager is a software package that monitors the process values, alarms and status signals of the device. Please consult the operating instructions or online help for details on using AMS Device Manager. You can find more information at:

Emerson (<http://www.emersonprocess.com/AMS/>)

6.3 Operating via FDT (Field Device Tool)

FDT is a standard used in several software packages designed to commission and maintain field devices. Two commercially available FDTs are PACTware and Fieldcare.

Functionally FDT is very similar to PDM. See Operating via SIMATIC PDM (Page 45) for more detail.

- To configure a field device via FDT you need the DTM (Device Type Manager) for the device.
- To configure a field device via SIMATIC PDM, you need the EDD (Electronic Data Description) for the device.

6.4 Communication

Note

You will need the complete operating instructions to acquire the list of applicable parameters.

6.4.1 HART

We recommend that you use SIMATIC Process Device Manager (PDM) to program your device. Application Guides for setting up HART devices with SIMATIC PDM can be downloaded from our website, under **Support**:

LR560 (www.siemens.com/LR560)

6.4.2 PROFIBUS PA

We recommend that you use SIMATIC Process Device Manager (PDM) to program your device.

6.4.3 FOUNDATION FIELDBUS

We recommend that you use AMS Device Manager to program your device. Details on using AMS Device Manager to program your device can be found in the complete operating instructions.

Service and maintenance

7.1 Basic safety notes

Note

The device is maintenance-free.

7.1.1 Maintenance

The device is maintenance-free. However, a periodic inspection according to pertinent directives and regulations must be carried out.

An inspection can include, for example, check of:

- Ambient conditions
- Seal integrity of the process connections, cable entries, and cover
- Reliability of power supply, lightning protection, and grounds

 WARNING
--

Impermissible repair and maintenance of the device

- | |
|--|
| <ul style="list-style-type: none"> • Repair and maintenance must be carried out by Siemens authorized personnel only. |
|--|

 WARNING
--

Impermissible repair of explosion protected devices
--

Risk of explosion in hazardous areas

- | |
|--|
| <ul style="list-style-type: none"> • Repair must be carried out by Siemens authorized personnel only. |
|--|

NOTICE

Penetration of moisture into the device
--

Damage to device.

- | |
|---|
| <ul style="list-style-type: none"> • Make sure when carrying out cleaning and maintenance work that no moisture penetrates the inside of the device. |
|---|

7.1.2 Leaks in the sample gas path

 WARNING
Leaks in the sample gas path Risk of poisoning. When measuring toxic process media, these can be released or collect in the device if there are leaks in the sample gas path. <ul style="list-style-type: none">• Purge the device as described the "Installing/mounting" chapter in the full operating instructions.• Dispose of the toxic process media displaced by purging in an environmentally friendly manner.

7.2 Cleaning

Cleaning the enclosure

- Clean the outside of the enclosure with the inscriptions and the display window using a cloth moistened with water or a mild detergent.
- Do not use any aggressive cleansing agents or solvents, e.g. acetone. Plastic parts or the painted surface could be damaged. The inscriptions could become unreadable.

 WARNING
Electrostatic charge Risk of explosion in hazardous areas if electrostatic charges develop, for example, when cleaning plastic surfaces with a dry cloth. <ul style="list-style-type: none">• Prevent electrostatic charging in hazardous areas.

7.3 Maintenance and repair work

 WARNING
Maintenance during continued operation in a hazardous area There is a risk of explosion when carrying out repairs and maintenance on the device in a hazardous area. <ul style="list-style-type: none">• Isolate the device from power. - or - <ul style="list-style-type: none">• Ensure that the atmosphere is explosion-free (hot work permit).

 WARNING
Humid environment Risk of electric shock. <ul style="list-style-type: none">• Avoid working on the device when it is energized.• If working on an energized device is necessary, ensure that the environment is dry.• Make sure when carrying out cleaning and maintenance work that no moisture penetrates the inside of the device.

 CAUTION
Hot surfaces Risk of burns during maintenance work on parts having surface temperatures exceeding 70 °C (158 °F). <ul style="list-style-type: none">• Take corresponding protective measures, for example by wearing protective gloves.• After carrying out maintenance, remount touch protection measures.

7.3.1 Enclosure open

 WARNING
Enclosure open Risk of explosion in hazardous areas as a result of hot components and/or charged capacitors inside the device. To open the device in a hazardous area: <ol style="list-style-type: none">1. Isolate the device from power.2. Visually inspect sensor inlet and outlet. Exception: Devices exclusively having the type of protection "Intrinsic safety Ex i" may be opened in an energized state in hazardous areas.

 CAUTION
Hazardous voltage at open device Risk of electric shock when the enclosure is opened or enclosure parts are removed. <ul style="list-style-type: none">• Before you open the enclosure or remove enclosure parts, de-energize the device.• If maintenance measures in an energized state are necessary, observe the particular precautionary measures. Have maintenance work carried out by qualified personnel.

 WARNING
Hot, toxic or corrosive process media Risk of injury during maintenance work. When working on the process connection, hot, toxic or corrosive process media could be released. <ul style="list-style-type: none">• As long as the device is under pressure, do not loosen process connections and do not remove any parts that are pressurized.• Before opening or removing the device ensure that process media cannot be released.

 WARNING
Improper connection after maintenance Risk of explosion in areas subject to explosion hazard. <ul style="list-style-type: none">• Connect the device correctly after maintenance.• Close the device after maintenance work. Refer to Connecting (Page 22).

7.4 Return procedure

7.4.1 Return procedure

To return a product to Siemens, see Returns to Siemens (www.siemens.com/returns-to-siemens).

Contact your Siemens representative to clarify if a product is repairable, and how to return it. They can also help with quick repair processing, a repair cost estimate, or a repair report/cause of failure report.

NOTICE

Decontamination

The product may have to be decontaminated before it is returned. Your Siemens contact person will let you know for which products this is required.

Note

Return of products with lithium batteries

Lithium batteries are dangerous goods according to the Regulation of Dangerous Goods, UN 3090 and UN 3091.

- Remove lithium batteries prior to shipment.
- If the battery cannot be removed, return the product according to the Regulation of Dangerous Goods with special transport documentation.

7.5 Disposal



Devices described in this manual should be recycled. They may not be disposed of in the municipal waste disposal services according to the Directive 2012/19/EC on waste electronic and electrical equipment (WEEE).

Devices can be returned to the supplier within the EC and UK, or to a locally approved disposal service for eco-friendly recycling. Observe the specific regulations valid in your country.

Further information about devices containing batteries can be found at: Information about battery / product return (WEEE) (<https://support.industry.siemens.com/cs/document/109479891/>)

Technical data

Note

Device specifications

Siemens makes every attempt to ensure the accuracy of these specifications but reserves the right to change them at any time.

8.1 Performance

Measurement Accuracy¹⁾ (measured in accordance with IEC 60770-1)

Maximum measured error	5 mm (0.2") including hysteresis and non-repeatability ²⁾	
Frequency	78 to 79 GHz FMCW	
Maximum measurement range ³⁾	40 m version	40 m (131 ft)
	100 m version	100 m (328 ft)
Minimum detectable distance	400 mm (15.7") from sensor reference point ⁴⁾	
Update time ⁵⁾	maximum 10 seconds, depending on setting for RESPONSE RATE	
Influence of ambient temperature	< 0.003%/K (average over full temperature range, referenced to maximum range)	
Long-term stability	<0.1%/24 months	
Dielectric constant of material measured	for ranges up to 20 m (65.6 ft)	minimum dK = 1.6
	for ranges up to 100 m (328 ft)	minimum dK = 2.5
Memory	non-volatile EEPROM	
	no battery required	

¹⁾ Reference conditions: POSITION DETECT set to Center and ALGORITHM set to True First Echo.

²⁾ Under severe EMI/EMC environments per IEC61326-1 or NAMUR NE21, the device error may increase to a maximum of 25mm (1").

³⁾ From sensor reference point.

⁴⁾ See Dimension drawings in full operating instructions.

⁵⁾ Reference conditions: RESPONSE RATE set to **FAST**.

8.2 Power

HART

Nominal 24 V DC at 550 Ohm. For other configurations, refer the chart under "Loop power" in the full operating instructions.

PROFIBUS PA and FOUNDATION FIELDBUS

Bus powered	9 to 32 V DC, per IEC 61158-2
Current consumed	13.5 mA

8.3 Construction

Process connection:	Universal flat-faced flange ¹⁾	3"/80 mm, 4"/100 mm, 6"/150 mm Material: 316L (1.4404 or 1.4435), or 304 stainless steel
	Aimer flange ¹⁾	3"/80 mm, 4"/100 mm, 6"/150 mm Material: Polyurethane powder-coated cast aluminum
	Universal stamped flange ¹⁾	3"/80 mm, 4"/100 mm, 6"/150 mm Material: 304 stainless steel
Enclosure	Construction	316L/1.4404 stainless steel
	Conduit entry	M20x1.5, or 1/2" NPT
	Conduit entry connector (optional)	M12 connector (shipped with M20 to M12 adaptor) or, 7/8" connector (shipped with 1/2" NPT to 7/8" adaptor)
	Ingress protection	Type 4X, Type 6, IP68
	Lid with window	Polycarbonate (window material)
	Sun shield (optional)	304 stainless steel
Lens antenna material	40 m version	PEI
	100 m version	PEEK
Air purge connection	equipped with female 1/8" NPT fitting	
Weight (excluding extensions):	3" stainless steel flange model	3.15 kg (6.94 lb)

¹⁾ Universal flange mates with EN 1092-1 (PN16)/ASME B16.5 (150 lb)/JIS 2220 (10K) bolt hole pattern.

8.4 Operating conditions

Note

- For the specific configuration you are about to use or install, check transmitter nameplate and see Approvals (Page 56).
- Use appropriate conduit seals to maintain IP or NEMA rating.

Location	indoor/outdoor
Altitude	5000 m (16,404 ft) max.
Ambient temperature	-40 to +80 °C (-40 to +176 °F)
Storage temperature	-40 to +80 °C (-40 to +176 °F)
Relative humidity	suitable for outdoor use Type 4X, Type 6, IP68 enclosure (see note above)
Installation category	I
Pollution degree	4

Reference operating conditions according to IEC 60770-1

Ambient temperature	15 to 25 °C (59 to 77 °F)
Humidity	45 to 75% relative humidity
Ambient pressure	860 to 1060 mbar a (86000 to 106000 N/m ² g)

8.5 Process

Temperature and pressure¹⁾

Note

Pressure

Universal stamped flanges are to be used for 0.5 bar max pressure only.

Version	Stainless steel flange	Aimer flange 0.5 bar max.	Aimer flange 3.0 bar max
40 m	-40 to +100 °C (-40 to +212 °F)	-40 to +100 °C (-40 to +212 °F)	-40 to +100 °C (-40 to +212 °F)
100 m	-40 to +200 °C (-40 to +392 °F)	-40 to +200 °C (-40 to +392 °F)	-40 to +120 °C (-40 to +248 °F)

¹⁾ Maximum and minimum temperatures are dependent on the process connection, antenna and O-ring materials. Use of the Easy Aimer limits maximum temperature.

For more detail, refer to the complete operating instructions.

8.6 Approvals

Note

Approvals

The device label lists the approvals that apply to your device.

General		cCSAus, FM, CE, UKCA, RCM	
Radio		Europe (RED), FCC, Industry Canada	
Hazardous	Non-sparking/Energy Limited	Europe	ATEX II 3G Ex ec/IC T4 Gc
		UK	UKEX II 3G Ex ec/IC T4 Gc
		International	Ex ec/IC T4 Gc IECEX SIR 09.0149X
		Brazil	INMETRO: DNV 12.0085 X Ex ec IIC T4 Gc -40 °C ≤ Ta ≤ +80 °C Un = 32 Vcc
		China	Ex nA IIC T4 Gc
	Dust Ignition Proof	Europe	ATEX II 1D, 1/2D, 2D Ex ta IIIC T139°C Da
		UK	UKEX II 1D, 1/2D, 2D Ex ta IIIC T139°C Da
		International	Ex ta IIIC T139°C Da IP68 IECEX SIR 09.0149X
		Brazil	INMETRO: DNV 12.0085 X Ex ta IIIC T139 °C Da IP68 -40 °C ≤ Ta ≤ +80 °C
		China	Ex tD A20 IP68 T139°C
	Dust Ignition Proof	US/Canada	FM/CSA: Class II, Div. 1, Groups E, F, G Class III T4
	Non-incendive	US/Canada	FM/CSA Class I, Div. 2, Groups A, B, C, D, T4

CE Electromagnetic Compatibility (EMC) conformity	
Emission	EN 55011 / CISPR-11
Immunity	EN/IEC 61326-1 (Industry) NAMUR NE 21

8.7 Communication

HART

Protocol	HART ²⁾ Version 6.0
Load	230 to 550 Ω , 230 to 500 Ω when connecting a coupling module
Max line length¹⁾	multi-wire: 1500 m (4921 ft)
¹⁾ Max. length depends on wire type. See www.hartcomm.org (www.hartcomm.org) for more details.	
²⁾ HART is a registered trademark of HART Communication Foundation.	

PROFIBUS PA

Profibus PA 3.01

FOUNDATION FIELDBUS

ITK version 5	<ul style="list-style-type: none">• Blocks supported: RESOURCE, LTB, AIFB1, AIFB2, LCD, DIAG• Block execution time: AIFB - 30 ms
---------------	---

Product documentation and support

A.1 Product documentation

Process instrumentation product documentation is available in the following formats:

- Certificates (<http://www.siemens.com/processinstrumentation/certificates>)
- Downloads (firmware, EDDs, software) (<http://www.siemens.com/processinstrumentation/downloads>)
- Catalog and catalog sheets (<http://www.siemens.com/processinstrumentation/catalogs>)
- Manuals (<http://www.siemens.com/processinstrumentation/documentation>)

You have the option to show, open, save, or configure the manual.

- "Display": Open the manual in HTML5 format
- "Configure": Register and configure the documentation specific to your plant
- "Download": Open or save the manual in PDF format
- "Download as html5, only PC": Open or save the manual in the HTML5 view on your PC

You can also find manuals with the Mobile app at Industry Online Support (<https://support.industry.siemens.com/cs/ww/en/sc/2067>). Download the app to your mobile device and scan the device QR code.

Product documentation by serial number

Using the PIA Life Cycle Portal, you can access the serial number-specific product information including technical specifications, spare parts, calibration data, or factory certificates.

Entering a serial number

1. Open the PIA Life Cycle Portal (<https://www.pia-portal.automation.siemens.com>).
2. Select the desired language.
3. Enter the serial number of your device. The product documentation relevant for your device is displayed and can be downloaded.

To display factory certificates, if available, log in to the PIA Life Cycle Portal using your login or register.

Scanning a QR code

1. Scan the QR code on your device with a mobile device.
2. Click "PIA Portal".

To display factory certificates, if available, log in to the PIA Life Cycle Portal using your login or register.

Technical support

If this documentation does not completely answer your technical questions, you can enter a Support Request (<http://www.siemens.com/automation/support-request>).

For help creating a support request, view this video here (www.siemens.com/opensr).

Additional information on our technical support can be found at Technical Support (<http://www.siemens.com/automation/csi/service>).

Service & support on the Internet

In addition to our technical support, Siemens offers comprehensive online services at Service & Support (<http://www.siemens.com/automation/service&support>).

Contact

If you have further questions about the device, contact your local Siemens representative at Personal Contact (<http://www.automation.siemens.com/partner>).

To find the contact for your product, go to "all products and branches" and select "Products & Services > Industrial automation > Process instrumentation".

Contact address for business unit:

Siemens AG
Digital Industries
Process Automation
Östliche Rheinbrückenstr. 50
76187 Karlsruhe, Germany

Index

A

- Activating, 32
- Approvals
 - hazardous area, 56
 - radio, 56

C

- Catalog
 - catalog sheets, 58
- Certificates, 9, 58
- Cleaning, 48
- configuration
 - Quick Start via local display, 41
- Customer Support, (Refer to Technical support)

D

- Disassembly, 21
- Disposal, 51
- Downloads, 58

H

- Hazardous area
 - Laws and directives, 9
 - Qualified personnel, 13
- Hotline, (Refer to Support request)

L

- Laws and directives
 - Disassembly, 9
 - Personel, 9
- Lithium batteries
 - Return, 51
 - Safety, 36

M

- Maintenance, 47
- Manuals, 58

Modifications

- correct usage, 10
- improper, 10

Mounting

- beam angle, 18
- nozzle location, 18

P

- PDM
 - see SIMATIC PDM, 45
- power source
 - requirements, 23
- programmer
 - handheld, 36

Q

- Qualified personnel, 13
- Quick Start Wizard
 - via local display, 41

R

- Return procedure, 51

S

- Scope of delivery, 7
- Service, 59
- Service and support
 - Internet, 59
- startup
 - transition screen, 32
- Support, 59
- Support request, 59

T

- Technical data, 52
 - air purge connection, 53
 - ambient temperature, 54
 - enclosure, 53
 - environmental, 54
 - lens antenna material, 53
 - process connections, 53

process temperature, 55, 55
weight, 53

Technical support, 59
partner, 59
personal contact, 59

Test certificates, 9

W

Warranty, 8