

Pressure transmitter

SITRANS P, DS III Series with HART

Operating Instructions · 09/2012



SITRANS

Answers for industry.

SIEMENS

SIEMENS

SITRANS

Pressure transmitter SITRANS P, DS III series with HART

Operating Instructions



7MF4.33..

<u>Introduction</u>	1
<u>Safety instructions</u>	2
<u>Description</u>	3
<u>Installing/mounting</u>	4
<u>Connecting</u>	5
<u>Operation</u>	6
<u>Operating functions through HART</u>	7
<u>Functional safety</u>	8
<u>Commissioning</u>	9
<u>Service and maintenance</u>	10
<u>Technical data</u>	11
<u>Dimension drawings</u>	12
<u>Spare parts/accessories</u>	13
<u>Appendix</u>	A
<u>List of abbreviations</u>	B

Legal information

Warning notice system

This manual contains notices you have to observe in order to ensure your personal safety, as well as to prevent damage to property. The notices referring to your personal safety are highlighted in the manual by a safety alert symbol, notices referring only to property damage have no safety alert symbol. These notices shown below are graded according to the degree of danger.

 DANGER
indicates that death or severe personal injury will result if proper precautions are not taken.
 WARNING
indicates that death or severe personal injury may result if proper precautions are not taken.
 CAUTION
indicates that minor personal injury can result if proper precautions are not taken.
NOTICE
indicates that property damage can result if proper precautions are not taken.

If more than one degree of danger is present, the warning notice representing the highest degree of danger will be used. A notice warning of injury to persons with a safety alert symbol may also include a warning relating to property damage.

Qualified Personnel

The product/system described in this documentation may be operated only by **personnel qualified** for the specific task in accordance with the relevant documentation, in particular its warning notices and safety instructions. Qualified personnel are those who, based on their training and experience, are capable of identifying risks and avoiding potential hazards when working with these products/systems.

Proper use of Siemens products

Note the following:

 WARNING
Siemens products may only be used for the applications described in the catalog and in the relevant technical documentation. If products and components from other manufacturers are used, these must be recommended or approved by Siemens. Proper transport, storage, installation, assembly, commissioning, operation and maintenance are required to ensure that the products operate safely and without any problems. The permissible ambient conditions must be complied with. The information in the relevant documentation must be observed.

Trademarks

All names identified by ® are registered trademarks of Siemens AG. The remaining trademarks in this publication may be trademarks whose use by third parties for their own purposes could violate the rights of the owner.

Disclaimer of Liability

We have reviewed the contents of this publication to ensure consistency with the hardware and software described. Since variance cannot be precluded entirely, we cannot guarantee full consistency. However, the information in this publication is reviewed regularly and any necessary corrections are included in subsequent editions.

Table of contents

1	Introduction.....	9
1.1	Purpose of this documentation.....	9
1.2	Product information.....	9
1.3	History.....	9
1.4	Scope of the instructions.....	10
1.5	Checking the consignment.....	10
1.6	Transportation and storage.....	11
1.7	Notes on warranty.....	11
2	Safety instructions.....	13
2.1	Precondition for use.....	13
2.1.1	Laws and directives.....	13
2.1.2	Conformity with European directives.....	13
2.2	Use in hazardous areas.....	14
3	Description.....	17
3.1	System configuration.....	17
3.2	Application range.....	18
3.3	Structure.....	19
3.4	Nameplate layout.....	21
3.5	Measuring point label layout.....	22
3.6	Functional principle.....	23
3.6.1	Overview of mode of operation.....	23
3.6.2	Operation of the electronics.....	23
3.6.3	Measuring cell operation.....	24
3.6.3.1	Measuring cell for gauge pressure.....	25
3.6.3.2	Measuring cell for differential pressure and flow rate.....	26
3.6.3.3	Measuring cell for level.....	27
3.6.3.4	Measuring cell for absolute pressure from the differential pressure series.....	28
3.6.3.5	Measuring cell for absolute pressure from the gauge pressure series.....	29
3.6.3.6	Measuring cell for gauge pressure, front-flush membrane.....	29
3.6.3.7	Measuring cell for absolute pressure, front-flush membrane.....	30
3.7	Remote seal.....	31
3.8	SIMATIC PDM.....	31
4	Installing/mounting.....	33
4.1	Basic safety instructions.....	33
4.1.1	Installation location requirements.....	37
4.1.2	Proper mounting.....	38

4.1.2.1	Incorrect mounting.....	38
4.2	Disassembly.....	39
4.3	Installation (except level).....	39
4.3.1	Instructions for installation (except level).....	39
4.3.2	Installation (except level).....	40
4.3.3	Fastening.....	41
4.4	"Level" installation.....	43
4.4.1	Instructions for level installation.....	43
4.4.2	Installation for level.....	44
4.4.3	Connection of the negative pressure line.....	45
4.5	"Remote seal" installation.....	47
4.5.1	Remote seal installation.....	47
4.5.2	Installation of the remote seal with the capillary line.....	49
4.6	Tuning the measuring cell against housing.....	54
4.7	Rotating the display.....	55
5	Connecting.....	57
5.1	Basic safety instructions.....	57
5.1.1	Unsuitable cables and/or cable glands.....	57
5.2	Connecting the device.....	60
5.3	Connecting the Han plug.....	62
5.4	Connecting the M12 connector.....	63
6	Operation.....	65
6.1	Overview of operation.....	65
6.2	Basic safety instructions.....	66
6.3	Instructions for operation.....	66
6.4	Display.....	67
6.4.1	Display elements.....	67
6.4.2	Units display.....	68
6.4.3	Error display.....	69
6.4.4	Mode display.....	70
6.4.5	Status display.....	70
6.4.6	Overflow range.....	71
6.5	Local operation.....	72
6.5.1	Local control elements.....	72
6.5.2	Operation using buttons.....	74
6.5.3	Start of scale value/full scale value.....	75
6.5.3.1	Difference between setting and adjusting.....	75
6.5.3.2	Setting/adjusting the start of scale value.....	79
6.5.3.3	Setting/adjusting the full scale value.....	80
6.5.4	Setting/adjusting electrical damping.....	82
6.5.5	Blind start of scale value/full scale value.....	83
6.5.5.1	Difference between setting/adjusting and blind setting/adjusting.....	83
6.5.5.2	Blind setting of start of scale value.....	84
6.5.5.3	Blind setting of full scale value.....	85

6.5.5.4	Blind adjusting of the start of scale value.....	86
6.5.5.5	Blind adjustment of the full scale value.....	86
6.5.6	Trimming the zero point.....	87
6.5.7	Current transmitter.....	88
6.5.8	Output current in case of fault.....	89
6.5.9	buttons and function lock.....	90
6.5.10	Releasing key lock or function lock.....	91
6.5.11	Flow rate measurement (only differential pressure).....	91
6.5.12	Measured value display.....	94
6.5.13	Unit.....	95
7	Operating functions through HART.....	99
7.1	Operating functions through HART communication.....	99
7.2	Process tag data.....	100
7.3	Selecting the measuring modes.....	100
7.3.1	Overview of measuring modes.....	100
7.3.2	Measuring mode selector.....	101
7.3.3	Variable mapper.....	101
7.3.4	Measuring mode "Pressure".....	101
7.3.5	Customized characteristic curve.....	102
7.3.6	Measuring mode "Level".....	103
7.3.7	Measuring mode "Flow rate".....	106
7.3.8	Measuring mode "User".....	108
7.3.9	Measured value status.....	110
7.3.10	Analog output.....	114
7.3.11	Scaling the display value.....	115
7.4	Setting zero point and limit point.....	116
7.5	Blind setting of zero point and limit point.....	117
7.6	Zero point calibration (position correction).....	117
7.7	Electrical damping.....	118
7.8	Fast response mode.....	118
7.9	Current sensor.....	118
7.10	Fault current.....	118
7.11	Setting the current limits.....	119
7.12	Key lock and write protection.....	120
7.13	Measured value display.....	121
7.14	Selection of the physical unit.....	122
7.15	Bar graph.....	123
7.16	Sensor calibration.....	123
7.16.1	Sensor trim.....	123
7.16.2	Trimming the sensor.....	124
7.17	Current sensor trim.....	124
7.18	Factory calibration.....	125

7.19	Static configuration data.....	126
7.20	Flow rate measurement (only differential pressure).....	127
7.21	Diagnostic functions.....	128
7.21.1	Overview.....	128
7.21.2	Operating hours counter.....	129
7.21.3	Calibration timer and service timer.....	129
7.21.4	Min/max indicator.....	130
7.21.5	Limit modules.....	131
7.22	Simulation.....	133
7.22.1	Overview of simulation.....	133
7.22.2	Simulation as fixed value.....	134
7.22.3	Simulation with a ramp function.....	134
7.23	Limit monitor.....	134
8	Functional safety.....	137
8.1	General safety instructions.....	137
8.1.1	Safety-instrumented system.....	137
8.1.2	Safety Integrity Level (SIL).....	138
8.2	Device-specific safety information for single-channel operation (SIL 2).....	140
8.2.1	Safety function.....	140
8.2.2	Settings.....	140
8.2.3	Requirements	141
8.2.4	Behavior in case of faults.....	142
8.2.5	Maintenance/Checking.....	142
8.2.6	Safety characteristics.....	142
8.3	Device-specific safety information for redundant operation (SIL 3).....	143
8.3.1	Safety function.....	143
8.3.2	Requirements	144
8.3.3	Settings.....	145
8.3.4	Behavior in case of faults.....	146
8.3.5	Maintenance/Checking.....	146
8.3.6	Safety characteristics.....	147
8.4	Add-on parts.....	147
8.4.1	Checking a device with add-on pneumatic block.....	148
8.4.2	Checking a device with add-on remote seal.....	148
9	Commissioning.....	149
9.1	Basic safety instructions.....	149
9.2	Introduction to commissioning.....	150
9.3	gauge pressure, absolute pressure from the differential pressure series and absolute pressure from the gauge pressure series.....	151
9.3.1	Commissioning for gases.....	151
9.3.2	Commissioning with steam or liquid.....	152
9.4	Differential pressure and flow rate.....	153
9.4.1	Safety notes for commissioning with differential pressure and flow rate.....	153
9.4.2	Commissioning in gaseous environments.....	154
9.4.3	Commissioning for liquids.....	155

9.4.4	Commissioning with vapor.....	157
10	Service and maintenance.....	159
10.1	Basic safety instructions.....	159
10.2	Maintenance and repair work.....	162
10.2.1	Defining the maintenance interval.....	162
10.2.2	Checking the gaskets.....	163
10.2.3	Display in case of a fault.....	163
10.2.4	Changing the measuring cell and application electronics.....	164
10.3	Cleaning.....	164
10.3.1	Servicing the remote seal measuring system.....	165
10.4	Return procedure.....	166
10.5	Disposal.....	166
11	Technical data.....	169
11.1	Overview of technical data.....	169
11.2	Input point.....	170
11.3	Output.....	177
11.4	Measuring accuracy.....	177
11.5	Operating conditions.....	183
11.6	Construction.....	187
11.7	Display, keyboard and auxiliary power.....	191
11.8	Certificates and approvals.....	192
11.9	HART communication.....	194
12	Dimension drawings.....	195
12.1	SITRANS P, DS III series for gauge pressure and absolute pressure from the gauge pressure series.....	195
12.2	SITRANS P, DS III series for differential pressure, flow rate and absolute pressure from the differential pressure series.....	197
12.3	SITRANS P, DS III series for level.....	200
12.4	SITRANS P, DS III series (flush mounted).....	202
12.4.1	Note 3A and EHDG.....	203
12.4.2	Connections as per EN and ASME.....	203
12.4.3	F&B and pharma flange.....	204
12.4.4	PMC Style.....	208
12.4.5	Special connections.....	209
13	Spare parts/accessories.....	211
13.1	Order data.....	211
13.2	Order data for SIMATIC PDM.....	213
A	Appendix.....	215
A.1	Certificate.....	215

Table of contents

A.2	Literature and standards.....	215
A.3	Literature and catalogs.....	215
A.4	Overview of HART operating structure.....	217
A.5	Technical support.....	220
B	List of abbreviations.....	221
B.1	Functional safety.....	221
	Glossary.....	223
	Index.....	227

Introduction

1.1 Purpose of this documentation

These instructions contain all information required to commission and use the device. It is your responsibility to read the instructions carefully prior to installation and commissioning. In order to use the device correctly, first review its principle of operation.

The instructions are aimed at persons mechanically installing the device, connecting it electronically, configuring the parameters and commissioning it, as well as service and maintenance engineers.

1.2 Product information

The programming manual is an integral part of the CD, which is either supplied or can be ordered. The programming manual is also available on the Siemens homepage.

On the CD, you will also find the catalog extract with the ordering data, the Software Device Install for SIMATIC PDM for additional installation, and the required software.

See also

Product information on SITRANS P in the Internet (<http://www.siemens.com/sitransp>)

Catalog process instrumentation (<http://www.siemens.com/processinstrumentation/catalogs>)

1.3 History

This history establishes the correlation between the current documentation and the valid firmware of the device.

The documentation of this edition applies to the following firmware:

Edition	Firmware identifier nameplate	System integration	Installation path for PDM
09/2012	FW: 11.03.03, FW: 11.03.04, FW: 11.03.05, FW: 11.03.06	PDM 6.0 ¹⁾ ; Dev. Rev.3 DD Rev.2	SITRANS P DSIII.2
	¹⁾ up to SP05 Hotfix 5		

The most important changes in the documentation when compared with the respective previous edition are given in the following table.

Edition	Remark
09/2012	The following chapters have been changed: <ul style="list-style-type: none">• "General safety notices" chapter• "Mounting" chapter• "Functional safety" chapter• "Technical data" chapter

1.4 Scope of the instructions

Table 1-1 "7MF4.33" stands for:

Order number	SITRANS P, DS III series for
7MF4033	Gauge pressure
7MF4133	Gauge pressure, flush mounted diaphragm
7MF4233	Absolute pressure from the gauge pressure series
7MF4333	Absolute pressure from the differential pressure series
7MF4433	Differential pressure and flow rate, PN 32/160 (MAWP 464/2320 psi)
7MF4533	Differential pressure and flow rate, PN 420 (MAWP 6092 psi)
7MF4633	Level

1.5 Checking the consignment

1. Check the packaging and the device for visible damage caused by inappropriate handling during shipping.
2. Report any claims for damages immediately to the shipping company.
3. Retain damaged parts for clarification.
4. Check the scope of delivery by comparing the shipping documents with your order for correctness and completeness.

 WARNING
Using a damaged or incomplete device
Danger of explosion in hazardous areas.
<ul style="list-style-type: none">• Do not use any damaged or incomplete devices.

See also

Return procedure (Page 166)

1.6 Transportation and storage

To guarantee sufficient protection during transport and storage, observe the following:

- Keep the original packaging for subsequent transportation.
- Devices/replacement parts should be returned in their original packaging.
- If the original packaging is no longer available, ensure that all shipments are properly packaged to provide sufficient protection during transport. Siemens cannot assume liability for any costs associated with transportation damages.

 CAUTION
Insufficient protection during storage
The packaging only provides limited protection against moisture and infiltration.
<ul style="list-style-type: none">• Provide additional packaging as necessary.

Special conditions for storage and transportation of the device are listed in "Technical data" (Page 169).

1.7 Notes on warranty

The contents of this manual shall not become part of or modify any prior or existing agreement, commitment or legal relationship. The sales contract contains all obligations on the part of Siemens as well as the complete and solely applicable warranty conditions. Any statements regarding device versions described in the manual do not create new warranties or modify the existing warranty.

The content reflects the technical status at the time of publishing. Siemens reserves the right to make technical changes in the course of further development.

Safety instructions

2.1 Precondition for use

This device left the factory in good working condition. In order to maintain this status and to ensure safe operation of the device, observe these instructions and all the specifications relevant to safety.

Observe the information and symbols on the device. Do not remove any information or symbols from the device. Always keep the information and symbols in a completely legible state.

Symbol	Explanation
	Consult operating instructions

2.1.1 Laws and directives

Observe the test certification, provisions and laws applicable in your country during connection, assembly and operation. These include, for example:

- National Electrical Code (NEC - NFPA 70) (USA)
- Canadian Electrical Code (CEC) (Canada)

Further provisions for hazardous area applications are for example:

- IEC 60079-14 (international)
- EN 60079-14 (EC)

2.1.2 Conformity with European directives

The CE mark on the device is a sign of conformity with the following European directives:

2.2 Use in hazardous areas

Electromagnetic Compatibility EMC 2004/108/EC	Directive of the European Parliament and of the Council on the approximation of the laws of the Member States relating to electromagnetic compatibility and repealing Directive 89/336/EEC.
Atmosphère explosible ATEX 94/9/EC	Directive of the European Parliament and the Council on the approximation of the laws of the Member States concerning equipment and protective systems intended for use in potentially explosive atmospheres.
Pressure Equipment Directive PED 97/23/EC	Directive of the European Parliament and of the Council on the approximation of the laws of the Member States concerning pressure equipment.

The standards applied can be found in the EC declaration of conformity for the device.

 WARNING
Improper device modifications
Danger to personnel, system and environment can result from modifications to the device, particularly in hazardous areas.
<ul style="list-style-type: none">• Only carry out modifications that are described in the instructions for the device. Failure to observe this requirement cancels the manufacturer's warranty and the product approvals.

Due to the large number of possible applications, each detail of the described device versions for each possible scenario during commissioning, operation, maintenance or operation in systems cannot be considered in the instructions. If you need additional information not covered by these instructions, contact your local Siemens office or company representative.

Note

Operation under special ambient conditions

We highly recommend that you contact your Siemens representative or our application department before you operate the device under special ambient conditions as can be encountered in nuclear power plants or when the device is used for research and development purposes.

2.2 Use in hazardous areas

Qualified personnel for hazardous area applications

Persons who install, assemble, commission, operate and service the device in a hazardous area must have the following specific qualifications:

- They are authorized, trained or instructed in operating and maintaining devices and systems according to the safety regulations for electrical circuits, high pressures, aggressive and hazardous media.
- They are authorized, trained, or instructed in carrying out work on electrical circuits for hazardous systems.
- They are trained or instructed in maintenance and use of appropriate safety equipment according to the pertinent safety regulations.

**WARNING****Unsuitable device for the hazardous area**

Danger of explosion.

- Only use equipment that is approved for use in the intended hazardous area and labelled accordingly.

See also

Technical data (Page 169)

**WARNING****Loss of safety of device with type of protection "Intrinsic safety Ex i"**

If the device has already been operated in non-intrinsically safe circuits or the electrical specifications have not been observed, the safety of the device is no longer ensured for use in hazardous areas. There is a danger of explosion.

- Connect the device with type of protection "Intrinsic safety" solely to an intrinsically safe circuit.
- Observe the specifications for the electrical data on the certificate and in Chapter "Technical data (Page 169)".

 WARNING
Use of incorrect device parts in potentially explosive environments
<p>Devices and their associated device parts are either approved for different types of protection or they do not have explosion protection. There is a danger of explosion if device parts (such as covers) are used for devices with explosion protection that are not expressly suited for this type of protection. If you do not adhere to these guidelines, the test certificates and the manufacturer warranty will become null and void.</p>
<ul style="list-style-type: none">• Use only device parts that have been approved for the respective type of protection in the potentially explosive environment. Covers that are not suited for the "explosion-proof" type of protection are identified as such by a notice label attached to the inside of the cover with "Not Ex d Not SIL".• Do not swap device parts unless the manufacturer specifically ensures compatibility of these parts.

 WARNING
Risk of explosion due to electrostatic charge
<p>To prevent the build-up of an electrostatic charge in a hazardous area, the key cover must be closed during operation and the screws tightened.</p>
<p>The key cover may be opened temporarily at any time for the purposes of operating the transmitter, even during plant operation; the screws should then be tightened again.</p>

NOTICE
Electrostatic-sensitive devices
<p>The device contains electrostatic-sensitive devices (ESD). ESD can be destroyed by voltages far too low to be detected by humans. These voltages can occur if you simply touch a component part or the electrical connections of a module without being electrostatically discharged. The damage to a module caused by overvoltage cannot normally be detected immediately; it only becomes apparent after a longer period of operating time has elapsed.</p>
<p>Protective measures against the discharge of static electricity:</p>
<ul style="list-style-type: none">• Make sure that no power is applied.• Before working with modules, make sure that you discharge static from your body, for example by touching a grounded object.• Devices and tools used must be free of static charge.• Hold modules only by their edges.• Do not touch connector pins or conductor tracks on a module with the ESD notice.

Description

3.1 System configuration

Overview

The pressure transmitter can be used in a number of system configurations:

- as a stand-alone version, supplied with the necessary auxiliary power
- as part of a complex system environment, e.g. SIMATIC S7

System communication

Communication is via the HART protocol, using:

- HART Communicator (load 230 ... 1100 Ω)
- PC with HART modem, on which appropriate software is installed, e.g. SIMATIC PDM (load 230 ... 500 Ω)
- Control system which can communicate via the HART protocol, e.g. SIMATIC PCS7

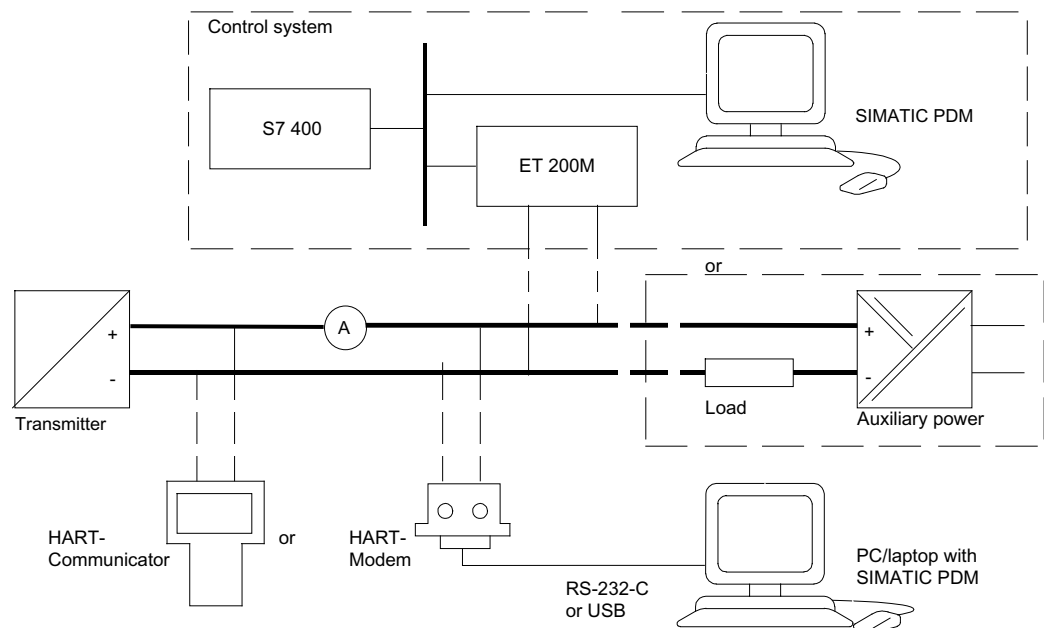

Figure 3-1 Possible system configurations

3.2 Application range

Overview

Depending on the version, a transmitter measures corrosive, non-corrosive and hazardous gases, vapors and liquids.

You can use the transmitter for the following types of measurement:

- Gauge pressure
- Absolute pressure
- Differential pressure

With appropriate parameter settings and the necessary add-on parts (e.g. flow orifices and remote seals), the pressure transmitter can also be used for the following measurements:

- Level
- Volume
- Mass
- Volumetric flow
- Mass flow rate

The output signal is always a load-independent direct current between 4 and 20 mA.

You can install the "intrinsically-safe" or "explosion-proof" version of the transmitter in hazardous areas. The devices have an EC type examination certificate and comply with the appropriate harmonized European CENELEC directives.

Transmitters with remote seals of different shapes can be delivered for special applications. For example, measuring high-viscosity substances is a special application.

Gauge pressure

This version measures aggressive, non-aggressive and hazardous gases, vapors and liquids.

The smallest span is 0.01 bar g (0.145 psi g), and the largest 700 bar g (10153 psi g).

Differential pressure and flow rate

This version measures corrosive, non-corrosive and hazardous gases, vapors and liquids. You can use this version for the following measurement types:

- differential pressure, e.g. effective differential pressure
- Gauge pressure, suitable for small positive or negative pressure value
- in combination with a restrictor device: flow rate $q \sim \sqrt{\Delta p}$

The smallest measuring span is 1 mbar (0.0145 psi), the largest 30 bar (435 psi).

Level

This version with mounting flange measures the level of non-corrosive, corrosive and hazardous liquids in open and closed containers. The smallest measuring span is 25 mbar (0.363 psi), the largest 5 bar (72.5 psi). The nominal diameter of the mounting flange is DN 80 or DN 100 or 3" or 4".

The negative connection of the measuring cell is kept open when measuring the level of open containers. This measurement is referred to as "measurement against atmosphere". The negative connection is normally connected with the container when measuring the level of closed containers. This balances the static pressure.

Wetted parts are made of various materials, depending on corrosion resistance requirements.

Absolute pressure

This version measures the absolute pressure of aggressive, non-aggressive and hazardous gases, vapors and liquids.

There are two series: a "differential pressure" series and a "gauge pressure" series. The "differential pressure" series is distinguished by a high overload capability.

The smallest measuring span of the "differential pressure" series is 8.3 mbar a (0.12 psi a), and the largest is 100 bar a (1450 psi a).

The smallest measuring span of the "gauge pressure" series is 8.3 mbar a (0.12 psi a), and the largest is 30 bar a (435 psi a).

3.3 Structure

Depending on a customer-specific order, the device comprises different parts.

3.3 Structure

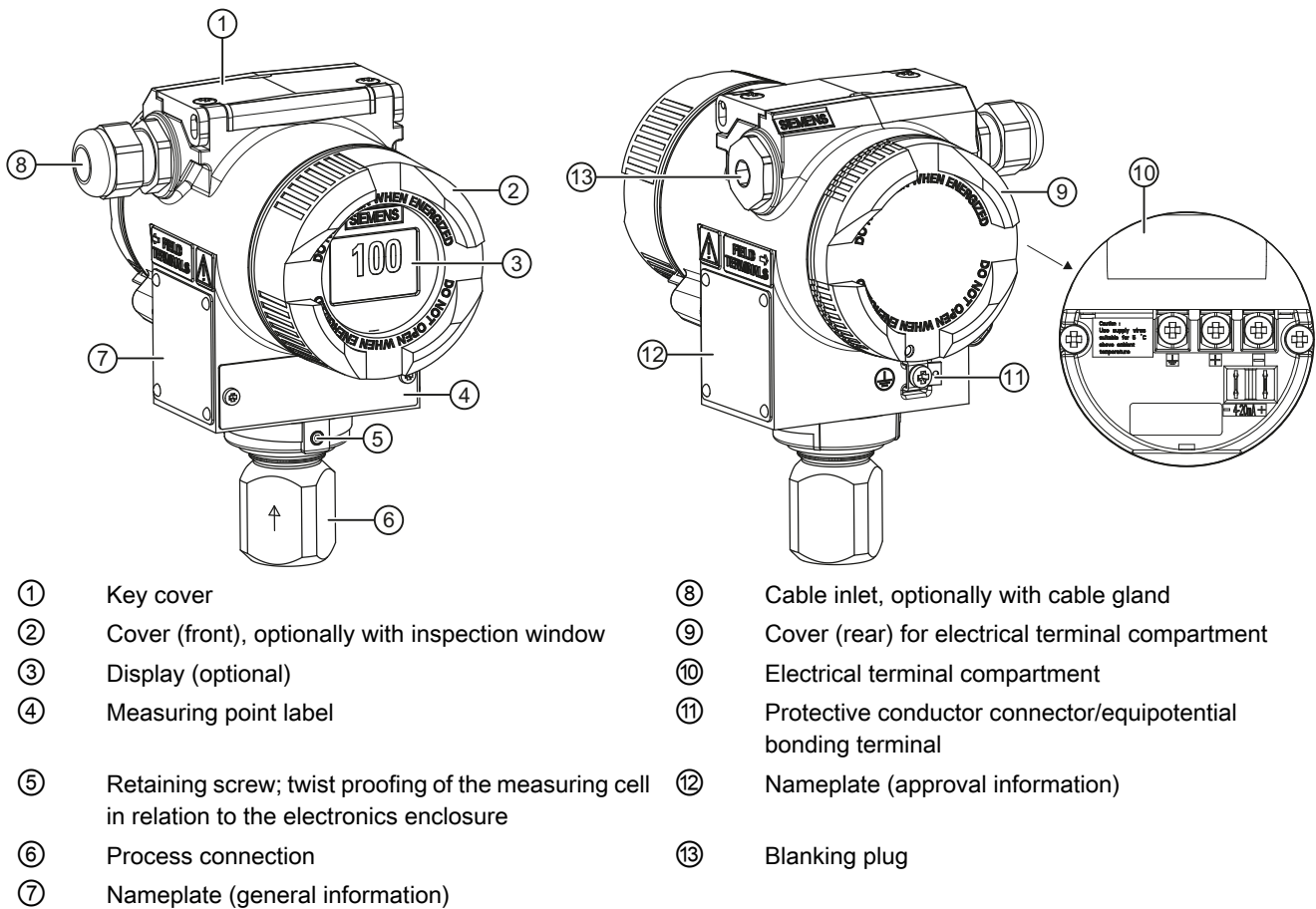

Figure 3-2 View of the transmitter: Left: Front right: Rear view

- The electronics enclosure is made of die cast aluminum or precision cast stainless steel.
- The housing has a removable circular cover at the front and the back.
- Depending on the device version, the front cover (2) may be designed as an inspection window. You can read the measured values straight off the digital display through this inspection window.
- The cable inlet (8) to the electrical terminal compartment is at the side; either the left or right-hand one can be used. The unused opening is closed with a blanking plug (13).
- The protective conductor terminal/equipotential bonding terminal (11) is located at the back of the enclosure.
- The electrical terminal compartment (10) for the auxiliary power and shield is accessible when you remove the back cover (9).
- The measuring cell with a process connection (6) is located in the lower section of the enclosure. This measuring cell is secured against twisting by a retaining screw (5). Thanks to the modular structure of the transmitter, the measuring cell, the electronic unit or the network card can be replaced if required.
- On the upper face of the enclosure you can see crosshead screws which secure the key cover (1), under which there are 3 keys for local operation.

3.4 Nameplate layout

Nameplate with general information

The nameplate bearing the Order No. and other important information, such as design details and technical data, is on the side of the enclosure.

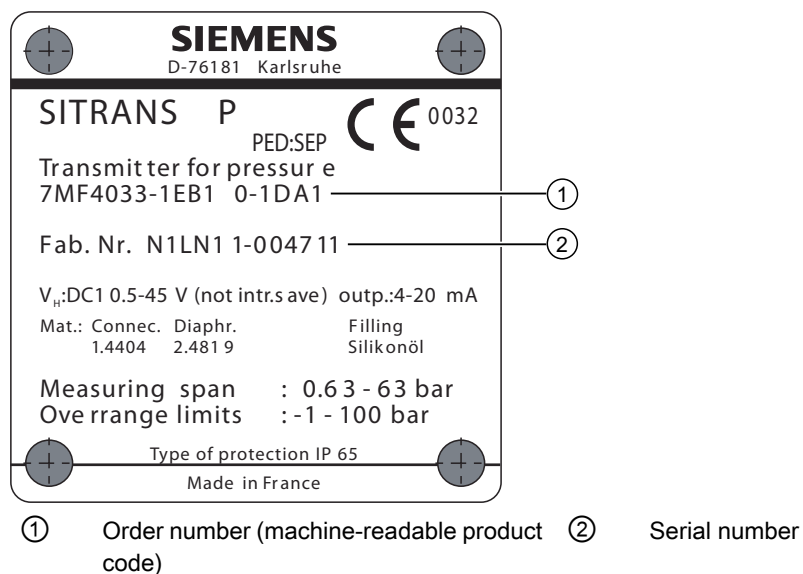

Figure 3-3 Example of a nameplate

3.5 Measuring point label layout

Nameplate with approval information

On the opposite side is the nameplate with approval information. This nameplate shows e.g. the hardware and firmware versions. Certificate information is also listed if the transmitter is an ex-version.

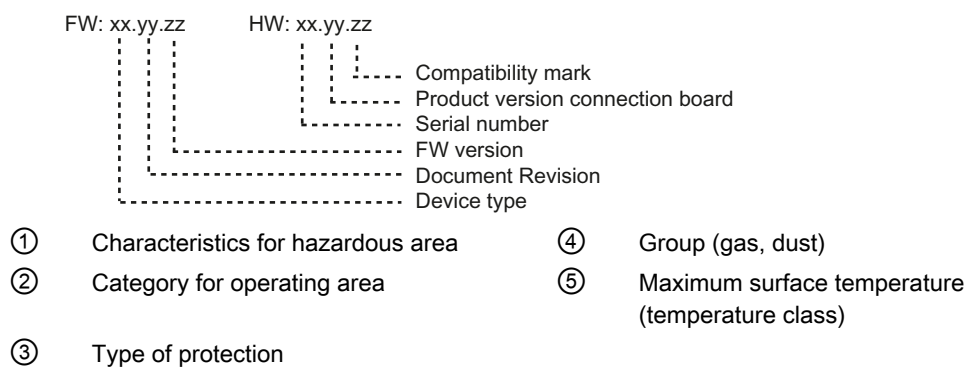
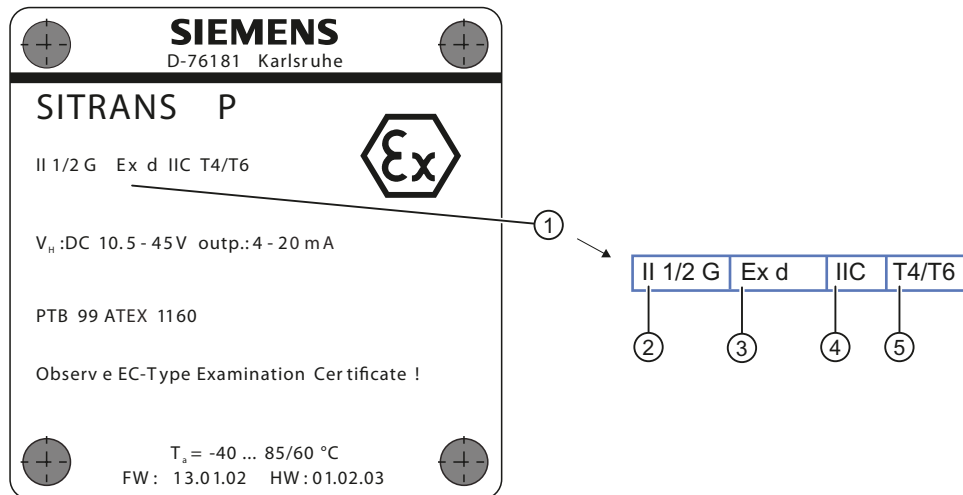

Figure 3-4 Example of a nameplate

3.5 Measuring point label layout

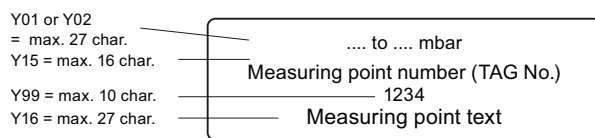

Figure 3-5 Example of measuring point label

3.6 Functional principle

3.6.1 Overview of mode of operation

This chapter describes how the transmitter works.

First the electronics are described, and then the physical principle of the sensors which are used with the various device versions for the individual measurement types.

3.6.2 Operation of the electronics

Description

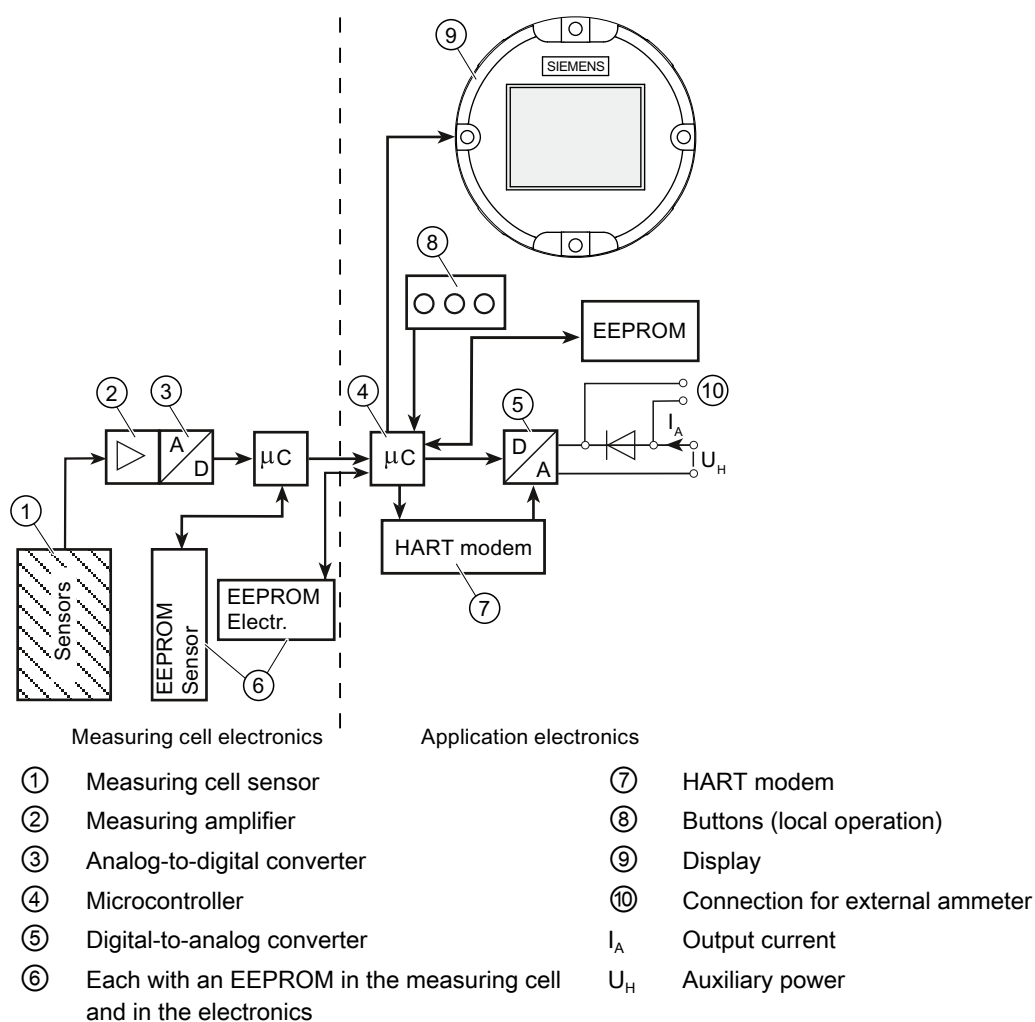

Figure 3-6 Operation of the electronics with HART communication

3.6 Functional principle

Function

- The input pressure is converted into an electrical signal by the sensor ①.
- This signal is amplified by the measuring amplifier ② and digitized in an analog-to-digital converter ③.
- The digital signal is analyzed in a microcontroller ④ and corrected with regard to linearity and thermal characteristics.
- The digital signal is then converted in a digital-to-analog converter ⑤ into the output current of 4 to 20 mA. A diode circuit provides reverse voltage protection.
- You can make an uninterrupted current measurement with a low resistance ammeter at the connection ⑩.
- The measuring cell-specific data, electronics data and parameter assignment data are saved in two EEPROMs ⑥. The first memory is linked to the measuring cell, the second to the electronics.

Operation

- The buttons ⑧ can be used to call up individual functions, so-called modes.
- If you have a device with a display ⑨, you can use it to track the mode settings and other device messages.
- The basic mode settings can be changed with a computer and HART modem ⑦ via PDM.

3.6.3 Measuring cell operation



CAUTION

If the measurement signal fails because of sensor breakage, the seal diaphragm may also be destroyed. In the worst case scenario, the process medium leaks from the reference pressure opening in the devices used for gauge pressure with a measuring span of ≤ 63 bar.

In the following sections, the process variable to be measured is called general inlet pressure.

Overview

The following modes of operation are described:

- Gauge pressure
- Absolute pressure
- Differential pressure and flow rate
- Level

The following process connections are available, for example:

- G1/2 B, 1/2-14 NPT
- Male thread: M20

- Flange connection in accordance with EN 61518
- Flush-mounted process connections

3.6.3.1 Measuring cell for gauge pressure

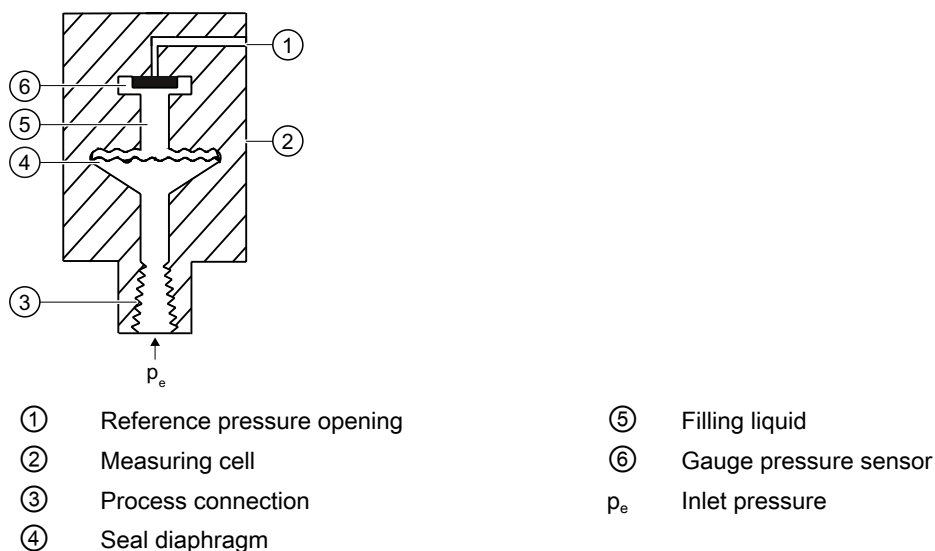

Figure 3-7 Function chart of measuring cell for gauge pressure

The inlet pressure (p_e) is transferred to the gauge pressure sensor (⑥) via the seal diaphragm (④) and the fill fluid (⑤), displacing its measuring diaphragm. The displacement changes the resistance of the four piezoresistors (bridge circuit) of the gauge pressure sensor. The change in the resistance causes a bridge output voltage proportional to the inlet pressure.

Transmitters with measuring span ≤ 63 bar measure the inlet pressure against atmosphere, those with measuring spans ≥ 160 bar against vacuum.

3.6.3.2 Measuring cell for differential pressure and flow rate

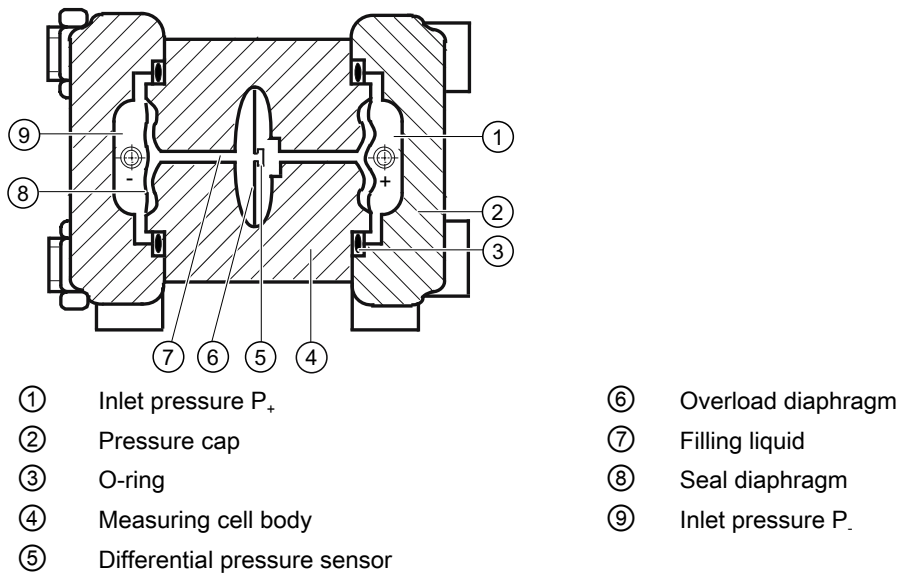

Figure 3-8 Function chart of the measuring cell for differential pressure and flow rate

- Differential pressure is transmitted to the differential pressure sensor ⑤ through the seal diaphragms ⑧ and the filling liquid ⑦.
- When measuring limits are exceeded, the seal diaphragm ⑧ is displaced until the seal diaphragm ② rests on the measuring cell body ④. The differential pressure sensor ⑤ is thus protected against overloading since no further deflection of the overload diaphragm ⑥ is possible.
- The seal diaphragm ⑧ is displaced by the differential pressure. The displacement changes the resistance of the four piezoresistors (bridge circuit) of the differential pressure sensor.
- The change in the resistance causes a bridge output voltage proportional to the differential pressure.

3.6.3.3 Measuring cell for level

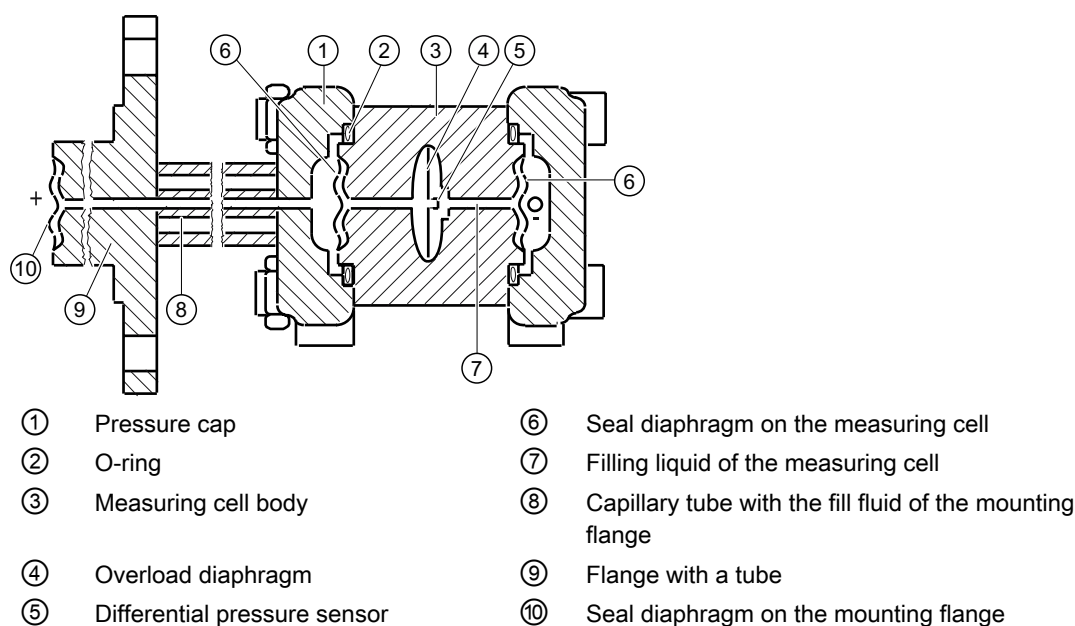

Figure 3-9 Function chart of the measuring cell for level

- The inlet pressure (hydrostatic pressure) works hydraulically on the measuring cell through the seal diaphragm ⑩ on the mounting flange ⑩.
- Differential pressure at the measuring cell is transmitted to the differential pressure sensor ⑤ through the seal diaphragms ⑥ and the filling liquid ⑦.
- When measuring limits are exceeded, the overload diaphragm ④ is displaced until one of the seal diaphragms ⑥ or ⑩ rests on the measuring cell body ③. The seal diaphragms ⑥ thus protect the differential pressure sensor ⑤ from overload.
- The seal diaphragm ⑥ is displaced by the differential pressure. The displacement changes the resistance of the four doped piezoresistors in the bridge circuit.
- The change in the resistance causes a bridge output voltage proportional to the differential pressure.

3.6.3.4 Measuring cell for absolute pressure from the differential pressure series

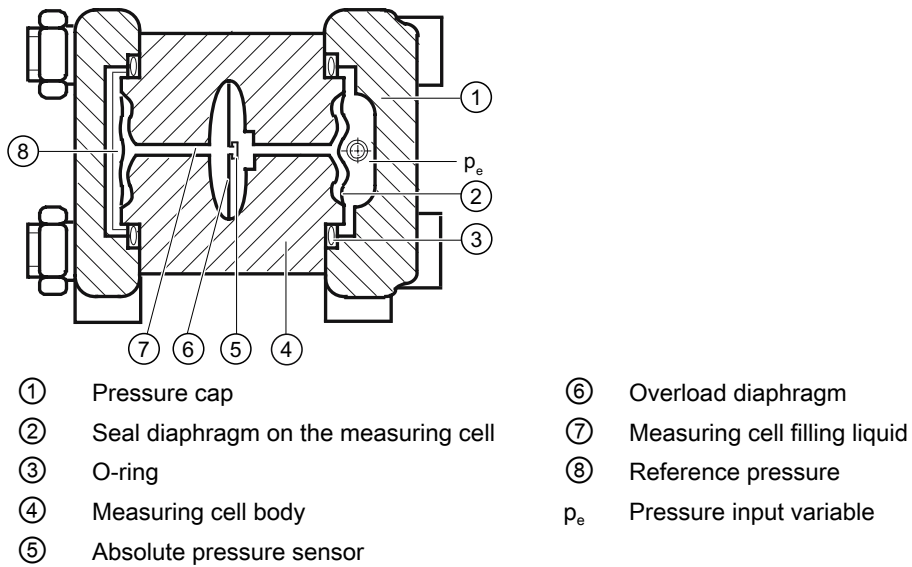

Figure 3-10 Function chart of measuring cell for absolute pressure

- Absolute pressure is transmitted to the absolute pressure sensor ⑤ through the seal diaphragm ② and the filling liquid ⑦.
- When measuring limits are exceeded, the overload diaphragm ⑥ is displaced until the seal diaphragm ② rests on the measuring cell body ④. The seal diaphragm thus protects the absolute pressure sensor ⑤ from overload.
- The difference between the inlet pressure (p_e) and the reference pressure ⑧ on the negative side of the measuring cell displaces the seal diaphragm ②. The displacement changes the resistance of the four piezoresistors (bridge circuit) of the absolute pressure sensor.

- The change in the resistance causes a bridge output voltage proportional to the absolute pressure.

3.6.3.5 Measuring cell for absolute pressure from the gauge pressure series

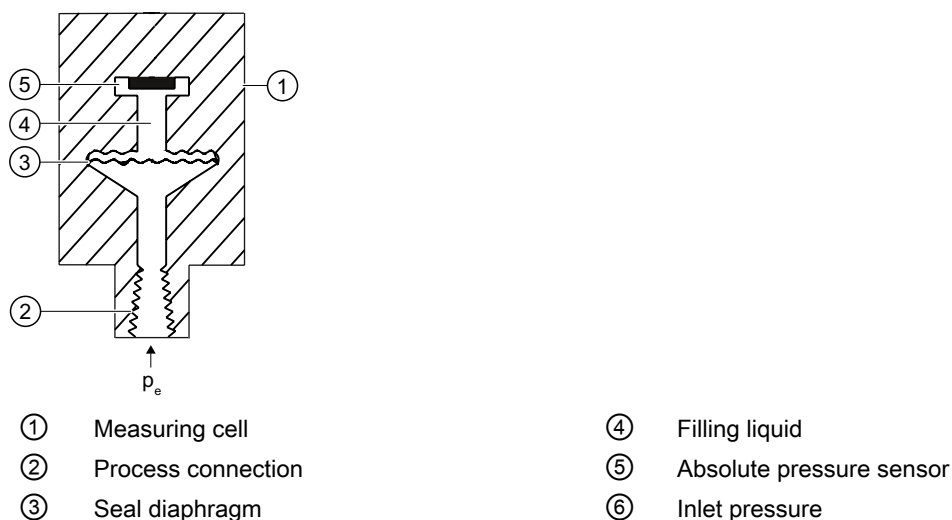

Figure 3-11 Function chart of measuring cell for absolute pressure

The inlet pressure (p_e) is transferred to the absolute pressure sensor ⑤ via the seal diaphragm ③ and the fill fluid ④, displacing its measuring diaphragm. The displacement changes the resistance of the four piezoresistors (bridge circuit) of the absolute pressure sensor. The change in the resistance causes a bridge output voltage proportional to the inlet pressure.

3.6.3.6 Measuring cell for gauge pressure, front-flush membrane

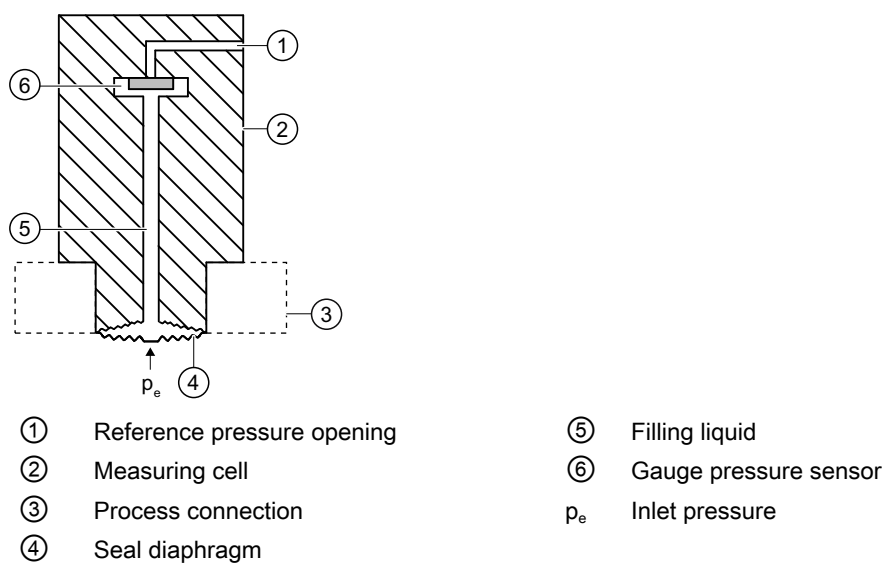

Figure 3-12 Function chart of the measuring cell for gauge pressure, flush mounted diaphragm

Description

3.6 Functional principle

The inlet pressure (p_e) is transferred to the gauge pressure sensor ⑥ via the seal diaphragm ④ and the filling liquid ⑤, displacing its measuring diaphragm. The displacement changes the resistance of the four piezoresistors (bridge circuit) of the gauge pressure sensor. The change in the resistance causes a bridge output voltage proportional to the inlet pressure.

Transmitters with measuring span ≤ 63 bar measure the inlet pressure against atmosphere, those with measuring spans ≥ 160 bar against vacuum.

3.6.3.7 Measuring cell for absolute pressure, front-flush membrane

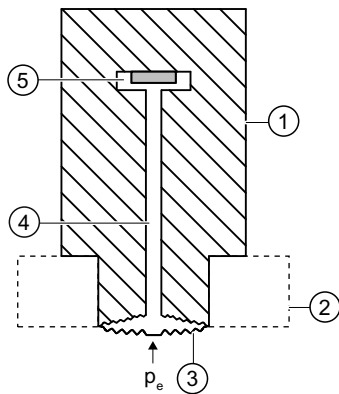

- ① Measuring cell
- ② Process connection
- ③ Seal diaphragm
- ④ Filling liquid
- ⑤ Absolute pressure sensor
- p_e Inlet pressure

Figure 3-13 Function chart of the measuring cell for absolute pressure, flush mounted diaphragm

The inlet pressure (p_e) is transferred to the absolute pressure sensor ⑤ via the seal diaphragm ③ and the filling liquid ④, and displaces its measuring diaphragm. The displacement changes the resistance of the four piezoresistors (bridge circuit) of the absolute pressure sensor. The change in the resistance causes a bridge output voltage proportional to the inlet pressure.

3.7 Remote seal

Product description

- A remote seal measuring system comprises the following elements:
 - Remote seal
 - Transmission line, e.g. capillary line
 - Measuring device

Note

Malfunction of the remote seal measuring system

If you separate the components of the remote seal measuring system, this results in malfunctioning of the system.

Do not separate the components under any circumstances.

- The measuring system based on a hydraulic principle is used to transfer pressure.
- The capillary line and the remote seal diaphragm are the most sensitive components in the remote seal measuring system. The material thickness of the remote seal diaphragm is only ~ 0.1 mm.
- The smallest of leakages in the transmission system leads to the loss of transmission fluid.
- The loss of transmission fluid results in inaccuracies in the measurement and failure of the measuring system.
- In order to avoid leaks and measuring errors, please observe the installation and maintenance instructions in addition to the safety notes.

3.8 SIMATIC PDM

SIMATIC PDM is a software package for configuring, parameter assignment, commissioning, diagnostics and maintenance of this device and other process devices.

SIMATIC PDM offers simple monitoring of process values, alarms, and device status information of the transmitter.

SIMATIC PDM allows the process device data to be:

- displayed
- set
- modified
- saved
- diagnosed
- checked for plausibility
- managed
- simulated

Installing/mounting

4.1 Basic safety instructions

 WARNING
Wetted parts unsuitable for the process media
Danger of injury or damage to device.
Hot, toxic and corrosive media could be released if the process medium is unsuitable for the wetted parts.
<ul style="list-style-type: none">• Ensure that the material of the device parts wetted by the process medium is suitable for the medium. Refer to the information in "Technical data" (Page 169).

 WARNING
Incorrect material for the diaphragm in Zone 0
Danger of explosion in the hazardous area. In the case of operation with intrinsically safe supply units of category "ib" or devices of the flameproof enclosure version "Ex d" and simultaneous use in Zone 0, transmitter explosion protection depends on the tightness of the diaphragm.
<ul style="list-style-type: none">• Ensure that the material used for the diaphragm is suitable for the process medium. Refer to the information in the section "Technical data (Page 169)".

 WARNING
Unsuitable connecting parts
Danger of injury or poisoning.
In case of improper mounting hot, toxic and corrosive process media could be released at the connections.
<ul style="list-style-type: none">• Ensure that connecting parts (such as flange gaskets and bolts) are suitable for connection and process media.

Note

Material compatibility

Siemens can provide you with support concerning selection of sensor components wetted by process media. However, you are responsible for the selection of components. Siemens accepts no liability for faults or failures resulting from incompatible materials.

 WARNING
Exceeded maximum permissible operating pressure
Danger of injury or poisoning.
The maximum permissible operating pressure depends on the device version. The device can be damaged if the operating pressure is exceeded. Hot, toxic and corrosive process media could be released.
<ul style="list-style-type: none">• Make sure that the device is suitable for the maximum permissible operating pressure of your system. Refer to the information on the nameplate and/or in "Technical data (Page 169)".

 WARNING
Exceeded maximum ambient or process media temperature
Danger of explosion in hazardous areas.
Device damage.
<ul style="list-style-type: none">• Make sure that the maximum permissible ambient and process media temperatures of the device are not exceeded. Refer to the information in Chapter "Technical data (Page 169)".

 WARNING
Open cable inlet or incorrect cable gland
Danger of explosion in hazardous areas.
<ul style="list-style-type: none">• Close the cable inlets for the electrical connections. Only use cable glands or plugs which are approved for the relevant type of protection.

⚠ WARNING
Incorrect conduit system
Danger of explosion in hazardous areas as result of open cable inlet or incorrect conduit system.
<ul style="list-style-type: none">• In the case of a conduit system, mount a spark barrier at a defined distance from the device input. Observe national regulations and the requirements stated in the relevant approvals.

See also

Technical data (Page 169)

⚠ WARNING
Incorrect mounting at Zone 0
Danger of explosion in hazardous areas.
<ul style="list-style-type: none">• Ensure sufficient tightness at the process connection.• Observe the standard IEC/EN 60079-14.

⚠ WARNING
Danger with "flameproof enclosure" protection
Danger of explosion in hazardous areas. An explosion may be caused by hot gas escaping from the flameproof enclosure if there is too little space between it and the fixed parts.
<ul style="list-style-type: none">• Ensure that there is a space of at least 40 mm between the flameproof joint and the fixed parts.

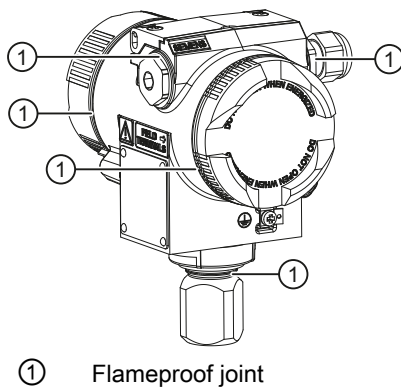

 WARNING
Loss of explosion protection
Danger of explosion in hazardous areas if the device is open or not properly closed.
<ul style="list-style-type: none">• Close the device as described in Chapter "Connecting the device (Page 60)".

 WARNING
Use of incorrect device parts in potentially explosive environments
Devices and their associated device parts are either approved for different types of protection or they do not have explosion protection. There is a danger of explosion if device parts (such as covers) are used for devices with explosion protection that are not expressly suited for this type of protection. If you do not adhere to these guidelines, the test certificates and the manufacturer warranty will become null and void.
<ul style="list-style-type: none">• Use only device parts that have been approved for the respective type of protection in the potentially explosive environment. Covers that are not suited for the "explosion-proof" type of protection are identified as such by a notice label attached to the inside of the cover with "Not Ex d Not SIL".• Do not swap device parts unless the manufacturer specifically ensures compatibility of these parts.

 CAUTION
Hot surfaces resulting from hot process media
Danger of burns resulting from surface temperatures above 70 °C (155 °F).
<ul style="list-style-type: none">• Take appropriate protective measures, for example contact protection.• Make sure that protective measures do not cause the maximum permissible ambient temperature to be exceeded. Refer to the information in Chapter "Technical data (Page 169)".

 CAUTION
External stresses and loads
Damage to device by severe external stresses and loads (e.g. thermal expansion or pipe tension). Process media can be released.
<ul style="list-style-type: none">• Prevent severe external stresses and loads from acting on the device.

4.1.1 Installation location requirements

 WARNING
Insufficient air supply The device may overheat if there is an insufficient supply of air. <ul style="list-style-type: none">• Install the device so that there is sufficient air supply in the room.• Observe the maximum permissible ambient temperature. Refer to the information in the section "Technical data (Page 169)".

 CAUTION
Aggressive atmospheres Damage to device through penetration of aggressive vapors. <ul style="list-style-type: none">• Ensure that the device is suitable for the application.

NOTICE
Direct sunlight Increased measuring errors. <ul style="list-style-type: none">• Protect the device from direct sunlight. Make sure that the maximum ambient temperature is not exceeded. Refer to the information in the section Technical data (Page 169).

4.1 Basic safety instructions

4.1.2 Proper mounting

4.1.2.1 Incorrect mounting

NOTICE
Incorrect mounting The device can be damaged, destroyed, or its functionality impaired through improper mounting. <ul style="list-style-type: none">• Before installing ensure there is no visible damage to the device.• Make sure that process connectors are clean, and suitable gaskets and glands are used.• Mount the device using suitable tools. Refer to the information in Chapter "Technical data (Page 169)", for example installation torques requirements.

 CAUTION
Loss of degree of protection Damage to device if the enclosure is open or not properly closed. The degree of protection specified on the nameplate or in Chapter "Technical data (Page 169)" is no longer guaranteed. <ul style="list-style-type: none">• Make sure that the device is securely closed.

See also

Connecting the device (Page 60)

4.2 Disassembly

 WARNING
Incorrect disassembly
The following dangers may result through incorrect disassembly:
- Injury through electric shock
- Danger through emerging media when connected to the process
- Danger of explosion in hazardous area
In order to disassemble correctly, observe the following:
<ul style="list-style-type: none">• Before starting work, make sure that you have switched off all physical variables such as pressure, temperature, electricity etc. or that they have a harmless value.• If the device contains dangerous media, it must be emptied prior to disassembly. Make sure that no environmentally hazardous media are released.• Secure the remaining connections so that no damage can result if the process is started unintentionally.

4.3 Installation (except level)

4.3.1 Instructions for installation (except level)

Conditions

Note

Compare the desired operating data with the data on the nameplate.
Please also refer to the information on the remote seal if this is fitted.

Note

Protect the transmitter against:

- Direct heat radiation
 - Rapid temperature fluctuations
 - Heavy contamination
 - Mechanical damage
 - Direct sunlight
-

The installation location is to be as follows:

4.3 Installation (except level)

- Easily accessible
- As close as possible to the measuring point
- Vibration-free
- Within the permitted ambient temperature values

Installation configuration

The transmitter may in principle be configured above or below the pressure tapping point. The recommended configuration depends on the aggregate state of the medium.

Installation configuration for gases

Install the transmitter above the pressure tapping point.

Lay the pressure tubing with a constant gradient to the pressure tapping point, so that any condensation produced can drain in the main line and thereby avoid corruption of the measured values.

Installation configuration for vapor and liquid

Install the transmitter below the pressure tapping point.

Lay the pressure tubing with a constant gradient to the pressure tapping point so that any gas pockets can escape in the main line.

4.3.2 Installation (except level)

Note

Damage to measuring cell

When installing the process connection of the pressure transmitter, do not rotate the housing. Rotating the housing may damage the measuring cell.

To avoid damage to the device, tighten the threaded nuts of the measuring cell using a wrench.

Procedure

Attach the transmitter to the process connection with an appropriate tool.

See also

Introduction to commissioning (Page 150)

4.3.3 Fastening

Fastening without the mounting bracket

You can fasten the transmitter directly on the process connection.

Fastening with the mounting bracket

You can fasten the mounting bracket as follows:

- On a wall or a mounting frame using two screws
- On a vertical or horizontal mounting tube (Ø 50 to 60 mm) using a tube bracket

Fasten the transmitter mounting bracket using the two screws provided.

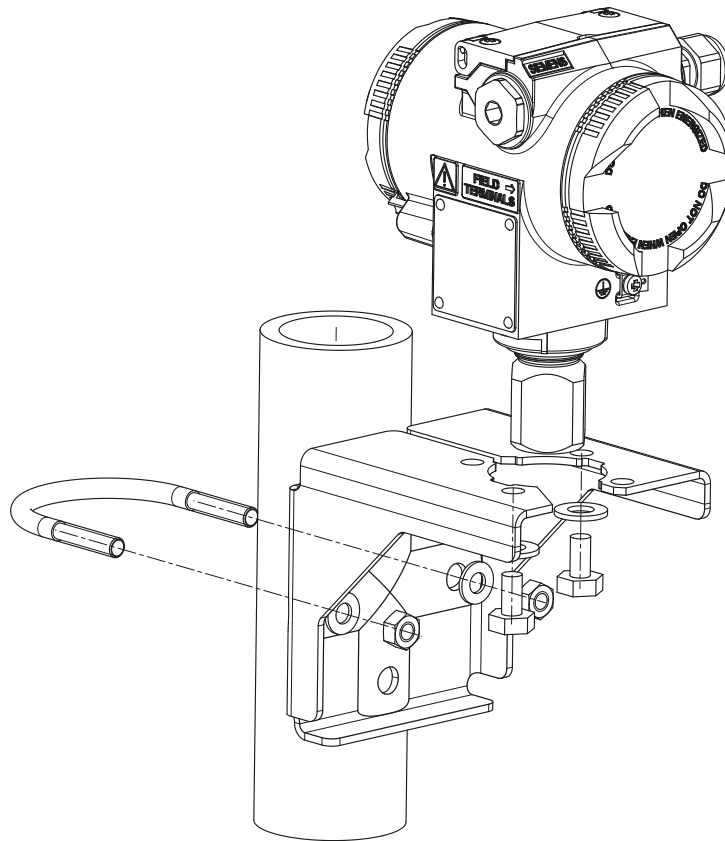

Figure 4-1 Fastening the transmitter on the mounting bracket

4.3 Installation (except level)

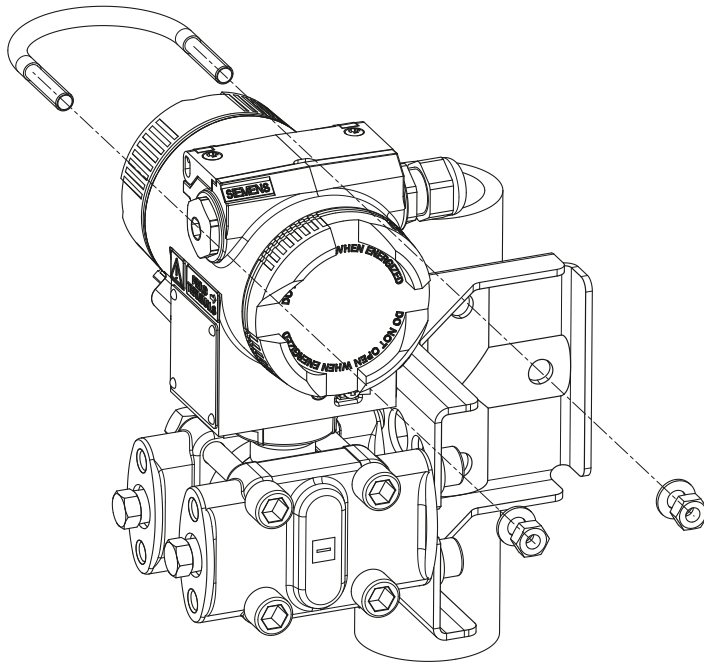

Figure 4-2 An example of fastening the transmitter on the mounting bracket in the case of differential pressure and horizontal differential pressure lines

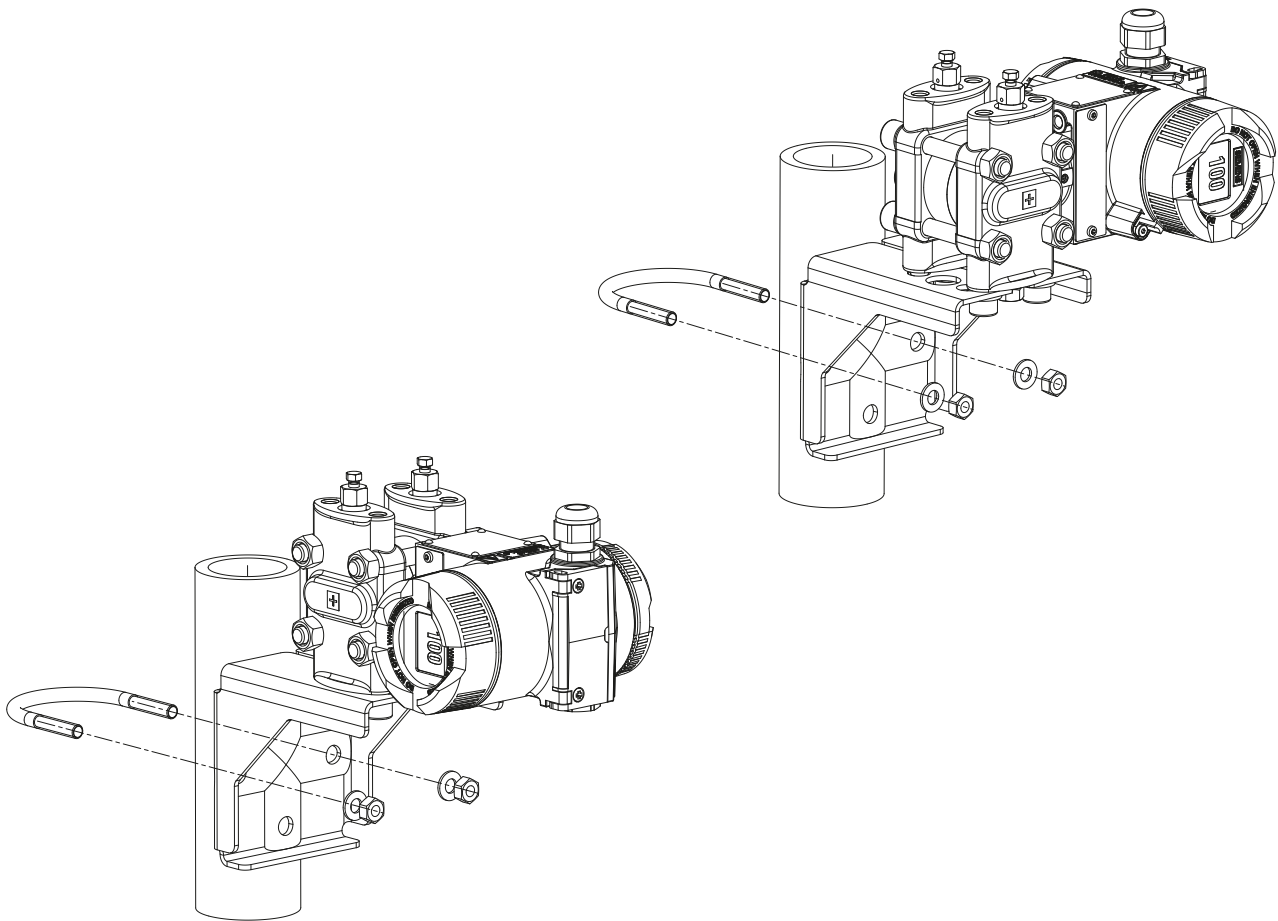

Figure 4-3 An example of fastening on the mounting bracket in the case of differential pressure and vertical differential pressure lines

4.4 "Level" installation

4.4.1 Instructions for level installation

Requirements

Note

Compare the desired operating data with the data on the nameplate.

Please also refer to the information on the remote seal if this is fitted.

4.4 "Level" installation

Note

Protect the transmitter from:

- Direct heat
 - Rapid temperature changes
 - Severe soiling
 - Mechanical damage
 - Direct sunlight
-

Note

Select the height of the mounting flange such that the pressure transmitter is always mounted below the lowest fill height to be measured.

The installation location is to be as follows:

- Easily accessible
- The measuring point must be as close as possible
- Vibration-free
- Within the permitted ambient temperature values

4.4.2 Installation for level

Note

Seals are required for the installation. The seals must be compatible with the medium to be measured.

Seals are not included in the delivery.

Procedure

To install the transmitter for level, proceed as follows:

1. Attach the seal to the container's mating flange.
Ensure that the seal is centrally positioned and that it does not restrict the movement of the flange's seal diaphragm in any way as otherwise the tightness of the process connection is not guaranteed.
2. Screw on the transmitter's flange.
3. Observe the installation position.

4.4.3 Connection of the negative pressure line

Assembly on an open container

A line is not required when taking measurements in an open container since the negative chamber is connected with the atmosphere.

Ensure that no dirt enters the open connection ports, for example by using connection screws with a 7MF4997-1CP bleed valve.

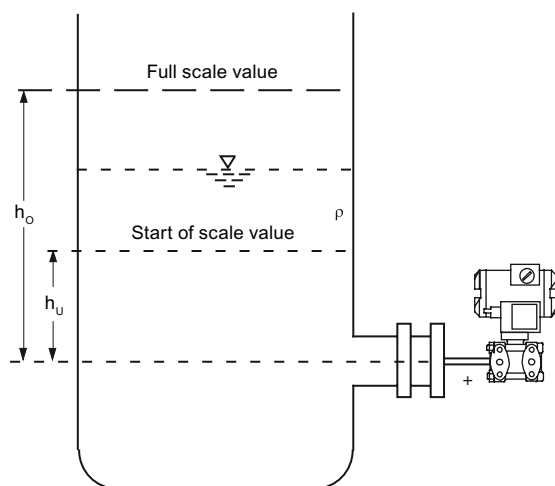

Formula:

$$\text{Start of scale value: } p_{MA} = \rho \cdot g \cdot h_U$$

$$\text{Full-scale value: } p_{ME} = \rho \cdot g \cdot h_O$$

Measurement assembly on an open container

h_U Lower filling level
 h_O Upper filling level
 ρ Pressure

Δp_{MA} Start of scale value
 Δp_{ME} Full-scale value
 ρ Density of the measured medium in the container
 g Acceleration due to gravity

Assembly on a closed container

When taking measurements in a closed container without or with little condensate formation, the negative pressure line is not filled. Lay the line in such a way that pockets of condensate do not form. Install a condensation container if required.

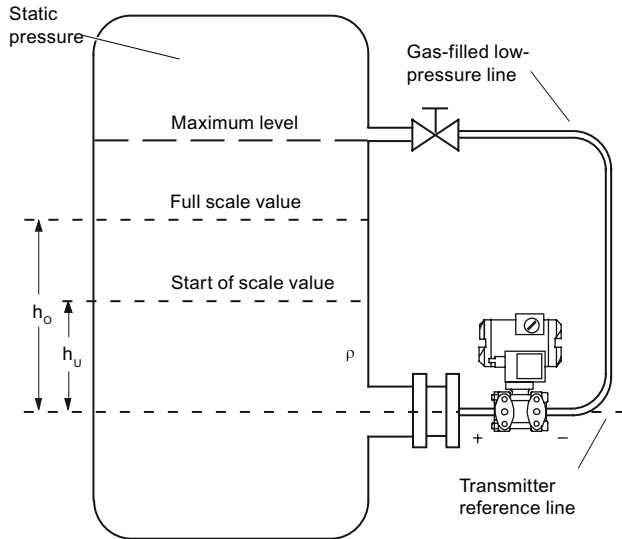

Formula:

Start-of-scale value: $\Delta p_{MA} = \rho \cdot g \cdot h_u$

Full-scale value: $\Delta p_{ME} = \rho \cdot g \cdot h_o$

Measurement assembly on a closed container (no or little condensate separation)

h_u	Lower filling level	Δp_{MA}	Start of scale value
h_o	Upper filling level	Δp_{ME}	Full-scale value
p	Pressure	ρ	Density of the measured medium in the container
		g	Acceleration due to gravity

When taking measurements in a closed container with strong condensate formation, you must fill the negative pressure line (mostly with the condensate of the measured medium) and install a condensate pot. You can cut off the device using the dual pneumatic block 7MF9001-2.

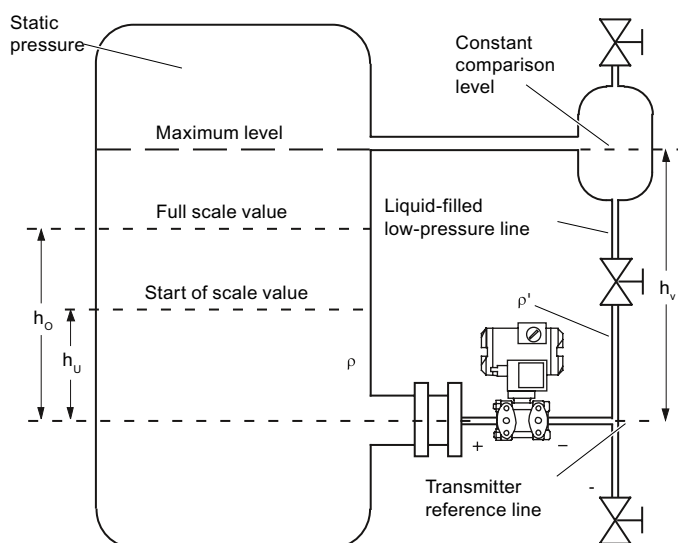

Formula:

Start-of-scale value:

$$\Delta p_{MA} = g \cdot (h_U \cdot \rho - h_V \cdot \rho')$$

Full-scale value:

$$\Delta p_{MA} = g \cdot (h_O \cdot \rho - h_V \cdot \rho')$$

Measurement assembly on a closed container (strong condensate formation)

h_U	Lower filling level	Δp_{MA}	Start of scale value
h_O	Upper filling level	Δp_{ME}	Full-scale value
h_V	Gland distance	ρ	Density of the measured medium in the container
p	Pressure	ρ'	Density of fluid in the negative pressure line corresponds to the prevailing temperature there
		g	Acceleration due to gravity

The process connection on the negative side is a female thread $1/4$ -18 NPT or an oval flange.

Lay the line for the negative pressure using a seamless steel tube 12 mm x 1.5 mm.

4.5 "Remote seal" installation

4.5.1 Remote seal installation

General installation instructions

- Keep the measuring system in the factory packing until it is installed in order to protect it from mechanical damage.
- When removing from the factory packing and installing: ensure that damage to and mechanical deformations in the membrane are prevented.

4.5 "Remote seal" installation

- Never loosen the sealed filling screws on the remote seal and the measuring instrument.
- Do not cause damage to the remote separating membrane; scratches on the remote separating membrane, e.g. due to sharp-edged objects, are the main starting points for corrosion.
- Select suitable gaskets for sealing.
- Use a gasket having an adequately large inner diameter for flanging. Insert the gasket concentrically; contact with the membrane leads to deviations in measurements.
- When using gaskets made of soft materials or PTFE: follow the guidelines of the gasket manufacturer, especially regarding the tightening torque and setting cycles.
- At the time of installation, use suitable fastening components such as screws and nuts that are compliant with fitting and flange standards.
- Excessive tightening of screwed joints on the process connection may displace the zero point on the pressure transmitter.

Note

Commissioning

If a shut-off valve exists, open the shut-off valve slowly when commissioning in order to avoid pressure surges.

Note

Permissible ambient and operating temperatures

Install the pressure measuring device such that the permissible limits of ambient and measured medium temperatures are not overshoot or undershot even with the consideration of the effect of convection and heat radiation.

- Note the effect of temperature on the measuring accuracy.
 - When selecting the remote seals, ensure that fittings and flange components have adequate pressure-temperature resistance by selecting suitable materials and pressure ratings. The pressure rating specified on the remote seal applies to reference conditions according to IEC 60770.
 - For the maximum permissible pressure at higher temperatures, please refer to the standard specified on the remote seal.
-

Using remote seals with pressure measuring device for hazardous areas:

- When using remote seals with pressure measuring device for hazardous areas, the permissible limits of ambient temperatures for the transmitter must not be exceeded. Hot surfaces on the cooling section (capillaries or cooling elements) are a possible source of ignition. Initiate suitable measures.
- When remote seals with a flame arrestor are used, the pressure measuring instrument determines the permissible ambient temperature. In the case of potentially explosive gaseous atmosphere, the temperature around the flame arrestor must not exceed +60 °C.

4.5.2 Installation of the remote seal with the capillary line

Notes

- Do not rest the measurement assembly on the capillary line.
- Do not bend capillary lines; risk of leakages and/or risk of considerable increase in the setting time of the measuring system.
- Owing to the risk of bending and breakages, pay attention to mechanical overloads at the joints such as capillary line-remote seal and capillary line-measuring device.
- Unwinding the excess capillary lines with a radius of at least 150 mm.
- Fasten the capillary line such that there are no vibrations.
- Permissible height differences:
 - When installing the pressure measuring device above the measuring point, keep the following in mind: the height difference of H_{1max} . for remote seal measuring systems with silicone, glycerin or paraffin oil filling. = 7 m must not be exceeded.
 - If halocarbon oil is used as the filling liquid, this maximum height difference is only $H_{1max} = 4$ m, see installation types A and B.

If negative overpressure is observed during measurements, reduce the permissible height difference accordingly.

Installation type for gauge pressure and level measurements (open containers)

Installation type A

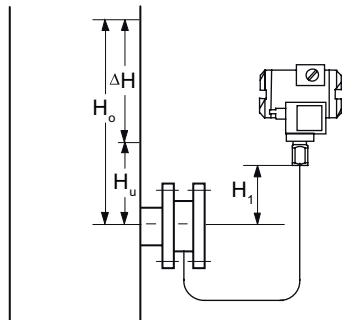

Pressure transmitter above the measuring point

Installation type B

Start of scale value:

$$\rho_{MA} = \rho_{FL} * g * H_u + \rho_{oil} * g * H_1$$

Full-scale value:

$$\rho_{ME} = \rho_{FL} * g * H_o + \rho_{oil} * g * H_1$$

4.5 "Remote seal" installation

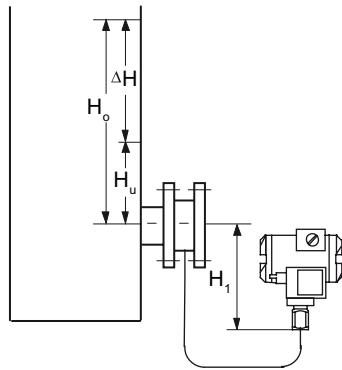

Start of scale value:
 $p_{MA} = \rho_{FL} * g * H_U - \rho_{oil} * g * H_1$
 Full-scale value:
 $p_{ME} = \rho_{FL} * g * H_O - \rho_{oil} * g * H_1$

Pressure transmitter below the measuring point

$H_1 \leq 7 \text{ m (23 ft)}$; with halocarbon oil as the filling liquid, only $H_1 \leq 4 \text{ m (13.1 ft)}$

Key

- p_{MA} Start of scale value
- p_{ME} Full-scale value
- ρ_{FL} Density of the process medium in the container
- ρ_{oil} Density of the filling oil in the capillary line of the remote seal
- g Acceleration due to gravity
- H_U Lower filling level
- H_O Upper filling level
- H_1 Distance between the container flange and the pressure transmitter

For absolute pressure measurements (vacuum), install the measuring device at least at the height of the remote seal or below it (see installation types C).

Installation types for absolute pressure measurements (closed containers)

Installation type C₁

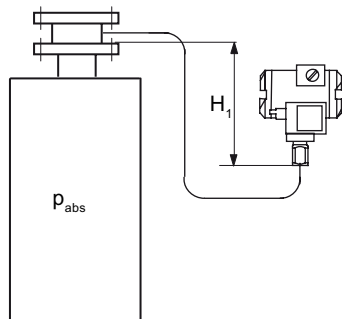

Start of scale value:
 $p_{MA} = p_{start} + \rho_{oil} * g * H_1$
 Full-scale value:
 $p_{ME} = p_{end} + \rho_{oil} * g * H_1$

Installation type C₂

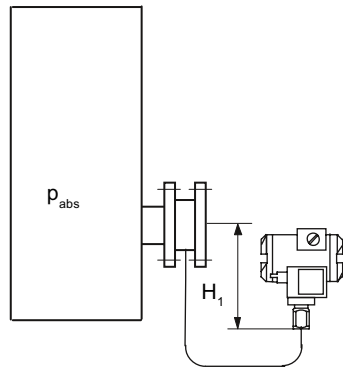

Pressure transmitter for absolute pressure always below the measuring point: $H_1 \geq 200$ mm (7.9 inch)

Key

p_{MA}	Start of scale value
p_{ME}	Full-scale value
p_{start}	Start of scale pressure
p_{end}	Full scale pressure
ρ_{oil}	Density of the filling oil in the capillary line of the remote seal
g	Acceleration due to gravity
H_1	Distance between the container flange and the pressure transmitter

Note

Effects of temperature

Keep the following instructions in mind in order to minimize keep the effects of temperature in remote seal measuring systems with the differential pressure measuring device:

Install the device such that the positive and negative sides are symmetrical as far as ambient effects, especially ambient temperatures, are concerned.

Installation type for differential pressure and flow rate measurements

Installation type D

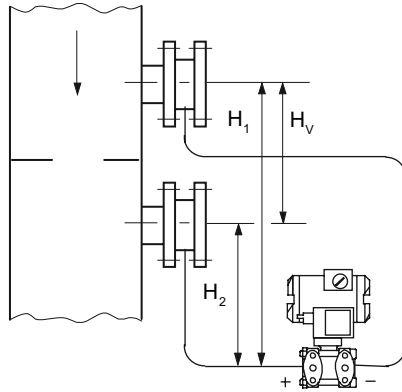

Start of scale value:
 $p_{MA} = p_{start} - \rho_{oil} * g * H_V$
 Full-scale value:
 $p_{ME} = p_{end} - \rho_{oil} * g * H_V$

Key

p_{MA}	Start of scale value
p_{ME}	Full-scale value
p_{start}	Start of scale pressure
p_{end}	Full scale pressure
ρ_{oil}	Density of the filling oil in the capillary line of the remote seal
g	Acceleration due to gravity
H_V	Gland distance

Installation types for level measurements (closed containers)

Installation type E

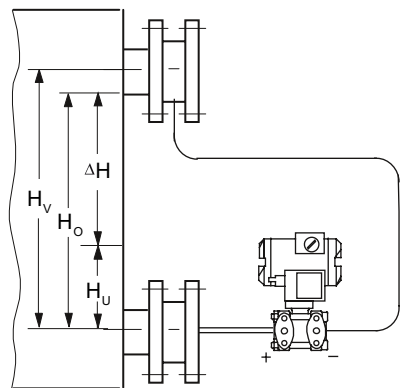

Start of scale value:
 $p_{MA} = \rho_{FL} * g * H_U - \rho_{oil} * g * H_V$
 Full-scale value:
 $p_{ME} = \rho_{FL} * g * H_O - \rho_{oil} * g * H_V$

Key

ρ_{MA}	Start of scale value
ρ_{ME}	Full-scale value
ρ_{FL}	Density of the process medium in the container
ρ_{oil}	Density of the filling oil in the capillary line of the remote seal
g	Acceleration due to gravity
H_U	Lower filling level
H_O	Upper filling level
H_V	Gland distance

Installation type G

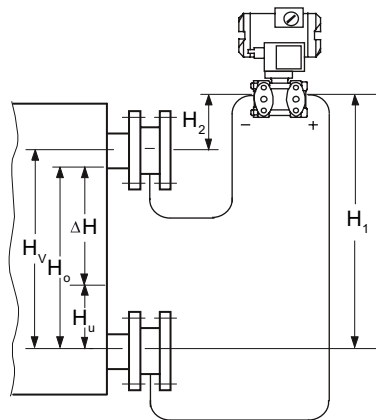

$H_1 \leq 7$ m (23 ft), for halocarbon oil, however only $H_1 \leq 4$ m (13.1 ft)

Start of scale value:

$$\rho_{MA} = \rho_{FL} * g * H_U - \rho_{oil} * g * H_V$$

Full-scale value:

$$\rho_{ME} = \rho_{FL} * g * H_O - \rho_{oil} * g * H_V$$

Pressure transmitter for differential pressure above the upper measuring point, no vacuum

Installation type H

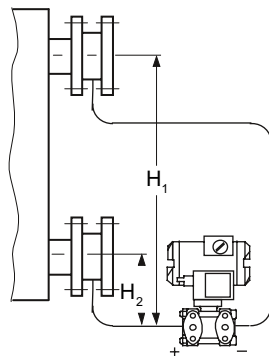

Start of scale value:

$$\rho_{MA} = \rho_{FL} * g * H_U - \rho_{oil} * g * H_V$$

Full-scale value:

$$\rho_{ME} = \rho_{FL} * g * H_O - \rho_{oil} * g * H_V$$

Below the lower measuring point

4.6 Turing the measuring cell against housing

Installation type J

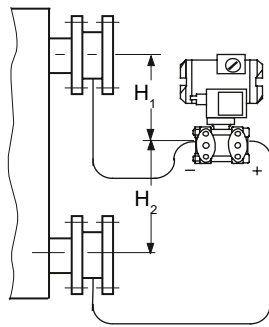

$H_2 \leq 7 \text{ m (23 ft)}$; with halocarbon oil as the filling liquid, only $H_2 \leq 4 \text{ m (13.1 ft)}$

Start of scale value:

$$p_{MA} = \rho_{FL} * g * H_U - \rho_{oil} * g * H_V$$

Full-scale value:

$$p_{ME} = \rho_{FL} * g * H_O - \rho_{oil} * g * H_V$$

Between the measuring points, no vacuum

Key

p_{MA}	Start of scale value
p_{ME}	Full-scale value
ρ_{FL}	Density of the process medium in the container
ρ_{oil}	Density of the filling oil in the capillary line of the remote seal
g	Acceleration due to gravity
H_U	Lower filling level
H_O	Upper filling level
H_V	Gland distance

4.6 Turing the measuring cell against housing

Description

You can turn the measuring cell against the housing. Turning simplifies the transmitter operation in the case of an angled installation environment. The buttons and the current connection can thus also be operated for an external measuring device. The display also remains visible in enclosure covers with an inspection window.

Only limited turning is permissible! The turning range ① is marked at the foot of the electronic housing. An orientation mark ③ is provided at the throat of the measuring cell. This mark must remain in the marked section when turning.

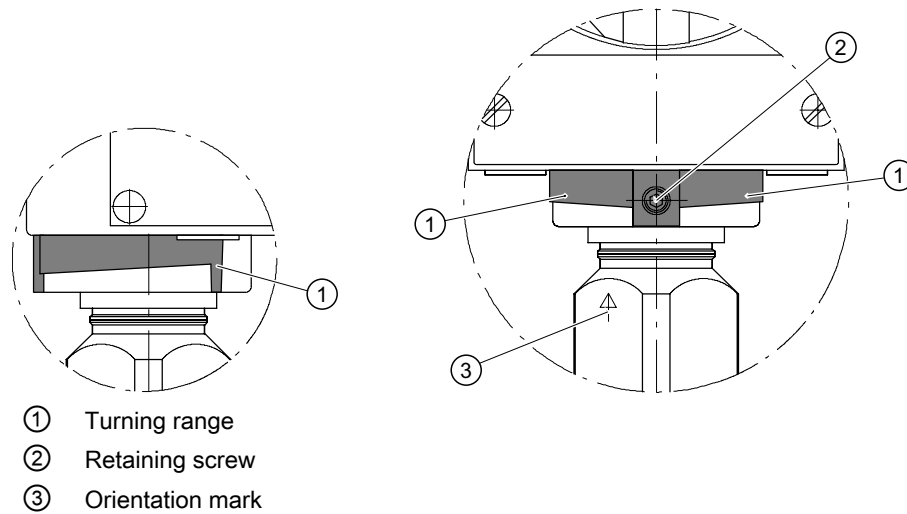

Figure 4-4 Example: turning range of transmitters for pressure and absolute pressure from the gauge pressure series

The turning range for transmitters for differential pressure and flow rate, absolute pressure from the differential pressure series and level is identified in a similar manner.

Procedure

NOTICE

Follow the turning range, otherwise electrical connections of the measuring cell may get damaged.

1. Loosen the retaining screw ② (Allen screw 2.5 mm).
2. Turn the electronic housing against the measuring cell. Follow the marked turning range ① while doing so.
3. Tighten the retaining screw (torque: 3.4 to 3.6 Nm).

4.7 Rotating the display

You can rotate the display in the electronics enclosure. This makes it easier to read the display if the device is not being operated in a vertical position.

Procedure

1. Unscrew the cover of the electrical cable compartment. See section Structure (Page 19). An identification text "FIELD TERMINAL" is provided at the side of the housing.
2. Unscrew the display. Depending on the application position of the transmitter, you can reinstall it at four different positions. You can turn it by $\pm 90^\circ$ or $\pm 180^\circ$.

4.7 Rotating the display

3. Screw the covers back on as far as they will go.
4. Secure the covers with the cover catch.

Connecting

5.1 Basic safety instructions

5.1.1 Unsuitable cables and/or cable glands

 WARNING
Unsuitable cables and/or cable glands
Danger of explosion in hazardous areas.
<ul style="list-style-type: none">• Only use suitable cables and cable glands complying with the requirements specified in Chapter "Technical data (Page 169)".• Tighten the cable glands in accordance with the torques specified in Chapter "Technical data (Page 169)".• When replacing cable glands use only cable glands of the same type.• After installation check that the cables are seated firmly.

 WARNING
Hazardous contact voltage in versions with 4-conductor extension
Danger of electrocution in case of incorrect connection.
<ul style="list-style-type: none">• For the electrical connection, refer to the information in Chapter "Technical data (Page 169)".

 WARNING
Improper power supply
Danger of explosion in hazardous areas as result of incorrect power supply, e.g. using direct current instead of alternating current.
<ul style="list-style-type: none">• Connect the device in accordance with the specified power supply and signal circuits. The relevant specifications can be found in the certificates, in Chapter "Technical data (Page 169)" or on the nameplate.

 WARNING
Unsafe extra-low voltage Danger of explosion in hazardous areas due to voltage flashover. <ul style="list-style-type: none">• Connect the device to an extra-low voltage with safe isolation (SELV).

 WARNING
Lack of equipotential bonding Danger of explosion through compensating currents or ignition currents through lack of equipotential bonding. <ul style="list-style-type: none">• Ensure that the device is potentially equalized. Exception: It may be permissible to omit connection of the equipotential bonding for devices with type of protection "Intrinsic safety Ex i".

 WARNING
Unprotected cable ends Danger of explosion through unprotected cable ends in hazardous areas. <ul style="list-style-type: none">• Protect unused cable ends in accordance with IEC/EN 60079-14.

 WARNING
Improper laying of shielded cables Danger of explosion through compensating currents between hazardous area and the non-hazardous area. <ul style="list-style-type: none">• Only ground shielded cables that run into the hazardous area at one end.• If grounding is required at both ends, use an equipotential bonding conductor.

 WARNING
Connecting device in energized state Danger of explosion in hazardous areas. <ul style="list-style-type: none">• Connect devices in hazardous areas only in a de-energized state. Exceptions: <ul style="list-style-type: none">• Circuits of limited energy may also be connected in the energized state in hazardous areas.• Exceptions for type of protection "Non-sparking nA" (Zone 2) are regulated in the relevant certificate

 WARNING
Incorrect selection of type of protection Danger of explosion in areas subject to explosion hazard. This device is approved for several types of protection. <ol style="list-style-type: none">1. Decide in favor of one type of protection.2. Connect the device in accordance with the selected type of protection.3. In order to avoid incorrect use at a later point, make the types of protection that are not used permanently unrecognizable on the nameplate.

NOTICE
Ambient temperature too high Damage to cable sheath. <ul style="list-style-type: none">• At an ambient temperature ≥ 60 °C (140 °F), use heat-resistant cables suitable for an ambient temperature at least 20 °C (68 °F) higher.

NOTICE
Incorrect measured values with incorrect grounding The device must not be grounded via the "+" connection. It may otherwise malfunction and be permanently damaged. <ul style="list-style-type: none">• If necessary, ground the device using the "-" connection.

Note

Electromagnetic compatibility (EMC)

You can use this device in industrial environments, households and small businesses.

For metal housings there is an increased electromagnetic compatibility compared to high-frequency radiation. This protection can be increased by grounding the housing, see Chapter "Connecting the device (Page 60)".

Note

Improvement of interference immunity

- Lay signal cables separate from cables with voltages > 60 V.
 - Use cables with twisted wires.
 - Keep device and cables in distance to strong electromagnetic fields.
 - Use shielded cables to guarantee the full specification according to HART.
 - Refer to HART communication information in Chapter "Technical data (Page 169)".
-

5.2 Connecting the device

Opening the device

1. Unscrew the cover of the electrical cable compartment. An identification text "FIELD TERMINAL" is provided at the side of the housing.

Connecting the device

1. Lead the connecting cable through the cable gland ③.
2. Connect the device to the plant with the protective conductor connection ⑦.

3. Connect the wires to the terminals "+" and "-". ④
Observe the correct polarity. If necessary, ground the device using the "-" connection by connecting the "-" connection to the ground terminal ⑨.
4. If necessary, connect the shield to the screw of the ground terminal ⑨. The ground terminal is electrically connected to the external protective conductor connection.

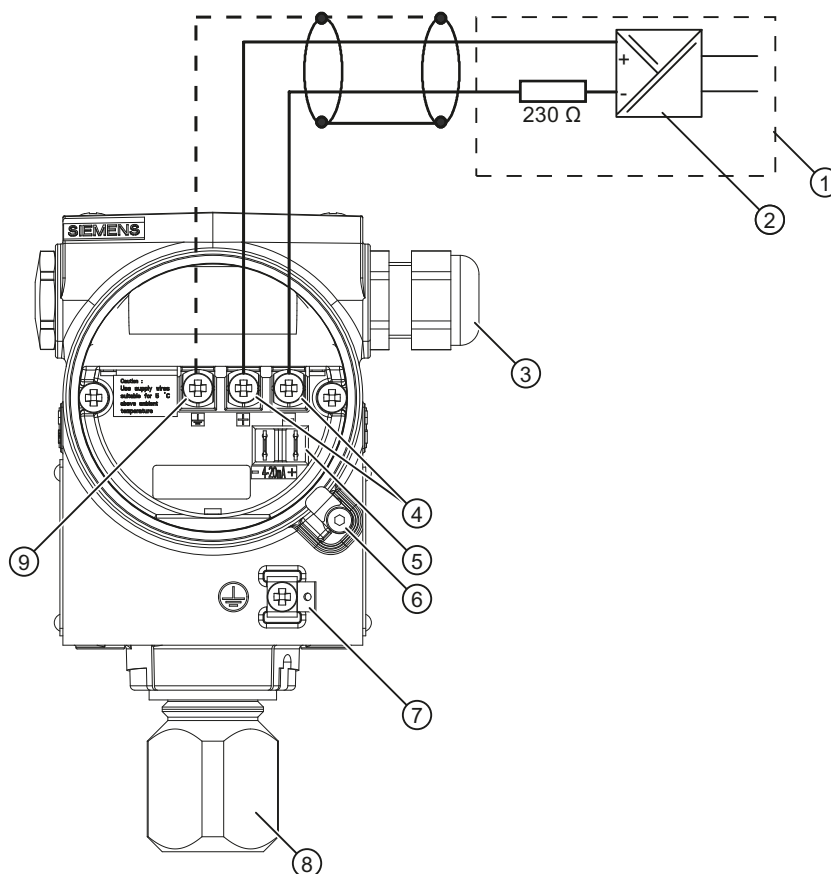

- | | |
|---|---|
| ① Feed separator with integrated load | ⑤ Test connector for direct current measuring device or connection for external display |
| ② Auxiliary power | ⑥ Safety catch |
| ③ Cable entry for auxiliary power/analog output | ⑦ Protective conductor connection/ equipotential bonding terminal |
| ④ Connecting terminals | ⑧ Process connection |
| | ⑨ Ground terminal |

Figure 5-1 Electrical connection, power supply

Closing the device

1. Screw the covers ④ ⑦ back on as far as they will go.
2. Secure each cover with the cover catch ③ ⑥.

5.3 Connecting the Han plug

3. Close the key cover ①.
4. Tighten the screws in the key cover.
5. Check the tightness of the blanking plugs ⑤ and cable gland ② in accordance with the degree of protection.

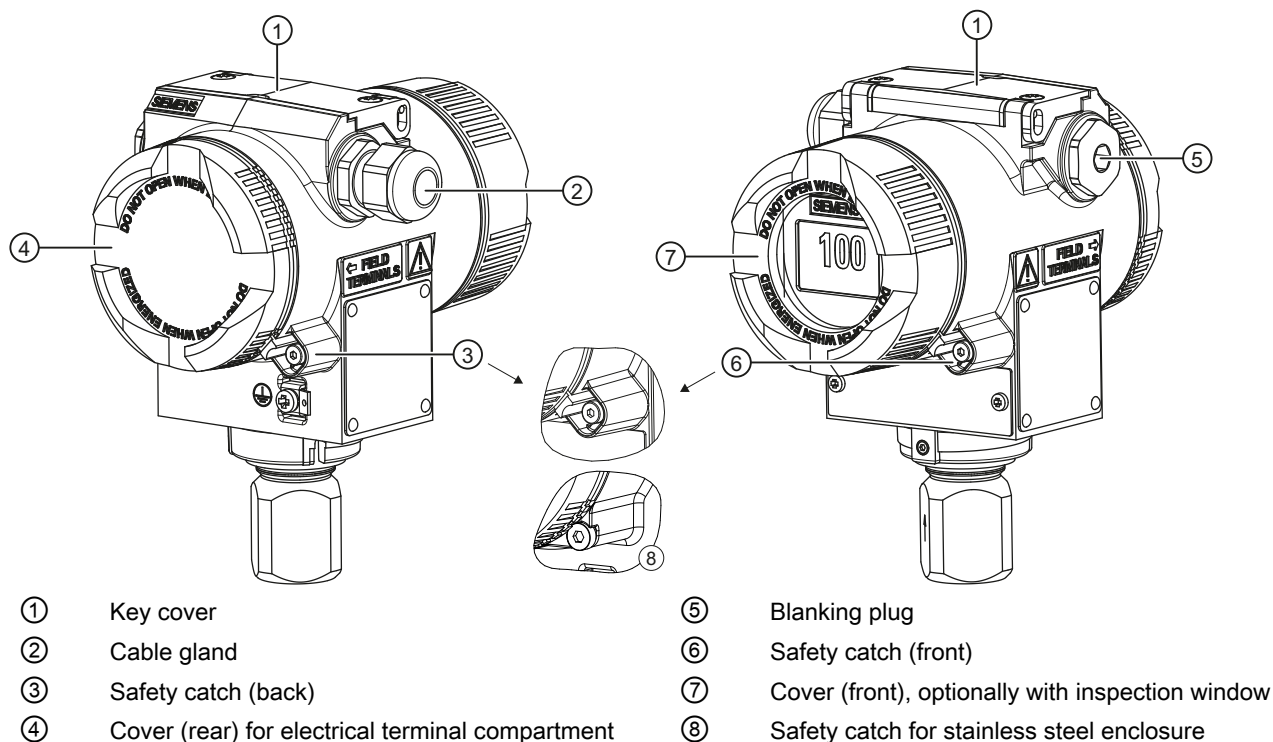

Figure 5-2 View of the transmitter: Left: Back right: Front view

See also

Structure (Page 19)

5.3 Connecting the Han plug

⚠ WARNING

The connector may only be used for Ex ia devices and non-Ex devices; otherwise the safety required for the approval is not guaranteed.

Note

Observe the protection class of the Han plug when defining the protection class.

The contact parts for the coupling socket are also supplied.

Procedure

1. Slide the sleeve and the screwed joint on the cable.
2. Strip approx. 8 mm of the cable ends.
3. Crimp the contact parts on the cable ends.
4. Assemble the coupling socket.

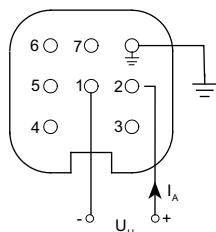

I_A Output current
 U_H Auxiliary power

Connector pin assignment with Han 7D or Han 8D plug

5.4 Connecting the M12 connector**Procedure****CAUTION**

A conductive connection must not exist between the shield and the connector housing.

WARNING

The connector may only be used for Ex ia devices and non-Ex devices; otherwise the safety required for the approval is not guaranteed.

Note

Observe the protection class of the M12 connector when defining the protection class.

For devices in which a connector is already available on the housing, the connection is established using a cable jack.

1. Thread the parts of the cable jack as described by the connector manufacturer.
2. Strip approximately 18 mm of the bus cable ①.
3. Twist the shield.
4. Thread the shield in the insulating sleeve.
5. Draw 8 mm of shrink sleeve over the cable, wires and shield up to the reference edge ②.

6. Screw the cable ends and the shield in the pin insert.
7. Fix the parts of the cable jack as described by the connector manufacturer.

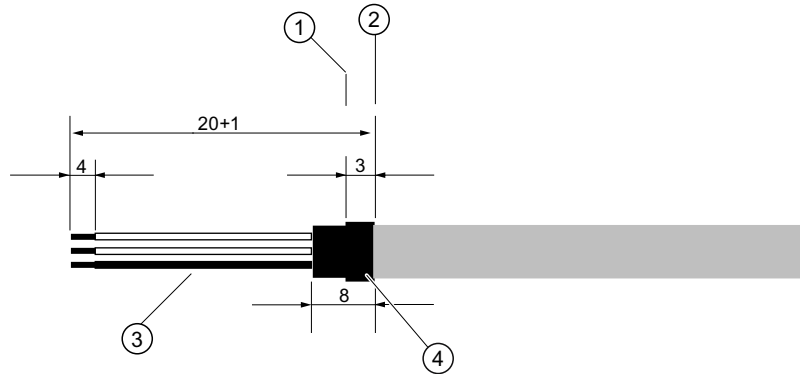
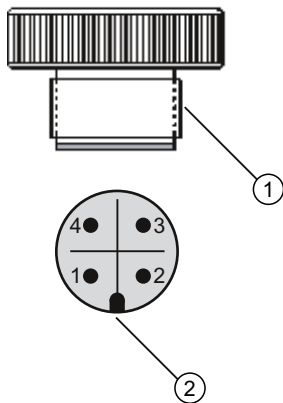

Figure 5-3 Preparing the connecting cable

- | | |
|--|-------------------------------------|
| ① Reference edge for stripping | ③ Insulating sleeve over the shield |
| ② Reference edge for the dimension specifications for cable assembly | ④ Shrink sleeve |

Pin assignment



Layout for M12 connector

- | | |
|---|-------------------|
| ① | M12 x 1 thread |
| ② | Positioning catch |
| 1 | + |
| 2 | Not connected |
| 3 | - |
| 4 | Shield |

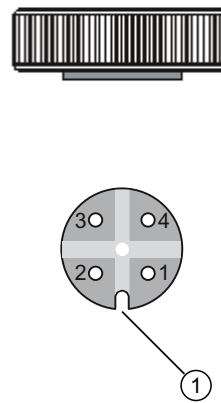

Layout for M12 jack

- | | |
|---|-----------------------------------|
| ① | Positioning slot |
| 1 | + |
| 2 | Not connected |
| 3 | - |
| 4 | Shield |
| | Middle jack contact not connected |

Operation

6.1 Overview of operation

Introduction

The following description contains an overview of the operating functions that you can execute using the pressure transmitter, and the safety notes that are to be observed when doing so. You can operate the transmitter on-site through HART communication. First, the on-site operation and then, the operating functions using HART are described.

Contents of the chapter

- Basic safety instructions (Page 66)
- Instructions for operation (Page 66)
- Display (Page 67)
- Local operation (Page 72)

Overview of operating functions

You can configure basic settings of the pressure transmitter using the buttons on the device. You can configure all settings through HART communication.

The following table describes the basic operating functions. More operating functions for special applications are accessible through HART. **Basic variables** of the device are marked in bold.

Table 6-1 Operating functions

Function	Using buttons	Using HART
Start of scale value	Yes	Yes
Full scale value	Yes	Yes
Electrical damping	Yes	Yes
Blind adjustment of the start of scale value	Yes	Yes
Blind adjustment of the full scale value	Yes	Yes
Zero point calibration (position correction)	Yes	Yes
Current transmitter	Yes	Yes
Fault current	Yes	Yes
Keyboard lock and write protection	Yes	Yes, release except for write protection
Unit type, unit	Yes	Yes

Function	Using buttons	Using HART
Characteristic curve (lin., rad.) (Not relevant for absolute and gauge pressure)	Yes	Yes
Customized characteristic curve	No	Yes
Diagnostic function	No	Yes

More operating functions for special applications are accessible through HART.

If a device does not have a display, its operations are limited. This is however not applicable for selecting functions using HART.

6.2 Basic safety instructions

Note

Incorrect reproduction of the process pressure

If you have changed the basic functions of the pressure transmitter, the display and the measurement output could be set such that the actual process pressure is not reproduced.

Therefore, check the basic parameters before commissioning.

6.3 Instructions for operation

The following rules are applicable for the operation of the pressure transmitter:

- The device counts numerical values always in an ascending order step by step starting from the least significant digit displayed.
If you keep the button pressed for a longer time, it counts the next higher digit displayed. This procedure is used for fast coarse adjustment over a wide number range. Release the [↑] or [↓] button again for fine adjustment. Press the button again.

Violations of the measured value limits are output on the display by ↑ or ↓.

- The keyboard must have been unlocked in order to operate the device using the keyboard.
- If you are operating the transmitter locally, write access is denied through HART during this time.
However, it is always possible to read the data, e.g. measured values.

Note

The setting is saved and the measured values are automatically displayed again if more than two minutes have passed after a button was pressed for the last time.

The operating instructions in the "Local operation without display" section apply if the device has been delivered with a blind cover.

6.4 Display

6.4.1 Display elements

Structure

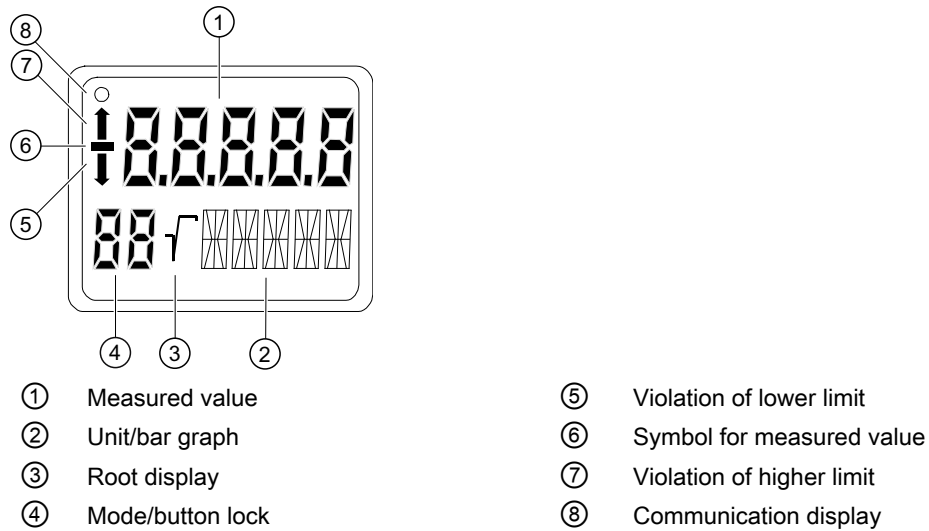

Figure 6-1 Display layout

Description

The display is used for the local display of the measured value ① with:

- Unit ②
- Mode ④
- Sign ⑥
- Statuses ⑤ and ⑦

Depending on the customer setting, the displayed measured value ① represents the following:

- The current emitted by the transmitter
- The percentage measurement value of the adjusted measurement type, e.g. level, related to the adjusted measurement range.
- The measurement value in a selectable physical unit

The *Violation of lower limit* ⑤ and *Violation of upper limit* ⑦ displays are also referred to as status since they have meanings dependent on the settings.

If the communication display ⑧ blinks, this indicates an active communication.

6.4.2 Units display

Description

The unit display comprises five 14-segment fields for representing the unit as a percentage value, physical unit or current value. A bar graph showing the percentage measured value range from 0 to 100% can be displayed as an alternative to the unit. The bar graph function is disabled by default.

Display

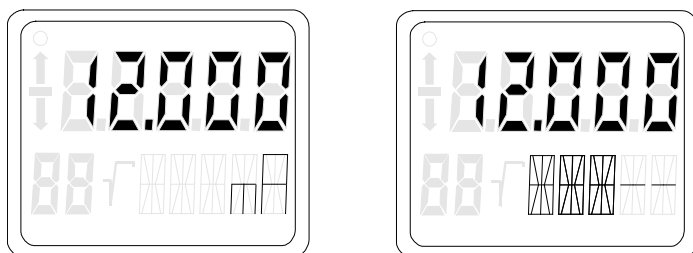

Figure 6-2 Examples for measured value display for current and bar graph

The following messages may appear as a ticker in the bottom line of the display. They have no influence on the current output.

Table 6-2 Message as ticker

Ticker	Meaning
"DIAGNOSTIC WARNING"	Is always displayed if: <ul style="list-style-type: none"> • An event configured by the user is to be signaled with a warning. For example: <ul style="list-style-type: none"> – Limit reached – Event counter for limit values exceeded – Calibration time expired – Current saturation reached • The status of one of the device variables is "UNCERTAIN".
"SIMULATION"	Is always displayed when the simulation of a pressure value or temperature value is active.

See also

Measured value status (Page 110)

6.4.3 Error display

Description

If hardware faults, software errors or diagnostic alarms occur in the transmitter, the message "Error" appears in the measured value display.

A ticker appears in the bottom line of the display indicating the type of error. This diagnostic information is also available via HART communication.

Display

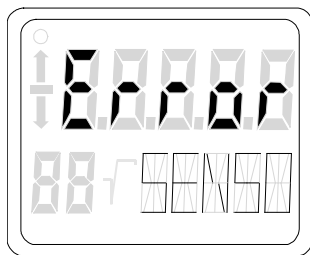

Figure 6-3 Example of error message

The following messages may appear as a ticker in the bottom line of the display.

Ticker	Meaning
"HARDWARE FIRMWARE ALARM"	Contains hardware faults such as: <ul style="list-style-type: none"> • incorrect checksum • incorrect EEPROM data • Defective EEROM • RAM fault • ROM fault • inconsistent data • EEPROMs not initialized
"DIAGNOSTIC ALARM"	Is always displayed if <ul style="list-style-type: none"> • an event configured by the user is to be signaled with an alarm. For example: <ul style="list-style-type: none"> – Limit reached – Event counter for limit values exceeded – Calibration time expired – Current saturation reached • the status of one of the device variables is "BAD".
"SENSOR BREAK"	Appears when there is a sensor break.

See also

Measured value status (Page 110)

6.4.4 Mode display

Description

The selected active mode is shown in the mode display.

Display

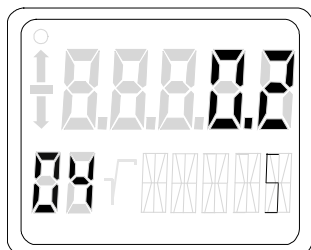

Figure 6-4 Example for mode display

In the example, a damping of 0.2 seconds was set in mode 4.

6.4.5 Status display

Description

The arrows of the status display have a different meaning depending on the mode setting. The table below shows the meanings of the arrows in the respective functions.

Meaning

Table 6-3 Meaning of the arrow displays

Function	Mode	Display ↑	Display ↓
Adjusting start of scale value	2	if the upper current limit is exceeded	if the value falls below the lower current limit
Adjusting full scale value	3	if the upper current limit is exceeded	if the value falls below the lower current limit
Adjusting damping	4	if the upper damping value is exceeded only for the pressure device version	if the value falls below the lower damping value only for the pressure device version
Blind adjustment of the start of scale value	5	if the upper sensor limit is exceeded	if the value falls below the lower sensor limit
Blind adjustment of the full scale value	6	if the upper sensor limit is exceeded	if the value falls below the lower sensor limit

Function	Mode	Display ↑	Display ↓
Position correction	7	if the max span is exceeded by more than 5% of the upper current limit	if the value falls below the lower current limit
Root application point	12	if the root application point of 15% is exceeded	if the value falls below the root application point of 5%
Keyboard operation	2, 3, 5, 6	when the span to be adjusted is larger than the maximum span	when the span to be adjusted is smaller than the minimum span
Normal operation		Current exceeds the upper saturation limit Pressure exceeds the upper sensor limit.	Current falls below the lower saturation limit Pressure falls below the lower sensor limit.

6.4.6 Overflow range

Description

The output signal is divided into defined ranges:

- Measuring range
- Saturation limits
- Fault current

The transmitter emits the output current according to the device variables selected as primary variable (PV). The working range of the current lies between 4 mA and 20 mA.

Meaning

When the measurement limits are exceeded or not reached, the measured values are correctly displayed in the overflow range.

A ticker is displayed in the bottom line of the display showing alternately the message UNDER or OVER and the selected unit. The possible overflow range can be adjusted via HART communication. If either of the overflow limits are violated, the output current remain constant. Violations of the measured value limits are output on the display by ↑ or ↓.

Note

The setting of the overflow range and the fault current range can be freely selected via HART communication.

Reference

NAMUR recommendation NE43 dated 03.02.2003

"Standardization of the signal level for the breakdown information of digital transmitters"

See also

Fault current (Page 118)

Setting the current limits (Page 119)

6.5 Local operation

6.5.1 Local control elements

Introduction

The transmitter can be operated on-site using the keys. Selectable modes can be used to choose and execute the functions described in the table. The number of available functions is limited if the device does not have a display.

Control elements

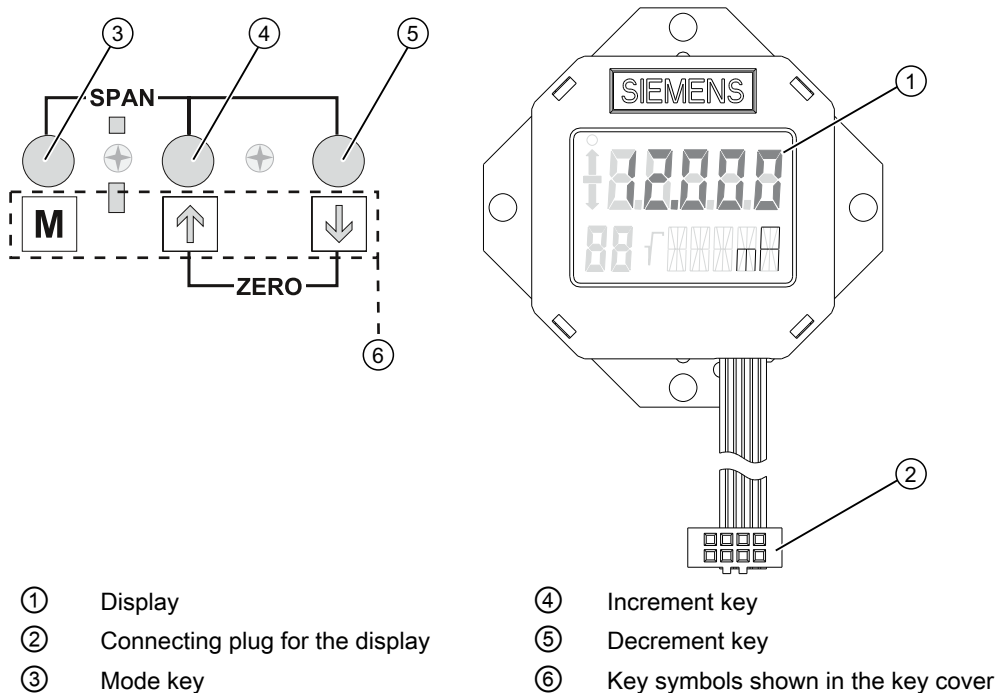

Figure 6-5 Position of keys and display

Operating functions

Note

Zero point calibration

For absolute pressure transmitters, the start of scale value is at vacuum.

A zero point calibration with transmitters which do not measure absolute pressure leads to faulty settings.

Table 6-4 Operating functions using keys

Function	Mode	Key function			Display, explanations
	[M]	[↑]	[↓]	[↑] and [↓]	
Measured value	The modes are selected here.				The current measured value is displayed as you have adjusted it in the "Measured value display, mode 13" function.
Start of scale value (only in "Pressure" measuring mode)	2	Current higher	Current lower	Set to 4 mA	Output current in mA
Full scale value (only in "Pressure" measuring mode)	3	Current higher	Current lower	Set to 20 mA	Output current in mA
Electrical damping	4	Damping higher	Damping lower	Set to 0	Time constant T63 in seconds Adjustment range: 0.0 s to 100.0 s
Start of scale value in the so-called blind adjustment	5	Pressure higher	Pressure lower	Set the start of scale value to 0	Start of scale value in the selected pressure unit
Full scale value in the so-called blind adjustment	6	Pressure higher	Pressure lower	Set the full scale value to upper measuring limit	Full scale value in the selected pressure unit
Zero point calibration (position correction)	7	Correction value higher	Correction value lower	execute	Ventilate the transmitter for gauge pressure, differential pressure, flow rate or level. Evacuate the transmitter for absolute pressure (< 0.1% of the measuring span). (Start of scale value remains unaffected) Measured value in pressure unit
Current transmitter	8	Current higher	Current lower	switch on	constant output current in mA "3.6"; "4", "12", "20" or "22.8" Switch off using the [M] key.
Output current in case of fault	9	Switch between lower fault current and upper fault current.		lower fault current	selected output current possible: Fault current limits adjusted by user

6.5 Local operation

Function	Mode	Key function			Display, explanations	
	[M]	[↑]	[↓]	[↑] and [↓]		
Key lock or function lock	10	Switch between the five functions		–	0	None
					LA	all locked
					LO	all locked except for start of scale value
					LS	all locked except for start of scale value and full scale value
					L	Write protection Operation via HART not possible.
Characteristic curve ¹⁾	11	Switch between the four functions		linear	lin	linear
					srlin	square root extracting (linear up to the application point)
					sroff	Square root extracting (deactivated up to the application point)
					sri2	square root extracting (linear up to the application point 10%)
Application point of the square root extracting characteristic curve ¹⁾	12	Greater	Smaller	10% flow rate	Adjustment range of 5 to 15% flow rate.	
Measured value display	13	Select from three options.		–	<ul style="list-style-type: none"> • Display type (input value) • Output current in mA • Measured value in % 	
Unit	14	Select from the table for measured value display.		In each case, the first value from the table of the physical unit	Physical unit	

¹⁾ Not relevant for gauge and absolute pressure)

See also

Overview of operation (Page 65)

Operating functions through HART communication (Page 99)

6.5.2 Operation using buttons

Introduction

This overview informs you about the most important safety notes to be observed when operating the pressure transmitter. Furthermore, the overview guides you in adjusting the operating functions on site.

Condition

The keyboard must have been unlocked in order to operate the device using the buttons.

Procedure

In the default setting, the device is in the measured value display.

To adjust the operating functions, proceed as follows:

1. Loosen both the screws of the keyboard cover and lift it upwards.
2. Keep pressing the [M] button until the desired mode is displayed.
3. Keep pressing the [\uparrow] or [\downarrow] button until the desired value is displayed.
4. Press the [M] button.
Now you have saved the values and the device goes to the next mode.
5. Close the keyboard cover using the two screws.

Note

The setting is saved and the measured values are automatically displayed again if more than two minutes have passed after a button was pressed for the last time.

See also

Releasing key lock or function lock (Page 91)

6.5.3 Start of scale value/full scale value

6.5.3.1 Difference between setting and adjusting

Introduction

In "Pressure" measuring mode, you can set or adjust the start of scale value and full scale value using the buttons. Modes 2 and 3 are used for this. Rising and falling characteristic curves can be realized with appropriate use of the buttons. If the transmitter is not in "Pressure" measuring mode, this mode is skipped in local operation.

Difference

The difference between setting and adjusting lies in the calculation.

Setting with reference pressure

Condition

Two reference pressures p_{r1} and p_{r2} are available. The reference pressures are initialized by the process or generated by a pressure sensor.

When setting, a desired start of scale value or a full scale value is allocated to the standard current values (4 mA or 20 mA). After setting, the span given on the nameplate may no longer correspond to the setting.

6.5 Local operation

Depending on the series and measuring range, a maximum downscaling of 1:100 can be achieved (measuring span ratio = r, turn down).

The correlation between the measured pressure and the output current generated is linear. The square root extracting characteristic curve for differential pressure transmitters is an exception. Calculate the output current using the following formula.

$$I = \frac{p - MA}{ME - MA} * 16 \text{ mA} + 4 \text{ mA}$$

I	Output current	MA _{actual}	Old start of scale value
p	Pressure	ME _{actual}	Old full scale value
MA	Start of scale value	MA _{target}	New start of scale value
ME	Full scale value	ME _{target}	New full scale value

Figure 6-6 Current calculation formula for setting

Example of setting with reference pressure

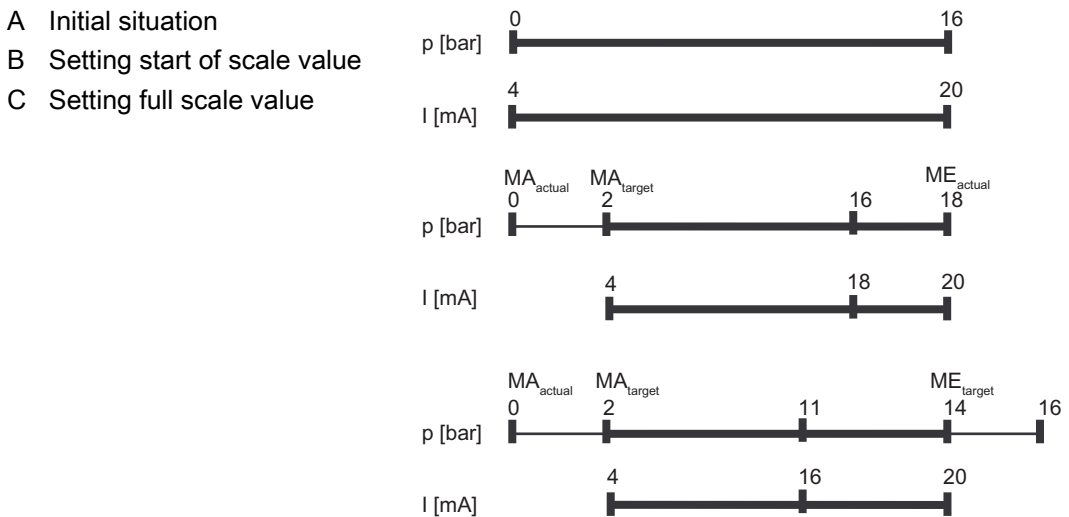

Explanations for the example of setting with reference pressure

- A The measuring range is from 0 to 16 bar. You are changing the start of scale value from 0 to 2 bar and the full scale value from 16 to 14 bar. The measuring span is then 12 bar.
- B 2 bar process pressure is created.
Use the [M] button to set the transmitter to mode 2. To set the start of scale value, press the [↑] and [↓] buttons simultaneously for 2 seconds.
If there is 2 bar input pressure, the transmitter produces an output current of 4 mA.

- C 14 bar process pressure is created.
Use the [M] button to set the transmitter to mode 3. To set the full scale value, press the [↑] and [↓] buttons simultaneously for 2 seconds.
If there is 14 bar input pressure, the transmitter produces an output current of 20 mA.
- D The output current can be calculated for any input pressure using the "current calculation formula for setting".

Note

If the value exceeds or falls below the preset measuring limits by more than 20% when setting, the setting function is not carried out. The old value is retained in this case.

With a marked elevation of the zero point, the full scale value must therefore previously be reduced such that it still lies within the permitted range after elevation of the zero point. This setting function is only possible in "Pressure" measuring mode.

Adjusting with reference pressure

Condition:

The reference pressure, the adjusted start of scale value and adjusted full scale value are known.

When adjusting, a start of scale value or a full scale value can be allocated to a desired current value with the aid of a reference pressure. This function is particularly suitable when the required pressures for the start of scale value and the full scale value are not available. After adjustment, the measuring range specified on the nameplate may no longer correspond to the setting made.

Using the formulae below, the current to be set for the desired start of scale value and the full scale value can be calculated.

To calculate the output currents when setting the start of scale value or the full scale value, the reference pressure must be selected such that a value between 4 and 20 mA results for the current.

$$I = \frac{p - MA}{ME - MA} * 16 \text{ mA} + 4 \text{ mA}$$

$$I_{ME} = \frac{p_{ref} - MA_{target}}{ME_{target} - MA_{target}} * 16 \text{ mA} + 4 \text{ mA}$$

I	Output current	MA _{actual}	Old start of scale value
I _{MA}	Current to be adjusted with MA _{target}	ME _{actual}	Old full scale value
I _{ME}	Current to be adjusted with ME _{target}	MA _{target}	New start of scale value
p	Pressure	ME _{target}	New full scale value
p _{ref}	Existing reference pressure		

Figure 6-7 Current calculation formula for setting with reference pressure

Example of adjusting with reference pressure

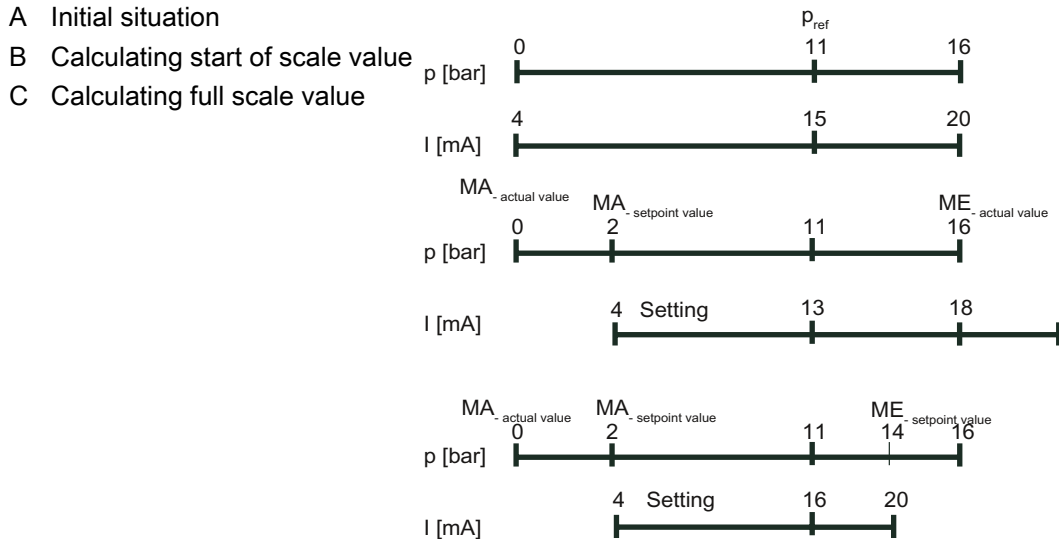

Explanations for the example of adjusting with reference pressure

- A The measuring range is from 0 to 16 bar. You are changing the start of scale value from 0 to 2 bar and the full scale value from 16 to 14 bar. The measuring span is then 12 bar. A reference pressure of 11 bar is created.
- B Use the [M] button to set the transmitter to mode 2.
 The "Current calculation formula for adjusting with reference pressure" can be used to calculate the current to be adjusted for the desired start of scale value I_{MA} (13 mA at 2 bar) with the existing reference pressure. It can be adjusted with the [↑] or [↓] buttons I_{MA} .
- C Use the [M] button to set the transmitter to mode 3.
 The "Current calculation formula for adjusting" can be used to calculate the current to be adjusted for the desired full scale value I_{ME} (16 mA at 14 bar) with the existing reference pressure. It can be adjusted with the [↑] or [↓] buttons I_M .

Note

If the preset measuring limits are exceeded or fallen below by more than 20% during adjustment, the resulting current cannot be set above these limits.

With a marked elevation of the zero point, the full scale value must therefore previously be reduced such that it still lies within the permitted range after elevation of the zero point.

See also

Unit (Page 95)

6.5.3.2 Setting/adjusting the start of scale value

NOTICE**Inadvertent adjustment of parameters on devices without display or without visible display**

Key lock is canceled if you press the [M] key for longer than 5 seconds, see chapter "Releasing key lock or function lock (Page 91)". In the case of a device without display or without a visible display, you could inadvertently change parameters.

- Always press the [M] key for less than 5 seconds.

Introduction

Set or adjust the start of scale value of the pressure transmitter in mode 2.

You can also adjust the start of scale value or the full scale value separately as well as adjust both these values one after the other.

Condition

You are familiar with the correct operation of the transmitter and the associated safety notes.

You have selected a reference pressure that corresponds to the start of scale value and is within the permissible tolerance range.

The transmitter is in "Pressure" measuring mode.

Setting start of scale value

To set the output current of the start of scale value to 4 mA, proceed as follows:

1. Create the reference pressure.
2. Set mode 2.
3. Set the start of scale value to 4 mA.
4. Save with the [M] button.

Adjusting start of scale value

If you do not set the output current but constantly adjust it, you need to calculate the currents to be adjusted mathematically.

To the adjust the output current of the start of scale value, proceed as follows:

1. Create the reference pressure.
2. Set mode 2.
3. Adjust the output current of the start of scale value to the calculated value.
4. Save with the [M] button.

Setting the start-of-scale value without a display

You have a device with a cover that does not have an inspection window and you wish to set the start of scale value.

To set the output current of the start of scale value to 4 mA, proceed as follows:

1. Create the reference pressure.
2. Press the [↑] and [↓] buttons simultaneously.
The device has set the start of scale value to 4 mA.
3. When you release the buttons, the device saves the adjusted value automatically.

Setting the start-of-scale value without a display

You have a device with a cover that does not have an inspection window and you do not wish to set the start of scale value, but adjust it.

You will need an ammeter for this purpose.

To adjust the output current of the start of scale value, proceed as follows:

1. Connect the ammeter to the test connector.
2. Create the reference pressure.
3. Adjust the output current of the start of scale value using the [↑] or [↓] button.
4. When you release the button, the device saves the adjusted value automatically.

6.5.3.3 Setting/adjusting the full scale value

Introduction

Set or adjust the full scale value of the pressure transmitter in mode 3.

You can also adjust the start of scale value or the full scale value separately as well as adjust both these values one after the other.

Condition

You are familiar with the correct operation of the transmitter and the associated safety notes.

You have selected a reference pressure that corresponds to the full scale value and is within the permissible tolerance range.

The transmitter is in "Pressure" measuring mode.

Setting full scale value

To set the output current of the full scale value to 20 mA, proceed as follows:

1. Create the reference pressure.
2. Set mode 3.

3. Set the full scale value to 20 mA.
4. Save with the [M] button.

Adjusting full scale value

If you do not set the output current but constantly adjust it, you need to calculate the currents to be adjusted mathematically.

To the adjust the output current of the full scale value, proceed as follows:

1. Create the reference pressure.
2. Set mode 3.
3. Adjust the output current of the full scale value to the calculated value.
4. Save with the [M] button.

Setting the full-scale value without a display

You have a device with a cover that does not have an inspection window and you wish to set the full scale value.

To set the output current of the full scale value to 20 mA, proceed as follows:

1. Create the reference pressure.
2. Press and hold the [M] button.
3. Also press the [\uparrow] and [\downarrow] buttons simultaneously.
The device has set the full scale value to 20 mA.
4. When you release the buttons, the device saves the adjusted value automatically.

Setting the full-scale value without a display

You have a device with a cover that does not have an inspection window and you do not wish to set the full scale value, but adjust it continuously.

You will need an ammeter for this purpose.

To the adjust the output current of the full scale value, proceed as follows:

1. Connect the ammeter to the test connector.
2. Create the reference pressure.
3. Press and hold the [M] button.
4. Adjust the output current of the full scale value to the calculated value using the [\uparrow] or [\downarrow] button.
5. When you release the button, the device saves the adjusted value automatically.

6.5.4 Setting/adjusting electrical damping

Difference between setting and adjusting

You can set or adjust the time constant of electrical damping using the buttons. Setting means that the time constant is automatically set to 0 seconds. Adjusting means that the time constant is adjusted between 0 and 100 seconds using the steps of 0.1 seconds. This electrical damping also has an effect on the built-in basic damping of the device.

Condition for "setting"

You are familiar with the correct operation of the transmitter and the associated safety notes.

Setting electrical damping

To set electrical damping to 0 seconds, proceed as follows:

1. Set mode 4.
2. Press the [↑] and [↓] buttons simultaneously.
3. Save with the [M] button.

Result

Electrical damping has been set to 0 seconds.

Condition for "adjusting"

The default setting of steps is an interval of 0.1 seconds. If you press the [↑] or [↓] button for a longer time, the step is increased.

Adjusting electrical damping

To adjust electrical damping, proceed as follows:

1. Set mode 4.
2. Adjust the desired damping.
3. Save with the [M] button.

Result

Electrical damping has been set to the desired time constant.

6.5.5 Blind start of scale value/full scale value

6.5.5.1 Difference between setting/adjusting and blind setting/adjusting

Differences

In contrast to setting/adjusting with a reference pressure, you do not need a reference pressure for blind setting/adjusting. You can adjust a value in the physical variable "pressure" without a reference pressure, and an output current with a reference pressure.

Blind adjusting

First select the desired physical unit. Then, adjust two pressure values using the [↑] and [↓] buttons and save them in the device. These theoretical pressure values are allocated to the standard current values 4 mA and 20 mA.

Depending on the series and measuring range, a maximum downscaling of 1:100 can be achieved (measuring span ratio = r, turn down).

The correlation between the measured pressure and the output current generated is linear. The square root extracting characteristic curve for differential pressure transmitters is an exception.

Example of blind adjusting

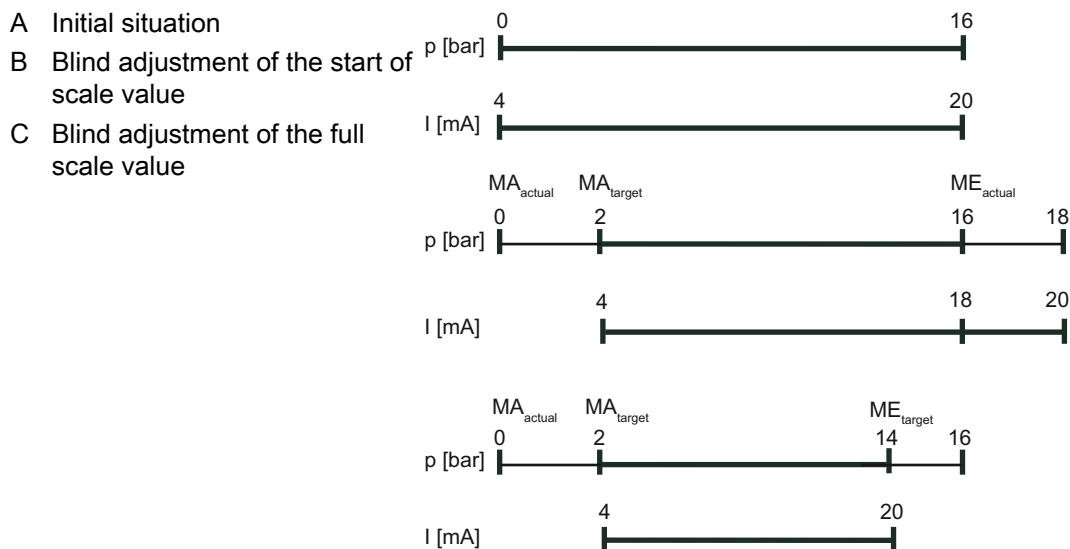

I	Output current	p	Pressure
MA_{actual}	Old start of scale value	MA_{target}	New start of scale value
I			
ME_{actual}	Old full scale value	ME_{target}	New full scale value
I			

Explanations for the blind adjusting example

- A The measuring range is from 0 to 16 bar. You are changing the start of scale value from 0 to 2 bar and the full scale value from 16 to 14 bar. The measuring span is then 12 bar.
In this example you create no pressure.
- B Use the [M] button to switch the transmitter to mode 5. To adjust the start of scale value to 2 bar, press one of the [↑] or [↓] buttons.
If there is 2 bar input pressure, the transmitter produces an output current of 4 mA.
- C Use the [M] button to switch the transmitter to mode 6. To adjust the full scale value to 14 bar, press one of the [↑] or [↓] buttons.
If there is 14 bar input pressure, the transmitter produces an output current of 20 mA.

Note

If the preset measuring limits are exceeded or fallen below by more than 20% during adjustment, the resulting current cannot be set above these limits.

With a marked elevation of the zero point, the full scale value must therefore previously be reduced such that it still lies within the permitted range after elevation of the zero point.

Setting without reference pressure

Blind setting resets the start of scale value to the lower sensor limit and the full scale value to the upper sensor limit.

Note

If the value exceeds or falls below the preset measuring limits by more than 20% when setting, the setting function is not carried out. The old value is retained in this case.

With a marked elevation of the zero point, the full scale value must therefore previously be reduced such that it still lies within the permitted range after elevation of the zero point.

6.5.5.2 Blind setting of start of scale value

Introduction

Blind setting resets the start of scale value to the lower sensor limit.

Note

Changes in modes 5 and 6 have an exclusive effect on pressure scaling. This does not affect the scaling for level or customized characteristic curve. Therefore, only measured pressure values and pressure units are displayed in these modes.

Condition

You are familiar with the correct operation of the transmitter and the associated safety notes.
You have not created any reference pressure and have selected a pressure unit.

Procedure

To the set the start of scale value blindly, proceed as follows:

1. Set mode 5.
2. Press the [↑] and [↓] buttons simultaneously for 2 seconds.

6.5.5.3 Blind setting of full scale value**Introduction**

Blind setting resets the full scale value to the upper sensor limit.

Note

Changes in modes 5 and 6 have an exclusive effect on pressure scaling. This does not affect the scaling for level or customized characteristic curve. Therefore, only measured pressure values and pressure units are displayed in these modes.

Condition

You are familiar with the correct operation of the transmitter and the associated safety notes.
You have not created any reference pressure and have selected a pressure unit.

Procedure

To the set the full scale value blindly, proceed as follows:

1. Set mode 6.
2. Press the [↑] and [↓] buttons simultaneously for 2 seconds.

6.5.5.4 Blind adjusting of the start of scale value

Introduction

In the case of blind adjustment, adjust the pressure value of the start of scale value continuously and without a reference pressure.

Note

Changes in modes 5 and 6 have an exclusive effect on pressure scaling. This does not affect the scaling for level or customized characteristic curve. Therefore, only measured pressure values and pressure units are displayed in these modes.

You can toggle between rising and falling characteristic curves.

Condition

You are familiar with the correct operation of the transmitter and the associated safety notes.
You have not created any reference pressure and have selected a pressure unit.

Procedure

To the adjust the pressure value of the start of scale value blindly, proceed as follows:

1. Set mode 5.
2. Adjust the pressure value of the start of scale value.
3. Save with the [M] button.

6.5.5.5 Blind adjustment of the full scale value

Introduction

In the case of blind adjustment, adjust the pressure value of the full scale value continuously and without a reference pressure.

Note

Changes in modes 5 and 6 have an exclusive effect on pressure scaling. This does not affect the scaling for level or customized characteristic curve. Therefore, only measured pressure values and pressure units are displayed in these modes.

You can toggle between rising and falling characteristic curves by swapping the start of scale value and the full scale value.

Condition

You are familiar with the correct operation of the transmitter and the associated safety notes.
You have not created any reference pressure and have selected a pressure unit.

Procedure

To the adjust the pressure value of the full scale value blindly, proceed as follows:

1. Set mode 6.
2. Adjust the pressure value of the full scale value.
3. Save with the [M] button.

6.5.6 Trimming the zero point**Introduction**

The zero point is calibrated in mode 7. Zero point calibration corrects zero point errors resulting from the installation position of the pressure transmitter. The device type determines the way in which you proceed.

SIMATIC PDM or the HART communicator will display the total of all zero point corrections.

Condition

You are familiar with the correct operation of the transmitter and the associated safety notes.

Zero point calibration for gauge pressure transmitter

To calibrate the zero point, proceed as follows:

1. Pressurize the transmitter.
2. Set mode 7.
3. Press the [↑] and [↓] keys simultaneously for 2 seconds.
4. Save using the [M] key.

Zero point calibration for absolute pressure transmitter

Note

You need a reference pressure known to you which lies within the measuring limits.

To calibrate the zero point, proceed as follows:

6.5 Local operation

1. Create the reference pressure.
2. Set mode 7.
3. Set the reference pressure on the display.
4. Save using the [M] key.

6.5.7 Current transmitter

Introduction

In mode 8, switch the pressure transmitter into the constant current operation. You can connect an external current transmitter in the constant current operation. The current then no longer corresponds to the process variable. The following output current can be adjusted irrespective of the input pressure:

- 3.6 mA
- 4.0 mA
- 12.0 mA
- 20.0 mA
- 22.8 mA

You can use HART communication to adjust intermediate values.

Procedure

To switch on the constant current operation, proceed as follows:

1. Set mode 8.
"Cur" in the display stands for current.
2. Press the [↑] and [↓] buttons simultaneously.
3. Select constant current.

Switching off the constant current operation

To switch off the constant current operation, proceed as follows:

Press the [M] button in mode 8.

6.5.8 Output current in case of fault

Introduction

When a fault occurs, the upper fault current is displayed in the basic setting. In mode 9, you can choose between the output of the upper and lower fault current. The standard values 3.6 mA and 22.8 mA are set.

The standard values of the upper and lower fault current can be changed via HART communication.

Condition

You are familiar with the correct operation of the transmitter and the associated safety notes.

Procedure

To change the fault current, proceed as follows:

1. Set mode 9.
2. Select the fault current.
3. Save using the [M] key.

Note

If a current saturation interrupt is active, the setting of the output current may deviate from your setting in the case of a fault.

Resetting fault current

To reset the fault current to the basic setting, proceed as follows:

Press the [↑] and [↓] [M] keys simultaneously.

Fault causes

Fault currents may be triggered by:

- FW alarm
- HW alarm
- Diagnostic interrupt
- Sensor breakage
- Measured value status BAD

Reference

NAMUR recommendation NE43 dated 02/03/2003

"Standardization of the signal level for the breakdown information of digital transmitters"

6.5.9 buttons and function lock

Introduction

In mode 10, you can disable the functions that can be executed using buttons. Application example for a lock is e.g. safeguarding the saved parameters.

Lock options

You have the following lock options on the pressure transmitter:

Table 6-5 Meaning of lock modes

Lock mode	Meaning
0	The device can be operated by means of the keys and HART communication.
LA	Keys on the transmitter are locked. Exception: <ul style="list-style-type: none"> • Releasing key lock The device can be operated by means of HART communication.
LO	Keys on the transmitter are partially locked. Exception: <ul style="list-style-type: none"> • Setting start of scale value • Releasing key lock The device can be operated by means of HART communication.
LS	Keys on the transmitter are partially locked. Exception: <ul style="list-style-type: none"> • Setting start of scale value • Setting full scale value • Releasing key lock The device can be operated by means of HART communication.
L	Write protection Operation via keys and HART communication is blocked. Exception: <ul style="list-style-type: none"> • Releasing key lock

Note

If you want to select the LO or LS lock, we recommend you first select the measured value display of "Current" in "mA" or "%" in mode 13. Otherwise, a change in the output variable using the [↑] and [↓] buttons is not detected.

If the blind cover is provided, the LS lock mode is effective, i.e. only the zero point and the span can be changed. If you continuously operate the device with the blind cover, ensure that the LS lock mode is constantly set.

Condition

You are familiar with the correct operation of the transmitter and the associated safety notes.

Note

In the measured value display function, check whether the desired setting is displayed.

Procedure

To disable the buttons, proceed as follows:

1. Set mode 10.
2. Select the desired lock mode.
3. Confirm the lock mode with the [M] button.

6.5.10 Releasing key lock or function lock

Releasing key lock



WARNING

In the case of devices used for safety-relevant applications, only authorized personnel may release the key lock, e.g. overflow protection.

To release a set key lock (LA, LO, LS) using buttons, proceed as follows:

Press the [M] button for 5 seconds.

Releasing the write protection

To release a write protection for HART (L) using buttons, proceed as follows:

Press the [M] button for 5 seconds.

6.5.11 Flow rate measurement (only differential pressure)

Introduction

The characteristic curve representing the relationship between the output current and input pressure can be adjusted in mode 11. Adjust the root application point in mode 12.

You can select the following characteristic curve types of the output current:

6.5 Local operation

- linear "lin": proportional to differential pressure
- square root extracting "sroff": proportional to flow rate, deactivated up to the application point
- square root extracting "srln": proportional to flow rate, linear up to the application point
- square root extracting "srli2": proportional to flow rate, two-step linear up to the application point

Variable application point

The output current for the "srln" and "sroff" functions can be displayed linearly or set to zero below the application point of the square root extracting characteristic curve.

Fixed application point

The "srli2" function has a permanently defined application point of 10%. The range up to this point contains two linear characteristic curve sections. The first section ranges from the zero point to 0.6% of the output value and 0.6% of the pressure value. The second section has a higher gradient and it goes up to the root application point at 10% of the output value and 1% of the pressure value. See the following figure for this purpose.

Procedure

Proceed as follows to set or adjust the type of characteristic curve:

1. Set mode 11.
2. Select the type of characteristic curve.
To set the characteristic curve to "linear", press the [↑] and [↓] buttons simultaneously.
3. Save with the [M] button.

Proceed as follows to set or adjust the root application point: This procedure is not applicable for "srli2":

1. Set mode 12.
2. Select an application point between 5 and 15%.
To set the application point to 10%, press the [↑] and [↓] buttons simultaneously.
3. Save with the [M] button.

Note

Mode 12 cannot be selected if the "linear" or "srli2" measuring mode has been adjusted in mode 11.

If the square root extracting characteristic curve has been adjusted in mode 11 and if the measured value display has been set to "Pressure" in mode 13, the root sign and the differential pressure corresponding to the flow rate are displayed.

The "srli2" square root extraction function is set as default in "Flow rate" measuring mode.

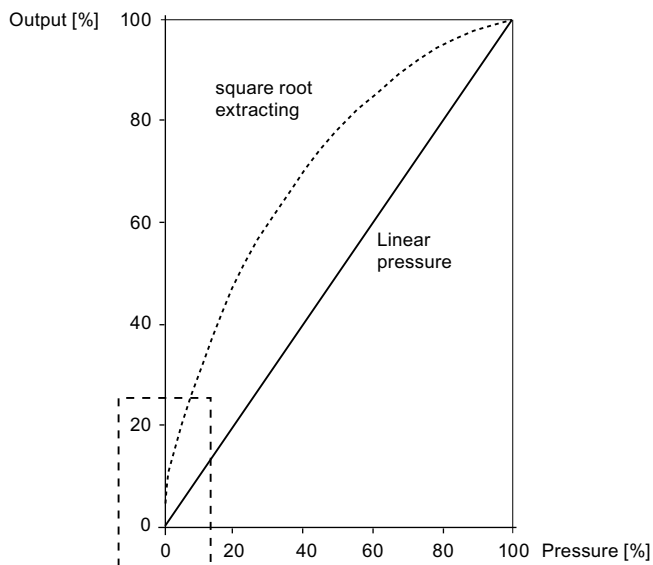

The dotted rectangle has been magnified in the form of the following characteristic curves in order to show the behavior of characteristic curves.

Characteristic curves and application point of square root extracting characteristic curves

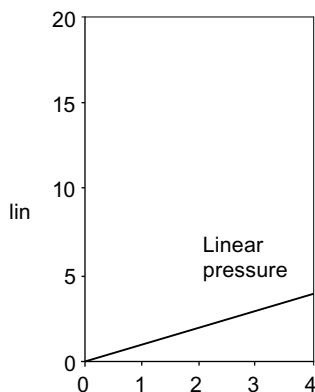

Characteristic curve "lin":

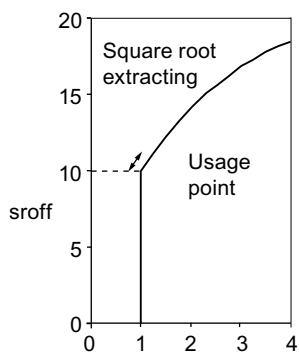

Characteristic curve "sroff"

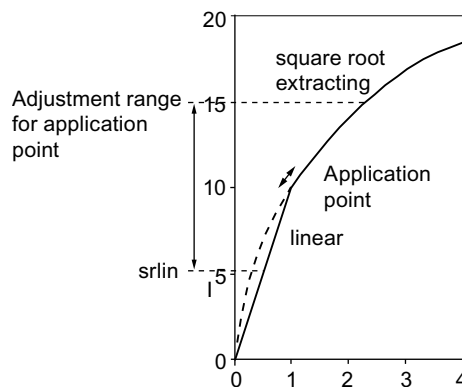

Square root extracting characteristic curve "srlin"

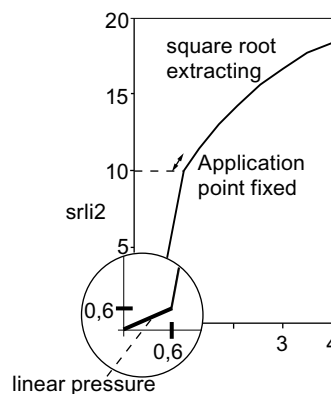

Characteristic curve "srl2"

6.5.12 Measured value display

Note

To use the operating functions with the buttons, first set the device variable (DV) parameters with a host system such as SIMATIC PDM. You will find details of the relation between primary variable (PV) assignment and the DV in the following section:

Measuring mode "Pressure" (Page 101)

Introduction

In mode 13, adjust the following types of measured value display:

- mA
- %
- Display of the PV selected via HART. (Default setting: P pressure)

Table 6-6 Display of measuring mode/device variables

Display	DV	Meaning
P	0	Pressure
t-SE	1	Sensor temperature
t-EL	2	Electronics temperature
P-UNC	3	Pressure (untrimmed)
LEVEL	4	Level
Vol	5	Volume
MASS	6	Mass
V-Flo	7	Volumetric flow rate (not relevant for gauge or absolute pressure)
M-Flo	8	Mass flow rate (not relevant for gauge or absolute pressure)
CUSt	9	Users

Condition

You are familiar with the correct operation of the transmitter and the associated safety notes.

Procedure

To select the display type, proceed as follows:

1. Set mode 13.
2. Select the measured value display.
3. Save with the [M] button.

See also

Measured value display (Page 121)

6.5.13 Unit**Introduction**

In mode 14, select the physical unit in which the measured value display of the device should be shown.

Condition

You are familiar with the correct operation of the transmitter and the associated safety notes.
You have already selected the desired measured value display via HART.

Procedure

To adjust the physical unit, proceed as follows:

1. Set mode 14.
2. Select a unit.
Press the [↑] and [↓] buttons simultaneously to set the unit to the first value in the following table depending on the measuring mode set.
3. Save with the [M] button.

Instructions for selecting the unit

- Unit selection depends on the type of measurement set. For example, only pressure units are available in "Pressure" measuring mode and only level units are available in the "Level" measuring mode.
- The displayed measured value is always converted into the new unit. "9.9.9.9.9" appears on the display when its display capacity is exceeded.
- The selected unit is visible on the display in the measuring mode only if you have selected the display of a physical unit via HART. "mA" or "%" will be displayed if you have not selected mode 13, "Measuring mode".

Units

Table 6-7 Units available for pressure

Pressure units	Display	Pressure units	Display
mbar	mbar	Psi	PSi
bar	bar	Pa	Pa
mm water column (20°C / 68°F)	mmH2O	KPa ²	KPa
Inch water column (20°C / 68°F)	inH2O	MPa	MPa
Feet water column (20°C / 68°F)	FTH2O	g/cm2	Gcm2
mm mercury column	mmHG	Kg/cm2	KGcm2
Inch mercury column	in_HG	Torr	TORR
mm water column (4°C / 39 °F)	m4H2O	ATM	ATM
Inch water column (4°C / 39°F)	i4H2O		

Table 6-8 Units available for level

Level unit	Display	Level unit	Display
Feet	FT	cm	cm
Inch	inch	mm	mm
M	m		

Table 6-9 Units available for mass

Mass unit	Display	Mass unit	Display
Gram	G	Long ton	ITon
Kilogram	KG	Pound	lb
Ton	T	Ounce	OZ
Short ton	STon		

Table 6-10 Units available for mass flow rate

Mass flow rate unit	Display	Mass flow rate unit	Display
g / s	G/S	Pound / s	P/S
g / min	G/m	Pound / min	lb/m
g / h	G/h	Pound / h	lb/h
Kg / s	KG/S	Pound / d	lb/d
Kg / min	KG/m	Short ton / min	ShT/m
Kg / h	KG/h	Short ton / h	ShT/h
Kg / d	KG/d	Short ton / d	ShT/d
T / min	T/m	Long ton / h	IT/h
T / h	T/h	Long ton / d	IT/d
T / d	T/d		

Table 6-11 Units available for temperature

Temperature unit	Display	Temperature unit	Display
° Celsius	° / C	Kelvin	K
° Fahrenheit	° / F	Rankine	R

Table 6-12 Units available for volume

Volume unit	Display	Volume unit	Display
M3	m3	Buschels	buShl
Liter	L	yard3	Yd3
Hectoliter	HL	Feet3	FT3
US gallon	Gal	inch3	in3
British gallon	in Gal	Standard l	STdL
British barrel	bbl	Standard m3	STdm3
British barrel liquid	bblli	Standard feet3	STFT3

Table 6-13 Units available for volumetric flow

Unit of volumetric flow	Display	Unit of volumetric flow	Display
m3 / second	m3/S	Gallon / hour	Gal/h
m3 / minute	m3/m	Gallon / day	Gal/d
m3 / hour	m3/H	Million gallon / day	MGI/D
m3 / day	m3/d	British gallons/second	iGI/S
Liter / second	L/S	British gallons/minute	iGI/m
Liters/minute	L/m	British gallons/hour	iGI/h
Liters/hour	L/h	British gallons/day	iGL/d
Million liter / day	mL/d	Standard m3 / hour	Sm3/h
Feet3 / second	FT3/S	Standard l / hour	STL/h
Feet3 / minute	FT3/m	Standard feet3 / minute	SFT3m
Feet3 / hour	FT3/h	British barrel liquid / second	bbl/S
Feet3 / day	FT3/d	British barrel liquid / minute	bbl/m
Gallon / second	Gal/S	British barrel liquid / hour	bbl/h
Gallons/minute	Gal/m	British barrel liquid / day	bbl/d

See also

Selection of the physical unit (Page 122)

Operating functions through HART

7.1 Operating functions through HART communication

Condition

You can operate the transmitter through HART communication. The following is required for this purpose:

- A HART communicator or PC software such as SIMATIC PDM.
- A HART modem to connect a PC with the transmitter or a lead to connect a HART communicator with the transmitter.

Introduction

The full functionality of the transmitter is available via HART communication. The HART communicator and PC software are not supplied with the transmitter. How to connect and operate a HART communicator or the PC software is described in separate operating instructions or in the online help for both these tools.

Fundamental description

The input signal is provided in the form of digital information in the following variables through HART communication:

- Pressure
- Level
- Volume
- Mass
- Volumetric flow
- Mass flow rate
- User programmable "characteristic curve"

As soon as you have set up the HART communication and the transmitter, you can adapt the transmitter to your relevant measuring task. When doing so you are assisted by the selectable measuring modes "Pressure", "Level", "Flow rate" and a user programmable "Characteristic curve". One or more device variables are permanently allocated to each measuring mode in order to execute corresponding measuring tasks.

See also

Overview of operation (Page 65)

7.2 Process tag data

You can store your process tag data in user definable fields. The following table contains information about the structure of these fields and the format in which you can enter information in these fields:

Table 7-1 Process tag data

Field	Explanations
Tag designation	Eight characters
Date	Day:Month:Year
Description	16 characters
Message	32 characters
Works number	Integer number
Tag designation long	32 characters
Freely definable material parameter	21 x 16 characters

7.3 Selecting the measuring modes

7.3.1 Overview of measuring modes

Overview

The transmitter can be set for the corresponding measuring task using a few parameters. You can select the following measuring modes:

- Pressure
- Level
- Flow rate
- Users: user programmable characteristic curve

You can use the measuring mode selector to activate measuring modes "Level", "Flow rate" and "User".

Selecting the device variables

One or more device variables are permanently allocated to each measuring mode. The following device variables are always active and are therefore always displayed:

- Pressure
- Sensor temperature
- Electronics temperature
- Pressure (untrimmed)

The following device variables are activated only when the allocated measuring mode is activated and parameterized simultaneously:

- "Level", "Volume" and "Mass" are allocated to the "Level" measuring mode.
- "Volumetric flow" and "Mass flow rate" are classified as "Flow rate" measuring mode.
- "User" is allocated to the "User" measuring mode.

The inactive device variables have the CONSTANT status.

7.3.2 Measuring mode selector

You can use this switch to toggle between measuring modes "Pressure", "Level", "Flow rate" and a characteristic curve programmable by a "User".

If a measuring mode has been selected using the measuring mode selector, it has to be configured. This does not mean that this block has an automatic effect on the current output (4 to 20 mA). For that, you need to switch the corresponding device variable to the primary variable (PV) using a so-called variable mapper.

7.3.3 Variable mapper

Introduction

In this transmitter, the dynamic variable that determines the behavior of current output is always called the primary variable (PV). You need to use the variable mapper for a number of purposes, including selecting which device variable is to be switched to PV. The variable selected as PV using a PC program such as SIMATIC PDM or using the HART Communicator is scaled once again in the analog output stage to a zero value and a limit value. These two values then correspond to the current values 4 and 20 mA.

As soon as the PV is switched over using the variable mapper, the start of scale value and full scale value in the analog output stage are preset to the limit values of the new device variables. You can define these limit values within the individual block functions.

The dynamic variables "Primary", "Secondary", "Tertiary" and "Quarternary" (PV, SV, TV, QV) can be interconnected with any active device variables. Various different measuring mode examples are conceivable with a 4 bar pressure transmitter.

See also

Measured value status (Page 110)

7.3.4 Measuring mode "Pressure"

The "Pressure" measuring mode contains the "Sensor trim" function, and is always active since it is the standard measuring mode. When the measuring mode selector is set to "Off", further measuring variables are not derived from the "Pressure" measuring variable. Except the first

7.3 Selecting the measuring modes

four variables, all other device variables are marked as inactive and have the CONSTANT status. These four variables are mapped with dynamic variables PV, SV, TV and QV by default.

Switching an inactive device variable to the primary variable (PV) generates an error message since the variable currently does not have a valid measured value. This message is displayed in SIMATIC PDM or the HART communicator.

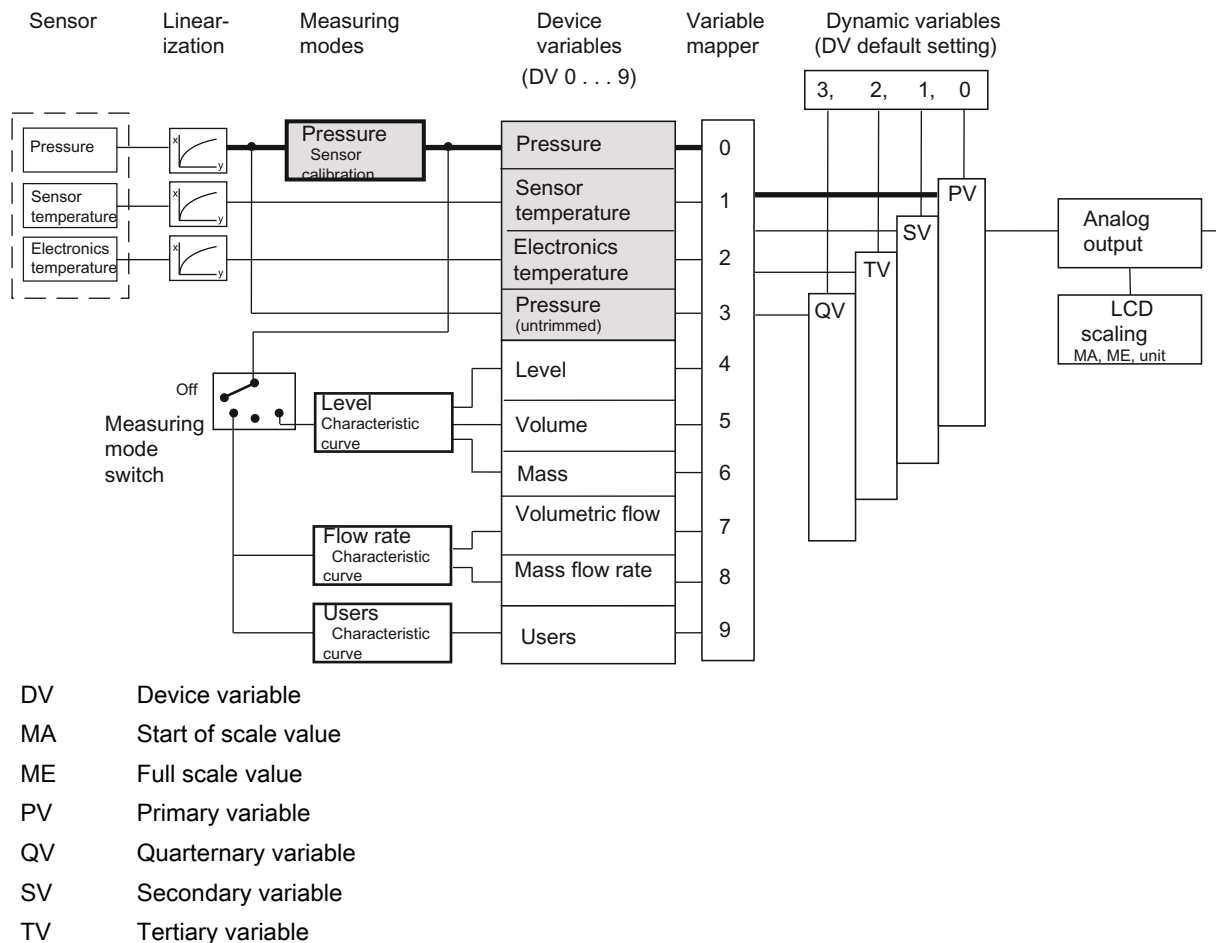

Figure 7-1 Measuring mode "Pressure"

7.3.5 Customized characteristic curve

Introduction

The customized "characteristic curve" is continuously active as an identical function in the three following measuring modes "Level", "Flow rate" and "User". This means that the customized "characteristic curve" always provides a result for the following function, thus also influencing the measured value status of the affected device variables.

In the device, the characteristic curve vertices are only provided once in the EEPROM. Therefore, if the measuring mode is changed, you will usually need to adjust the characteristic curve accordingly.

The characteristic curve function expects at least two and at the most 30 characteristic curve vertices as input parameters. Characteristic curve vertices are entered in pairs of values x %;y %. The values for the x-coordinate are only accepted by the device when they run monotonically. The y-coordinates, on the other hand, may also be non-monotonic. A warning will however be issued by the configuring device, which you as the user have to recognize and acknowledge. The output of the characteristic curve is not explicitly stored in a device variable, but rather is directly interconnected with the input of the next function block in each case. The pairs of values 0%;0% and 100%;100% are set as default values. In principle, rising and falling characteristic curves can be configured. With regard to the device variable status, rising characteristic curves are however preferred. Otherwise the meanings of HIGH LIMIT and LOW LIMIT are swapped.

See also

Measured value status (Page 110)

7.3.6 Measuring mode "Level"

Description

Once you have configured the measuring mode "Level", the device variables "Level", "Volume" and "Mass" are activated. They are all inferred from the measured pressure. The "Level" block here represents a series of permanently interconnected functions which you need to configure

7.3 Selecting the measuring modes

with appropriate parameters. Only then will you be given a meaningful measured value for the three device variables.

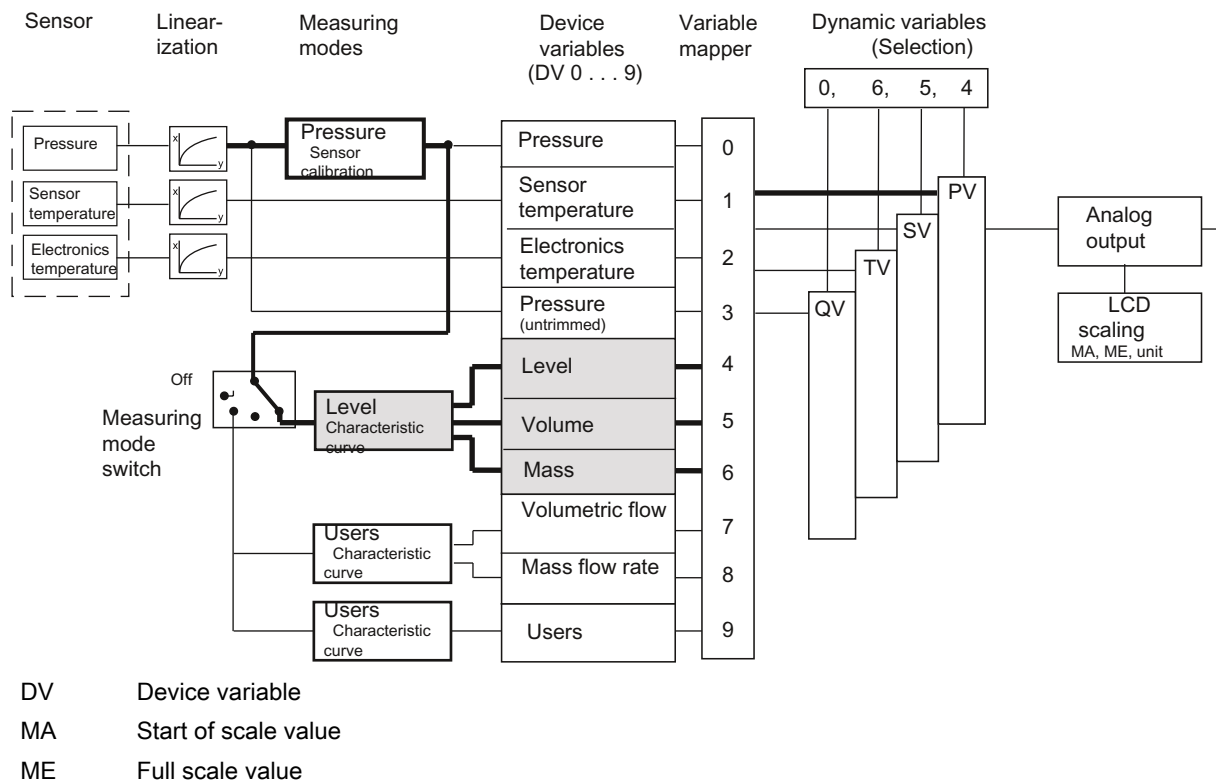

Figure 7-2 Measuring mode "Level"

Functions of the "Level" block

The first function, "Input scaling, pressure", sets the pressure range used by the following functions in all three blocks in the same way. Ideally, this range corresponds to the sensor limits of the transmitter. In the following calculation examples, 0 and 4 bar are assumed for these sensor limits for all blocks. You can however also set a downscaling, e.g. 1:2. The downscaling of 1:2 means that 50% of the rated measuring range, here 2 bar, can control the following characteristic curve 100%.

Use the "Output scaling, level" to set the measuring limits for the measuring mode "Level" with a unit from the level range. Parameter settings in this example are 10 and 20 m. At 0 bar process pressure, 10 m is displayed in DV4 and 20 m is displayed at 2 bar. The values for the start of scale value and the full scale value, which are effective for the analog output, are configured in the "analog output" block.

In the calculation example, the two pairs of values 0%;0% and 100%;100% are configured for the customized "characteristic curve". This is the default setting. The measured value from the pressure scaling is transferred 1:1 in this example.

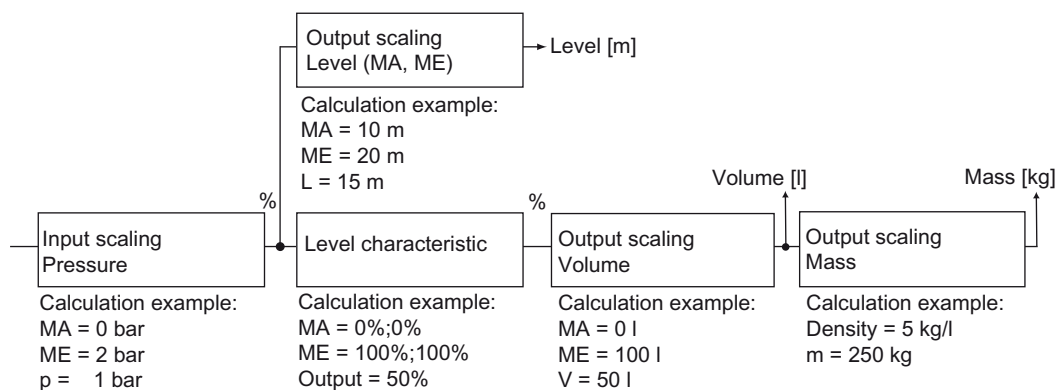

DV [x]	Device variable x
L	Level
m	Mass
MA	Start of scale value
ME	Full scale value
P	Pressure
V	Volume

Figure 7-3 Functions of the "Level" block

Configure the "Output scaling, volume" with a unit from the volume range and the measuring limits for the device variable "Volume". The characteristic curve output directly affects the volume scaling input.

In the calculation example, for the measuring limits from 0 and 100 l, a volume of 50 l is yielded for process pressure of 1 bar.

The "Level" parameter setting also still automatically activates the device variable for the mass. If you have not yet configured a value for the density, the initial value of 1 kg/l is preset. In the calculation example for the "Mass" device variable, a mass of 250 kg is derived at a density of 5 kg/l.

Note

When the density changes, the measuring range limits have to be adjusted accordingly.

You can configure all parameter settings for the "Level" block in SIMATIC PDM or the HART communicator. Activate the "Level" measuring mode for this purpose. For all settings, the measuring limits may be exceeded by +/-20%. Values which lie above or below that will be rejected by the device.

7.3.7 Measuring mode "Flow rate"

Description

When you activate the "Flow rate" measuring mode, only two other device variables are active: volumetric flow and mass flow rate. If another block was active earlier, the corresponding device variables remain inactive and have the "CONSTANT" status. The "Flow rate" block here represents a series of permanently interconnected functions which you need to configure with appropriate parameters.

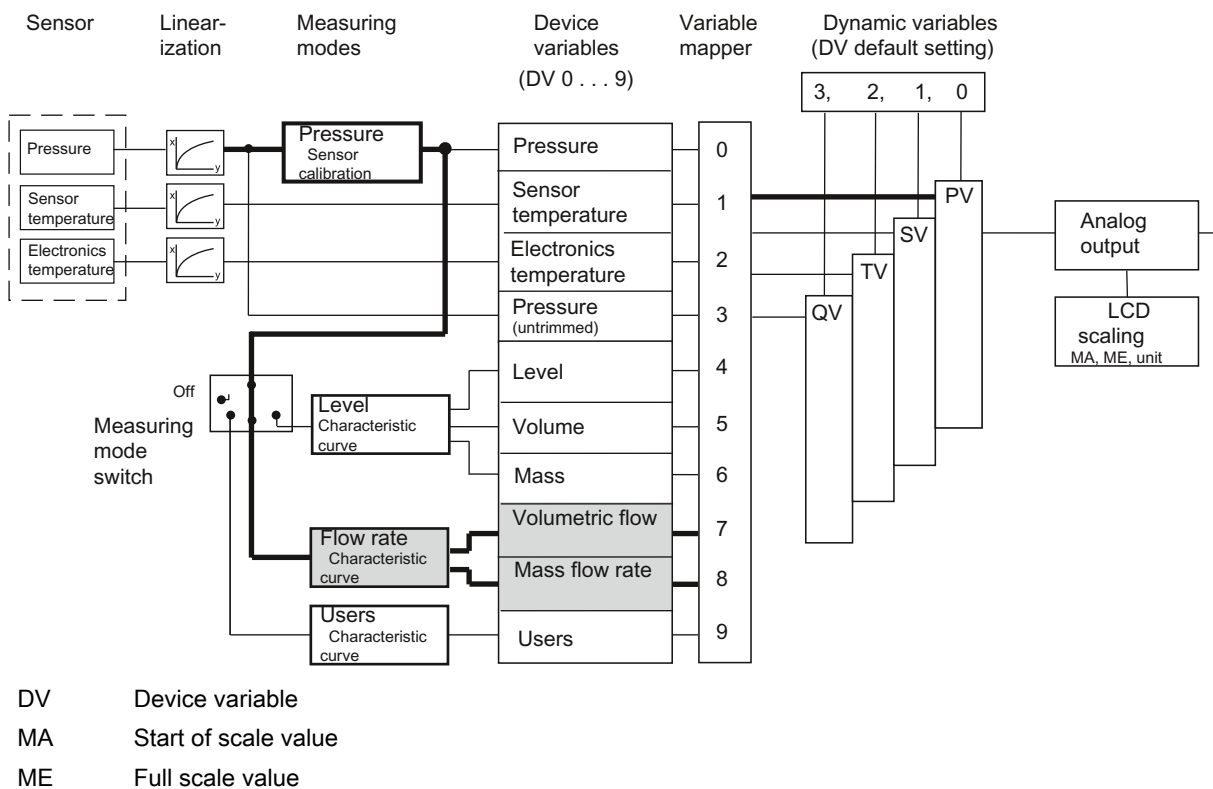

Figure 7-4 Measuring mode "Flow rate"

Functions of the "Flow rate" block

The "Input scaling, pressure" function defines the pressure range of 0 to 2 bar that is interpreted as 0 and 100% by the following square root extracting function. A process pressure of 0.5 bar has been assumed in the following figure.

In the "Flow rate" measuring mode, a square root extracting characteristic curve "srlin2" is plotted with a fixed root application point of 10%.

In the calculation example, the input value for the "square root extracting function" is approximately 25% at a process pressure of 0.5 bar. The output value is approximately 50%.

Note

When using the "Flow rate" block, other square root extracting characteristic curves must be deactivated if required.

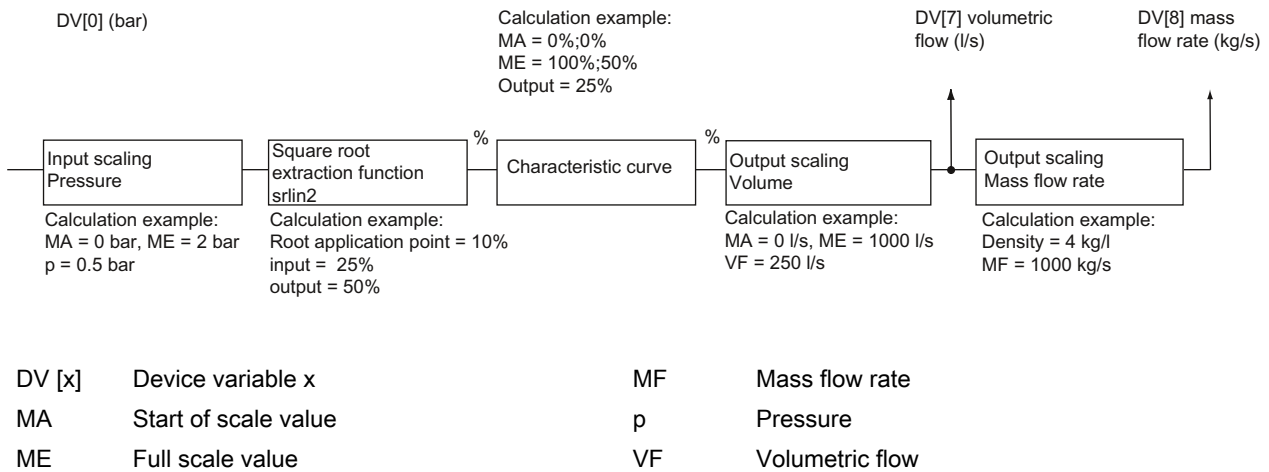

Figure 7-5 Functions of the "Flow rate" block

In the calculation example, the two pairs of values 0%;0% and 100%;50 % are configured for the customized "characteristic curve". This setting corresponds to a bisection of the input value for all output values.

Configure the output scaling "volumetric flow" with a unit from the volume flow range and the measuring limits for the device variable "Volumetric flow". In the calculation example, 0 l/s and 1000 l/s are defined as lower and upper measuring limits. The volumetric flow rate is 250 l/s at a process pressure of 0.5 bar.

The "Mass flow rate" device variable is automatically activated when the "Flow rate" block is configured. If you have not yet configured a value for the density, the initial value of 1 kg/l is preset.

In the calculation example, a mass of 1000 kg/s is derived for the "Mass flow rate" device variable at a value of 4 kg/l. The density value entered is only used to calculate the mass flow rate. The entered value of density has no effect on the diaphragm calculation that is to be carried out by the user.

In SIMATIC PDM or the HART communicator, the "Flow rate" block is configured in an online dialog box in an extremely compact manner. In this online dialog box, you can compile all values in a menu and transfer them to the device collectively.

7.3.8 Measuring mode "User"

Description

The "User" measuring mode is the simplest of the measuring modes that you can select with the measuring mode selector. Only one further device variable, "User", is activated in this measuring mode in addition to the four standard device variables. The variables "Level", "Volume", "Mass", "Volumetric flow" and "Mass flow rate" are marked as inactive and are given the status CONSTANT.

In the "User" measuring mode, you have an option to define a customized unit for output scaling. This customized unit is, e.g. a specific quantity of liquid. This quantity of liquid depends on the input process pressure.

Example: Fill the beverages in cans having a capacity of 0.33 l. You can now define a customized unit "Can" that is exactly equal to 0.33 l. The quantity of "cans" depends on the input process pressure.

Note

Permissible input values

All alphabetic a...z, A...Z and numeric 0...9 inputs are allowed for the customized unit. The following characters are also allowed:

° " \$ / < > * , _ + - = @

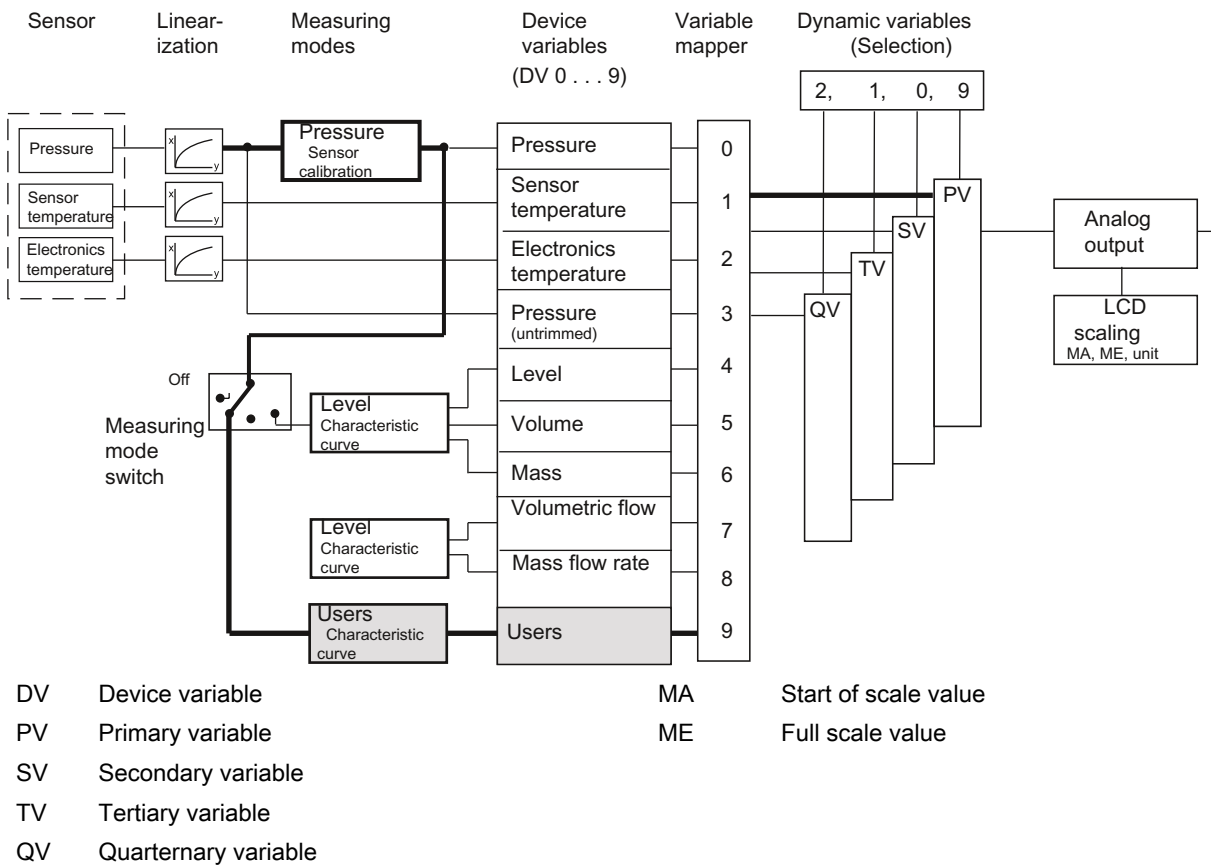

Figure 7-6 Measuring mode "User"

Functions of the "User" block

The first function, "Input scaling, pressure", defines the pressure range which is used by the customized characteristic curve. Ideally, this range corresponds to the sensor limits. In the calculation example, 0 and 2 bar are assumed. This means that with process pressure of 0.5 bar, there is a value of 25% on the characteristic curve.

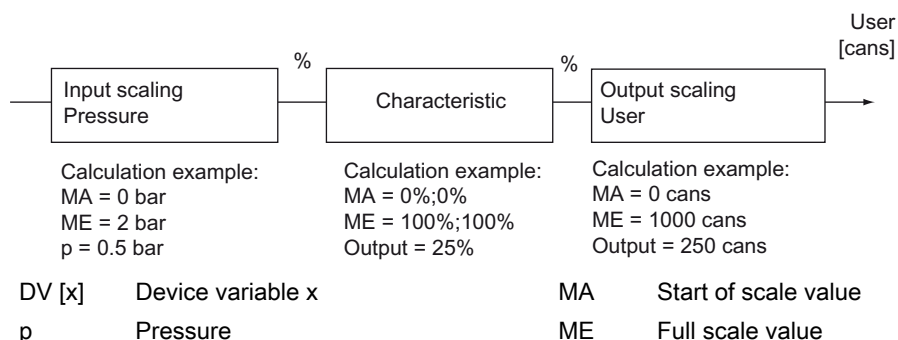

Figure 7-7 Functions of the "User" block

In the calculation example, the two pairs of values 0%;0% and 100%;100% are configured for the customized "characteristic curve". Any curve shapes can be calculated with the help of 30

7.3 Selecting the measuring modes

characteristic curve vertices. These curve shapes can be stored in the device using SIMATIC PDM or the HART communicator.

In the calculation example, the value at the input of the characteristic curve is transferred 1:1 to the output.

In the calculation example, a number of filled cans is set for the output scaling. You can enter up to five characters for any given unit. Do not confuse this with the user-programmable display unit of the "Analog output" block.

In the calculation example, you have a start of scale value of 0 cans and a full scale value of 1000 cans. At a process pressure of 0.5 bar, you get a value of 250 cans for the "User" device variable.

See also

Analog output (Page 114)

Measured value status (Page 110)

7.3.9 Measured value status

Introduction

Every device variable is assigned a status byte to indicate the quality of the measured values. This status byte can have the following values:

- BAD
- GOOD
- MANUAL
- UNCERTAIN

The following values are also possible:

- CONSTANT
- HIGH LIMIT
- LOW LIMIT

A higher-level diagnosis program can display and analyze these states.

GOOD status

During smooth, uninterrupted operation, the measured value status of all active device variables is GOOD.

BAD/CONSTANT status

All inactive device variables have CONSTANT/BAD status.

If a variable having the BAD status is an output value for calculation, the measured value is BAD.

The basic measured values, namely pressure and temperatures, have the BAD status in the following cases:

- The analog-to-digital converter does not function.
- Linearization values in the EEPROM are defective.
- If the two end points of the customized characteristic curve are exceeded for the status of the device variables of the following function.

UNCERTAIN status

If a pressure value exceeds or falls below the sensor limits of the device by more than 20%, the corresponding measured value and the variables inferred from it are UNCERTAIN.

If the analog-to-digital converter for pressure control is over/underrange, the status is UNCERTAIN.

HIGH LIMIT and LOW LIMIT

If the analog-to-digital converter is overrange, the HIGH LIMIT label is allocated. If the analog-to-digital converter is underrange, the LOW LIMIT label is allocated.

Change in status

If the status of a device variable changes and it was right at the front of the sequence of operations for a block, e.g. pressure, then all variables that are derived from it will take on the same status. In the following example, the device variable "Pressure" has the BAD status. Since the measuring mode selector is set to "USER", the device variable "User" is also given the BAD status.

The reasons for changes in the status of a device variable are summarized in the table. If there were several reasons for a change in status, MANUAL always has the highest priority. BAD has the second highest and UNCERTAIN the third highest priority.

Operating functions through HART

7.3 Selecting the measuring modes

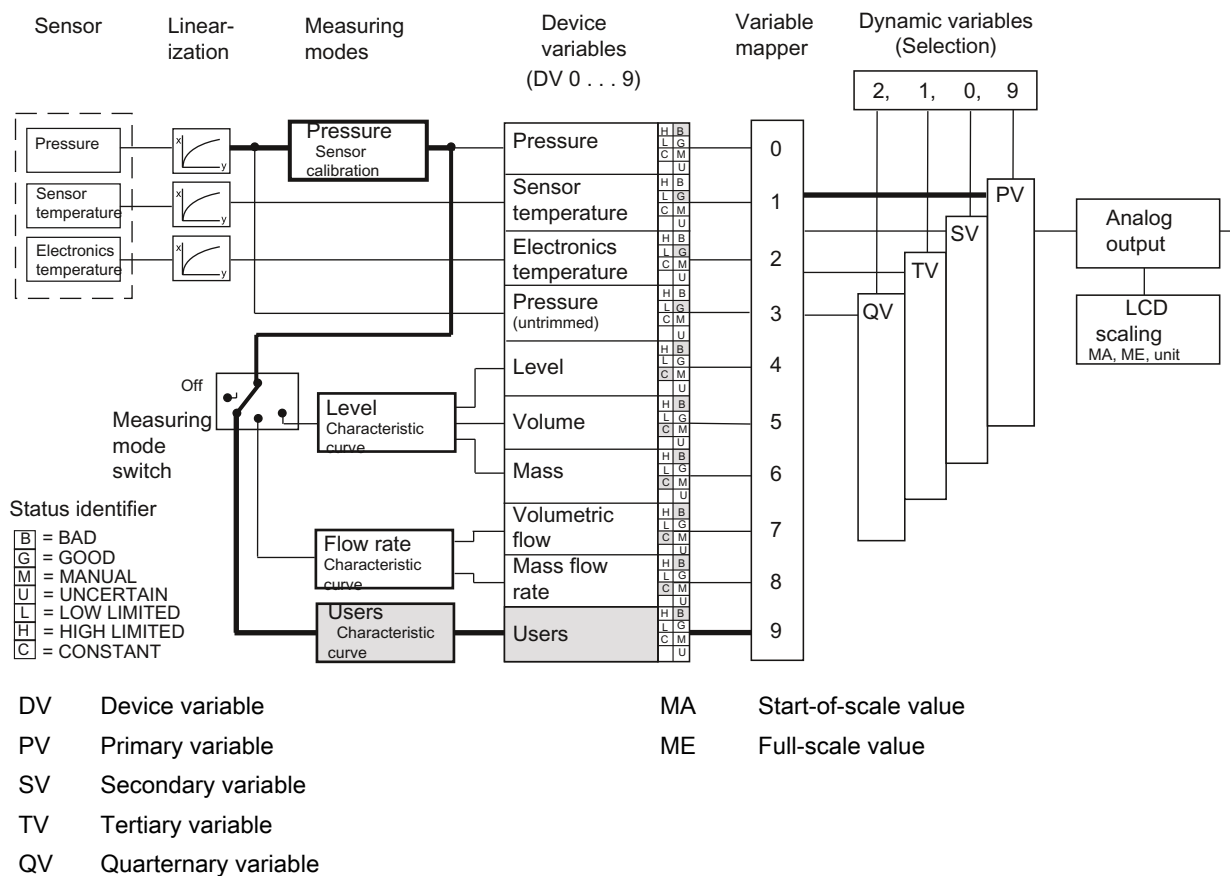

Figure 7-8 Device status dependency

Table 7-2 Events which result in a change of status

DV	Measuring mode	BAD	MANUAL	UNCERTAIN	CONSTANT	HIGH LIMIT	LOW LIMIT
0	Pressure	DV3 = BAD, fault in linearization	When DV0 is simulated	DV3 = UNCERTAIN	-	DV3 = HIGH LIMIT	DV3 = LOW LIMIT
1	Sensor temperature	DV2 = BAD, analog-to-digital converter in over/underrange, fault in linearization	When DV1 is simulated	DV1 more than 20% outside the sensor limits DV2 = UNCERTAIN DV2 = MANUAL	-	Analog-to-digital converter in overrange	Analog-to-digital converter in underrange
2	Electronics temperature	Analog-to-digital converter in over/underrange, fault in linearization	When DV2 is simulated	DV2 more than 20% outside the sensor limits	-	Analog-to-digital converter in overrange	Analog-to-digital converter in underrange

DV	Measuring mode	BAD	MANUAL	UNCERTAIN	CONSTANT	HIGH LIMIT	LOW LIMIT
3	Pressure (untrimmed)	Analog-to-digital converter in over/underrange, DV1 sensor breakage, DV2 = BAD, fault in linearization	-	Analog-to-digital converter in overrange/underrange, DV3 more than 20% outside the sensor limits DV2 = MANUAL	-	Analog-to-digital converter in overrange	Analog-to-digital converter in underrange
4	Level	If DV0 = BAD	When DV0 is simulated	DV0= UNCERTAIN	DV not active	DV0 = HIGH LIMIT	DV0 = LOW LIMIT
5	Volume	DV0 = BAD, Characteristic curve is faulty	When DV0 is simulated	DV0 = UNCERTAIN, input value is outside the specified characteristic curve range	Characteristic curve is faulty DV not active	DV4 = HIGH LIMIT, Characteristic curve for maximum value with gradient 0	DV4 = LOW LIMIT, Characteristic curve for minimum value with gradient 0
6	Mass	DV5 = BAD	When DV0 is simulated	DV5= UNCERTAIN	DV not active, DV5 = CONSTANT	DV5 = HIGH LIMIT	DV5 = LOW LIMIT
7	Volumetric flow (not absolute and gauge pressure)	DV0 = BAD, characteristic curve is faulty	When DV0 is simulated	DV0 = UNCERTAIN, input value is outside the specified characteristic curve range	Characteristic curve is faulty, DV not active	DV4 = HIGH LIMIT, Characteristic curve for maximum value with gradient 0	DV4 = LOW LIMIT, Characteristic curve for minimum value with gradient 0
8	Mass flow rate (not absolute and gauge pressure)	DV5 = BAD	When DV0 is simulated	DV5= UNCERTAIN	DV not active DV5 = CONSTANT	DV5 = #HIGH LIMIT	DV5 = LOW LIMIT
9	Users	DV0 = BAD, Characteristic curve is faulty	When DV0 is simulated	DV0 = UNCERTAIN, input value is outside the specified characteristic curve range	Characteristic curve is faulty DV not active	DV0 = HIGH LIMIT, Characteristic curve for maximum value with gradient 0	DV0 = LOW LIMIT, Characteristic curve for minimum value with gradient 0

If you use falling characteristic curves in the blocks, the meanings of HIGH LIMIT and LOW LIMIT are swapped around.

If you mix falling and rising characteristic curves, the meanings will be swapped each time a falling characteristic curve is run.

7.3.10 Analog output

Introduction

The "Analog output" block converts the value provided by the dynamic primary variable (PV) into a current value of 4 to 20 mA. When you actuate the measuring mode selector, you automatically define the start of scale value and the full scale value to the current values 4 and 20 mA, respectively. Limit values of corresponding device variables are used for scaling the analog output by default. You have entered these limits when setting the parameters of your measuring mode.

Example for measuring mode "Level"

This means that for a "Level" device variable as PV, 10 m corresponds to the value for 4 mA and 20 m corresponds to the value for 20 mA. You can change this presetting again in the "Analog output" block. This is done by restricting the range of the "Level" device variable for scaling the output current to e.g. 12 to 18 m. This downscaling has no effect on the previous block scaling. In this case, a current of 4 mA is output for a measured height of 12 m, and a current of 20 mA for 18 m.

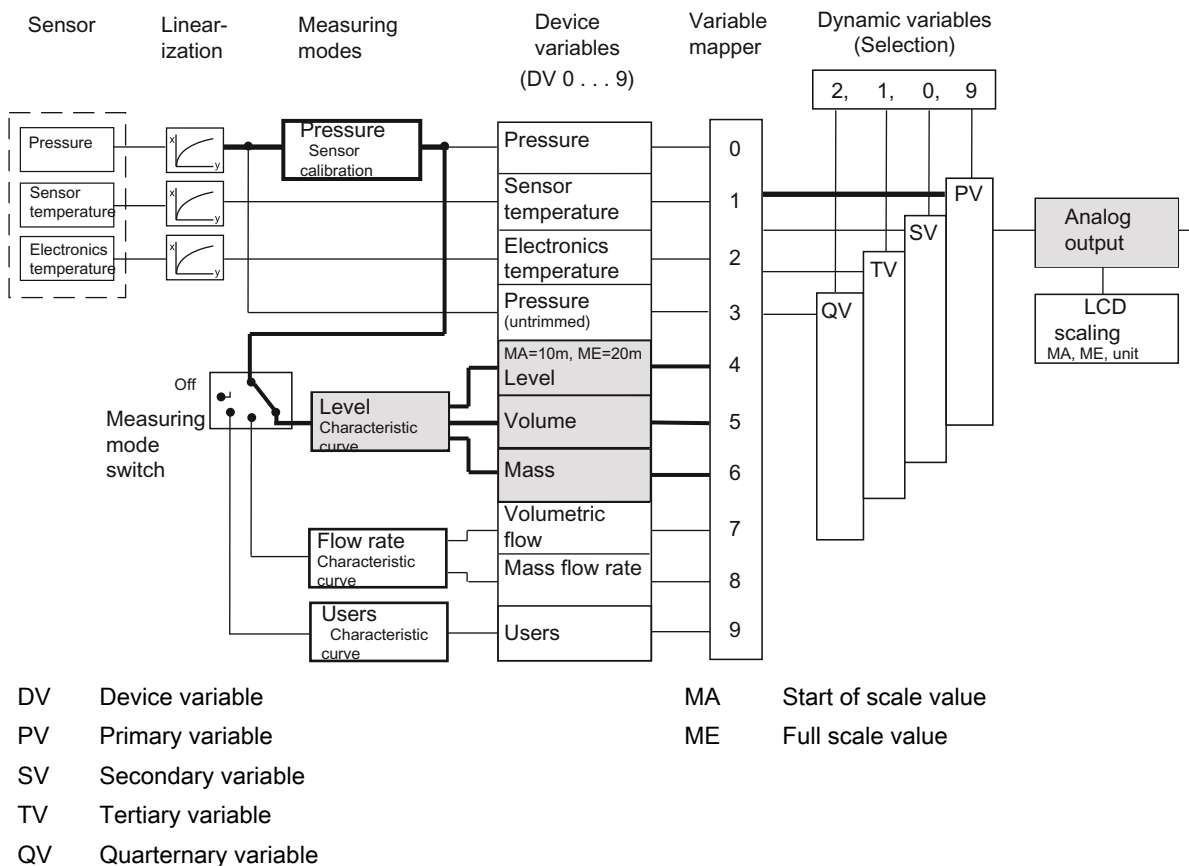
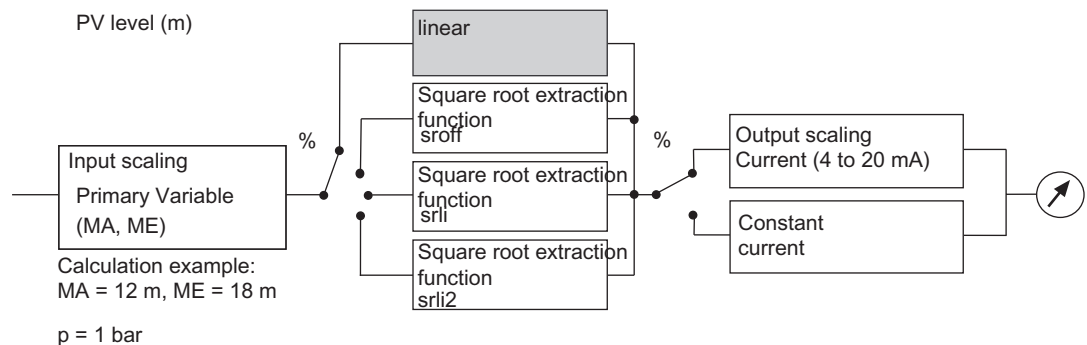

Figure 7-9 "Analog output" scaling

Description of measuring mode "Level"



MA	Start of scale value	p	Pressure
ME	Full scale value	PV	Primary variable

Figure 7-10 "Analog output" block

Note

If, when setting the analog output, the values for the start of scale value zero and the full scale value are more than 20% below or above the limit values of the set PV (set using the variable mapper), the values will be rejected by the device. The values configured previously are retained. Similarly, the span must not fall below the minimum.

Minimum span = ME - MA

The square root extracting function can only be selected in the "Pressure" measuring mode.

The "srlin2" square root extracting function is set as default in the "Flow rate" measuring mode.

7.3.11 Scaling the display value

Introduction

You can scale the value shown in the display as you wish and allocate it any unit of 5 characters. The scaling of the value is independent of the selection of the measuring mode selector, the primary variable (PV) and the display unit defined. Use the "Display settings" item in SIMATIC PDM or the HART communicator for this purpose.

The percent value of the PV is the basis for this scaling. This percent value is also used to scale the current output. In SIMATIC PDM, this item is referred to as "Setting the PV output scaling". After selecting the "Display settings" menu item, you must enter a start-of-scale value, a full-scale value and a unit string.

This display option has the highest priority amongst all options. A switch over to %, mA or any other unit is not possible in this status. You need to deactivate the LCD scaling again for this purpose.

Example

In the Level measuring mode, the start of scale value is assumed as 0 m and the full scale value as 10 m in the example illustrated in the following picture. The value of 2 m is displayed at a process pressure of 0.4 bar.

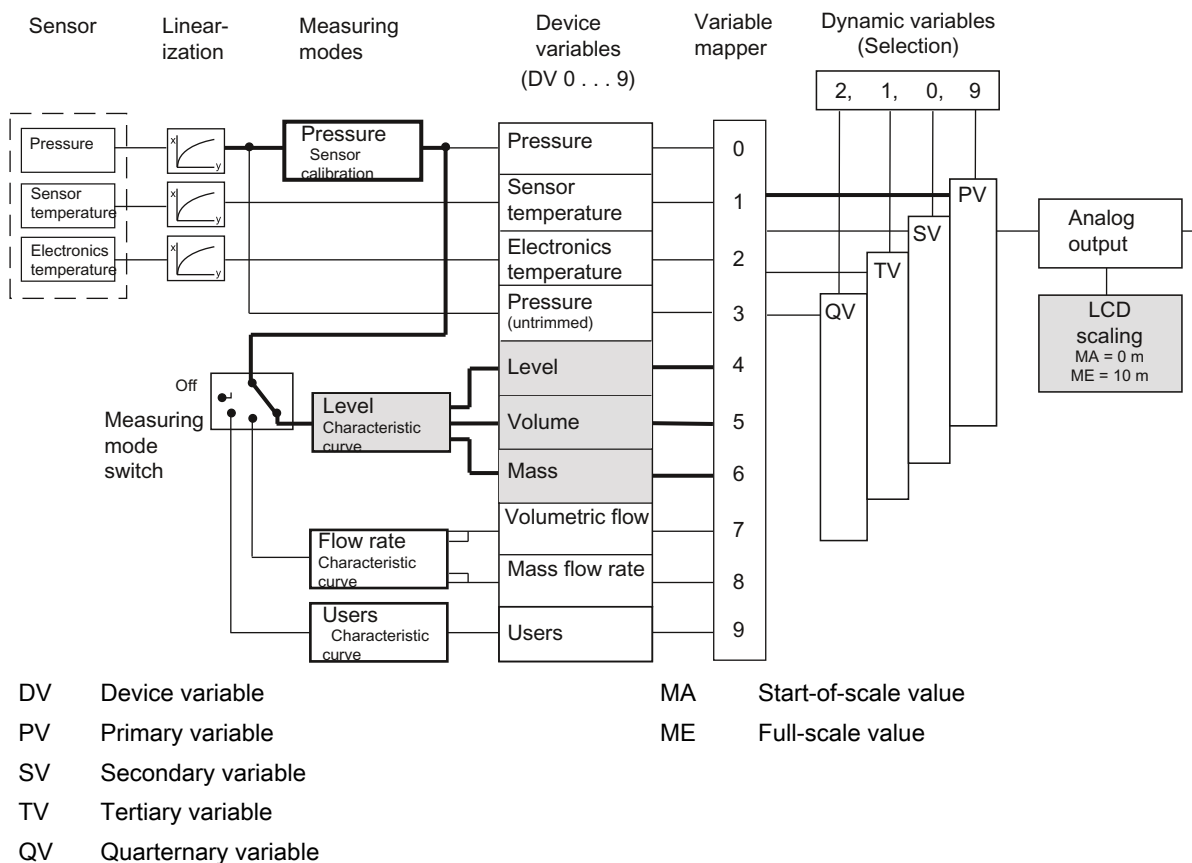

Figure 7-11 Free LCD scaling

7.4 Setting zero point and limit point

You can set the zero point and the limit point using the SIMATIC PDM or HART Communicator. You can use this function to realize rising or falling characteristic curves.

The pressure unit can be set separately for the display and for HART communication.

See also

Difference between setting and adjusting (Page 75)

7.5 Blind setting of zero point and limit point

- The start of scale value and the full scale value can be set without creating a reference pressure.
- Both values can be selected as any point within the sensor limits.
- The maximum downscaling is 1:100, depending on the series and the measuring range.

7.6 Zero point calibration (position correction)

Description

A zero point calibration is used to correct a zero point error resulting from the installation position.

Procedure

- Pressurize the device or evacuate it (at absolute pressure, < 0.1 ‰ of the measuring span).
- Perform the zero point calibration using SIMATIC PDM or the HART Communicator.
- If you do not have a vacuum, perform a trimming of the lower sensor calibration point at a known reference pressure.

 CAUTION
--

For absolute pressure transmitters, the zero point is at vacuum. A zero point calibration with a pressurized transmitter will lead to faulty settings!
--

Note

The effective measuring range is reduced by the amount of the upstream pressure.

Example:

With an upstream pressure of 100 mbar, the effective measuring range of a 1-bar transmitter is reduced to a point between 0 and 0.9 bar.

See also

Trimming the sensor (Page 124)

7.7 Electrical damping

Description

You can set the time constant of electrical damping to a point within a range from 0 to 100 s. It always applies to the "Pressure" device variable (DV0) and thus to the measured values derived from it.

7.8 Fast response mode

Description

This mode is only intended for special applications such as fast recognition of jumps in pressure, e.g. pressure drop in the event of pipe breakage. The internal recording of measured values is sped up at the cost of accuracy. From your point of view, an increased low-frequency noise is caused for the measured value. For this reason, good accuracy can only be achieved by setting the measuring span to the maximum.

7.9 Current sensor

Description

The transmitter can be switched to constant current operation for test purposes. In that case, the current no longer corresponds to the process variable. A "C" will appear in the mode display of the display.

7.10 Fault current

Description

You can use this function to set the size of the lower (< 4 mA) and upper (> 20 mA) fault current. Both signal a hardware/firmware fault, sensor breakage, or that the alarm limit has been reached (diagnostic interrupt). ERROR will in this case appear in the display. You can obtain a detailed guide to the display using SIMATIC PDM or the HART Communicator.

Reference

NAMUR recommendation NE43 dated 03.02.2003
"Standardization of the signal level for the breakdown information of digital transmitters"

See also

Error display (Page 69)

Limit modules (Page 131)

7.11 Setting the current limits

Description

The level of the upper and lower fault current and the upper and lower saturation limits can be freely selected within the preset limits of the current output signal.

The specified accuracy of the current output signal is only valid within the current limits 4 to 20 mA.

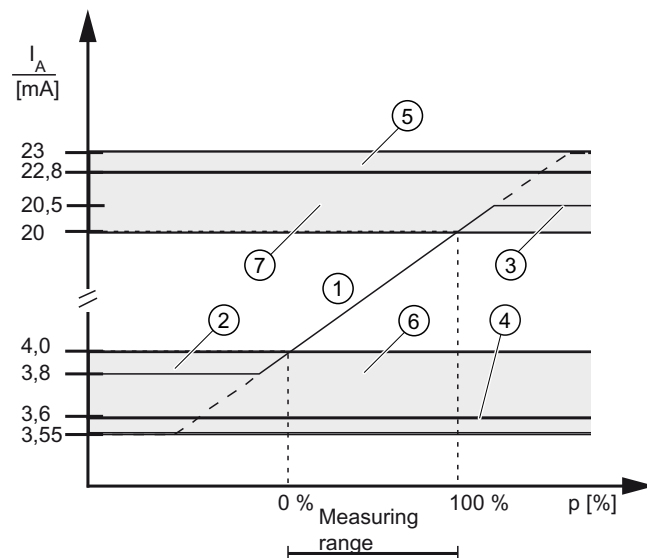

- ① Linear control range
- ② Lower saturation limit (default value)
- ③ Upper saturation limit (default value)
- ④ Lower fault current value (default value)
- ⑤ Upper fault current value (default value)
- ⑥ Recommended setting range for lower fault current range and lower control range limit
- ⑦ Recommended setting range for upper fault current range and upper control range limit

Figure 7-12 Current limits

7.12 Key lock and write protection

Introduction

You can use this function to lock the keys or activate write protection to safeguard the saved parameters.

Lock options

You have the following lock options:

Table 7-3 Meaning of the HART lock modes

Lock mode	Meaning
0	The device can be operated by means of the keys and HART communication.
LA	Keys on the transmitter are locked. Exception: <ul style="list-style-type: none">• Releasing key lock The device can be operated by means of HART communication.
LO	Keys on the transmitter are partially locked. Exception: <ul style="list-style-type: none">• Setting start of scale value• Releasing key lock The device can be operated by means of HART communication.
LS	Keys on the transmitter are partially locked. Exception: <ul style="list-style-type: none">• Setting start of scale value• Setting full scale value• Releasing key lock The device can be operated by means of HART communication.
LL	Write protection You can now only release the lock using HART communication.

See also

buttons and function lock (Page 90)

Releasing key lock or function lock (Page 91)

7.13 Measured value display

Introduction

You can use this function to set one of three options for the device display:

- Display in mA
- Display in % (of the set measuring range)
- Display in a physical unit

Table 7-4 Display of measuring mode/device variables

DV	Description
0	Pressure
1	Sensor temperature
2	Electronics temperature
3	Pressure (untrimmed)
4	Level
5	Volume
6	Mass
7	Volumetric flow rate (not relevant to gauge or absolute pressure)
8	Mass flow rate (not relevant to gauge or absolute pressure)
9	Users

Points to note for "Pressure" DV

If the device variable (DV) is set to "Pressure", you can configure the displayed pressure unit with an extension, GAUGE (G) or ABS (A). The add-on has no effect on the real measured value.

To do so, select the option Gauge or Absolute under the "Pressure display type" menu item.

There are two options for the display:

7.14 Selection of the physical unit

- If the pressure unit is < 5 characters, an A or a G is added at the end, respectively.
- If the pressure unit is ≥ 5 characters, the letters GAUGE or ABS flash alternately with the pressure unit.



Figure 7-13 Add-on with example GAUGE

Note

The change of the display with GAUGE or ABS does not change the physical pressure used by the transmitter, rather only the nature of the display.

See also

Measured value display (Page 94)

7.14 Selection of the physical unit

Introduction

You can use this function to select a unit from a table with predefined units.

Description

The only units available will be those of the device variable that was mapped as the Primary Variable (PV).

The unit can be set separately for the display and for HART communication. You can also choose to link the setting of the two units.

See also

Unit (Page 95)

7.15 Bar graph

Description

You can use this to switch on the "Bar graph" function in the device display as an alternative to the unit display. The "Bar graph" function is disabled in the factory state.

See also

Display elements (Page 67)

7.16 Sensor calibration

7.16.1 Sensor trim

Description

The sensor trim can be used to set the characteristic curve of the transmitter at two sensor trim points. The results are then correct measured values at the sensor trim points. The sensor trim points can be selected as any points within the nominal range.

Devices that are not turned down prior to delivery are trimmed at 0 bar and the upper limit of the nominal range; devices that are turned down prior to delivery are trimmed at the lower and upper limits of the set pressure measuring range.

Application examples

- For a particular device that is not turned down (e.g. 63 bar), the typical measured value is 50 bar. To attain the highest possible accuracy for this value, set the upper sensor calibration at 50 bar.
- A 63-bar transmitter is turned down to 4 to 7 bar. You can attain the highest possible accuracy by selecting 4 bar for the lower sensor calibration point and 7 bar for the upper.
- A 250-mbar absolute pressure transmitter shows 25 mbar at 20 mbar (abs). A reference pressure of 100 mbar is available. You can carry out zero point correction by performing a lower sensor trim at 100 mbar.

Note

The accuracy of the test device should be at least three times as high as that of the transmitter.

7.16.2 Trimming the sensor

Trim the sensor at the lower trim point

The pressure at which the lower sensor trim is to be performed is applied at the transmitter. Via SIMATIC PDM or the HART Communicator, you instruct the transmitter to accept this pressure.

This represents an offset shift of the characteristic curve.

Trim the sensor at the upper trim point

The pressure at which the upper sensor trim is to be performed is applied at the transmitter. Via SIMATIC PDM or the HART Communicator, you instruct the transmitter to accept this pressure.

A gradient correction is thereby applied to the characteristic curve. The lower sensor trim point is not affected by this. The upper trim point needs to be greater than the lower trim point.

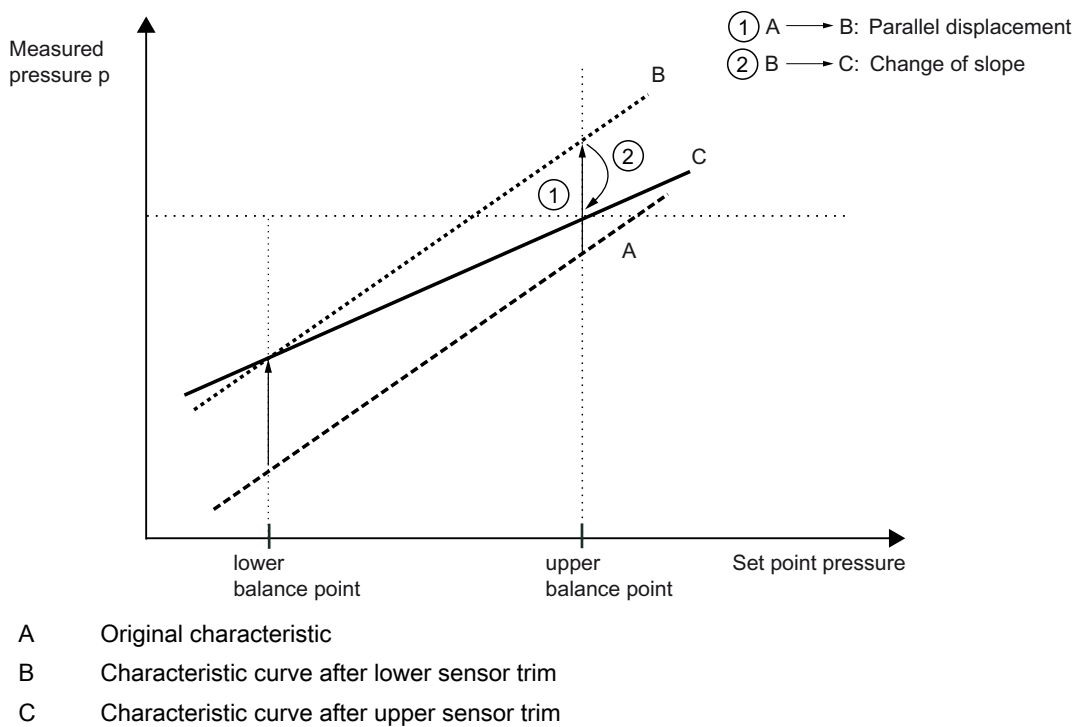

Figure 7-14 Sensor calibration

7.17 Current sensor trim

The current that is output by the transmitter can be trimmed independently of the pressure measuring circuit. This function is designed for compensating inaccuracies in the processing chain following the transmitter.

Example of an application

The current is to be measured as a voltage drop from 1 to 5 V at a resistance of 250 Ohm +/- 5%. To trim the tolerance of the resistance, set the current transmitter so that the voltage drop at 4 mA is exactly 1 V and at 20 mA is exactly 5 V.

- Trim at 4 mA:
Use the current transmitter trim menu option to instruct the transmitter to output 4 mA. Read the measured value at an ammeter and input it. The transmitter uses this value for offset correction of the current.
- Trim at 20 mA:
Use the current transmitter trim menu option to instruct the transmitter to output 20 mA. Read the measured value at an ammeter and input it. The transmitter uses this value for gradient correction of the current. The value for 4 mA is not affected by this.

Note

If a multimeter is used, it must always be sufficiently accurate.

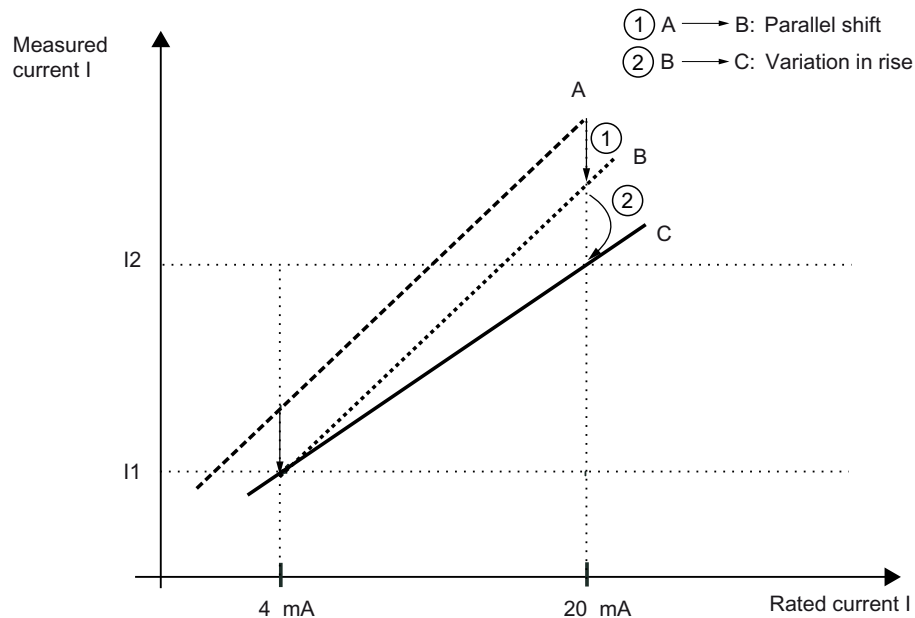

- A Original characteristic
- B Characteristic curve after current transmitter trim 4 mA
- C Characteristic curve after current transmitter trim 20 mA

Figure 7-15 Current transmitter trim

7.18 Factory calibration

Introduction

You can use factory calibration to reset the transmitter to the factory state.

Description

You can use the menu-guided interface of SIMATIC PDM or HART Communicator to select the range of parameters to be reset:

1. Current trim
2. Sensor zero point calibration (position correction)
3. Pressure corrections (zero point calibration and sensor trim)
4. All parameters relevant for the processing of measured values, such as zero point, limit point, electrical damping, display unit, current trim, zero point calibration (position correction), sensor trim, measuring speed, interrupt current limits, interrupt setting, overflow ranges of current.

5. Variable mapper. This performs the following setting:

PV= Pressure, SV= Sensor temp., TV= Electronics temp., QV= Non-linearized pressure

- PV Primary variable
SV Secondary variable
TV Tertiary variable
QV Quarternary variable

See also

Factory calibration - FAQ (<http://support.automation.siemens.com/WWW/view/en/10806940/133000>)

7.19 Static configuration data

Description

A further menu command in the corresponding operating program allows you to read and also write a series of sensor-specific material data. With the factory state, this data is pre-allocated according to the particular device model. These values are not contained in the "Factory calibration" function; in other words, changes in the device are permanently saved.

List of variable material parameters:

- Flange type
- Flange material
- Remote seal type
- Filling medium
- O-ring material
- Remote seal
- Remote seal diaphragm material
- Number of remote seals
- Sensor filling medium

- Sensor seal diaphragm material
- Transmitter model
- Housing material
- Tube length
- Process connection
- Electrical connection
- Process connection screw material
- Vent valve position

For a series of these material data items, you can enter any designation of your choice under the option "Special". This applies to the following parameters:

- Process connection
- Flange type
- Process connection screws
- O-ring material
- Material of vent valve
- Vent valve position
- Remote seal type
- Remote seal
- Diaphragm material
- Remote seal filling medium

You can use up to 16 characters for each entry.

7.20 Flow rate measurement (only differential pressure)

Description

For the "Differential pressure and flow rate" device version, you can select the characteristic curve of output current as follows without actuating the measuring mode selector:

- linear "lin": proportional to differential pressure
- square root extracting "sroff": proportional to flow rate, deactivated up to the application point
- square root extracting "srln": proportional to flow rate, linear up to the application point
- square root extracting "srln2": proportional to flow rate, two-step linear up to the application point

Variable application point

The output current for the "srlin" and "sroff" functions can be displayed linearly or set to zero below the application point of the square root extracting characteristic curve.

Fixed application point

The "srlin2" function has a permanently defined application point of 10%. The range up to this point contains two linear characteristic curve sections. The first section ranges from the zero point to 0.6% of the output value and 0.6% of the pressure value. The second section has a higher gradient and it goes up to the root application point at 10% of the output value and 1% of the pressure value.

See also

Flow rate measurement (only differential pressure) (Page 91)

7.21 Diagnostic functions

7.21.1 Overview

Description

HART communication allows you to activate and evaluate a wide range of diagnostic functions from a central control room or onsite:

- Calibration/service timer
- Min/max indicator
- Limit monitoring modules
- Simulation of measured pressure and temperature values
- Limit monitoring of all device variables

The diagnostics strategy employed for the transmitter incorporates a diagnostic warning and a diagnostic interrupt for diagnostic functions for monitoring limit values, e.g. for monitoring current saturation. This warning and interrupt can be configured:

- Diagnostic warning: The device transmits via HART communication the diagnostic event that has occurred. The current output value is unaffected. The message "Diagnostic Warning" alternates with the unit on the display.
- Diagnostic interrupt: The device goes into the fault current state. The message "Diagnostic Warning" or "Diagnostic Alarm" appears on the display, along with the message ERROR. In addition, the diagnostic event is made available via HART communication.

In the default settings, all warnings and alarms are switched off. You can choose to set either the diagnostic warning only or the diagnostic interrupt and warning. For HART communication, use the HART Communicator or PC software such as SIMATIC PDM. To see the steps

required, refer to the attached table for operation of the HART Communicator or the help functions in the SIMATIC PDM software.

7.21.2 Operating hours counter

Description

An operating hours counter can be read via HART communication for the electronics and another for the sensor. For HART communication, use the HART Communicator or PC software such as SIMATIC PDM. The counters are activated the first time the transmitter is put into operation. If the device is separated from its power supply, the counter readings are automatically stored in the non-volatile memories. That means that the current counter readings can be accessed at the next restart. The operating hours counters cannot be reset.

7.21.3 Calibration timer and service timer

Description

To ensure regular calibration of the electronics and for service work on the sensor, you activate a two-stage timer in each case. On expiry of the first time period, a calibration or service request is made. On expiry of a second time span set by parameter as a time difference, a diagnostic alarm is reported and a fault current is output.

The calibration intervals for the electronics are calculated using the following formula:

$$\text{Calibration interval} = \frac{\text{required accuracy} - \text{probable total error}}{\text{Stability/month}}$$

For performance of the calibration work, you must acknowledge the requests and alarms. Then you can reset the timer. In addition, there is a facility to deactivate the monitoring function.

The following procedure applies for acknowledgement of requests and alarms:

As long as the warning/alarm limit has not been reached, the following applies:

1. "Reset the timer" this resets the timer, which then restarts from 0. The monitoring remains active.
2. "Alarm/Acknowledge the request" this has no effect; the timer continues to run and the monitoring remains active.

When the warning/alarm limit has been reached, the following applies:

1. "Alarm/Acknowledge the request" resets the request / alarm message, but allows the timer to continue to run. In this state, a new alarm or warning is not possible since the time limits have already been exceeded.
2. "Reset timer" resets the request / alarm message, also resets the timer. It acknowledges the interrupt or warning at the same time. The timer immediately starts running again from zero and will report again when the warning/alarm limit is next reached. The next calibration interval is therefore immediately active.

7.21.4 Min/max indicator

Description

The measuring transmitter provides three min/max indicator pairs, which you can use to monitor the three measured variables Pressure, Sensor temperature, and Electronics temperature for negative and positive peak values. For each measured value, a resettable min/max indicator saves the maximum and minimum peak values in long-term storage in the two non-volatile memories. Consequently, the values are available even after the device is restarted. The min/max indicators are also updated during a simulation.

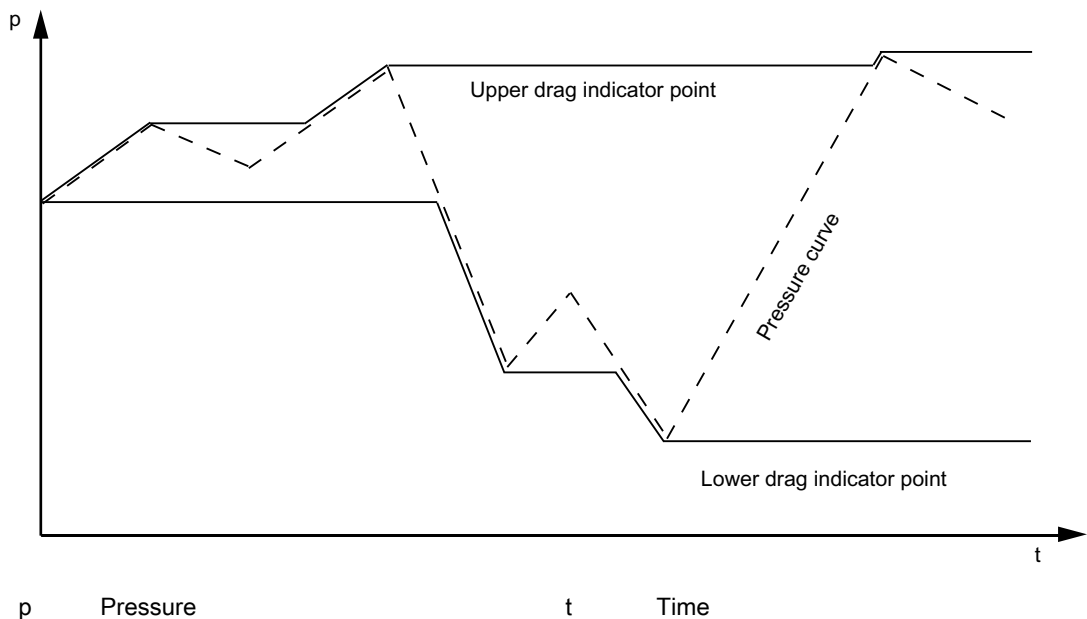

Figure 7-16 Basic representation of min/max indicators

7.21.5 Limit modules

Introduction

The diagnostic functions of this device give you an option to monitor the measured values in programmable limits. If the limits are not adhered to, the device sends a warning through HART communication or notifies a higher-level instance about an analog fault current.

Monitoring of current saturation

You can monitor the current output in the saturation range using a simple limit module. This limit module is configured and activated via HART communication. For HART communication, use a HART communicator or PC software such as SIMATIC PDM.

You need to set two time periods to configure the limit module:

The first time period specifies how long the current output is allowed to be in saturation before an interrupt is triggered and the device outputs its set fault current. This first time period is the response time.

The second time period specifies the duration of the interrupt. This second time period is the stop time.

Different outputs of the fault current corresponding to the set response and stop times are shown in the following example.

Configuring the direction of fault current

The current value is proportional to pressure within the saturation limits. When the saturation limits are exceeded, the direction of fault current can however vary from the direction of saturation. The upper or the lower fault current is displayed depending on the parameter settings of the direction of fault current.

You can configure the direction of fault current for a current saturation interrupt depending on your requirements. The following settings are possible under the current saturation menu:

Active interrupt value	The applicable settings are those under the current interrupt type menu command.
Inverse interrupt value	The applicable settings are the inverse settings under the current interrupt type menu command.
Saturated interrupt value	The fault current is output in the direction of current saturation.
Inverse saturated interrupt value	The fault current is output in the opposite direction to current saturation.

The difference between different settings is evident in examples 3 and 4 in the following figure. Example 3 shows the direction of fault current with the "Saturated current value" setting. Example 4 shows the direction of fault current with the "Active upper interrupt value" setting.

Example

The configured saturation limits in the following figures are 3.8 mA and 20.5 mA.

Example 1: the response time starts at t_1 . At t_1 , current reaches the configured saturation limit of 20.5 mA for the first time. At t_2 , the response time ends. The stop time begins and the interrupt is triggered. Time t_3 is the configured end of the stop time. At t_3 , the interrupt is immediately revoked even if the current then drops below the saturation limit again.

Example 2: the duration of the current saturation is shorter than the response time (t_1, t_2). In that case, the device does not go into "fault current" state.

Example 3: the current drops below the lower saturation limit only for a short time. The fault current is not switched off until after the end of the stop time (t_3). The direction of fault current corresponds to the "Saturated interrupt value" setting. The fault current is output in the direction of current saturation.

Example 4: the current drops below the lower saturation limit only for a short time. The fault current is not switched off until after the end of the stop time (t_3). The direction of fault current corresponds to the "Active upper interrupt value" setting. The upper fault current is outputted although the direction of current saturation is downward.

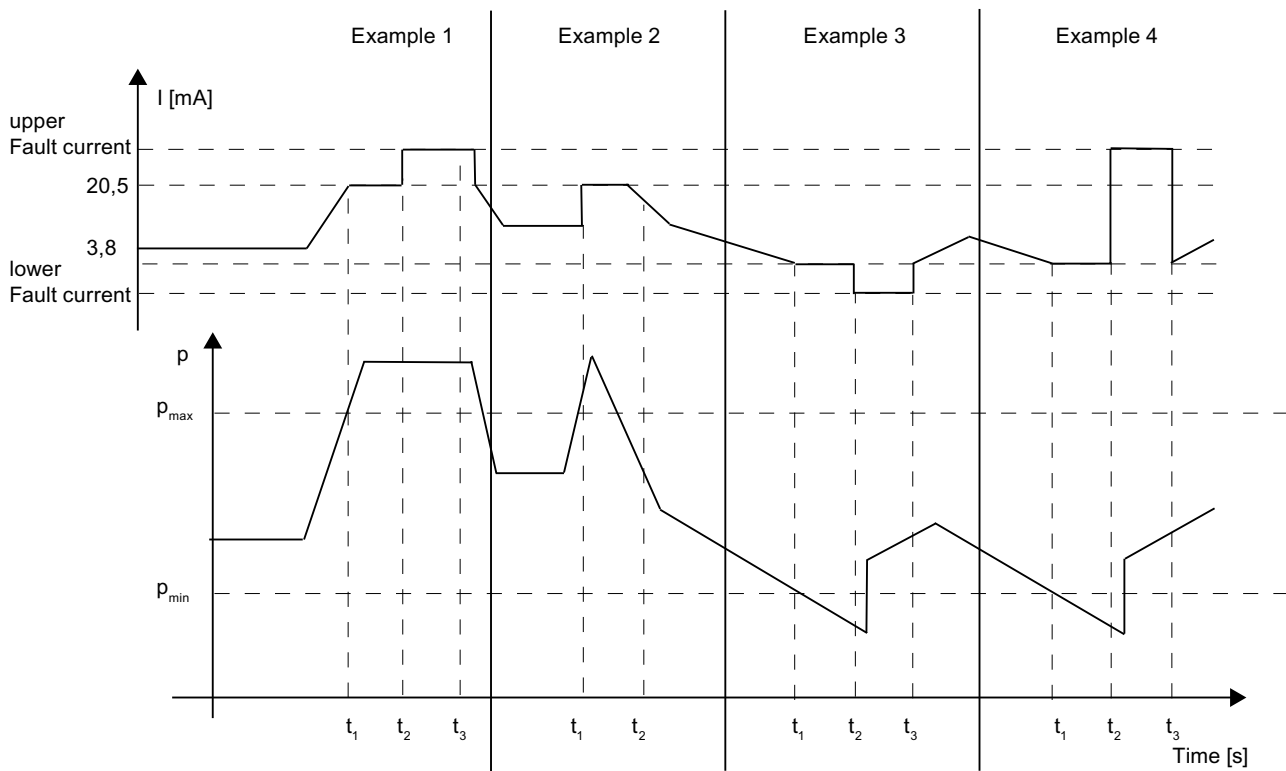

Figure 7-17 Four examples of saturation monitoring

See also

Fault current (Page 118)

7.22 Simulation

7.22.1 Overview of simulation

Description

With the "Simulation" diagnostic function, you can receive and process simulated measurement data onsite or in the control room without having process pressure or a temperature value. This allows you to run individual process sequences in the "cold" state and thus simulate process states. In addition, if you inject simulation values you can test the line routing from the control room to the individual transmitter.

The value to be simulated can be provided as a fixed value or in the form of a ramp function. Simulation of pressure and temperature values is handled in the same way in terms of parameter settings and function, so the following will only deal with the general simulation procedures "Fixed value" and "Ramp function".

For reasons of safety, all simulation data are held only in the non-volatile user memory. This means that when the device is restarted any simulation which may be active will be shut down. You can simulate the pressure and both temperature values. It should be noted here that changing the temperatures by simulation will have no effect on the measured pressure value.

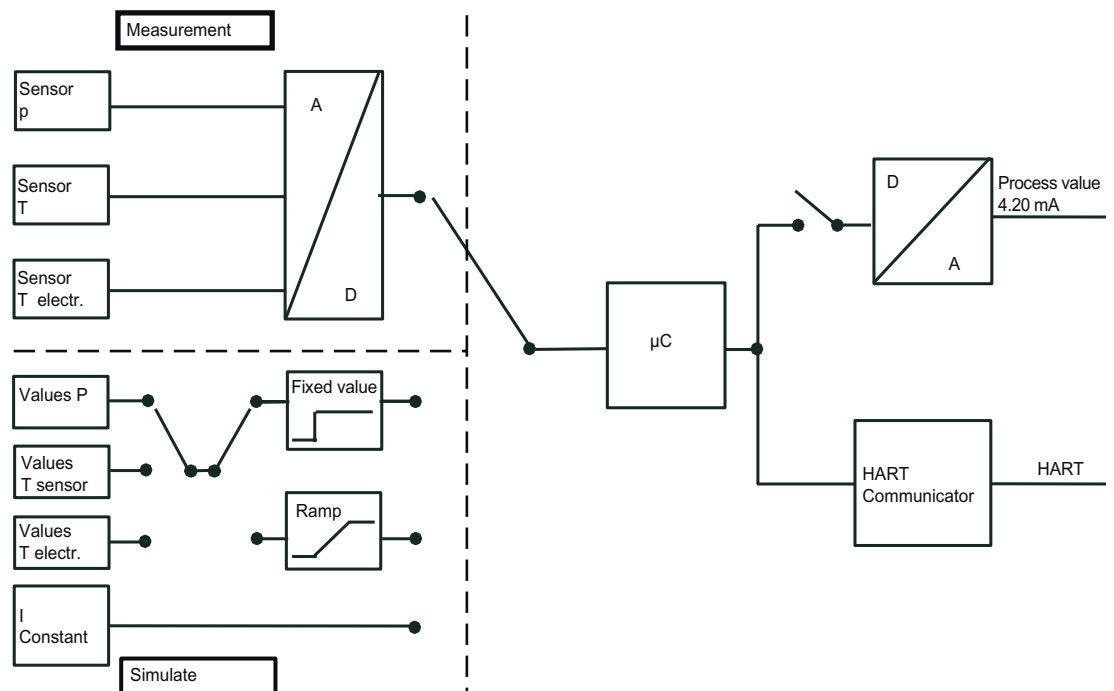

Figure 7-18 Block diagram of simulation

7.22.2 Simulation as fixed value

Description

Taking the physical unit into account you can set a fixed simulation value for all three possible simulation paths. You can simulate the pressure value and both temperature values simultaneously. While pressure simulation is activated, the transmitter will not react to changes in the process pressure. The output value for the current adjusts itself in accordance with the preset pressure value. Simulation of the temperature values has no effect on the current output. It can only be observed via HART communication.

7.22.3 Simulation with a ramp function

Description

In addition to the adjustable fixed values for all three simulation paths, you can, as a second option, also configure one ramp function in each case. Adjustable lower and upper values together determine the limits between which the simulation values with a rising or falling tendency can move. The step width can be calculated with the step number, which is also adjustable. You can specify the rate of rise of the ramp via the duration of the individual ramp steps.

$$\text{Increment} = \frac{\text{Upper range value} - \text{Lower range value}}{\text{Number of steps}}$$

7.23 Limit monitor

Description

You can activate up to three limit monitors in order to monitor any of the device variables. The limit monitor monitors a value at an upper or lower limit value. If this limit is violated it sends a diagnostic warning or a diagnostic interrupt. Select the "Limit Monitor" menu command in SIMATIC PDM or in the HART communicator. You can program the following values for each of the three limit monitors:

Table 7-5 Parameter of the limit monitor

Monitoring variable	You will be shown a list of the active device variables. This list is independent of the measuring mode selected.
Limit monitoring: warning / interrupt	Select whether a warning or a warning plus an interrupt should be triggered when a limit is violated.
Limit monitoring: upper / lower	Specify here whether a device variable monitors the upper limit, the lower limit, or both limits.
Upper limit value	Upper limit value in the unit of the device variable.
Lower limit value	Lower limit value in the unit of the device variable.

Hysteresis	Operating point for chatter suppression in the case of small pressure changes.
Response time	The time which must pass after the limit is violated before this violation is registered.
Stop time	The time for which a limit interrupt or warning will always be sustained even when the event which triggered it is no longer present.

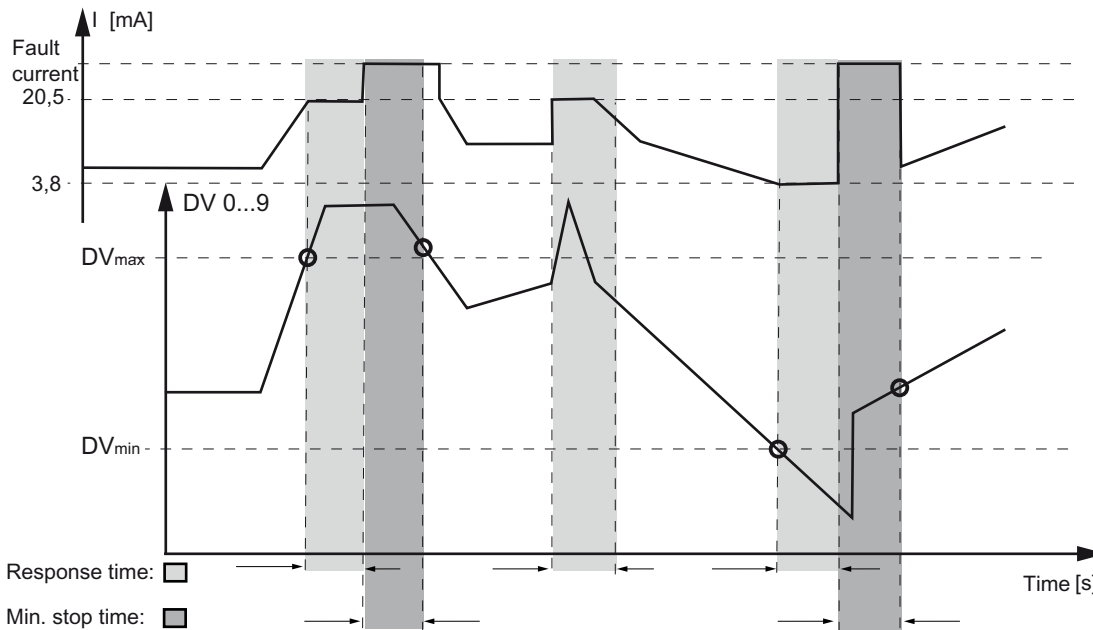

Figure 7-19 Trip levels for the limit monitor

You can count the limit violations for each limit monitor by activating an event counter that provides separate, cumulative totals of upper and lower limit violations. A diagnostic warning and / or a diagnostic interrupt can be issued once a certain number of violations is reached, a number which you can also program. You can program the following values for the event counter:

Table 7-6 Parameters of the event counter

Event counter: upper limit	Select here whether a warning or a warning plus an interrupt should be triggered when the comparison value is exceeded.
Event counter: lower limit	Select here whether a warning or a warning plus an interrupt should be triggered when the comparison value is not met.
Comparison value: upper limit	Specify here the number of overflows at which a warning or a warning plus an interrupt should be triggered.
Comparison value: upper limit	Specify here the number of underflows at which a warning or a warning plus an interrupt should be triggered.
Limit monitoring, warning/interrupt: upper limit	Select whether a warning or a warning plus an interrupt should be triggered when the event counter upper limit is violated.
Limit monitoring, warning/interrupt: lower limit	Select whether a warning or a warning plus an interrupt should be triggered when the event counter lower limit is violated.

7.23 Limit monitor

Reset event counter upper limit	Here you can reset the upper limit counter to zero. A new event is not possible until the counter has been reset.
Reset event counter lower limit	Here you can reset the lower limit counter to zero. A new event is not possible until the counter has been reset.
Warning/interrupt acknowledgement	Here you can acknowledge each warning or interrupt separately.

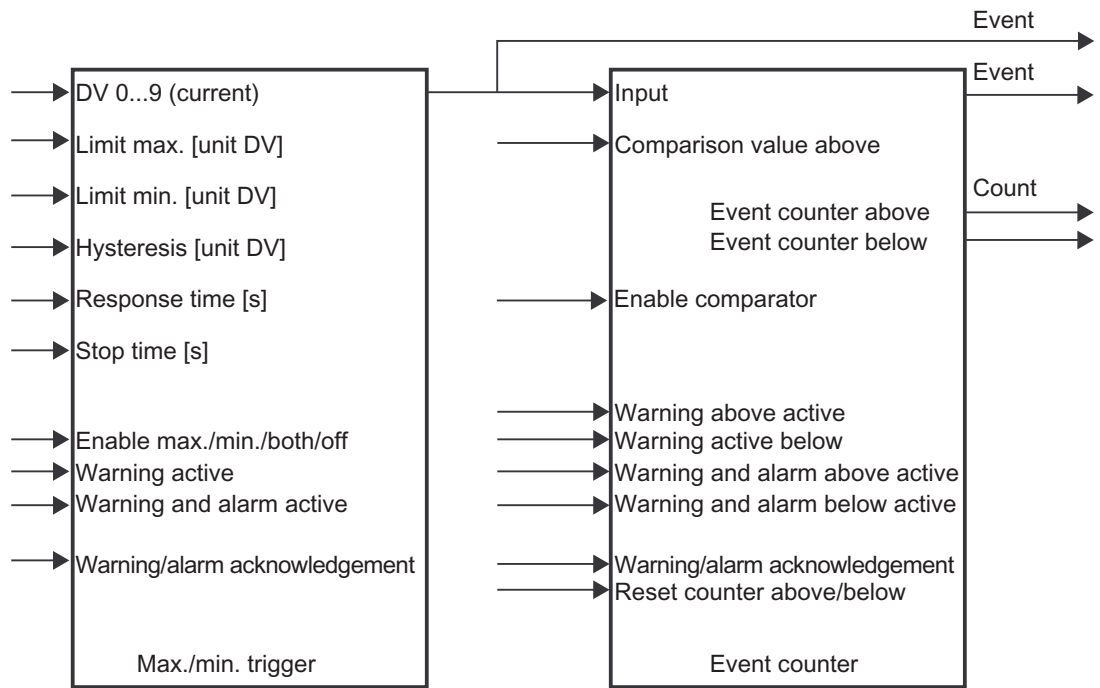

Figure 7-20 Limit monitor and event counter

Messages from the limit monitor and from the event counter can be acknowledged separately. Resetting the event counter starts a new monitoring interval.

Functional safety

8.1 General safety instructions

8.1.1 Safety-instrumented system

This chapter describes the functional safety in general and not specific to a device. The devices in the examples are selected as representative examples. The device-specific information follows in the next chapter.

Description

The combination of transmitter, automation system and final controlling element forms a safety-instrumented system that performs a safety function.

Functional principle of single-channel operation

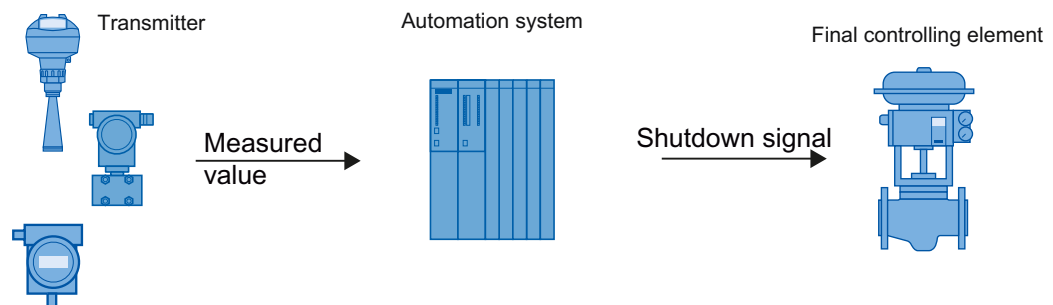

Figure 8-1 Safety-instrumented system for single-channel operation

The transmitter generates a process-related measured value that is transferred to the automation system. The automation system monitors this measured value. If the measured value exceeds the range of the high or low limit, the automation system generates a shutdown signal for the connected final controlling element, which switches the associated valve to the specified safety position.

Function principle of multi-channel operation

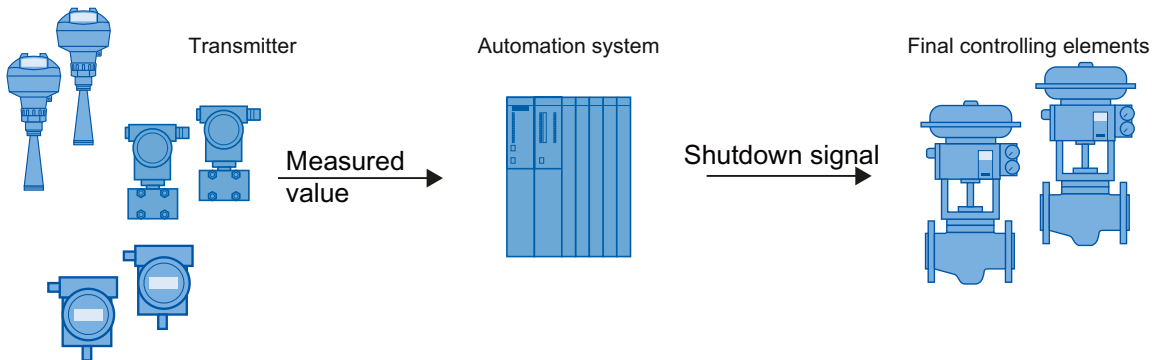

Figure 8-2 Safety-instrumented system (SIL3)

The transmitter generates process-related measured values that are transferred to the automation system. The automation system monitors these measured values. In the event of a fault, the automation system generates shutdown signals for connected final controlling elements that set the associated valve to the defined safety position.

Faults are:

- Violations of the preset high or low limits
- Simultaneously incoming measured values which are different from one another

8.1.2 Safety Integrity Level (SIL)

The international standard IEC 61508 defines four discrete Safety Integrity Levels (SIL) from SIL 1 to SIL 4. Every level corresponds to a probability range for the failure of a safety function.

Description

The following table shows the dependency of the SIL on the "average probability of dangerous failures of a safety function of the entire safety-instrumented system" (PFD_{AVG}) The table deals with "Low demand mode", i.e. the safety function is required a maximum of once per year on average.

Table 8-1 Safety Integrity Level

SIL	Interval
4	$10^{-5} \leq PFD_{AVG} < 10^{-4}$
3	$10^{-4} \leq PFD_{AVG} < 10^{-3}$
2	$10^{-3} \leq PFD_{AVG} < 10^{-2}$
1	$10^{-2} \leq PFD_{AVG} < 10^{-1}$

The "average probability of dangerous failures of the entire safety-instrumented system" (PFD_{AVG}) is normally split between the three sub-systems in the following figure.

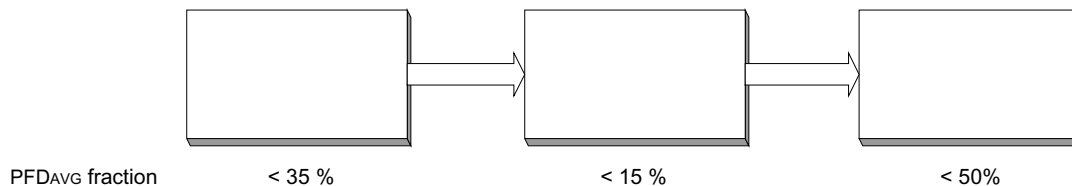

Figure 8-3 PFD distribution

The following table shows the achievable Safety Integrity Level (SIL) for the entire safety-instrumented system for type A/B subsystems depending on the safe failure fraction (SFF) and the hardware fault tolerance (HFT).

- Type A sub-systems include analog transmitters and shut-off valves **without** complex components, e.g. microprocessors (see also IEC 61508, Section 2).
- Type B sub-systems include analog transmitters and shut-off valves **with** complex components, e.g. microprocessors (also see IEC 61508, Section 2).

SFF	HFT for type A sub-system			HFT for type B sub-system		
	0	1	2	0	1 (0) ¹⁾	2 (1) ¹⁾
< 60 %	SIL 1	SIL 2	SIL 3	Not permitted	SIL 1	SIL 2
60 to 90 %	SIL 2	SIL 3	SIL 4	SIL 1	SIL 2	SIL 3
90 to 99 %	SIL 3	SIL 4	SIL 4	SIL 2	SIL 3	SIL 4
> 99 %	SIL 3	SIL 4	SIL 4	SIL 3	SIL 4	SIL 4

¹⁾ Operational reliability in accordance with IEC 61511-1, Section 11.4.4

Operational reliability

According to IEC 61511-1, Section 11.4.4, the hardware fault tolerance (HFT) can be reduced by one (values in brackets) for transmitters and final controlling elements with complex components if the following conditions apply to the device:

- The device is proven in operation.
- The user can configure only the process-related parameters, e.g. control range, signal direction in case of a fault, limiting values, etc.
- The configuration level of the firmware is blocked against unauthorized operation.
- The function requires SIL of less than 4.

8.2 Device-specific safety information for single-channel operation (SIL 2)

8.2.1 Safety function

Safety function for pressure transmitters

The safety function of SITRANS P refers to the measurement of pressures. An additional safety accuracy of 2% of the measuring range (complete span) must be added to the application-specific measuring error for an output current of 4 to 20 mA.

Total tolerance (safety function) = \pm [application-specific measuring error + 2% safety accuracy].

Pressure transmitter safety accuracy: the maximum effect of an uncritical individual error on the measured value.

The diagnostics function will respond within 4 seconds in the worst-case scenario.

Note

Use of remote seals

If remote seals are used, the application-specific measurement error is the product of the transmitter and remote seal measurement errors.

WARNING

Disregarding conditions for fulfilling the safety function

Disregard can result in a malfunction of the process plant or application, e.g. process pressure too high, maximum level exceeded.

The binding settings and conditions are listed in the chapters "Settings (Page 140)" and "Safety characteristics (Page 142)".

These conditions must be strictly observed in order to fulfill the safety function.

8.2.2 Settings

The following settings must be adhered to after installing and commissioning as per the Operating Instructions:

Operation/configuration

While operating/configuring, ensure that the technical data of the pressure transmitter are adhered to in their respective version.

Checking the safety function

Note

You should check the safety function while the device is mounted, if possible. If this is not possible, you can also check the safety function when the device is not mounted. Make sure that the transmitter is mounted in the same position for testing as it is in in the system.

Note

If the transmitter is locked in Mode 10, deactivate the lock to check the safety function.

We recommend that:

- You check the status for warnings and alarms.
- You check the measurement value limits.
- Simulate various currents and the minimum and maximum fault currents.
- Check the measuring accuracy, which must be within the range of the application-specific measuring error for the safety function.
 - Set the measured value display to a unit of pressure in Mode 13.
 - Check the zero point, e.g. in a pressureless state, for gauge and differential pressure.
 - Check the zero point for absolute pressure, e.g. by applying a defined pressure.
 - Check the upper limit of the measuring range (URL) and the upper limit of the span set (URV) for gauge, absolute and differential pressure by applying a defined pressure.
 - Reset the measured value display to the required value in Mode 13.
- Check the triggering of the safety function.

Protection against configuration changes

After parameterizing/commissioning:

1. Set the lock mode in Mode 10 to write protection "L".
Operation via keys and HART communication is blocked.
2. Protect the keys from unintended change in the parameters, e.g. by lead-sealing.

8.2.3 Requirements

Requirements

Functional safety has the following requirements:

- Only one DS III device is required for single-channel operation in accordance with SIL 2.
- Functional safety up to SIL 2 in accordance with IEC 61508/IEC 61511-1. The firmware version is listed in the "SIL Declaration of Conformity".

8.2 Device-specific safety information for single-channel operation (SIL 2)

- Explosion protection for corresponding versions
- Electromagnetic compatibility in compliance with EN 61326

8.2.4 Behavior in case of faults

Repairs

Defective devices should be sent in to the repair department with details of the fault and the cause. When ordering replacement devices, please specify the serial number of the original device. You will find the serial number on the nameplate.

The address of the responsible SIEMENS repair center, contacts, spare parts lists, etc. can be found on the Internet.

8.2.5 Maintenance/Checking

Interval

We recommend that the functioning of the pressure transmitters be checked at regular intervals of one year.

Checking the safety function

Check the safety function as detailed in the chapter Settings (Page 140).

Checking safety

You should regularly check the safety function of the entire safety circuit in accordance with IEC 61508/61511. The testing intervals are determined in calculations for each individual safety circuit in a system (PFD_{AVG}).

Electronics and measuring cell

The safety function of the transmitter is ensured only if you use the electronics, measuring cell, display and connection board delivered by the factory. These components cannot be replaced.

8.2.6 Safety characteristics

The safety characteristics necessary for using the system are listed in the "SIL declaration of conformity". These values apply under the following conditions:

8.3 Device-specific safety information for redundant operation (SIL 3)

- The SITRANS P pressure transmitter is only used in applications with a low demand for the safety function (low demand mode).
- Communication with the HART protocol is used only for the following:
 - Device configuration
 - Reading diagnostics values
 - However, it is not used for operations critical to safety. In particular, the simulation function must not be activated in safety-related operation.
- The safety-related parameters/settings have been entered by local operation or HART communication before commencing safety-related operation. They are checked on the local display.
(see "Settings" section)
- The safety function test has been concluded successfully.
- The transmitter is blocked against unwanted and unauthorized changes/operation.
- The current signal of 4 to 20 mA of the transmitter is evaluated by a safe system.
- Fault rates are calculated on the basis of a Mean Time To Repair (MTTR) of eight hours (order option C20) or 72 hours (order option C23).

See also

Settings (Page 140)

8.3 Device-specific safety information for redundant operation (SIL 3)

8.3.1 Safety function

Safety function for pressure transmitters

The safety function of SITRANS P refers to the measurement of pressures. An additional safety allowance of 2% of the measuring range (complete span) must be added to the application-specific measuring error for an output current of 4 to 20 mA.

Total tolerance (safety function) = \pm [application-specific measuring error + 2% safety allowance].

Pressure transmitter safety allowance: the maximum effect of an uncritical individual error on the measured value.

The diagnostics function will respond within 4 seconds in the worst-case scenario.

Note

Use of remote seals

If remote seals are used, the application-specific measurement error is the product of the transmitter and remote seal measurement errors.

⚠ WARNING

Disregarding conditions for fulfilling the safety function

Disregard can result in a malfunction of the process plant or application, e.g. process pressure too high, maximum level exceeded.

The binding settings and conditions are listed in the chapters "Settings (Page 145)" and "Safety characteristics (Page 147)".

These conditions must be strictly observed in order to fulfill the safety function.

8.3.2 Requirements

Requirements

Functional safety has the following requirements:

- Two DS III devices are required for redundant operation in accordance with SIL 3. Operation with one DS III is not permissible.
- Functional safety up to SIL 3 in accordance with IEC 61508/IEC 61511-1. The firmware version is listed in the "SIL Declaration of Conformity".
- Explosion protection for corresponding versions
- Electromagnetic compatibility in compliance with EN 61326

Description

The sensor, logic unit/control system and final controlling element combine to form a safety-instrumented system, which executes a safety function. The focal point of this description is the sensor. Please refer to the corresponding standards for the requirements placed on the PLC and final controlling element.

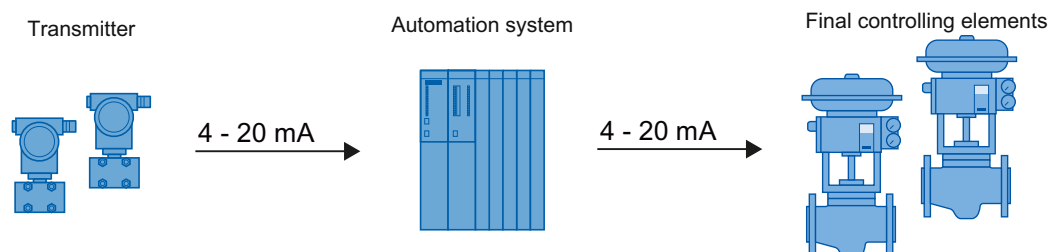

Figure 8-4 Safety-instrumented system in redundant operation

8.3 Device-specific safety information for redundant operation (SIL 3)

The PLC program must monitor the measured values of both DS III devices. As soon as the measured values differ by e.g. 2% or more, the system must be brought into the safe state and the fault must be located.

Note

Switching-off of system at high monitoring accuracy

The two transmitters are connected to the process at different positions. Actual differences in pressure \geq the total tolerance (safety function) can occur when the process is started up or if there are other pressure variations. A difference in pressure \geq the total tolerance (safety function) will shut down the system.

- Match the monitoring accuracy of the PLC to the process.
 - Mount the two transmitters exposed to equal conditions.
-

8.3.3 Settings

Observe the following settings following installing and commissioning as per the Operating Instructions:

Operation/configuration

While operating/configuring, ensure that the technical data of the pressure transmitters in their respective versions is adhered to.

Checking the safety function

Note

You should check the safety function while the device is mounted, if possible. If this is not possible, you can also check the safety function when the device is not mounted. Make sure that the transmitter is mounted in the same position for testing as it is in in the system.

Note

If the transmitter is locked in Mode 10, deactivate the lock to check the safety function.

We recommend for both pressure transmitters:

- You check the status for warnings and alarms.
- You check the measurement value limits.
- Simulate various currents and the minimum and maximum fault currents.

8.3 Device-specific safety information for redundant operation (SIL 3)

- Check the measuring accuracy, which must be within the range of the application-specific measuring error for the safety function.
 - Set the measured value display to a unit of pressure in Mode 13.
 - Check the zero point, e.g. in a pressureless state, for gauge and differential pressure.
 - Check the zero point for absolute pressure, e.g. by applying a defined pressure.
 - Check the upper limit of the measuring range (URL) and the upper limit of the span set (URV) for gauge, absolute and differential pressure by applying a defined pressure.
 - Reset the measured value display to the required value in Mode 13.
- Check the triggering of the safety function.

Protection against configuration changes

After parameterizing/commissioning:

1. Set the lock mode in Mode 10 to write protection "L".
Operation via keys and HART communication is blocked.
2. Protect the keys from unintended change in the parameters, e.g. by lead-sealing.

8.3.4 Behavior in case of faults

Repairs

Defective devices should be sent in to the repair department with details of the fault and the cause. When ordering replacement devices, please specify the serial number of the original device. You will find the serial number on the nameplate.

The address of the responsible SIEMENS repair center, contacts, spare parts lists, etc. can be found on the Internet.

8.3.5 Maintenance/Checking

Interval

We recommend that the functioning of the pressure transmitters be checked at regular intervals of one year.

Checking the safety function

Check the safety function as detailed in the chapter Settings (Page 145).

Checking safety

You should regularly check the safety function of the entire safety circuit in accordance with IEC 61508/61511. The testing intervals are determined in calculations for each individual safety circuit in a system (PFD_{AVG}).

Electronics and measuring cell

The safety function of the transmitter is ensured only if you use the electronics, measuring cell, display and connection board delivered by the factory. These components cannot be replaced.

8.3.6 Safety characteristics

The safety characteristics necessary for using the system are listed in the "SIL Declaration of Conformity". These values apply under the following conditions:

- Two DS III devices are required for redundant operation in accordance with SIL 3. The PLC program must monitor the measured values of both DS III devices. The system must be put into safe mode as soon as the measured values differ too greatly.
- SITRANS P pressure transmitters are only used in applications with a low demand for the safety function (low demand mode).
- Communication with the HART protocol is used only for the following:
 - Device configuration
 - Reading diagnostics values
 - However, it is not used for operations critical to safety. In particular, the simulation function must not be activated in safety-related operation.
- The safety-related parameters/settings have been entered by local operation or HART communication before commencing safety-related operation. They are checked on the local display.
(see the "Settings" section)
- The safety function test has been concluded successfully.
- The transmitters are protected from accidental and unauthorized changes/operation.
- The transmitter current signal of 4 to 20 mA is evaluated by a safe system.
- Fault rates are calculated on the basis of a mean time to recovery (MTTR) of 8 hours (order option C20) or 72 hours (order option C23).

8.4 Add-on parts

This chapter contains safety information for add-on parts.

 WARNING
Add-on parts unsuitable for process medium
Danger of injury or damage to device.
If the process medium is not suitable for the parts which come into contact with it, hot and/or toxic or corrosive substances could be released.
<ul style="list-style-type: none">• Refer to the information in the chapter "Technical data (Page 169)".• Make sure that the add-on parts are suitable for the corresponding application with regard to materials, temperature of process medium, and pressure.

8.4.1 Checking a device with add-on pneumatic block

Procedure

1. Check the connection between the transmitter and pneumatic block and between the pneumatic block and pipelines in the plant for leaks.
2. Observe the safety information and specifications in chapter Installing/mounting (Page 33).
3. Check the following valves for correct positioning and absence of leaks:
 - Process valves
 - Equalizer valve
 - Vent valves
 - Blowout valves or plugs
4. Observe the safety information and specifications in chapter Commissioning (Page 149).

8.4.2 Checking a device with add-on remote seal

Procedure

1. Check the connection between the transmitter and remote seal and between the remote seal and the plant for leaks.
2. Observe the safety information and specifications in chapter Installing/mounting (Page 33).

Commissioning

9.1 Basic safety instructions

 DANGER
<p>Toxic gases and liquids</p> <p>Danger of poisoning when the device is vented.</p> <p>If toxic process media are measured, toxic gases and liquids can be released when the device is vented.</p> <ul style="list-style-type: none">• Before venting ensure that there are no toxic gases and liquids in the device. Take the appropriate safety measures.

 WARNING
<p>Improper commissioning in hazardous areas</p> <p>Device failure or danger of explosion in hazardous areas.</p> <ul style="list-style-type: none">• Do not commission the device until it has been mounted completely and connected in accordance with the information in Chapter "Technical data (Page 169)".• Before commissioning take the effect on other devices in the system into account.

 WARNING
<p>Opening device in energized state</p> <p>Danger of explosion in areas subject to explosion hazard.</p> <ul style="list-style-type: none">• Only open the device in a de-energized state.• Check prior to commissioning that the cover, cover locks, and cable inlets are assembled in accordance with the directives. <p>Exception: Devices having the type of protection "Intrinsic safety Ex i" may also be opened in energized state in hazardous areas.</p>

Note

Hot surfaces

Hot process medium and high ambient temperatures lead to hot surfaces which can cause burns.

- Take corresponding protective measures, for example wear protective gloves.
-

9.2 Introduction to commissioning

Following commissioning, the transmitter is immediately ready for use.

To obtain stable measured values, the transmitter needs to be allowed to warm up for five minutes or so after the power supply is switched on.

The operating data must correspond to the values specified on the nameplate. If you switch on the auxiliary power, the transmitter will operate.

The following commissioning cases are typical examples. Configurations different from those listed here may be meaningful depending on the system configuration.

9.3 gauge pressure, absolute pressure from the differential pressure series and absolute pressure from the gauge pressure series

9.3 gauge pressure, absolute pressure from the differential pressure series and absolute pressure from the gauge pressure series

9.3.1 Commissioning for gases

Usual arrangement

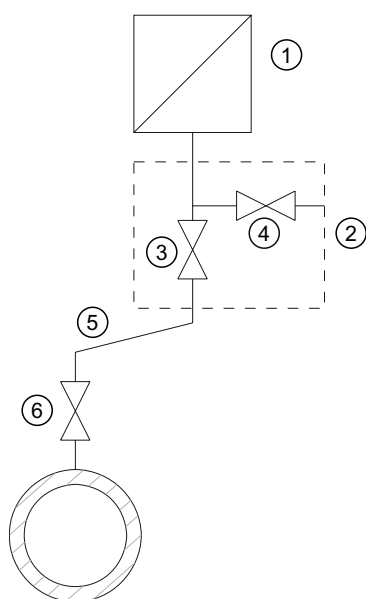

Special arrangement

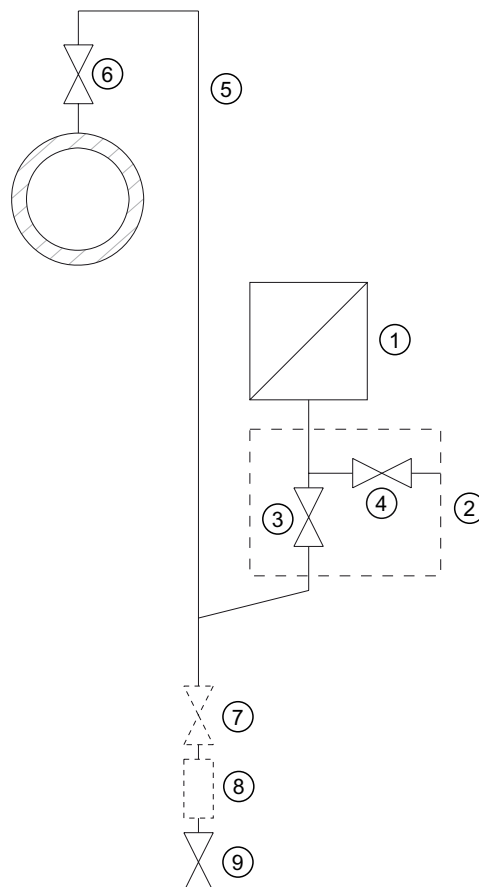

Measuring gases above the pressure tapping point

Measuring gases below the pressure tapping point

- ① Pressure transmitter
- ② Shut-off module
- ③ Shut-off valve to process
- ④ Shut-off valve for test connection or for bleed screw

- ⑤ Pressure line
- ⑥ Shut-off valve
- ⑦ Shut-off valve (optional)
- ⑧ Condensate vessel (optional)
- ⑨ Drain valve

Condition

All valves are closed.

Procedure

To commission the transmitter for gases, proceed as follows:

1. Open the shut-off valve for the test connection ④.
2. Via the test connection of the shut-off fitting ②, apply the pressure corresponding to the start of scale value to the pressure transmitter ①.
3. Check the start of scale value.
4. If the start of scale value differs from the value desired, correct it.
5. Close the shut-off valve for the test connection ④.
6. Open the shut-off valve ⑥ at the pressure tapping point.
7. Open the shut-off valve for the process ③.

9.3.2 Commissioning with steam or liquid

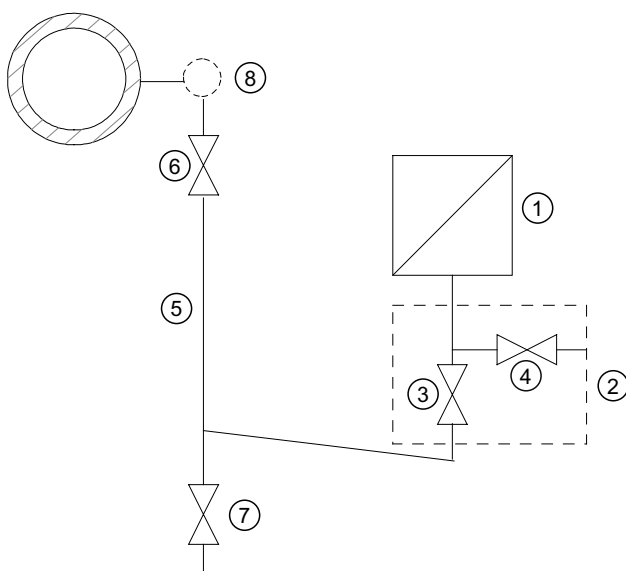

- ① Pressure transmitter
- ② Shut-off fitting
- ③ Shut-off valve to process
- ④ Shut-off valve for test connection or for bleed screw
- ⑤ Pressure line
- ⑥ Shut-off valve
- ⑦ Blow-out valve
- ⑧ Compensation vessel (steam only)

Figure 9-1 Measuring steam

Requirement

All valves are closed.

Procedure

To commission the transmitter for steam or liquid, proceed as follows:

1. Open the shut-off valve for the test connection ④.
2. Via the test connection of the shut-off module ②, apply the pressure corresponding to the start of scale value to the pressure transmitter ①.
3. Check the start of scale value.
4. If the start of scale value differs from the value desired, correct it.
5. Close the shut-off valve for the test connection ④.
6. Open the shut-off valve ⑥ at the pressure tapping point.
7. Open the shut-off valve for the process ③.

9.4 Differential pressure and flow rate

9.4.1 Safety notes for commissioning with differential pressure and flow rate

 WARNING
Incorrect or improper operation If the lock screws are missing or are not sufficiently tight, and/or if the valves are operated incorrectly or improperly, it could lead to serious physical injuries or considerable damage to property. Measure <ul style="list-style-type: none">• Take care that the locking screw and/or the vent valve are screwed in and tightened.• Ensure that the valves are operated correctly and properly.

 WARNING
Hot mediums In the case of hot mediums, the individual operational steps should be carried out one after the other. Otherwise, it could lead to excessive heating, thus causing damage to the valves and the transmitter.

9.4.2 Commissioning in gaseous environments

Usual arrangement

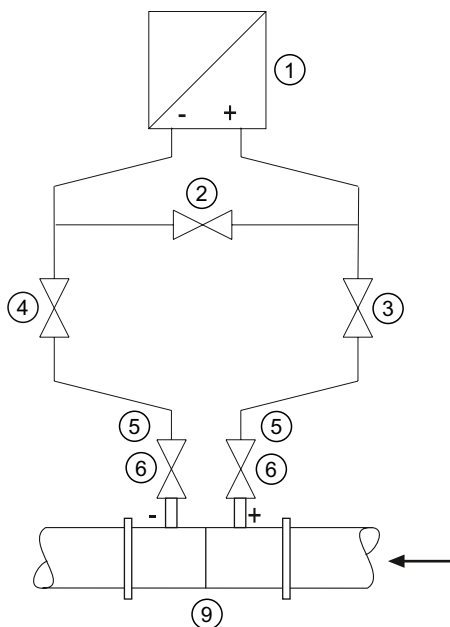

- ① Pressure transmitter
- ② Stabilizing valve
- ③, ④ Differential pressure valves
- ⑤ Differential pressure lines

Transmitter **above** the differential pressure transducer

Special arrangement

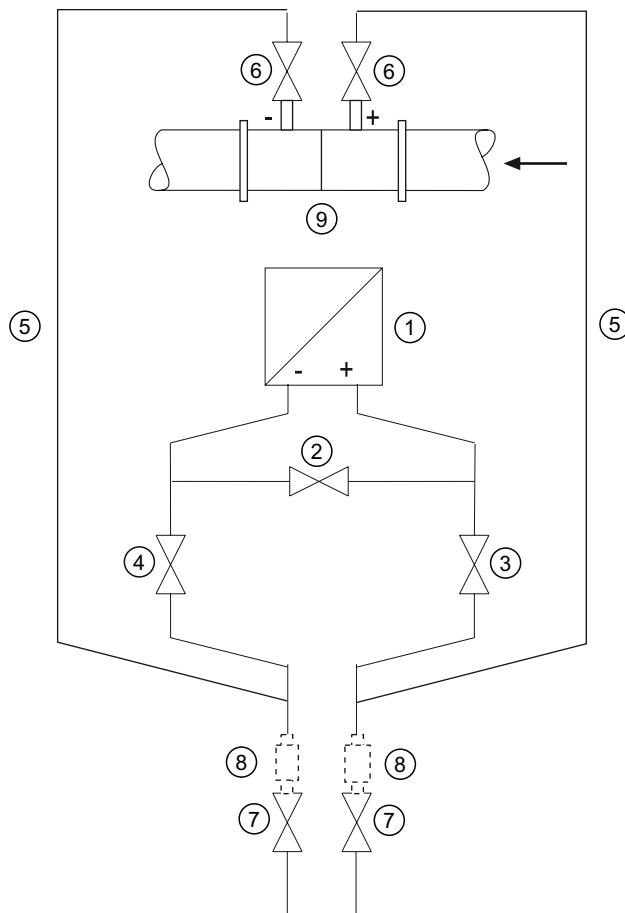

- ⑥ Shut-off valves
- ⑦ Drain valves
- ⑧ Condensate vessels (optional)
- ⑨ Differential pressure transducer

Transmitter **below** the differential pressure transducer

Condition

All shut-off valves are closed.

Procedure

To commission the transmitter for gases, proceed as follows:

1. Open both the shut-off valves ⑥ at the pressure tapping point.
2. Open the stabilizing valve ②.

3. Open the differential pressure valve (③ or ④).
4. Check and if required correct the zero point when the start of scale value is 0 mbar (4 mA).
5. Close the stabilizing valve ②.
6. Open the other differential pressure valve (③ or ④).

9.4.3 Commissioning for liquids

Usual arrangement

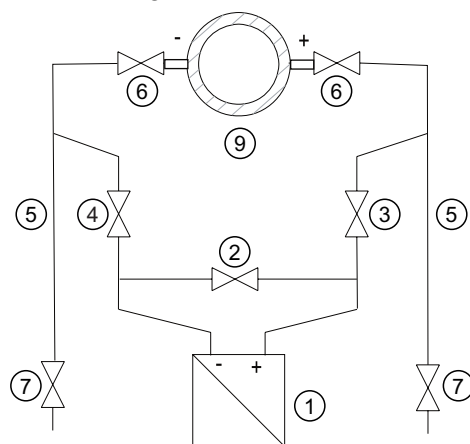

Special arrangement

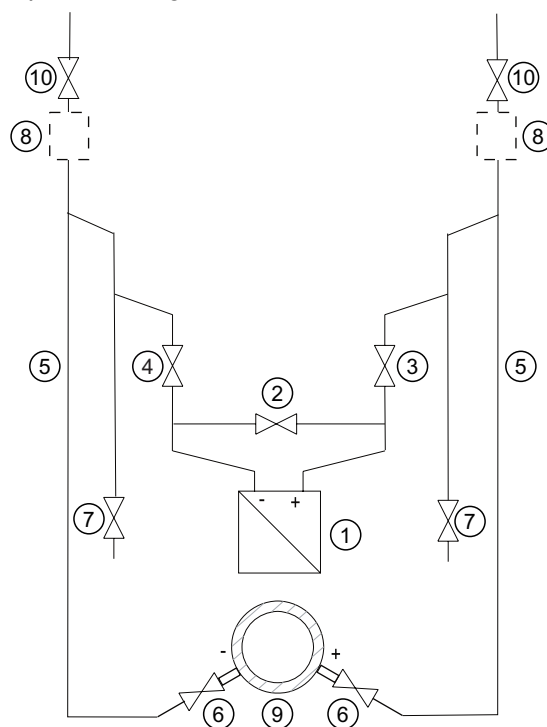

- ① Pressure transmitter
- ② Equalizer valve
- ③, ④ Differential pressure valves
- ⑤ Differential pressure lines
- ⑥ Shut-off valves

Transmitter **below** the differential pressure transducer

- ⑦ Drain valves
- ⑧ Gas collector vessels (optional)
- ⑨ Differential pressure transducer
- ⑩ Vent valves

Transmitter **above** the differential pressure transducer

Condition

All valves are closed.

Procedure



WARNING

The transmitter should not be depressurized if toxic substances are being used.

To commission the transmitter with liquids, proceed as follows:

1. Open both the shut-off valves ⑥ at the pressure tapping point.
2. Open the equalizer valve ②.
3. With **transmitters below the differential pressure transducer**, open both the blowout valves one after the other ⑦ until the air-free liquid emerges.
In the case of a **transmitter above the differential pressure transducer**, open both the vent valves one after the other ⑩ until the liquid emerges.
4. Close both drain valves ⑦ or vent valves ⑩.
5. Open the differential pressure valve ③ and the vent valve on the positive side of the transmitter ① slightly, until fluid escapes without bubbles.
6. Close the vent valve.
7. Open the vent valve on the negative side of the transmitter ① slightly, until fluid escapes without bubbles.
8. Close the differential pressure valve ③.
9. Open the differential pressure valve ④ until the liquid emerges and then close it.
10. Close the vent valve on the negative side of the transmitter ①.
11. Open the differential pressure valve ③ by rotating it in half a turn.
12. Check and if required adjust the zero point (4 mA) if the start-of-scale value is 0 bar.
13. Close the equalizer valve ②.
14. Open the differential pressure valves (③ and ④) completely.

9.4.4 Commissioning with vapor

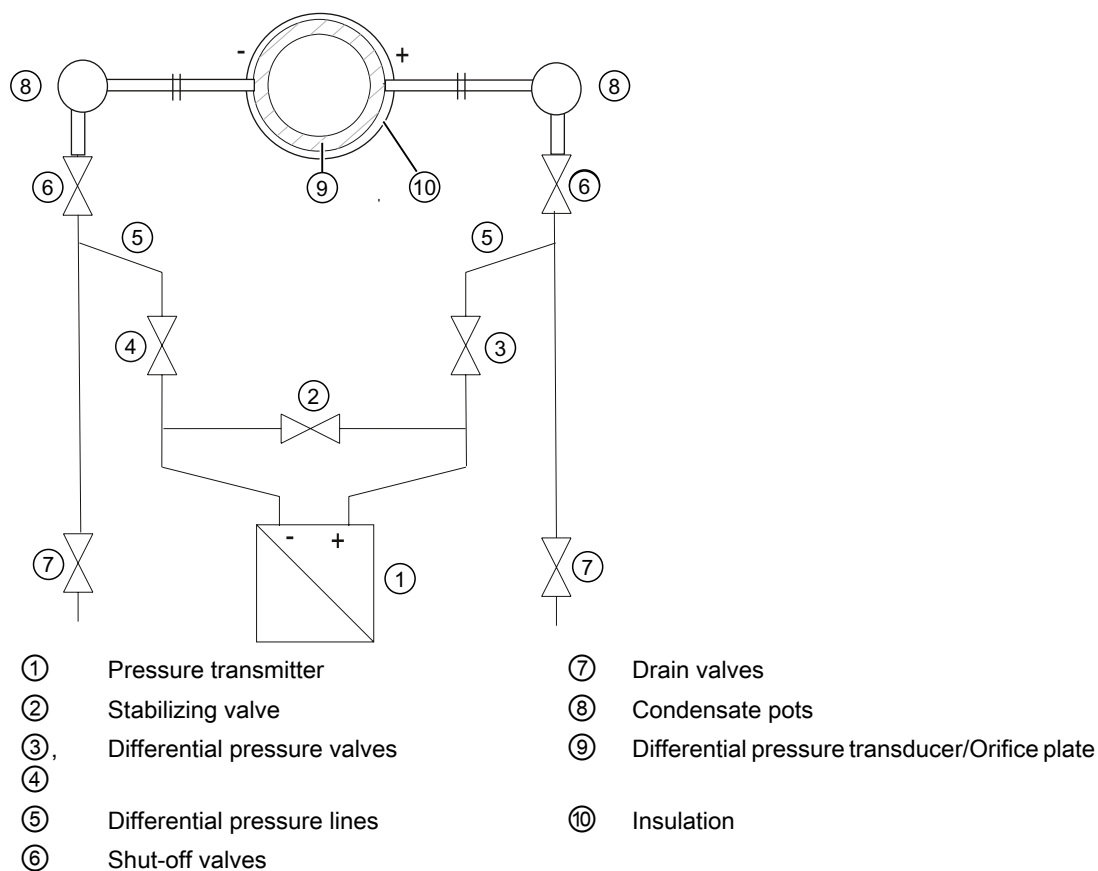

Figure 9-2 Measuring steam

Condition

All valves are closed.

Procedure

NOTICE

The measuring result is error-free only if the differential pressure lines ⑤ have equally high condensate columns with the same temperature. The zero calibration must be repeated if required if these conditions are fulfilled. If the shut-off valves ⑥ and the differential pressure valves ③ are open at the same time and the stabilizing valve ② is opened, there is a possibility of the transmitter ① being damaged due to the streaming vapor.

To commission the transmitter for vapor, proceed as follows:

1. Open both the shut-off valves ⑥ at the pressure tapping point.
2. Open the stabilizing valve ②.

9.4 Differential pressure and flow rate

3. Wait until the steam in the differential pressure lines ⑤ and in the equalizing vessels ⑧ has condensed.
4. Open the differential pressure valve ③ and the vent valve on the positive side of the transmitter ① slightly, until condensate escapes without bubbles.
5. Close the vent valve.
6. Open the vent valve on the negative side of the transmitter ① slightly, until condensate escapes without bubbles.
7. Close the differential pressure valve ③.
8. Open the differential pressure valve ④ slightly, until condensate escapes without bubbles, then close it.
9. Close the vent valve on the negative side ①.
10. Open the differential pressure valve ③ by rotating it in half a turn.
11. Check and if required correct the zero point in case of start of scale value 0 bar (4 mA).
12. Close the stabilizing valve ②.
13. Fully open the differential pressure valves ③ and ④.
14. You can briefly open the drain valves ⑦ to clean the line. Close before steam starts to leak.

Service and maintenance

10.1 Basic safety instructions

 WARNING
Impermissible repair of explosion protected devices Danger of explosion in areas subject to explosion hazard. <ul style="list-style-type: none">• Repair must be carried out by Siemens authorized personnel only.

 WARNING
Impermissible accessories and spare parts Danger of explosion in areas subject to explosion hazard. <ul style="list-style-type: none">• Only use original accessories or original spare parts.• Observe all relevant installation and safety instructions described in the instructions for the device or enclosed with the accessory or spare part.

 WARNING
Use of incorrect device parts in potentially explosive environments Devices and their associated device parts are either approved for different types of protection or they do not have explosion protection. There is a danger of explosion if device parts (such as covers) are used for devices with explosion protection that are not expressly suited for this type of protection. If you do not adhere to these guidelines, the test certificates and the manufacturer warranty will become null and void. <ul style="list-style-type: none">• Use only device parts that have been approved for the respective type of protection in the potentially explosive environment. Covers that are not suited for the "explosion-proof" type of protection are identified as such by a notice label attached to the inside of the cover with "Not Ex d Not SIL".• Do not swap device parts unless the manufacturer specifically ensures compatibility of these parts.

 WARNING
Maintenance during continued operation in a hazardous area
There is a danger of explosion when carrying out repairs and maintenance on the device in a hazardous area.
<ul style="list-style-type: none">• Isolate the device from power.
- or -
<ul style="list-style-type: none">• Ensure that the atmosphere is explosion-free (hot work permit).

 WARNING
Commissioning and operation with pending error
If an error message appears, correct operation in the process is no longer guaranteed.
<ul style="list-style-type: none">• Check the gravity of the error• Correct the error• If the error still exists:<ul style="list-style-type: none">– Take the device out of operation.– Prevent renewed commissioning.

See also

Display in case of a fault (Page 163)

 WARNING
Hot, toxic or corrosive process media
Danger of injury during maintenance work.
When working on the process connection, hot, toxic or corrosive process media could be released.
<ul style="list-style-type: none">• As long as the device is under pressure, do not loosen process connections and do not remove any parts that are pressurized.• Before opening or removing the device ensure that process media cannot be released.

 **WARNING**

Improper connection after maintenance

Danger of explosion in areas subject to explosion hazard.

- Connect the device correctly after maintenance.
- Close the device after maintenance work.

Refer to Chapter "Connecting (Page 57)".

 **WARNING**

Use of a computer in a hazardous area

If the interface to the computer is used in the hazardous area, there is a danger of explosion.

- Ensure that the atmosphere is explosion-free (hot work permit).

 **CAUTION**

Releasing key lock

Improper modification of parameters could influence process safety.

- Make sure that only authorized personnel may cancel the key locking of devices for safety-related applications.

 **CAUTION**

Hot surfaces

Danger of burns during maintenance work on parts having surface temperatures exceeding 70 °C (158 °F).

- Take corresponding protective measures, for example by wearing protective gloves.
- After carrying out maintenance, remount touch protection measures.

 **CAUTION**

Hazardous voltage with open device in versions with 4-conductor extension

Danger of electrocution when the enclosure is opened or enclosure parts are removed.

- Disconnect the device before you open the enclosure or remove enclosure parts.
- Observe the special precautionary measures if maintenance is required while the device is live. Have maintenance work carried out by qualified personnel.

NOTICE
Electrostatic-sensitive devices
The device contains electrostatic-sensitive devices (ESD). ESD can be destroyed by voltages far too low to be detected by humans. These voltages can occur if you simply touch a component part or the electrical connections of a module without being electrostatically discharged. The damage to a module caused by overvoltage cannot normally be detected immediately; it only becomes apparent after a longer period of operating time has elapsed.
Protective measures against the discharge of static electricity:
<ul style="list-style-type: none">• Make sure that no power is applied.• Before working with modules, make sure that you discharge static from your body, for example by touching a grounded object.• Devices and tools used must be free of static charge.• Hold modules only by their edges.• Do not touch connector pins or conductor tracks on a module with the ESD notice.

10.2 Maintenance and repair work

10.2.1 Defining the maintenance interval

 WARNING
No maintenance interval has been defined
Device failure, device damage, and risk of injury.
<ul style="list-style-type: none">• Define a maintenance interval for regular tests in line with device use and empirical values.• The maintenance interval will vary from site to site depending on corrosion resistance.

10.2.2 Checking the gaskets

Inspect the seals at regular intervals

Note**Incorrect seal changes**

Incorrect measured values will be displayed. Changing the seals in a process flange of a differential pressure measuring cell can alter the start-of-scale value.

- Changing seals in devices with differential pressure measuring cells may only be carried out by personnel authorized by Siemens.
-

Note**Using the wrong seals**

Using the wrong seals with flush-mounted process connections can cause measuring errors and/or damage the diaphragm.

- Always use seals which comply with the process connection standards or are recommended by Siemens.
-

1. Clean the enclosure and seals.
2. Check the enclosure and seals for cracks and damage.
3. Grease the seals if necessary.
- or -
4. Replace the seals.

10.2.3 Display in case of a fault

Check the start of scale value of the device from time to time.

Differentiate between the following in case of a fault:

- The internal self test has detected a fault, e.g. sensor break, hardware fault/Firmware fault.
Displays:
 - Display: "ERROR" display and ticker with an error text
 - Analog output: Factory setting: Failure current 3.6 or 22.8 mAOr depending on the parameterization
 - HART: detailed error breakdown for display in the HART communicator or SIMATIC PDM
- Grave hardware faults, the processor is not functioning.
Displays:
 - Display: no defined display
 - Analog output: failure current < 3.6 mA

In case of defect, you can replace the electronic unit by following the warning notes and the provided instruction manual.

See also

Error display (Page 69)

10.2.4 Changing the measuring cell and application electronics

Related

Each of the individual components "Measuring cell" and "Electronics" has a non-volatile memory (EEPROM).

Measuring cell data (e.g.: measuring range, measuring cell material, oil filling) and application-specific electronics data (e.g.: downscaling, additional electrical damping) are located in the measuring cell EEPROM. Application-specific data are lost when the measuring cell is changed. Application-specific data are not lost when the application electronics are changed.

You can backup application-specific data before changing the measuring cell and reload them afterwards. Use an input device which supports the HART protocol. (e.g. HART communicator, PC with HART modem and HART software or PC with HART modem and PDM software). Factory settings will be used if application-specific data are not backed up before the measuring cell is changed.

Technical developments enable advanced functions to be implemented in the firmware of the measuring cell or application electronics. Further technical developments are indicated by modified firmware statuses (FW). The firmware status does not affect whether the modules can be replaced. However, the scope of functions is limited to the function of existing components.

If a combination of certain firmware versions of measuring cell and application electronics is not possible for technical reasons, the device will identify this problem and go into "Fault current" mode. This information is provided via the HART interface.

10.3 Cleaning

 WARNING
Dust layers above 5 mm
Danger of explosion in hazardous areas. Device may overheat due to dust build up.
<ul style="list-style-type: none">• Remove any dust layers in excess of 5 mm.

NOTICE**Penetration of moisture into the device**

Device damage.

- Make sure when carrying out cleaning and maintenance work that no moisture penetrates the inside of the device.

Cleaning the enclosure

- Clean the outside of the enclosure and the display window using a cloth moistened with water or a mild detergent.
- Do not use aggressive cleaning agents or solvents. Plastic components or painted surfaces could be damaged.

**WARNING****Electrostatic charge**

Danger of explosion in hazardous areas if electrostatic charges develop e.g. when cleaning plastic enclosures with a dry cloth.

- Prevent electrostatic charging in hazardous areas.

10.3.1 Servicing the remote seal measuring system

The remote seal measuring system usually does not need servicing.

If the mediums are contaminated, viscous or crystallized, it could be necessary to clean the diaphragm from time to time. Use only a soft brush and a suitable solvent to remove the deposits from the diaphragm. Do not use corrosive cleaning agents. Prevent the diaphragm from getting damaged due to sharp-edged tools.

NOTICE**Improper cleaning of diaphragm**

Device damage. The diaphragm can be damaged.

- Do not use sharp or hard objects to clean the diaphragm.

10.4 Return procedure

Enclose the bill of lading, return document and decontamination certificate in a clear plastic pouch and attach it firmly to the outside of the packaging.

Required forms

- Delivery note
- Return goods delivery note (<http://www.siemens.com/processinstrumentation/returngoodsnote>)
with the following information:
 - Product (item description)
 - Number of returned devices/replacement parts
 - Reason for returning the item(s)
- Decontamination declaration (<http://www.siemens.com/sc/declarationofdecontamination>)
With this declaration you warrant "that the device/replacement part has been carefully cleaned and is free of residues. The device/replacement part does not pose a hazard for humans and the environment."
If the returned device/replacement part has come into contact with poisonous, corrosive, flammable or water-contaminating substances, you must thoroughly clean and decontaminate the device/replacement part before returning it in order to ensure that all hollow areas are free from hazardous substances. Check the item after it has been cleaned. Any devices/replacement parts returned without a decontamination declaration will be cleaned at your expense before further processing.

The forms can be found on the Internet as well as in the documentation which comes with the device.

10.5 Disposal



Devices identified by this symbol may not be disposed of in the municipal waste disposal services under observance of the Directive 2002/96/EC on waste electronic and electrical equipment (WEEE).

They can be returned to the supplier within the EC or to a locally approved disposal service. Observe the specific regulations valid in your country.

Note

Special disposal required

The device includes components that require special disposal.

- Dispose of the device properly and environmentally through a local waste disposal contractor.
-

Technical data

11.1 Overview of technical data

Introduction

The following overview of technical data provides you with a quick and easy access to relevant data and characteristic numbers.

Remember that the tables partially contain the data of the three communication types HART, PROFIBUS and Foundation Fieldbus. This data deviates in many cases. Therefore, adhere to the communication type used by you when using the technical data.

Contents of the chapter

- Input point (Page 170)
- Output (Page 177)
- Measuring accuracy (Page 177)
- Operating conditions (Page 183)
- Construction (Page 187)
- Display, keyboard and auxiliary power (Page 191)
- Certificates and approvals (Page 192)
- HART communication (Page 194)

11.2 Input point

Gauge pressure input						
Measured variable	HART			PROFIBUS PA or Foundation Fieldbus		
	Gauge pressure					
Span (continuously adjustable) or measuring range, max. operating pressure (in accordance with 97/23/EC Pressure Equipment Directive) and max. test pressure (in accordance with DIN 16086) (max. 120 bar for oxygen measurement)	Measuring span	Maximum operating pressure MAWP (PS)	Maximum permissible test pressure	Measuring range	Maximum permissible operating pressure	Maximum test pressure
	0.01 ... 1 bar g (0.15 ... 14.5 psi g)	4 bar g (58 psi g)	6 bar g (87 psi g)	1 bar g (14.5 psi g)	4 bar g (58 psi g)	6 bar g (87 psi g)
	0.04 ... 4 bar g (0.58 ... 58 psi g)	7 bar g (102 psi g)	10 bar g (145 psi g)	4 bar g (58 psi g)	7 bar g (102 psi g)	10 bar g (145 psi g)
	0.16 ... 16 bar g (2.3 ... 232 psi g)	21 bar g (305 psi g)	32 bar g (464 psi g)	16 bar g (232 psi g)	21 bar g (305 psi g)	32 bar g (464 psi g)
	0.63 ... 63 bar g (9.1 ... 914 psi g)	67 bar g (972 psi g)	100 bar g (1450 psi g)	63 bar g (914 psi g)	67 bar g (972 psi g)	100 bar g (1450 psi g)
	1.6 ... 160 bar g (23 ... 2321 psi g)	167 bar g (2422 psi g)	250 bar g (3626 psi g)	160 bar g (2321 psi g)	167 bar g (2422 psi g)	250 bar g (3626 psi g)
	4 ... 400 bar g (58 ... 5802 psi g)	400 bar g (5802 psi g)	600 bar g (8702 psi g)	400 bar g (5802 psi g)	400 bar g (5802 psi g)	600 bar g (8702 psi g)
	7,0 ... 700 bar g (102 ... 10153 psi g)	800 bar g (11603 psi g)	800 bar g (11603 psi g)	700 bar g (10153 psi g)	800 bar g (11603 psi g)	800 bar g (11603 psi g)
Lower measuring limit						
• Measuring cell with silicon oil filling	30 mbar a (0.44 psi a)					
• Measuring cell with inert liquid	30 mbar a (0.44 psi a)					
Upper measuring limit	100% of max. span (max. 120 bar g (1740 psi g) for oxygen measurement)			100% of max. measuring range (max. 120 bar g (1740 psi g) for oxygen measurement)		
Start-of-scale value	between the measuring limits (continuously adjustable)					

gauge pressure input, with flush mounted diaphragm

	HART			PROFIBUS PA or Foundation Fieldbus		
Measured variable	Gauge pressure					
Measuring span (continuously adjustable) or measuring range, max permissible operating pressure and max. permissible test pressure	Span	Maximum operating pressure MAWP (PS)	Maximum test pressure	Measuring range	Maximum operating pressure	Maximum test pressure
	0.01 ... 1 bar g (0.15 ... 14.5 psi g)	4 bar g (58 psi g)	6 bar g (87 psi g)	1 bar g (14.5 psi g)	4 bar g (58 psi g)	6 bar g (87 psi g)
	0.04 ... 4 bar g (0.58 ... 58 psi g)	7 bar g (102 psi g)	10 bar g (145 psi g)	4 bar g (58 psi g)	7 bar g (102 psi g)	10 bar g (145 psi g)
	0.16 ... 16 bar g (2.3 ... 232 psi g)	21 bar g (305 psi g)	32 bar g (464 psi g)	16 bar g (232 psi g)	21 bar g (305 psi g)	32 bar g (464 psi g)
	0.6 ... 63 bar g (9.1 ... 914 psi g)	67 bar g (972 psi g)	100 bar g (1450 psi g)	63 bar g (914 psi g)	67 bar g (972 psi g)	100 bar g (1450 psi g)
Lower measuring limit						
• Measuring cell with silicon oil filling	100 mbar a (1.45 psi a)					
• Measuring cell with inert liquid	100 mbar a (1.45 psi a)					
• Measuring cell with neobee	100 mbar a (13.05 psi a)					
Upper measuring limit	100% of maximum measuring span			100 % of the max. measuring range		

Absolute pressure input, with flush-mounted diaphragm

	HART			PROFIBUS PA or Foundation Fieldbus		
Measured variable	Gauge pressure					
Span (continuously adjustable) or measuring range, max. operating pressure and max. test pressure	Span	Maximum operating pressure MAWP (PS)	Maximum test pressure	Measuring range	Maximum operating pressure	Maximum test pressure
	43 ... 1300 mbar a (17 ... 525 inH ₂ O)	2.6 bar a (37.7 psi a)	10 bar a (145 psi a)	1.3 bar a (18.9 psi a)	2.6 bar a (37.7 psi a)	10 bar a (145 psi a)
	160 ... 5000 mbar a (2.32 ... 72.5 psi a)	10 bar a (145 psi a)	30 bar a (435 psi a)	5 bar a (72.5 psi a)	10 bar a (145 psi a)	30 bar a (435 psi a)
	1 ... 30 bar a (14.5 ... 435 psi a)	45 bar a (653 psi a)	100 bar a (1450 psi a)	30 bar a (435 psi a)	45 bar a (653 psi a)	100 bar a (1450 psi a)
	Depending on the process connection, the span may differ from these values			Depending on the process connection, the measuring range may differ from these values		

Technical data

11.2 Input point

Absolute pressure input, with flush-mounted diaphragm						
HART			PROFIBUS PA or Foundation Fieldbus			
Lower measuring limit	0 bar a (0 psi a)					
Upper measuring limit	100% of maximum span		100 % of max. measuring range			

DS III input with PMC connection						
HART			PROFIBUS PA or Foundation Fieldbus			
Measured variable	Gauge pressure					
Measuring span (continuously adjustable) or measuring range, max permissible operating pressure and max. permissible test pressure	Span	Maximum operating pressure MAWP (PS)	Maximum test pressure	Measuring range	Maximum permissible operating pressure	Maximum permissible test pressure
	0.01 ... 1 bar g (0.15 ... 14.5 psi g) ¹⁾	4 bar g (58 psi g)	6 bar g (87 psi g)	1 bar g (14.5 psi g) ¹⁾	4 bar g (58 psi g)	6 bar g (87 psi g)
	0.04 ... 4 bar g (0.58 ... 58 psi g)	7 bar g (102 psi g)	10 bar g (145 psi g)	4 bar g (58 psi g)	7 bar g (102 psi g)	10 bar g (145 psi g)
	0.16 ... 16 bar g (2.3 ... 232 psi g)	21 bar g (305 psi g)	32 bar g (464 psi g)	16 bar g (232 psi g)	21 bar g (305 psi g)	32 bar g (464 psi g)
Lower measuring limit						
• Measuring cell with silicon oil filling ²⁾	100 mbar a (1.45 psi a)					
• Measuring cell with inert liquid ²⁾	100 mbar a (1.45 psi a)					
• Measuring cell with neobee ²⁾	100 mbar a (13.05 psi a)					
Upper measuring limit	100% of maximum span		100 % of max. measuring range			

¹⁾ 1 bar g (14.5 psi g) only in PMC-Style Standard, not in Minibolt

²⁾ For PMC-Style Minibolt, the measuring span should not be less than 500 mbar

Absolute pressure input (from the gauge pressure series)						
Measured variable	HART			PROFIBUS PA or Foundation Fieldbus		
	Absolute pressure			Measuring range	Maximum operating pressure	Maximum test pressure
Measuring span (continuously adjustable) or measuring range, max permissible operating pressure (as per 97/23/EC pressure device guideline) and max. permissible test pressure (as per DIN 16086)	Span	Maximum operating pressure MAWP (PS)	Maximum test pressure			
	8.3 ... 250 mbar a (3 ... 100 inH ₂ O)	1.5 bar a (21.8 psi a)	6 bar a (87 psi a)	250 mbar a (100 inH ₂ O)	1.5 bar a (21.8 psi a)	6 bar a (87 psi a)
	43 ... 1300 mbar a (17 ... 525 inH ₂ O)	2.6 bar a (37.7 psi a)	10 bar a (145 psi a)	1.3 bar a (18.9 psi a)	2.6 bar a (37.7 psi a)	10 bar a (145 psi a)
	160 ... 5000 mbar a (2.32 ... 72.5 psi a)	10 bar a (145 psi a)	30 bar a (435 psi a)	5 bar a (72.5 psi a)	10 bar a (145 psi a)	30 bar a (435 psi a)
	1 ... 30 bar a (14.5 ... 435 psi a)	45 bar a (653 psi a)	100 bar a (1450 psi a)	30 bar a (435 psi a)	45 bar a (653 psi a)	100 bar a (1450 psi a)
Lower measuring limit						
• Measuring cell with silicon oil filling	0 mbar a (0 psi a)					
• Measuring cell with inert liquid						
for process temperature -20°C < ϑ ≤ 60°C (-4°F < ϑ ≤ +140°F)	30 mbar a (0.44 psi a)					
for process temperature 60°C < ϑ ≤ 100°C (max. 85°C for measuring cell 30 bar) (140°F < ϑ ≤ 212°F (max. 185°F for measuring cell 435 psi))	30 mbar a + 20 mbar a • (ϑ - 60 °C)/°C (0.44 psi a + 0.29 psi a • (ϑ - 108 °F)/°F)					
Upper measuring limit	100% of max. span (max. 120 bar g (1740 psi g) for oxygen measurement)			100% of max. measuring range (max. 120 bar g (1740 psi g) for oxygen measurement)		
Start-of-scale value	between the measuring limits (continuously adjustable)					

Technical data

11.2 Input point

Absolute pressure input (from the differential pressure series)				
	HART		PROFIBUS PA or Foundation Fieldbus	
Measured variable	Absolute pressure			
Measuring span (continuously adjustable) or measuring range and max permissible operating pressure (as per 97/23/EC pressure device guideline)	Span	Maximum operating pressure MAWP (PS)	Measuring range	Maximum operating pressure
	8.3 ... 250 mbar a (3 ... 100 inH ₂ O)	32 bar a (464 psi a)	250 mbar a (100 inH ₂ O)	32 bar a (464 psi a)
	43 ... 1300 mbar a (17 ... 525 inH ₂ O)	32 bar a (464 psi a)	1300 mbar a (525 inH ₂ O)	32 bar a (464 psi a)
	160 ... 5000 bar a (2.32 ... 72.5 psi a)	32 bar a (464 psi a)	5 bar a (72.5 psi a)	32 bar a (464 psi a)
	1 ... 30 bar a (14.5 ... 435 psi a)	160 bar a (2320 psi a)	30 bar a (435 psi a)	160 bar a (2320 psi a)
	5.3 ... 100 bar a (76.9 ... 1450 psi a)	160 bar a (2320 psi a)	100 bar a (1450 psi a)	160 bar a (2320 psi a)
Lower measuring limit				
• Measuring cell with silicon oil filling	0 mbar a (0 psi a)			
• Measuring cell with inert liquid				
for process temperature -20°C < ϑ ≤ 60°C (-4°F < ϑ ≤ +140°F)	30 mbar a (0.44 psi a)			
for process temperature 60°C < ϑ ≤ 100°C (max. 85°C for measuring cell 30 bar) (140°F < ϑ ≤ 212°F (max. 185°F for measuring cell 435 psi))	30 mbar a + 20 mbar a • (ϑ - 60 °C)/°C (0.44 psi a + 0.29 psi a • (ϑ - 108 °F)/°F)			
Upper measuring limit	100% of max. span (max. 120 bar g (1740 psi g) for oxygen measurement)		100% of max. measuring range (max. 120 bar g (1740 psi g) for oxygen measurement)	
Start of scale value	between the measuring limits (continuously adjustable)			

Differential pressure and flow rate input				
	HART		PROFIBUS PA or Foundation Fieldbus	
Measured variable	Differential pressure and flow rate			
Measuring span (continuously adjustable) or measuring range and max permissible operating pressure (as per 97/23/EC pressure device guideline)	Span	Maximum operating pressure MAWP (PS)	Measuring range	Maximum permissible operating pressure
	1 ... 20 mbar (0.4015 ... 8.031 inH ₂ O)	32 bar (464 psi)	20 mbar (8.031 inH ₂ O)	32 bar a (464 psi)
	1 ... 60 mbar (0.4015 ... 24.09 inH ₂ O)	160 bar (2320 psi)	60 mbar (24.09 inH ₂ O)	160 bar (2320 psi)
	2.5 ... 250 mbar (1.004 ... 100.4 inH ₂ O)		250 mbar (100.4 inH ₂ O)	
	6 ... 600 mbar (2.409 ... 240.9 inH ₂ O)		600 mbar (240.9 inH ₂ O)	
	16 ... 1600 mbar (6.424 ... 642.4 inH ₂ O)		1600 mbar (642.4 inH ₂ O)	
	50 ... 5000 mbar (20.08 ... 2008 inH ₂ O)		5 bar (2008 inH ₂ O)	
	0.3 ... 30 bar (4.35 ... 435 psi)		30 bar (435 psi)	
	2.5 ... 250 mbar (1.004 ... 100.4 inH ₂ O)	420 bar (6091 psi)	250 mbar (100.4 inH ₂ O)	420 bar (6091 psi)
	6 ... 600 mbar (2.409 ... 240.9 inH ₂ O)		600 mbar (240.9 inH ₂ O)	
	16 ... 1600 mbar (6.424 ... 642.4 inH ₂ O)		1600 mbar (642.4 inH ₂ O)	
	50 ... 5000 mbar (20.08 ... 2008 inH ₂ O)		5 bar (2008 inH ₂ O)	
	0.3 ... 30 bar (4.35 ... 435 psi)		30 bar (435 psi)	
Lower measuring limit				
• Measuring cell with silicon oil filling	-100% of max. measuring range (-33 % for 30 bar (435 psi) measuring cell) or 30 mbar a (0.44 psi a)			
• Measuring cell with inert liquid				

Technical data

11.2 Input point

Differential pressure and flow rate input				
	HART		PROFIBUS PA or Foundation Fieldbus	
for process temperature of $-20^{\circ}\text{C} < \vartheta \leq 60^{\circ}\text{C}$ ($-4^{\circ}\text{F} < \vartheta \leq +140^{\circ}\text{F}$)	-100% of max. measuring range (-33 % for 30 bar (435 psi) measuring cell) or 30 mbar a (0.44 psi a)			
for process temperature $60^{\circ}\text{C} < \vartheta \leq 100^{\circ}\text{C}$ (max. 85°C for measuring cell 30 bar) ($140^{\circ}\text{F} < \vartheta \leq 212^{\circ}\text{F}$ (max. 185°F for measuring cell 435 psi))	<ul style="list-style-type: none"> -100% of max. measuring range (-33% for 30 bar (435 psi) measuring cell) 30 mbar a + 20 mbar a • $(\vartheta - 60^{\circ}\text{C})/^{\circ}\text{C}$ (0.44 psi a + 0.29 psi a • $(\vartheta - 108^{\circ}\text{F})/^{\circ}\text{F}$) 			
Upper measuring limit	100% of max. span (max. 120 bar g (1740 psi g) for oxygen measurement)		100% of max. measuring range (max. 120 bar g (1740 psi g) for oxygen measurement)	
Start of scale value	between the measuring limits (continuously adjustable)			
Level input				
	HART		PROFIBUS PA or Foundation Fieldbus	
Measured variable	Level			
Measuring span (continuously adjustable) or measuring range and max permissible operating pressure (as per 97/23/EC pressure device guideline)	Span	Maximum operating pressure MAWP (PS)	Measuring range	Maximum permissible operating pressure
	25 ... 250 mbar (10 ... 100 inH ₂ O)	see the mounting flange	250 mbar (100 inH ₂ O)	see the mounting flange
	25 ... 600 mbar (10 ... 240 inH ₂ O)		600 mbar (240 inH ₂ O)	
	53 ... 1600 mbar (21 ... 640 inH ₂ O)		1600 mbar (640 inH ₂ O)	
	160 ... 5000 mbar (2.32 ... 72.5 psi)		5 bar (72.5 psi)	
Lower measuring limit				
• Measuring cell with silicon oil filling	-100% of the max. measuring range or 30 mbar a (0.44 psi a) depending on the mounting flange			
• Measuring cell with inert liquid	-100% of the max. measuring range or 30 mbar a (0.44 psi a) depending on the mounting flange			
Upper measuring limit	100% of maximum span		100 % of max. measuring range	
Start of scale value	between the measuring limits continuously adjustable			

11.3 Output

Output		
	HART	PROFIBUS PA or Foundation Fieldbus
Output signal	4 ... 20 mA	Digital PROFIBUS-PA or Foundation Fieldbus signal
• Lower limit (continuously adjustable)	3.55 mA, set to 3.84 mA in the factory	–
• Upper limit (continuously adjustable)	23 mA, set to 20.5 mA or optionally 22.0 mA in the factory	–
• Ripple (without HART communication)	$I_{SS} \leq 0.5\%$ of the max. output current	–
adjustable time constants damping coefficient	0 ... 100 s, continuously adjustable	0 ... 100 s, continuously adjustable
Adjustable time constants (T63) with local operation	0 ... 100 s, in steps of 0.1 s Factory-set to 2 s	0 ... 100 s, in steps of 0.1 s Factory-set to 2 s
• Current transmitter	3.55 ... 23 mA	–
• Failure signal	3.55 ... 23 mA	–
Load	Resistor R [Ω]	–
• Without HART communication	$R = \frac{U_H - 10,5\text{ V}}{23\text{ mA}}$	–
	U_H Power supply in V	
• With HART communication		–
HART communicator (Handheld)	R = 230 ... 1100 Ω	–
SIMATIC PDM	R = 230 ... 500 Ω	–
Characteristic curve	<ul style="list-style-type: none"> • Linearly increasing or linearly decreasing • Linear increase or decrease or square root extracting increasing (only for DS III differential pressure and flow rate) 	
Bus physics	–	IEC 61158-2
Polarity-independent	–	Yes

11.4 Measuring accuracy

Measuring accuracy (as per EN 60770-1) gauge pressure		
	HART	PROFIBUS PA or Foundation Fieldbus
Reference conditions	<ul style="list-style-type: none"> • Rising characteristic curve • Start of scale value 0 bar • Seal diaphragm: stainless steel • Measuring cell with silicon oil filling • Room temperature 25°C (77°F) 	
	<ul style="list-style-type: none"> • Measuring span ratio r r = maximum measuring span or set measuring span 	–

Technical data

11.4 Measuring accuracy

Measuring accuracy (as per EN 60770-1) gauge pressure		
	HART	PROFIBUS PA or Foundation Fieldbus
Measurement deviation with cut-off point setting, including hysteresis and repeatability.		
Linear characteristic curve		≤ 0,075 %
• $r \leq 10$	≤ (0.0029 • r + 0.071) %	–
• $10 < r \leq 30$	≤ (0.0045 • r + 0.071) %	–
• $30 < r \leq 100$	≤ (0.005 • r + 0.05) %	–
Repeatability	Included in the measuring deviation	
Hysteresis	Included in the measurement deviation	
Settling time T_{63} without electrical damping	approx. 0.2 s	
Long-term drift at ±30°C (±54°F)		In 5 years ≤ 0.25 %
• 1- to 4-bar measuring cell	In 5 years ≤ (0.25 • r) %	
• 16- to 400-bar measuring cell	In 5 years ≤ (0.125 • r) %	
• 700-bar measuring cell	In 5 years ≤ (0.25 • r) %	
Ambient temperature influence	As percentage	
• at -10 ... +60 °C (14 ... 140 °F)	≤ (0.08 • r + 0.1) %	≤ 0,3 %
• at -40 ... -10°C and +60 ... +85 °C (-40 ... 14°F and 140 ... 185°F)	≤ (0.1 • r + 0.15) % per 10 K	≤ 0.25 % per 10 K
Influence of mounting position	≤ 0.05 mbar g (0.000725 psi g) per 10° inclination correction via zero offset	
Power supply influence	In percent per change in voltage 0.005 % per 1 V	–
Measuring value resolution	–	$3 \cdot 10^{-5}$ of the rated measuring range
Gauge pressure measuring accuracy, with flush mounted diaphragm		
	HART	PROFIBUS PA or Foundation Fieldbus
Reference conditions	<ul style="list-style-type: none"> • Rising characteristic curve • Start of scale value 0 bar • Seal diaphragm: stainless steel • Measuring cell with silicon oil filling • Room temperature 25°C (77°F) 	
	<ul style="list-style-type: none"> • Measuring span ratio r r = maximum measuring span or set measuring span 	–
Measurement deviation with limit setting, including hysteresis and repeatability.		
Linear characteristic curve		≤ 0,075 %

Gauge pressure measuring accuracy, with flush mounted diaphragm		
	HART	PROFIBUS PA or Foundation Fieldbus
• $r \leq 10$	$\leq (0.0029 \cdot r + 0.071) \%$	–
• $10 < r \leq 30$	$\leq (0.0045 \cdot r + 0.071) \%$	–
• $30 < r \leq 100$	$\leq (0.005 \cdot r + 0.05) \%$	–
Settling time T_{63} without electrical damping	Approx. 0.2 s	
Long-term drift at $\pm 30^\circ \text{C}$ ($\pm 54^\circ \text{F}$)	In 5 years $\leq (0.25 \cdot r) \%$	In 5 years $\leq 0.25\%$
Ambient temperature influence	In percent	
• At $-10 \dots +60^\circ \text{C}$ ($14 \dots 140^\circ \text{F}$)	$\leq (0.1 \cdot r + 0.2) \%$	$\leq 0,3 \%$
• at $-40 \dots -10^\circ \text{C}$ and $+60 \dots +85^\circ \text{C}$ ($-40 \dots 14^\circ \text{F}$ and $140 \dots 185^\circ \text{F}$)	$\leq (0.1 \cdot r + 0.15) \%$ per 10 K	$\leq 0.25 \%$ per 10 K
Process temperature influence	In pressure per temperature change	
• Temperature difference between process temperature and ambient temperature	3 mbar per 10 K (0.04 psi per 10 K)	
Influence of mounting position	In pressure per change in angle 0.4 mbar (0.006 psi) per 10° inclination Correction via zero offset	
Power supply influence	In percent per change in voltage 0.005 % per 1 V	–
Measured value resolution	–	$3 \cdot 10^{-5}$ of the rated measuring range
Measuring accuracy (as per EN 60770-1) DS III with PMC connection		
	HART	PROFIBUS PA or Foundation Fieldbus
Reference conditions	<ul style="list-style-type: none"> • Rising characteristic curve • Start of scale value 0 bar • Seal diaphragm: stainless steel • Measuring cell with silicon oil filling • Room temperature 25°C (77°F) 	
	<ul style="list-style-type: none"> • Measuring span ratio r $r = \text{maximum measuring span or set measuring span}$ 	–
Measurement deviation with limit setting, including hysteresis and repeatability.		
Linear characteristic curve		$\leq 0,075 \%$
• $r \leq 10$	$\leq (0.0029 \cdot r + 0.071) \%$	–
• $10 < r \leq 30$	$\leq (0.0045 \cdot r + 0.071) \%$	–
• $30 < r \leq 100^*)$	$\leq (0.005 \cdot r + 0.05) \%$	–
Repeatability	Included in the measurement deviation	
Hysteresis	Included in the measurement deviation	
Settling time T_{63} without electrical damping	Approx. 0.2 s	

Technical data

11.4 Measuring accuracy

Measuring accuracy (as per EN 60770-1) DS III with PMC connection		
	HART	PROFIBUS PA or Foundation Fieldbus
Long-term drift at $\pm 30^{\circ}\text{C}$ ($\pm 54^{\circ}\text{F}$)	In 5 years $\leq (0.25 \cdot r) \%$	In 5 years $\leq 0.25\%$
Ambient temperature influence	In percent	
• At $-10 \dots +60^{\circ}\text{C}$ ($14 \dots 140^{\circ}\text{F}$)	$\leq (0.08 \cdot r + 0.1) \%$	$\leq 0,3 \%$
• at $-40 \dots -10^{\circ}\text{C}$ and $+60 \dots +85^{\circ}\text{C}$ ($-40 \dots 14^{\circ}\text{F}$ and $140 \dots 185^{\circ}\text{F}$)	$\leq (0.1 \cdot r + 0.15) \%$ per 10 K	$\leq 0.25 \%$ per 10 K
Process temperature influence	In pressure per temperature change	
• Temperature difference between process temperature and ambient temperature	3 mbar per 10 K (0.04 psi per 10 K)	
Influence of mounting position	In pressure per change in angle $\leq 0.1 \text{ mbar g}$ (0.00145 psi g) per 10° inclination correction via zero offset	
Power supply influence	In percent per change in voltage 0.005% per 1 V	–
Measured value resolution	–	$3 \cdot 10^{-5}$ of the rated measuring range

*) not for 4 bar PMC Minibolt

Absolute pressure measuring accuracy (from gauge and differential pressure series)		
	HART	PROFIBUS PA or Foundation Fieldbus
Reference conditions	<ul style="list-style-type: none"> • Rising characteristic curve • Start of scale value 0 bar • Seal diaphragm: stainless steel • Measuring cell with silicon oil filling • Room temperature 25°C (77°F) 	
	<ul style="list-style-type: none"> • Measuring span ratio r r = maximum measuring span or set measuring span 	–
Measurement deviation with limit setting, including hysteresis and repeatability.		
Linear characteristic curve		$\leq 0,1 \%$
• $r \leq 10$	$\leq 0,1 \%$	–
• $10 < r \leq 30$	$\leq 0,2 \%$	–
Settling time T_{63} without electrical damping	approx. 0.2 s	
Long-term drift at $\pm 30^{\circ}\text{C}$ ($\pm 54^{\circ}\text{F}$)	per year $\leq (0.1 \cdot r) \%$	per year $\leq 0.1 \%$
Ambient temperature influence	In percent	
• At $-10 \dots +60^{\circ}\text{C}$ ($14 \dots 140^{\circ}\text{F}$)	$\leq (0.1 \cdot r + 0.2) \%$	$\leq 0,3 \%$
• at $-40 \dots -10^{\circ}\text{C}$ and $+60 \dots +85^{\circ}\text{C}$ ($-40 \dots 14^{\circ}\text{F}$ and $140 \dots 185^{\circ}\text{F}$)	$\leq (0.1 \cdot r + 0.15) \%$ per 10 K	$\leq 0.25 \%$ per 10 K

Absolute pressure measuring accuracy (from gauge and differential pressure series)		
	HART	PROFIBUS PA or Foundation Fieldbus
Influence of mounting position	In pressure per change of angle <ul style="list-style-type: none"> for absolute pressure (from the gauge pressure series): 0.05 mbar (0.000725 psi) per 10° inclination for absolute pressure (from the differential pressure series): 0.7 mbar (0.001015 psi) per 10° inclination Correction via zero offset	
Power supply influence	In percent per change in voltage 0.005 % per 1 V	–
Measured value resolution	–	$3 \cdot 10^{-5}$ of the rated measuring range
Differential pressure and flow rate measuring accuracy		
	HART	PROFIBUS PA or Foundation Fieldbus
Reference conditions	<ul style="list-style-type: none"> Rising characteristic curve Start of scale value 0 bar Seal diaphragm: stainless steel Measuring cell with silicon oil filling Room temperature 25°C (77°F) 	
	<ul style="list-style-type: none"> Measuring span ratio r r = maximum measuring span or set measuring span 	–
Measurement deviation with limit setting, including hysteresis and repeatability.		
Linear characteristic curve		$\leq 0,075$
<ul style="list-style-type: none"> $r \leq 10$ 	$\leq (0.0029 \cdot r + 0.071) \%$	–
<ul style="list-style-type: none"> $10 < r \leq 30$ 	$\leq (0.0045 \cdot r + 0.071) \%$	–
<ul style="list-style-type: none"> $30 < r \leq 100$ 	$\leq (0.005 \cdot r + 0.05) \%$	–
Square root extracting characteristic curve (flow rate > 50%)		$\leq 0,1 \%$
<ul style="list-style-type: none"> $r \leq 10$ 	$\leq 0,1 \%$	–
<ul style="list-style-type: none"> $10 < r \leq 30$ 	$\leq 0,2 \%$	–
square root extracting characteristic curve (flow rate 25 ... 50%)		$\leq 0,2 \%$
<ul style="list-style-type: none"> $r \leq 10$ 	$\leq 0,2 \%$	–
<ul style="list-style-type: none"> $10 < r \leq 30$ 	$\leq 0,4 \%$	–
Settling time T_{63} without electrical damping	<ul style="list-style-type: none"> approx. 0.2 s approx 0.3 s for measuring cell 20 and 60 mbar (0.29 and 0.87 psi) 	
Long-term drift at $\pm 30^\circ\text{C}$ ($\pm 54^\circ\text{F}$)	$\leq (0.25 \cdot r) \%$ per five years static pressure max. 70 bar g (1015 psi g)	$\leq 0.25 \%$ per five years static pressure max. 70 bar g (1015 psi g)
<ul style="list-style-type: none"> 20 mbar (0.29 psi) measuring cell 	$\leq (0.2 \cdot r) \%$ per year	$\leq 0.2 \%$ per year
<ul style="list-style-type: none"> 250, 600, 1600 and 5000 mbar (0.29, 0.87, 2.32 and 7.25 psi) measuring cell 	$\leq (0.125 \cdot r) \%$ every 5 years	$\leq 0.125\%$ every 5 years

Technical data

11.4 Measuring accuracy

Differential pressure and flow rate measuring accuracy		
	HART	PROFIBUS PA or Foundation Fieldbus
Effect of the ambient temperature (double values for measuring cell 20 mbar g (0.29 psi g))	As percentage	
• At -10 ... +60°C (14 ... 140°F)	$\leq (0.08 \cdot r + 0.1) \%$	$\leq 0,3 \%$
• At -40 ... -10°C and +60 ... +85°C (-40 ... 14°F and 140 ... 185°F)	$\leq (0.1 \cdot r + 0.15) \%$ per 10 K	$\leq 0.25 \%$ per 10 K
Effect of static pressure		
• At the start of scale value	$\leq (0.1 \cdot r) \%$ per 70 bar (1015 psi)	$\leq 0.1\%$ per 70 bar (1015 psi)
Measuring cell 20 mbar (0.29 psi)	$\leq (0.15 \cdot r) \%$ per 32 bar (464 psi)	$\leq 0.15 \%$ per 32 bar (464 psi)
• On the measuring span	$\leq 0.15 \%$ per 70 bar (1015 psi)	-
Measuring cell 20 mbar (0.29 psi)	$\leq 0.2 \%$ per 32 bar (464 psi)	-
Influence of mounting position	In pressure per change of angle ≤ 0.7 mbar (0.001015 psi) per 10° inclination Correction via zero offset	
Power supply influence	In percent per change in voltage 0.005 % per 1 V	-
Measured value resolution	-	$3 \cdot 10^{-5}$ of the rated measuring range
Level measuring accuracy		
	HART	PROFIBUS PA or Foundation Fieldbus
Reference conditions	<ul style="list-style-type: none"> • Rising characteristic curve • Start of scale value 0 bar • Seal diaphragm: stainless steel • Measuring cell with silicon oil filling • Room temperature 25°C (77°F) 	
	<ul style="list-style-type: none"> • Measuring span ratio r r = maximum measuring span or set measuring span 	-
Measurement deviation with limit setting, including hysteresis and repeatability.		
Linear characteristic curve		$\leq 0,075$
• $r \leq 10$	$\leq 0,15 \%$	-
• $10 < r \leq 30$	$\leq 0,3 \%$	-
• $30 < r \leq 100$	$\leq (0.0075 \cdot r + 0.075) \%$	-
Settling time T_{63} without electrical damping	approx. 0.2 s	
Long-term drift at $\pm 30^\circ\text{C}$ ($\pm 54^\circ\text{F}$)	$\leq (0.25 \cdot r) \%$ per five years static pressure max. 70 bar g (1015 psi g)	$\leq 0.25 \%$ per five years static pressure max. 70 bar g (1015 psi g)
Ambient temperature influence	As percentage	
• At -10 ... +60°C (14 ... 140°F) (0.4 instead of 0.2 at $10 < r \leq 30$)		

Level measuring accuracy		
	HART	PROFIBUS PA or Foundation Fieldbus
Measuring cell 250 mbar (3.63 psi)	$\leq (0.5 \cdot r + 0.2) \%$	$\leq 0,7 \%$
Measuring cell 600 mbar (8.7 psi)	$\leq (0.3 \cdot r + 0.2) \%$	$\leq 0,5 \%$
Measuring cell 1.6 and 5 bar (23.2 and 72.5 psi)	$\leq (0.25 \cdot r + 0.2) \%$	$\leq 0,45 \%$
<ul style="list-style-type: none"> At -40 ... -10°C and +60 ... +85°C (-40 ... 14°F and 140 ... 185°F) (double values for $10 < r \leq 30$) 		
Measuring cell 250 mbar (3.63 psi)	$\leq (0.25 \cdot r + 0.15) \%/10 \text{ K}$ $(\leq (0.25 \cdot r + 0.15) \%/18^\circ\text{F})$	$\leq 0.4 \%/10 \text{ K} (\leq 0.4 \%/18^\circ\text{F})$
Measuring cell 600 mbar (8.7 psi)	$\leq (0.15 \cdot r + 0.15) \%/10 \text{ K}$ $(\leq (0.15 \cdot r + 0.15) \%/18^\circ\text{F})$	$\leq 0.3 \%/10 \text{ K} (\leq 0.3 \%/18^\circ\text{F})$
Measuring cell 1.6 and 5 bar (23.2 and 72.5 psi)	$\leq (0.12 \cdot r + 0.15) \%/10 \text{ K}$ $(\leq (0.12 \cdot r + 0.15) \%/18^\circ\text{F})$	$\leq 0.27 \%/10 \text{ K} (\leq 0.27 \%/18^\circ\text{F})$
Effect of static pressure		
<ul style="list-style-type: none"> At the start of scale value 		
Measuring cell 250 mbar (0.29 psi)	$\leq (0.3 \cdot r) \%$ per nominal pressure	$\leq 0.3 \%$ per nominal pressure
Measuring cell 600 mbar (8.7 psi)	$\leq (0.15 \cdot r) \%$ per nominal pressure	$\leq 0.15 \%$ per nominal pressure
Measuring cell 1.6 and 5 bar (23.2 and 72.5 psi)	$\leq (0.1 \cdot r) \%$ per nominal pressure	$\leq 0.1 \%$ per nominal pressure
<ul style="list-style-type: none"> On the measuring span 	$\leq (0.1 \cdot r) \%$ per nominal pressure	$\leq 0.1 \%$ per nominal pressure
Influence of mounting position	depending on the fill fluid in the mounting flange	
Power supply influence	In percent per change in voltage 0.005 % per 1 V	
Measuring value resolution	-	$3 \cdot 10^{-5}$ of the rated measuring range

11.5 Operating conditions

Rated conditions for gauge pressure and absolute pressure (from the gauge pressure series)	
Installation conditions	
Ambient conditions	
<ul style="list-style-type: none"> Ambient temperature 	
Note	Observe the temperature class in hazardous areas.
Measuring cell with silicon oil filling	-40 ... +85 °C (-40 ... +185 °F)
Measuring cell with inert liquid	-20 ... +85 °C (-4 ... +185 °F)
Display	-30 ... +85 °C (-22 ... +185 °F)
Storage temperature	-50 ... +85 °C (-58 ... +185 °F)
<ul style="list-style-type: none"> Climate class 	
Condensation	Permitted

Technical data

11.5 Operating conditions

Rated conditions for gauge pressure and absolute pressure (from the gauge pressure series)

• Degree of protection in accordance with EN 60529	IP65, IP68
• Degree of protection in accordance with NEMA 250	NEMA 4X
• Electromagnetic Compatibility	
Interference emission and interference immunity	As per EN 61326 and NAMUR NE 21

Medium conditions

• Process temperature	
Measuring cell with silicon oil filling	-40 ... +100 °C (-40 ... +212 °F)
Measuring cell with inert liquid filling	-20 ... +100 °C (-4 ... +212 °F)
With extension to Zone 0	-20 ... +60 °C (-4 ... +140 °F)

Conditions of use for gauge pressure and absolute pressure with flush-mounted diaphragm

Installation conditions

Ambient temperature

Note Observe the temperature class in explosive atmospheres.

• Measuring cell with silicon oil filling	-40 ... +85 °C (-40 ... +185 °F)
• Measuring cell with inert liquid filling	-20 ... +85 °C (-4 ... +185 °F)
• Measuring cell with Neobee (FDA-compliant)	-10 ... +85 °C (14 ... 185 °F)
• Display	-30 ... +85 °C (-22 ... +185 °F)
• Storage temperature	-50 ... +85 °C (-58 ... +185 °F) (for Neobee: -20 ... +85 °C (-4 ... +185 °F)) (for high-temperature oil: -10 ... +85 °C (14 ... 185 °F))

Climate class

Condensation	permitted
• Degree of protection in accordance with EN 60 529	IP65, IP68
• Degree of protection in accordance with NEMA 250	NEMA 4X

Electromagnetic compatibility

• Emitted interference and interference immunity	In accordance with EN 61326 and NAMUR NE 21
--	---

Process medium conditions

Process medium temperature¹⁾

• Measuring cell with silicon oil filling	-40 ... +150°C (-40 ... +302 °F) -40 ... +200°C (-40 ... +392 °F) with cooling extension
• Measuring cell with inert liquid filling	-20 ... +100 °C (-4 ... +212 °F) -20 ... +200°C (-4 ... +392 °F) with cooling extension

Conditions of use for gauge pressure and absolute pressure with flush-mounted diaphragm

- Measuring cell with Neobee (FDA-compliant) -10 ... +150°C (14 ... 302 °F)
-10 ... +200°C (14 ... 392 °F) with cooling extension
- Measuring cell with high-temperature oil filling -10 ... +250 °C (14 ... 482 °F) with cooling extension

¹⁾ Observe the temperature limits in the process connection standards (e.g. DIN 32676 and DIN 11851) for the maximum process medium temperature for flush-mounted process connections.

Rated conditions DS III with PMC connection

Installation conditions

Ambient temperature

Note Observe the temperature class in hazardous areas.

- Measuring cell with silicon oil filling -40 ... +85 °C (-40 ... +185 °F)
- Display -30 ... +85 °C (-22 ... +185 °F)
- Storage temperature -50 ... +85 °C (-58 ... +185 °F)

Climate class

- Condensation Permitted
- Degree of protection in accordance with EN 60529 IP65, IP68
- Degree of protection in accordance with NEMA 250 NEMA 4X

Electromagnetic compatibility

- Emitted interference and interference immunity In accordance with EN 61326 and NAMUR NE 21

Process medium conditions

- Process medium temperature -40 ... +100 °C (-40 ... +212 °F)

Rated conditions for absolute pressure (from the differential pressure series), differential pressure and flow rate

Installation conditions

- Installation instruction any

Ambient conditions

- Ambient temperature

Note Observe the temperature class in hazardous areas.

- Measuring cell with silicon oil filling -40 ... +85 °C (-40 ... +185 °F)
- Measuring cell 30 bar (435 psi)
 - -40 ... +85°C (-40 ... +185 °F)
 - for flow rate: -20 ... +85°C (-4 ... +185 °F)

Measuring cell with inert liquid filling -20 ... +85 °C (-4 ... +185 °F)

Display -30 ... +85 °C (-22 ... +185 °F)

Storage temperature -50 ... +85 °C (-58 ... +185 °F)

- Climate class

Condensation Permitted

Technical data

11.5 Operating conditions

Rated conditions for absolute pressure (from the differential pressure series), differential pressure and flow rate	
• Degree of protection in accordance with EN 60529	IP65, IP68
• Degree of protection in accordance with NEMA 250	NEMA 4X
• Electromagnetic compatibility	
Emitted interference and interference immunity	In accordance with EN 61326 and NAMUR NE 21
Process medium conditions	
• Process medium temperature	
Measuring cell with silicon oil filling	-40 ... +100 °C (-40 ... +212 °F)
• Measuring cell 30 bar (435 psi)	<ul style="list-style-type: none"> • -40 ... +85 °C (-40 ... +185 °F) • With flow: -20 ... +85 °C (-4 ... +185 °F)
Measuring cell with inert liquid filling	-20 ... +100 °C (-4 ... +212 °F)
• Measuring cell 30 bar (435 psi)	<ul style="list-style-type: none"> • -40 ... +85 °C (-40 ... +185 °F) • With flow: -20 ... +85 °C (-4 ... +185 °F)
In conjunction with dust explosion protection	-20 ... +60°C (-4 ... +140°F)
Rated conditions for level	
Installation conditions	
• Installation instruction	specified through the flange
Ambient conditions	
• Ambient temperature	
Note	Observe the allocation of the max. permissible operating temperature to the max. permissible operating pressure of the relevant flange connection.
Measuring cell with silicon oil filling	-40 ... +85 °C (-40 ... +185 °F)
Display	-30 ... +85 °C (-22 ... +185 °F)
Storage temperature	-50 ... +85 °C (-58 ... +185 °F)
• Climate class	
Condensation	Permitted
• Degree of protection in accordance with EN 60529	IP65
• Degree of protection in accordance with NEMA 250	NEMA 4X
• Electromagnetic compatibility	
Emitted interference and interference immunity	In accordance with EN 61326 and NAMUR NE 21
Medium conditions	
• Process temperature	
Measuring cell with silicon oil filling	<ul style="list-style-type: none"> • Plus side: see the mounting flange • Minus side: -40 ... +100°C (-40 ... +212°F)

11.6 Construction

Construction for gauge pressure and absolute pressure (from the gauge pressure series)			
Weight	Approx. 1.5 kg (3.3 lb) for aluminum enclosure		
Material			
<ul style="list-style-type: none"> Wetted parts materials 			
Process connection	Stainless steel, mat. no. 1.4404/316L or Hastelloy C4, mat. no. 2.4610		
Oval flange	Stainless steel, mat. no. 1.4404/316L		
Seal diaphragm	Stainless steel, material no. 1.4404/316L or Hastelloy C276, material no. 2.4819		
<ul style="list-style-type: none"> Non-wetted parts materials 			
Electronics housing	<ul style="list-style-type: none"> Copper-free die cast aluminum GD-AISi 12 or stainless steel precision casting, mat. no. 1.4408 Standard: Polyester-based paint Option: 2 coats: Coat 1: epoxy-based; coat 2: polyurethane Stainless steel nameplate 		
Mounting bracket	Steel or stainless steel		
Measuring cell filling	<ul style="list-style-type: none"> Silicone oil Neobee M20 Inert liquid (max. 120 bar g (2320 psi g) for oxygen measurement) 		
Process connection	G $\frac{1}{2}$ B connection pin in accordance with DIN EN 837-1; $\frac{1}{2}$ -14 NPT female thread or oval flange (PN 160 (MAWP 2320 psi g)) with M10 fastening screw thread in accordance with DIN 19213 or $\frac{7}{16}$ -20 UNF in accordance with EN 61518. Male thread M20 x 1.5 and $\frac{1}{2}$ -14 NPT.		
Electrical connection	Cable inlet using the following cable glands: <ul style="list-style-type: none"> Pg 13.5 M20 x 1.5 and $\frac{1}{2}$-14 NPT or Han 7D/Han 8D connector¹⁾ <ul style="list-style-type: none"> Cable diameter: 6 to 12 mm; types of protection "nA" and "ic" (Zone 2): 8 to 12 mm or a suitable cable gland for smaller diameters M12 connector 		
Torque for cable gland nut made of	Plastic	Metal	Stainless steel
	2.5 Nm (1.8 ft lb)	4.2 Nm (3.1 ft lb)	4.2 Nm (3.1 ft lb)

¹⁾ Han 8D is identical to Han 8U.

Construction for gauge pressure, with flush mounted diaphragm	
Weight	Approx 1.5 ... 13.5 kg (3.3 ... 30 lb) with aluminum enclosure
Material	
<ul style="list-style-type: none"> Wetted parts materials 	
Process connection	Stainless steel, mat. no. 1.4404/316L
Seal diaphragm	Stainless steel, mat. no. 1.4404/316L
<ul style="list-style-type: none"> Non-wetted parts materials 	

Technical data

11.6 Construction

Construction for gauge pressure, with flush mounted diaphragm

Electronics housing	<ul style="list-style-type: none"> • Non-copper aluminum die casting GD-AISI 12 or stainless steel precision casting, mat. no. 1.4408 • Standard: Polyester-based paint Option: 2 coats: Coat 1: epoxy-based; coat 2: polyurethane • Stainless steel nameplate 						
Mounting bracket	Steel or stainless steel						
Measuring cell filling	<ul style="list-style-type: none"> • Silicone oil • Neobee M20 • Inert liquid 						
Process connection	<ul style="list-style-type: none"> • Flanges as per EN and ASME • F&B and Pharma flange, clamp and threaded connectors • NEUMO BioConnect/BioControl • PMC connections for the paper industry 						
Electrical connection	Cable inlet using the following cable glands: <ul style="list-style-type: none"> • Pg 13.5 • M20x1.5 • ½-14 NPT • Han 7D/Han 8D plug¹⁾ • M12 connector 						
Torque for cable gland nut made of	<table border="1"> <thead> <tr> <th>Plastic</th> <th>Metal</th> <th>Stainless steel</th> </tr> </thead> <tbody> <tr> <td>2.5 Nm (1.8 ft lb)</td> <td>4.2 Nm (3.1 ft lb)</td> <td>4.2 Nm (3.1 ft lb)</td> </tr> </tbody> </table>	Plastic	Metal	Stainless steel	2.5 Nm (1.8 ft lb)	4.2 Nm (3.1 ft lb)	4.2 Nm (3.1 ft lb)
Plastic	Metal	Stainless steel					
2.5 Nm (1.8 ft lb)	4.2 Nm (3.1 ft lb)	4.2 Nm (3.1 ft lb)					

¹⁾ Han 8D is identical to Han 8U.

DS III construction with PMC connection

Weight	Approx. 1.5 kg (3.3 lb) for aluminum enclosure
Material	<ul style="list-style-type: none"> • Wetted parts materials
Gasket (standard)	PTFE flat gasket
O-ring (minibolt)	<ul style="list-style-type: none"> • FPM (Viton) • FFPM or NBR (optional)
Seal diaphragm	Hastelloy C276, mat. No. 2.4819
Non-wetted parts materials	<ul style="list-style-type: none"> • Non-wetted parts materials
Electronics housing	<ul style="list-style-type: none"> • Non-copper aluminum die casting GD-AISI 12 or stainless steel precision casting, mat. no. 1.4408 • Standard: Polyester-based paint Option: 2 coats: Coat 1: epoxy-based; coat 2: polyurethane • Stainless steel nameplate
Mounting bracket	Steel or stainless steel
Measuring cell filling	<ul style="list-style-type: none"> • Silicone oil • Inert liquid
Process connection	

DS III construction with PMC connection

<ul style="list-style-type: none"> • Standard 	<ul style="list-style-type: none"> • Flush mounted • 1½" • PMC Standard design
<ul style="list-style-type: none"> • Minibolt 	<ul style="list-style-type: none"> • Flush mounted • 1" • PMC Minibolt design

Electrical connection	Cable inlet using the following cable glands: <ul style="list-style-type: none"> • Pg 13.5 • M20 x 1.5 • ½-14 NPT • Han 7D/Han 8D plug¹⁾ • M12 connector
-----------------------	--

Torque for cable gland nut made of	Plastic	Metal	Stainless steel
	2.5 Nm (1.8 ft lb)	4.2 Nm (3.1 ft lb)	4.2 Nm (3.1 ft lb)

¹⁾ Han 8D is identical to Han 8U.

Design for absolute pressure (from the differential pressure series), differential pressure and flow rate

Weight	Approx. 4.5 kg (9.9 lb) for aluminum enclosure
--------	--

Material	
----------	--

<ul style="list-style-type: none"> • Wetted parts materials 	
Seal diaphragm	Stainless steel, mat. no. 1.4404/316L, Hastelloy C276, mat. no. 2.4819, Monel, mat. no. 2.4360, tantalum or gold
Pressure caps and locking screw	Stainless steel, mat. no. 1.4408 to PN 160, mat. no. 1.4571/316Ti for PN 420, Hastelloy C4, 2.4610 or Monel, mat. no. 2.4360
O-ring	FPM (Viton) or optionally: PTFE, FEP, FEPM and NBR

<ul style="list-style-type: none"> • Non-wetted parts materials 	
Electronics housing	<ul style="list-style-type: none"> • Non-copper aluminum die casting GD-AISi 12 or stainless steel precision casting, mat. no. 1.4408 • Standard: Polyester-based paint Option: 2 coats: Coat 1: epoxy-based; coat 2: polyurethane • Stainless steel nameplate
Pressure cap screws	Stainless steel
Mounting bracket	Steel or stainless steel

Measuring cell filling	<ul style="list-style-type: none"> • Silicone oil • Neobee M20 • Inert liquid (max. 120 bar g (2320 psi g) for oxygen measurement)
------------------------	---

Process connection	¹ / ₄ -18 NPT female thread and flat connection with ⁷ / ₁₆ -20 UNF fastening screw thread in accordance with EN 61518 or M10 fastening screw thread in accordance with DIN 19213 (M12 for PN 420 (MAWP 6092 psi))
--------------------	--

Technical data

11.6 Construction

Design for absolute pressure (from the differential pressure series), differential pressure and flow rate

Electrical connection	Screw terminals Cable inlet using the following cable glands: <ul style="list-style-type: none"> • Pg 13.5 • M20 x 1.5 • ½-14 NPT or Han 7D/Han 8D connector¹⁾ • M12 connector 		
Torque for cable gland nut made of	Plastic	Metal	Stainless steel
	2.5 Nm (1.8 ft lb)	4.2 Nm (3.1 ft lb)	4.2 Nm (3.1 ft lb)

¹⁾ Han 8D is identical to Han 8U.

Construction for level

Weight	
• as per EN (pressure transmitter with mounting flange, without tube)	approx 11 ... 13 kg (24.2 ... 28.7 lb)
• as per ASME (pressure transmitter with mounting flange, without tube)	approx 11 ... 18 kg (24.2 ... 39.7 lb)
Material	
• Wetted parts materials	
Plus side	
• Seal diaphragm on the mounting flange	Stainless steel, mat. no. 1.4404/316L, Monel 400, mat. no. 2.4360, Hastelloy B2, mat. no. 2.4617, Hastelloy C276, mat. no. 2.4819, Hastelloy C4, mat. no. 2.4610, tantalum, PTFE, ECTFE
• Sealing surface	smooth as per EN 1092-1, form B1 or ASME B16.5 RF 125 ... 250 AA for stainless steel 316L, EN 2092-1 form B2 or ASME B16.5 RFSF for the remaining materials
Sealing material in the pressure caps	
• for standard applications	Viton
• for underpressure applications on the mounting flange	Copper
Minus side	
• Seal diaphragm	Stainless steel, mat. no. 1.4404/316L
• Pressure caps and locking screws	Stainless steel, mat. no. 1.4408
• O-ring	FPM (Viton)
• Non-wetted parts materials	
Electronics housing	<ul style="list-style-type: none"> • Non-copper aluminum die casting GD-AISI 12 or stainless steel precision casting, mat. no. 1.4408 • Standard: Polyester-based paint Option: 2 coats: Coat 1: epoxy-based; coat 2: polyurethane • Stainless steel nameplate
Pressure cap screws	Stainless steel
Measuring cell filling	Silicone oil

Construction for level			
• Mounting flange fill fluid	Silicon oil or a different design		
Process connection			
• Plus side	Flange as per EN and ASME		
• Minus side	1/4-18 NPT female thread and flat connection with M10 fastening screw thread in accordance with DIN 19213 (M12 for PN 420 (MAWP 6092 psi)) or 7/16-20 UNF in accordance with EN 61518		
Electrical connection			
	Screw terminals		
	Cable inlet using the following cable glands:		
	<ul style="list-style-type: none"> • Pg 13.5 • M20 x 1.5 • 1/2-14 NPT or Han 7D/Han 8D connector¹⁾ • M12 connector 		
Torque for nut with			
• Cable gland made of plastic	2.5 Nm (1.8 ft lb)		
• Cable gland made of metal	4.2 Nm (3.1 ft lb)		
• Cable gland made of stainless steel	4.2 Nm (3.1 ft lb)		
Torque for cable gland nut made of			
	Plastic	Metal	Stainless steel
	2.5 Nm (1.8 ft lb)	4.2 Nm (3.1 ft lb)	4.2 Nm (3.1 ft lb)

¹⁾ Han 8D is identical to Han 8U.

11.7 Display, keyboard and auxiliary power



Display and user interface		
Keys	3 for on-site programming directly at the device	
Display	<ul style="list-style-type: none"> • With or without integrated display (optional) • Cover with inspection window (optional) 	
Auxiliary power U _H		
	HART	PROFIBUS PA or Foundation Fieldbus
Terminal voltage at transmitter	<ul style="list-style-type: none"> • DC 10.5 V ... 45 V • In the case of intrinsically safe operation 10.5 V ... 30 V DC 	–
Ripple	U _{SS} ≤ 0.2 V (47 ... 125 Hz)	–
Noise	U _{eff} ≤ 1.2 V mV (0.5 to 10 kHz)	–
Auxiliary power	–	Bus-powered
Separate supply voltage	–	Not necessary
Bus voltage		
• Not 	–	9 ... 32 V
• For intrinsically safe operation	–	9 ... 24 V
Current consumption		





Technical data

11.8 Certificates and approvals

Auxiliary power U_H	HART	PROFIBUS PA or Foundation Fieldbus
• Max. basic current	–	12.5 mA
• Starting current \leq basic current	–	Yes
• Max. current in event of fault	–	15.5 mA
Error shut-down electronics (FDE) present	–	Yes

11.8 Certificates and approvals

Certificates and approvals	HART	PROFIBUS PA or Foundation Fieldbus
Classification according to Pressure Equipment Directive (PED 97/23/EC)	<ul style="list-style-type: none"> for gases of Fluid Group 1 and liquids of Fluid Group 1; meets requirements of Article 3 Para. 3 (good engineering practice) only for flow rate: for gases of Fluid Group 1 and liquids of Fluid Group 1; fulfills the basic safety requirements as per article 3, Para 1 (appendix 1); classified as category III, module H conformity evaluation by TÜV Nord 	
Drinking water	In preparation	
Explosion protection		
• Intrinsic safety "i"	PTB 11 ATEX 2011 X	
Marking	 II 1/2G Ex ia/ib IIC T4/T5/T6 Ga/Gb	
Permissible ambient temperature	-40 ... +85 °C (-40 ... +185 °F) Temperature class T4 -40 ... +70 °C (-40 ... +158 °F) Temperature class T5 -40 ... +60 °C (-40 ... +140 °F) Temperature class T6	
Connection	To a certified intrinsically safe circuit with the max. values: $U_i = 30 \text{ V}$, $I_i = 100 \text{ mA}$, $P_i = 750 \text{ mW}$, $R_i = 300 \Omega$	FISCO supply unit $U_0 = 17.5 \text{ V}$, $I_0 = 380 \text{ mA}$, $P_0 = 5.32 \text{ W}$ Linear barrier $U_0 = 24 \text{ V}$, $I_0 = 174 \text{ mA}$, $P_0 = 1 \text{ W}$
Effective inner capacitance	$C_i = 6 \text{ nF}$	$C_i = 1.1 \text{ nF}$
Effective inner inductance	$L_i = 0.4 \text{ mH}$	$L_i = 7 \mu\text{H}$
• Flameproof enclosure encapsulation "d"	PTB 99 ATEX 1160	
Marking	 II 1/2 Ex d IIC T4, T6 Ga/Gb	
Permissible ambient temperature	-40 ... +85 °C (-40 ... +185 °F) Temperature class T4 -40 ... +60 °C (-40 ... +140 °F) Temperature class T6	
Connection	To a circuit with the operating values: $U_H = 10.5 \dots 45 \text{ V DC}$	To a circuit with the operating values: $U_H = 9 \dots 32 \text{ V DC}$
• Dust explosion protection for Zone 20 and 20/21	PTB 01 ATEX 2055	

Certificates and approvals		
	HART	PROFIBUS PA or Foundation Fieldbus
Marking	 II 1 D IP65 T 120 °C,  II 1/2 D IP65 T 120 °C	
Permissible ambient temperature	-40 ... +85 °C (-40 ... +185 °F)	
max. surface temperature	120°C (248°F)	
Connection	To a certified intrinsically safe circuit with the max. values: $U_i = 30 \text{ V}$, $I_i = 100 \text{ mA}$, $P_i = 750 \text{ mW}$, $R_i = 300 \Omega$	FISCO supply unit $U_o = 17.5 \text{ V}$, $I_o = 380 \text{ mA}$, $P_o = 5.32 \text{ W}$ Linear barrier $U_o = 24 \text{ V}$, $I_o = 250 \text{ mA}$, $P_o = 1.2 \text{ W}$
Effective inner capacitance	$C_i = 6 \text{ nF}$	$C_i = 1.1 \text{ nF}$
Effective inner inductance	$L_i = 0.4 \text{ mH}$	$L_i = 7 \mu\text{H}$
• Dust explosion protection for Zone 22	PTB 01 ATEX 2055	
Marking	 II 2 D IP65 T 120 °C	
Connection	To a circuit with the operating values: $U_H = 10.5 \dots 45 \text{ V DC}$; $P_{\max} = 1.2 \text{ W}$	To a circuit with the operating values: $U_H = \text{DC } 9 \dots 32 \text{ V}$; $P_{\max} = 1.2 \text{ W}$
• Type of protection "n" (Zone 2)	PTB 11 ATEX 2011 X	
Marking	 II 2/3 G Ex nA II T4/T5/T6 Gc  II 2/3 G Ex ic IIC T4/T5/T6 Gc	
Connection "nA"	$U_n = 45 \text{ V}$	$U_m = 32 \text{ V}$
Connection "ic"	To a circuit with the operating values: $U_i = 45 \text{ V}$	FISCO supply unit $U_o = 17.5 \text{ V}$, $I_o = 570 \text{ mA}$ Linear barrier $U_o = 32 \text{ V}$, $I_o = 132 \text{ mA}$, $P_o = 1 \text{ W}$
Effective inner capacitance	$C_i = 6 \text{ nF}$	$C_i = 1.1 \text{ nF}$
Effective inner inductance	$L_i = 0.4 \text{ mH}$	$L_i = 7 \mu\text{H}$
• Explosion protection in accordance with FM	Certificate of Compliance 3008490	
Designation (XP/DIP) or IS; NI; S	CL I, DIV 1, GP ABCD T4 ... T6; CL II, DIV 1, GP EFG; CL III; CL I, ZN 0/1 AEx ia IIC T4 ... T6; CL I, DIV 2, GP ABCD T4 ... T6; CL II, DIV 2, GP FG; CL III	
Permissible ambient temperature	$T_a = \text{T4: } -40 \dots +85 \text{ °C } (-40 \dots +185 \text{ °F})$ $T_a = \text{T5: } -40 \dots +70 \text{ °C } (-40 \dots +158 \text{ °F})$ $T_a = \text{T6: } -40 \dots +60 \text{ °C } (-40 \dots +140 \text{ °F})$	
Entity parameters	As per "control drawing" A5E00072770A: $U_i = 30 \text{ V}$, $I_i = 100 \text{ mA}$, $P_i = 750 \text{ mW}$, $R_i = 300 \Omega$, $C_i = 6 \text{ nF}$, $L_i = 0.4 \text{ mH}$	As per "control drawing" A5E00072770A: $U_{\max} = 17.5 \text{ V}$, $I_{\max} = 380 \text{ mA}$, $P_{\max} = 5.32 \text{ W}$, $C_{\max} = 6 \text{ nF}$, $L_{\max} = 0.4 \text{ mH}$
• Explosion protection as per CSA	Certificate of Compliance 1153651	
Designation (XP/DIP) or (IS)	CL I, DIV 1, GP ABCD T4 ... T6; CL II, DIV 1, GP EFG; CL III; Ex ia IIC T4 ... T6; CL I, DIV 2, GP ABCD T4 ... T6; CL II, DIV 2, GP FG; CL III	
Permissible ambient temperature	$T_a = \text{T4: } -40 \dots +85 \text{ °C } (-40 \dots +185 \text{ °F})$ $T_a = \text{T5: } -40 \dots +70 \text{ °C } (-40 \dots +158 \text{ °F})$ $T_a = \text{T6: } -40 \dots +60 \text{ °C } (-40 \dots +140 \text{ °F})$	
Entity parameters	As per "control drawing" A5E00072770A: $U_i = 30 \text{ V}$, $I_i = 100 \text{ mA}$, $P_i = 750 \text{ mW}$, $R_i = 300 \Omega$, $L_i = 0.4 \text{ mH}$, $C_i = 6 \text{ nF}$	

11.9 HART communication

HART communication	
Load for a	
• HART communicator connection	230 ... 1100 Ω
• HART modem	230 ... 500 Ω
Cable	2-wire, shielded: \leq 3.0 km (1.86 miles), multi-wired, shielded: \leq 1.5 km (0.93 miles)
Protocol	HART Version 5.x
PC/laptop requirements	IBM-compatible, user memory > 32 MB, hard disk > 70 MB, depending on the type of modem: RS 232 interface or USB connection, VGA graphic
Software for computer	SIMATIC PDM

Dimension drawings

12.1 SITRANS P, DS III series for gauge pressure and absolute pressure from the gauge pressure series

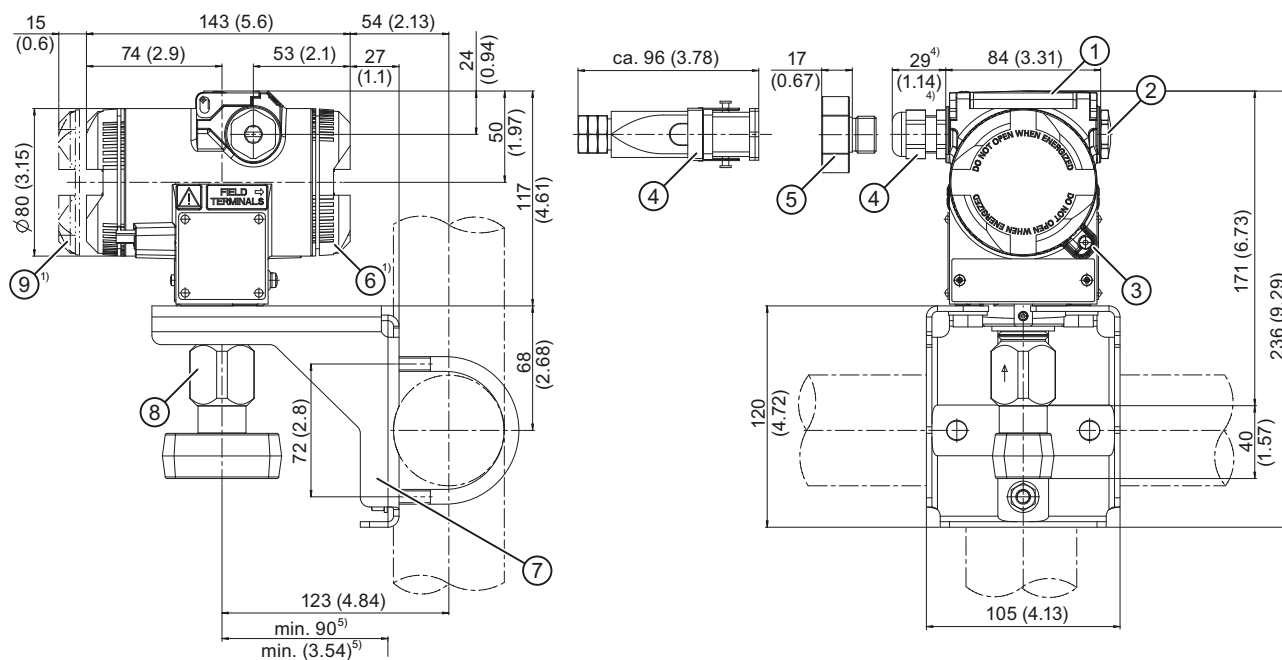

Dimension drawings

12.1 SITRANS P, DS III series for gauge pressure and absolute pressure from the gauge pressure series

- ① Key cover
 - ② Blanking plug
 - ③ Cover catch (only for "flameproof enclosure" type of protection)
 - ④ Electrical connection:
 - Threaded joint Pg 13.5 (adapter)²⁾³⁾,
 - Threaded joint M20 x 1.5³⁾,
 - Threaded joint 1/2-14 NPT
 - Han 7D/Han 8D plug^{2) 3)}
 - M12 connector
 - ⑤ Han 7D/Han 8D adapter
 - ⑥ Connection side
 - ⑦ Mounting bracket (optional)
 - ⑧ Process connection:
 - 1/2-14 NPT,
 - Connection pin G1/2A or
 - Oval flange
 - ⑨ Electronics side, display (longer for cover with inspection window)
- 1) Take additional 20 mm (0.79 inches) thread length into account
- 2) Not with "flameproof enclosure" type of protection
- 3) Not for "FM + CSA [is + XP]" type of protection
- 4) For Pg 13.5 with adapter approx 45 mm (1.77 inches)
- 5) Minimum distance for rotating

Figure 12-1 Pressure transmitter SITRANS P, DS III series for absolute pressure, from gauge pressure series, dimensions in mm (inches)

12.2 SITRANS P, DS III series for differential pressure, flow rate and absolute pressure from the differential pressure series

12.2 SITRANS P, DS III series for differential pressure, flow rate and absolute pressure from the differential pressure series

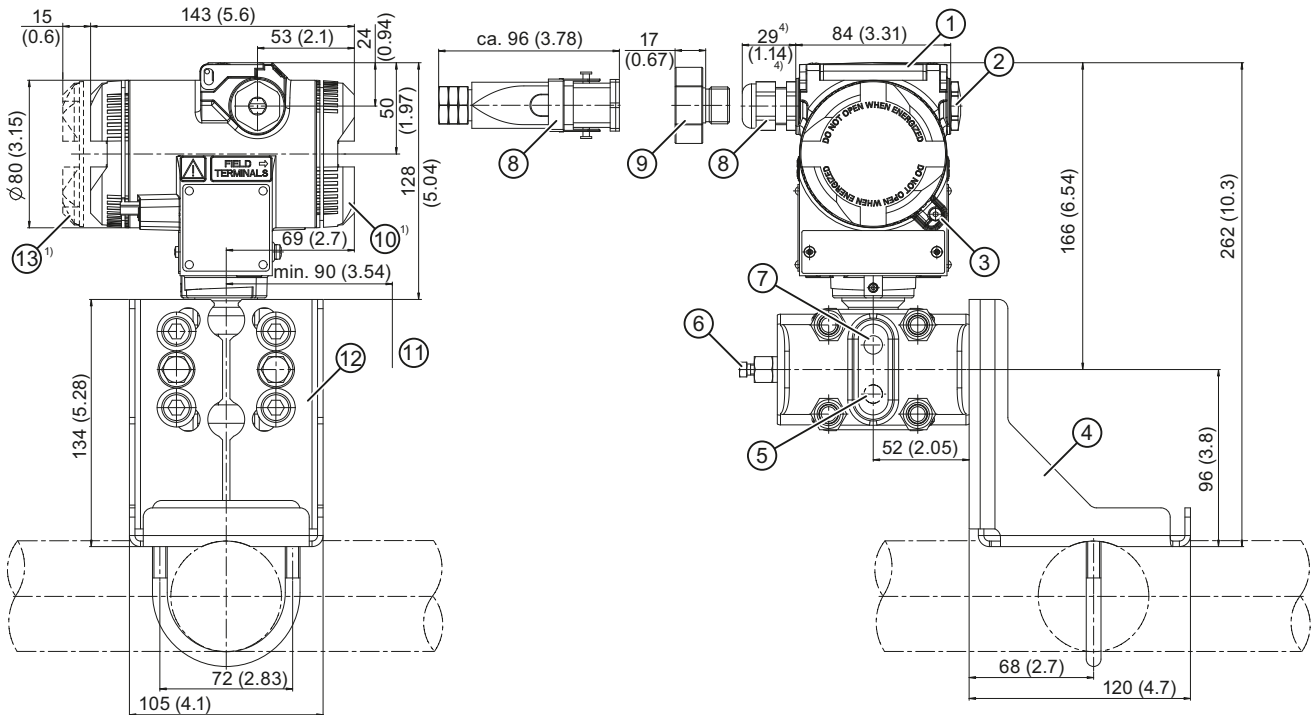

Dimension drawings

12.2 SITRANS P, DS III series for differential pressure, flow rate and absolute pressure from the differential pressure series

- ① Key cover
 - ② Blanking plug
 - ③ Cover catch (only for "flameproof enclosure" type of protection)
 - ④ Mounting bracket (optional)
 - ⑤ Lateral ventilation for gas measurement (addition H02)
 - ⑥ Sealing plug, with valve (optional)
 - ⑦ Lateral ventilation for liquid measurement
 - ⑧ Electrical connection:
 - Pg 13.5 gland (adapter)²⁾³⁾
 - M20 x 1.5 gland³⁾
 - 1/2-14 NPT gland
 - Han 7D/Han 8D plug^{2) 3)}
 - M12 connector
 - ⑨ Han 7D/Han 8D adapter
 - ⑩ Connection side
 - ⑪ Space for enclosure rotation⁵⁾
 - ⑫ Process connection: 1/4-18 NPT (EN 61518)
 - ⑬ Electronics side, display (longer for cover with inspection window)
- ¹⁾ Take an additional 20 mm (0.79 inches) thread length into account
- ²⁾ Not with "flameproof enclosure" type of protection
- ³⁾ Not for "FM + CSA [is + XP]" type of protection
- ⁴⁾ For Pg 13.5 with adapter, approx 45 mm (1.77 inches)
- ⁵⁾ 92 mm (3.62 inches) minimum distance for rotating the enclosure with display

Figure 12-2 Pressure transmitter SITRANS P, DS III series for differential pressure and flow rate, dimensions in mm (inches)

12.2 SITRANS P, DS III series for differential pressure, flow rate and absolute pressure from the differential pressure series

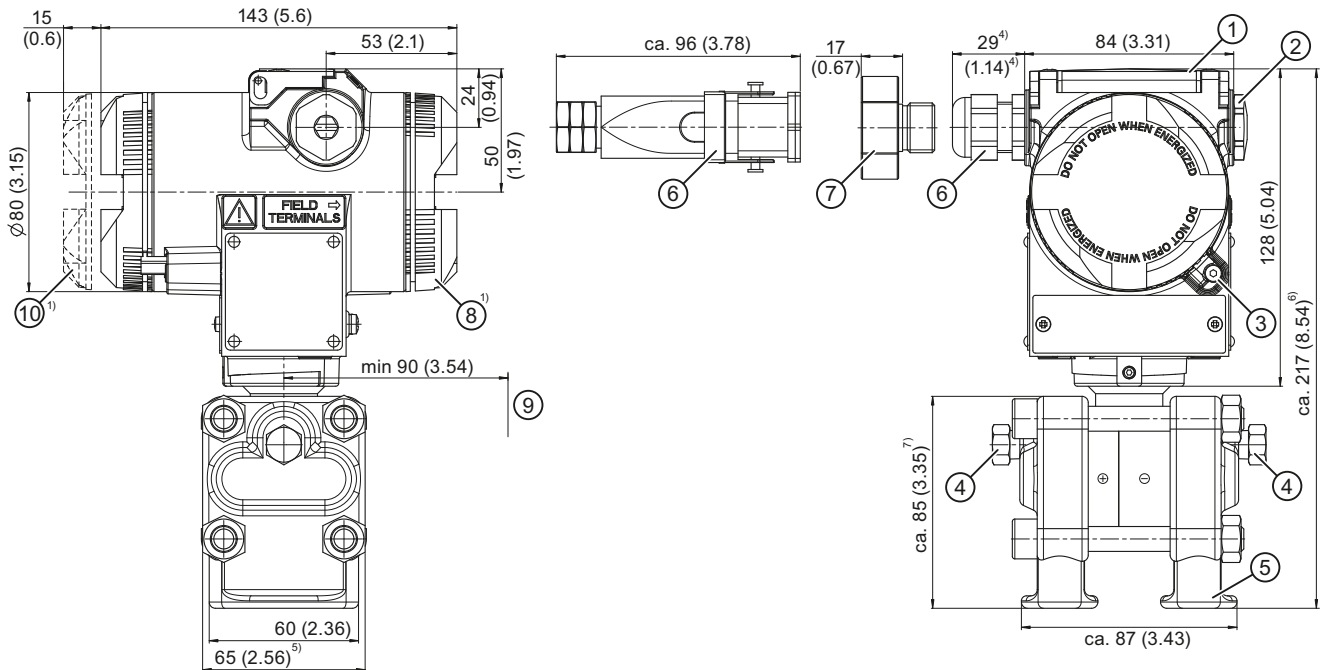

- ① Key cover
 - ② Blanking plug
 - ③ Cover catch (only for "flameproof enclosure" type of protection)
 - ④ Sealing plug, with valve (optional)
 - ⑤ Process connection: 1/4-18 NPT (EN 61518)
 - ⑥ Electrical connection:
 - Pg 13.5 gland (adapter)²⁾³⁾
 - M20 x 1.5 gland³⁾
 - 1/2-14 NPT gland
 - Han 7D/Han 8D plug^{2) 3)}
 - M12 connector
 - ⑦ Han 7D/Han 8D adapter
 - ⑧ Connection side
 - ⑨ Space for enclosure rotation⁸⁾
 - ⑩ Electronics side, display (longer for cover with inspection window)
- 1) Take an additional 20 mm (0.79 inches) thread length into account
 2) Not with "flameproof enclosure" type of protection
 3) Not for "FM + CSA [is + XP]" type of protection
 4) For Pg 13.5 with adapter, approx 45 mm (1.77 inches)
 5) 74 mm (2.9 inch) for PN ≥ 420 (MAWP ≥ 6092 psi)
 6) 219 mm (8.62 inches) for PN ≥ 420 (MAWP ≥ 6092 psi)
 7) 91 mm (3.6 inches) for PN ≥ 420 (MAWP ≥ 6092 psi)
 8) 92 mm (3.62 inches) minimum distance for rotating the enclosure with display

Figure 12-3 Pressure transmitter SITRANS P, DS III series for differential pressure and flow rate with caps for vertical differential pressure lines, dimensions in mm (inches)

12.3 SITRANS P, DS III series for level

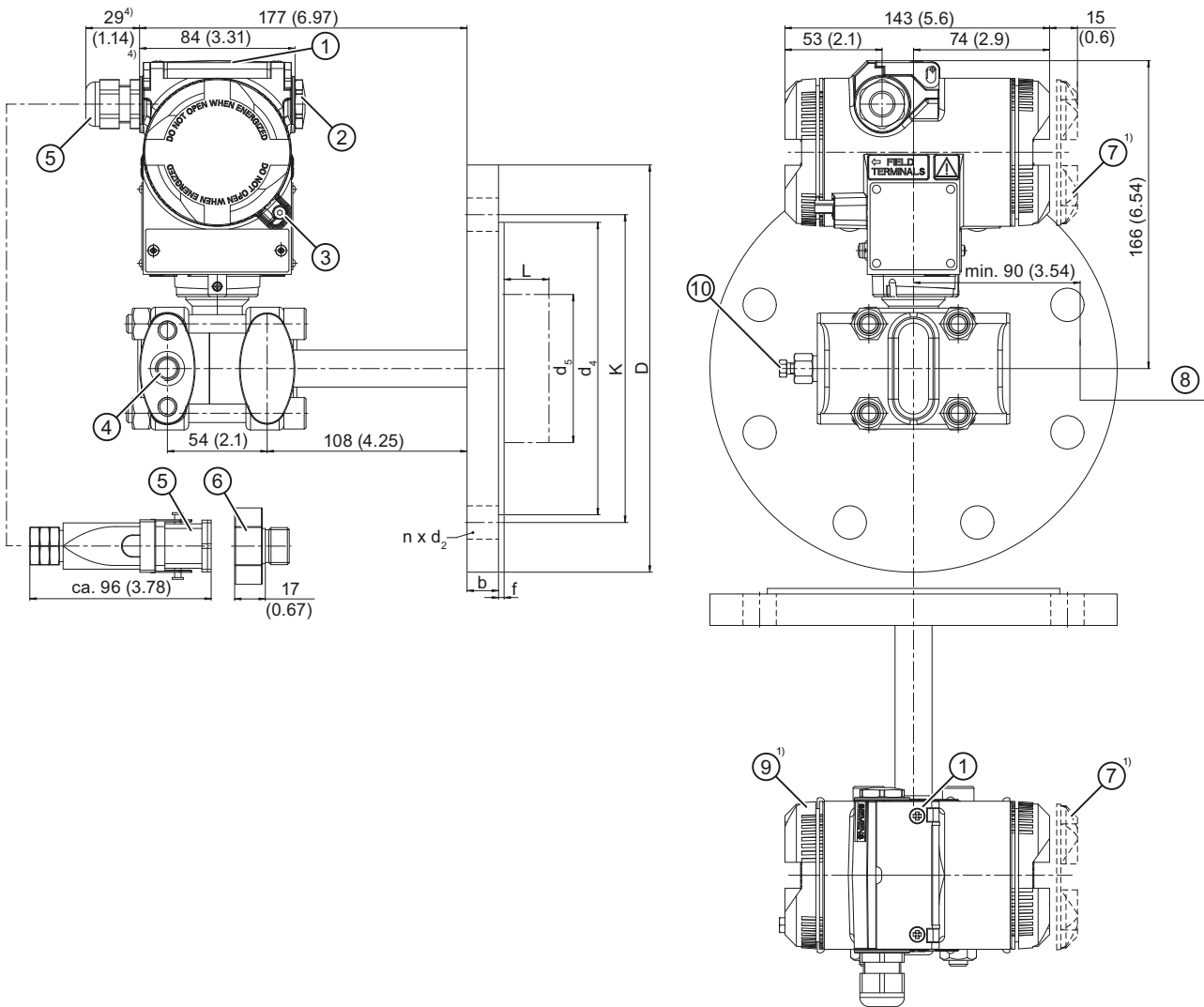

- ① Key cover
 - ② Blanking plug
 - ③ Cover catch (only for "flameproof enclosure" type of protection)
 - ④ Process connection: Minus side $\frac{1}{4}$ -18 NPT (EN 61518)
 - ⑤ Electrical connection:
 - Pg 13.5 gland (adapter)²⁾³⁾
 - M20 x 1.5 gland³⁾
 - $\frac{1}{2}$ -14 NPT gland
 - Han 7D/Han 8D plug^{2) 3)}
 - M12 connector
 - ⑥ Han 7D/Han 8D adapter
 - ⑦ Electronics side, display (longer for cover with inspection window)
 - ⑧ Space for enclosure rotation⁵⁾
 - ⑨ Connection side
 - ⑩ Sealing plug with valve (optional)
- ¹⁾ Take an additional 20 mm (0.79 inches) thread length into account
- ²⁾ Not with "flameproof enclosure" type of protection
- ³⁾ Not for "FM + CSA [is + XP]" type of protection
- ⁴⁾ For Pg 13.5 with adapter, approx 45 mm (1.77 inches)
- ⁵⁾ 92 mm (3.62 inches) minimum distance for rotating the enclosure with display

Figure 12-4 Pressure transmitter SITRANS P, DS III series for level, including mounting flange, dimensions in mm (inches)

12.4 SITRANS P, DS III series (flush mounted)

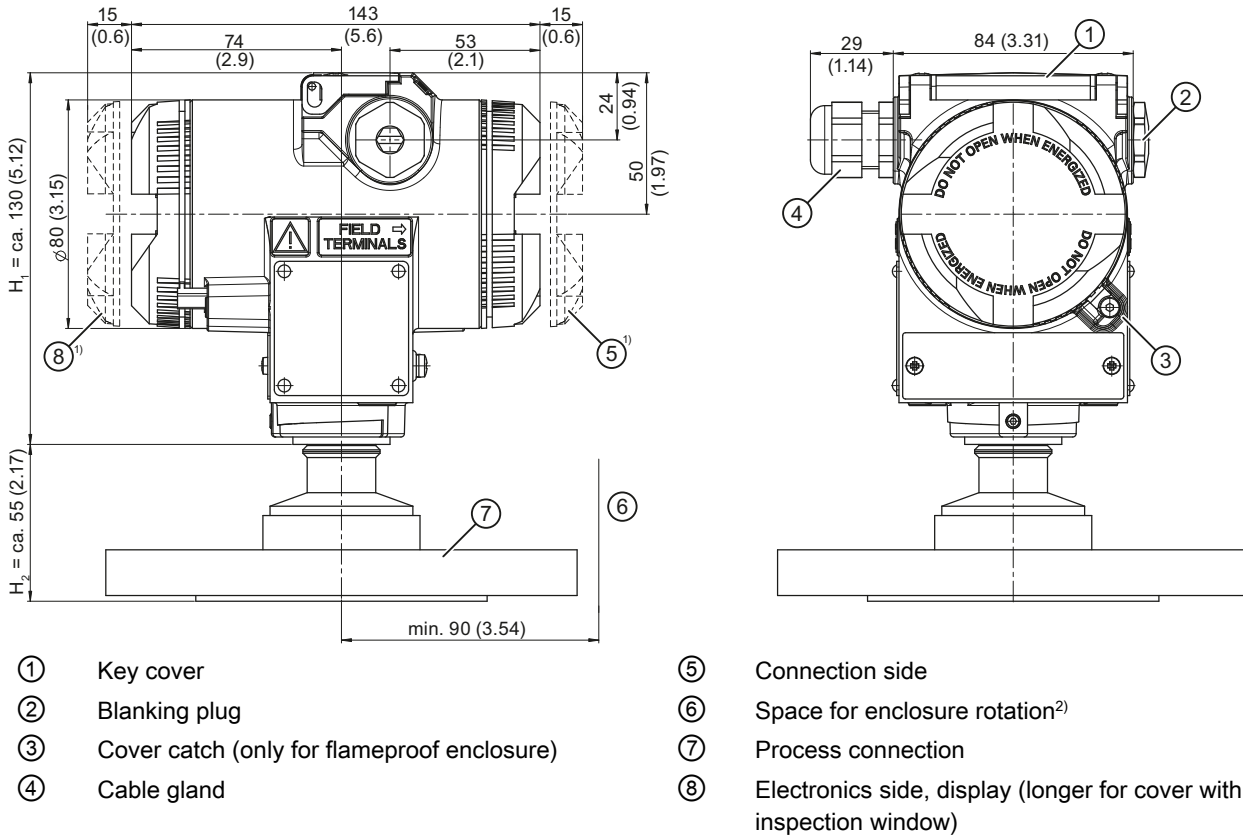

Figure 12-5 SITRANS P DS III (flush mounted)

The screen consists of a SITRANS P DS III with an example flange. On this screen, the height is divided into H_1 and H_2 .

H_1 Height of the device up to a defined cut

H_2 Height of the flange up to this defined cut

In the flange dimensions, only the height H_2 is specified.

12.4.1 Note 3A and EHDG

Note**Approvals**

The references to the approvals for "EHEDG" and "3A" refer to the respective process connections and are not device-specific. Please refer to the technical data of the respective transmitter to see whether the desired certificate is available for your device/flange combination.

12.4.2 Connections as per EN and ASME

Flange as per EN

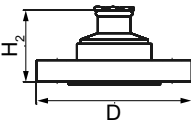
EN 1092-1				
	DN	PN	øD	H ₂
	25	40	115 mm (4.5")	Approx. 52 mm (2")
	25	100	140 mm (5.5")	
	40	40	150 mm (5.9")	
	40	100	170 mm (6.7")	
	50	16	165 mm (6.5")	
	50	40	165 mm (6.5")	
	80	16	200 mm (7.9")	
	80	40	200 mm (7.9")	

Threaded connections

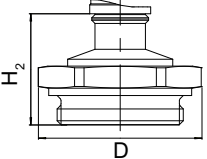
G3/4", G1" and G2" In accordance with DIN 3852				
	DN	PN	øD	H ₂
	¾"	63	37 mm (1.5")	Approx. 45 mm (1.8")
	1"	63	48 mm (1.9")	Approx. 47 mm (1.9")
	2"	63	78 mm (3.1")	Approx. 52 mm (2")

Flanges as per ASME

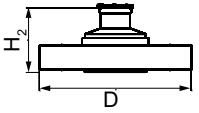
ASME B 16.5				
	DN	CLASS	ØD	H ₂
	1"	150	110 mm (4.3")	Approx. 52 mm (2")
	1"	300	125 mm (4.9")	
	1½"	150	130 mm (5.1")	
	1½"	300	155 mm (6.1")	
	2"	150	150 mm (5.9")	
	2"	300	165 mm (6.5")	
	3"	150	190 mm (7.5")	
	3"	300	210 mm (8.1")	
	4"	150	230 mm (9.1")	
	4"	300	255 mm (10.0")	

12.4.3 F&B and pharma flange

Connections as per DIN

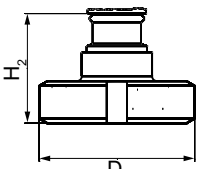
DIN 11851				
	DN	PN	ØD	H ₂
	50	25	92 mm (3.6")	Approx. 52 mm (2")
	80	25	127 mm (5.0")	

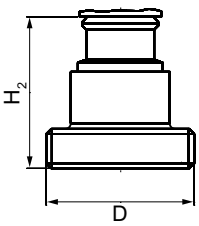
DIN 11864-1 Form A - sterile threaded sockets				
	DN	PN	ØD	H ₂
	25	40	52 mm (2")	Approx. 52 mm (2")
	40	40	65 mm (2.6")	
	50	40	78 mm (3.1")	
	100	40	130 mm (5.1")	
Approvals	EHEDG			

DIN 11864-2 Form A - sterile collar flange

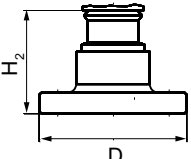
	DN	PN	ØD	H ₂
	50	16	94 mm (3.7")	Approx. 52 mm (2")
	65	16	113 mm (4.4")	
	80	16	133 mm (5.2")	
	100	16	159 mm (6.3")	

Approvals EHEDG

DIN 11864-2 Form A - sterile groove flange

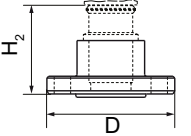
	DN	PN	ØD	H ₂
	50	16	94 mm (3.7")	Approx. 52 mm (2")
	65	16	113 mm (4.4")	
	80	16	133 mm (5.2")	
	100	16	159 mm (6.3")	

Approvals EHEDG

DIN 11864-3 Form A - sterile collar sockets

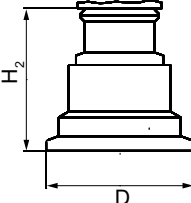
	DN	PN	ØD	H ₂
	50	25	77.5 mm (3.1")	Approx. 52 mm (2")
	65	25	91 mm (3.6")	
	80	16	106 mm (4.2")	
	100	16	130 mm (5.1")	

Approvals EHEDG

Tri-Clamp as per DIN 32676

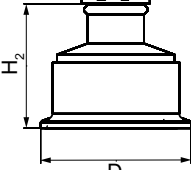
	DN	PN	ØD	H ₂
	50	16	64 mm (2.5")	Approx. 52 mm (2")
	65	16	91 mm (3.6")	

Dimension drawings

12.4 SITRANS P, DS III series (flush mounted)

Other connections

Varivent® connector				
	DN	PN	∅D	H ₂
	40-125	40	84 mm (3.3")	Approx. 52 mm (2")

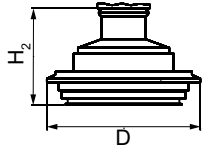

Approvals	EHEDG			
-----------	-------	--	--	--

Connection in accordance with DRD				
	DN	PN	∅D	H ₂
	65	40	105 mm (4.1")	Approx. 52 mm (2")

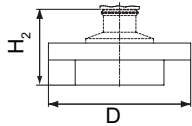

BioConnect™ connectors

BioConnect™ screwed joint				
	DN	PN	∅D	H ₂
	50	16	82 mm (3.2")	Approx. 52 mm (2")
	65	16	105 mm (4.1")	
	80	16	115 mm (4.5")	
	100	16	145 mm (5.7")	
	2"	16	82 mm (3.2")	
	2½"	16	105 mm (4.1")	
	3"	16	105 mm (4.1")	
	4"	16	145 mm (5.7")	

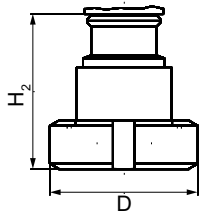

Approvals	EHEDG			
-----------	-------	--	--	--

BioConnect™ flange connector

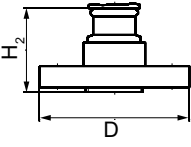
	DN	PN	∅D	H ₂
	50	16	110 mm (4.3")	Approx. 52 mm (2")
	65	16	140 mm (5.5")	
	80	16	150 mm (5.9")	
	100	16	175 mm (6.9")	
	2"	16	100 mm (3.9")	
	2½"	16	110 mm (4.3")	
	3"	16	140 mm (5.5")	
	4"	16	175 mm (6.9")	

Approvals EHEDG

BioConnect™ clamp connector

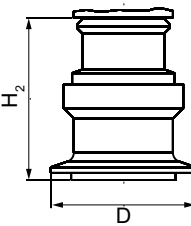
	DN	PN	∅D	H ₂
	50	16	77.4 mm (3.0")	Approx. 52 mm (2")
	65	10	90.9 mm (3.6")	
	80	10	106 mm (4.2")	
	100	10	119 mm (4.7")	
	2"	16	64 mm (2.5")	
	2½"	16	77.4 mm (3.0")	
	3"	10	90.9 mm (3.6")	
	4"	10	119 mm (4.7")	

Approvals EHEDG

Connect S™ flanged joint

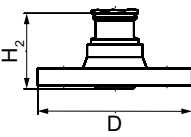
	DN	PN	∅D	H ₂
	50	16	125 mm (4.9")	Approx. 52 mm (2")
	65	10	145 mm (5.7")	
	80	10	155 mm (6.1")	
	100	10	180 mm (7.1")	
	2"	16	125 mm (4.9")	
	2½"	10	135 mm (5.3")	
	3"	10	145 mm (5.7")	
	4"	10	180 mm (7.1")	

Approvals EHEDG

Dimension drawings

12.4 SITRANS P, DS III series (flush mounted)

Other connections

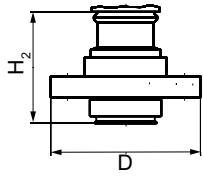
BioControl™ connector				
	DN	PN	ØD	H ₂
	50	16	90 mm (3.5")	Approx. 52 mm (2")
	65	16	120 mm (4.7")	
Approvals	EHEDG			

12.4.4 PMC Style

Connections for the paper industry

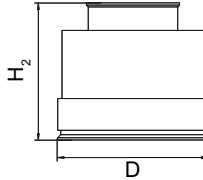
PMC Style Standard				
	DN	PN	ØD	H ₂
	-	-	40.9 mm (1.6")	Approx. 36.8 mm (1.4")
	M44x1.25 cap nut			

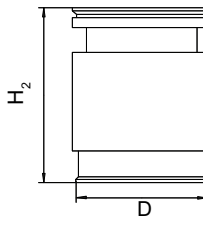
PMC-Style Minibolt				
	DN	PN	ØD	H ₂
	-	-	26.3 mm (1.0")	Approx. 33.1 mm (1.3")

12.4.5 Special connections

Tank connection

TG52/50 and TG52/150

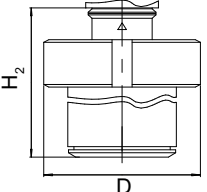
	DN	PN	ØD	H ₂
	TG52/50			
	43.5 mm	10	63 mm (2.5")	Approx. 63 mm (2.5")
	TG52/150			
	43.5 mm	10	63 mm (2.5")	Approx. 170 mm (6.7")

SMS connectors

SMS sockets with union nut

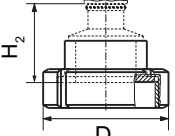
	DN	PN	ØD	H ₂
	2"	25	84 mm (3.3")	Approx. 52 mm (2.1")
	2½"	25	100 mm (3.9")	
	3"	25	114 mm (4.5")	

SMS threaded sockets

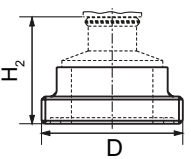
	DN	PN	ØD	H ₂
	2"	25	70 x 1/6 mm (2.8")	Approx. 52 mm (2.1")
	2½"	25	85 x 1/6 mm (3.3")	
	3"	25	98 x 1/6 mm (3.9")	

Dimension drawings

12.4 SITRANS P, DS III series (flush mounted)

IDF connectors

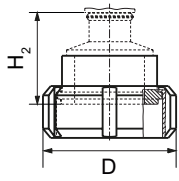
IDF sockets with union nut				
	DN	PN	ØD	H ₂
	2"	25	77 mm (3.0")	Approx. 52 mm (2.1")
	2½"	25	91 mm (3.6")	
	3"	25	106 mm (4.2")	

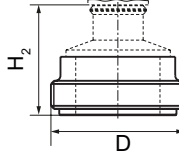
IDF threaded sockets				
	DN	PN	ØD	H ₂
	2"	25	64 mm (2.5")	Approx. 52 mm (2.1")
	2½"	25	77.5 mm (3.1")	
	3"	25	91 mm (3.6")	

Spare parts/accessories

13.1 Order data

In order to ensure that the ordering data you are using is not outdated, the latest ordering data is always available on the Internet:

Process instrumentation catalog (<http://www.siemens.com/processinstrumentation/catalogs>)

Selection and order data	Order no.
CD "sitrans p - pressure transmitters" with documentation in German/English/French/Spanish/Italian, etc.	A5E00090345
HART modem	
• With serial interface RS232	7MF4997-1DA ^{1) D)}
• With USB interface	7MF4997-1DB ^{1) D)}
Weld-in support for PMC connection	
For Series SITRANS P, Series DS III and SITRANS P300	
• PMC Style Standard: Thread 1½"	7MF4997-2HA
• PMC-Style Minibolt: flush mounted 1"	7MF4997-2HB
Gaskets for PMC connection, (1 set = 5 pieces)	
• PTFE gasket for PMC Style Standard: Thread 1½"	7MF4997-2HC
• Viton gasket for PMC Style Minibolt: flush mounted 1"	7MF4997-2HD
Weld-in adapter for PMC connection	
For connection of weld-in support delay during welding for:	
• PMC Style Standard: Thread 1½"	7MF4997-2HE
• PMC-Style Minibolt: flush mounted 1"	7MF4997-2HF

1) Available from stock

D) Subject to export regulations AL: N, ECCN, EAR99H

Selection and order data	Order no.
Mounting bracket and fastening parts	
For SITRANS P, Series DS III, DS III PA and DS III FF	
For gauge pressure transmitter (7MF403.-.....-..C.)	
For transmitter for absolute pressure (7MF423.-.....-..C.)	
• Made of steel	7MF4997-1AB
• Made of stainless steel	7MF4997-1AH
Mounting bracket and fastening parts	
For SITRANS P, Series DS III, DS III PA and DS III FF	
For gauge pressure transmitter (7MF403.-.....-..A., -..B. and -..D.)	

13.1 Order data

Selection and order data	Order no.
For transmitter for absolute pressure (7MF423.-.....-..A., -..B. and -..D.)	
• Made of steel	7MF4997-1AC
• Made of stainless steel	7MF4997-1AJ
Mounting bracket and fastening parts	
For SITRANS P, Series DS III, DS III PA and DS III FF	
Differential pressure transmitter with flange thread	
• Made of steel	
For thread M10 (7MF433.-... and 7MF443.-...)	7MF4997-1AD
For thread M12 (7MF453.-...)	7MF4997-1AE
• Made of stainless steel	
For thread M10 (7MF433.-... and 7MF443.-...)	7MF4997-1AK
For thread M12 (7MF453.-...)	7MF4997-1AL
Mounting bracket and fastening parts	
For SITRANS P, Series DS III, DS III PA and DS III FF	
Differential and absolute transmitter with flange thread 7/16-20 UNF (7MF433.-..., 7MF443.-... and 7MF453.-...)	
• Made of steel	7MF4997-1AF
• Made of stainless steel	7MF4997-1AM
Cover	
For SITRANS P, Series DS III, DS III PA and DS III FF	
• Made of aluminum die casting, including gasket	
Without inspection window	7MF4997-1BB
With inspection window	7MF4997-1BE
• Made of stainless steel, including gasket	
Without inspection window	7MF4997-1BC
With inspection window	7MF4997-1BF
Analog display	
• Scale 0 ... 100%	7MF4997-1BN
• Customer-specific scale division as per the plain text specifications	7MF4997-1BP-Z Y20:
Digital display	
For SITRANS P, Series DS III, DS III PA and DS III FF	
Including the fastening material	7MF4997-1BR
Measuring point label	
• not labeled (five pieces)	7MF4997-1CA
• labeled (one piece) Specifications as per Y01 or Y02, Y15 and Y16 (refer to SITRANS P transmitter)	7MF4997-1CB-Z Y...:
Fastening screws, 50 pieces for:	7MF4997-1CD
• Measuring point label	
• Earthing and connecting terminals	
• Digital display	
Locking screws, (1 set = 2 pieces) for pressure cap	

Selection and order data	Order no.
• Made of stainless steel	7MF4997-1CG
• Made of Hastelloy	7MF4997-1CH
Vent valves , complete (1 set = 2 pieces)	
• Made of stainless steel	7MF4997-1CP
• Made of Hastelloy	7MF4997-1CQ
Electronics	
• For SITRANS P, Series DS III	7MF4997-1DK
• For SITRANS P, Series DS III PA	7MF4997-1DL
• For SITRANS P, Series DS III FF	7MF4997-1DM
Network card	
• For SITRANS P, Series DS III	7MF4997-1DN
• For SITRANS P, Series DS III PA and DS III FF	7MF4997-1DP
Sealing rings for pressure caps made of	
• FPM (Viton)	7MF4997-2DA
• PTFE (Teflon)	7MF4997-2DB
• FEP (with silicon core, suitable for food)	7MF4997-2DC
• FFPM (Kalrez, Compound 4079)	7MF4997-2DD
• NBR (Buna N)	7MF4997-2DE

13.2 Order data for SIMATIC PDM

You can find ordering data in the Catalog FI 01 "Field devices for process automation in the Chapter "Communication and software > Software > SIMATIC PDM - Process Device Manager".

Appendix

A.1 Certificate

The certificates can be found on the enclosed CD and on the Internet under:
 Certificates (<http://www.siemens.com/processinstrumentation/certificates>)

A.2 Literature and standards

No.	Standard	Description
/1/	IEC 61508 Section 1-7	Functional safety of following systems: <ul style="list-style-type: none"> • Safety-instrumented • Electrical • Electronic • Programmable Target group: Manufacturers and suppliers of equipment
/2/	IEC 61511 Section 1-3	Functional safety - Safety systems for the process industry Target group: Planners, constructors and users

A.3 Literature and catalogs

Table A-1

No.	Title	Publisher	Order no.
/1/	PNO guidelines PROFIBUS PA	PNO Technologiefabrik Haid-und-Neu-Str. 7 D-76131 Karlsruhe	2.091
/2/	Catalog ST 70 SIMATIC Products for Totally Integrated Automation	Siemens AG	E86060-K4670-A111-B1
/3/	Catalog ST 70 NSIMATIC News Products for Totally Integrated Automation	Siemens AG	E86060-K4670-A151-A3

No.	Title	Publisher	Order no.
/4/	Catalog ST 80 SIMATIC HMI operation and observation products	Siemens AG	E86060-K4680-A101-B4
/5/	Catalog IK PI Industrial Communication	Siemens AG	Internet address: IK PI Catalog (http://www.automation.siemens.com/net/html_76/support/printkatalog.htm) E86060-K6710-A101-B5

A.4 Overview of HART operating structure

The following overview applies to the HART communicator operating structure.

2 Online	1 (PV meas) *)				
	2 (PV) status				
	3 Module type				
	4 Identification	1 Operation Unit	1 Tag 2 Long Tag --> M ** 3 Descriptor 4 Message 5 Date		
		2 Device	1 Manufacturer 2 Model 3 Device identification 4 Distributor 5 MLFB Order Number 6 Measurement type 7 Fabrication-No 8 Final assembly number 9 Sensor serial number 10 Revisions	1 MLFB Order No --> M 1 Universal rev. 2 Field device rev. 3 Software rev. 4 Hardware rev.	
		3 Basic Parameters	1 Pressure unit 2 LSL (Lower Sensor Limit) 3 USL (Upper Sensor Limit) 4 Minimum Span 5 LRV (Lower Range Value) 6 URV (Upper Range Value) 7 Pressure damping 8 Pressure xfer function	xfer = transfer	
	5 Config Inp/Out	1 Quick-Setup & Meas.	1 PV, Current, Status 2 Meas.Val. & Status 3 Quick-Setup	1 (PV meas) *) 2 AO (analogue output) 3 (PV) % range 4 Status see --> 5 Measurement type 1 Pressure Values 2 Temperature Values 3 Level, Vol, Mass Values (shown if valid items) 4 Vol- Mass- & Flow (shown if valid items) 5 Appl & Stat (shown if valid items) 1 Tag 2 Ext TAG --> M 3 PV is 4 (PV) unit 5 Position correction 6 LRV 7 URV 8 Pressure damping 9 Pressure xfer function	6 Diagnosis/Service 1 Pressure 2 Pres status 3 Untrimmed pressure 4 Untrimmed pres status 1 Sens-Temp 2 Sens-Temp status 3 Electr-Temp 4 Electr-Temp status 1 Level 2 Level status 3 Volume 4 Volume status 5 Mass 6 Mass status 1 Vol-Flow 2 Vol-Flow status 3 Mass-Flow 4 Mass-Flow status 1 Customer 2 Customer Status 1 Position corr --> M
		2 Input	1 Config Pres/Temp 2 Display Process Variables 3 Meas Switch/Mapper	1 Pressure sensor 2 Temperature sensor 3 Pres units see --> 4 Temp units see --> 1 Prozess variables 1 measurement 2 PV is 3 SV is 4 TV is 5 QV is 6 (measurement) config e.g. Level	1 Pressure 2 Untrimmed pres 3 Pressure units 1 Sens-Temp 2 Electr-Temp 3 Temp units 1 Pressure sensor 2 Temperature sensor 1 (PV measurement) 2 (PV) %mge 3 AO 4 (SV measurement) 5 (TV measurement) 6 (QV measurement) 1 Input scaling 2 Level scaling e.g. Level scaling 1 Pres abs/rel 2 Pressure unit 3 Input LRV 4 Input URV 1 Sens-Temp unit 2 Electr-Temp unit 1 Level unit 2 Level LRV 3 Level URV
		to be continued			

Appendix

A.4 Overview of HART operating structure

continuanace 5 Config Inp/Outp	continuanace 2 Input	continuanace 3 Meas Switch/Mapper	continuanace 6 (measurement) config e.g. Level	3 Volume scaling	1 Volume unit 2 Vol LRV 3 Vol URV 2 Density unit 3 Density 3 Mass unit
			6 (measurement) config e.g. Flow	1 Input scaling	1 Pres abs/rel 2 Pressure unit 3 Input LRV 4 Input URV
				2 Flow scaling	1 Vol flow unit 2 Vol flow LRV 3 Vol flow URV 2 Density unit 3 Density 3 Mass flow unit
			6 (measurement) config e.g. Customer	1 Input scaling	1 Pres abs/rel 2 Pressure unit 3 Input LRV 4 Input URV
				3 Customer scaling	1 Cust unit (5 Ch) 2 Cust LRV 3 Cust URV
			7 Unser linearization if Level, Flow or Customer this is valid - otherwise not	1 Special Curve status -->	only if meas not pres
				2 No curve points	
			3 Setup special char --> M		
			4 Display special char --> M		
			4 Meas.Limits & Span	1 Module range 2 Active Device Variables	additional if measurement is mapped to level
	2 Sens-Temp	1 Sens-Temp unit 2 Sens-Temp USL 3 Sens-Temp LSL 4 Sens-Temp min.span			
	3 Electr-Temp	1 Electr-Temp unit 2 Electr-Temp USL 3 Electr-Temp LSL 4 Electr-Temp min.span			
	4 Untrimmed Pres	1 Untrimmed Pres unit 2 Untrimmed Pres USL 3 Untrimmed Pres LSL 4 Untr Pres min.span			
	5 Level	1 Level unit 2 Level USL 3 Level LSL 4 Level min.span			
	6 Volume	1 Volume unit 2 Volume USL 3 Volume LSL 4 Volume min.span			
	7 Mass	1 Mass unit 2 Mass USL 3 Mass LSL 4 Mass min.span			
	5 Vol-Flow	1 Vol-Flow unit 2 Vol-Flow USL 3 Vol-Flow LSL 4 Vol-Flow min.span			
	6 Mass-Flow	1 Mass-Flow unit 2 Mass-Flow USL 3 Mass-Flow LSL 4 Mass-Flow min.span			
	5 Customer	1 (PV) unit 2 Customer USL 3 Customer LSL 4 Customer min. span			
	3 Output	1 Analog output	additional if measurement is mapped to level	1 Analog output	
2 Percent range					
3 Zero and Span				1 Zero/Span set	1 Apply values >1
4 Pres xfer function					2 Out Scaling PV >2
5 Startpoint square root				>1 Out Scaling PV	1 Unit 2 LRV 3 URV 4 LSL 5 USL
				>2 Apply values	1 Apply values --> M
6 Current Limits				1 Lower AO Limit 2 Upper AO Limit	
7 Alarms				1 AO Alarm Type	
				2 Alarm LRV 3 Alarm URV	
2 Sensor trim points				1 Lower sensor trim point 2 Upper sensor trim point	
3 HART output	1 Polling address				
	2 Num request preambles				
	3 Num response preambles				
4 Local meter	1 Meter type				
	2 Unit tracking				
	3 Local Display unit				

to be continued

A.4 Overview of HART operating structure

continuanace 5 Config Inp/Outp	continuanace 4 Local Meter	4 LCD Settings	1 LCD Scaling, if On:	2 LCD Unit			
		5 Bargraph		3 LCD LRV			
				4 LCD URV			
		6 Access Control	1 Lokal keys control mode				
			2 Write protect				
			3 Set write protect --> M				
		5 Mech. Construction Mech = mechanical	1 No of electronic changes	2 Design	1 Sensor	1 Fill fluid	
						2 Isolation material	
						3 O ring material	
						4 Module range	
2 Remote Seal	1 Number remote seal (RS)						
	2 RS type						
	3 RS isolator material						
	4 RS fill fluid						
	5 Extension length						
	6 Extension type						
	7 Capillar length						
3 Process Connection	1 Process Connection						
	2 DrainVent / plug mat						
	3 DrainVent / plug pos						
	4 Process flange bolt						
	5 Flange type						
4 Electronic Connection	6 Flange material						
	1 Electr housing material						
	2 Electr connection						
6 Certif & Approv	1 Explos. Protection						
7 Diagnosis/Service	1 Status	1 Status summary					
		2 Extended device status					
		3 Simulation status					
		4 Hardw/Firmw status	1 Status group 2				
			2 Status group 3				
			3 Status group 4				
			4 Status group 5				
		5 Diag Alarm Status	1 Status group 15				
			2 Status group 16				
		6 Diag Warn Status	1 Status group 19				
	2 Status group 20						
	2 Device	1 Selftest/Reset	1 Selftest --> M				
			2 Display Test --> M				
			3 Master reset --> M				
			4 Changes Config	1 Config changed counter			
		2 Sensor trim	1 Restore mfrg trims --> M				
			2 Sensor trim	1 Sensor trim points	1 Lower sensor trim point		
				2 Sensor trim	2 Upper sensor trim point		
			3 Trimpoint summary	1 Pres zero trim --> M			
			4 Trim analog output	2 Lower sensor trim --> M			
5 Scaled D/A trim --> M		3 Upper sensor trim --> M					
3 Simulation/Test	1 Loop test --> M						
	2 Inputs --> M	Simulation AO					
	4 Position correction	1 Position corr --> M	Simulation Fixed / Ramp				
4 Access Control	1 Local keys control mode						
	2 Write protect						
	3 Set write protect --> M						
3 Diagnostic settings	1 W/A time unit	W/A = warning/alarm					
		2 Calib interval	1 Calib status				
			2 W/A acknowledge --> M				
			3 Calib timer	1 Calib time			
		3 Service interval	4 Calib warning				
			5 Calib alarm				
	6 W/A activation		2 Reset timer --> M				
	4 AO saturation		1 Service status				
			2 W/A acknowledge --> M				
			3 Service timer	1 Service time			
	5 Limiter setup	4 Service warning					
		5 Service alarm					
		6 W/A activation	2 Reset timer --> M				
		1 AO alarm type	1 AO alarm type				
			2 Saturation alarm				
			3 Alarm duration				
	2 Saturation alarm	4 Alarm activation					
		1 Display limiter --> M	1 Display limiter --> M				
			2 Setup limiter --> M				
			3 Limiter status --> M				
4 Limiter: Ack W/A --> M		4 Limiter: Ack W/A --> M					
		5 CmpCnt: Ack W/A --> M					
	6 Reset counter. --> M						
4 View	1 Operating hours	1 Operating hours Electr					
		2 Operating hours Sensor					
	3 Min/Max pointer	1 Pressure pointer	1 Pres max				
			2 Pres min				
			3 Reset pointer --> M				
		2 Electr-Temp pointer	1 Electr-Temp max				
			2 Electr- Temp min				
		3 Reset pointer --> M					
3 Sens-Temp pointer	1 Sens-Temp max						
	2 Sens-Temp min						
	3 Reset pointer --> M						

Explos = Explosion
Certif = Certification
Approv = Approval

mfrg = manufacturer
1 Lower sensor trim point
2 Upper sensor trim point
1 Pres zero trim --> M
2 Lower sensor trim --> M
3 Upper sensor trim --> M

Ack = acknowledge
CmpCnt =
Comparison Counter

A.5 Technical support

Technical Support

You can contact Technical Support for all IA and DT products:

- Via the Internet using the **Support Request:**
Support request (<http://www.siemens.com/automation/support-request>)
- E-mail (<mailto:support.automation@siemens.com>)
- **Phone:** +49 (0) 911 895 7 222
- **Fax:** +49 (0) 911 895 7 223

Further information about our technical support is available on the Internet at Technical Support (<http://www.siemens.com/automation/csi/service>)

Service & Support on the Internet

In addition to our documentation, we offer a comprehensive knowledge base on the Internet at:

Services & Support (<http://www.siemens.com/automation/service&support>)

There you will find:

- The latest product information, FAQs, downloads, tips and tricks.
- Our newsletter with the latest information about our products.
- A Knowledge Manager to find the right documents for you.
- Our bulletin board, where users and specialists share their knowledge worldwide.
- Your local contact partner for Industry Automation and Drives Technologies in our partner database.
- Information about field service, repairs, spare parts and lots more under "Services."

Additional Support

Please contact your local Siemens representative and offices if you have any questions about the products described in this manual and do not find the right answers.

Find your contact partner at:

Partner (<http://www.automation.siemens.com/partner>)

Documentation for various products and systems is available at:

Instructions and manuals (<http://www.siemens.com/processinstrumentation/documentation>)

See also

Product information on SITRANS P in the Internet (<http://www.siemens.com/sitransp>)

Process instrumentation catalog (<http://www.siemens.com/processinstrumentation/catalogs>)

List of abbreviations

List of abbreviations

Table B-1 Units

Abbreviation	In full	Meaning
bar a	bar absolute	Pressure unit for absolute pressure
bar g	bar gauge	Pressure unit for gauge pressure
lb	Pfund (engl.: Pound)	Unit of weight
psi a	psi absolute	Pressure unit for absolute pressure
psi g	psi gauge	Pressure unit for gauge pressure

Table B-2 Other abbreviations

Abbreviation	In full	Meaning
PED	Pressure equipment directive	
HART	Highway Addressable Remote Transducer	Standardized protocol for transmission of information between field device and automation system.
LRL	Engl.: Lower Range Limit	Lower end of the measuring range
LRV	Engl.: Lower Range Value	Lower end of the set measuring span
MA	Start of scale value	Lower end of the set measuring span
ME	Full scale value	Upper end of the set measuring span
MAWP	Engl.: Maximum Allowable Working Pressure (PS)	Maximum permissible operating pressure
NFPA	National Fire Protection Association	US - American Fire Protection Organization
F&B	Food and beverage industry	
PDM	Engl.: Process Device Manager	Tool for communication with HART devices (manufacturer: Siemens)
URL	Engl.: Upper Range Limit	Upper end of the measuring range
URV	Engl.: Upper Range Value	Upper end of the set measuring span

B.1 Functional safety

Abbreviation	Full term in English	Meaning
FIT	Failure in Time	Frequency of failure Number of faults withing 10 ⁹ hours
HFT	Hardware Fault Tolerance	Hardware fault tolerance: Capability of a function unit to continue executing a required function in the presence of faults or deviations.

List of abbreviations

B.1 Functional safety

Abbreviation	Full term in English	Meaning
MooN	"M out of N" voting	Classification and description of the safety-instrumented system in terms of redundancy and the selection procedures used. A safety-instrumented system or part that consists of "N" independent channels. The channels are connected to each other in such a way that "M" channels are in each case sufficient for the device to perform the safety instrumented function. Example: Pressure measurement: 1oo2 architecture. A safety-instrumented system decides that a specified pressure limit has been exceeded if one out of two pressure sensors reaches this limit. In a 1oo1 architecture, there is only one pressure sensor.
MTBF	Mean Time Between Failures	Average period between two failures
MTTR	Mean Time To Restoration	Average period between the occurrence of a fault in a device or system and restoration of functionality
PFD	Probability of Failure on Demand	Probability of dangerous failures of a safety function on demand
PFD _{AVG}	Average Probability of Failure on Demand	Average probability of dangerous failures of a safety function on demand
SFF	Safe Failure Fraction	Proportion of safe failures: Proportion of failures without the potential to bring the safety-instrumented system into a dangerous or non-permissible functional status.
SIL	Safety Integrity Level	The international standard IEC 61508 defines four discrete Safety Integrity Levels (SIL 1 to SIL 4). Each level corresponds to a range of probability for failure of a safety function. The higher the Safety Integrity Level of the safety-instrumented system, the lower the probability that it will not execute the required safety functions.
SIS	Safety Instrumented System	A safety-instrumented system (SIS) executes the safety functions that are required to achieve or maintain a safe status in a system. It consists of a sensor, logic unit/control system and final controlling element.
TI	Test Interval	Testing interval of the protective function

Glossary

ATEX

ATEX is an abbreviation of the French term "Atmosphère explosible" (potentially explosive atmosphere). ATEX stands for both EC directives in the area of explosion protection: ATEX product directive 94/9/EC and ATEX operating directive 1999/92/EC.

Auxiliary power supply

Auxiliary power supply refers to an electrical supply or reference voltage which some electrical circuits require apart from the standard supply. The auxiliary power supply can, for example, be specially stabilized, have a particular level or polarity and/or other properties which are important for the correct functioning of switch components.

Auxiliary voltage

→ *Auxiliary power supply*

Dangerous failure

Failure with the potential to bring the safety-instrumented system into a dangerous or non-functional status.

EEPROM

EEPROM (Electrically Erasable Programmable Read-Only Memory): a non-volatile, electronic memory module.

EEPROMs are often used where individual bytes of data (e.g. configuration data or runtime meters) change over time and must be stored safely in the event of a mains power failure.

Fail-safe

The capability of a control to maintain the safe state of the controlled device, e.g. machine, process, or to bring the device to a safe state even when faults/failures occur.

Failure/Fault

Failure:

A resource is no longer capable of executing a required function.

Fault:

Undesired state of a resource indicated by the incapability of executing a required function.

Fault

→ *Failure/Fault*

Fault tolerance

Fault tolerance N means that a device can execute the intended task even when N faults exist. The device fails to execute the intended function in case of N+1 faults.

Final controlling element

Converter that converts electrical signals into mechanical or other non-electrical variables.

Firmware

Firmware (FW) is software that is embedded on a chip in electronic devices – in contrast to software which is saved on hard disks, CD-ROMs or other media. These days, firmware is mostly stored in a flash memory or EEPROM.

Firmware usually contains the elementary functions for controlling the device, as well as input and output routines.

Frequency shift keying

Frequency shift keying is a simple form of modulation, where the digital values 0 and 1 modulate the actual current signal by means of two different frequencies.

Frequency Shift Keying (FSK)

→ *Frequency shift keying*

HART

HART (Highway Addressable Remote Transducer) is a standardized, widely used communications system used to structure industrial fieldbusses. The communications system provides digital communications for multiple participants (field devices) via a common databus. HART is based especially on the equally widely used 4/20 mA standard for the transfer of analog sensor signals. The cabling from existing older systems can be used directly and both systems operated in parallel.

HART specifies several protocol levels in the OSI model. It facilitates the transfer of process and diagnostics data and control signals between field devices and high-level control systems. Standardized parameter sets can be used for the manufacture-independent operation of all HART devices.

Typical applications include transmitters for measuring mechanical and electrical dimensions.

MAWP (PS)

Maximum Allowable Working Pressure (PS)

Non-volatile memory

→ *EEPROM*

Risk

The combination of probability of a damage occurring and its magnitude.

Safety function

Defined function executed by a safety-instrumented system with the objective of achieving or maintaining a safe system status taking into account a defined dangerous occurrence.

Example:

Limit pressure monitoring

Safety Instrumented Function

→ *SIF*

Safety Integrity Level

→ *SIL*

Safety-instrumented system

A safety-instrumented system executes the safety functions that are required to achieve or maintain a safe status in a system. It consists of a sensor, logic unit/control system and final controlling element.

Example:

A safety-instrumented system is made up of a pressure transmitter, a limit signal sensor and a control valve.

Sensor

Converter that converts mechanical or other non-electrical variables into electrical signals.

SIF

A part/function of a safety-instrumented system that reduces the risk of a dangerous failure occurring.

SIL

The international standard IEC 61508 defines four discrete Safety Integrity Levels (SIL) from SIL 1 to SIL 4. Each level corresponds to the probability range for the failure of a safety function. The higher the SIL of the safety-instrumented system, the higher probability that the required safety function will work.

The achievable SIL is determined by the following safety characteristics:

- Average probability of dangerous failure of a safety function in case of demand (PFD_{AVG})
- Hardware fault tolerance (HFT)
- Safe failure fractions (SFF)

srl2

→ *srlin2*

srlin2

"srl2" or "srlin2" is a type of square root extracting characteristic curve for the output current. This characteristic curve type is proportional to the flow rate, linear in two levels up to the application point and has a pre-defined application point of 10%.

"srl2" or "srlin2" are synonymous and technically there is no difference between them. The abbreviation "srl2" is used in sections that refer to the on-site operation of the pressure transmitter. The reason for the abbreviation is that the pressure transmitter display is restricted to five characters. The abbreviation "srlin2" is used for HART operation.

Index

- PV
 - Primary variable, 102
- QV
 - Quarternary variable, 102
- SV
 - Secondary variable , 102
- TV
 - Tertiary variable, 102

3

- 3A, 203

A

- Acknowledgement, 129
- Additional Support, 220
- Ambient temperature, 183, 184, 185, 186
 - Influence, 178, 179, 180, 182
- Analog output, 114
- Analog output block, 114
- Analog output stage, 101
- Appendix, 215
- Approval
 - 3A, 203
 - EHEDG, 203
- Approval plate, 22
- Arrow display, 70

B

- Bar graph, 123
- Basic variables, 65
- Blind adjustment, 117
- Bridge output voltage, 25, 26, 27

C

- Calibration
 - Current transmitter, 124
 - Sensor, 123
- Calibration interval, 130
- Calibration timer, 129
- Certificate, 215

- Certificates, 13
- Certification, 215
- Characteristic curve
 - lin, 92
 - srlin , 92
 - srlin2 , 92
 - sroff, 92
- Characteristics
 - Safety, 142, 147
- Configuration data, 126
- Connector
 - M12, 63
- Constant current operation, 88, 118
- Control system, 137
- Correct usage, (See improper device modifications)
- Current limit, 119
- Current transmitter, 88, 118
- Customer Support Hotline, 220

D

- Device
 - Electrostatic-sensitive, 16, 162
- Device variable, 71, 110
 - DV, 102
- Diagnostic interrupt, 118, 128
- Diagnostic warning, 128
- Differential pressure, 18, 19, 91, 127
- Direct sunlight, 37
- Display of unit, 68
- Downscaling, 76
- DV
 - Device variable, 102
- Dynamic variable (DV), 101

E

- EHEDG, 203
- Electrical damping, 118
- Electromagnetic compatibility, 184, 185, 186
- Electromagnetic Compatibility
 - Compatibility, 142
- Electronics, 142, 147
- Electrostatic-sensitive device (ESD), 16, 162
- EMC, 184, 185, 186
- Equalizer valve, 156
- Error display, 69

F

- Factory calibration, 125
- Failure current, 118
- Fast recording of measured values, 118
- Fast Response Mode, 118
- Filling liquid, 25, 27, 28
- Final controlling element , 137
- Firmware, 9
- Firmware version
 - Safety Integrity Level, 141, 144
- Flange, 27, 44
- Full-scale value
 - Set, 75
- Function chart, 29

H

- Han plug, 62
- HART
 - Modem, 17
- HART communicator, 99
- Hazardous area
 - Laws and directives, 13
- History, 9
- Hotline, 220

I

- Improper device modifications, 14
- Input scaling, 104, 106, 109
- Install
 - Remote seal, 47
- Installation, 40
- Internet, 220

K

- Keyboard lock, 90

L

- L (level), 105
- LCD scaling, 115
- Level, 19
- Limit monitor, 134
- lin, 92, 127
- Load, 177

M

- M12 connector, 63
- MA
 - Start of scale value, 102
- Maintenance, 142, 146
- Mapper, 101, (Also see: Variable mapper)
- Mass, 104, 105
- MAWP, 221
- ME
 - Full scale value, 102
- Measured value display, 75, 94
- Measured value status, 111
- Measuring accuracy, 141, 146
- Measuring cell
 - Differential pressure and flow rate , 26
 - Absolute pressure, 29
 - Gauge pressure, 25
 - Level, 27
- Measuring mode, 75, 100, 102, 106
- Measuring mode selector, 101, 102
- Measuring span, 76
- Message
 - OVER, 71
 - UNDER, 71
- Mounting bracket, 41
- Mounting flange, 27
- MTTR, 143, 147
- MWP, (See MAWP)

N

- Nameplate, 21

O

- Operating structure , 217
- operation
 - Local, 75
- Output scaling, 104, 110
- Output scaling , 107

P

- Pair of min/max pointer, 130
- Pairs of values, 107, 110
- Plug
 - Han, 62
- Position correction, 87

Pressure simulation, 134
Pressure unit, 122
Primary variable, 71, 94
Process connection, 20
PV
 Primary variable, 94

Q

Qualified personnel, 14

R

Ramp function, 133, 134
Remote seal
 Description, 31
 Install, 47
 Maintenance, 165
Response time, 131
Root application point, 92, 106

S

Safety
 Checking, 142, 147
Safety function, 140, 143
 Checking, 141, 142, 145, 146
Safety Integrity Level , 141, 144
Saturation limit , 119
Scope of delivery, 10
sensor calibration, 123
Service, 220
Service timer, 129
Settings, 140, 145
Shut-off valve, 153, 154, 156, 157
Signal range, 71
SIL 2, 137
Simulation, 130, 133
Single-channel operation, 137
Span, 76
srlin, 92, 127
srlin2, 92, 127
sroff, 92, 127
Stabilizing valve, 154, 155, 157
Start-of-scale value
 Set, 75
Stop time, 131
Structure, 19
Support, 220

T

Tank connection, 209
Technical data, 140, 145
Test certificates, 13
Transmitter, 137
Trimming
 lower trim point , 124
 upper trim point, 124
Turning range, 54

V

Variable mapper, 101
Vent valve, 127, 156, 158
Volume, 105

W

Write protection, 90, 141, 146

Z

Zero point calibration, 87, 117

www.siemens.com/processautomation

Siemens AG
Industry Automation (IA)
Sensors and Communication
Process Analytics
76181 KARLSRUHE
DEUTSCHLAND

Subject to change without prior notice
A5E00047092-08
© Siemens AG 2012



A5E00047092



A5E00047092

www.siemens.com/processautomation