

## Overview



SITRANS WM300 MFA motion failure alarm controller is a highly sensitive dual setpoint motion sensor system, used with Milltronics MSP probes.

## Benefits

- Up to 100 mm (4 inch) gap between target and probe.
- Over and under speed setpoint detection.
- Setpoint adjustment range 2 to 5 000 Hz (120 to 300 000 ppm).
- Adjustable start-up time delay.
- Visual indication of probe operation and relay status.
- General purpose, suitable for majority of industrial applications; rugged probe designs provide unmatched reliability.

## Application

The SITRANS WM300 MFA detects changes in the motion and speed of rotating, reciprocating or conveying equipment. It warns of equipment malfunction and signals through contacts to shut down machinery in case of a slowdown or failure. Its reliability makes it a cost-effective way to protect valuable process equipment.

The dual setpoint system suits most industrial applications. This versatile unit can be used on tail pulley shafts, driven pulleys, motor shaft sensing, belt or drag conveyors, screw conveyor flights, bucket elevators, fans and pumps.

Multiple machines can be monitored with twin, independent probe inputs as well as an additional 2 inputs for differential speed detection (DSD) within a machine monitoring solution such as a belt conveyor comparing the head to tail pulley speeds. An optional analog output module can convert the WM300 into a non-contacting tachometer (NCT) with 2 mA outputs.

A special feature is the adjustable 0 to 60 second time delay, allowing the monitored device to accelerate to normal running speed before monitoring begins. A wide range of probes are available to suit specific needs, including high temperatures and corrosive installations. SITRANS WM300 MFA consistently meets the needs of mining aggregate, cement and other primary and secondary industries.

- Key Applications: tail pulleys, motor shaft sensing, screw conveyor flights, bucket elevators

## SITRANS WM300 Motion failure alarm controller

## Design

## Mounting for Milltronics MSP-3, MSP-7, MSP-12, XPP-5

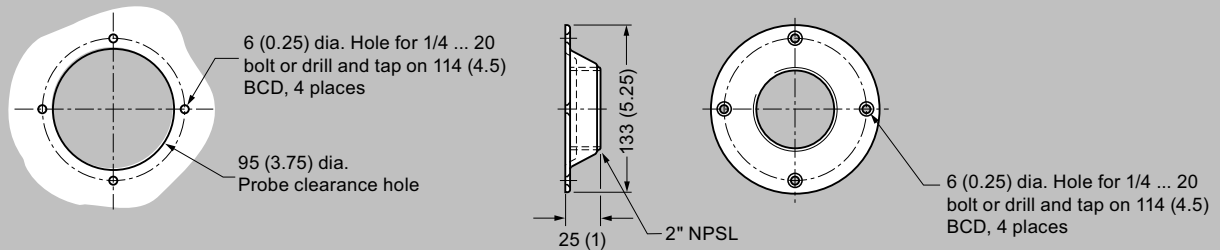

**Note:** Mounting flange supplied with probe.

## Mounting for Milltronics MSP-9

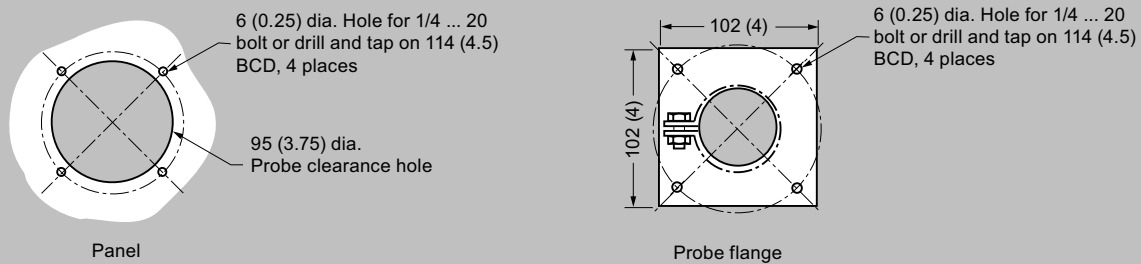

Milltronics MSP-12, MSP-3, MSP-7, MSP-9, XPP-5 mounting, dimensions in mm (inch)

**Standard Milltronics MSP-12**

- Heavy-duty general purpose motion probe
- Long lasting aluminum body with internal amplifier
- Convenient mounting flange and locknut for fast installation and setup
- Temperature rating: -40 ... +60 °C (-40 ... +140 °F)
- Enclosure rating: Type/NEMA 4X, 6, IP67

**High temperature Milltronics MSP-3**

- Heavy-duty, high temperature aluminum probe designed to withstand operating temperatures from -50 ... 260 °C (500 °F)
- Cast aluminum probe with convenient mounting flange and locknut
- 1.5 m (5 ft) of high temperature PTFE cable provided. Up to 30 m (100 ft) may be used.
- Enclosure rating: Type/NEMA 4X, 6, IP67

**Standard Milltronics MSP-7**

- Heavy-duty general purpose motion probe for direct connection to WM300 MFA
- Long lasting aluminum body
- Convenient mounting flange and locknut for fast installation and setup
- Temperature rating: -40 ... +60 °C (-40 ... +140 °F)
- Enclosure rating: Type/NEMA 4X, 6, IP67
- NPN, open collector output
- 24 V DC power supply

**Stainless high temperature Milltronics MSP-9**

- Heavy-duty, high temperature 304 stainless steel probe
- Special construction allows operation of probe in environment from -50 ... 260 °C (500 °F)
- 1.5 m (5 ft) special high temperature PTFE cable provided. Up to 30 m (100 ft) may be used.
- Enclosure rating: Type/NEMA 4X, 6, IP67

**Milltronics XPP-5**

- CSA hazardous approval (Class I, Div. 1, Groups A, B, C, D; Class II Div. 1, Groups E, F, G; Class III)
- Aluminum body that is fully potted
- Convenient mounting flange and locknut
- 3/4" NPT male hub connection
- Operating temperature from -40 ... 60 °C (-40 ... 140 °F)
- Enclosure rating: Type/NEMA 4X, 6, IP67

**Milltronics RMA (Remote Mounted Amplifier)**

- Available for internal mounted IMA in probe, or without and converting older existing applications into 3-wire NPN signals for use with WM300 MFA
- DIN rail mount
- Operating temp. from -40 ... +60 °C (-40 ... +140 °F)

Milltronics motion probes

## Selection and ordering data

Selection and ordering data	Article No.
<b>Motion Failure Alarm MFA, DSD, NCT</b> A highly sensitive dual setpoint motion sensor system, used with up to 2 MSP or XPP probes. Capable of hi/lo setpoint as well as differential monitoring with 2 additional probes.	7MH7701-0AA00-0A
<b>Remote Mounted Amplifier RMA</b> A remote mounted amplifier for 2 Milltronics MSP-1, MSP-3, MSP-9, MSP-12 and XPP-5 motion sensing probes.	7MH7702-0B
<b>Analog output module NCT</b> Additional module required for NCT applications featuring 2, 4 ... 20 mA outputs, used with WM300.	6ED1055-1MM00-0BA2
<b>Power conversion module</b> Convert 100 ... 240 V AC ... 24 V DC power, for use with WM300	6EP3331-6SB00-0AY0
<b>Remote display and configuration panel</b> Larger text display panel mount HMI for use with enclosure mounted WM300 for easy user access and monitoring.	6ED1055-4MH08-0BA1
<b>Operating Instructions</b> All literature is available to download for free, in a range of languages, at <a href="http://www.siemens.com/processinstrumentation/documentation">http://www.siemens.com/processinstrumentation/documentation</a> .	

## Technical specifications

<b>Mode of operation</b> Measuring principle Typical application	Motion monitor and alarm Monitoring loss of motion in tail pulley, screw flights, bucket elevators
<b>Features</b>	<ul style="list-style-type: none"> <li>Switch user configurable overspeed and underspeed detection</li> <li>Setpoint adjustment range:               <ul style="list-style-type: none"> <li>Standard model: 2 ... 5 000 Hz (120 ... 300 000 ppm)</li> <li>Slow speed version: 2 ... 400 seconds (30 ... 0.15 ppm)</li> </ul> </li> <li>Adjustable start-up time delay: 0 ... 60 seconds</li> <li>Visual indication of probe operation and relay status</li> </ul>
<b>Output</b> Resistive rating	4 relays <ul style="list-style-type: none"> <li>10 A at 24 V DC</li> <li>10 A at 240 V AC</li> </ul>
<b>Performance</b> Repeatability Dead band	± 1 % ± 0.25 %
<b>MSP and XPP dynamic range</b>	0 ... 7 200 PPM
<b>Ambient temperature range</b>	-20 ... +50 °C (-5 ... +122 °F)
<b>Storage temperature</b>	-20 ... +50 °C (-5 ... +122 °F)
<b>Design</b> Enclosure dimensions Enclosure material	71.5 x 90 x 60 mm (2.8 x 3.5 x 2.4 inch) Polycarbonate
<b>Power</b>	<ul style="list-style-type: none"> <li>10.8 ... 28.8 V DC, 25 ... 165 mA</li> <li>Power supply: 100 ... 240 V AC, 50/60 Hz, 0.7 ... 0.35 A per LOGO! power module</li> </ul>
<b>Certificates and approvals</b>	CE, UKCA, cCSA/ULus, FM, EAC, RCM, KC

SITRANS WM300 Motion failure alarm controller

Dimensional drawings

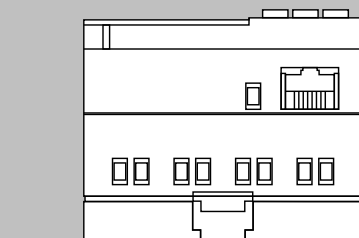
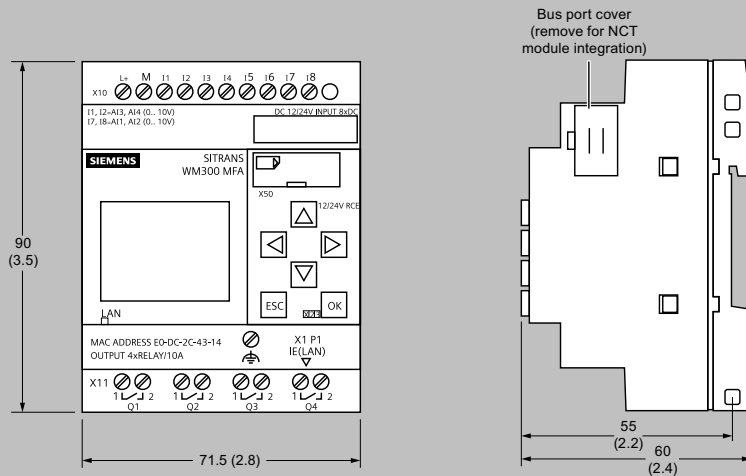

Standard Probe MSP-7, MSP-12

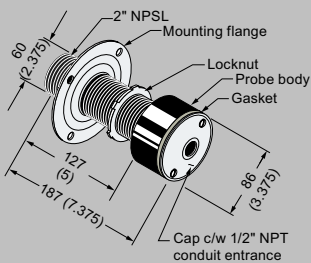

Hazardous Locations XPP-5

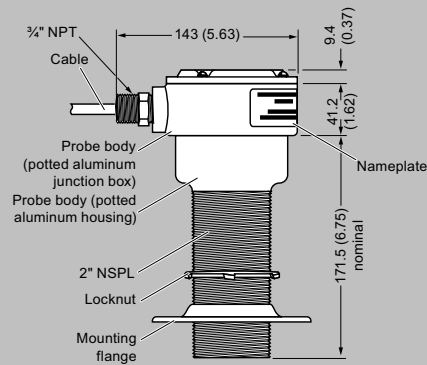

SITRANS WM300 MFA and probe, dimensions in mm (inch)

## Dimensional drawings (continued)

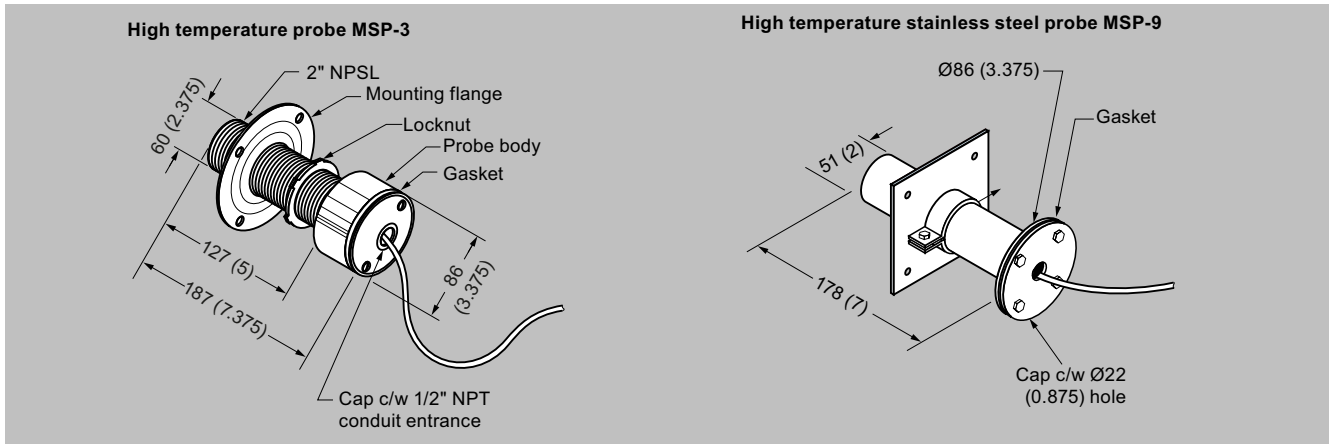

Milltronics probes, dimensions in mm (inch)