

Overview



The SITRANS FM MAG 6000 I/MAG 6000 I Ex de transmitter is designed for the demands in the process industry. The robust die-cast aluminum housing provides superb protection, even in the most harsh industrial environments. Full input and output functionality is given even in the Ex version.

Benefits

- Full range of Ex-rated flowmeters with intrinsically safe rated input and outputs
- For compact or remote installation
- HART, FOUNDATION Fieldbus H1, DeviceNet, PROFIBUS PA and DP, Modbus RTU/RS 485 add-on communication modules available
- Superior signal resolution for optimum turn down ratio
- Digital signal processing with many possibilities
- Automatic reading of SENSORPROM data for easy commissioning
- User configurable operation menu with password protection
 - 3 lines, 20 characters display in 11 languages
 - Flow rate in various units
 - Totalizer for forward, reverse and net flow as well as much more information available
- Multiple functional outputs for process control, minimum configuration with analogue, pulse/frequency and relay output (status, flow direction, limits)
- Comprehensive self-diagnostic for error indication and error logging
- Batch control
- Conforming to NAMUR recommendations NE 21, NE 32, NE 43, NE 53 and NE 70
- Self verification

Design

The transmitter is designed for either compact or remote installation in non-hazardous or hazardous areas (compact mounted transmitter to be ordered together with the sensor).

Function

The following functions are available:

- Flow rate
- 2 measuring ranges
- 2 totalizers
- Low flow cut-off
- Flow direction
- Error system
- Operating time
- Uni-/bidirectional flow
- Limit switches and pulse output
- Batch control

The MAG 6000 I/6000 I Ex de is a microprocessor-based transmitter with a built-in alphanumeric display in several languages. The transmitters evaluate the signals from the associated electromagnetic sensors and also fulfil the task of a power supply unit which provides the magnet coils with a constant current.

Further information on connection, mode of operation and installation can be found in the data sheets for the sensors.

Displays and keypads

Operation of the transmitter can be carried out using:

- Keypad and display unit
- HART communicator
- PC/laptop and SIMATIC PDM software via HART communication
- PC/laptop and SIMATIC PDM software using PROFIBUS or Modbus communication

Flow Measurement

SITRANS FM (electromagnetic)

Flow transmitters / SITRANS FM MAG 6000 I and 6000 I Ex

Selection and ordering data

SITRANS FM Transmitter MAG 6000 I Remote with standard wall mounting bracket, local display, die cast aluminum	Article No. 7ME6930-									
	2	B	A	●	●	-	1	●	A	7
Click on the Article No. for the online configuration in the PIA Life Cycle Portal.										
Supply voltage										
Standard transmitter: 18 ... 90 V DC; 115 ... 230 V AC, 50 ... 60 Hz									2	
Ex transmitter: 18 ... 30 V DC									4	
Ex transmitter: 115 ... 230 V AC, 50 ... 60 Hz									5	
Ex approval										
Standard sensor: FM Class I, Div 2, CSA Class I, Div 2									0	
Standard sensor: no approval for use in hazardous areas									1	
Ex sensor: Hazardous area (ATEX 2 GD; FM Class I, Zone 1; CSA Class I, Zone 1)									2	
Communication										
None										A
HART										B
PROFIBUS PA Profile 3										F
PROFIBUS DP Profile 3 (not for Ex version)										G
Modbus RTU/RS 485 (not for Ex version)										E
FOUNDATION Fieldbus H1										J
Cable gland entries										
Metric										0
½" NPT										2

1) Product Variation Request (PVR).

Further design	Order code
Please add "-Z" to Article No. and specify Order code(s) and plain text	
Tag name plate, stainless steel (specify in plain text)	Y17
Tag name plate, plastic (self-adhesive)	Y18
Special version (specify in plain text)	Y99

Communication modules for MAG 6000 I (All standard outputs can still be used)

Description	Article No.
HART (only for MAG 6000 I/Ex)	FDK:085U0321
Modbus RTU/RS 485 ¹⁾	FDK:085U0234
PROFIBUS PA Profile 3	FDK:085U0236
PROFIBUS DP Profile 3 ¹⁾	FDK:085U0237
DeviceNet ¹⁾	FDK:085U0229
FOUNDATION Fieldbus H1	A5E02054250







1) Not for Ex versions

Accessories for MAG 6000 I/6000 I Ex

Description	Article No.
Standard coil or electrode cable 3 × 1.5 mm ² /18 gage, single shielded with PVC jacket Temperature range: -30 ... +70 °C (-22 ... +158 °F)	
• 5 m (16.5 ft)	A5E02296523
• 10 m (33 ft)	FDK:083F0121
• 20 m (65 ft)	FDK:083F0210
• 30 m (98 ft)	A5E02297309
• 40 m (131 ft)	FDK:083F0211
• 50 m (164 ft)	A5E02297317
• 60 m (197 ft)	FDK:083F0212



Selection and ordering data (continued)

Description	Article No.	
<ul style="list-style-type: none"> • 100 m (328 ft) • 150 m (492 ft) • 200 m (656 ft) • 500 m (1640 ft) 	FDK:083F0213 FDK:083F3052 FDK:083F3053 FDK:083F3054	
Special electrode cable (empty pipe detection or low conductivity) 3 × 0.25 mm ² , double shielded with PVC jacket Temperature range: -30 ... +70 °C (-22 ... +158 °F) <ul style="list-style-type: none"> • 10 m (33 ft) • 20 m (65 ft) • 40 m (131 ft) • 60 m (197 ft) • 100 m (328 ft) • 150 m (492 ft) • 200 m (656 ft) • 500 m (1640 ft) 	FDK:083F3020 FDK:083F3095 FDK:083F3094 FDK:083F3093 FDK:083F3092 FDK:083F3056 FDK:083F3057 FDK:083F3058	
Cable kit including standard coil cable and special electrode cable Standard coil cable: 3 × 1.5 mm ² / 18 gage, single shielded with PVC jacket Special electrode cable: 3 × 0.25 mm ² , double shielded with PVC jacket Temperature range: -30 ... +70 °C (-22 ... +158 °F) <ul style="list-style-type: none"> • 5 m (16.5 ft) • 10 m (33 ft) • 15 m (49 ft) • 20 m (65 ft) • 25 m (82 ft) • 30 m (98 ft) • 40 m (131 ft) • 50 m (164 ft) • 60 m (197 ft) • 100 m (328 ft) • 150 m (492 ft) • 200 m (656 ft) • 500 m (1640 ft) 	A5E02296329 A5E01181647 A5E02296464 A5E01181656 A5E02296490 A5E02296494 A5E01181686 A5E02296498 A5E01181689 A5E01181691 A5E01181699 A5E01181703 A5E01181705	
Low noise electrode coax cable for low conductivity and high vibration levels 3 × 0.13 mm ² . Temperature range -25 °C ... +85 °C (-13 °F ... +185 °F) <ul style="list-style-type: none"> • 2 m (6.6 ft) • 5 m (16.5 ft) • 10 m (33 ft) 	A5E02272692 A5E02272723 A5E02272730	

Spare parts





Description	Article No.	
Display unit	FDK:085U3122	

Flow Measurement

SITRANS FM (electromagnetic)

Flow transmitters / SITRANS FM MAG 6000 I and 6000 I Ex

Selection and ordering data (continued)

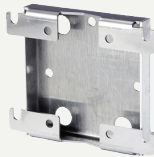
Description	Article No.	
Accessory bag including cable gland inserts and connectors for sensor cables	FDK:085U3144	
Display lid (non-Ex, Ex) in die-cast aluminum, with corrosion resistant coating (min. 60 µm)	7ME5933-0AC01	
Blind lid for sensor cables connection compartment (only remote version) in die-cast aluminum, with corrosion resistant coating (min. 60 µm) incl. O-ring seal	7ME5933-0AC02	
Blind lid (mains supply, input/outputs) in die-cast aluminum, with corrosion resistant coating (min. 60 µm)	7ME5933-0AC03	
Safety clamp	7ME5933-0AC06	
Standard wall-mounting bracket, stainless steel AISI 316L/1.4404	7ME5933-0AC04	
Special wall-mounting bracket, BI 2.5 DIN 59382 X6Cr17	7ME5933-0AC05	

Complete spare part PCB unit

Description	Article No.	
MAG 6000 I std. (not for Ex), 18 ... 30 V DC; 115 ... 230 V AC Spare PCBA	FDK:085U3123	
MAG 6000 I Ex d 115 ... 230 V AC Spare PCBA only for use with Ex approved sensor and explosion protection "Increased safety" (Ex e)	A5E01013127	
MAG 6000 I Ex d 18 ... 30 V DC Spare PCBA only for use with Ex approved sensor and explosion protection "Increased safety" (Ex e)	A5E01013340	

Please use online Product selector to get latest updates.

Selection and ordering data (continued)

Product selector link:

<http://www.pia-portal.automation.siemens.com>

Technical specifications

MAG 6000 I and MAG 6000 I Ex	
Mode of operation	
Measuring principle	Electromagnetic with pulsed constant field
Empty pipe	Detection of empty pipe (special cable required in remote mounted installation)
Excitation frequency	Depend on sensor size
Electrode input impedance	$> 1 \times 10^{14} \Omega$
Input	
Digital input	11 ... 30 V DC, $R_i = 4.4 \text{ k}\Omega$
• Activation time	50 ms
• Current	$I_{11 \text{ V DC}} = 2.5 \text{ mA}$, $I_{30 \text{ V DC}} = 7 \text{ mA}$
Output	
Current output	
• Signal range	4 ... 20 mA (active/passive)
• Load	$< 560 \Omega$
• Time constant	0.1 ... 30 s, adjustable
Digital output	
• Frequency	0 ... 10 kHz, 50 % duty cycle (uni-/bidirectional)
• Time constant	0.1 ... 30 s, adjustable
• Pulse (passive)	3 ... 30 V DC, max. 110 mA (30 mA Ex version), $200 \Omega \leq R_i \leq 10 \text{ k}\Omega$ (powered from connected equipment)
• Time constant	0.1 ... 30 s, adjustable
Relay output	
• Time constant	Changeover relay, same as current output
• Load	42 V AC/2 A, 24 V DC/1 A
Low flow cut off	0 ... 9.9 % of maximum flow
Galvanic isolation	All inputs and outputs are galvanic isolated.
Max. measuring error	
MAG 6000 I/MAG 6000 I Ex (incl. sensor)	$\pm 0.2 \% \pm 1 \text{ mm/s}$
Rated operation conditions	
Ambient temperature	
• Operation	
- MAG 6000 I ²⁾	-20 ... +60 °C (-4 ... +140 °F)
- MAG 6000 I Ex ²⁾	-20 ... +60 °C (-4 ... 140 °F)
• Storage	-40 ... +70 °C (-40 ... +158 °F)
Mechanical load	18 ... 1000 Hz random in x, y, z, directions for 2 hours according to EN 60068-2-36 Transmitter: 1.14 g RMS
Degree of protection	IP67/NEMA 4X to IEC 529 and DIN 40050 (1 mH ₂ O 30 min.)
EMC performance	<ul style="list-style-type: none"> • IEC/EN 61326-1 (all environments) • IEC/EN 61326-2-5 • NAMUR NE 21
Display and keypad	
Totalizer	Two eight-digit counters for forward, net or reverse flow
Display	Background illumination with alphanumeric text, 3 x 20 characters to indicate flow rate, totalized values, settings and faults; Reverse flow indicated by negative sign
Keypad	Capacitive touch keypad with LED light for feedback indication
Time constant	Time constant as current output time constant

Technical specifications (continued)

MAG 6000 I and MAG 6000 I Ex	
Design	
Enclosure material	Die-cast aluminum, with corrosion resistant Basic Polyester powder coating (min. 60 μm)
• Wall mounting	Wall mounting bracket enclosed for remote version
Dimensions	See dimensional drawings
Weight	See dimensional drawings
Power supply	
	<ul style="list-style-type: none"> • Standard transmitter: 18 ... 90 V DC; 115 ... 230 V AC; 50 ... 60 Hz • Ex transmitter: 18 ... 30 V DC • Ex transmitter: 115 ... 230 V AC; 50 ... 60 Hz
Power consumption	<ul style="list-style-type: none"> • 230 V AC: 20 VA • 24 V DC: 9.6 W, $I_N = 0.4 \text{ A}$, $I_{ST} = 1 \text{ A}$ (3 ms)
Certificates and approvals	
General purpose	• CE (LVD, EMC, PED, RoHS)
Hazardous areas	<ul style="list-style-type: none"> • ATEX, IECEx, FM, CSA, EAC Ex, NEPSI <ul style="list-style-type: none"> - Zone 1 Ex d e [ia] ia IIC T6 Gb • ATEX, IECEx, CSA <ul style="list-style-type: none"> - Zone 21 Ex tD A21 IP67 T85 °C • FM <ul style="list-style-type: none"> - XP IS Class I Div. 1 Groups A, B, C, D - DIP Class II+III Div. 1 Groups E, F, G
Others	<ul style="list-style-type: none"> • CPA (China) • EAC (Russia, Belarus, Kazakhstan) • KCs (South Korea)
Cable entries	
MAG 6000 I	
• Power supply and outputs	2 × M20 (HART)/M25 (PROFIBUS) or 2 × 1/2" NPT (HART)
• Sensor connection	2 × M16 or 2 × 1/2" NPT
MAG 6000 I Ex ATEX 2G D	
• Power supply and outputs	2 × M20
• Sensor connection	2 × M16
Communication	
Standard versions	HART, Modbus RTU/RS 485, FOUNDATION Fieldbus H1, DeviceNet, PROFIBUS PA, PROFIBUS DP add-on modules
Ex versions	HART, PROFIBUS PA (not for Ex version)

1) Applicable for: Compact mounted MAG 6000 I Ex on MAG 3100, sizes DN 15 ... 300 (1/2" ... 12").

2) With HART communication max. ambient temperature 50 °C (122 °F).

Flow Measurement

SITRANS FM (electromagnetic)

Flow transmitters / SITRANS FM MAG 6000 I and 6000 I Ex

Dimensional drawings

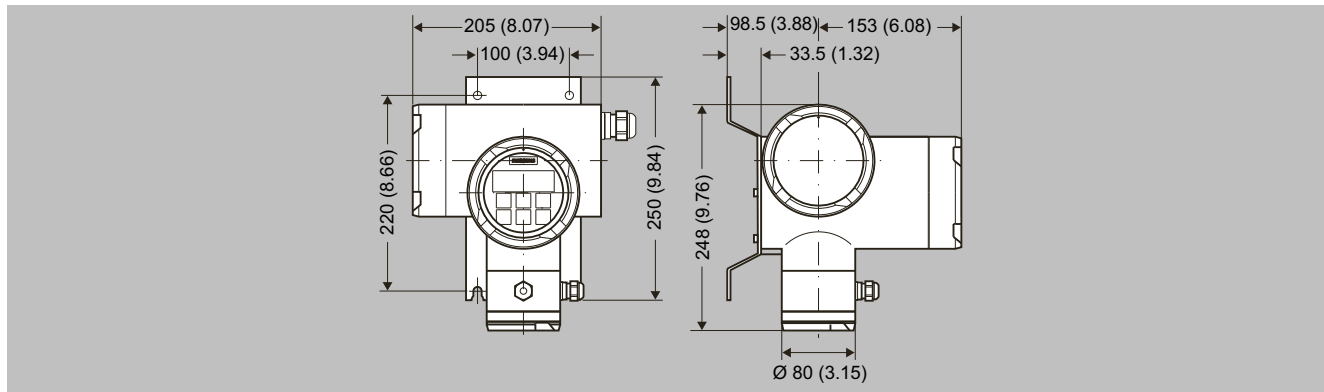

SITRANS FM transmitter MAG 6000 I with wall-mounting bracket, dimensions in mm (inch)