

SIEMENS

SICAM Fault Sensor Indicator

V03.11

Manual

Preface

Table of Contents

Delivery

1

Overview

2

Getting Started

3

Device Functions

4

SICAM FSI Configurator

5

Technical Data

6

Type Testing

7

Maintenance

8

Troubleshooting

9

Firmware and Configurator Version

Compatibility with SICAM FSI

A

SICAM FSI ACSR Cable Types and Diameter

B

Literature

Index

**NOTE**

For your own safety, observe the warnings and safety instructions contained in this document, if available.

Disclaimer of Liability

Subject to changes and errors. The information given in this document only contains general descriptions and/or performance features which may not always specifically reflect those described, or which may undergo modification in the course of further development of the products. The requested performance features are binding only when they are expressly agreed upon in the concluded contract.

Document version: E50417-H1040-C587-C1.00

Edition: 07.2022

Version of the product described: V03.11

Copyright

Copyright © Siemens 2022. All rights reserved.

The disclosure, duplication, distribution and editing of this document, or utilization and communication of the content are not permitted, unless authorized in writing. All rights, including rights created by patent grant or registration of a utility model or a design, are reserved.

Trademarks

SIPROTEC, DIGSI, SIGRA, SIGUARD, SIMEAS, SAFIR, SICAM, and MindSphere are trademarks of Siemens. Any unauthorized use is prohibited.

Preface

Purpose of the Manual

This manual describes the application, functions, installation, commissioning, and operation of the Fault Sensor Indicator 6MD2314.

Target Audience

This manual is intended for project engineers, commissioning engineers, and operating personnel in electrical systems and substations.

Scope

This manual is valid for the Fault Sensor Indicator 6MD2314.

Indication of Conformity



This product complies with the directive of the Council of the European Communities on the harmonization of the laws of the Member States relating to electromagnetic compatibility (EMC Directive 2014/30/EU) and concerning electrical equipment for use within specified voltage limits (Low Voltage Directive 2014/35/EU) as well as restriction on usage of hazardous substances in electrical and electronic equipment (RoHS Directive 2011/65/EU).

This conformity has been proved by tests conducted by Siemens AG in accordance of the Council Directive in accordance with the product standard IEC/EN 61326-1 for the EMC directives, and with the standard IEC/EN 61010-1 for the low-voltage directive.

Standards for short-range radio and mobile communication acc. to RED directive 2014/53/EU:

- EMC testing acc. to EN 301 489
- Short-range radio acc. to EN 300 328

RoHS directive 2011/65/EU is met using the standard IEC/EN 63000.

The device has been designed and produced for industrial use.

Standards

EN IEC 62368-1

FCC Conformity Information

This device complies with part 15 of the FCC rules. Operation is subject to the following 2 conditions:

- This device may not cause harmful interference.
- This device must accept any interference received, including interference that may cause undesired operation.

This equipment has been tested and found to comply with the limits for a Class A digital device, pursuant to part 15 of the FCC rules. These limits are designed to provide reasonable protection against harmful interference when the equipment is operated in a commercial environment. This equipment generates, uses, and can radiate radio frequency energy and, if not installed and used in accordance with the instructions, may cause harmful interference to radio communications. Operation of this equipment in a residential area is likely to cause harmful interference in which case the user will be required to correct the interference at their own expense.



NOTE

Any changes or modifications not expressly approved by the party responsible for compliance could void the users' authority to operate this equipment.



CAUTION

Radiation RF exposure

This equipment complies with FCC radiation exposure limits set forth for an uncontrolled environment.

- ✧ This equipment should be installed and operated with minimum distance 20 cm between the radiator and your body.
-

ISED Compliance Statement

This device complies with ISED's license-exempt RSSs. Operation is subject to the following 2 conditions:

- This device may not cause harmful interference.
- This device must accept any interference received, including interference that may cause undesired operation.

Cet appareil est conforme aux RSS exemptés de licence de l'ISED. L'opération est soumise aux 2 conditions suivantes :

- Cet appareil peutne pas causer d'interférences nocives.
 - Cet appareil doit accepter toute interférence, y compris les interférences qui peuvent provoquer un fonctionnement non désiré de l'appareil.
-



CAUTION

Radiation RF exposure

This equipment complies with ISED radiation exposure limits set forth for an uncontrolled environment.

- ✧ This equipment should be installed and operated with minimum distance 20 cm between the radiator and your body.
-



CAUTION

Déclaration sur l'exposition aux rayonnements

Cet équipement est conforme aux limites d'exposition aux rayonnements. ISED établies pour un environnement non contrôlé.

- ✧ Cet équipement doit être installé et actionné avec la distance minimale 20 cm entre le radiateur et votre corps.
-

Detachable Antenna Usage

This radio transmitter (IC: 5123A-GM210P) has been approved by ISED to operate with the antenna type listed below with maximum permissible gain indicated. Antenna types not included in this list, having a gain greater than the maximum gain indicated for that type, are strictly prohibited for use with this device.

Antenna Name	Antenna Type	Antenna Gain (dBi)	Transmitting Power Level	Antenna Part No.
Onchip Ceramic Antenna	Integral Antenna	1.86 dBi	20 dBm	–



NOTE

- The RF module supports BLE protocol which is not required for the host application, hence it is disabled through software and not used in host product application.
- The device integrates a ZigBee transmitter having FCC ID: QOQGM210P, IC ID: 5123A-GM210P for radio communication. The RF module is integrated to this host product as per module integration guidelines defined in module grant and FCC KDB 996369.
- RF exposure evaluation for ZigBee protocol is evaluated for 20 cm distance and results are compliant to FCC and IC RF exposure requirements.

Module Name	FCC ID	IC ID	Operating Frequency Range
ZigBee module	QOQGM210P	5123A-GM210P	2405 MHz to 2480 MHz

Customer Support Center

Our Customer Support Center provides a 24-hour service.

Siemens AG

Smart Infrastructure – Protection Automation

Customer Support Center

Tel.: +49 911 2155 4466

E-Mail: energy.automation@siemens.com

Additional Support

For questions about the system, contact your Siemens sales partner.

Training Courses

Inquiries regarding individual training courses should be addressed to our Training Center:

Siemens AG

Siemens Power Academy TD

Humboldtstraße 59

90459 Nuremberg

Germany

Phone: +49 911 9582 7100

E-mail: poweracademy@siemens.com

Internet: www.siemens.com/poweracademy

Notes on Safety

This document is not a complete index of all safety measures required for operation of the equipment (module or device). However, it comprises important information that must be followed for personal safety, as well as to avoid material damage. Information is highlighted and illustrated as follows according to the degree of danger:



DANGER

DANGER means that death or severe injury **will** result if the measures specified are not taken.

- ✧ Comply with all instructions, in order to avoid death or severe injuries.
-



WARNING

WARNING means that death or severe injury **may** result if the measures specified are not taken.

- ✧ Comply with all instructions, in order to avoid death or severe injuries.
-



CAUTION

CAUTION means that medium-severe or slight injuries **can** occur if the specified measures are not taken.

- ✧ Comply with all instructions, in order to avoid moderate or minor injuries.
-

NOTICE

NOTICE means that property damage **can** result if the measures specified are not taken.

- ✧ Comply with all instructions, in order to avoid property damage.
-



NOTE

Important information about the product, product handling or a certain section of the documentation which must be given attention.

Qualified Electrical Engineering Personnel

Only qualified electrical engineering personnel may commission and operate the equipment (module, device) described in this document. Qualified electrical engineering personnel in the sense of this document are people who can demonstrate technical qualifications as electrical technicians. These persons may commission, isolate, ground and label devices, systems and circuits according to the standards of safety engineering.

Proper Use

The equipment (device, module) may be used only for such applications as set out in the catalogs and the technical description, and only in combination with third-party equipment recommended and approved by Siemens.

Problem-free and safe operation of the product depends on the following:











- Proper transport
- Proper storage, setup and installation
- Proper operation and maintenance

When electrical equipment is operated, hazardous voltages are inevitably present in certain parts. If proper action is not taken, death, severe injury or property damage can result:

- The equipment must be grounded at the grounding terminal before any connections are made.
- All circuit components connected to the power supply may be subject to dangerous voltage.

- Hazardous voltages may be present in equipment even after the supply voltage has been disconnected (capacitors can still be charged).
- Operation of equipment with exposed current-transformer circuits is prohibited. Before disconnecting the equipment, ensure that the current-transformer circuits are short-circuited.
- The limiting values stated in the document must not be exceeded. This must also be considered during testing and commissioning.

Selection of Used Symbols on the Device

No.	Symbol	Description
1		Direct current, IEC 60417, 5031
2		Alternating current, IEC 60417, 5032
3		Direct and alternating current, IEC 60417, 5033
4		Earth (ground) terminal, IEC 60417, 5017
5		Protective conductor terminal, IEC 60417, 5019
6		Caution, risk of electric shock
7		Caution, risk of danger, ISO 7000, 0434
8		Protective Insulation, IEC 60417, 5172, Safety Class II devices
9		Guideline 2002/96/EC for electrical and electronic devices
10		Guideline for the Eurasian Market
11		Mandatory Conformity Mark for Electronics and Electrotechnical Products in Morocco

OpenSSL

This product includes software developed by the OpenSSL Project for use in OpenSSL Toolkit (<http://www.openssl.org/>).

This product includes software written by Tim Hudson (tjh@cryptsoft.com).

This product includes cryptographic software written by Eric Young (ey@cryptsoft.com).

Table of Contents

	Preface	3
1	Delivery	11
	1.1 Delivery.....	12
2	Overview	13
	2.1 SICAM Fault Sensor Indicator (FSI)	14
	2.2 Ordering Information.....	17
	2.2.1 SICAM FSI - Selection and Ordering Data.....	17
3	Getting Started	19
	3.1 SICAM FSI Unpacking and Inspecting the Delivery.....	20
	3.2 Installation.....	21
	3.2.1 SICAM FSI Installation.....	21
	3.3 SICAM FSI Mounting.....	30
	3.3.1 SICAM FSI Mounting Methods	30
	3.3.2 Mounting SICAM FSI using Hot Stick with Shotgun.....	30
	3.3.3 Mounting SICAM FSI using Hot Stick (Telescopic) with Device Adaptor.....	35
	3.4 Commissioning.....	47
	3.4.1 SICAM FSI Commissioning	47
	3.5 SICAM FSI Unmounting	56
	3.6 Updating the Device Firmware.....	59
	3.6.1 Updating the SICAM FSI Firmware via the UART Cable	59
	3.6.2 Updating SICAM FSI with Integrated Communication Firmware via the SICAM FCG Web GUI.....	60
4	Device Functions	63
	4.1 Device Functions.....	64
	4.1.1 Network Parameters.....	64
	4.1.2 Permanent-Fault Verification Time (PFVT).....	64
	4.1.3 Fault Detection	65
	4.1.4 Fault Resets	68
	4.1.5 Inrush Restraint	69
	4.1.6 Auto-Reclosure.....	70
	4.1.7 Self Test.....	71
	4.1.8 Battery Health	71
	4.1.9 Short-Range Radio (Wireless) Communication Module Check.....	72
	4.1.10 SICAM FSI LED Flashing Sequence.....	72
	4.1.11 Energy Harvesting.....	72
	4.1.12 Low Temperature Cutoff.....	72

4.2	Short-Range Radio (Wireless) Communication.....	73
4.2.1	Overview	73
4.2.2	SICAM FSI Measured Values.....	74
4.2.3	Fault Alarms	75
4.2.4	Resetting SICAM FSI from SICAM FCG.....	76
4.2.5	Communication Test Mode	76
5	SICAM FSI Configurator.....	79
5.1	Overview.....	80
5.2	Computer Configuration Requirements	81
5.3	SICAM FSI Configurator Installation.....	82
5.4	Control Functions.....	98
5.5	Starting the SICAM FSI Configurator User Interface	99
5.6	Dashboard.....	101
5.6.1	SICAM FSI Configurator Dashboard.....	101
5.6.2	Device Information	101
5.6.3	Settings.....	102
5.7	Basic Parameter Settings	104
5.8	Advanced Parameter Settings.....	106
5.9	Device Info	110
5.10	Device Settings.....	111
5.10.1	Reset to Factory Settings	111
5.10.2	Backup Device Settings	111
5.10.3	Restore Device Settings	112
5.10.4	Updating Firmware.....	116
5.11	Log off	121
5.12	SICAM FSI Configurator Uninstallation	122
6	Technical Data.....	125
7	Type Testing.....	127
7.1	Type Testing.....	128
8	Maintenance.....	131
8.1	Replacing the Battery	132
8.2	Environmental Protection Hints.....	139
9	Troubleshooting.....	141
9.1	Troubleshooting	142
9.2	Shipping Instructions – Field Returns.....	145
A	Firmware and Configurator Version Compatibility with SICAM FSI.....	149
A.1	Firmware and Configurator Version Compatibility with SICAM FSI.....	150
B	SICAM FSI ACSR Cable Types and Diameter.....	151
B.1	Aluminum Conductor Steel Reinforced (ACSR) Cable Type and Diameter.....	152
	Literature.....	153
	Index.....	155

1 Delivery

1.1	Delivery	12
-----	----------	----

1.1 Delivery

Delivery Note

SICAM FSI is delivered in a cardboard box printed with Siemens logo.

Scope of Delivery

The scope of delivery are:

- 1 SICAM FSI according to ordering information
- 1 Printed Circuit Board Assembly (PCBA)
- 1 quick reference guide
- 1 document with safety instructions



WARNING

Danger of explosion of the battery.

Noncompliance with the safety instructions means that death, severe injuries, or considerable material damages can occur.

- ✧ Do not throw the SICAM FSI device or PCBA containing a battery into a fire.
- ✧ Do not tamper SICAM FSI battery and PCBA containing a battery.



NOTE

The SICAM FSI as a device and the lithium battery (cylindrical cell) as a spare part has to be treated as Dangerous Goods, Class 9 during transport. You can find more details and shipping advises in the certificate "Dangerous Goods Information SICAM FSI" on the SIOS website:

<https://support.industry.siemens.com/cs/start?lc=en-WW>



NOTE

Due to Dangerous Goods Regulations of Lithium metal batteries contained in equipment, the SICAM FSI device is forbidden to transport when it is activated.

Refer to instructions [3.1 SICAM FSI Unpacking and Inspecting the Delivery](#) for factory-packed instructions. Before transportation field return devices, the battery must not be packed in device packaging and also in device housing. Refer to instructions [9.2 Shipping Instructions – Field Returns](#) for more details.

2 Overview

2.1	SICAM Fault Sensor Indicator (FSI)	14
2.2	Ordering Information	17

2.1 SICAM Fault Sensor Indicator (FSI)

Description

SICAM Fault Sensor Indicator (FSI) detects the phase fault and ground fault when it is mounted on the MV overhead line. The SICAM FSI indicates both the temporary fault and the permanent fault via LED flashing and communicates the fault information via the gateway device SICAM Fault Collector Gateway (FCG).

The SICAM FSI is used to improve the distribution grid reliability and to reduce the power outage time on the MV overhead line. The SICAM FSI can be mounted in groups of 3 or 6 or 9 on each phase after the branching points and sectionalizer.

The device is available in the following variants:

- **SICAM FSI (6MD2314 - 1Ax10)**
The device indicates the faults directly with LEDs flashing. Depending on the fault type, a specific LED flashing sequence is generated.
- **SICAM FSI with integrated communication (6MD2314 - 1Ax11)**
In addition to the LED flashing, phase fault and ground fault events are communicated to the SICAM FCG via a secured short-range radio (wireless) communication. The SICAM FCG communicates fault information to the control center/MindSphere cloud using the selected communication protocol via General Packet Radio Service (GPRS) network.

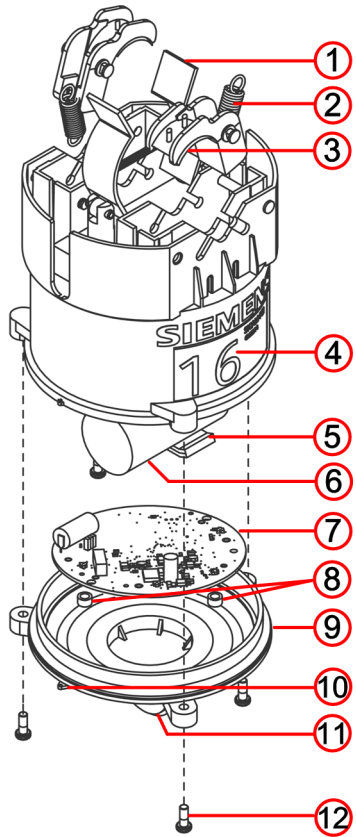

[le_sfsi_device, 2, ...]

Figure 2-1 SICAM FSI Device

- (1) Clamp
- (2) Spring for hook
- (3) Mounting hook
- (4) Device label
- (5) Voltage detection plate

- (6) Battery
- (7) Printed circuit board assembly (PCBA)
- (8) Mounting boss
- (9) Transparent cover
- (10) Seal through hole
- (11) Eye hook
- (12) Screws

Features

The salient features of the SICAM FSI are:

- The device monitors the phase current and detects the presence and absence of voltage on the MV overhead lines
- The device detects and indicates the phase fault and ground fault
- The device is configurable for phase faults and rate of change of current fault (di/dt) (ground faults)
- The device adapts to the rated MV overhead line voltage as per the Rated voltage (V_{rated}) parameter selected
- The device supports installation on both insulated and non-insulated overhead cables
- The phase and di/dt fault indication can be reset via the following:
 - Voltage restoration in MV overhead line
 - Auto timer reset
 - Manual reset via magnet adaptor
 - Remote reset via the SICAM FCG
- The device indicates the fault via 6 high luminous red LEDs for long-distance visibility to the patrol team in all directions
- The device has inrush-restraint time function which is used to restraint the fault detection during the MV overhead line energization
- The device is self sustained with a minimum of 10 years of battery life, under standard operating conditions
- The device has an energy harvesting capability which can enhance the battery life beyond 10 years
- The device is easily and safely mountable on the MV overhead line by using a hot stick with shotgun or hot stick (telescopic) with device adaptor
- The device is designed with robust IP68 and UV resistant housing
- The device has maintenance-free operation
- The device can be configured in close coordination with the protection systems in the MV network for better fault detection and localization
- The SICAM FSI with integrated communication uses the short-range radio to communicate with SICAM FCG. The GPRS interface in SICAM FCG is used for transmitting the fault information to a control center using standardized telecontrol protocols. The fault indication can also be reset remotely from the control center
- The device fault parameters and other settings are remotely configurable for the SICAM FSI with integrated communication
- The device is suitable for outdoor applications on MV overhead line.

Applications

SICAM FSI is used in the following areas of application:

Table 2-1 Device Applications

Rated voltage (V_{rated})	3.3 kV, 6.6 kV, 11 kV, 22 kV, 33 kV, 44 kV ¹ , 66 kV (non-insulated cable) 6.6 kV, 11 kV, 22 kV, 33 kV, 44 kV ¹ , 66 kV (insulated cable) NOTE: For ANSI voltage nominal ranges, you can select the nearest rated voltage. For example, for 69 kV ANSI voltage, please select 66 kV rated voltage.
Maximum operating voltage	72 kV
Maximum operating current	1500 A
Maximum continuous operating current	800 A
Operating current range (with $\pm 10\%$ accuracy)	50 A to 800A
System frequency	50 Hz or 60 Hz network
Grounding type	Solidly grounded system or resistive star-point grounded systems
Conductor overall diameter	5 mm to 40 mm (Non-insulated) 15 mm to 40 mm (Insulated) ²
Non-insulated conductor type	Aluminium Conductor Steel Reinforced (ACSR)
Insulated conductor type	Single core, aluminium conductor steel reinforced with/without water-blocking, XLPE insulated

¹ The 44 kV setting option is only available for combination of SICAM FSI with firmware version V03.03 or higher and SICAM FCG with firmware version V04.12 or higher.

² SICAM FSI with conductor overall diameter 5mm to 15mm (Insulated) can be ordered only on a special request. Contact the local Siemens office for more information.

2.2 Ordering Information

2.2.1 SICAM FSI - Selection and Ordering Data

Selection and Ordering Data

Table 2-2 SICAM FSI Selection and Ordering Data

Description	Versions	Order no.												
		1	2	3	4	5	6	7	8	9	10	11	12	
		6	M	D	2	3	1	4	-	1	A	□	1	□
												▲		▲
SICAM FSI														
	<ul style="list-style-type: none"> Phase-fault detection Ground-fault (di/dt) detection UV stabilised polycarbonate IP68 rated housing Operating temperature range: -25°C to +70°C 											B		
	<ul style="list-style-type: none"> Phase-fault detection Ground-fault (di/dt) detection UV stabilised polycarbonate IP68 rated housing Operating temperature range: -40°C to +70°C 											C		
	Visual fault indication of 40 lumens by 6 high luminous red LEDs													0
	Visual fault indication of 40 lumens by 6 high luminous red LEDs SICAM FSI with integrated communication, short-range radio communication for fault status and measured values ³													1
Spare parts and accessories		6	M	D	2	3	1	8	-	4	□	□	0	□
												▲	▲	▲
Spare part														
	SICAM FSI Li-TH Battery Set (Pack of 6)											B	B	0
Accessories														
	UART cable for device configuration (recommended type: FTDI chip, part number TTL-232R-RPi) For more detailed information visit: http://www.ftdi-chip.com											A	A	0
	Magnetic adaptor for device reset, accessory for hot stick with shotgun or hot stick (telescopic)											M	A	4
	Device adaptor for SICAM FSI mounting via hot stick (telescopic)											M	A	5
Accessory Description														

³ SICAM FSI with integrated communication along with SICAM FCG (6MD2340-3JM71-8AA2) must be ordered when the communication with control center is required.

Description	Versions	Order no.
Hot stick with shotgun for SICAM FSI mounting, 4 m	Recommended brand: Terex hot stick with shotgun, Ritz, catalog number: RC403-0295 For more detailed information visit: http://www.terexutilities.com.br	
	Recommended brand: Hubbell hot stick with shotgun, catalog number: C4030295 For more detailed information visit: https://www.hubbell.com/hubbellpowersystems/en/	
Hot stick (telescopic) for SICAM FSI mounting, 12 m	Recommended brand: Terex Ritz, catalog no.: VTT-1/9 For more detailed information visit: http://www.terexutilities.com.br	

**NOTE**

For markets requiring FCC certification and ISED certification, SICAM FSI with integrated communication should be ordered as: 6MD2314-1AC11 along with SICAM FCG (6MD2340-3JM71-8AA2 -Z /DD).

3 Getting Started

3.1	SICAM FSI Unpacking and Inspecting the Delivery	20
3.2	Installation	21
3.3	SICAM FSI Mounting	30
3.4	Commissioning	47
3.5	SICAM FSI Unmounting	56
3.6	Updating the Device Firmware	59

3.1 SICAM FSI Unpacking and Inspecting the Delivery

Unpacking

SICAM FSI has been factory-packed for safe transport. Due to **Dangerous Goods Regulations (DGR) for shipping Lithium batteries**, the SICAM FSI Printed Circuit Board Assembly (PCBA) is packed separately when it is shipped from factory and 3-pin (X6) jumper pin on PCBA is kept in OFF position.

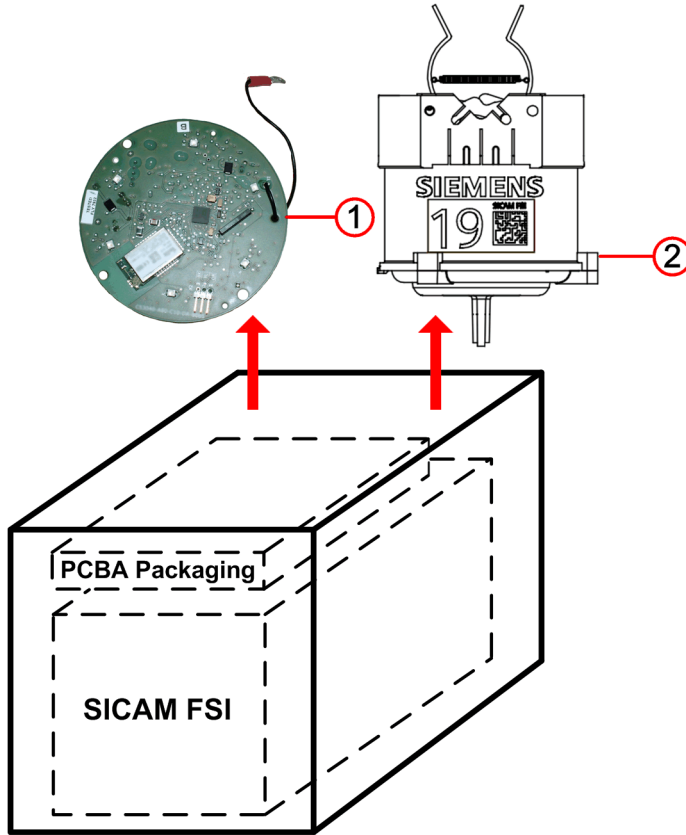

SICAM FSI Packaging

[idw_sfsi_dangdspkg, 2, --]

Figure 3-1 SICAM FSI and PCBA Packaging from Factory

- (1) SICAM FSI PCBA
- (2) SICAM FSI

Unpack the device carefully and do not use force. Use an appropriate tool if necessary.

Inspecting the Delivery

After unpacking, first check that all the necessary and ordered items are enclosed as per [Scope of Delivery, Page 12](#). Then inspect the device visually for any mechanical damage.



NOTE

If the device has been damaged during transport, do not connect and operate it.

Read the instructions carefully which are enclosed with the packaging and keep the transport packaging for future transport.

In any event of shipping for field returns, the SICAM FSI must be transported as shown in [Figure 9-3](#).

3.2 Installation

3.2.1 SICAM FSI Installation

Preparing the Device for Mounting

Before mounting SICAM FSI on the MV overhead line and before configuring the device, proceed as follows:

NOTICE

Exercise caution when connecting the device.

Non-observance of the following specified measures means that material damage can occur.

- ✧ The printed circuit board (PCB) is an electrostatic sensitive device. Follow the ESD measures.
- ✧ Prepare the working area and provide grounded mat for protecting components from electrostatic discharges (ESDs) damage.
- ✧ Wear ESD gloves and handle the device PCBA. Place it on the prepared mat suitable for preventing ESD. Do not place the PCBA on a conductive surface.
- ✧ **The images used in the SICAM FSI Installation procedure are for representation of connections. The actual PCBA and components may differ in look and feel.**

- ✧ The device and PCBA are factory calibrated to meet the measurement accuracies. Once the device and PCBA are unpacked; make sure to assemble the PCBA with the SICAM FSI with which was packed.



NOTE

Device serial number is printed on both SICAM FSI and PCBA packaging to avoid interchanging of devices and PCBAs.

- ✧ Unscrew the 3 screws using a Phillips screwdriver of tip size 1 as shown in [Figure 3-2](#).
- ✧ Remove the SICAM FSI transparent cover from the device housing.
Reuse 3 screws and transparent cover in assembly procedure.

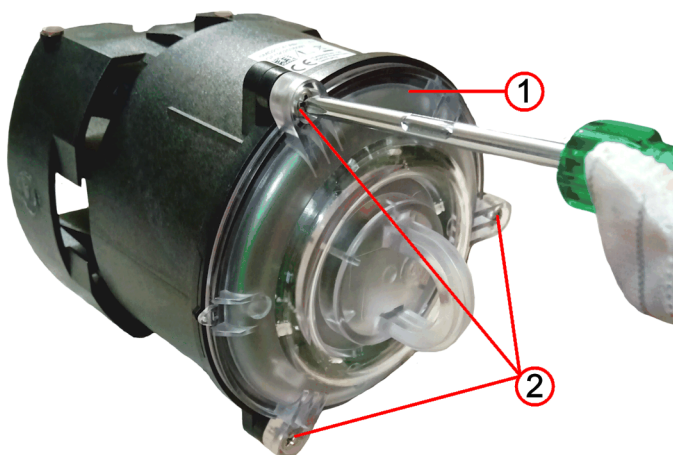

[le_sfsi_dangds-3screws, 2, _-]

Figure 3-2 Remove Screws and Transparent Cover

- (1) Transparent Cover
- (2) 3 Screws

- ✦ Identify the wires and connectors in the device housing and PCBA before assembling the PCBA to SICAM FSI.

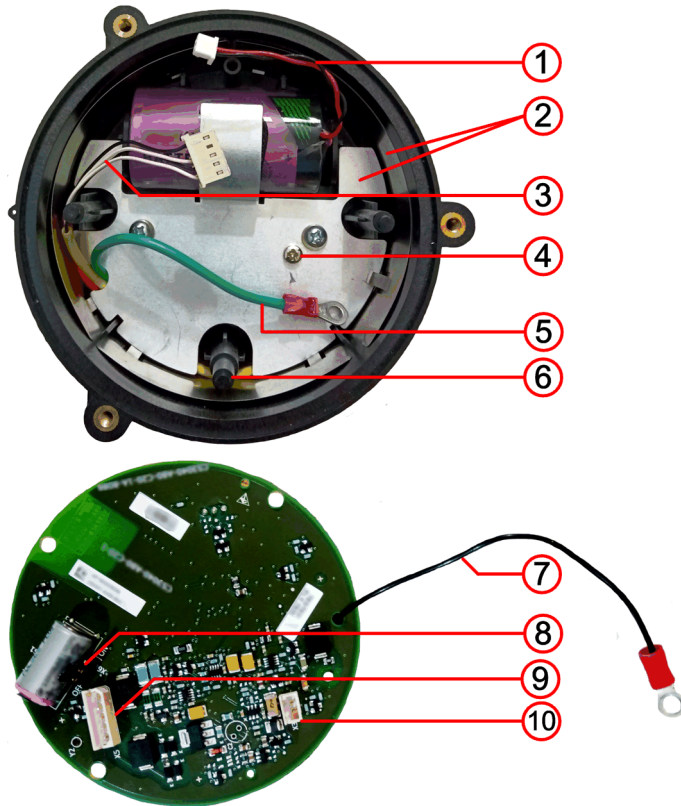

[file_sfsi_dangdswire-conn, 2, ...]

Figure 3-3 Wires and Connectors in the Device Housing and PCBA

- (1) Battery wire
- (2) Voltage detection plate
- (3) Coil wire
- (4) Screw for voltage detection plate wire
- (5) Voltage detection plate wire 2 (from sensor assembly)
- (6) Mounting boss
- (7) Voltage detection plate wire 1 (from PCBA)
- (8) 3-pin (X6) jumper pin
- (9) 5-pin (X5) connector
- (10) 2-pin (X3) battery polarized connector



NOTE

Voltage detection plate wire 2 (from sensor assembly) is only applicable to SICAM FSI FF hardware version and above.

- ✦ Unscrew the voltage detection wire screw (4 of [Figure 3-3](#)) from voltage detection plate using a Phillips screwdriver of tip size 1.

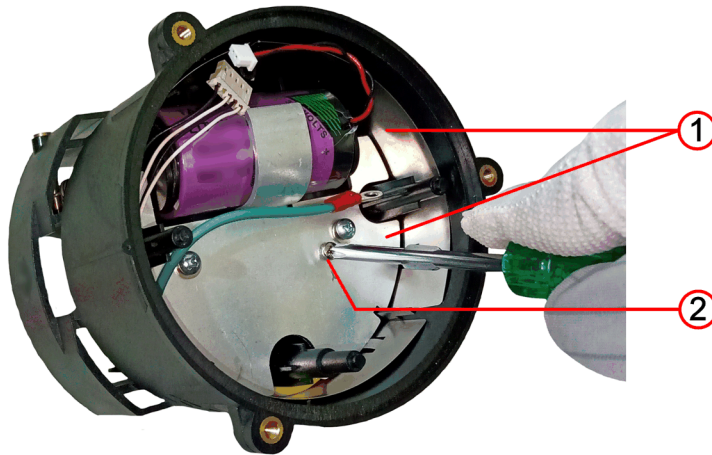

[le_sfsi_dangdsvoltcptwire, 2, --]

Figure 3-4 Unscrew Voltage Detection Wire Screw

- (1) Voltage detection plate
- (2) Voltage detection wire screw

✧ Align the voltage detection plate wire 1 (from PCBA) lug and then wire 2 (from sensor assembly) lug with the thread hole as shown in [Figure 3-5](#). Screw both lugs together with a torque of 0.35 Nm.

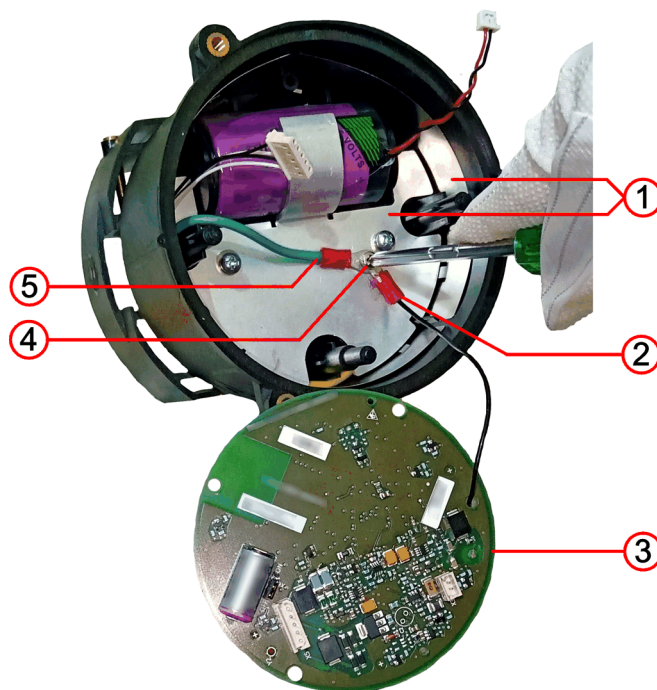

[le_sfsi_dangdsvoltcptwire, 2, --]

Figure 3-5 Voltage Detection Plate Wire Connected to Voltage Detection Plate

- (1) Voltage detection plate
- (2) Voltage detection plate wire 1 (from PCBA)
- (3) PCBA
- (4) Voltage detection plate wire screw
- (5) Voltage detection plate wire 2 (from sensor assembly)

- ✦ Connect coil wire to the 5-pin (X5) connector as shown in [Figure 3-6](#).

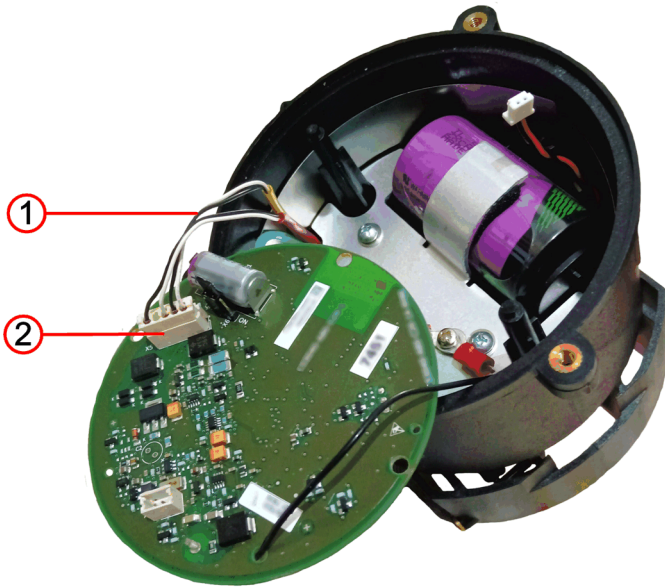

[file_sfsi_dangds5pinconn, 2, --]

Figure 3-6 Coil Wire Connected to the 5-pin (X5) Connector

- (1) Coil wire
- (2) 5-pin (X5) connector

- ✦ Connect battery to the 2-pin (X3) battery polarized connector on the PCBA to power on the device as shown in [Figure 3-7](#).

After the battery connector is connected, all the LEDs flash for 2 s to indicate that the battery connections are proper and the device is powered on.

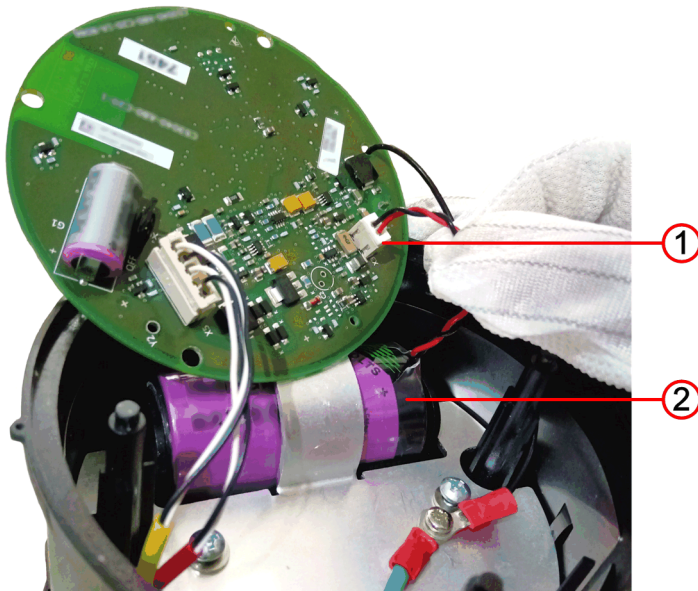

[file_sfsi_batt_x3connecthc, 4, --]

Figure 3-7 Battery Wire Connected to the 2-pin (X3) Battery Polarized Connector

- (1) 2-pin (X3) battery polarized connector
- (2) Battery



NOTE

If the 2-pin (X3) battery polarized connector is disconnected from the PCBA, wait for 2 min to reconnect the battery connector.

NOTICE

Exercise caution when switching the jumper pin on the PCBA.

Non-observance of the following specified measure means that material damage can occur.

- ✧ Ensure to switch the 3-pin (X6) jumper pin from OFF to ON position on the PCBA, otherwise battery life is impacted.

- ✧ Switch the 3-pin (X6) jumper pin from OFF to ON position on PCBA.

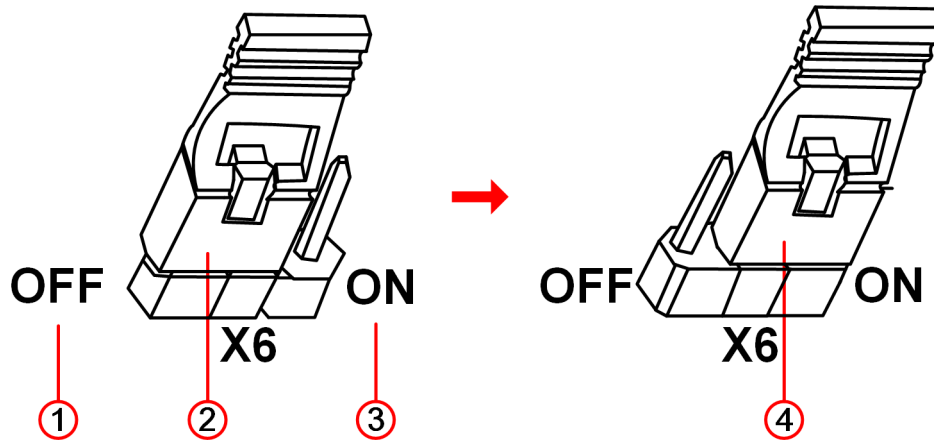

[le_sfsi_hicboard-off-on, 3, --]

Figure 3-8 3-Pin (X6) Jumper Pin on PCBA

- (1) OFF position marking on PCBA
- (2) Jumper pin in OFF position
- (3) ON position marking on PCBA
- (4) Jumper pin in ON position

- ✧ [Figure 3-9](#) shows that all the 3 wires (coil, battery, and voltage-detection plate) are routed after the battery is connected to the X3 connector.

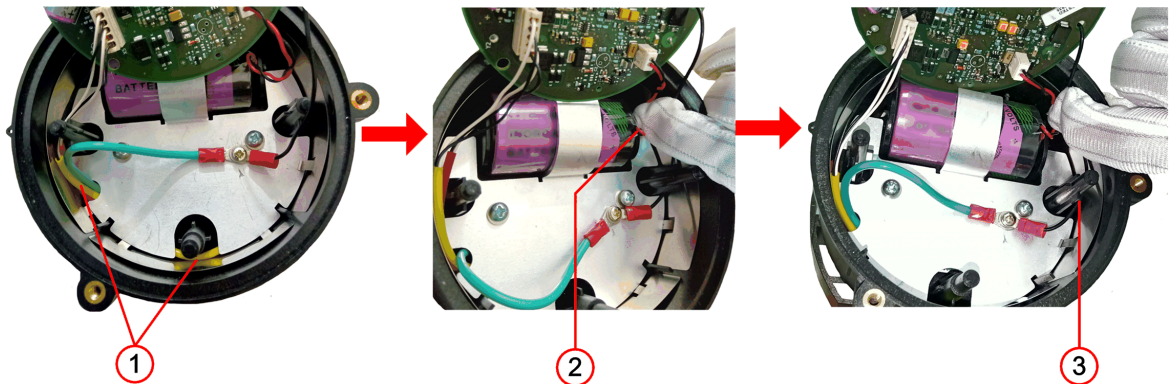

[le_sfsi_wireconnectnew, 2, en_US]

Figure 3-9 3 Wires Routing Sequence in the Housing

- (1) Coil wires and voltage detection plate wire 2 - routed around mounting bosses
- (2) Battery wire
- (3) Voltage detection plate wire routed around mounting boss



NOTE

Voltage detection plate wire must be aligned in proper orientation as shown in *Figure 3-5* or *Figure 3-9*.

Installing SICAM FSI Configurator and UART Cable Drivers

Download the SICAM FSI Configurator (Setup.exe) from the following Siemens Internet page:
<https://support.industry.siemens.com/cs/document/109751711/sicam-fsi-configurator?dti=0&lc=en-WW>
SICAM FSI Configurator (Setup.exe) is also distributed by the Siemens customer care representative. Contact customer support.

- ✦ To install the SICAM FSI Configurator, refer to *5.3 SICAM FSI Configurator Installation*.

Once the SICAM FSI Configurator is installed, the UART drivers are available in the following default path of PC or laptop computer:

C:\Program Files (x86)\Siemens Energy\SICAM FSI\USBDrivers

- ✦ To install the UART drivers, refer to *5.3 SICAM FSI Configurator Installation*.

Connecting SICAM FSI using UART Cable and Performing Device Reset

Before starting the SICAM FSI Configurator user interface, connect the UART cable to the USB of the PC or laptop computer and to serial UART interfaces of the SICAM FSI PCBA.

Siemens recommends using only the UART cable make: **FTDI Chip with part number TTL-232R-RPi**.

To connect the SICAM FSI using the UART cable, proceed as follows:

- ✦ Plug in the USB connector of the UART cable to the USB port of the PC or laptop computer.
- ✦ Connect the color-coded individual wires of the UART cable to the corresponding pins of the X2 connector on the PCBA.

The following table shows the SICAM FSI PCBA terminals and the UART cable color-coded wires:

Table 3-1 SICAM FSI PCBA Terminals and UART Cable Color-Coded Wires

SICAM FSI PCBA Terminals	Function	UART Cable Color-Coded Wires
Terminal 3	Ground (GND)	Black
Terminal 2	Receive (Rx)	Yellow
Terminal 1	Transmit (Tx)	Orange

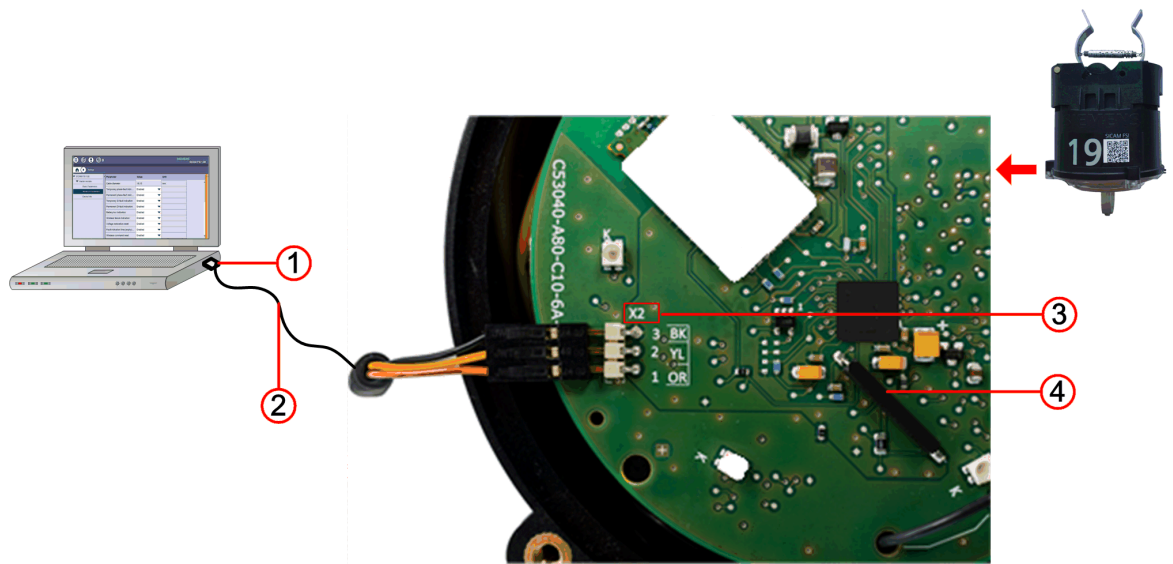

[le_sfsi_uart_pcba_20160208_4_en_US]

Figure 3-10 UART Cable Connected to the PCBA X2 Connector

- (1) USB
- (2) UART cable
- (3) X2 connector
- (4) Magnetic switch (REED switch)

- ✧ Once the UART cable connections are established, reset the device by placing magnet adaptor (MLFB: 6MD2318 - 4MA04) near to magnetic switch for 1 s to enable the serial port at X2 connector. All the LED flashes for 2 s to confirm that the device is healthy and ready for configuring the device parameters.



NOTE

The serial port remains disabled until a magnetic reset is performed after which the serial port is enabled. This port remains enabled as long as there is communication on the UART port. If there is no communication for 10 min, the port is auto-disabled to secure from spurious noises. To enable the serial port, reset the device again by magnet adaptor.

Configuring the Device Parameters



NOTE

The SICAM FSI is configurable with the SICAM FSI Configurator only. For more information about SICAM FSI Configurator, refer to [5.1 Overview](#).

The SICAM FSI with integrated communication is configurable with the SICAM FCG Web GUI.

Before configuring SICAM FSI (with integrated communication) with SICAM FCG Web GUI, pairing of SICAM FSI and SICAM FCG must be performed. Refer to [3.4.1 SICAM FSI Commissioning](#).

For more information about configuring the SICAM FSI parameters via SICAM FCG Web GUI, refer to the 5.2 Parameterizing the SICAM FSI section in the SICAM FCG Manual.

- ✧ Configure the device basic and advanced parameters with the SICAM FSI Configurator.

For more information about configuring the parameters, refer to chapter [5.7 Basic Parameter Settings](#) and [5.8 Advanced Parameter Settings](#).

- ✧ Once the basic and advanced parameters are configured, disconnect UART cable from X2 connector on the PCBA.
- ✧ Remove the USB connector of the UART cable from the PC or laptop computer.
- ✧ Place the PCBA in the housing such that the 3 mounting bosses of the housing are locked into the assembly holes of the PCBA.

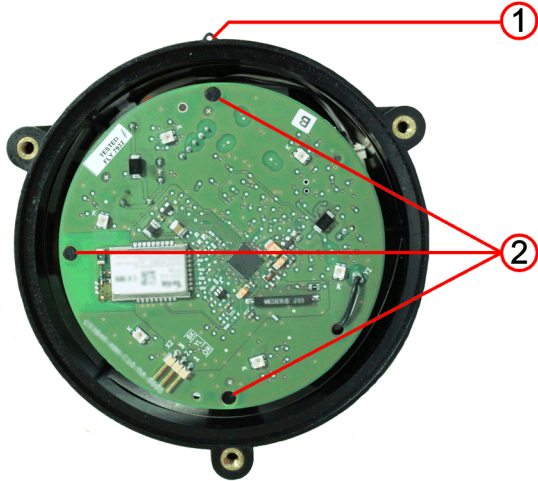

[le_sfai_pcbaslot-20160503, 2, --]

Figure 3-11 PCBA Placed in the 3 Mounting Bosses of Housing

- (1) Sealing hole
- (2) Mounting boss

- ✧ Ensure that the gasket is in place and align the device transparent cover with the sealing hole (1 of [Figure 3-11](#)). Then place the transparent cover in the device housing.

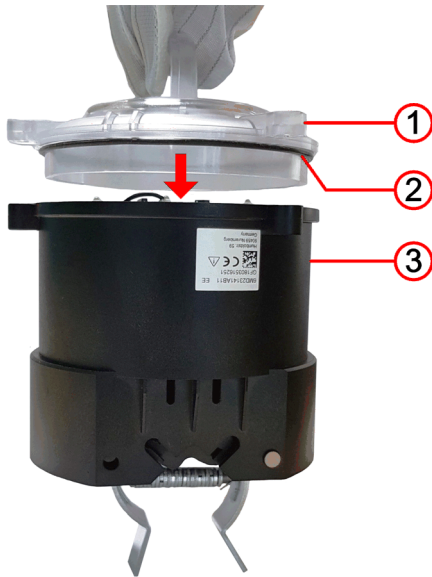

[le_sfai_dangdsdevgskt, 1, --]

Figure 3-12 Placing the Transparent Cover in Device Housing

- (1) Device transparent cover
- (2) Gasket
- (3) Device housing

- ✧ Manually thread 3 screws and then tighten using a torque screw driver with a torque of 0.7 N.



[le_sfsi_covermount.3,-_-]

Figure 3-13 Screws Tightened with the Housing

- (1) 3 Screws
- (2) Sealing hole alignment

NOTICE

Exercise caution when closing the transparent cover.

Non-observance of the following measures means that material damage can occur.

- ✧ To ensure effective operation of the device in severe environmental conditions as per IP68 classification, the transparent cover screws must be tightened as per the recommended torque.
 - ✧ Place the PCBA on the mounting boss correctly when closing the transparent cover, else it may result in improper fitment. This may violate the **ingress protection**.
-
- ✧ Perform the device self test with the magnet adaptor to ensure that the device is ready for mounting in the MV overhead line.

3.3 SICAM FSI Mounting

3.3.1 SICAM FSI Mounting Methods

You can mount SICAM FSI on the MV overhead line with one of the following tools:

- Hot stick with shotgun
Hot stick with shotgun is used when the overhead line is accessible up to 4 m
- Hot stick (telescopic) with device adaptor
Hot stick (telescopic) is used when the overhead line is accessible up to 12 m

For more information about SICAM FSI commissioning, refer to [3.4.1 SICAM FSI Commissioning](#).

3.3.2 Mounting SICAM FSI using Hot Stick with Shotgun

To mount the device on the MV overhead line with hot stick with shotgun, proceed as follows:



DANGER

Warning due to live voltage when mounting the device.

Non-observance of the following measures leads to death or serious injury.

- ✧ Mounting the device or replacing the device must be carried out by trained personnel (see preface) who are familiar with and observe the safety requirements and precautions.
- ✧ Before mounting the device, ensure that you wear safety helmet, gloves and boots. It is recommended to use glares while working in bright sunny environment.
- ✧ Siemens recommends using the **hot stick with shotgun (Make: Ritz, Cat.No. RC403-0295 or equivalent) with a minimum isolation of 125 kV AC**. Follow safety measures and recommended maintenance procedures as per the hot stick with shotgun supplier.
- ✧ Ensure that the **hot stick is dry and clean from dirt before mounting or unmounting** the device on the MV overhead line.
- ✧ Do not mount and unmount the device from the MV overhead line if the **weather is wet, if it is raining, if there is a fog, or if snow is falling**.
- ✧ Do not rest or hang **hot stick with shotgun** with device unattended on the MV overhead line.

-
- ✧ Assign 1 device per phase.
 - ✧ Check and note the device identity, for example, SICAM FSI 1 to R/L1, SICAM FSI 2 to Y/L2, and SICAM FSI 3 to B/L3.
 - ✧ Open both hooks of the device.



[file_sfsi_hookopen-20160216_2_...]

Figure 3-14 Opening the Hooks of the Device

(1) Hooks



CAUTION

Exercise caution with the hooks of the device

Non-observance of the safety notes may lead to severe injury.

- ✦ When handling the hooks, exercise caution to avoid any physical harm to the fingers.
- ✦ After opening the hooks, do not place your fingers in the hooks to avoid any accidental closure of the clamping mechanism causing injury.

- ✦ Press the hand grip of the hot stick with shotgun and move upwards to open the jaw hook. Attach the device to the hot stick on the eye hook provided on the transparent cover.

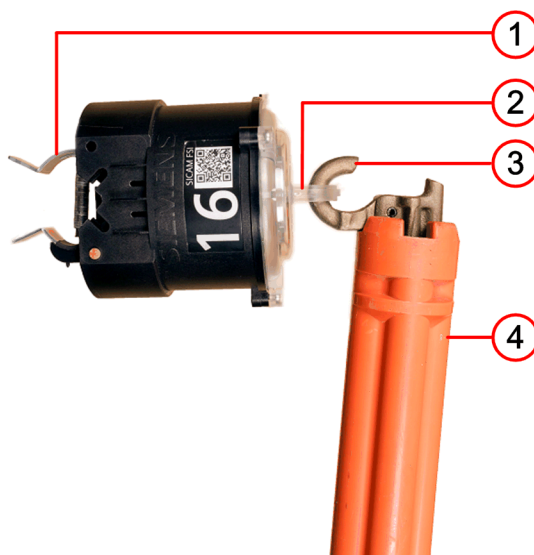

[file_sfsi_hotstickhook-20160608_1_...]

Figure 3-15 Device Eye Hook Attached to Hot Stick with Shotgun

- (1) Clamp
- (2) Eye hook
- (3) Jaw hook
- (4) Hot stick with shotgun

Following figure shows the position of the hand grip and how to open the jaw hook of the hot stick with shotgun.



[dw_fsi_devopen-20160620_2_en_US]
Figure 3-16 Opening the Jaw Hook of the Hot Stick with Shotgun

- ❖ Press the hand grip of the hot stick with shotgun and move downwards to close the jaw hook. Following figure shows the position of the hand grip and how to close the jaw hook of the hot stick with shotgun.



[dw_fsi_devdose-20160620_2_en_US]
Figure 3-17 Closing the Jaw Hook of the Hot Stick with Shotgun

- ❖ Press the hand grip of the hot stick with shotgun and retract to keep the eye hook connected to the hot stick with shotgun. Following figure shows the position of the hand grip and how the device is locked with the hot stick with shotgun. The device is ready for mounting on the MV overhead line.



[dw_fsi_devlock-20160620, 1, en_US]

Figure 3-18 Locking the Jaw Hook of the Hot Stick with Shotgun



[dw_fsi_installation-20160620, 1, en_US]

Figure 3-19 Mounting the Device on the MV Overhead Line

- ✧ Raise the device ensuring that the MV overhead line is positioned between the open clamps arrangement.



[le_fsi_installine-20160620_1_en_US]

Figure 3-20 Device Attached to the MV Overhead Line

- (1) MV overhead line
- (2) Clamp

✧ Thrust the device against the MV overhead line until the mounting clamps snaps to the MV overhead line.



[dw_fsi_hotstickhookclampsnaps-20160620_1_en_US]

✧ Exert slight pull to confirm that the device is secured on the MV overhead line.



[dw_fsi_devpull-20160620, 1, en_US]

Figure 3-21 Device Secured on the MV Overhead Line

- ✧ Lower the hot stick with shotgun from the MV overhead line. To retract the hot stick with shotgun, refer to [Figure 3-16](#).

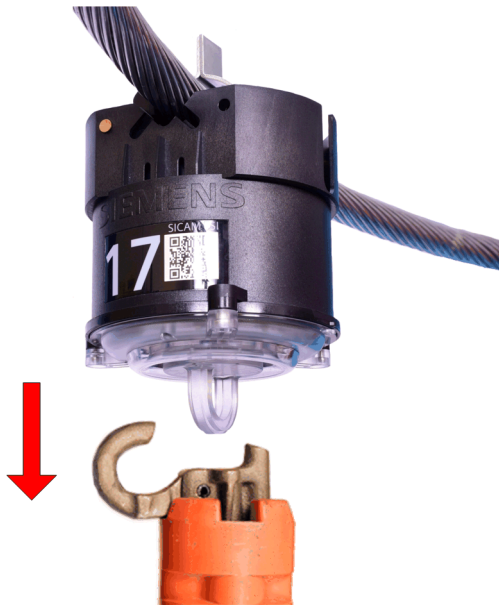

[dw_sfsi_hotstickshotgun, 1, --]

Figure 3-22 Lowering Hot Stick with Shot Gun



NOTE

Before the hot stick with shotgun is lowered, the orientation of SICAM FSI must be aligned as shown in [Figure 3-22](#) and ensure that device transparent cover is always facing towards the ground.

3.3.3 Mounting SICAM FSI using Hot Stick (Telescopic) with Device Adaptor

To mount the device on the MV overhead line with telescopic hot stick, proceed as follows:



DANGER

Warning due to live voltage when mounting the device.

Non-observance of the following measures leads to death or serious injury.

- ✧ Mounting the device or replacing the device must be carried out by trained personnel (see preface) who are familiar with and observe the safety requirements and precautions.
- ✧ Before mounting the device, ensure that you wear safety helmet, gloves and boots. It is recommended to use glares while working in bright sunny environment.
- ✧ Siemens recommends using the **telescopic hot stick (Make: Ritz, VTT-1/9 or equivalent) with a minimum isolation of 125 kV AC**. Follow safety measures and recommended maintenance procedures as per the hot stick (telescopic) supplier.
- ✧ Ensure that the **hot stick is dry and clean from dirt before mounting or unmounting** the device on the MV overhead line.
- ✧ Do not mount and unmount the device from the MV overhead line if the **weather is wet, if it is raining, if there is a fog, or if snow is falling**.
- ✧ Do not rest or hang **telescopic hot stick** with device unattended on the MV overhead line.

-
- ✧ Assign 1 device per phase.
 - ✧ Check and note the device identity, for example, SICAM FSI 1 to R/L1, SICAM FSI 2 to Y/L2, and SICAM FSI 3 to B/L3.
 - ✧ Open both hooks of the device.



[le_sfsi_hookopen-20160216_2, --]

Figure 3-23 Opening the Hooks of the Device

(1) Hooks



CAUTION

Exercise caution with the hooks of the device

Non-observance of the safety notes may lead to severe injury.

- ✧ When handling the hooks, **exercise caution to avoid any physical harm to the fingers.**
- ✧ After opening the hooks, **do not place your fingers in the hooks to avoid any accidental closure of the clamping mechanism causing injury.**

- ✧ Remove the rubber fastening from the telescopic hot stick.



[le_sfs_telhotrubber, 1, -_-]

Figure 3-24 Removing the Rubber Fastening

- (1) Rubber fastening
- (2) Telescopic hot stick

- ✧ Loosen the wing bolt of the telescopic hot stick.

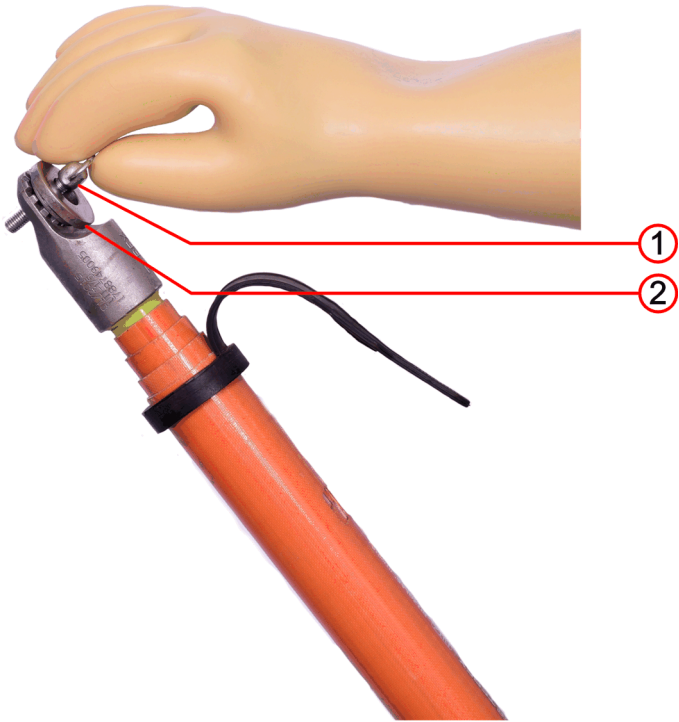

[le_sfsi_telhotwingbolt, 1, --]

Figure 3-25 Loosen the Wing Bolt of the Telescopic Hot Stick

- (1) Wing bolt
- (2) Washers (optional)



NOTE

Do not completely remove the wing bolt from the telescopic hot stick. Washer/s are only used to achieve better grip between wing bolt and device adaptor.

- ✧ Mount the device adaptor on the telescopic hot stick.
Make sure that the device adaptor is mounted at the right angles to the telescopic hot stick.

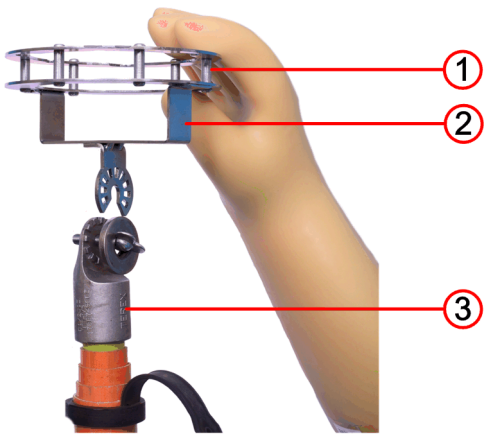

[le_sfsi_telhotdevadap, 1, --]

Figure 3-26 Mounting Device Adaptor on the Telescopic Hot Stick

- (1) Device adaptor
- (2) Bottom flange of device adaptor
- (3) Telescopic hot stick

Following figure shows the correct positioning of device adaptor on the telescopic hot stick.

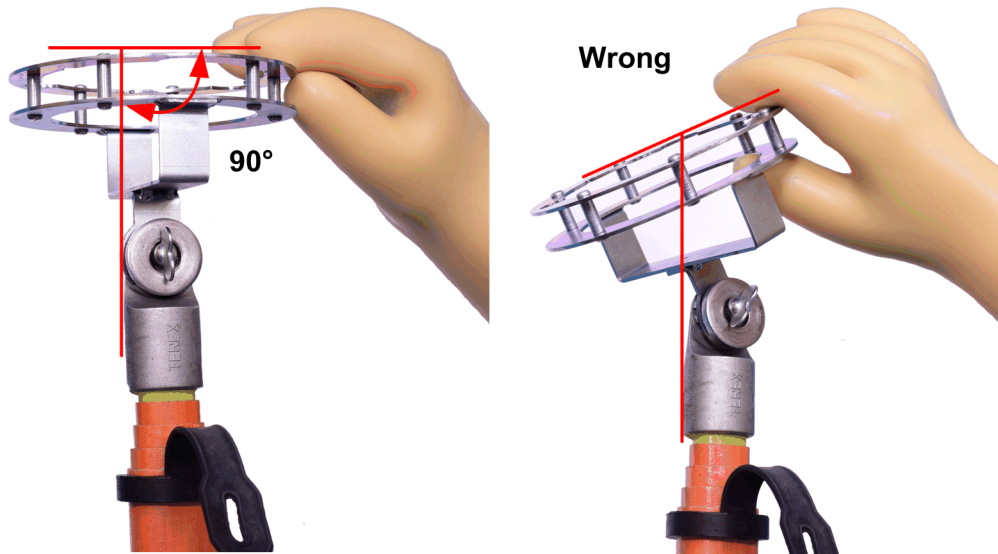

[dw_sfsi_devadapcorrect, 1, en_US]

Figure 3-27 Correct Position of Device Adaptor on the Telescopic Hot Stick

- ✧ Match the device adaptor square holes on the telescopic hot stick teeth, so that they fit in place.

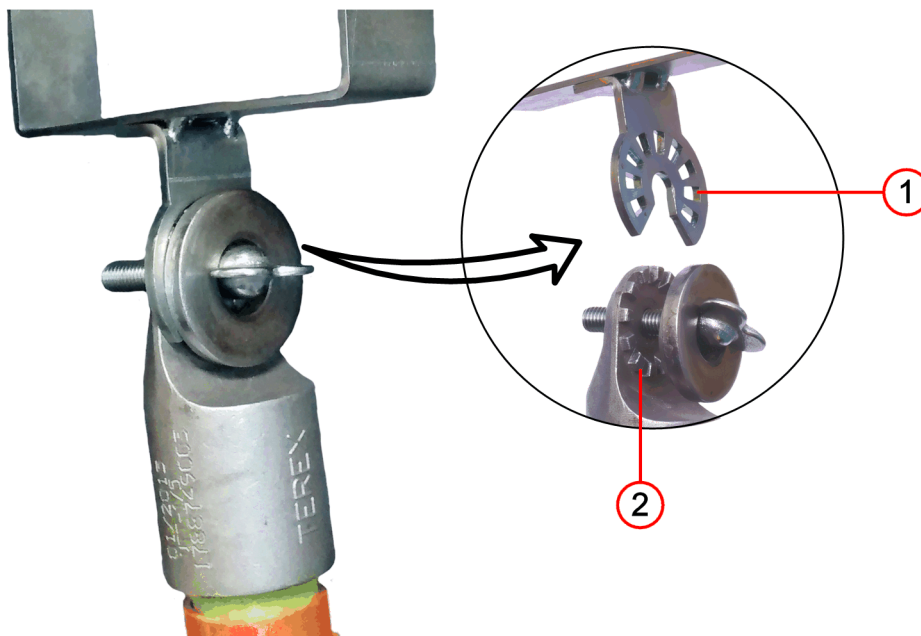

[le_sfsi_devadapsqthruholes, 1, --]

Figure 3-28 Matching Device Adaptor Square Holes on the Telescopic Hot Stick

- (1) Device adaptor square holes
- (2) Telescopic hot stick teeth

- ✧ Hold the device adaptor firmly on the telescopic hot stick and completely tighten the wing bolt.

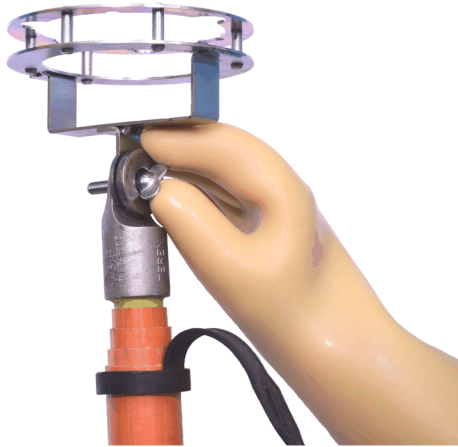

[dw_sfsi_telhotwingbolttight, 1, --]

Figure 3-29 Tighten the Wing Bolt of Telescopic Hot Stick

- ❖ Place the SICAM FSI in 3 slots of the device adaptor as shown in [Figure 3-30](#). Also make sure that the Siemens logo is in line with the device adaptor bottom flange and the user facing it as shown in [Figure 3-31](#).

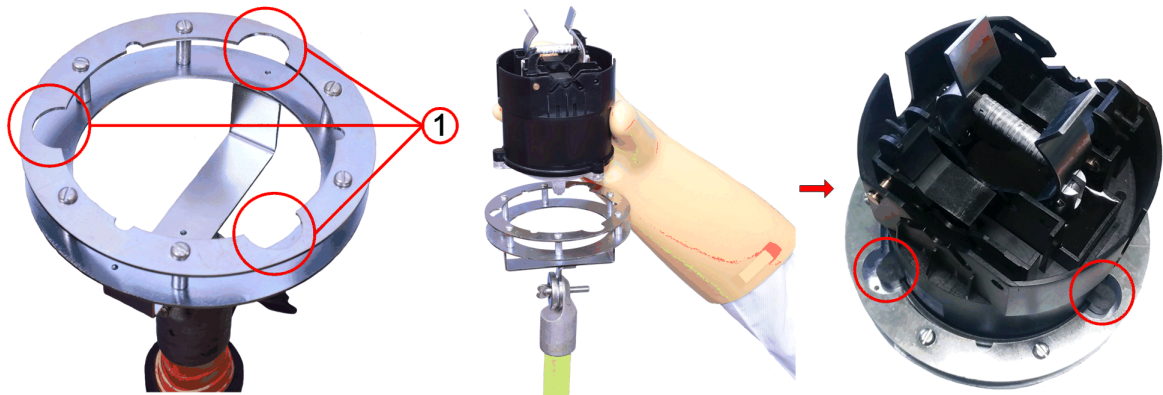

[le_sfsi_devadap3slots, 1, --]

Figure 3-30 Placing the SICAM FSI in Device Adaptor 3 Slots

- (1) 3 slots of device adaptor

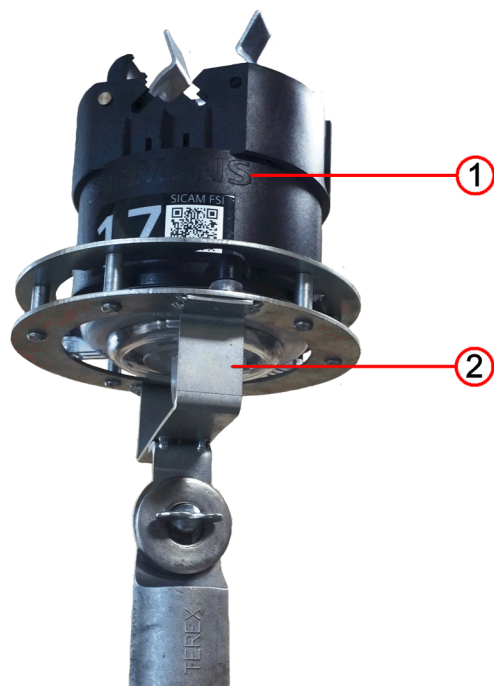

[le_sfsi_logoboltflange, 1, -,-]

Figure 3-31 Aligning Bottom Flange of Device Adaptor with the SIEMENS Logo

- (1) SIEMENS logo
- (2) Bottom flange of device adaptor

✧ To lock the SICAM FSI in the device adaptor, turn it horizontally in either direction.



[dw_sfsi_lockdev3slots, 1, -,-]

Figure 3-32 Locking the SICAM FSI in Device Adaptor

✧ To attain preferred length, the telescopic hot stick must be extended and retracted vertically, with the base resting on the ground. Extend the telescopic hot stick sections that are necessary to focus on the estimated height to be reached.

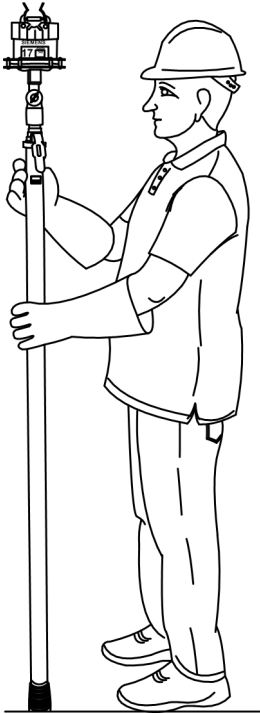

[dw_sfsi_telhotstkground, 1, --]

Figure 3-33 Telescopic Hot Stick Base Resting on the Ground

- ✧ Each section of the telescopic hot stick can be extended or retracted with integrated locking button. Extend the top section first until it locks. Extend the subsequent sections likewise and make sure that the integrated buttons are locked until it reaches the necessary height.

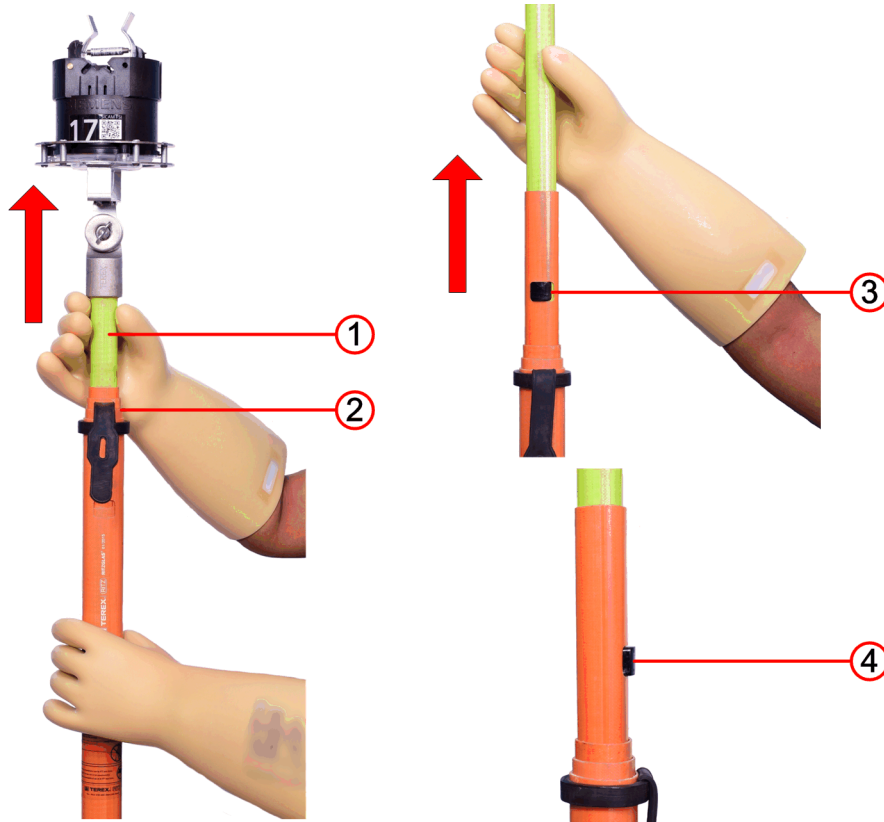

[le_sfs_telhotextract, 1, -_]

Figure 3-34 Extending the Top Section and Subsequent Sections

- (1) Top Section
- (2) Subsequent Sections
- (3) Integrated Button
- (4) Integrated Button in Locked Condition



NOTE

User hand stability is essential while balancing the telescopic hot stick in expanded state (or heights more than 10 m) and simultaneously aligning the device to the MV overhead line.

- ✧ To retract the stick extensions, maintain the telescopic hot stick in vertical position, place it on the ground. Press the base section button, holding the subsequent section, allowing a smooth sliding down. Proceed likewise to retract the subsequent sections, until the stick is fully retracted.

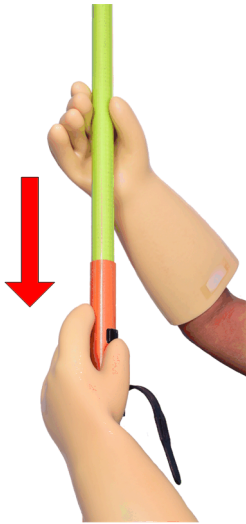

[dw_sfsi_telhotretract, 1, --]

Figure 3-35 Retracting Subsequent Sections and First Section

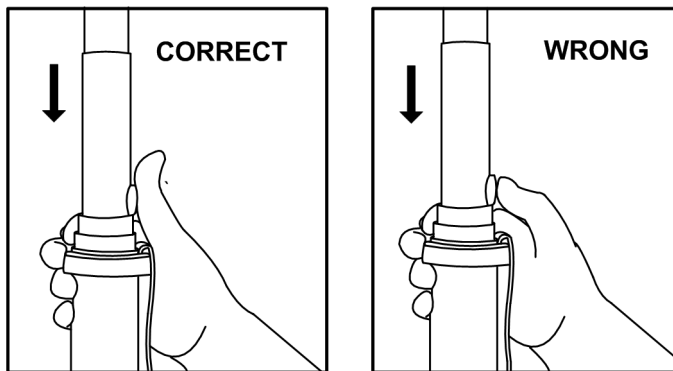

[dw_sfsi_telhotlockcaution, 1, en_US]

Figure 3-36 Pressing Integrated Lock Button



CAUTION

Exercise caution with integrated locking button

Non-observance of the safety notes leads to moderate or minor injuries.

- ✧ To avoid any **physical harm to the fingers**, care must be taken while pressing integrated lock button and retracting the stick simultaneously.
-
- ✧ The device is now ready for mounting on the MV overhead line. Raise the device ensuring that the MV overhead line is positioned between the open clamps arrangement. Thrust the device against the MV overhead line until the mounting clamp snaps to the MV overhead line.

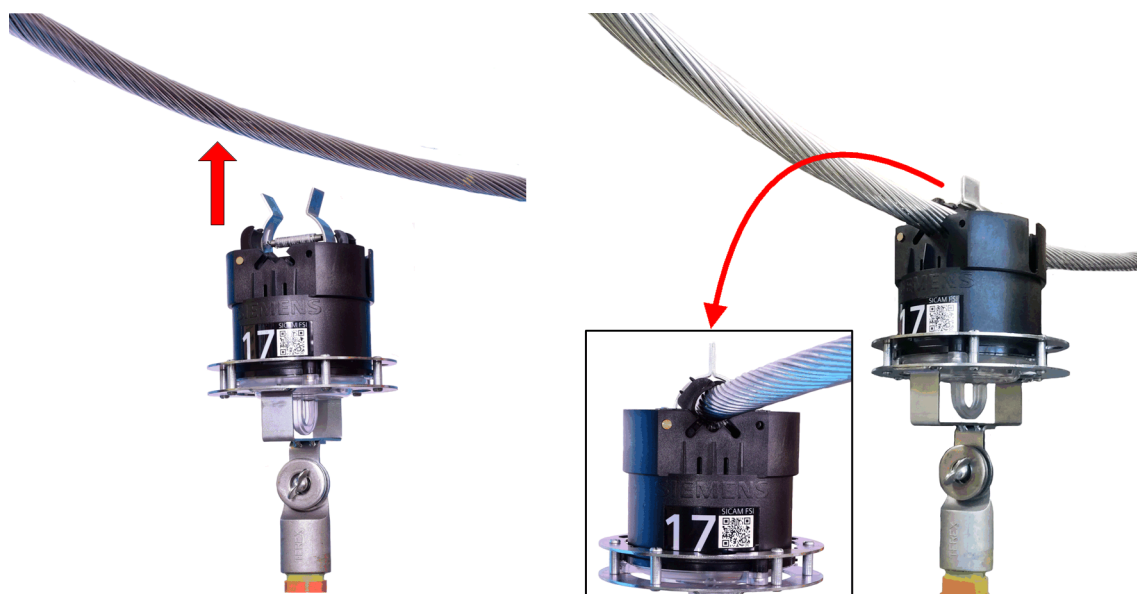

[dw_sfi_telhotmountdevice, 1, --]

Figure 3-37 Mounting SICAM FSI on MV Overhead Line



NOTE

To ensure proper mounting of the device in first attempt, align the device adaptor flange exactly in parallel to the MV overhead line.

- ✧ Exert slight pull to confirm that the device is secured on the MV overhead line.
- ✧ Turn the telescopic hot stick along with device adaptor until SICAM FSI flanges align with device adaptor cut sections at 3 locations.



[dw_sfi_deviceunlock, 1, --]

Figure 3-38 Unlocking the Device Adaptor from SICAM FSI

- ✧ Lower the telescopic hot stick from the MV overhead line. To retract the telescopic hot stick, refer to [3.3.3 Mounting SICAM FSI using Hot Stick \(Telescopic\) with Device Adaptor](#)

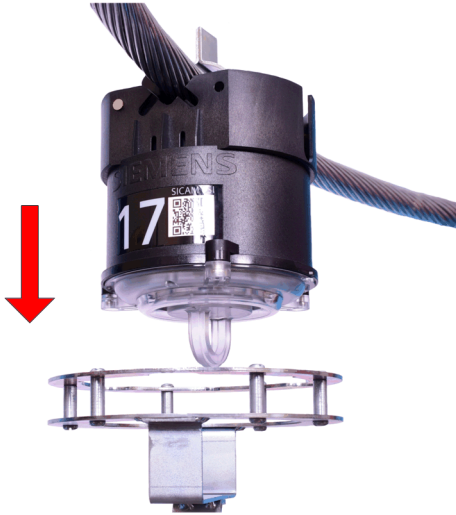

[dw_sfsi_telhotstcklower. 1. --]

Figure 3-39 Lowering Telescopic Hot Stick



NOTE

Before the telescopic hot stick is lowered, the orientation of SICAM FSI must be aligned as shown in [Figure 3-34](#) and ensure that device transparent cover is always facing towards the ground.

3.4 Commissioning

3.4.1 SICAM FSI Commissioning

After mounting the device on the MV overhead line for the first time, the device takes 3 min to adapt to the MV overhead line voltage and it is confirmed by flashing all the LED for 10 times (1 flash/s).

Commissioning SICAM FSI using Magnet Adaptor

To commission the SICAM FSI, proceed as follows:

- ✧ Reset the device by placing the magnet adaptor (MLFB: 6MD2318 - 4MA04) within 2 cm to 3 cm near to the device transparent cover for approximately 1 s.

LEDs flash one by one in a clockwise direction for 5 times to confirm that the device is healthy and ready for operation.



[le_fsi_magnetreset-20160620_1_en_US]

Figure 3-40 Resetting the Device using Magnet Adaptor using Hot Stick with Shot Gun

- (1) Transparent cover
- (2) Magnet adaptor
- (3) Hot stick with shot gun

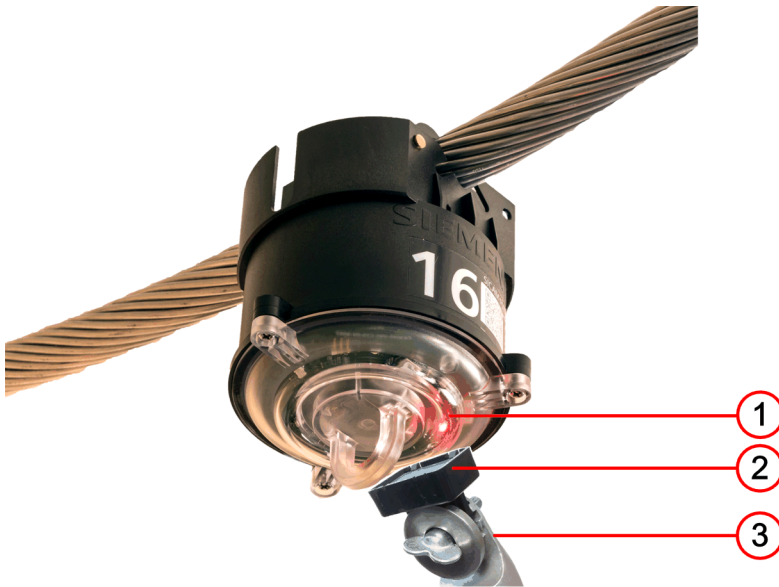

[file_fsi_telmagnetreset, 2, ...]

Figure 3-41 Resetting the Device using Magnet Adaptor using Telescopic Hot Stick

- (1) Transparent cover
- (2) Magnet adaptor
- (3) Telescopic hot stick

Commissioning (Pairing) of SICAM FSI with Integrated Communication using SICAM FCG

This section describes the process of establishing the communication between SICAM FCG and SICAM FSI with integrated communication. The communication between SICAM FCG and SICAM FSI is encrypted and all the mandatory parameters are shared to establish the communication. For establishing the communication, ensure that the SICAM FSI QR Code is scanned and added in the SICAM FCG configuration page. Use a recommended QR code scanner to scan and enter the QR code to the SICAM FCG.



NOTE

Siemens recommends using **Honeywell QR Code Scanner (Model: Xenon 1902)** for scanning the SICAM FSI QR code label.



NOTE

Once the communication between SICAM FCG and SICAM FSIs is established, SICAM FCG automatically updates the latest device configuration and firmware of all paired SICAM FSIs.

To commission the SICAM FCG and SICAM FSI using a recommended QR code scanner, proceed as follows:

- ✦ Power on the SICAM FCG.
- ✦ Connect the PC or laptop computer to SICAM FCG via the Ethernet port.

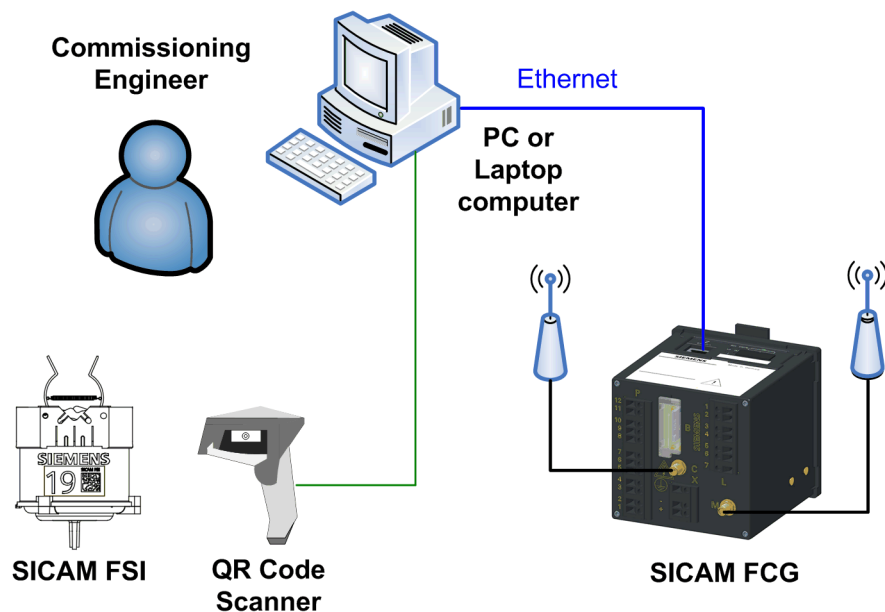

[dw_fsifcg_commissioning_3_en_US]

Figure 3-42 SICAM FSI QR Code Scanning and Configuration

- ✧ Connect a QR code scanner to the configuration PC or laptop computer.
- ✧ Open the Web browser (MS Internet Explorer, Google Chrome, Mozilla Firefox) and enter the default IP address (192.168.0.55) of SICAM FCG.
- ✧ Navigate to the **Configure** tab → **Communication** → **Short range communication (WPAN)**.
- ✧ Switch on the short range communication (WPAN): WPAN enable option button = **Yes**.
- ✧ Click **Send** on the **SICAM FCG** configuration page.

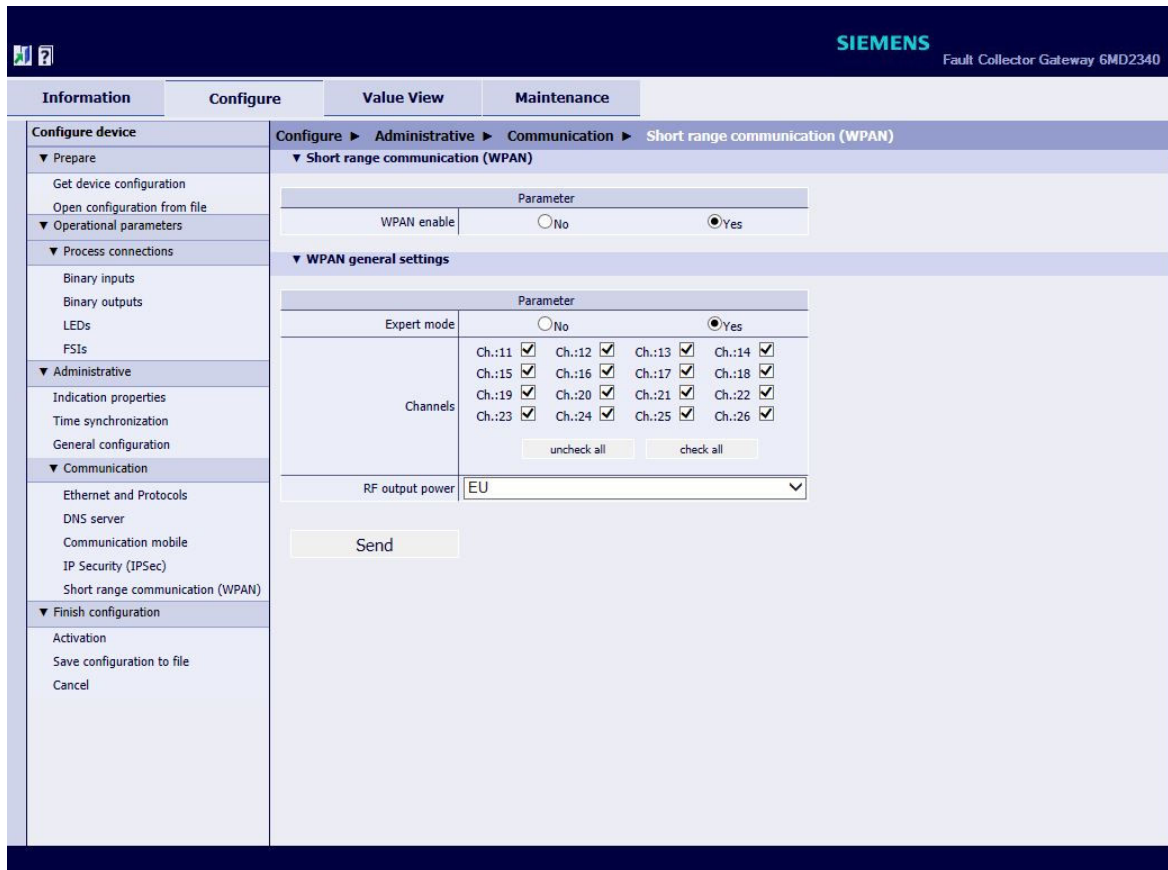

[sc_sfsi_srcWPAN, 1, -,-]

Figure 3-43 Short Range Communication (WPAN)

- ✧ Navigate to the **Configure** tab → **Finish configuration** → **Activation**.
- ✧ Enter the **Password** and click **Activation** to activate the WPAN.
- ✧ In the **SICAM FCG configuration** page, navigate to the **Process Connections** tab → **FSIs** and delete the default value (****) from the **QR Code content** field for the respective SICAM FSI.

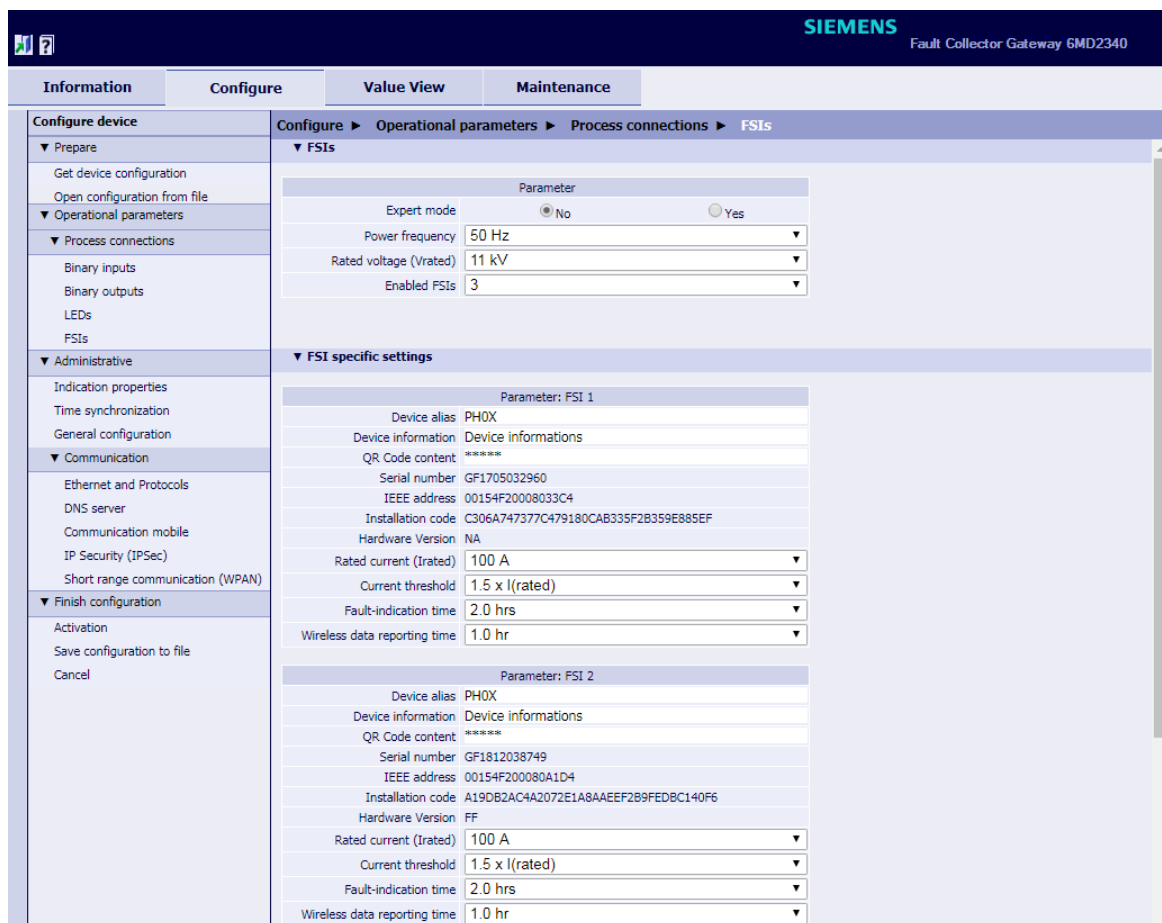

[sc_sfsi_profis, 1, --]

Figure 3-44 SICAM FSI Parameterization

- ✧ Place the cursor in the **QR Code content** field.
- ✧ Scan the QR Code from the SICAM FSI device label.



[te_sfsi_qrcodelabel_20160223, 3, en_US]

- (1) Product name
- (2) QR code
- (3) Year of manufacturing



NOTE

While scanning QR code from the SICAM FSI device label, avoid sunlight on QR code.

- ✧ Click **Send** on the **SICAM FCG** configuration page.
- ✧ In the **Process connections** → **FSIs**, switch on the Expert mode option button = **Yes**.
- ✧ Select the cable type and cable diameter before activating the FSIs configuration. SICAM FSI hardware version can be identified under Hardware Version.

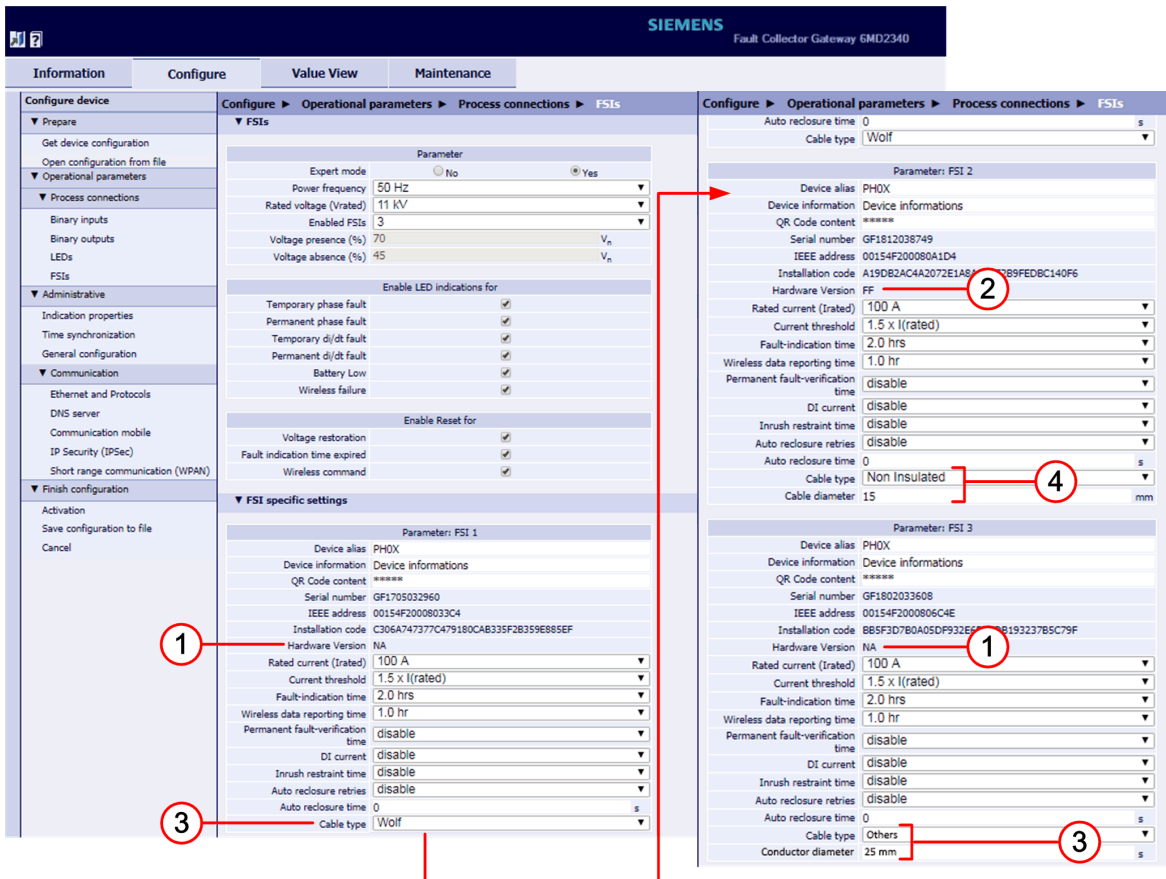

[idw_sfsi_cabtypedia_1_en_US]

Figure 3-45 Overhead Line Cable Type and Diameter Selection

- (1) SICAM FSI - DD or EE Hardware version
- (2) SICAM FSI - FF or GG Hardware version
- (3) Cable type for SICAM FSI - DD or EE version
- (4) Cable type and diameter for SICAM FSI - FF or GG version



NOTE

- For SICAM FSI - FF and GG versions, the default cable type is Non-insulated and default cable diameter is 15 mm.
- SICAM FSI - DD and EE hardware versions are shown as "NA". For SICAM FSI - DD and EE versions, the default cable type is Wolf. Refer to [B.1 Aluminum Conductor Steel Reinforced \(ACSR\) Cable Type and Diameter](#) for details on cable type and diameter.

- ✧ For SICAM FSI - FF and GG versions, select cable type (non-insulated/insulated) from list box and manually enter cable diameter.
 - Cable diameter range for Non-insulated cable is 5 mm to 40 mm
 - Cable diameter range for Insulated cable is 15 mm to 40 mm
- ✧ For SICAM FSI - DD and EE versions, select cable type from the list box. The cable diameter field is auto populated except for cable type as **Others**.
If the device is mounted on a conductor which is not available in the list, then select the cable type as **Others** with cable diameter from ≥ 5 mm to ≤ 25 mm.
- ✧ Click **Send** on the **SICAM FCG** configuration page.
- ✧ Navigate to the **Configure** tab → **Finish configuration** → **Activation**.



[sc_sfsi_active_passFF, 1, ---]

Figure 3-46 Configure Tab, Activation Input/Output Window

- ✧ Enter the **Password** and click **Activation** to activate the parameters.
Contact the local Siemens office or contact customer support for password details.



NOTE

FSIs configuration activation takes nearly 20 s for FF/GG version and 5 s for DD/EE version.

- ✧ Power on the SICAM FSI by connecting the battery wires to the respective terminal. For more information about connecting the battery wires, refer to [3.2.1 SICAM FSI Installation](#). All the LED flashes for 2 s during startup and the SICAM FSI searches for SICAM FCG for association.
- ✧ Navigate to the **Maintenance View** tab → **Diagnosis** → **FSIs** and verify that SICAM FSI is successfully associated and the SICAM FSI device data is populated.

Parameterizing the SICAM FSI

For more information about the parameter settings, refer to **chapter 5.2 Parameterizing the SICAM FSI section, SICAM FCG Manual**.

- ✧ Repeat the earlier steps for pairing with the other SICAM FSIs in the group.

- ✧ Mount the SICAM FSIs on the MV overhead line as per the configured phases, for example, SICAM FSI 1 to R/L1, SICAM FSI 2 to Y/L2, and SICAM FSI 3 to B/L3.
- ✧ You can verify the actual measured values of current on the energized MV overhead line in the **Value view** tab in SICAM FCG Web GUI.

The screenshot shows the Siemens SICAM FCG Web GUI interface. The 'Value View' tab is active, displaying a table of 'FSI measured values'. The table is organized into 'Instantaneous Data' and 'Periodic Data' sections. The 'Instantaneous Data' section includes columns for 'FSIs', 'Receiving time', and 'Instant current'. The 'Periodic Data' section includes columns for 'Receiving time', 'Maximum current', 'Minimum current', and 'Average current'. The table lists data for 9 different FSIs, each with multiple receiving times and corresponding current measurements.

Instantaneous Data			Periodic Data			
FSIs	Receiving time	Instant current	Receiving time	Maximum current	Minimum current	Average current
1	2021-01-01 14:28:32:559	50 A	2021-01-01 13:34:42:462	190 A	0 A	38 A
	2021-01-01 14:28:31:430	50 A	2021-01-01 12:33:55:055	174 A	0 A	25 A
	2021-01-01 14:23:31:022	0 A	2021-01-01 11:33:07:524	181 A	0 A	40 A
2	2021-01-01 14:28:32:564	47 A	2021-01-01 14:07:21:602	187 A	0 A	27 A
	2021-01-01 14:28:31:453	45 A	2021-01-01 13:06:34:020	187 A	0 A	32 A
	2021-01-01 14:23:31:268	0 A	2021-01-01 12:05:46:555	87 A	0 A	33 A
3	2021-01-01 14:28:32:511	40 A	2021-01-01 14:23:28:371	130 A	0 A	20 A
	2021-01-01 14:28:31:553	40 A	2021-01-01 13:22:40:797	131 A	0 A	31 A
	2021-01-01 14:23:31:350	0 A	2021-01-01 12:21:53:390	135 A	0 A	23 A
4	2021-01-01 14:28:32:480	46 A	2021-01-01 14:21:50:367	171 A	0 A	23 A
	2021-01-01 14:28:31:490	46 A	2021-01-01 13:21:02:785	169 A	0 A	37 A
	2021-01-01 14:23:30:917	0 A	2021-01-01 12:20:15:384	171 A	0 A	28 A
5	2021-01-01 14:28:32:529	46 A	2021-01-01 13:40:45:967	87 A	0 A	37 A
	2021-01-01 14:28:31:406	46 A	2021-01-01 12:39:58:474	182 A	0 A	24 A
	2021-01-01 14:23:30:980	0 A	2021-01-01 11:39:10:948	175 A	0 A	38 A
6	2021-01-01 14:28:32:555	47 A	2021-01-01 13:45:57:720	87 A	0 A	36 A
	2021-01-01 14:28:31:448	47 A	2021-01-01 12:45:10:205	188 A	0 A	25 A
	2021-01-01 14:23:31:044	0 A	2021-01-01 11:44:22:686	188 A	0 A	38 A
7	2021-01-01 14:28:32:563	41 A	2021-01-01 14:25:23:998	148 A	0 A	22 A
	2021-01-01 14:28:31:469	43 A	2021-01-01 13:24:36:395	147 A	0 A	34 A
	2021-01-01 14:25:23:998	0 A	2021-01-01 12:23:49:002	26 A	15 A	24 A
8	2021-01-01 14:28:32:600	48 A	2021-01-01 14:08:55:486	184 A	0 A	28 A
	2021-01-01 14:28:31:510	48 A	2021-01-01 13:08:07:916	184 A	0 A	34 A
	2021-01-01 14:23:30:959	0 A	2021-01-01 12:07:20:465	88 A	0 A	32 A
9	2021-01-01 14:28:32:487	50 A	2021-01-01 14:13:56:726	188 A	0 A	26 A
	2021-01-01 14:28:31:531	50 A	2021-01-01 13:13:09:159	188 A	0 A	35 A
	2021-01-01 14:23:31:002	0 A	2021-01-01 12:12:21:703	88 A	0 A	34 A

[sc_fcg_fsimeasuredvalues, 1, en_US]

Figure 3-47 SICAM FSI Measured Values

Updating the SICAM FSI Parameters using SICAM FCG Web GUI

You must update the SICAM FSI parameters whenever there is a change in MV overhead line conditions. To modify the existing SICAM FSI parameters, proceed as follows:

- ✧ In the SICAM FCG Web GUI, navigate to the **Configure** tab → **Operational parameters** → **Process connections** → **FSIs**.
- ✧ Go to **FSI specific settings**.
- ✧ Select the **Rated current (Irated)** from the list box.
- ✧ Select the **Current threshold** from the list box.
- ✧ Select the **Fault-indication time** from the list box.
- ✧ Select the **Wireless data reporting time** from the list box.
- ✧ Select the **Permanent fault-verification time** from the list box.
- ✧ Select the **DI current** from the list box.
- ✧ Select the **Inrush restraint time** from the list box.
- ✧ Select the **Auto reclosure retries** from the list box.
- ✧ Enter the **Auto reclosure time**.
- ✧ Select the **Cable type** from the list box.
- ✧ Enter the **Cable diameter**.
- ✧ Click **Send** to activate the changed parameters.
- ✧ Enter the **Password**.

✧ Click **Activation**.

The updated parameters are saved in SICAM FCG and communicated to the respective SICAM FSIs on the next communication time frame.

For example, the SICAM FSI communicates with SICAM FCG during the voltage detection, fault indication, fault reset, self test, and magnet reset.



NOTE

During the events, the respective LED sequence may stop intermittently, if the new SICAM FSI parameter settings are received from SICAM FCG.



NOTE

After receiving the new settings from SICAM FCG, the SICAM FSI takes 3 min to adapt to the MV overhead line conditions.

3.5 SICAM FSI Unmounting

SICAM FSI may be unmounted from the MV overhead line in the following situations:

- When the device is faulty
- To replace the battery
- When the SICAM FSI (6MD2314 - 1Ax10) firmware update is required

Before unmounting SICAM FSI, refer to [3.3 SICAM FSI Mounting](#) for safety instructions.

To unmount the device from the MV overhead line with hot stick with shotgun, proceed as follows:

- ✧ Open the hand grip of the hot stick with shotgun.
- ✧ Insert the jaw hook (hot stick with shotgun) in the eye hook of the device.
- ✧ Close the jaw hook using the hot stick with shotgun.



[file_sfsi_hotstick_unmounttilt, 1, en_US]

Figure 3-48 Moving SICAM FSI

- ✧ Move the hot stick with shotgun approximately 2 m in parallel to the MV overhead line to release the device.
For more information about the opening, closing, and locking the jaw hook of the hot stick with shotgun, refer to [3.3.2 Mounting SICAM FSI using Hot Stick with Shotgun](#)

To unmount the device from the MV overhead line with telescopic hot stick, proceed as follows:

- ✧ Rest the base of telescopic hot stick along with device adaptor on the ground. Before extending the telescopic hot stick, identify the device adaptor bottom flange which is inline with device adaptor slot for ease of locking device adaptor to SICAM FSI flange.

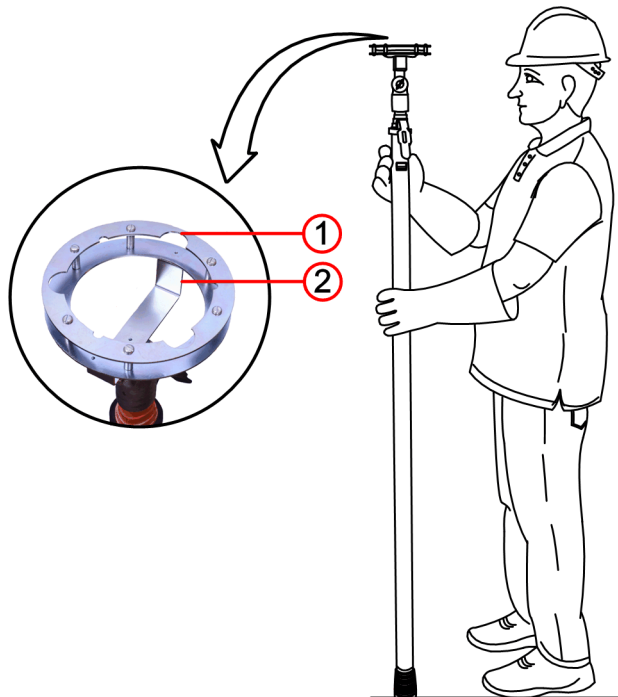

[te_sfs_telhotstkgmdwoFSI, 1, -,-]

Figure 3-49 Telescopic Hot Stick Base Resting on the Ground and Aligning Device Adaptor

- (1) Device adaptor slot
- (2) Bottom flange of device adaptor

For more information about extending and retracting telescopic hot stick vertically, refer to [3.3.3 Mounting SICAM FSI using Hot Stick \(Telescopic\) with Device Adaptor](#)

- ✦ Extend the telescopic hot stick to the necessary height and proceed to align bottom flange of device adaptor to one of the SICAM FSI flanges.

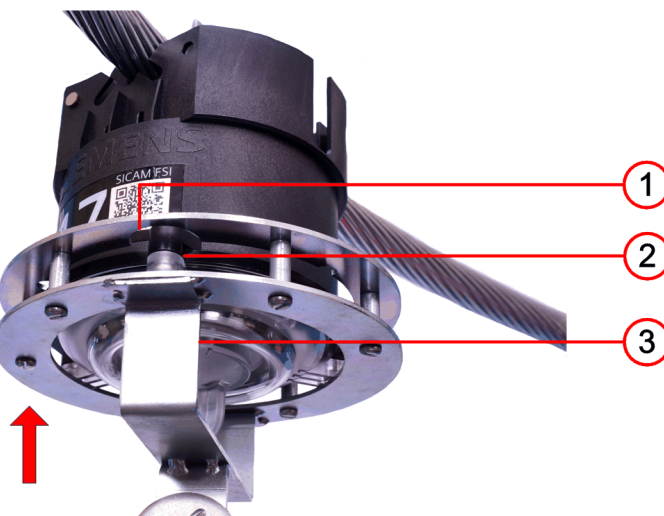

[te_sfs_unmountdevice, 1, -,-]

Figure 3-50 Aligning Device Adaptor to SICAM FSI

- (1) Device adaptor slot
- (2) SICAM FSI flange
- (3) Bottom flange of device adaptor

- ✧ Turn the device adaptor with the telescopic hot stick in either direction to lock the SICAM FSI in the device adaptor.

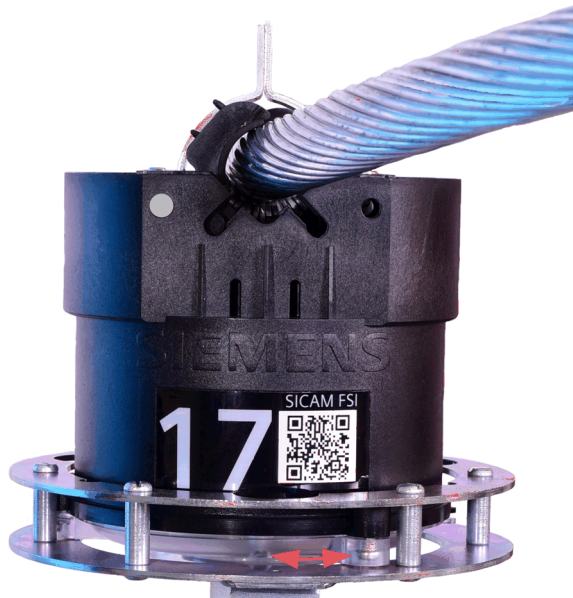

[dw_sfsi_unmountdeviceclick, 1, --]

Figure 3-51 Locking the SICAM FSI in Device Adaptor

- ✧ Move the telescopic hot stick approximately 2 m in parallel to the MV overhead line to release the device.

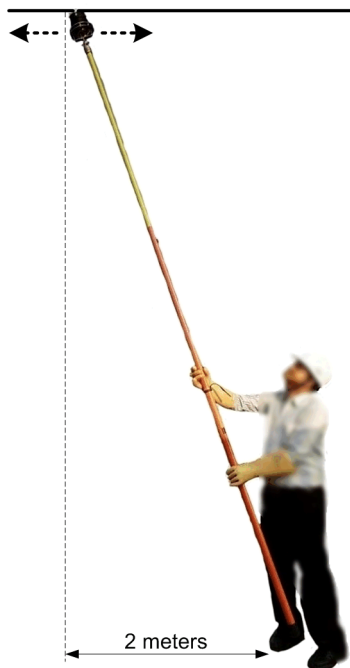

[le_sfsi_telhotstick_unmounttilt, 1, en_US]

Figure 3-52 Moving and Releasing SICAM FSI

3.6 Updating the Device Firmware

Contact local Siemens office or contact customer support for latest SICAM FSI firmware.

You can update the device firmware for the following variants:

- SICAM FSI via UART cable with SICAM FSI Configurator
- SICAM FSI with integrated communication via the SICAM FCG Web GUI

3.6.1 Updating the SICAM FSI Firmware via the UART Cable

The UART cable provides the connectivity between the USB of laptop computer and serial UART interfaces of the device. Siemens recommends using only the UART cable make: FTDI Chip with part number: TTL-232R-RPi. To update the device firmware via the UART cable, proceed as follows:

NOTICE

Exercise caution when updating the firmware.

Non-observance of the following specified measures means that material damage can occur.

- ✧ The printed circuit board (PCB) is an electrostatic sensitive device. Follow the ESD measures.
 - ✧ Prepare the working area and provide grounded mat for protecting components from electrostatic discharges (ESDs) damage.
 - ✧ Remove the PCB from the housing and place it on the prepared mat suitable for preventing ESD. Do not place the PCB on a metallic surface.
-
- ✧ With the help of a hot stick, unmount the device. Refer to [3.5 SICAM FSI Unmounting](#)
 - ✧ Connect one end of the UART cable to a PC or laptop computer. Refer to [3.2.1 SICAM FSI Installation](#)
 - ✧ Connect the UART end of the UART cable to the X2 (3-pin terminal) of the PCBA.

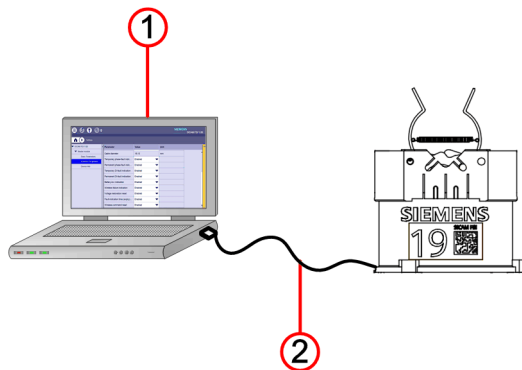

[file_sfs_uart_20160208, 3, ...]

Figure 3-53 SICAM FSI Firmware Update via UART

- (1) Laptop computer
- (2) UART cable

- ✧ Log on to device via the SICAM FSI Configurator.
For more information about updating firmware, refer to chapter [5.10.4 Updating Firmware](#).



NOTE

The device restarts automatically and the updated firmware is available in the next startup of the device.

3.6.2 Updating SICAM FSI with Integrated Communication Firmware via the SICAM FCG Web GUI



NOTE

- Before uploading latest firmware versions of SICAM FSIs in to SICAM FCG, SICAM FCG must be updated with its latest device firmware. Then SICAM FCG web GUI allows you to update the latest versions of firmware corresponding to associated FSIs.
- Before pairing new SICAM FSIs to existing SICAM FCG and SICAM FSI system, it is recommended that SICAM FCG Web GUI must be updated with latest SICAM FSIs firmware.

For SICAM FSI firmware version compatability with respective MLFBs, refer to [A.1 Firmware and Configurator Version Compatibility with SICAM FSI](#)

SICAM FSI firmware can be updated with the latest version via the SICAM FCG Web GUI. SICAM FCG indicates the availability of a new firmware version to all SICAM FSIs during the periodic communication time frame and checks for any firmware-update requirements. SICAM FSI requests SICAM FCG to update the firmware and once the firmware upload is completed, the new firmware becomes effective.

Contact local Siemens office or contact customer support for latest SICAM FSI firmware.

- SICAM FSI firmware files are available in **.cms** and **.fw** extension.
 - Example of file name: **FSI_VOX.XX.XX**

Updating the SICAM FSI Firmware

To update the SICAM FSI firmware (V01.XX/V02.XX/V03.XX) via SICAM FCG Web GUI, proceed as follows:

- ✧ Open the Web browser and enter the SICAM FCG IP address to access SICAM FCG Web GUI. In the **Log on** page, enter the **Log on password**.
- ✧ In the SICAM FCG Web GUI, navigate to **Maintenance** → **Firmware upload**.

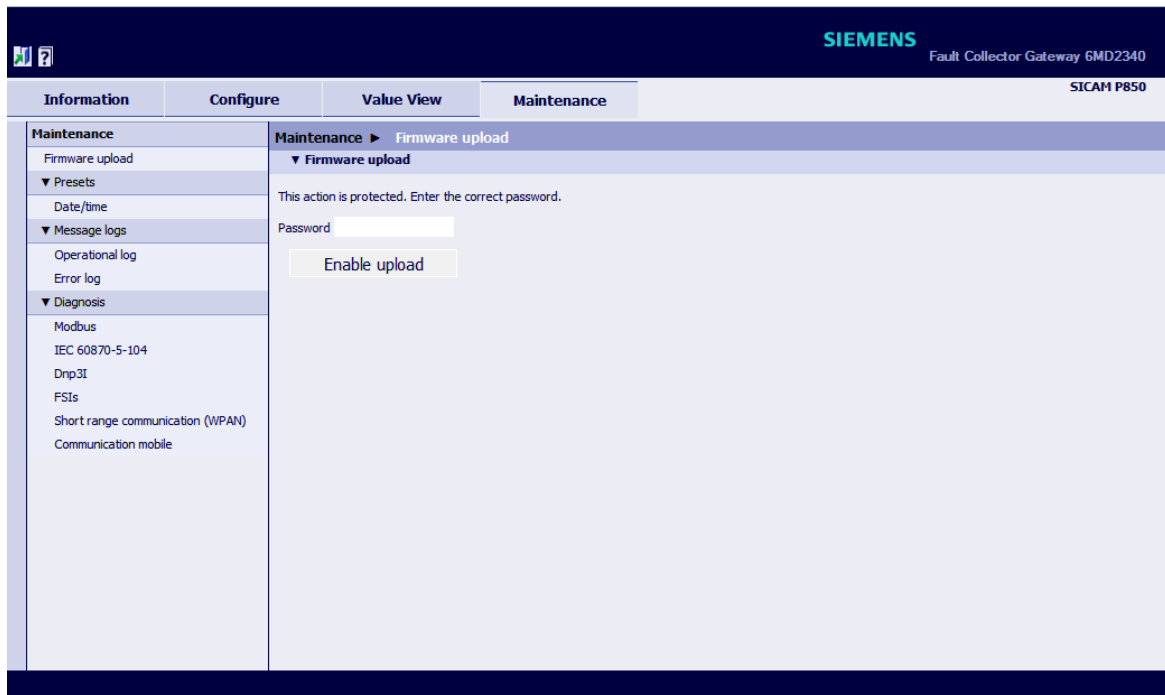

[sc_fcg_firmupdate, 1_en_US]

Figure 3-54 Maintenance Tab, Firmware Upload – Enable Upload Input/Output Window

✧ Enter the maintenance **Password** and click **Enable upload**. The following window is opened:

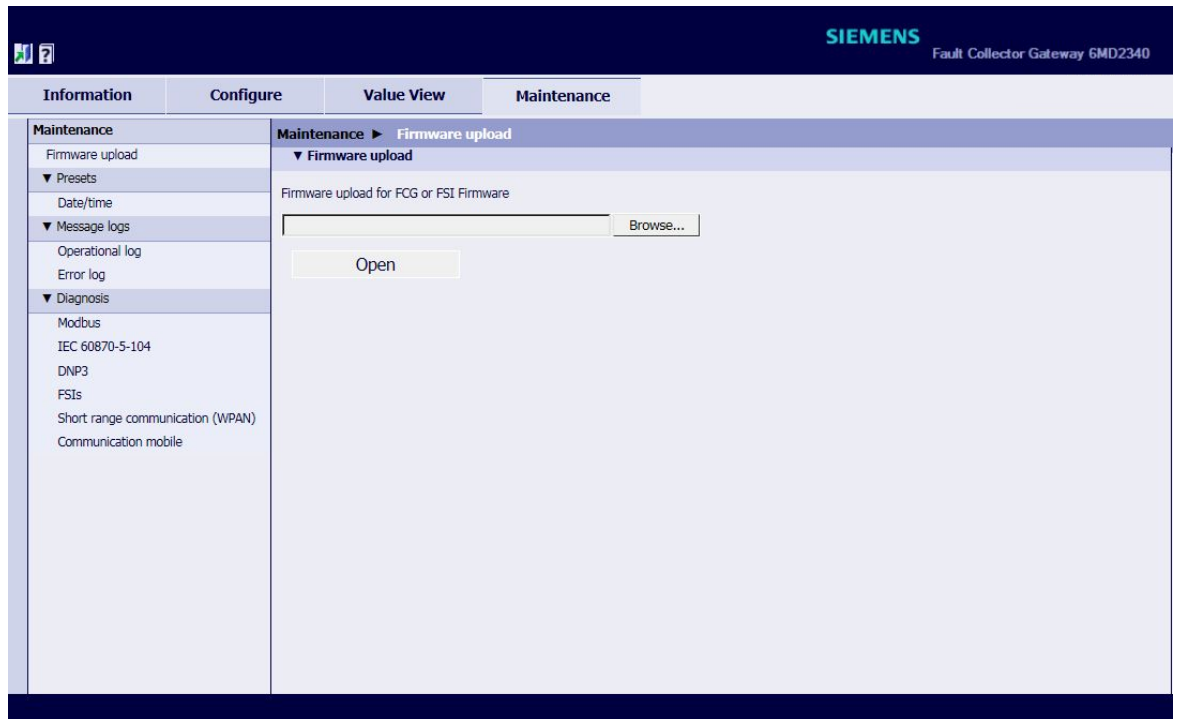

[sc_fcg_maint_fwup, 1, ...]
Figure 3-55 Maintenance Tab, Firmware Upload – Open Input/Output Window

✧ Click **Browse** and select the required firmware file for upload.

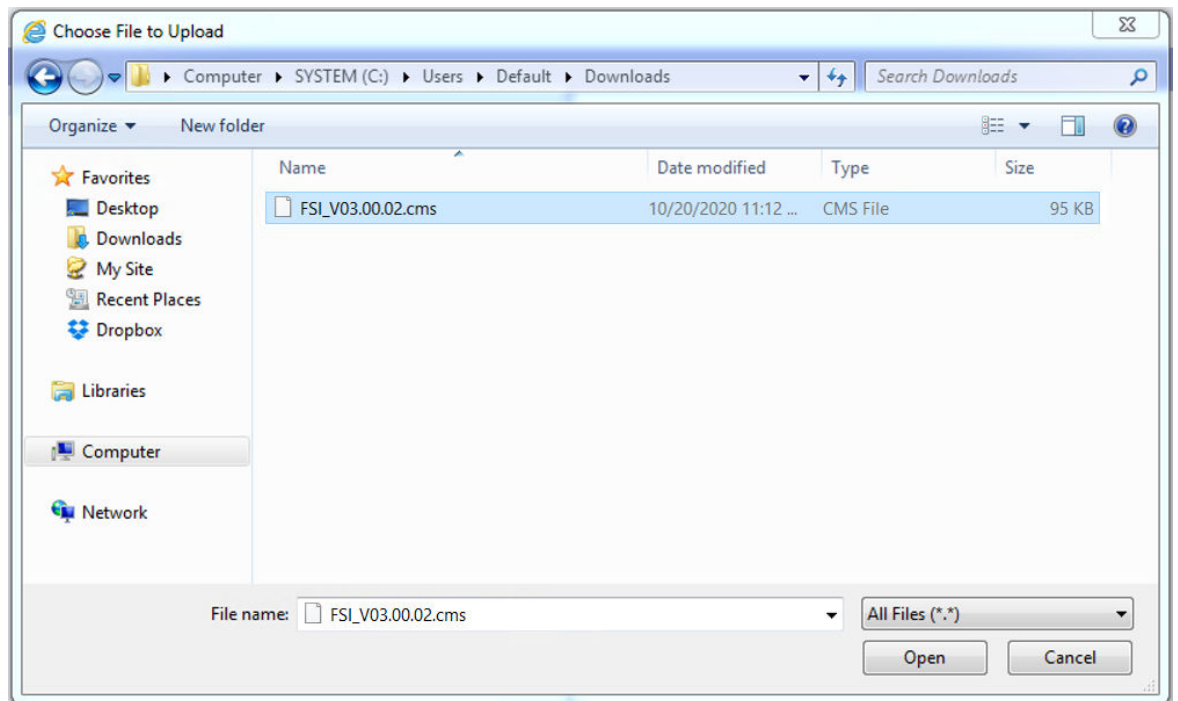

[sc_FSI_choosefiledialogue, 1, en_US]
Figure 3-56 SICAM FSI – Choose File Dialog

✧ Select the latest update file in the directory.

- ✧ Click **Open**.
The selected path is inserted in the input/output window, into the **Browse...**field.
- ✧ Click **Open**.
- ✧ The message **Action was successful** is displayed in the SICAM FCG Web GUI.

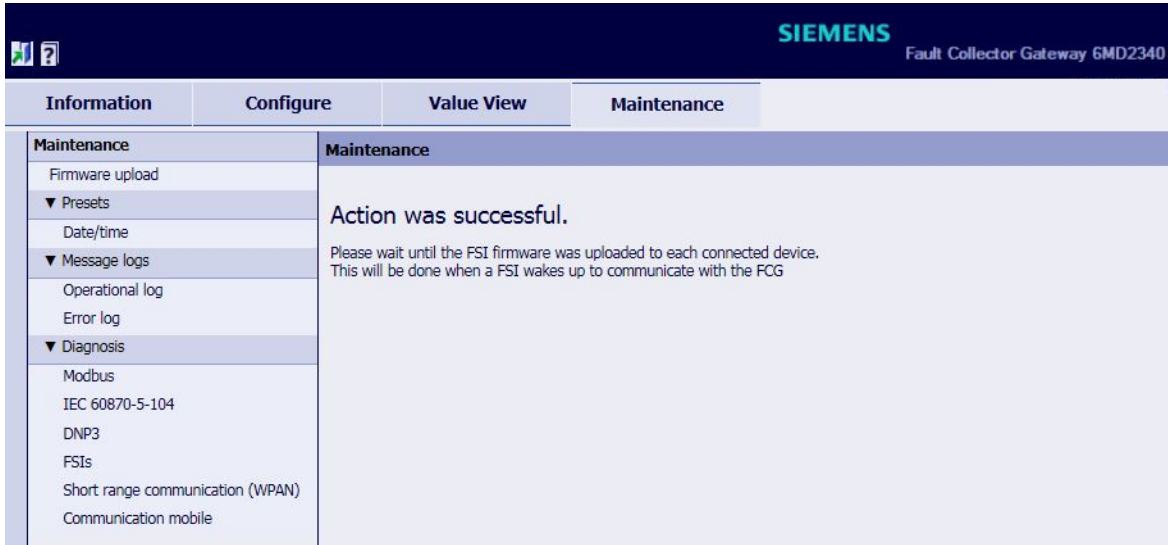

Figure 3-57 SICAM FSI Firmware - Action was Successful

- ✧ When different variants of SICAM FSI are associated with SICAM FCG, firmwares corresponding to each SICAM FSI hardware revision associated with SICAM FCG must be updated sequentially.
- ✧ Ensure to update the latest firmware version corresponding to SICAM FSI hardware version as per the firmware compatibility matrix ([Table A-1](#))
- ✧ In order to verify the firmware version of SICAM FSI uploaded in SICAM FCG and that present currently in SICAM FSI (will be overwritten by that in SICAM FCG), navigate to **Maintenance page** → **Diagnosis** → **FSIs**. Refer to chapter **Diagnosis SICAM FSI** of SICAM FCG User Manual.
- ✧ The latest uploaded SICAM FSI firmware corresponding to the respective SICAM FSI hardware version is sent during the periodic communication time frame. After receiving the appropriate and latest firmware, the SICAM FSI restarts and reconnects automatically to the short-range radio network.



NOTE

The successful firmware transfer is indicated in the SICAM FCG operational log. To verify the uploaded SICAM FSI firmware version and associated SICAM FSIs firmware version, navigate to **Maintenance page** → **Diagnosis** → **FSIs**. Refer to **6.17.4 Diagnosis SICAM FSI** of SICAM FCG User Manual.



NOTE

Due to the sequential association of SICAM FCG with SICAM FSIs, the SICAM FCG takes longer time to update firmware in all FSIs.
The corresponding firmware is updated to all associated FSIs in the next communication time frame based on the user-defined setting. For example, the communication window is 1 hour.

4 Device Functions

4.1	Device Functions	64
4.2	Short-Range Radio (Wireless) Communication	73

4.1 Device Functions

4.1.1 Network Parameters

Voltage Detection

SICAM FSI adapts to the MV overhead line voltage and detects the overcurrent faults based on the configuration and when it is mounted on the MV overhead line.

When the device is mounted on the MV overhead line for the first time after installing the battery, the device takes 3 min to adapt to the MV overhead line voltage.

To detect the voltage immediately after mounting, reset the device by placing the magnet adaptor within 2 cm to 3 cm near to the device transparent cover for approximately 1 s. The device detects the MV overhead line voltage, which is confirmed by flashing all the LEDs for 10 times (1 flash/s).

Subsequently in a fault condition, the voltage absence or presence is used to determine a temporary fault or permanent fault.

Power Frequency

SICAM FSI operates on the configured power frequency of 50 Hz or 60 Hz.

Current Measurement

SICAM FSI monitors the phase current continuously after it is mounted on the MV overhead line network. For both frequencies 50 Hz and 60 Hz, the current measurement ranges from 50 A to 800 A with an accuracy of $\pm 10\%$. Current measurement accuracies are guaranteed within the continuous carrying capacity of the overhead conductor.

The rated current for the device is configurable from 50 A to 500 A (in steps of 50 A). Trip threshold current can be configured 1.5 to 3 times that of rated current (upto 1500 A).



NOTE

To meet the current measurement accuracy specifications, the respective cable diameter on which SICAM FSIs are mounted must be configured in the device via SICAM FSI Configurator or SICAM FCG Web GUI.

In SICAM FSI DD and EE versions, if conductor type is not available in SICAM FSI Configurator or SICAM FCG Web GUI, then select conductor type as **Other** to configure the correct diameter manually.

4.1.2 Permanent-Fault Verification Time (PFVT)

The Permanent-Fault Verification Time (PFVT) is the time range required to convert the temporary fault to a permanent fault, based on status of voltage and current.

The PFVT can be configured as **Disabled**, **3 s**, **35 s**, and **70 s**.

For example, if the PFVT is set as **35 s** and if a fault (phase, di/dt) occurs, it is termed as temporary fault. The timer starts and continues for 35 s until the fault is evaluated.

If the voltage and current drops on MV overhead line during the PFVT, the temporary phase fault is converted to a permanent phase fault. Otherwise, this fault remains as a temporary phase fault until it is reset by one of the reset methods.

For more information about fault resets, refer to [4.1.4 Fault Resets](#)

If the PFVT is set as **Disabled**, it is internally considered as 500 ms.



NOTE

If auto-reclosure function is enabled, then conversion of temporary fault to permanent fault occurs only when auto reclosure time expires and voltage absence is detected.

4.1.3 Fault Detection

The device detects and indicates the **phase faults** and **di/dt faults** by continuously monitoring the phase current based on the device configuration. In a fault condition, the voltage presence or absence is used to determine a temporary fault or permanent fault indication. The temporary phase fault evolves to a permanent phase fault after confirming the voltage absence on the MV overhead line.

Both the phase fault and di/dt fault indications can be enabled or disabled using the respective configurations in the SICAM FSI Configurator or SICAM FCG Web GUI.

For more information about SICAM FSI configuration, refer to chapter [5.8 Advanced Parameter Settings](#)

Phase Faults

The phase faults are classified as:

- Temporary phase fault
- Permanent phase fault

Temporary Phase Fault

When the phase current exceeds the configured current threshold, the device detects and indicates a temporary phase fault. SICAM FSI detects a temporary phase fault typically in 2 cycles \pm 1 cycle (for both 50 Hz and 60 Hz), depending on current magnitude.

The device indicates the temporary phase fault via LEDs with a flashing pattern of 2 flashes every 6 s and also by sending the fault information to the SICAM FCG instantaneously (for SICAM FSI with integrated communication).

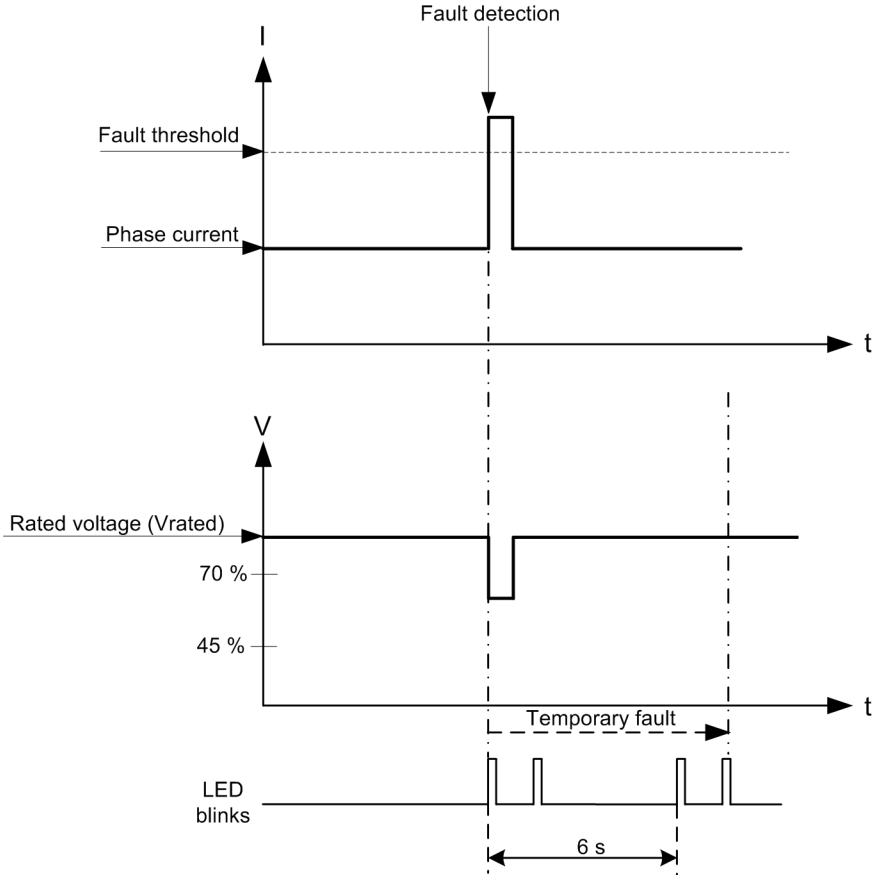

[dw_fsi_tempfault_2016-04-04_2_en_US]

Figure 4-1 Temporary Phase Fault

The following example shows how to calculate the setting for the phase-fault current:

$$\text{Phase-fault current} = I_{\text{rated current}} \times \text{current threshold}$$

For example, if the $I_{\text{rated current}} = 100 \text{ A}$ and the current threshold = 1.5 times $I_{\text{rated current}}$, then

$$\text{Phase-fault current setting} = 150 \text{ A} (100 \times 1.5)$$

Permanent Phase Fault

If the voltage and currents drops within PFVT after temporary phase fault, then device detects permanent phase fault. Otherwise, the device continues to indicate the temporary phase fault for the configured fault-indication time. The device evolves the fault from a temporary phase fault to a permanent phase fault when the voltage and current drops on the MV overhead line within PFVT.

The PFVT is configurable as **Disabled, 3 s, 35 s, and 70 s**.

The device indicates the permanent phase fault via LEDs with a flashing pattern of 1 flash every 6 s and also by sending the fault information to the SICAM FCG instantaneously (for SICAM FSI with integrated communication).

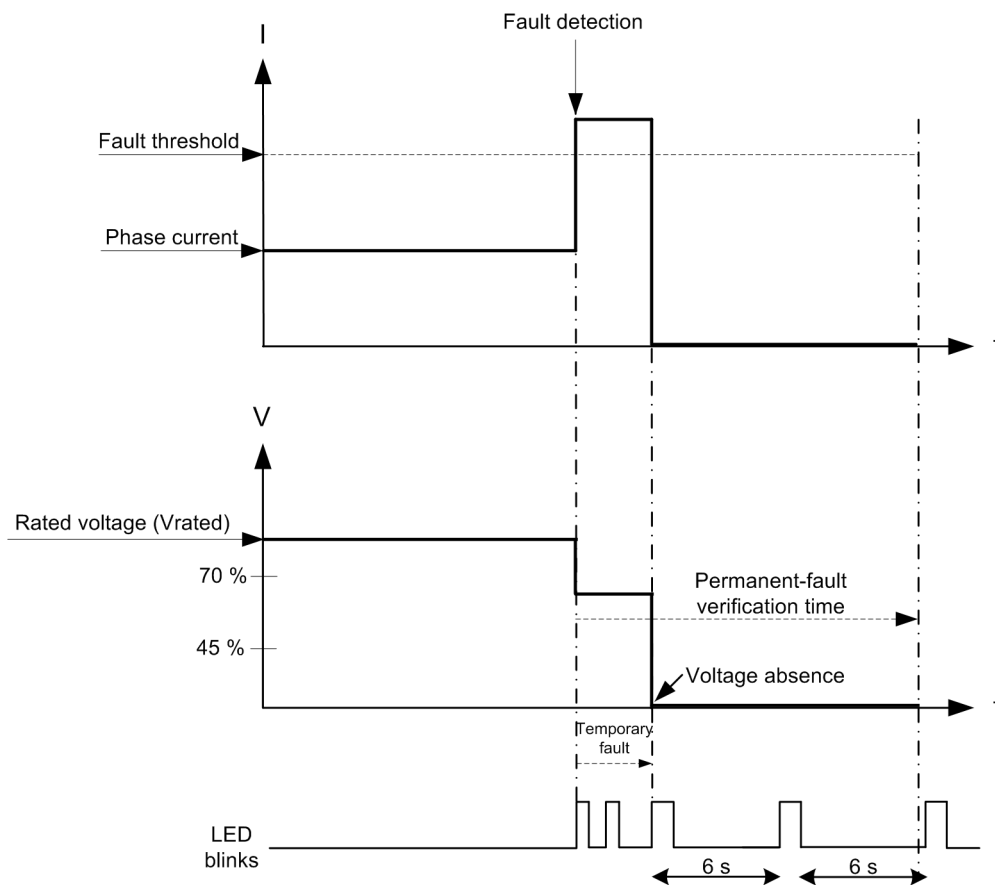

[dw_sfsi_permfault_2016-04-04_3_en_US]

Figure 4-2 Permanent Phase Fault

di/dt Fault

The low leakage ground faults are indicated by the rate of change of the phase current and it is termed as di/dt fault.

SICAM FSI detects the rate of change of current (di/dt) typically in 2 cycles ± 1 cycle, depending on current magnitude.

The di setting is configurable from 5 A to 80 A (in steps of 5 A), 120 A, and 160 A.

The device indicates the temporary di/dt fault via LEDs with a flashing pattern of 2 flashes every 6 s and also by sending the fault information to the SICAM FCG instantaneously (for SICAM FSI with integrated communication).

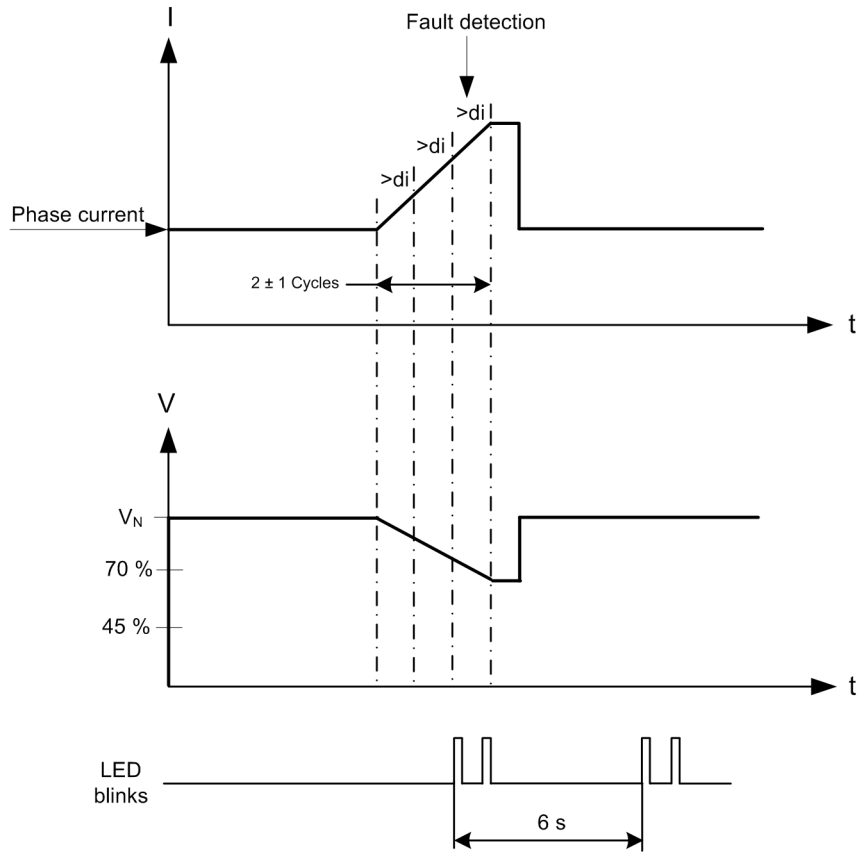

[dw_sfsi_tempdidtfault_2016-02-24_5_en_US]

Figure 4-3 Temporary di/dt Fault



NOTE

The di setting range is configurable from 5 A to 80 A (in steps of 5 A), 120 A, and 160 A. Siemens recommends keeping the di setting value $\geq 10\%$ of $I_{\text{rated current}}$ applicable for $I_{\text{rated current}} \geq 100$ A phase current.

The di setting works accurately for the phase current higher than 60 A.

The di/dt fault evolves from temporary di/dt fault to permanent di/dt fault, when the voltage and current drops on the MV overhead line within PFVT. The device indicates the permanent di/dt fault via LEDs with a flashing pattern of 1 flash every 6 s and also by sending the fault information to the SICAM FCG instantaneously (for SICAM FSI with integrated communication).

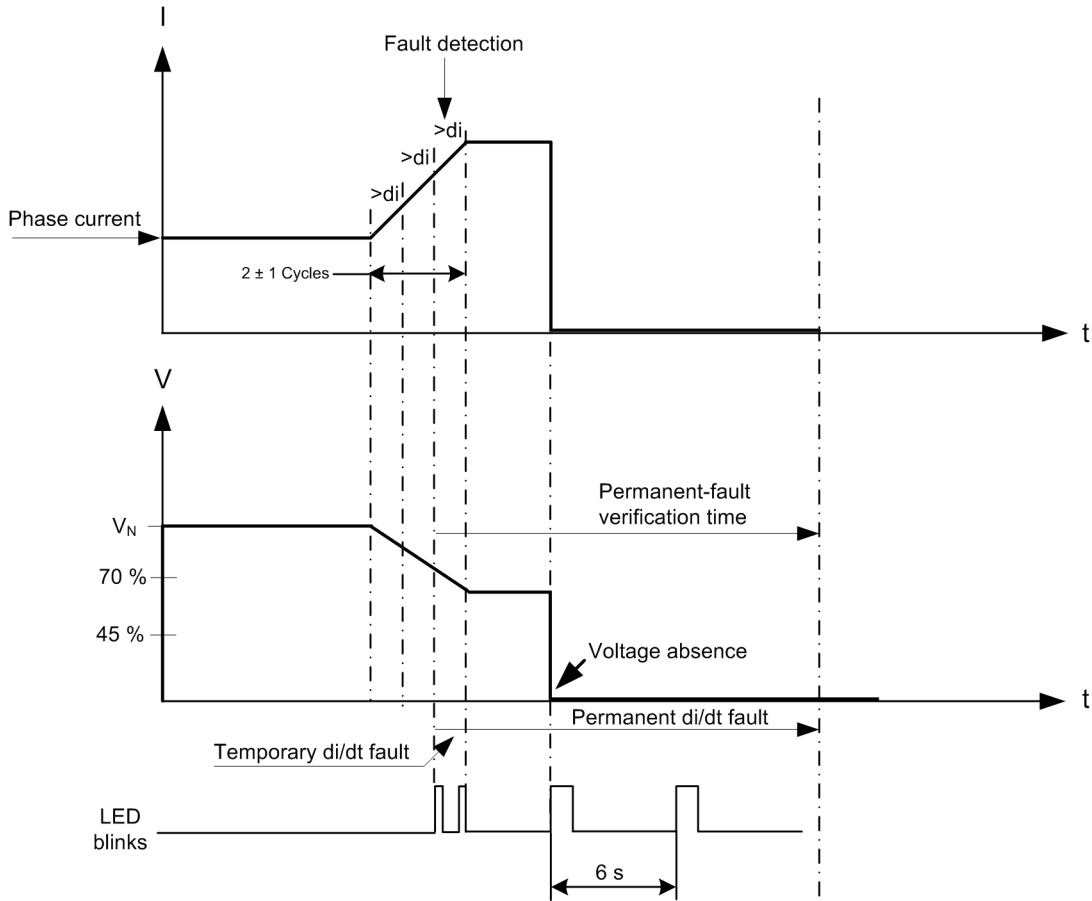

[idw_sfsi_permdidtfault_2016-02-24_4_en_US]

Figure 4-4 Permanent di/dt Fault

4.1.4 Fault Resets

After the fault is reset, the device LEDs stops flashing and the periodic phase-current measurements start again and the device is ready for detecting the new faults. The faults detected by SICAM FSI can be reset with the following methods.

- Voltage restoration
- Auto reset timer
- Manual reset
- Remote reset

Voltage Restoration

If the voltage-based reset is enabled via SICAM FSI Configurator, the device monitors for the voltage restored on the MV overhead line. When the device detects the line voltage > 70 % of the rated voltage, it resets the fault indication and starts the new measurements again.

In order to avoid wrong resets, the device monitors the voltage presence for the time equal to the PFVT configured for the device. If PFVT is disabled, the device monitors the voltage presence for 1 s.

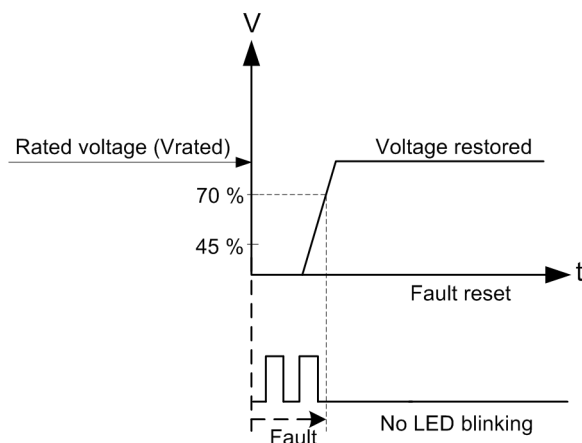

[dw_sfsi_voltagereset_2016-03-11, 2, en_US]

Figure 4-5 Voltage Reset

Auto Reset Timer

The auto reset is enabled based on the configured fault-indication time set via the SICAM FSI Configurator. The auto reset time can be configured from 2 h to 16 h (in steps of 30 min).

SICAM FSI resets the fault indication and starts new measurements on expiration of the fault-indication time. If the reset due to the fault-indication time is disabled, then device resets after 16 hours (maximum fault-indication time) to save battery power.

Manual Reset

The fault indications can be cleared manually by placing the magnet adaptor within 2 cm to 3 cm near to the device transparent cover for approximately 1 s.

By using the manual reset, the device does a self test by flashing all LEDs in clockwise direction for 5 times.

Remote Reset

For the SICAM FSI with integrated communication, the fault indications can be reset remotely from the control center via the SICAM FCG. The control center sends the fault-clearance request command to respective SICAM FSIs via SICAM FCG only on the next periodic communication.

SICAM FSI with integrated communication sends the fault information to the control center via SICAM FCG and if it does not get acknowledgement from SICAM FCG about the fault information received. SICAM FSI with integrated communication resends the fault information every 15 min until the SICAM FCG receives the fault information and acknowledgement.

4.1.5 Inrush Restraint

SICAM FSI blocks the fault detection for the configured inrush-restraint time due to the transformer magnetization during the voltage restoration on the MV overhead line.

The inrush-restraint time can be configured as **Disabled**, **3 s**, **30 s**, and **60 s**. The inrush-restraint time is initiated only after a voltage is detected in FSI.

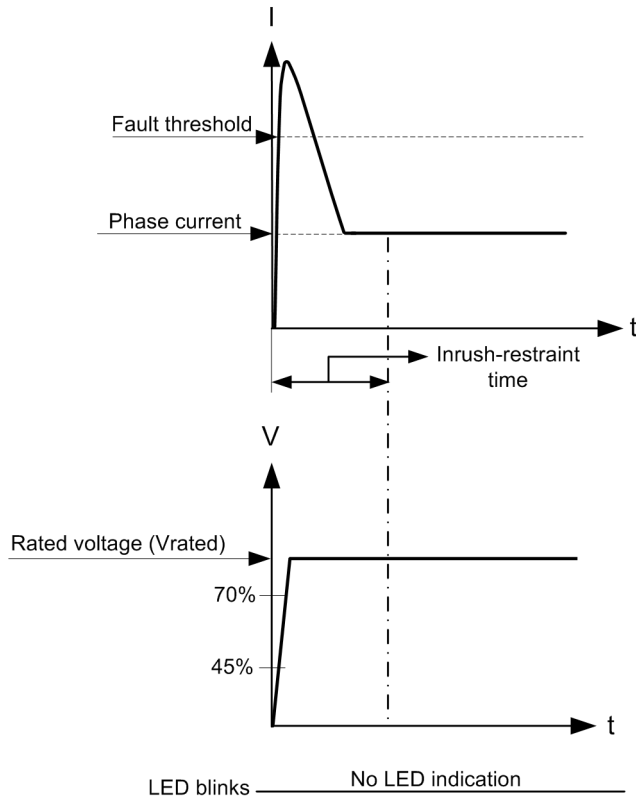

[dw_sfsi_inrushrestraint_2016-06-14_2_en_US]

Figure 4-6 Inrush Restraint

4.1.6 Auto-Reclosure

The auto-reclosure function is used to block the redundant fault detection during the auto-reclosure retries which are made to restore the MV overhead line.

After a fault, the MV overhead line is in trip state and auto-reclosure retries are made to restore the MV overhead line again. The device can detect the new faults based on the auto-reclosure retries.

In such case, when auto-reclosure time is set in the SICAM FSI Configurator, the device blocks such redundant fault detection for the configured auto-reclosure time.

If fault is cleared before expiry of auto-reclosure time, then the device continues to indicate temporary fault until a reset is done by any of the methods described in [4.1.4 Fault Resets](#).

The auto-reclosure time can be configured as **Disabled**, **0.1 s** to **99.9 s** via the SICAM FSI Configurator. You can configure the total reclosure time (total time to complete reclosure retries) as the device auto-reclosure time. The auto-reclosure retries parameter is only used as an information to describe the number of retries in the system.



NOTE

During the auto-reclosure time, the device continues to indicate any fault as a temporary fault. The conversion to permanent fault happens when auto-reclosure time expires and voltage absence is detected.

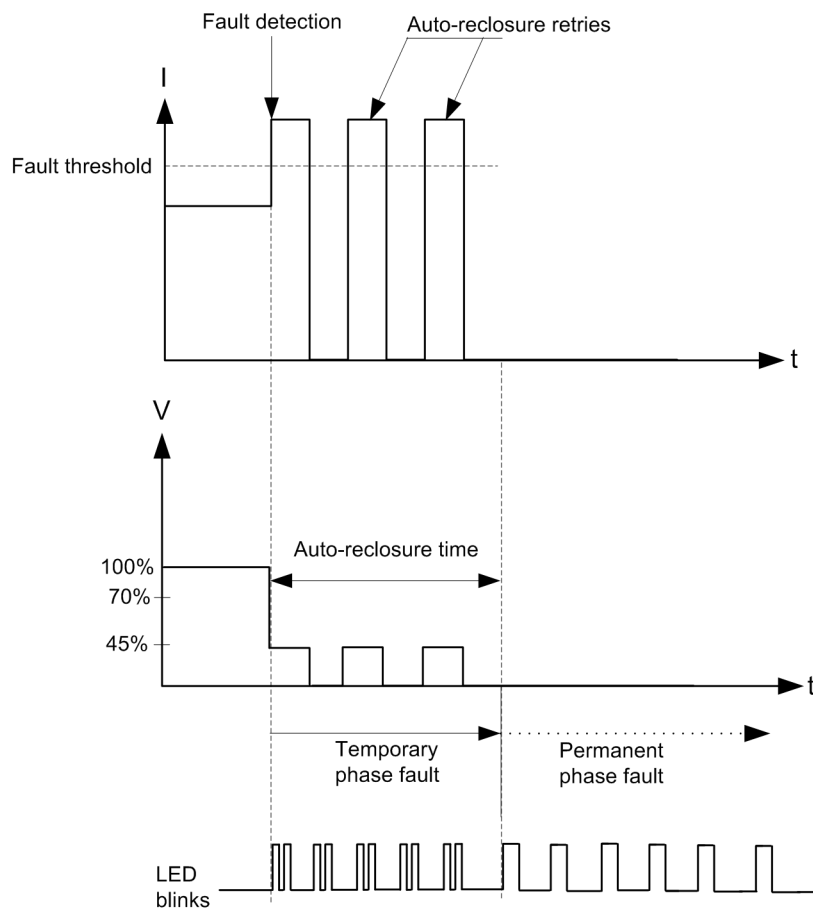

[dw_sfsi_autoreclose_2016-03-11, 3, en_US]

Figure 4-7 Auto-Reclosure

4.1.7 Self Test

You can execute the self test by magnet reset to verify the health of the device. During the self test, the device checks the status of the following:

- Battery health
- Short-range radio (wireless) communication

The success of self test is indicated by the self test pass LED sequence. The failure of battery and short-range radio (wireless) communication is indicated by a specific LED flashing pattern.

For more information about self test LED flashing sequences, refer to [4.1.10 SICAM FSI LED Flashing Sequence](#).

4.1.8 Battery Health

SICAM FSI is equipped with a non-rechargeable battery. The device periodically monitors the battery health and when the battery voltage is low, the device indicates the low battery status by flashing 3 LED every 15 s. If the battery voltage is low, Siemens recommends replacing the battery with a new one within 1 month after appearance of the low-battery indication.

The low-battery indication via LED can be enabled or disabled via the SICAM FSI Configurator.

In SICAM FSI with integrated communication, you can disable the LED indication for faults via the SICAM FCG Web GUI and receive the fault information via SICAM FCG only. By using this option, the SICAM FSI with integrated communication remains operational for a longer time in the low-battery condition.

4.1.9 Short-Range Radio (Wireless) Communication Module Check

The short-range radio (wireless) communication module health can be checked by executing the self test. The short-range radio (wireless) communication module failure results in 3 alternate LEDs flashing every 15 s for 10 min.

4.1.10 SICAM FSI LED Flashing Sequence

The device has 6 high luminous red LEDs for indicating the fault. The fault is visible in 360 degrees and the visibility ranges from 50 m in day and 300 m at night.

The following table displays the SICAM FSI events and the LED flashing sequences:

Table 4-1 SICAM FSI Events and Flashing Sequences

Events	LED Flashing Sequences
Startup	All LEDs flash for 2 s
Voltage detection	All LEDs flash 10 times
Temporary fault	All LEDs flash 2 times every 6 s
Permanent fault	All LEDs flash 1 time every 6 s
Self test pass	LEDs flash clockwise (one by one) 5 times
Battery low	3 LEDs (in sequence) flash every 15 s
Short-range radio (wireless) communication module failure	3 alternate LEDs flash every 15 s for 10 min

4.1.11 Energy Harvesting

The device is built in with the energy-harvesting feature apart from the primary source of power via battery. The device automatically switches its power source from the battery to energy-harvesting mode when the MV overhead phase current is greater than 60 A. Energy harvesting helps to extend the battery life time beyond 10 years.

Typically, the expected operational life of the device is 10 years for SICAM FSI when operating only on battery (including 400 hours of fault flashing) and under standard operating temperature of 25 °C.

The expected device life is further enhanced by 5 years if the energy harvesting is operational.

4.1.12 Low Temperature Cutoff

SICAM FSI is built in with an automatic cutoff feature when the temperature falls below -40 °C. The device functionality will get disabled when the temperature falls below -40 °C and will get re-enabled when the temperature goes above -37 °C.

In the above case, SICAM FSI with integrated communication (6MD2314-1Ax11) will also send the following event information to SICAM FCG. This will appear in the operational log of SICAM FCG device.

Information	Value	Description
Low Temperature Cutoff FSI	ON	Device functionality is disabled as temperature has fallen below -40 °C
Low Temperature Cutoff FSI	OFF	Device functionality is re-enabled as temperature has risen above -37 °C



NOTE

The temperature measurement accuracy is ± 3°C.

4.2 Short-Range Radio (Wireless) Communication

4.2.1 Overview

The SICAM FSI with integrated communication device communicates with the SICAM FCG via short-range radio (wireless) communication to transmit the fault information and periodic current measurements.

The short-range radio communication is a 2.4-GHz license-free frequency band with a communication protocol based on IEEE 802.15.4. The distance between SICAM FCG and SICAM FSI must be less than or equal to 100 m (line of sight).

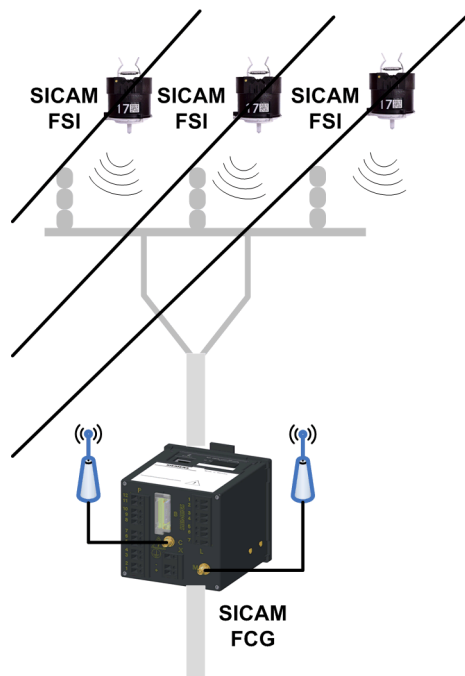

[dw_sfsi_srrcoverview, 1, en, US]

Figure 4-8 SICAM FSI 6MD2314 (Communicable) Mounted on the Overhead MV Line

After the secure connection establishment between SICAM FSI and SICAM FCG, SICAM FSI parameter set already configured and stored in the SICAM FCG would get transferred from SICAM FCG to SICAM FSI.

The following events are communicated instantaneously to SICAM FCG.

- All faults events
- Voltage presence or voltage absence
- Reset events

SICAM FSI sends the following measured value instantly to SICAM FCG in case of an event

- Instantaneous current

SICAM FSI also sends the following measured values to SICAM FCG in the configured wireless reporting time of SICAM FCG.

- Instantaneous current
- Minimum current
- Maximum current
- Average current
- Device health

SICAM FSI short-range radio (wireless) communication always remains in the sleep mode to save battery power. SICAM FSI wakes up after the configured wireless reporting time and communicates the periodic data and receives information such as configuration or firmware upload from SICAM FCG.

During the sleep mode of SICAM FSI, the communication between SICAM FSI and SICAM FCG is verified by performing the self test or magnetic reset on SICAM FSI. After the magnetic reset, SICAM FSI wakes up from the sleep mode and communicates with SICAM FCG to exchange the information.



NOTE

If SICAM FSI is unable to communicate with SICAM FCG as per the configured wireless reporting time (1 hour to 24 hours), then SICAM FSI retries communication with SICAM FCG in the following way:

- For the first hour: every 15 min
- After the first hour: 2 hrs, 4 hrs, 8 hrs, 16 hrs, and 24 hrs

Retry sequence is continued until an acknowledgment is received from the SICAM FCG.

To retry the communication immediately with SICAM FCG, perform magnetic reset of SICAM FSI. Magnetic reset also resets the FSI communication retry sequence.

4.2.2 SICAM FSI Measured Values

SICAM FSI measures the following current parameters and sends the information with SICAM FCG. These measured values are shared either instantaneously or periodically at the end of every configured wireless reporting time (1 h to 24 h).

- Instantaneous current
Instantaneous current register is updated with the measured current⁴ of the last measurement cycle period in case of expiry of wireless reporting interval configured.
The current value is shared instantaneously with SICAM FCG whenever an event occurs.
- Maximum current
This is the maximum measured current value within the last wireless reporting time interval.
- Minimum current
This is the minimum measured current value within the last wireless reporting time interval.
- Average current
Average current is the mean of measured current values within the last wireless reporting time interval.
Performing magnetic reset or device parametrization resets the average current.

For example, if the configured reporting time is 2 hours, then device sends the following current values of the last 2 hours periodically:

- Instantaneous current
- Maximum current
- Minimum current
- Average current values

SICAM FCG forwards the received SICAM FSI measured values and status information to the control center periodically via the communication protocol.

- ✦ Open the Web browser and enter the default IP address (192.168.0.55) to access SICAM FCG Web GUI.
- ✦ In the SICAM FCG Web GUI, navigate to **Value View** → **Operational parameters** → **Process connections** → **FSI Measured values**.

The **Measured values** dialog opens.

⁴ Measured current is the measured RMS value of 1 measurement cycle period (20 ms for 50 Hz, 16.6 ms for 60 Hz).

Value View		Value View ▶ Operational parameters ▶ Process connections ▶ FSI measured values					
▼ Operational parameters		▼ FSI measured values					
▼ Process connections		Instantaneous Data			Periodic Data		
FSIs	Receiving time	Instant current	Receiving time	Maximum current	Minimum current	Average current	
1	2021-01-01 14:28:32:559	50 A	2021-01-01 13:34:42:462	190 A	0 A	38 A	
	2021-01-01 14:28:31:430	50 A	2021-01-01 12:33:55:055	174 A	0 A	25 A	
	2021-01-01 14:23:31:022	0 A	2021-01-01 11:33:07:524	181 A	0 A	40 A	
2	2021-01-01 14:28:32:564	47 A	2021-01-01 14:07:21:602	187 A	0 A	27 A	
	2021-01-01 14:28:31:453	45 A	2021-01-01 13:06:34:020	187 A	0 A	32 A	
	2021-01-01 14:23:31:268	0 A	2021-01-01 12:05:46:555	87 A	0 A	33 A	
3	2021-01-01 14:28:32:511	40 A	2021-01-01 14:23:28:371	130 A	0 A	20 A	
	2021-01-01 14:28:31:553	40 A	2021-01-01 13:22:40:797	131 A	0 A	31 A	
	2021-01-01 14:23:31:350	0 A	2021-01-01 12:21:53:390	135 A	0 A	23 A	
4	2021-01-01 14:28:32:480	46 A	2021-01-01 14:21:50:367	171 A	0 A	23 A	
	2021-01-01 14:28:31:490	46 A	2021-01-01 13:21:02:785	169 A	0 A	37 A	
	2021-01-01 14:23:30:917	0 A	2021-01-01 12:20:15:384	171 A	0 A	28 A	
5	2021-01-01 14:28:32:529	46 A	2021-01-01 13:40:45:967	87 A	0 A	37 A	
	2021-01-01 14:28:31:406	46 A	2021-01-01 12:39:58:474	182 A	0 A	24 A	
	2021-01-01 14:23:30:980	0 A	2021-01-01 11:39:10:948	175 A	0 A	38 A	
6	2021-01-01 14:28:32:555	47 A	2021-01-01 13:45:57:720	87 A	0 A	36 A	
	2021-01-01 14:28:31:448	47 A	2021-01-01 12:45:10:205	188 A	0 A	25 A	
	2021-01-01 14:23:31:044	0 A	2021-01-01 11:44:22:686	188 A	0 A	38 A	
7	2021-01-01 14:28:32:563	41 A	2021-01-01 14:25:23:998	148 A	0 A	22 A	
	2021-01-01 14:28:31:469	43 A	2021-01-01 13:24:36:395	147 A	0 A	34 A	
	2021-01-01 14:25:23:998	0 A	2021-01-01 12:23:49:002	26 A	15 A	24 A	
8	2021-01-01 14:28:32:600	48 A	2021-01-01 14:08:55:486	184 A	0 A	28 A	
	2021-01-01 14:28:31:510	48 A	2021-01-01 13:08:07:916	184 A	0 A	34 A	
	2021-01-01 14:23:30:959	0 A	2021-01-01 12:07:20:465	88 A	0 A	32 A	
9	2021-01-01 14:28:32:487	50 A	2021-01-01 14:13:56:726	188 A	0 A	26 A	
	2021-01-01 14:28:31:531	50 A	2021-01-01 13:13:09:159	188 A	0 A	35 A	
	2021-01-01 14:23:31:002	0 A	2021-01-01 12:12:21:703	88 A	0 A	34 A	

[sc_fcg_fsimeasuredvalues, 1, en_US]

Figure 4-9 SICAM FSI Measured Values

4.2.3 Fault Alarms

SICAM FSI indicates the fault by flashing high luminous red LEDs. The optical indication pattern of the LEDs indicate the type of the fault. SICAM FSI detects any MV overhead line fault or other status change and communicates to the SICAM FCG via short-range radio (wireless) communication. SICAM FCG stores the fault alarms in the operational log.



NOTE

The fault alarms are sent to the SICAM FCG instantaneously irrespective of the configured reporting time.

To view and clear the **Operational log**, proceed as follows:



NOTE

The last 128 operational indications are displayed, older indications are automatically deleted.

- ✧ Open the Web browser and enter the default IP address (192.168.0.55) to access SICAM FCG Web GUI.
- ✧ In the SICAM FCG Web GUI, navigate to **Maintenance** → **Operational log**. The **Operational log** dialog opens.

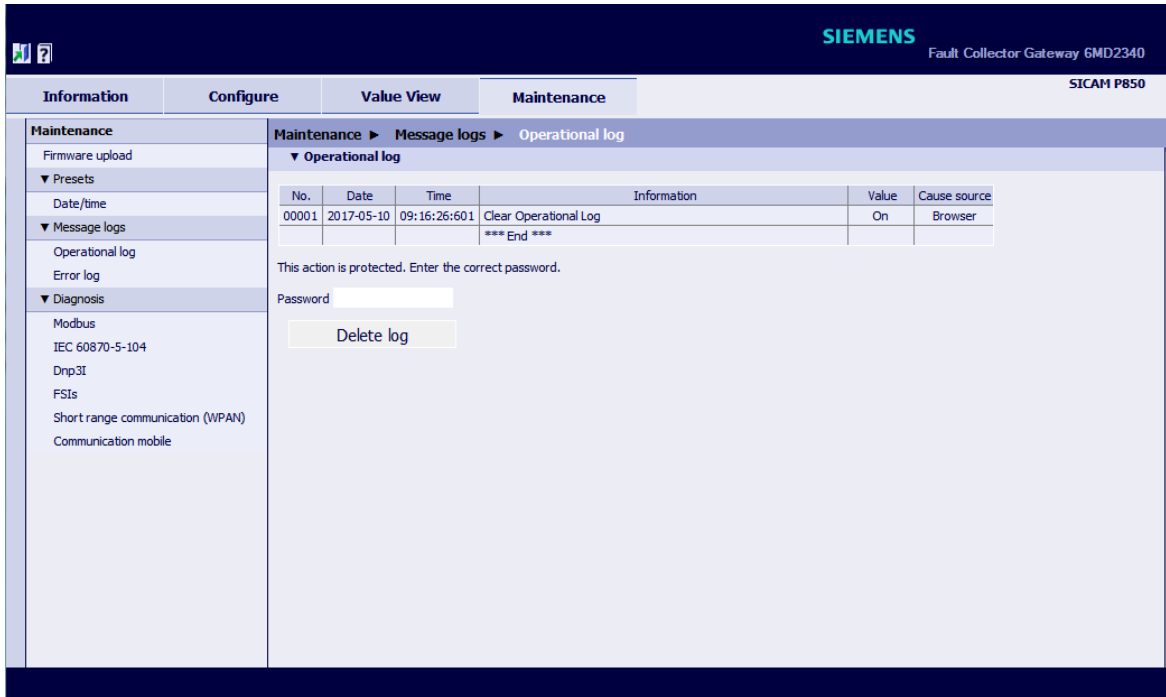

[sc_fcg_delete_oper_log, 1, en_US]

Figure 4-10 Maintenance Tab – Delete Operational Log

- ✧ Enter the maintenance **Password** into the **Password** field.
- ✧ Click **Delete log** in the dialog.
All operational indications in the dialog are deleted without backup.

4.2.4 Resetting SICAM FSI from SICAM FCG

The control center sends the fault-clearance command request to SICAM FCG via the communication protocol. SICAM FCG send the reset commands to the respective SICAM FSIs via short-range radio (wireless) communication.

4.2.5 Communication Test Mode

The communication test mode is used to verify the quality parameters of the short-range radio (wireless) communication.

The communication test mode can be started for a specific SICAM FSI or for all SICAM FSIs via the SICAM FCG Web GUI. In the test mode, the SICAM FCG and SICAM FSI exchange the messages every 5 s.

Once the test mode is started, SICAM FCG waits until the corresponding SICAM FSI short-range radio (wireless) communication wakes up in the next communication time frame.

The test mode is stopped via SICAM FCG Web GUI or after expiry of the defined duration of 1 hour. Once the test mode is completed, the short-range radio (wireless) communication is closed. At the end of the test mode, the short-range radio (wireless) communication module switches to sleep mode.

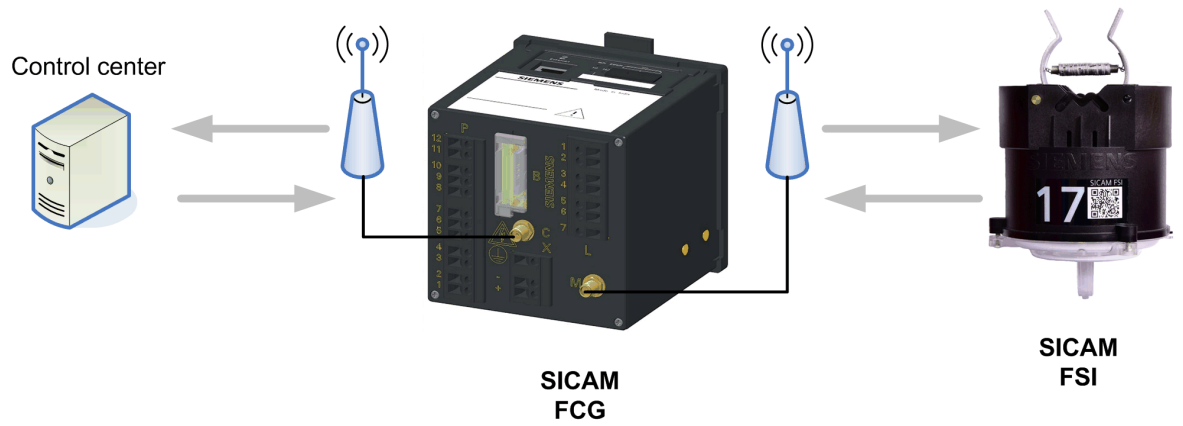

[dw_fsifcg_test_mode, 1, en_US]

Figure 4-11 SICAM FSI – SICAM FCG Short-Range Radio (Wireless) Communication Test Mode

5 SICAM FSI Configurator

5.1	Overview	80
5.2	Computer Configuration Requirements	81
5.3	SICAM FSI Configurator Installation	82
5.4	Control Functions	98
5.5	Starting the SICAM FSI Configurator User Interface	99
5.6	Dashboard	101
5.7	Basic Parameter Settings	104
5.8	Advanced Parameter Settings	106
5.9	Device Info	110
5.10	Device Settings	111
5.11	Log off	121
5.12	SICAM FSI Configurator Uninstallation	122

5.1 Overview

SICAM FSI Configurator is a Web-browser based configurator which allows you to configure and apply the parameters to the SICAM FSI device.

The main functions of SICAM FSI Configurator are:

- Configure and apply the engineering parameter settings to the SICAM FSI device
- Update the SICAM FSI firmware
- Read the parameter settings from SICAM FSI device and save the settings in an .xml file
- Restore the SICAM FSI device settings from the stored backup settings
- Reset the SICAM FSI device to the factory settings
- Display the following device information:
 - SICAM FSI firmware version
 - Boot-loader version
 - Application software version
- Display the following radio module information:
 - Boot-loader version
 - Application version
 - Stack version
- Display the device health state

5.2 Computer Configuration Requirements

Before installing and operating the SICAM FSI Configurator, ensure that your personal computer (PC) or laptop computer is equipped with the following minimum hardware specifications and the operating system:

- 1-GHz processor or higher
- 1 GB of free storage capacity on the hard disk
- 1 GB of RAM (2 GB recommended)
- Graphic display with a resolution of 1024 x 768 pixels (1280 x 1024 pixels recommended)
- USB 2.0 or higher port
- Operating system (recommended)
 - Windows 7 (64 bit) or Windows 10 (64 bit)

5.3 SICAM FSI Configurator Installation

Before installing the SICAM FSI Configurator on the PC or laptop computer, download the SICAM FSI Configurator (Setup.exe) from the following Siemens Internet page:

<https://support.industry.siemens.com/cs/document/109763640> or distributed by the siemens customer care representative

To install the SICAM FSI Configurator, proceed as follows:

- ✧ Double-click the **Setup.exe**.

If the SICAM FSI Configurator is already installed in the PC or laptop computer, the following Welcome Setup screen appears. In this process, the existing version of configurator is automatically removed and initiates upgrade to SICAM FSI Configurator.

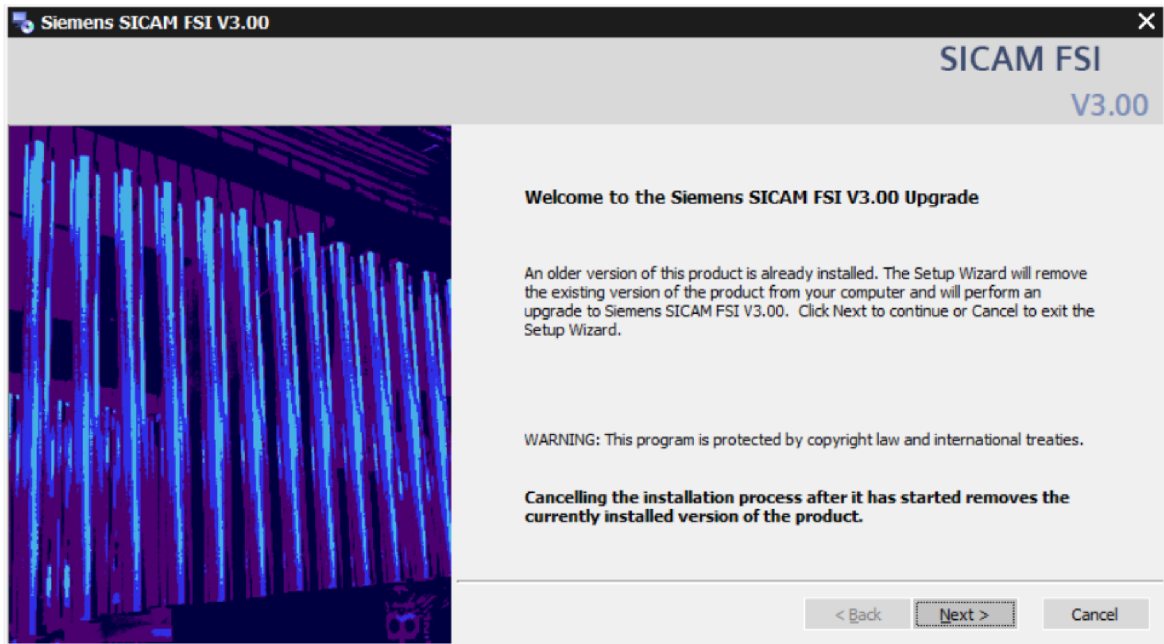

[sc_fsi_welcome_upgrade_1_1_en_US]

Figure 5-1 SICAM FSI Configurator Setup – Welcome Screen to Upgrade

The following **Welcome Setup** screen appears if the SICAM FSI Configurator is installed for first time.

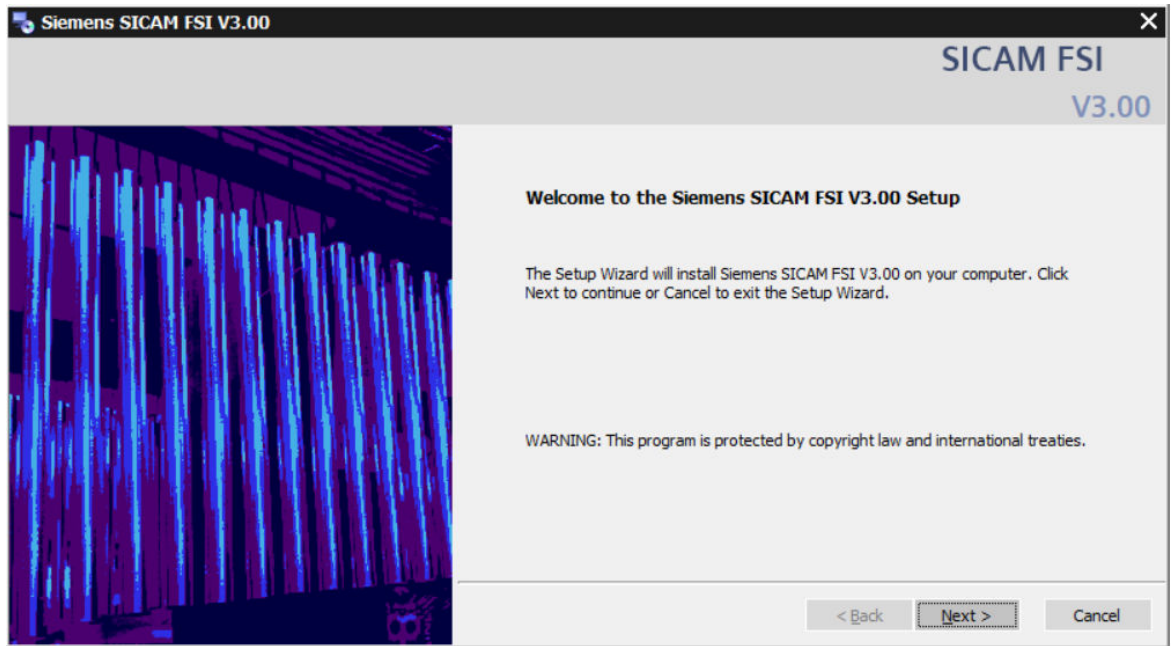

[sc_fsi_welcome_setup, 1, en_US]

Figure 5-2 SICAM FSI Configurator Setup – Welcome Screen

- ✧ Click **Next >** to install the SICAM FSI Configurator in the destination folder. Siemens recommends keeping the SICAM FSI Configurator installation in the following default folder:
C:\Program Files (x86)\Siemens Energy\SICAM FSI

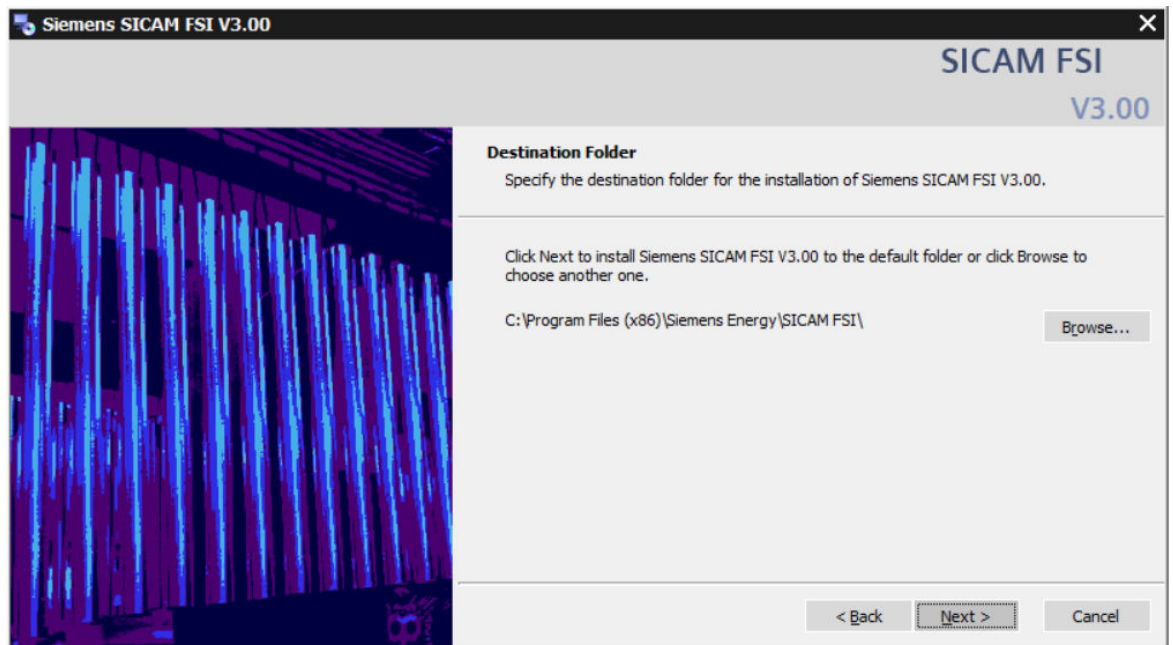

[sc_fsi_destinationfolder, 1, en_US]

Figure 5-3 SICAM FSI Configurator Setup – Destination Folder

- ✧ Click **Next >** to begin the SICAM FSI Configurator installation.

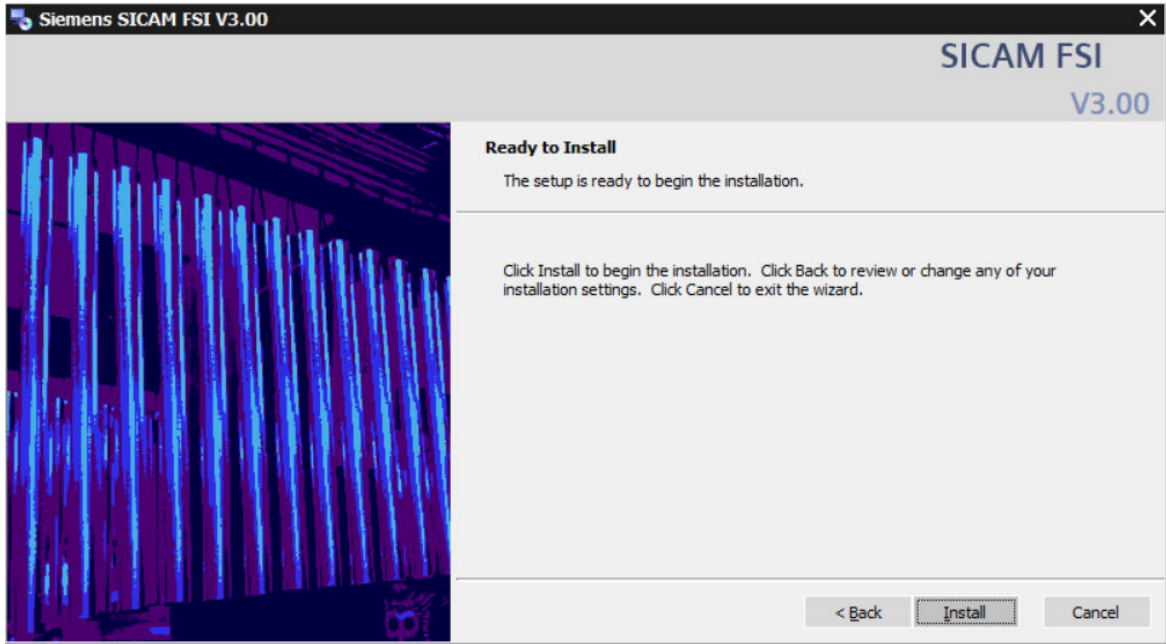

[sc_fsi_readytoinstall, 1, en_US]

Figure 5-4 SICAM FSI Configurator Setup – Ready to Install

✦ Click **Install** to start the SICAM FSI Configurator installation.

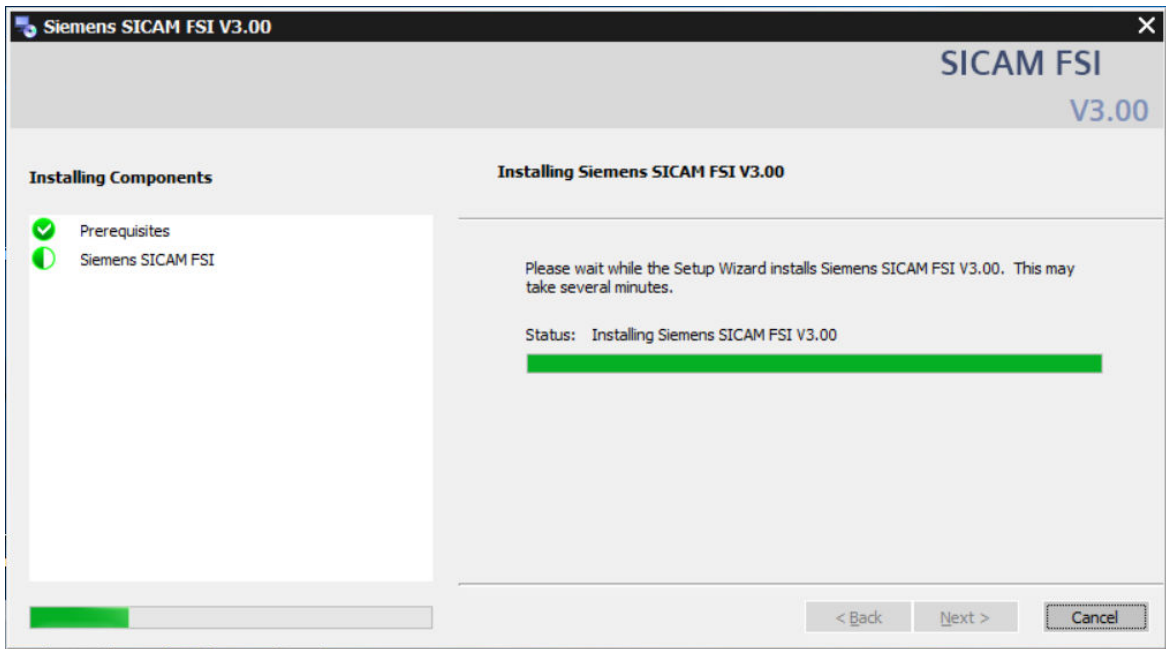

[sc_fsi_installing, 1, en_US]

Figure 5-5 SICAM FSI Configurator Setup – Installation In Progress

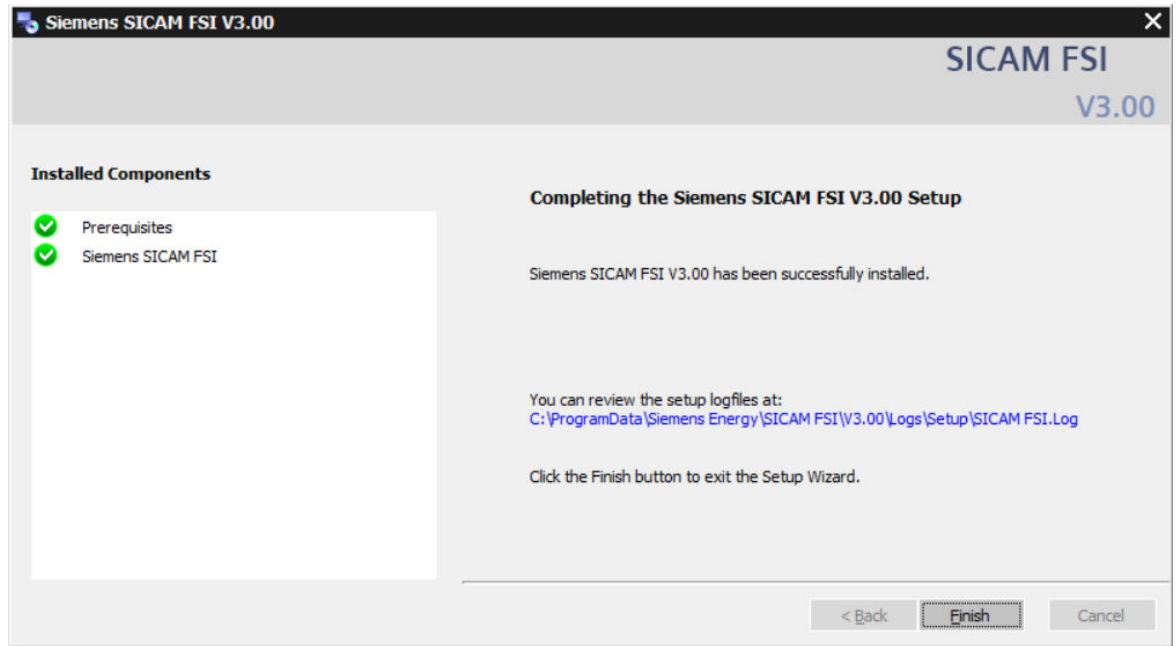

[sc_fsi_installfinish, 1, en_US]

Figure 5-6 SICAM FSI Configurator Setup – Installation Finished

- ✧ Click **Finish** to complete the Siemens FSI Configurator installation.

Installing UART Cable Drivers

If you are installing the SICAM FSI Configurator for the first time, install the UART cable drivers on your PC or laptop computer.

Make sure that you complete the installation procedure until **USB Serial Port** is visible in **Device Manager** → **Ports**.

- ✧ Plug in the USB connector of the UART cable to the USB port of the PC or laptop computer.
- ✧ Select **Start Menu** → **Control Panel** → **Device Manager**

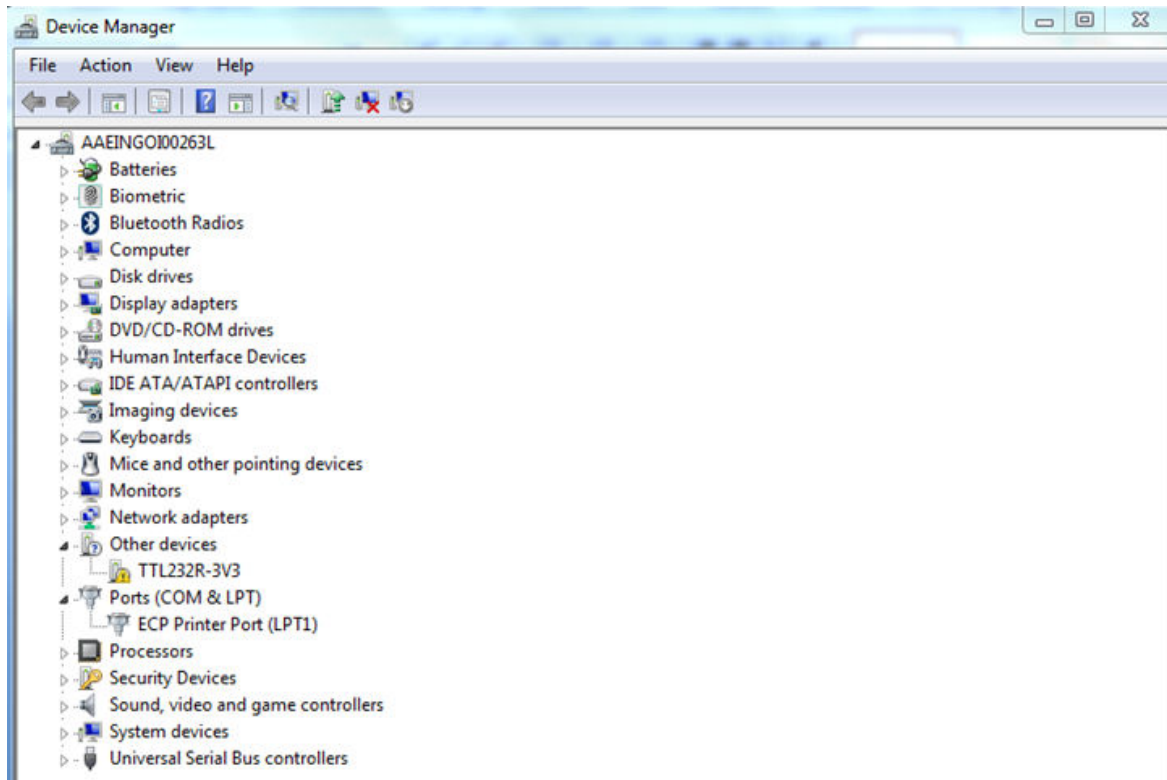

[sc_fsi_usbdri-ttl, 1, ...]

Figure 5-7 UART Cable Drivers – Device Manager

- ✧ In the **Device Manager**, navigate to **Other devices**. Right-click **TTL232R-3V3** and select **Update Driver Software** option.

Siemens recommends using only the UART cable make: FTDI Chip with part number TTL-232R-RPi.

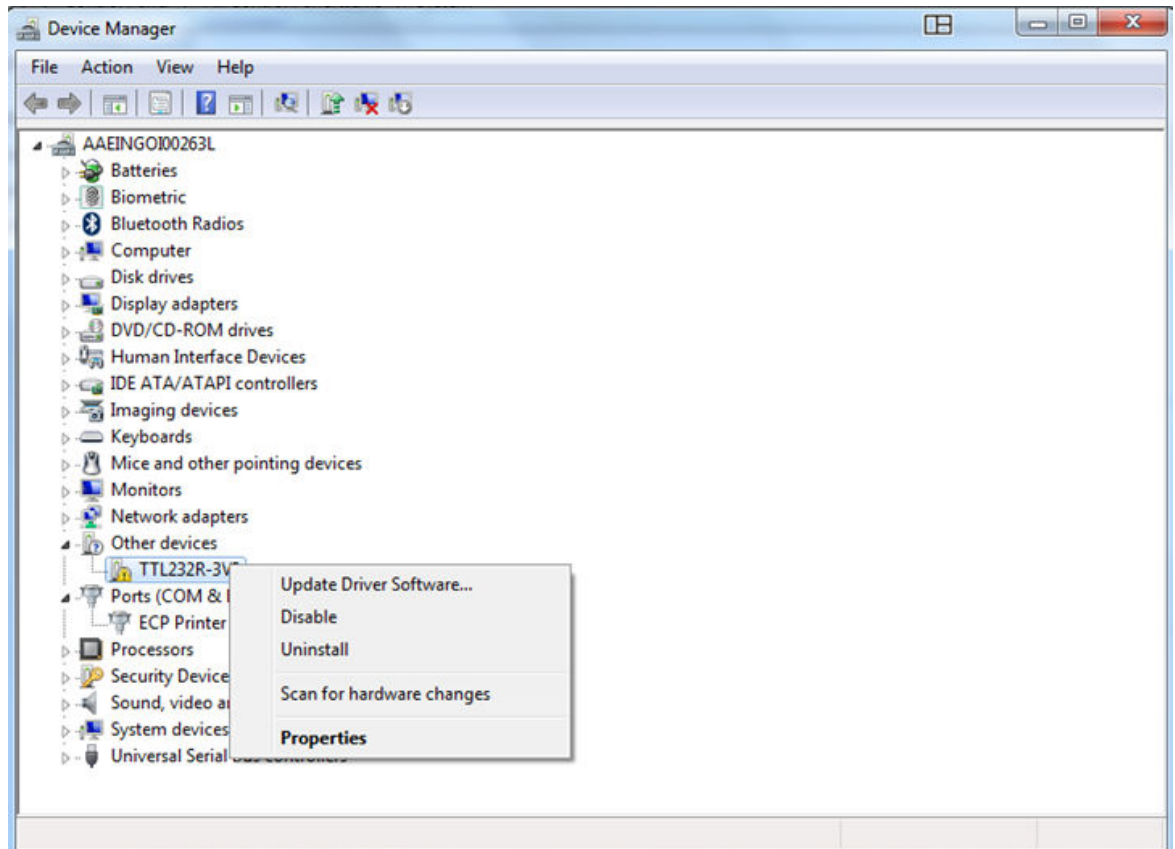

[sc_fsi_usbdri-ttl0ds, 1, -,-]

Figure 5-8 UART Cable Drivers – Update Driver Software

- ✧ Click **Browse my computer for driver software** to locate and install the driver software.
The drivers are available in the following default folder:
C:\Program Files (x86)\Siemens Energy\SICAM FSI\USBDrivers

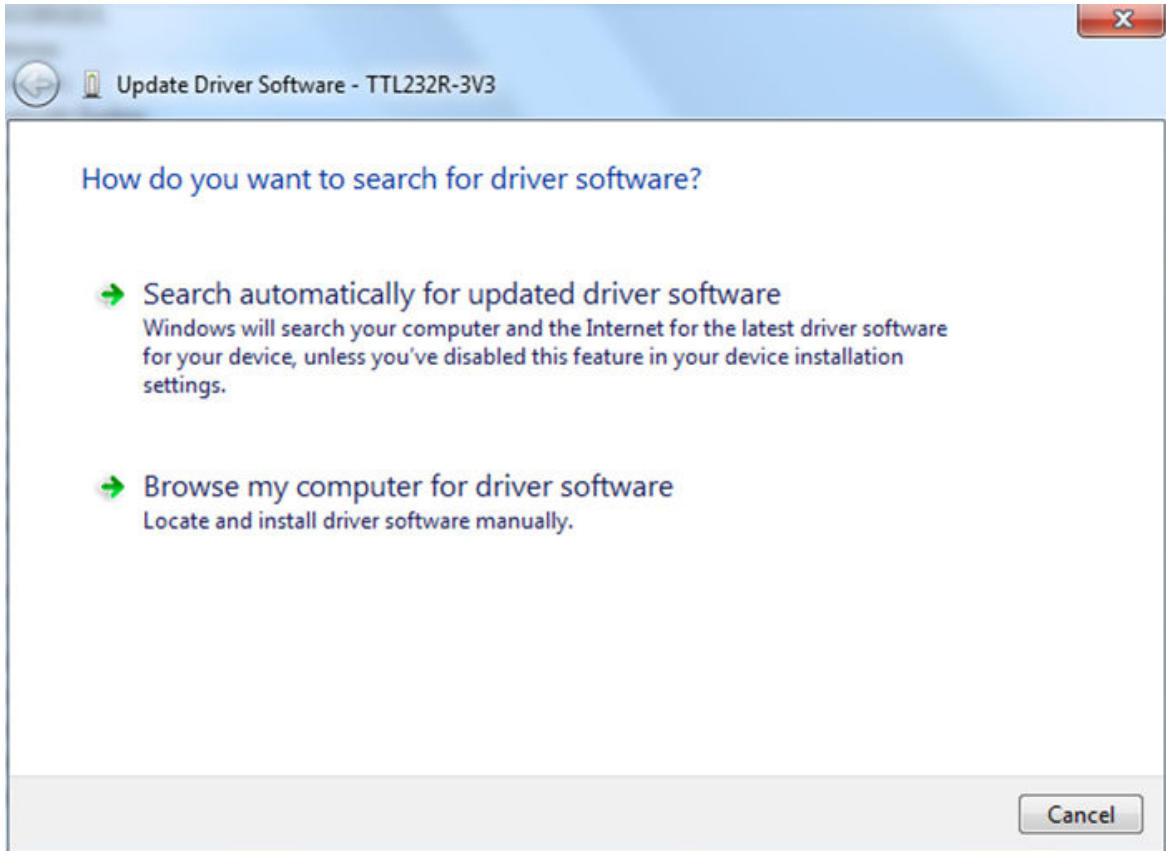

[sc_fsi_usbdri-ttlbrowse, 1, ...]
Figure 5-9 UART Cable Drivers – Locate Driver Software

- ✧ Click **Next** to begin the driver software installation.

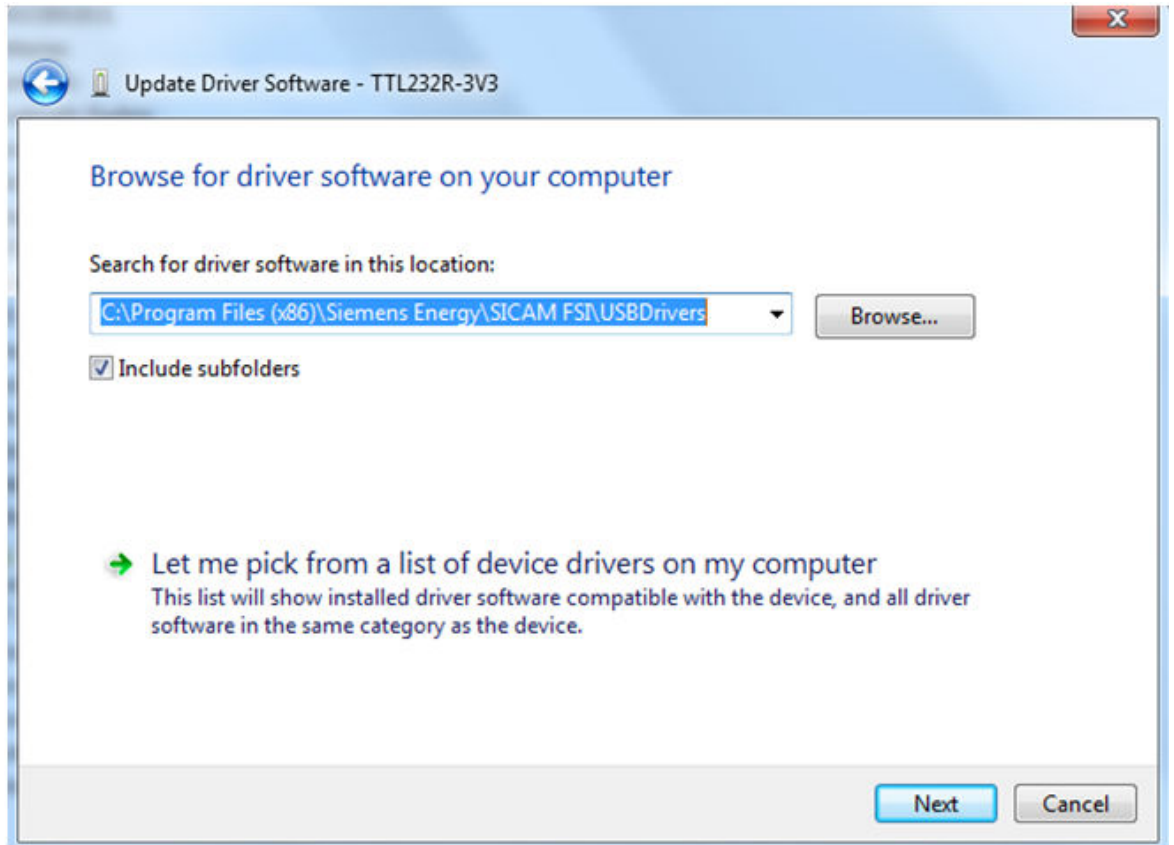

[sc_fsi_usbdri-ttlnext_1_...]

Figure 5-10 UART Cable Drivers – Driver Software Installation

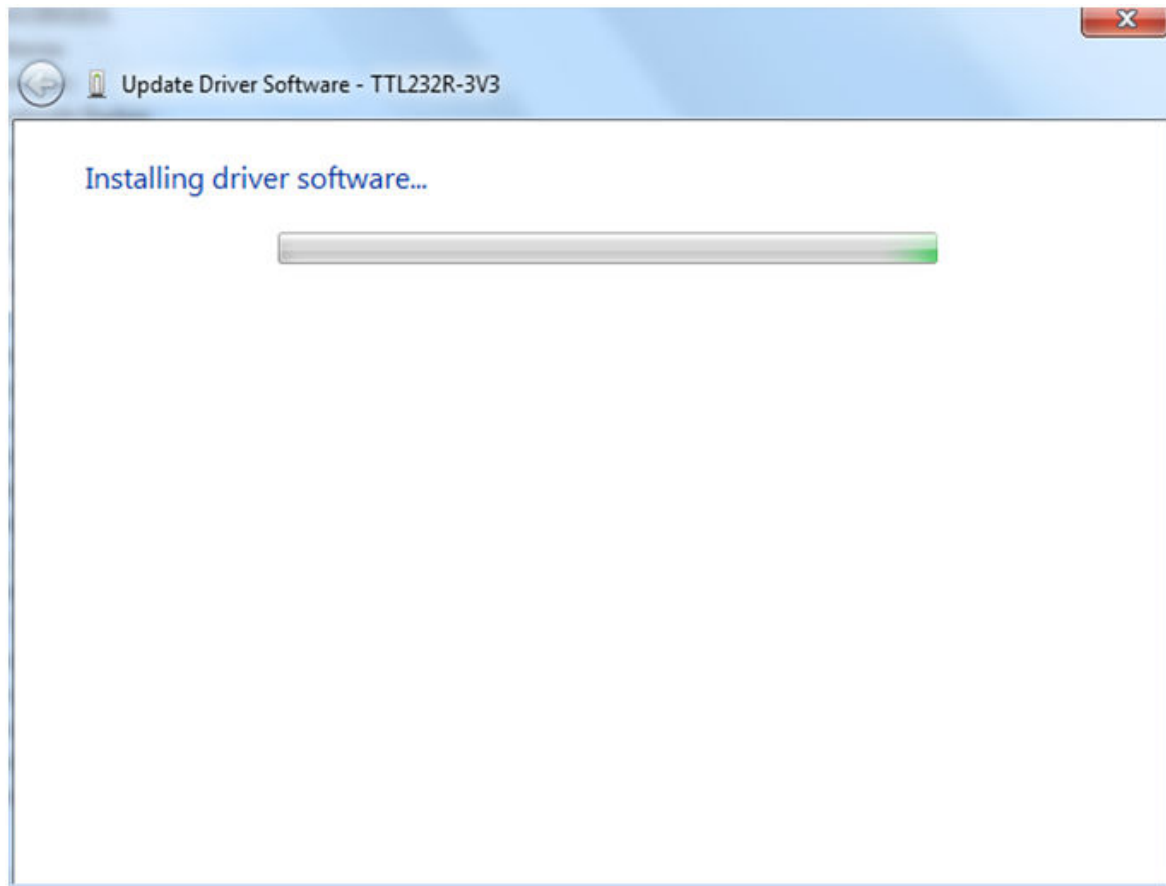

[sc_fsi_usbdrv-ttlinstprog, 1, --]

Figure 5-11 UART Cable Drivers – Installation In Progress

- ✧ Click **Close** once the driver software is successfully installed.

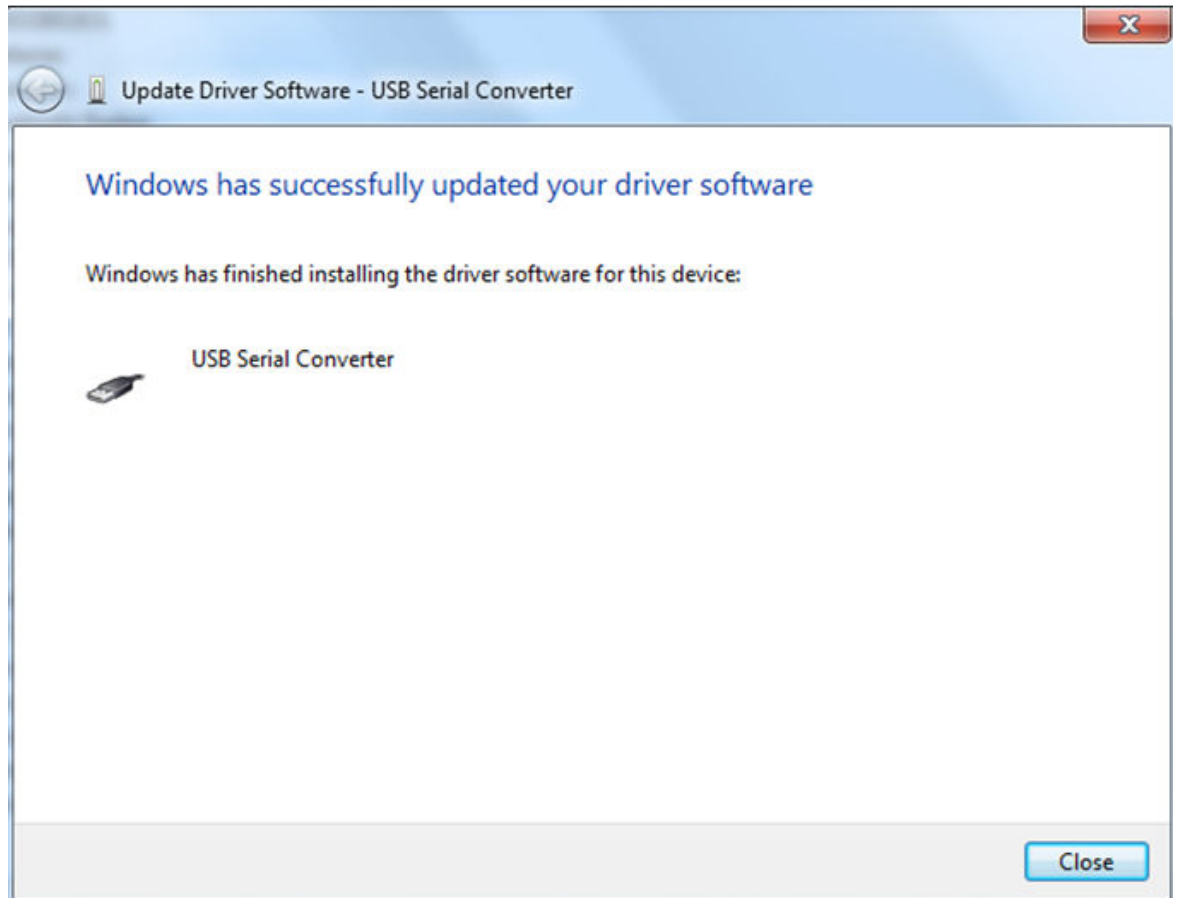

[sc_fsi_usbdri-ttlsuccess, 1, ...]

Figure 5-12 UART Cable Drivers – TTL232R-3V3 Installation Finished

- ✧ In the **Device Manager**, navigate to **Other devices**. Right-click **USB Serial Port** to select the **Update Driver Software** option.

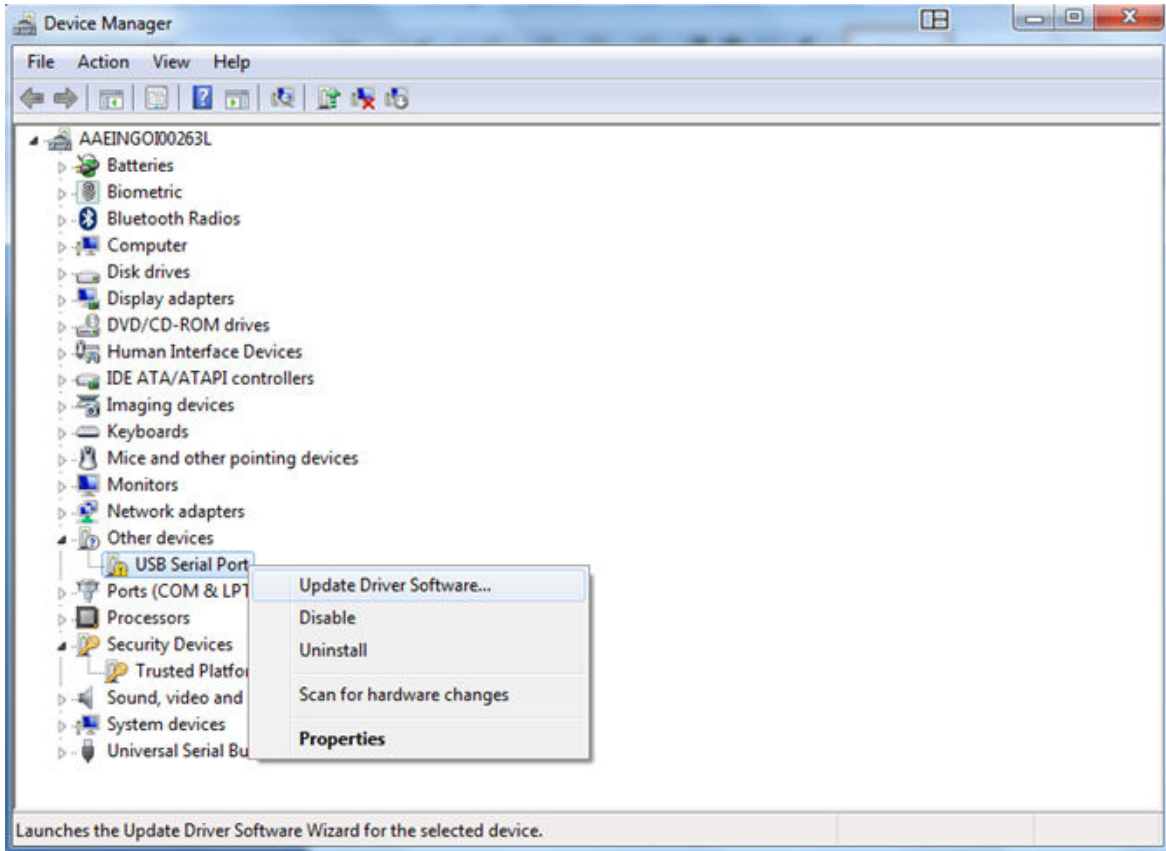

[sc_fsi_usbdri-srpt, 1, ...]

Figure 5-13 USB Serial Port Drivers – Update Driver Software

- ✧ Click **Browse my computer for driver software** to locate and install the driver software.
The drivers are available in the following default folder:
C:\Program Files (x86)\Siemens Energy\SICAM FSI\USBDrivers

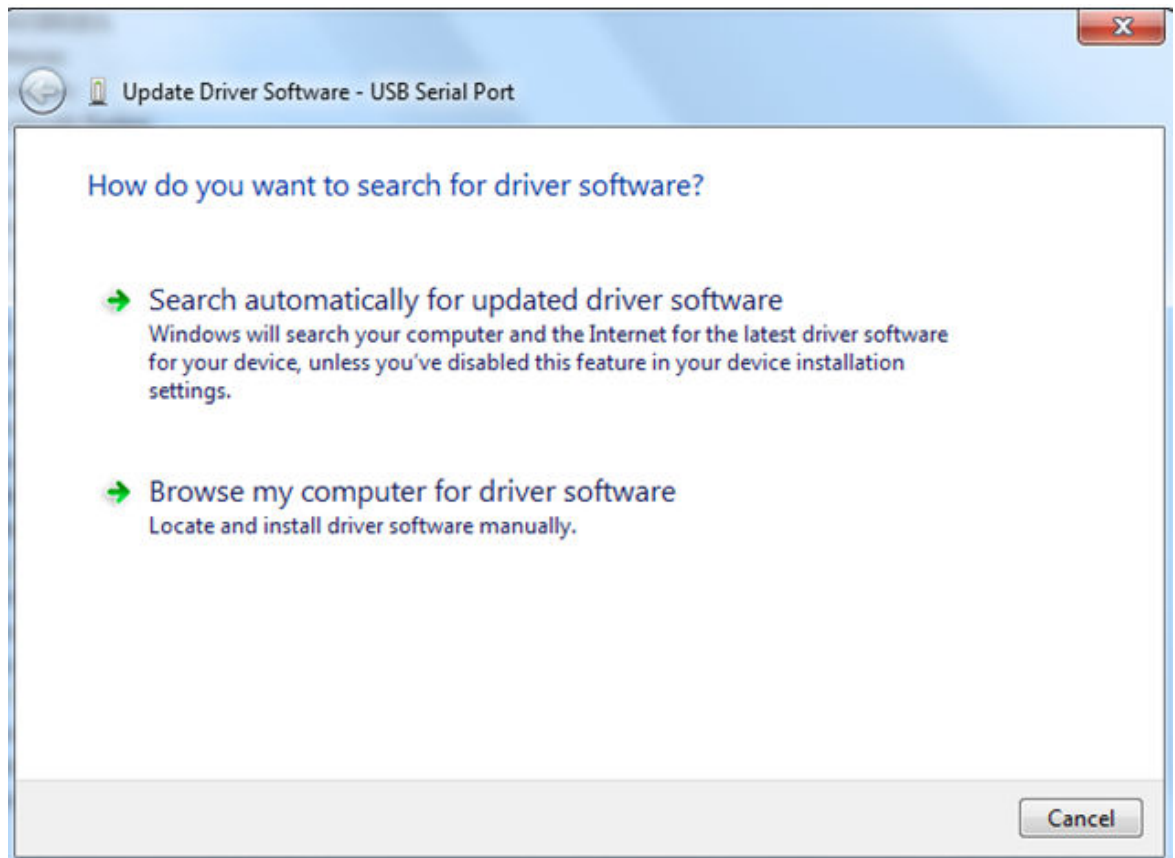

[sc_fsi_usbdri-srptbrowse, 1, -,-]

Figure 5-14 USB Serial Port Drivers – Locate Driver Software

- ✧ Click **Next** to start the driver software installation of USB Serial Port.

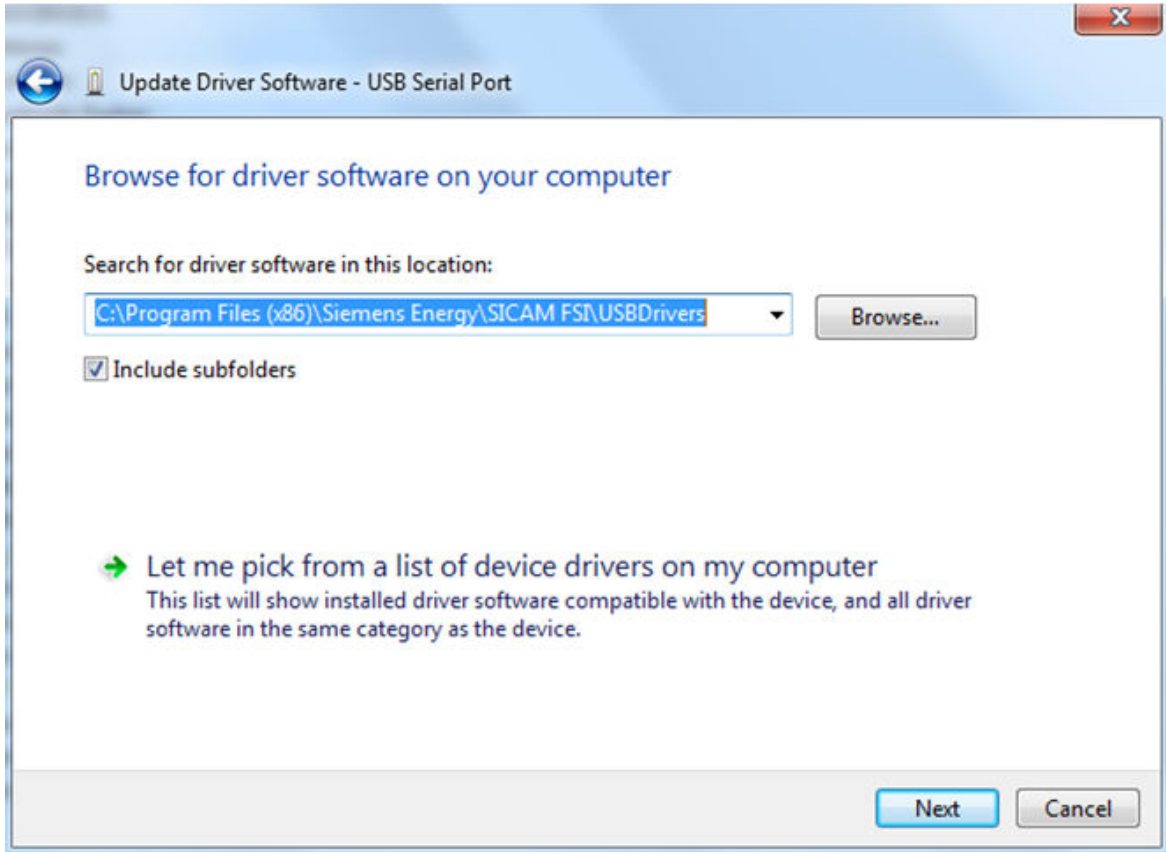

[sc_fsi_usbdrv_srptnext, 1, -,-]

Figure 5-15 USB Serial Port Drivers – Driver Software Installation

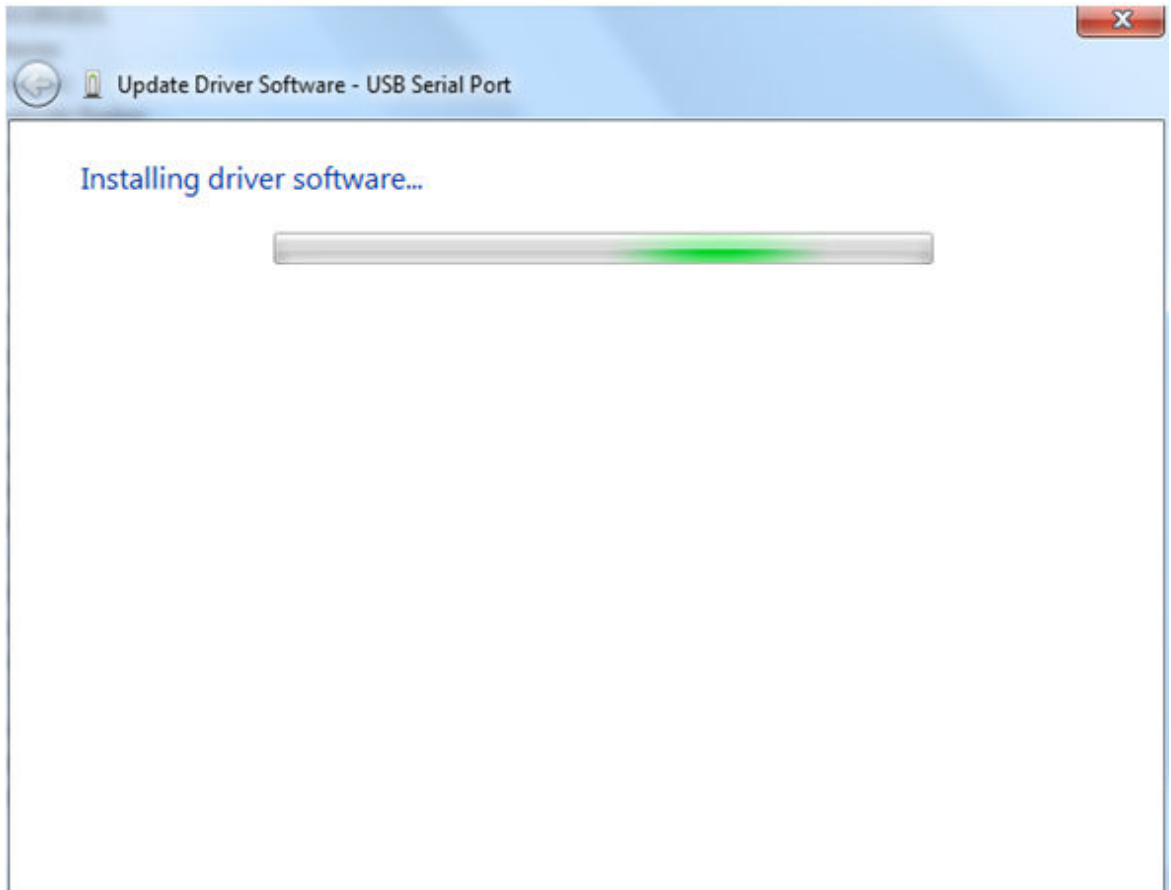

[sc_fsi_usbdri-srptinstprog, 1, --]

Figure 5-16 USB Serial Port Drivers – Installation In Progress

- ✧ Click **Close** once the driver software is successfully installed.

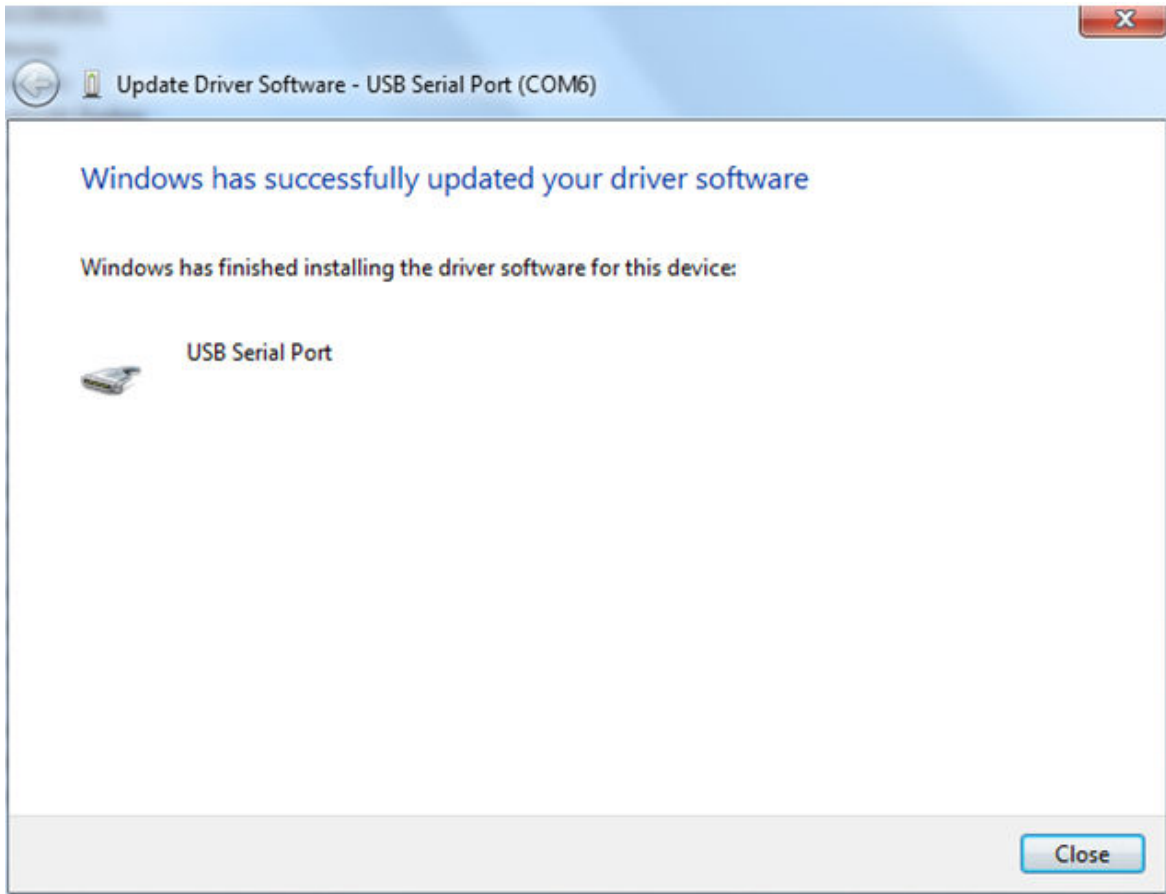

[sc_fsi_usbdri-srptsuccess, 1, --]

Figure 5-17 USB Serial Port Drivers – Installation Finished

- ✧ Once the SICAM FSI drivers are successfully installed, make sure that the USB Serial Port is visible in **Device Manager** → **Ports**.

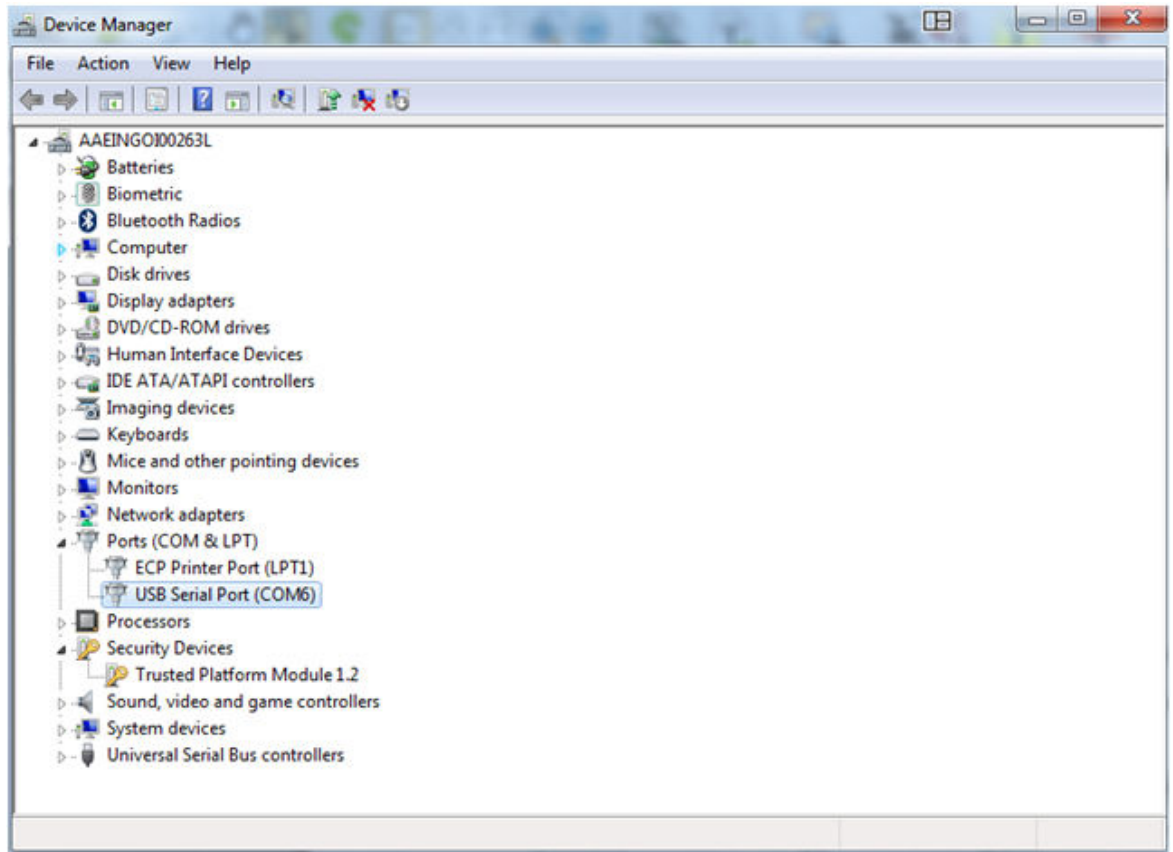

[sc_fsi_usbdri-LPT1-COM6, 1, -,-]

Figure 5-18 UART Cable Drivers – USB Serial Port

Launching the SICAM FSI Configurator

To launch the SICAM FSI Configurator after the installation, proceed as follows:

- ✧ Double-click the **SICAM FSI Configurator** icon from the desktop to open the SICAM FSI Configurator.



SICAM FSI

- or -

- ✧ Select the **Start Menu** → **All Programs** → **Siemens Energy** → **FSI Web Configurator**.

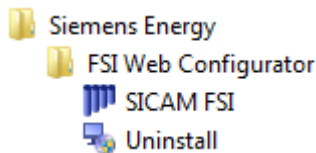





[sc_fsi_launchicon_20160411, 1, en_US]

5.4 Control Functions

Control Elements and Control Functions

The following table lists the control elements and control functions.

Table 5-1 Control Elements and Control Functions

Control Elements	Control Functions
	Home screen
	Backup device settings Reset to factory settings Restore device settings Update firmware Log off
	Write the settings to the device
	Read the settings from the device
	Display the device-log information

5.5 Starting the SICAM FSI Configurator User Interface

SICAM FSI Configurator supports the following Web browsers:

- Microsoft Internet Explorer 8.0 or higher
- Google Chrome 10.0 or higher
- Mozilla Firefox 45.0 or higher



NOTE

Siemens recommends using Google Chrome 10.0 or higher.

Before starting the SICAM FSI Configurator user interface, the following preconditions must be satisfied:

- Observe the ESD measures when connecting the SICAM FSI device.
For more information about SICAM FSI device ESD measures, refer to chapter [Preparing the Device for Mounting, Page 21](#).
- If the SICAM FSI is used for first time, complete the installation procedure.
For more information about installation procedures, refer to [3.2.1 SICAM FSI Installation](#).
- Magnetic reset of SICAM FSI is performed.
For more information about magnetic reset, refer to [3.2.1 SICAM FSI Installation](#).
- The connection between the SICAM FSI and the PC or laptop computer using UART is established.



NOTE

The serial port remains disabled until a magnetic reset is performed after which the serial port is enabled. This port remains enabled as long as there is communication. If there is no communication for 10 min, the port is auto-disabled to secure from spurious noises. To enable the serial port, reset the device again by magnet adaptor.

To start the SICAM FSI Configurator user interface, proceed as follows:

- ✧ Double-click the **SICAM FSI Configurator** icon from the desktop.
- ✧ Select the **Com port** from the list box.

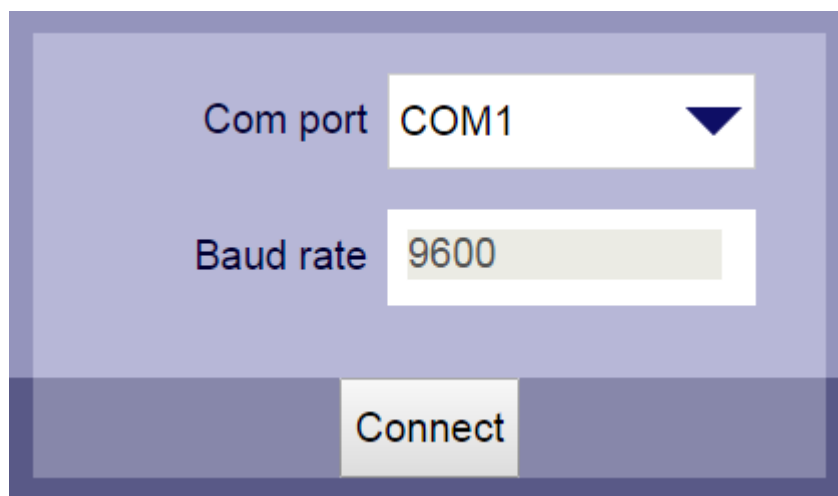

[sc_fsi_webconfigconnect_20160614_1_en_US]

Figure 5-19 Configurator Connection

- ✧ Click **Connect**.

The **Log-on to device** dialog appears.



The image shows a 'Log on to device' dialog box with a light blue background. At the top, the title 'Log on to device' is displayed in a bold, dark blue font. Below the title is an information icon (a lowercase 'i' in a circle) followed by the text 'Magnetic reset the FSI to access parameters'. The dialog contains two input fields: 'User name' with the value 'Engineer' and 'Language' with the value 'English'. At the bottom center, there is a circular button with a white checkmark on a blue background.

[sc_sfsi_configlogon, 1, --]

Figure 5-20 Log-on to Device Dialog

✧ Click **OK** to log on to the SICAM FSI Configurator.

The **Device Information** and **Settings** tiles page appears.

5.6 Dashboard

5.6.1 SICAM FSI Configurator Dashboard

Based on the selected COM port, you can connect and log on to the SICAM FSI Configurator. After successful log on, the **Dashboard** page appears and contains the following pages:

- Device Information
- Settings

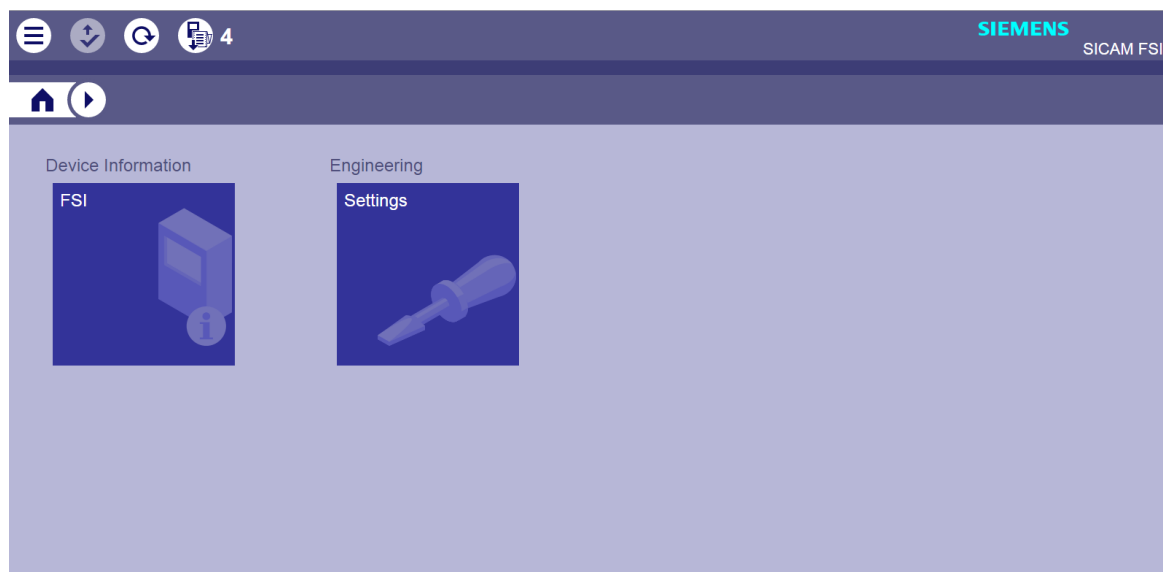

[sic_fsi_dashbrd_20160311_1_en_US]

Figure 5-21 SICAM FSI Configurator Dashboard

5.6.2 Device Information

The device information page displays the following:

- Device health state
- Battery state
- Boot-loader version number
- Firmware version number
- SICAM FSI Configurator (Application software version number)
- Wireless communication
 - NO — Non-communicable SICAM FSI (No Zigbee module)
 - YES — Communicable SICAM FSI (Zigbee module is available and wireless module setting is disabled)
 - DISABLED BY CONFIGURATION — Communicable SICAM FSI (Zigbee module is available and wireless module setting is enabled)
- WPAN module stack version
- WPAN module Boot-loader version
- WPAN module application version



NOTE

The device information parameters are read-only for the engineer role.

Click the **SICAM FSI** tile under **Device Information**.

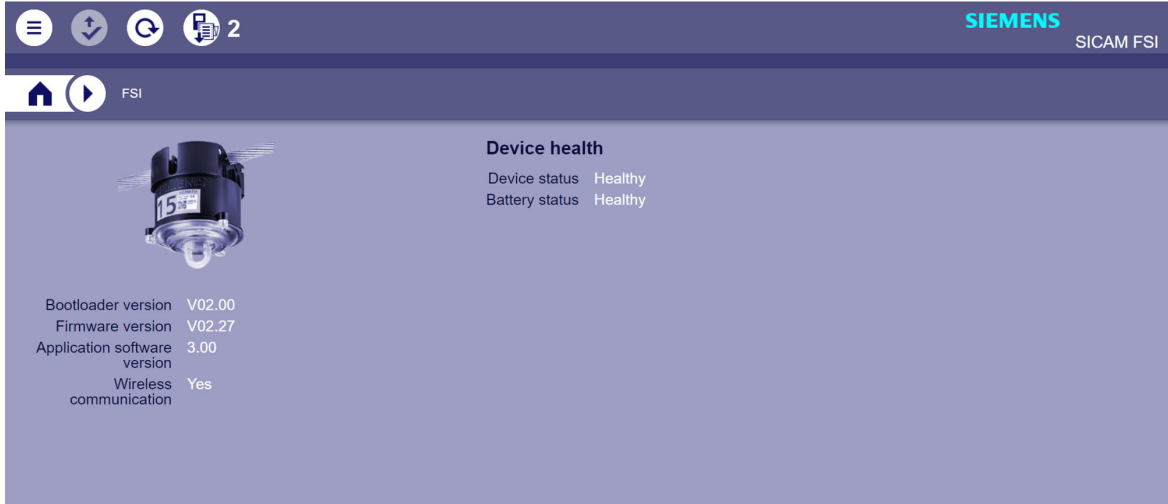

[sc_fsi_fsiconfighomeV2, 2, --]

Figure 5-22 Device Information (SICAM FSI - DD and EE Versions)



[sc_fsi_fsideviceinformation_ffgg, 1, en_US]

Figure 5-23 Device Information (SICAM FSI - FF and GG Versions)

5.6.3 Settings

The settings page displays the following parameters in a tree view structure:

- Basic parameters
- Advance parameters
- Device info parameters

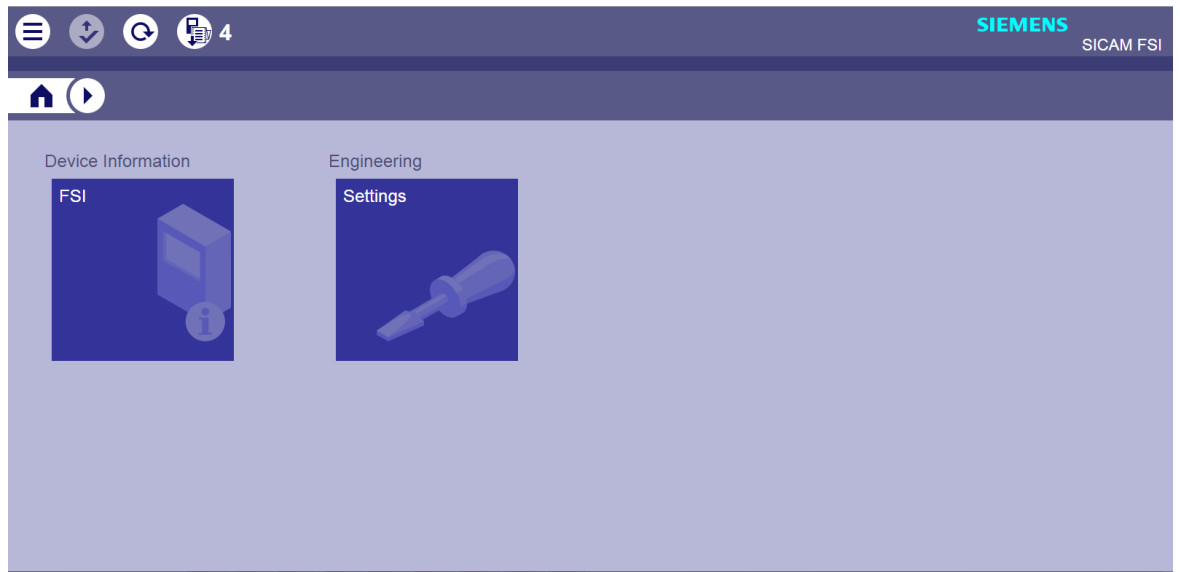

[sc_fsi_dashbrd_20160311, 1, en_US]

Figure 5-24 SICAM FSI Configurator - Settings (Engineering)

5.7 Basic Parameter Settings

SICAM FSI Configurator interface allows you to set the following basic parameters:

- Power frequency
- Rated voltage
- Rated current
- Current threshold
- DI current
- Fault-indication time
- Permanent-fault verification time
- Wireless reporting time

To set the basic parameters, proceed as follows:

- ✦ In the SICAM FSI dashboard, navigate to **Settings** → **Basic Parameters**.

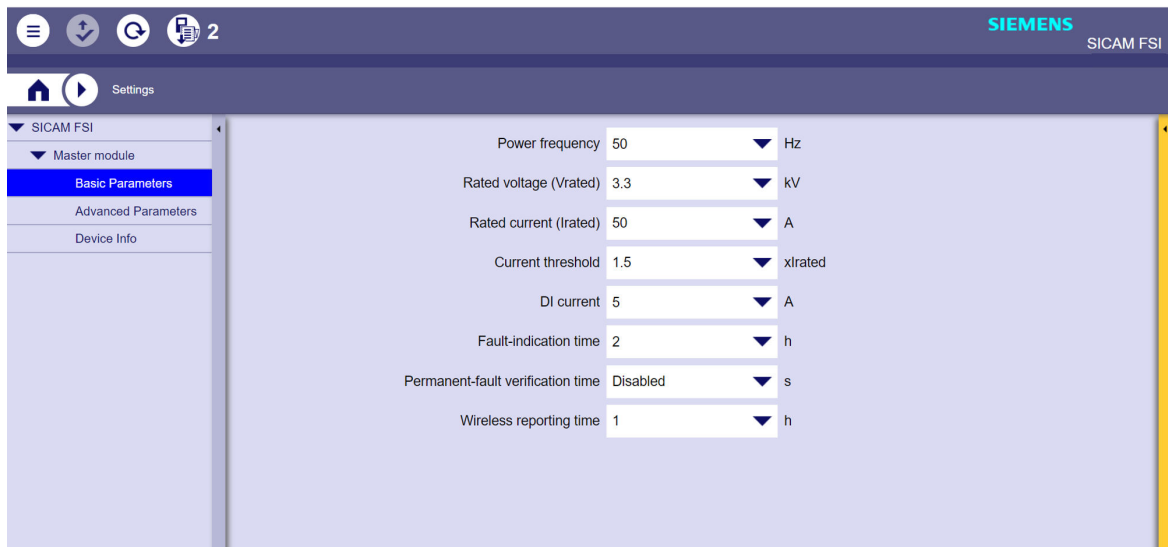

[sc_fsi_basiparam_20160107, 2, ---]

Figure 5-25 Basic Parameter Settings

- ✦ Select the power frequency from the **Power frequency** list box.
The frequency of the distribution network where SICAM FSI is installed. You can select the frequency as 50 Hz or 60 Hz.
- ✦ Select the rated voltage from the **Rated voltage (Vrated)** list box.
The rated voltage of the distribution network where SICAM FSI is installed. The rated voltage values are 3.3 kV, 6.6 kV, 11 kV, 22 kV, 33 kV, 44 kV and 66 kV.



NOTE

For ANSI voltage nominal ranges, you can select the nearest rated voltage. For example, for 69 kV ANSI voltage, please select 66 kV rated voltage.

- ✦ Select the rated current from the **Rated current (Irated)** list box.
The rated current of the distribution network where SICAM FSI is installed. The rated current is configurable from 50 A to 500 A (in steps of 50 A).

- ✧ Select the current threshold from the **Current threshold** list box.
The overcurrent fault is triggered when the current value exceeds the set current-threshold values. The current-threshold values are Disabled, 1.5, 2.0, 2.5, and 3.0 times of the rated current. If the current threshold value is **Disabled**, then the overcurrent protection is disabled.
- ✧ Select the di current from the **DI current** list box.
If the rate of change of current (di/dt) is more than the set value, the ground fault is triggered. The di current is settable as Disabled, 5 A to 80 A (in steps of 5 A), 120 A, and 160 A. If the di current is **Disabled**, then the ground-fault detection is disabled.
- ✧ Select the fault-indication time from the **Fault-indication time** list box.
The time range for which the fault indication is displayed. The fault-indication time is settable from 2 h to 16 h (in steps of 0.5 h).
- ✧ Select the permanent-fault verification time from the **Permanent-fault verification time** list box.
The time range required to confirm that the temporary fault detected is permanent fault. The permanent-fault verification time is settable as Disabled, 3 s, 35 s, and 70 s.
- ✧ Select the wireless reporting time from the **Wireless reporting time** list box.
The time range between the 2 periodic data updates from SICAM FSI to SICAM FCG via short-range radio (wireless) communication. The short-range radio (wireless) time is settable as 1 h, 2 h, 6 h, 12 h, and 24 h.

Information Section

The information section provides you more information about the parameters and the settings range when you are configuring the parameters.

To find more information about the parameters, proceed as follows:

- ✧ Click the arrow sign ◀ on the yellow bar.

5.8 Advanced Parameter Settings

SICAM FSI Configurator user interface allows you to set the following advanced device parameters:

- Inrush restraint time
- Cable type and diameter
- Phase fault
- di fault indication
- Battery-low indication
- Voltage restoration reset
- Expiry of fault-indication time
- Wireless command reset
- Wireless module

To set the advanced parameters, proceed as follows:

- ✦ In the SICAM FSI dashboard, navigate to **Engineering** → **Settings** → **Advanced Parameters**.

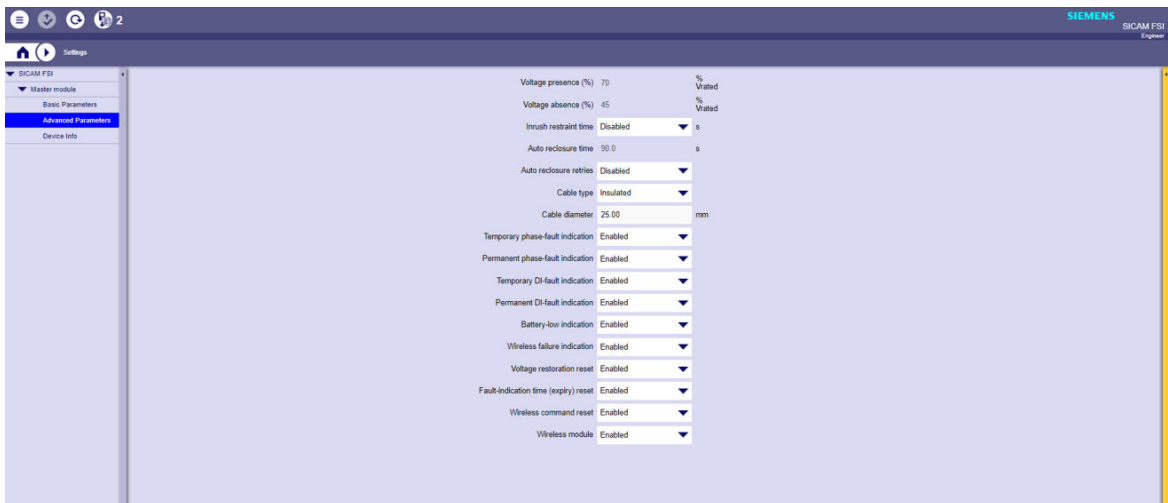

[sc_fsi_advparamV202, 3, --]

Figure 5-26 Advanced Parameter Settings (SICAM FSI - FF and GG Versions)

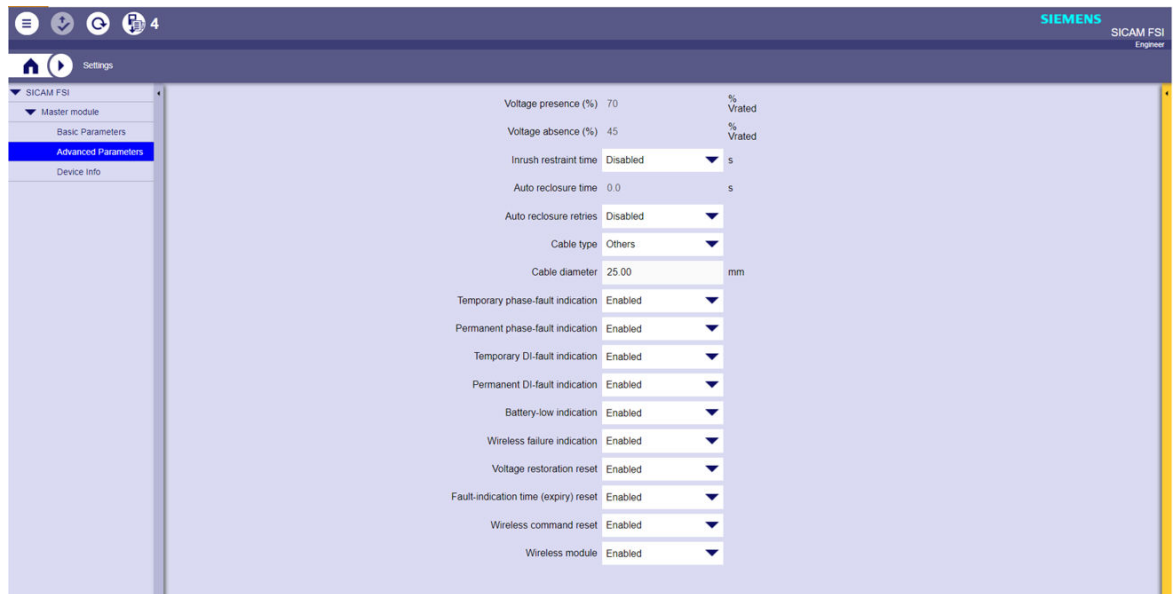

[sc_fsi_advparamV2, 3, -_-]

Figure 5-27 Advanced Parameter Settings (SICAM FSI - EE Version)

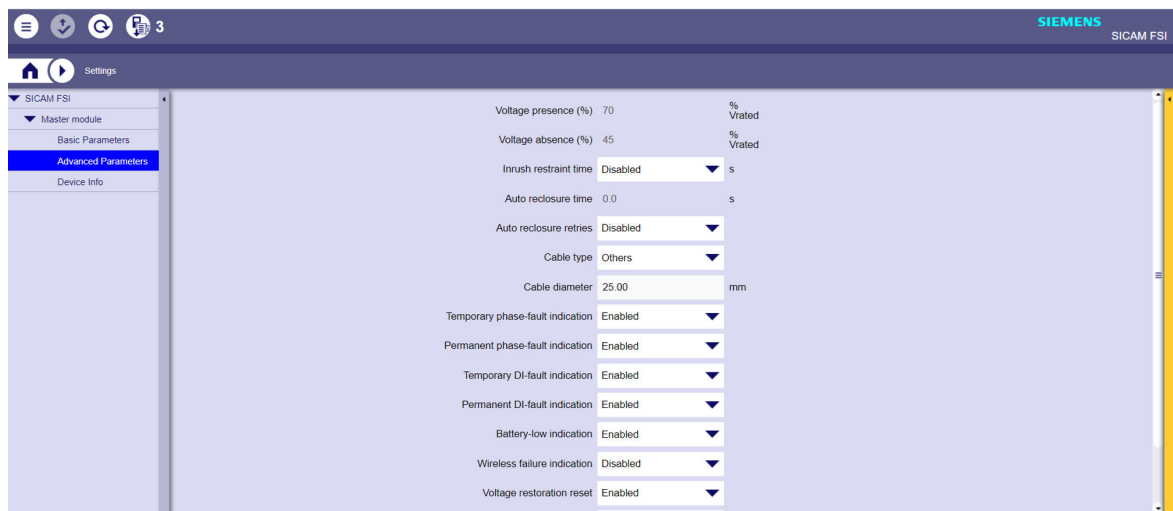

[sc_fsi_advparamV2, 2, -_-]

Figure 5-28 Advanced Parameter Settings (SICAM FSI - DD Version)

- ✧ **Voltage presence (%)** The 70 % of Vrated voltage is termed as voltage presence.
- ✧ **Voltage absence (%)** The 45 % of Vrated voltage is termed as voltage absence.
- ✧ Select the inrush restraint time from the **Inrush restraint time** list box.
SICAM FSI blocks the fault detection for the configured inrush restraint time due to the transformer magnetization during the voltage restoration on the MV overhead line.
The inrush restraint time can be configured as Disabled, 3 s, 30 s, and 60 s.
- ✧ The **Auto reclosure time** can be configred from 0.1 s to 99.9 s.
During the auto-reclosure time the conversion of temporary fault to permanent fault occurs only when auto reclosure time expires and voltage absence is detected.
- ✧ Select the auto-reclosure retries from the **Auto reclosure retries** list box.
The number of retries for the auto reclosure.

✧ **For SICAM FSI - FF and GG Versions**

The default cable type is Non insulated and default cable diameter is 15 mm.

Select cable type (non-insulated/insulated) from list box and manually enter cable diameter.

Refer to [B.1 Aluminum Conductor Steel Reinforced \(ACSR\) Cable Type and Diameter](#) for details on cable type and diameter.

✧ **For SICAM FSI - DD and EE Versions**

Select the cable type from the **Cable type** list box.

The type of cable on which the SICAM FSI is mounted. The following Aluminum Conductor Steel Reinforced (ACSR) cable types are listed in the SICAM FSI Configurator:

ROSE (5.8 mm)

SQUIRREL (6.33 mm)

WEASEL (7.77 mm)

RABBIT (10 mm)

RACOON (12.2 mm)

DOG (14.15 mm)

WOLF (18 mm)

PANTHER (21 mm)

Others

– If the device is mounted on another type of cable, select the cable type as **Others**. For example if the type of cable is GROSBEAK, then enter the cable diameter 25.15 mm manually.

– Select the cable type from the **Cable type** list box. The cable diameter field is auto populated except for cable type as **Others**. If the selected cable type is **Others**, enter the cable diameter from ≥ 5 mm to ≤ 25 mm.

✧ Select the temporary phase-fault indication from the **Temporary phase-fault indication** list box.

To indicate the temporary phase fault, select the **Enabled** option from the list box. If the temporary phase fault is **Disabled**, the temporary phase fault is not indicated.

In the SICAM FSI with integrated communication, the fault is communicated via short-range radio (wireless) and the communication is not dependent of the temporary phase-fault indication setting.

✧ Select the permanent phase-fault indication from the **Permanent phase-fault indication** list box.

To indicate the permanent phase fault, select the **Enabled** option from the list box. If the permanent phase fault is **Disabled**, the permanent phase fault is not indicated.

In the SICAM FSI with integrated communication, the fault is communicated via short-range radio (wireless) and the communication is not dependent of the permanent phase-fault setting.

✧ Select the temporary DI-fault indication from the **Temporary DI-fault indication** list box.

To indicate the temporary di fault, select the **Enabled** option from the list box. If the temporary di fault indication is **Disabled**, the temporary di fault is not indicated.

In the SICAM FSI with integrated communication, the fault is communicated via short-range radio (wireless) and the communication is not dependent of the temporary di fault setting.

✧ Select the permanent DI-fault indication from the **Permanent DI-fault indication** list box.

To indicate the permanent di fault, select the **Enabled** option from the list box. If the permanent di fault is **Disabled**, the permanent di fault is not indicated.

In the SICAM FSI with integrated communication, the fault is communicated via short-range radio (wireless) and the communication is not dependent of the permanent di fault setting.

- ✧ Select the battery-low indication from the **Battery-low indication** list box.
To indicate the battery low-indication, select the **Enabled** option from the list box. Select the **No** option from the list box, if the battery low-indication display is not required.
In the SICAM FSI with integrated communication, the battery-low status is communicated via short-range radio (wireless) and the communication is not dependent on the battery-low setting.
The battery-low indication is displayed when the battery voltage level falls below 3.08 V. Siemens recommends replacing the battery with a new one within 1 month after appearance of the low-battery indication.
- ✧ Select the wireless failure indication from the **Wireless failure indication** list box.
To indicate the failure of the SICAM FSI with integrated communication short-range radio (wireless) communication module, select the **Enabled** option from the list box. If the wireless failure indication is **Disabled**, the failure of the SICAM FSI short-range radio (wireless) communication module is not indicated.
- ✧ Select the voltage restoration reset from the **Voltage restoration reset** list box.
The fault is cleared when the voltage is restored to the voltage presence level.
To indicate the voltage restoration reset, select the **Enabled** option from the list box. If the voltage restoration reset is **Disabled**, the fault indication continues and it is independent of the voltage level.
- ✧ Select the fault-indication time (expiry) from the **Fault-indication time (expiry)** list box.
Select the **Enabled** option to clear the fault once the fault-indication time is expired. If the fault-indication time (expiry) is **Disabled**, the fault indication continues until the device resets after 16 hours (maximum fault-indication time) or if the reset is performed by any one of the other reset method.
For more information about fault resets, refer to [4.1.4 Fault Resets](#)
- ✧ Select the wireless command reset from the **Wireless command reset** list box.
If the wireless command reset option is **Enabled**, the fault can be cleared by sending the command over the short-range radio (wireless) communication. If the wireless command reset is **Disabled**, the fault cannot be cleared over the short-range radio (wireless) communication.
- ✧ Select the wireless module from the **Wireless module** list box.
If the wireless module option is **Disabled**, SICAM FSI disables its Zigbee module and stops communication with SICAM FCG working similar to a non-communicable SICAM FSI. If the wireless module option is **Enabled**, SICAM FSI enables the Zigbee module allowing the possibility to pair with SICAM FCG and communicate at configured wireless interval time or during an event.
- ✧ Click **Write the settings to the device** control element.
The updated setting parameters are applied to the SICAM FSI device and displayed in the log information.



NOTE

The settings Wireless failure indication, Wireless command reset and Wireless module are only applicable for SICAM FSI with integrated communication (MLFB: 6MD2314 - 1Ax11). These settings are not applicable for standalone SICAM FSI (MLFB: 6MD2314 - 1Ax10).

5.9 Device Info

The device information page displays the following information:

- Year of manufacturing
- MLFB
- Serial number
- Device ID
- Hardware version

✧ In the SICAM FSI dashboard, navigate to **Settings** → **Device Info**.

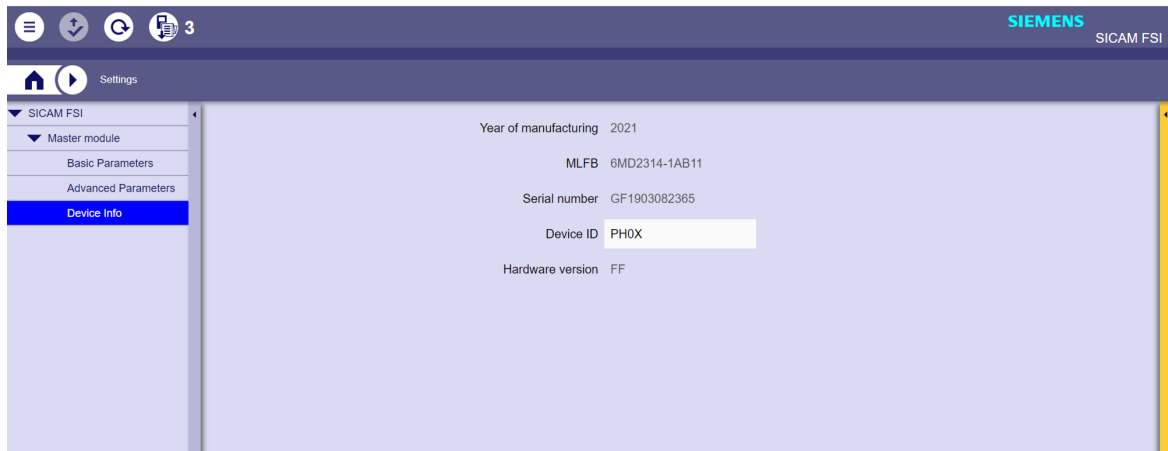

[sc_fsi_deviceinfoset_20210712_1_en_US]

Figure 5-29 SICAM FSI Device Info

5.10 Device Settings

5.10.1 Reset to Factory Settings

Reset to factory settings allows you to reset the device to the factory settings.

To reset the device to factory settings, proceed as follows:

- ✦ In the SICAM FSI Configurator dashboard, click the **Open** menu and select **Reset to factory settings...**

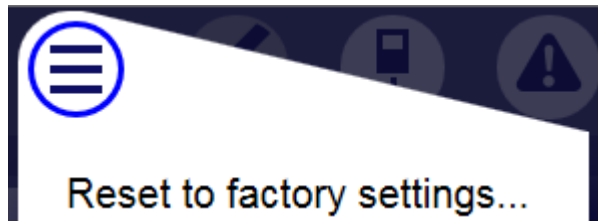

[sc_fsi_resetfactset_20151119, 1, ---]

Figure 5-30 Reset to Factory Settings

The **Reset to factory settings** dialog appears.



[sc_fsi_resetfactsetmsg_20160107, 1, ---]

Figure 5-31 Reset to Factory Settings Dialog

- ✦ Click **OK** to reset the device to factory settings.

5.10.2 Backup Device Settings

Backup device settings allows you to save the configured device settings in the PC or laptop computer.

Siemens recommends creating a backup of the device settings at regular intervals. The backup settings can be used to view configuration data via SICAM FSI Configurator and restore the device settings.

To create a backup of the device settings, proceed as follows:

- ✦ In the SICAM FSI Configurator dashboard, click the **Open** menu and select **Backup device settings...**



[sc_fsi_backupdeviceset_20151119, 1, ---]

Figure 5-32 Backup Device Settings

The **Backup device settings** dialog appears.

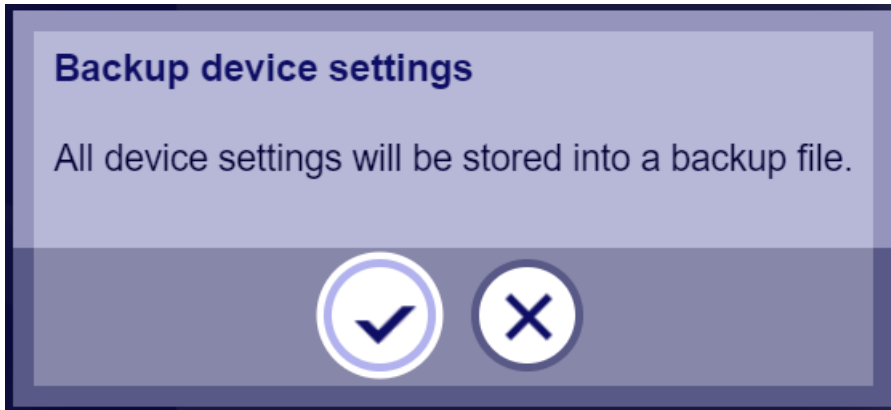

[sc_fsi_backupdevicesetok_20160107, 2, --]

Figure 5-33 Backup Device Settings Dialog

- Click ✓ to download the the backup device settings file as shown below to the following folder:
C:\ProgramData\Siemens Energy\FSI_Configurator\FSIBackUpSettings



[sc_fsi_downloadbackupfile_1_en_US]

Figure 5-34 Backup File - Download Complete

5.10.3 Restore Device Settings

Restore device settings allows the device to restore the device settings from the saved backup file.

To restore the device settings, proceed as follows:

- In the SICAM FSI dashboard, click the **Open** menu and select **Restore device settings....**



[sc_fsi_resetdeviceset_20151119, 1, --]

Figure 5-35 Restore Device Settings

- ✧ The **Restore device settings** dialog appears.

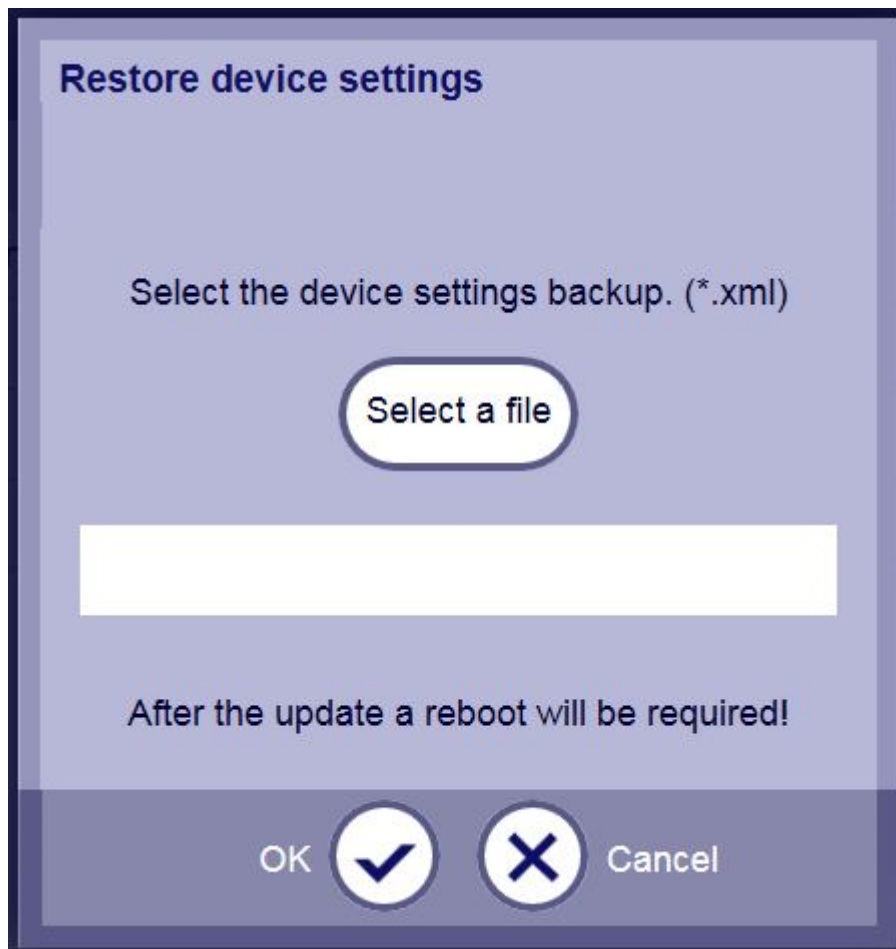

[sc_fsi_restoredeviceset_20160107, 1, --]

Figure 5-36 Restore Device Settings Dialog

- ✧ Click **Select a file**.
- ✧ Select the valid device settings backup (*.xml) file, for example, **SetupConfig.xml**.

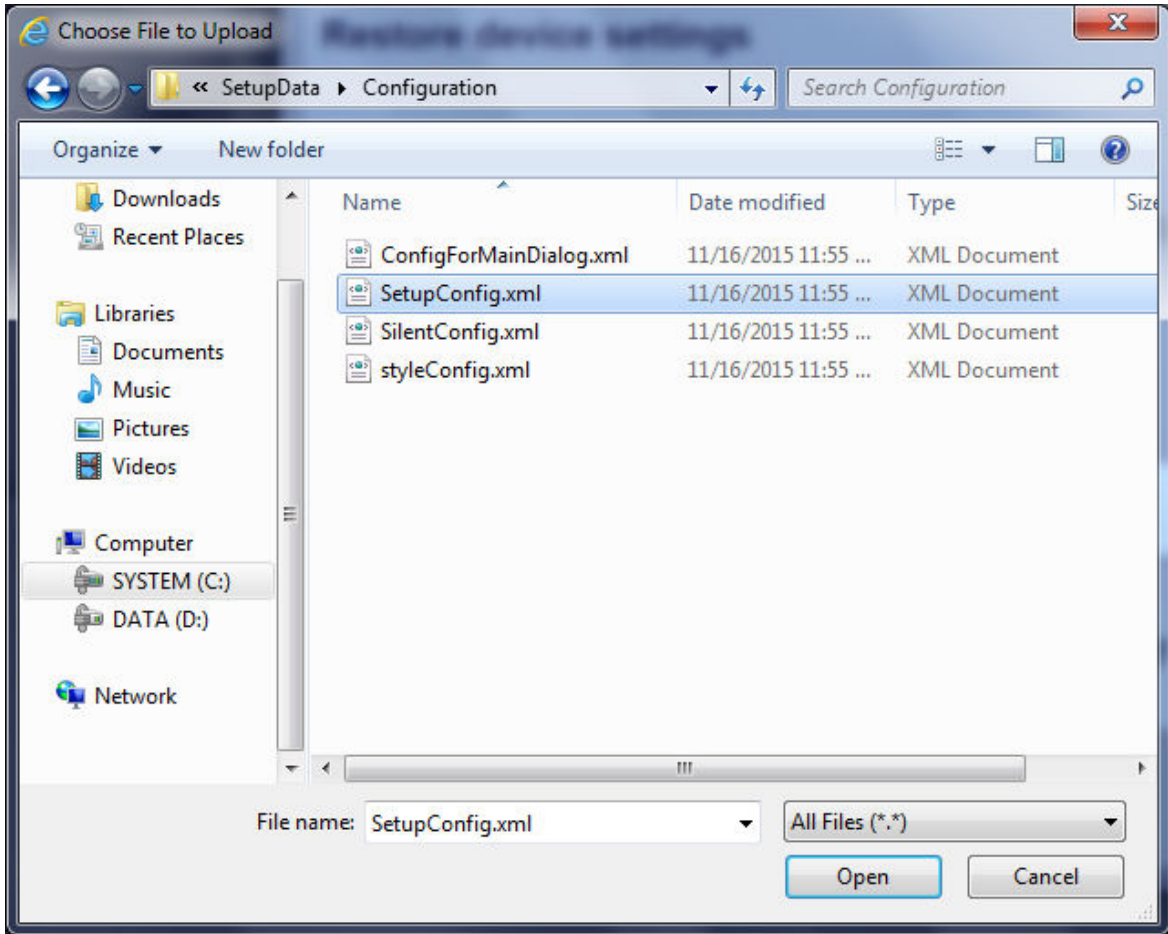

[sc_fsi_restoredevicesetselectfile_20151119, 1, -_-]

Figure 5-37 Valid Backup-File Selection

❖ Click **Open**.

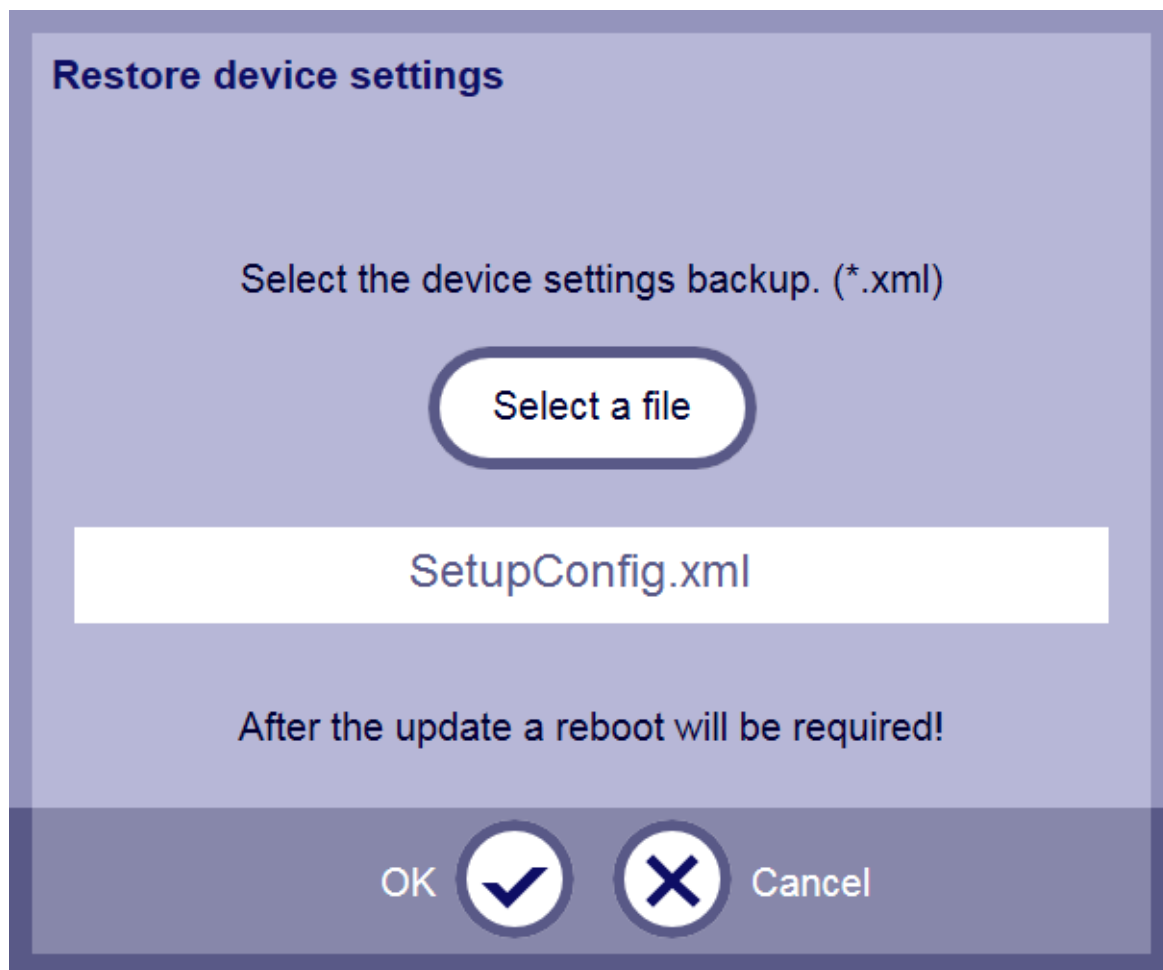

[sc_fsi_restoredeviceset_20160411_1_en_US]

Figure 5-38 Restore Device Settings Backup File

✧ Click **OK**.

The device settings are restored from the selected file and the message **Finished successfully. A log-on is required!** appears.

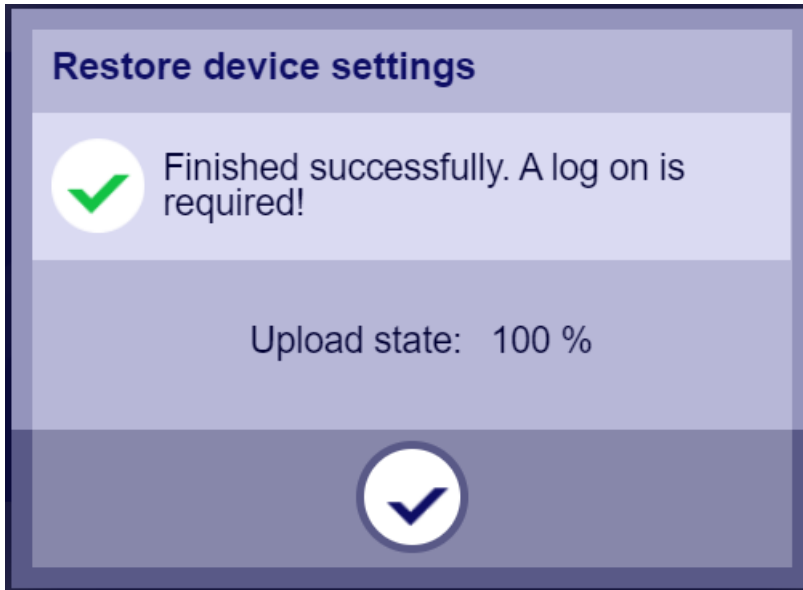

[sc_fsi_restdevsucc_20160411, 2, en_US]

Figure 5-39 Device Settings Restored Successfully

- ✧ Click **Close**.
The **Log-on to device** dialog appears.

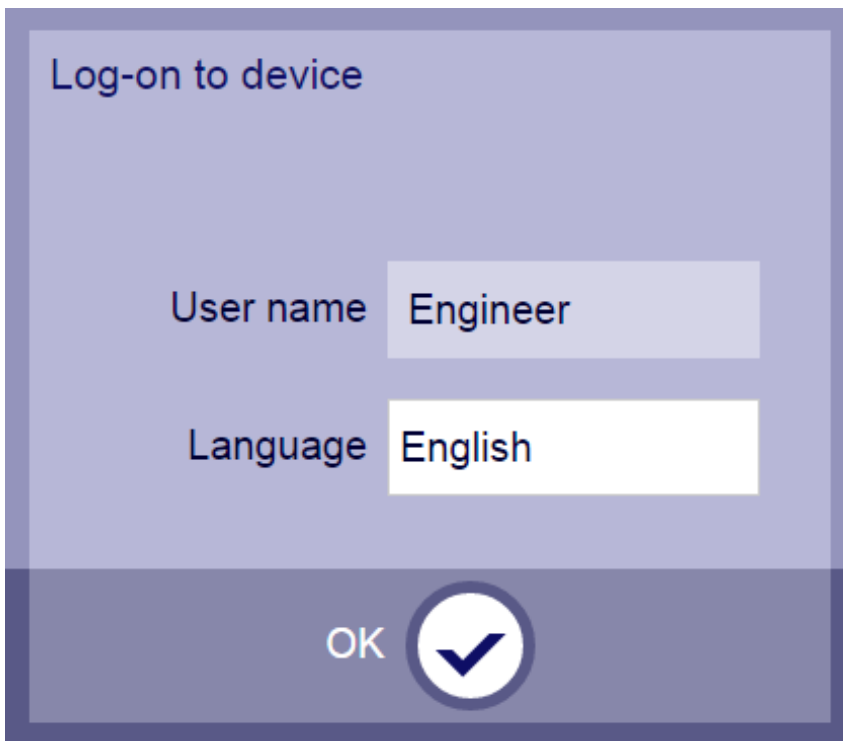

[sc_fsi_logon_20160614, 1, en_US]

Figure 5-40 Log-on to Device Dialog

5.10.4 Updating Firmware

You can download and update the latest firmware to the SICAM FSI device.

Before updating the SICAM FSI firmware (for example, FSI_V01.00.fw) on the PC or laptop computer, download the SICAM FSI firmware. Contact local Siemens office or contact customer support for latest SICAM FSI firmware.

To update the firmware, proceed as follows:

- ✧ In the SICAM FSI dashboard, click the **Open** menu and select **Update firmware....**



[sc_fsi_updatefirmware_20160411, 1, en_US]

Figure 5-41 Update Firmware

The **Update firmware** dialog appears.



[sc_fsi_updatefirmware_20160107, 1, en_US]

Figure 5-42 Firmware File Update Dialog

- ✧ Click **Select a file**.
The **Choose File to Upload** dialog appears.

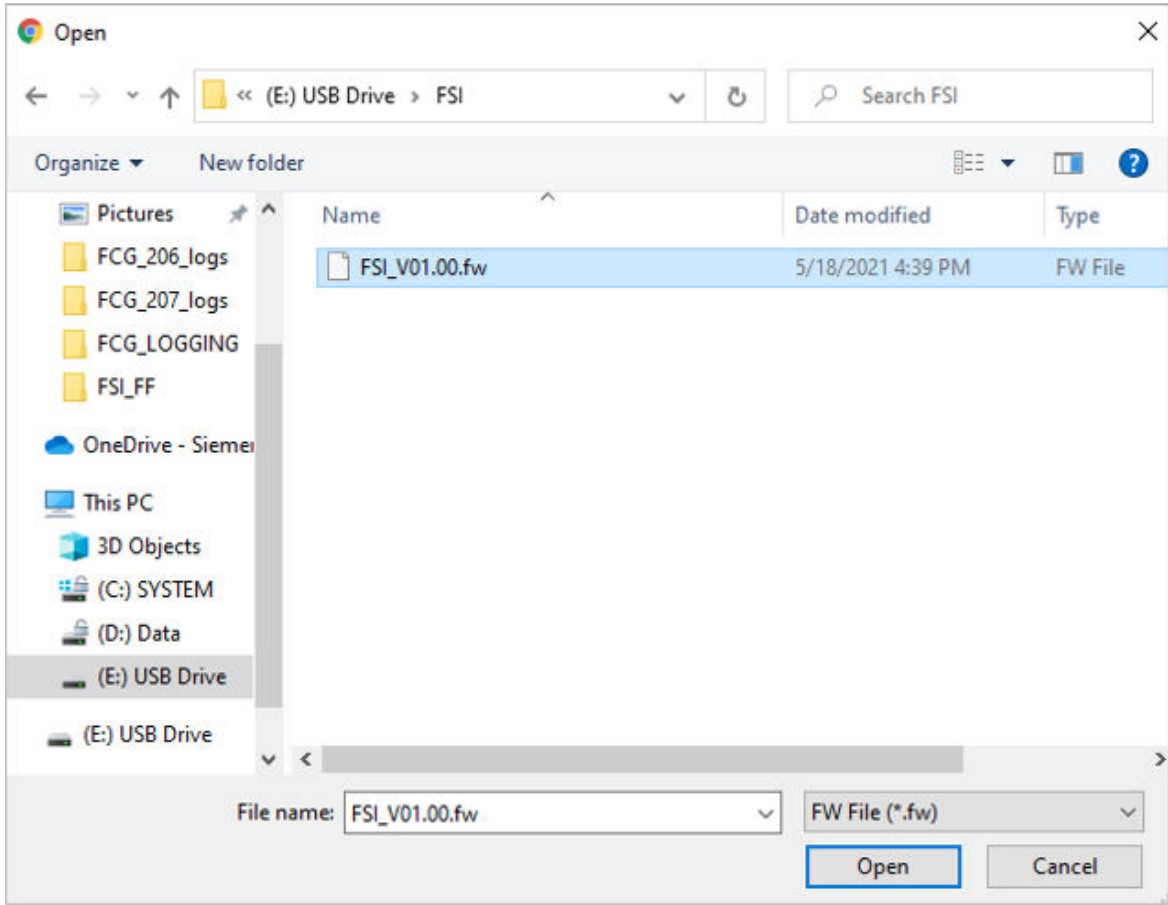

[sc_fsi_updatefwselectfile, 1, en_US]

Figure 5-43 Choose File to Upload Dialog

- ✧ Select the valid firmware file, for example, **FSI_V01.00.fw**.
- ✧ Click **Open**.



[sc_fsi_updatefirmware_20160107, 1, en_US]

Figure 5-44 Firmware File Update Dialog

- ✧ Click **OK**.

The **Update firmware** dialog appears.

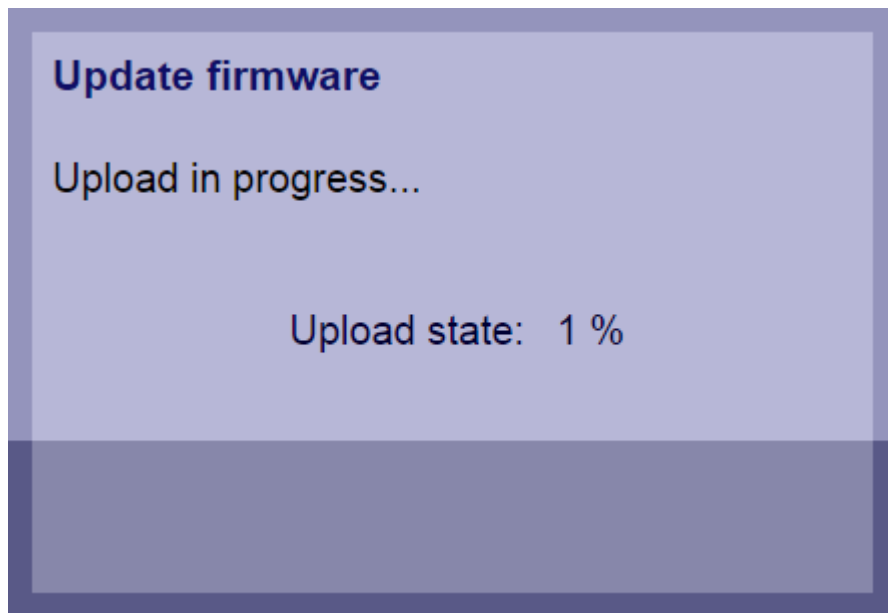

[sc_fsi_updatefirmprog_20160411, 1, en_US]

Figure 5-45 Firmware Upload in Progress

✧ After successful firmware update, the message **Finished successfully. A log-on is required!** appears.

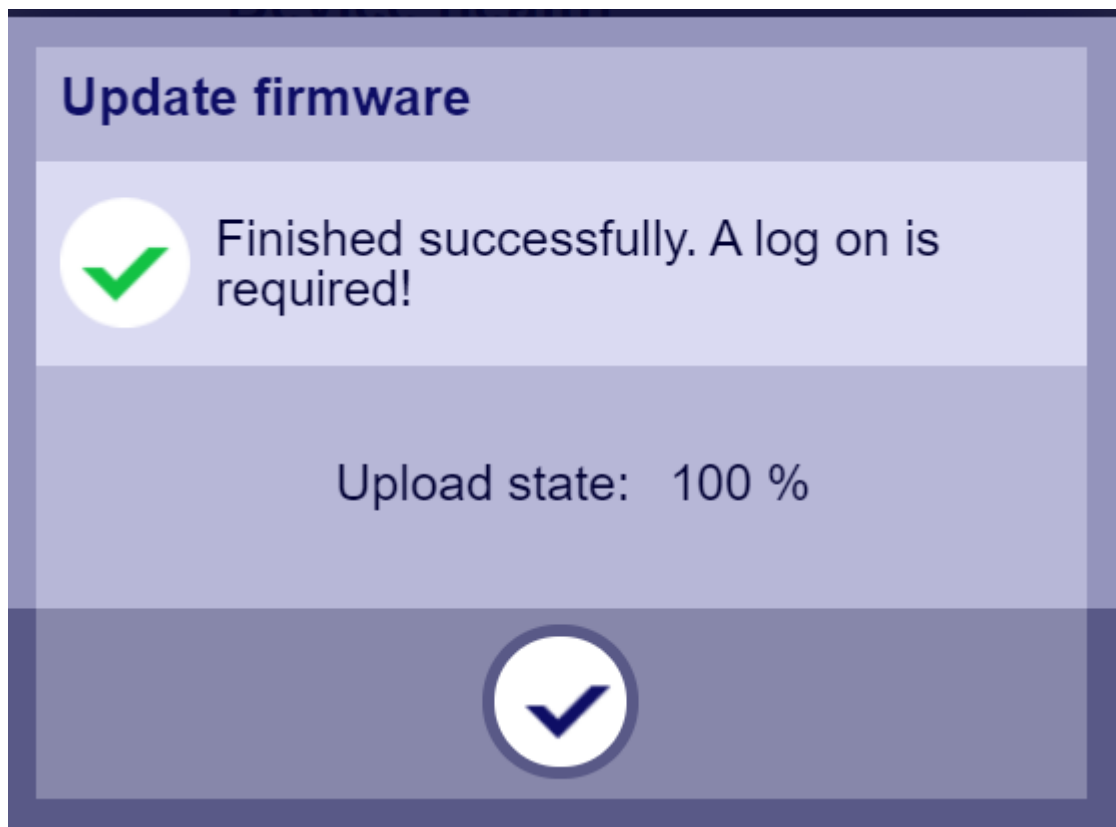

[sc_fsi_updfirmsucc, 2, --]

Figure 5-46 Firmware File Update Successful

✧ Click **Close**.

After the successful firmware download, the device resets.

5.11 Log off

Log off allows you to end the user session of the SICAM FSI Configurator.

To log off from the SICAM FSI Configurator, proceed as follows:

- ✧ In the SICAM FSI Configurator dashboard, click the **Open** menu and select **Log off** to disconnect from the SICAM FSI Configurator and return to the log on screen.

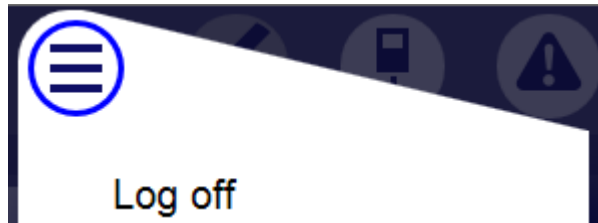

[sc_fsi_logoff_20151119, 1, --]

Figure 5-47 Log off

5.12 SICAM FSI Configurator Uninstallation

You can 2 possibilities to uninstall the SICAM FSI Configurator in one of the following possibilities:

- Uninstallation via the control panel
- Uninstallation via the start menu

Uninstallation via the Control Panel

To uninstall the SICAM FSI Configurator via the control panel, proceed as follows:

- ✦ To open the control panel, click **Start** → **Control Panel** → **Programs and Features**.

The **Programs and Features** window is displayed

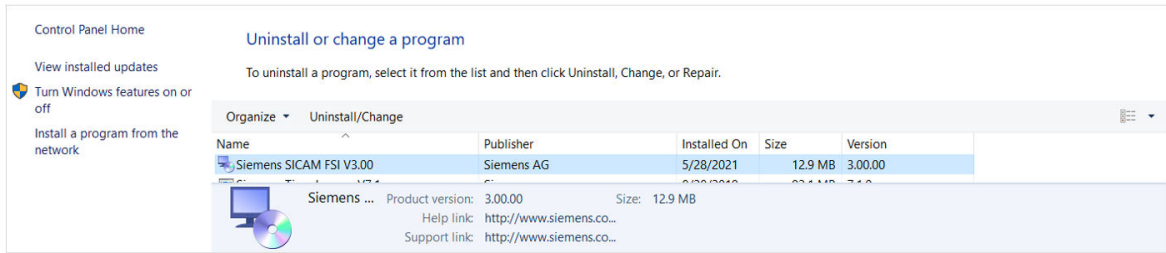

[sc_fsi_proguninstv2, 2, -_-]

Figure 5-48 Uninstalling Program

- ✦ Right-click **Siemens SICAM FSI** and select the **Uninstall** option from the context menu.

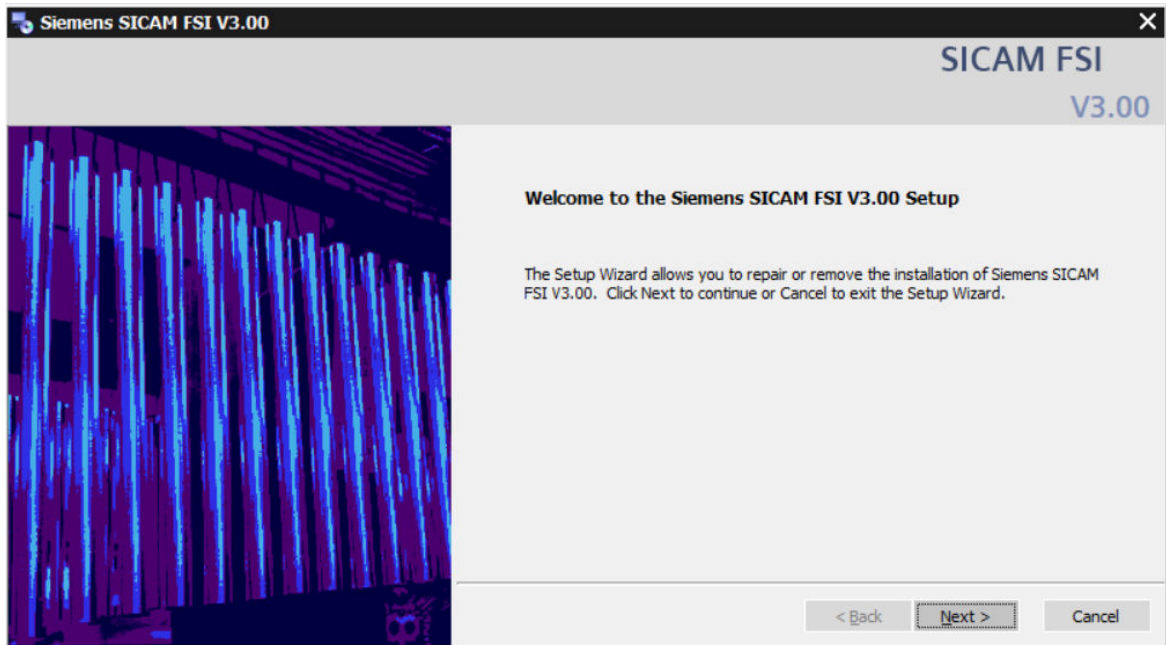

[sc_fsi_configremovv2, 2, -_-]

Figure 5-49 SICAM FSI Configurator – Setup Uninstallation

- ✦ Click **Next >**.
- ✦ Select the **Remove** option to start the uninstallation process.

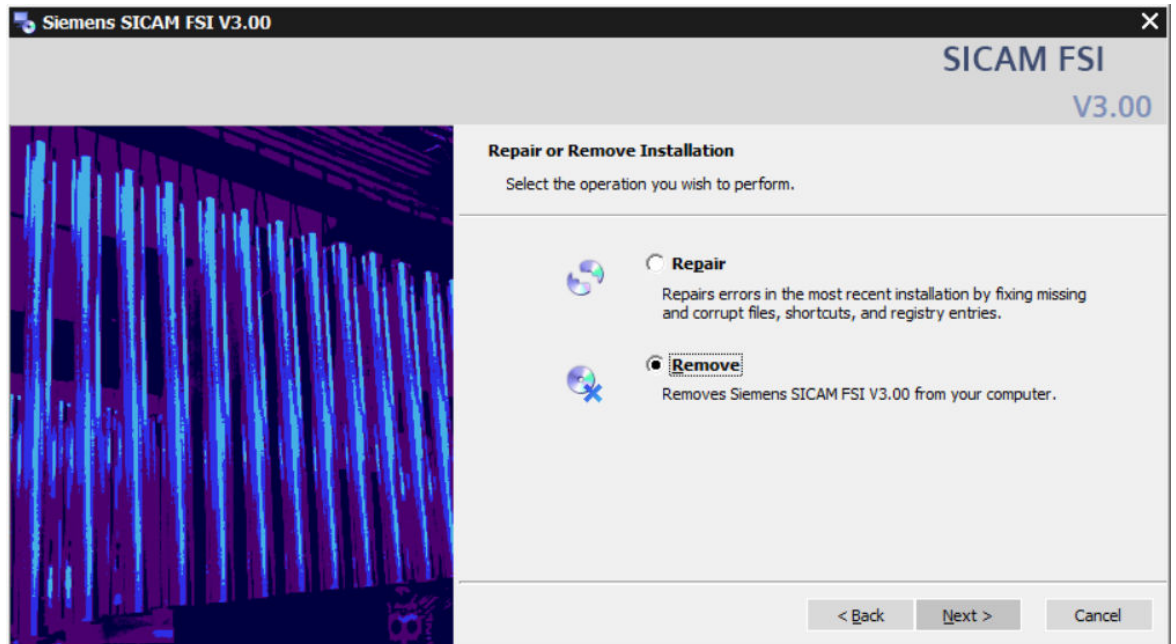

[sc_fsi_removectrlpnlv2, 2, --]

Figure 5-50 SICAM FSI Configurator – Remove Installation

✧ Click **Next >**.

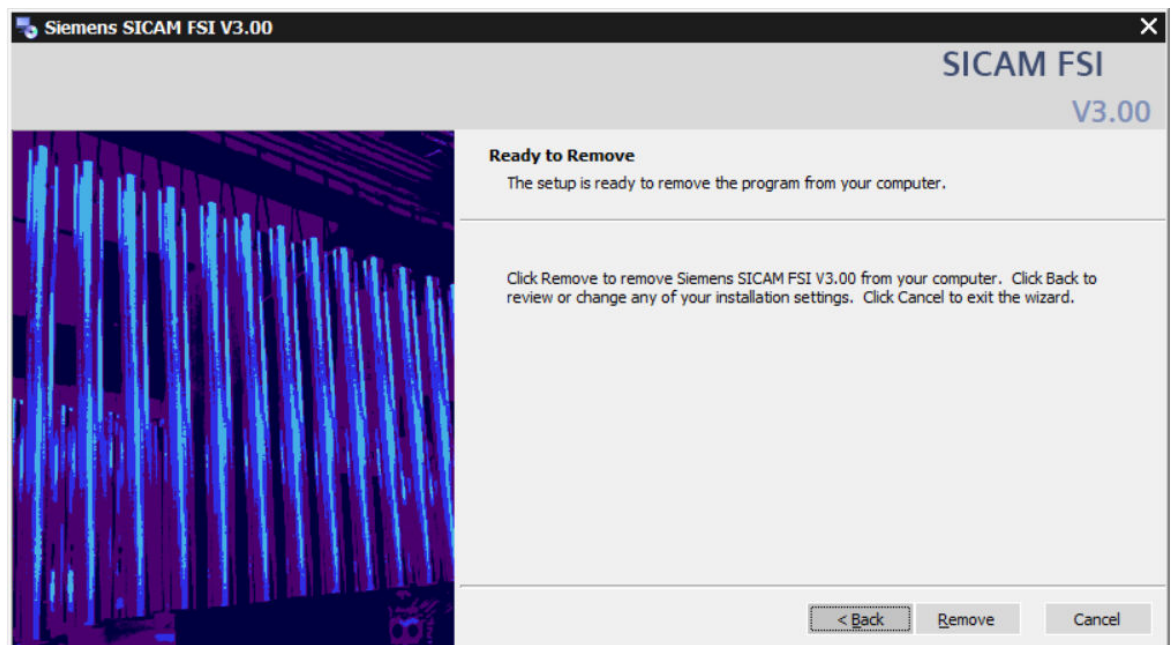

[sc_fsi_remcmpntsv2, 2, --]

Figure 5-51 SICAM FSI Configurator – Setup Ready to Remove

- ✧ Click **Remove** to start the uninstallation process.
The SICAM FSI Configurator program is removed from your computer. This process can take several minutes.
- ✧ Click **Finish** to complete the **Siemens SICAM FSI Configurator** uninstallation.

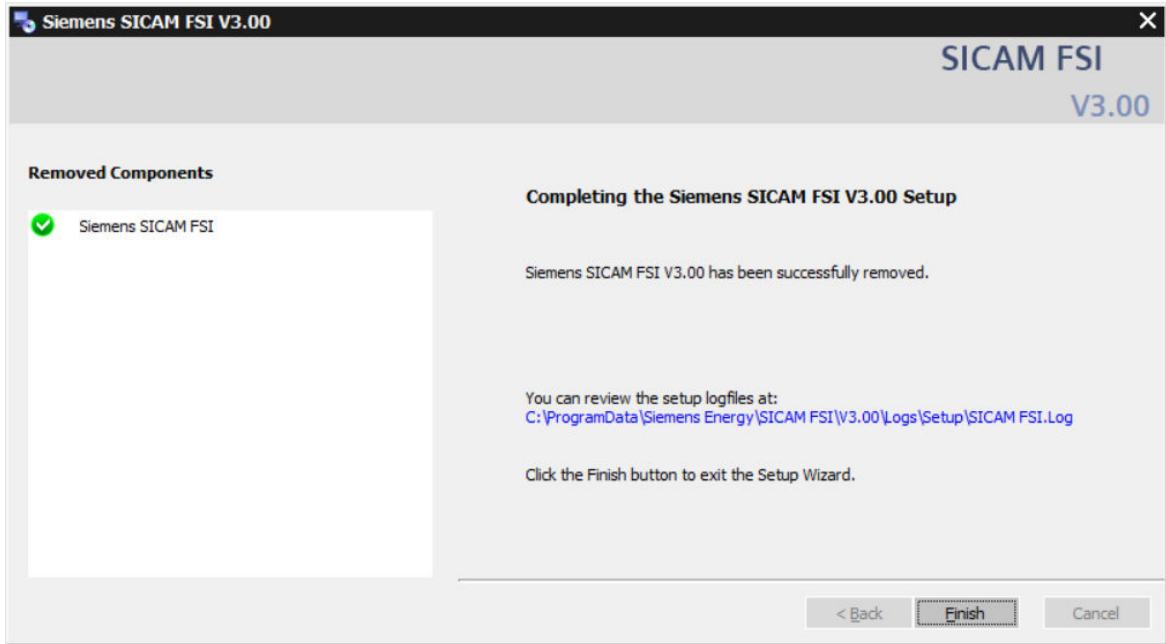

[sc_fsi_uninstfshv2, 2, --]

Figure 5-52 SICAM FSI Configurator – Setup Uninstallation Finished

Uninstallation via the Start Menu

To uninstall the SICAM FSI Configurator via the start menu, proceed as follows:

- ✧ Select the **Start Menu** → **All Programs** → **Siemens Energy** → **FSI Web Configurator** → **Uninstall**.

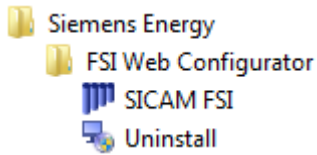

[sc_fsi_configuninstall, 1, --]

Figure 5-53 SICAM FSI Configurator – Uninstallation from Start Menu

6 Technical Data

Application Data

Rated voltage (V_{rated})	3.3 kV, 6.6 kV, 11 kV, 22 kV, 33 kV, 44 kV ⁵ , 66 kV (non-insulated cable) 6.6 kV, 11 kV, 22 kV, 33 kV, 44 kV ⁵ , 66 kV (insulated cable) NOTE: For ANSI voltage nominal ranges, you can select the nearest rated voltage. For example, for 69 kV ANSI voltage, please select 66 kV rated voltage.
System frequency	50 Hz/60 Hz
Cable overall diameter	5 mm to 40 mm (non-insulated) 15 mm to 40 mm (insulated) ⁶
Measurement cycle period	20 ms for 50 Hz 16.6 ms for 60 Hz
Voltage presence	> 70 % of V_{rated}
Voltage absence	< 45 % of V_{rated}
Rated current (I_{rated})	50 A to 500 A (increments of 50 A)
Current measurement accuracy	± 10 % from 50 A to 800 A (50 Hz and 60 Hz) ⁷
Power source	Lithium-thionyl chloride battery + energy harvesting ⁸
Total fault-indication time	400 h of LED flashing
Temperature with-stand of clamping material	120 °C

Fault-Detection Parameters

di current	5 A to 80 A (steps of 5 A), 120 A, 160 A
Current threshold value	$1.5 \cdot I_{rated}$ to $3 \cdot I_{rated}$ (steps of 0.5)
Protection measurement range of device	75 A to 1500 A
Fault-indication time	2 h to 16 h (steps of 0.5 h)
Inrush restraint time	3 s, 30 s, and 60 s
Permanent-fault verification time	3 s, 35 s, and 70 s
Automatic reclosing time	0.1 s to 99.9 s

⁵ The 44 kV setting option is only available for combination of SICAM FSI with firmware version V03.03 or higher and SICAM FCG with firmware version V04.12 or higher.

⁶ SICAM FSI with cable overall diameter 5 mm to 15 mm (insulated cables) can be ordered on a special request. Contact the local Siemens office for more information.

⁷ Current measurement accuracy is applicable for temperature range of -25 °C to 70 °C.

⁸ Energy harvesting starts if the phase current is above 60 A.

Short-Range Radio Communication

Communication mode	Short-range radio (wireless)
Operating frequency band	2.4 GHz (IEEE 802.15.4)
RF output power range used by SICAM FSI per country/region	10 dBm to 20 dBm



NOTE

The communication mode is applicable for the SICAM FSI with integrated communication (6MD2314-1Ax11).

Reset Device

Voltage restoration reset	$V_{\text{rated}} > 70 \%$
Magnet reset	Using magnetic adaptor
Remote reset	Via SICAM FCG from the control center (SICAM FSI with integrated communication)
Auto timer reset	2 h to 16 h (steps of 0.5 h)

Fault Indication – LEDs

Indication	6 red LEDs
Luminous flux	40 lm
Visibility angle	360° (from ground level)
Visibility range	50 m at day time, 300 m at night time

Mechanical Data

Weight	0.78 kg	
Dimensions	Diameter	Height
	116 mm	210 mm

Environmental Conditions

Outdoor Applications as per IEC 61010-1	
Degree of pollution	Category 2
Maximum altitude above sea level	5000 m
SICAM FSI is suitable for outdoor applications on MV overhead line	–

7 Type Testing

7.1	Type Testing	128
-----	--------------	-----

7.1 Type Testing

This section describes the type testing performed on SICAM FSI.

Electrical Tests

Table 7-1 Electrical Tests

Test	Standards	Tests Requirements
Dielectric withstand	IEC/EN 61010-1	125 kV ⁹
Overvoltage	IEC/EN 61010-1	Category IV
Short-circuit current withstand test	IEEE 495	12.5 kA @ 1 s 25 kA @ 170 ms

EMC Tests for Immunity

Table 7-2 EMC Tests for Immunity

Test	Standards	Tests Requirements
Electrostatic discharge, Level 3	EN 301 489-1, EN 301 489-17, IEC 61000-4-2	8 kV air discharge and 6 kV contact discharge
Radiated radio frequency electromagnetic field	EN 301 489-1, EN 301 489-17, IEC 61000-4-3	80 MHz to 1000 MHz (10 V/m, Level 3) 1 GHz to 6 GHz (3 V/m, Level 2)
Power frequency magnetic field, Level 4	IEC 61000-4-8	30 A/m (continuous) and 300 A/m (short time) on the X, Y, and Z axis of the product

EMC Tests for Noise Emission

Test	Standards	Tests Requirements
Radiated emission test, Class A	EN 301 489-1, EN 301 489-17, EN 55032	30 MHz to 6 GHz (class A)

Safety Testing

Test	Standards
Safety test	EN/IEC 61010-1, EN IEC 62368-1

EN/IEC 61010-1

Description	Applicable Clause No.
Marking and documentation	5
Protection against mechanical hazard	7
Resistance to mechanical stresses (shock and impact)	8
Protection against the spread of fire	9
Protection against liberated gases and substances, explosion, and implosion	13
Components and subassemblies	14

⁹ Dielectric strength of 125 kV AC is achieved by using Siemens recommended hot stick during mounting/unmounting of SICAM FSI on the overhead line.

Description	Applicable Clause No.
Hazards resulting from application	16
Risk assessment	17

Environmental Tests

Table 7-3 Insulation Tests

Test	Reference	Tests Requirements
Operating Temperature		
Dry cold test (4 days)	IEC 60068-2-1	-25 °C or -40 °C ¹⁰
Dry heat test (4 days)	IEC 60068-2-2	+70 °C
Damp heat steady (4 days)	IEC 60068-2-78	40 °C; 95 % RH
Damp heat cyclic (6 days)	IEC 60068-2-30	25 °C to 40 °C; 95 % RH (6 cycles with 12 h + 12 h)
Storage temperature ¹¹	IEC 60068-2-48	-25 °C to 70 °C or -40 °C to 70 °C ¹⁰
Rainfall	-	750 mm
Exposure to direct sunlight (UV)	ASTM G155	14 days
Wind resistance	-	200 km/h
Salt spray test	ASTM B117	72 h
Ingress protection	IEC 60529	IP68
Degree of pollution	IEC 61010-1	Category 2
Maximum altitude above sea level	IEC 61010-1	5000 m

Mechanical Tests

Table 7-4 Mechanical Tests

Standards	Reference	Tests Requirements
Vibration response test, Class 1	IEC 60068-2-6	Sinusoidal Frequency: 10 Hz to 500 Hz Displacement: 0.7 mm peak to peak from 10 Hz to 59 Hz Amplitude: 5 g from 59 Hz to 500 Hz Sweep rate: 1 oct./min Number of sweeps: 01/axis Number of axes: 3 (X, Y, and Z)
Bump test	IEC 60068-2-27/IEC 60068-2-29	Acceleration: 40 g Duration: 6 ms Number of sweeps: 2000 positive and 2000 negative shocks Number of axes: 3 (X, Y, and Z) Number of bumps: 1000 per direction Number of direction: 2 per axis Total number of bumps: 6000

¹⁰ Refer to [2.2.1 SICAM FSI - Selection and Ordering Data](#) for details.

¹¹ For optimum battery capacity, it is recommended to store the device below 30 °C; 30% RH

Short-Range Radio (Wireless) Testing

Table 7-5 Short-Range Radio (Wireless) Testing

Standards	Reference	Tests Requirements
Spurious emission	EN 300 328	Transmitter unwanted emissions in the spurious domain and receiver spurious emissions Operating frequency range: 2400 MHz to 2480 MHz No. of channels: 16 Modulation: Other than frequency hopping spread spectrum (FHSS) direct sequence spread spectrum (DSSS) Channel spacing: 5 MHz

Certifications

Table 7-6 Certifications

Certification	Standards	Test Requirements
WPC ETA certification	-	2405 MHz to 2480 MHz WPC ETA certification is performed as per R&TTE/RED directive
FCC and ISED certification	FCC Part 15 Subpart C 15.247, 15.207 RSS 247 Issue 2, RSS Gen Issue 5	2405 MHz to 2480 MHz FCC and ISED certification
CE/RED Certification	ETSI EN 300 328 EN 62311	2405 MHz to 2480 MHz, with measuring frequency range of 30 MHz to 12.75 GHz

Optical Tests

Table 7-7 Optical Tests

Test	Standards	Tests Requirements
Lumens test	LM79	40 lm
Goniometry test	LM79	360° visibility

8 Maintenance

8.1	Replacing the Battery	132
8.2	Environmental Protection Hints	139

8.1 Replacing the Battery

SICAM FSI uses a non-rechargeable 3.6 V LiSoCl₂ battery.

Siemens recommends replacing the battery within 1 month after appearance of the low-battery indication.



NOTE

It is mandatory to replace the battery with **Make: Tadiran, part number : TL-5930/SMNS (MLFB: 6MD2318 - 4BB00)** to claim the required battery life.



WARNING

In case of incorrect treatment or if you use the wrong battery type, the battery may burn, explode, or trigger a chemical reaction.

Non-observance of the safety notes may lead to death or serious injury.

- ✧ Installing the battery or replacing it may only be carried out by trained personnel (see preface) who are familiar with and observe the safety requirements and precautions.
 - ✧ The battery used in this device may present a fire or chemical burn hazard if mistreated. Do not recharge, disassemble, heat above 100 °C (212 °F), or incinerate the battery.
 - ✧ See the Tadiran batteries product information (SDS No.- T-36-04 (Revision–M) for more details on the battery type to be used.
 - ✧ Do not reverse the polarity of the battery.
 - ✧ Do not short-circuit the contacts. Use non-conducting tools for removing and installing the battery.
 - ✧ Do not attempt to open the battery.
 - ✧ Dispose of used battery promptly.
-

To replace the battery, proceed as follows:

- ✧ Unmount the device from the MV overhead line.
- ✧ Unscrew the 3 screws using a Phillips screwdriver of tip size 1 and remove the transparent cover from the device housing.
- ✧ Remove the PCBA from the device without removing the battery, coil, and voltage detection plate wire connections.
- ✧ Switch the 3-pin (X6) jumper pin from ON to OFF position on the PCBA to save battery life.

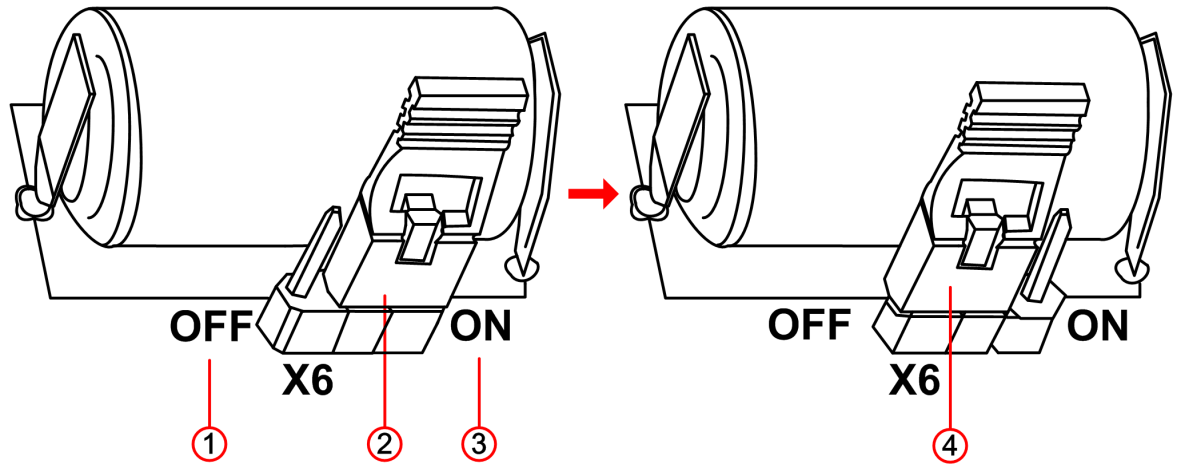

[file_sfsi_hicboard-on-off, 1, -,-]

Figure 8-1 3-Pin (X6) Jumper Pin on PCBA

- (1) OFF position marking on PCBA
- (2) Jumper pin in ON position
- (3) ON position marking on PCBA
- (4) Jumper pin in OFF position

✧ Disconnect the 2-pin (X3) battery polarized connector from the PCBA.

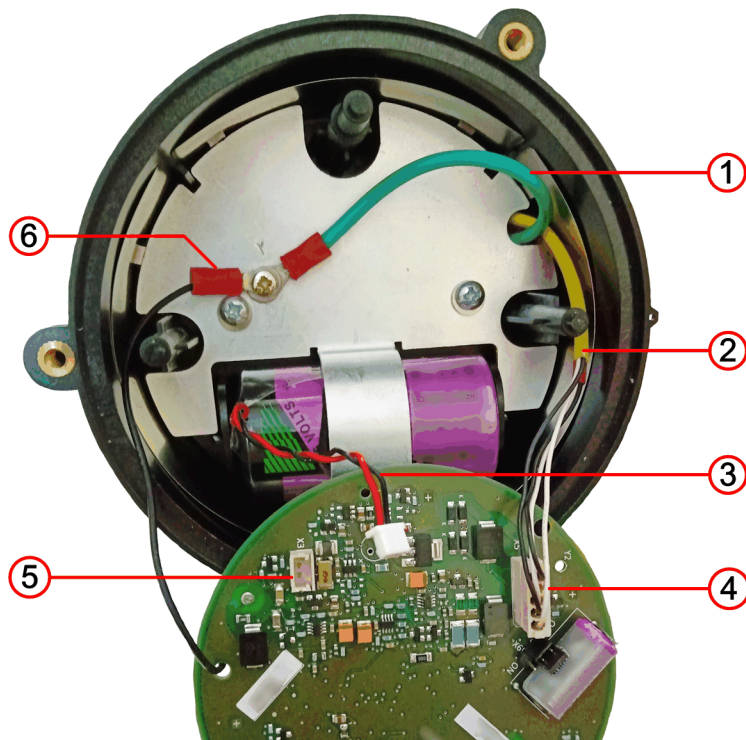

[file_sfsi_wireroutehc_bat, 2, -,-]

Figure 8-2 Wires and Connectors in the Device Housing

- (1) Voltage detection plate wire 2 (from sensor assembly)
- (2) Coil wire
- (3) Battery wire
- (4) 5-pin (X5) connector

8.1 Replacing the Battery

- (5) 2-pin (X3) battery connector
- (6) Voltage detection plate wire 1 (from PCBA)

✧ Remove the voltage detection plate by unscrewing 2 screws from the housing and then remove old battery.

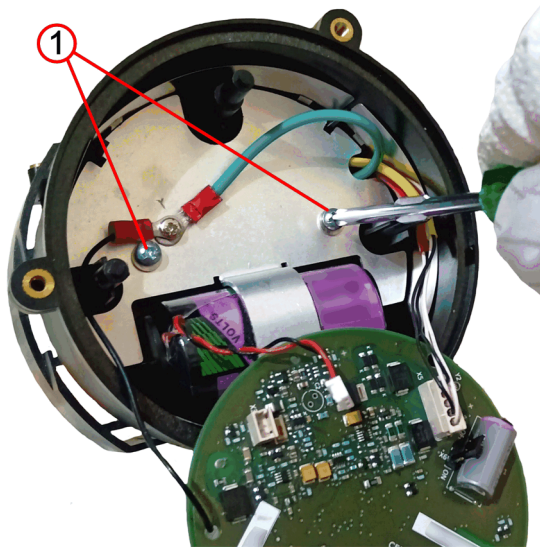

[dw_sfsi_vltplatehc, 3, --]

Figure 8-3 Unscrewing the Voltage Detection Mounting Plate Screws

- (1) Voltage detection mounting plate screws

✧ Unpack the new battery.
✧ Place the new battery in the housing with the same position, orientation, and polarity as the old battery.

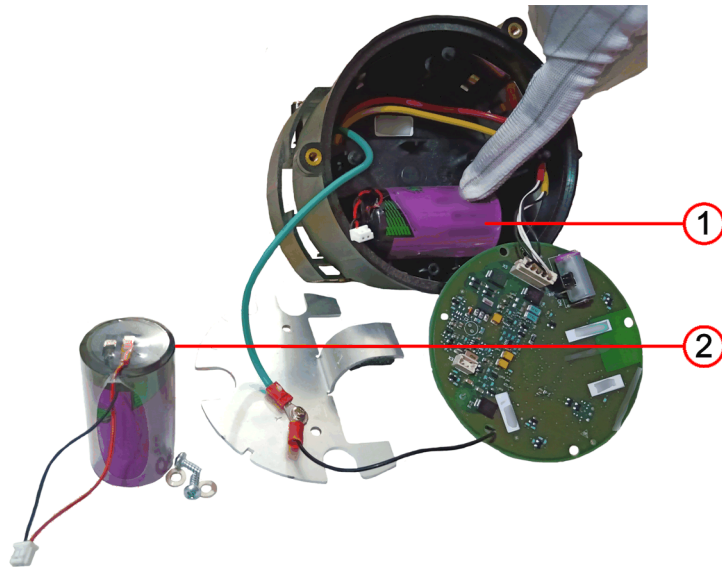

[le_sfsi_batt_replacehc, 3, --]

Figure 8-4 New Battery Placed in the Housing

- (1) New battery
- (2) Old battery

✧ Place the voltage detection plate again in the housing and tighten it with 2 screws.



[dw_sfsi_voltmtipitscrewhtc, 3, --]

Figure 8-5 Fitting the Voltage Detection Plate in the Housing

- ✧ Connect the new battery wire to the 2-pin (X3) battery polarized connector in the PCBA.

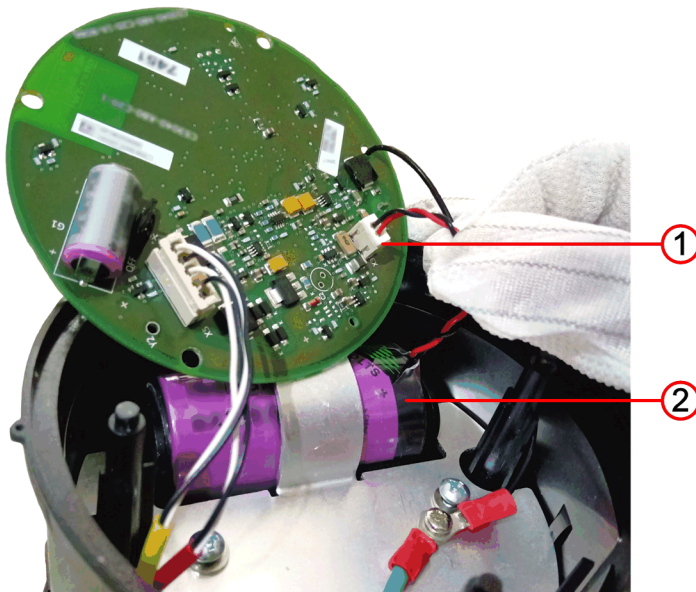

[file_sfsi_batt_x3connecthc, 4, --]

Figure 8-6 Battery Wire Connected to the 2-pin (X3) Battery Polarized Connector

- (1) 2-pin (X3) battery polarized connector
- (2) Battery

- ✧ Switch the 3-pin (X6) jumper pin from OFF to ON position on the PCBA.

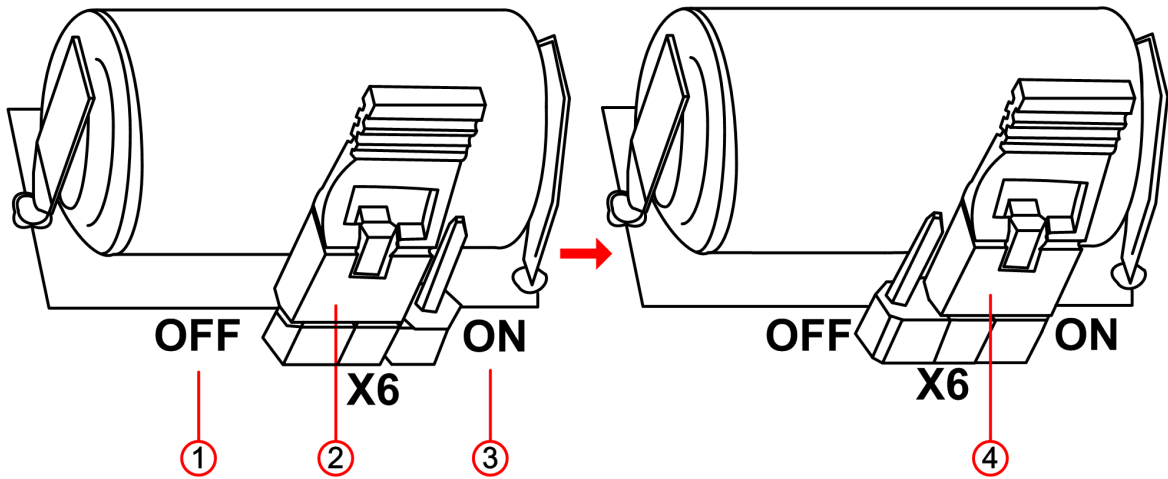

[file_sfsi_hicboard-off-on, 2, --]
Figure 8-7 3-Pin (X6) Jumper Pin on PCBA

- (1) OFF position marking on PCBA
- (2) Jumper pin in OFF position
- (3) ON position marking on PCBA
- (4) Jumper pin in ON position

✧ The following figure shows that all the 3 wires (coil, battery, and voltage-detection plate) are routed.

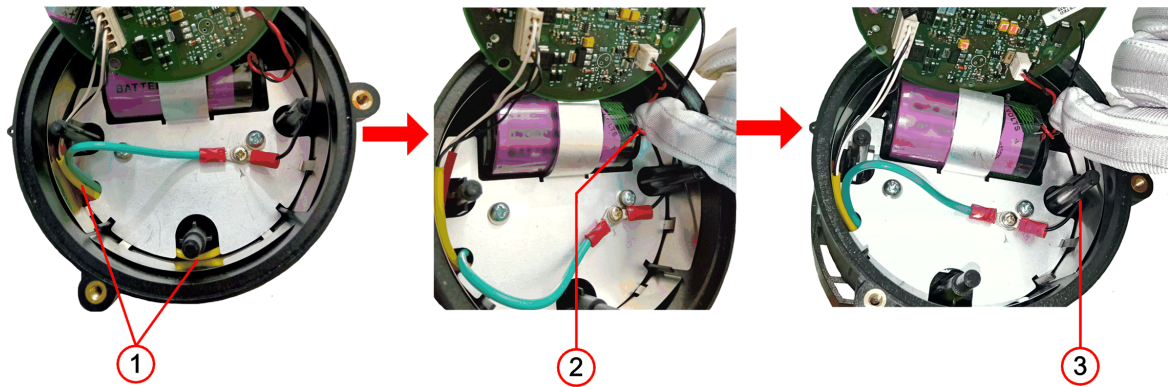

[file_sfsi_wireconnectnew, 2, en_US]
Figure 8-8 3 Wires Routing Sequence in the Housing

- (1) Coil wires routed around mounting bosses
- (2) Battery wire
- (3) Voltage detection plate routed around mounting boss



NOTE

Make sure that voltage-detection plate wire is tight enough on the voltage detection plate. Voltage-detection plate wire must be aligned in proper orientation as shown in [Figure 8-8](#).

✧ Place the PCBA in the housing such that 3 mounting bosses of the housing is locked into the assembly holes of the PCBA.

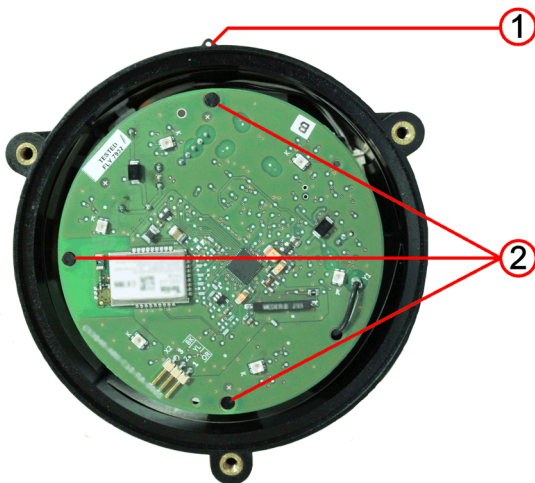

[le_sfsi_pcbaslot-20160503, 2, --]

Figure 8-9 PCBA Placed in the 3 Mounting Bosses of Housing

- (1) Sealing hole
- (2) Mounting Boss

✧ Ensure that the gasket is in place and align the device transparent cover with the sealing hole (Figure 8-9). Then place the transparent cover in the device housing.

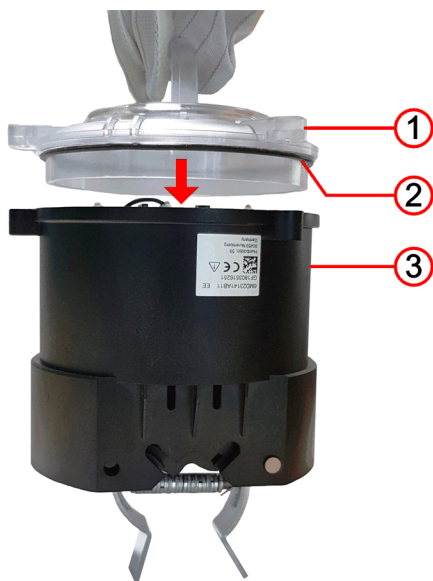

[le_sfsi_danqdsdevgskt, 1, --]

Figure 8-10 Placing the Transparent Cover in Device Housing

- (1) Device transparent cover
- (2) Gasket
- (3) Device housing

✧ Manually thread 3 screws and then tighten using a torque screw driver with a torque of 0.7 N.

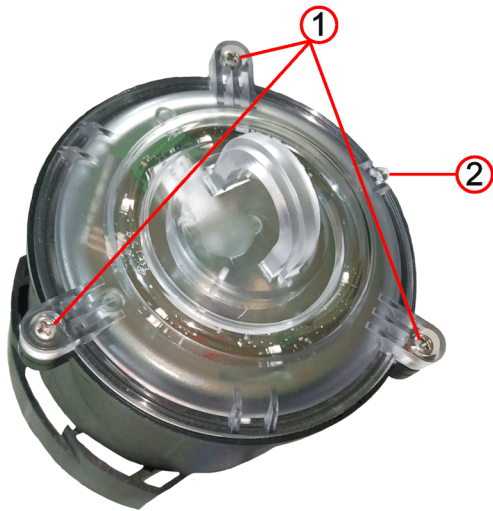

[le_sfsi_covermount, 3, -,-]

Figure 8-11 Screws Tightened with the Housing

- (1) Screws
- (2) Sealing hole alignment

8.2 Environmental Protection Hints

Disposal of Old Equipment and Batteries (Applicable only for European Union and Countries with a Recycling System)

The disposal of our products and possible recycling of their components after decommissioning has to be carried out by an accredited recycling company, or the products/components must be taken to applicable collection points. Such disposal activities must comply with all local laws, guidelines and environmental specifications of the country in which the disposal is done. For the European Union the sustainable disposal of electronic scrap is defined in the respective regulation for "waste electrical and electronic equipment" (WEEE).



The crossed-out wheellie bin on the products, packaging and/or accompanying documents means that used electrical and electronic products and batteries must not be mixed with normal household waste.

According to national legislation, penalties may be charged for incorrect disposal of such waste.

By disposing of these products correctly you will help to save valuable resources and prevent any potential negative effects on human health and the environment.



NOTE

Our products and batteries must not be disposed of as household waste. For disposing batteries it is necessary to observe the local national/international directives.

Disposal of Mobile Storage Devices (e.g. USB Sticks and Memory Cards)

When disposing of/transferring mobile storage devices, using the **format** or **delete** functions only changes the file management information and does not completely delete the data from your mobile storage device. When disposing of or transferring a mobile storage device, Siemens strongly recommends physically destroying it or completely deleting data from the mobile storage device by using a commercially available computer data erasing software.

REACH/RoHS Declaration

You can find our current **REACH/RoHS** declarations at:

<https://www.siemens.com/global/en/home/products/energy/ecotransparency/ecotransparency-downloads.html>



NOTE

You can find more information about activities and programs to protect the climate at the EcoTransparency website:

<https://www.siemens.com/global/en/home/products/energy/ecotransparency.html>

9 Troubleshooting

9.1	Troubleshooting	142
9.2	Shipping Instructions – Field Returns	145

9.1 Troubleshooting

This section provides information on the common problems of SICAM FSI and the recommended solutions.

Observations	Action
SICAM FSI is not functioning	<ul style="list-style-type: none"> • Reset the device with the magnet adaptor. • If the magnet adaptor reset is not successful, remove the screws from the housing and ensure that the battery wire is connected properly. • Check the battery voltage. Refer to 9.2 Shipping Instructions – Field Returns.
SICAM FSI with integrated communication failed to communicate as per the configuration settings	<ul style="list-style-type: none"> • Perform the communication test to verify that the quality parameters of the short-range radio (wireless) communication are available as per the configuration.
SICAM FSI failed to communicate with the gateway device during initial communication	<ul style="list-style-type: none"> • Perform the magnetic reset, to restart the communication between SICAM FSI and SICAM FCG.
SICAM FSI with integrated communication resets immediately after detecting the fault	<ul style="list-style-type: none"> • Check if the remote reset is activated via the SCADA control center.
SICAM FSI does not connect with SICAM FSI Configurator even after log-on	<ul style="list-style-type: none"> • Perform magnetic reset of the device and then log-on to SICAM FSI Configurator.
If there is no visual indication for fault condition in SICAM FSI and SICAM FSI with integrated communication	<p>The device does not indicate any fault condition only if the battery is drained. To confirm the battery drained condition:</p> <ul style="list-style-type: none"> • Perform magnetic reset and check for the LED startup flashing sequence. • If the LED startup flashing sequence is not seen, it confirms that the battery is completely drained and replace with a new battery. • Unmount the device from the MV overhead line. • Remove the old battery and replace it with a new battery.

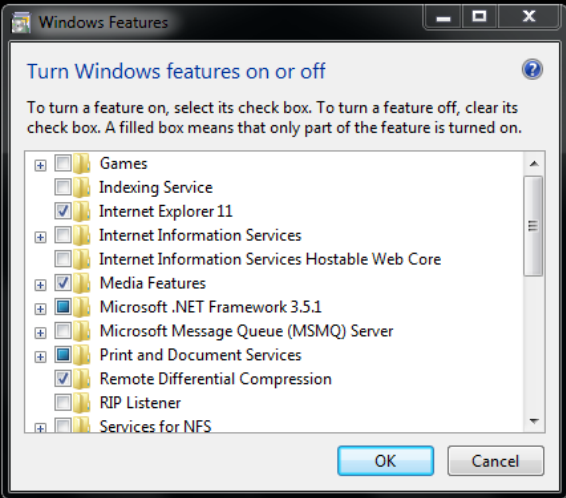
Observations	Action
<p>A failure is reported during SICAM FSI internet site registration with IIS.</p>	<ul style="list-style-type: none"> Go to Control Panel → Programs → Features. Click the Turn Windows features on or off on the left menu pane. The Windows Features dialog appears. In the Internet Information Services (IIS), deselect the IIS. Click OK.  <ul style="list-style-type: none"> If needed, restart the program after deselecting the IIS and reboot the PC. Once the PC is restarted, go to Control Panel → Programs → Features and select the Turn Windows features on or off on the left menu pane. Select the IIS and retry the SICAM FSI setup.
<p>The UART cable connected to the USB port of the PC or laptop computer is not detected</p>	<p>Update the UART cable drivers via Control Panel → Device Manager and browse for the USB drivers from the following path: C:\Program Files (x86)\Siemens Energy\SICAM FSI\USBDrivers</p>
<p>Unable to find out SICAM FSIs firmware version</p>	<ul style="list-style-type: none"> <u>For SICAM FSI with Integrated Communication:</u> Access SICAM FCG Web GUI and navigate to Maintenance page → Diagnosis → FSIs to check the associated SICAM FSIs versions. <u>For SICAM FSI:</u> Connect the UART cable one end to SICAM FSI and other end to PC or Laptop. Log in SICAM FSI configurator to know the firmware version of SICAM FSIs. Refer to 5.6.2 Device Information . Refer to appendix A.1 Firmware and Configurator Version Compatibility with SICAM FSI.

Observations	Action
Unable to update latest firmware versions in SICAM FSI	<ul style="list-style-type: none"> • SICAM FSI firmware V02.XX cannot be uploaded in SICAM FCG with firmware V01.XX. The FSI file could not decoded message reflects in SICAM FCG Web GUI. Update the gateway device (SICAM FCG) firmware with latest V02.XX. • Upload latest SICAM FSIs V01.XX and V02.XX firmwares to gateway device SICAM FCG. • The new SICAM FSI firmware is updated sequentially in the next communication time frame. • SICAM FSI firmware V02.XX cannot be uploaded in FSI Configurator V01.XX. Firmware update has failed as the selected file is corrupted message reflects on FSI configurator V01.XX. Upgrade the FSI Configurator to V02.XX.
Visibility of LED flashing is poor	Dust settled on transparent cover impacts the visibility of LED indication. Clean the transparent cover in periodic intervals.
SICAM FSI FF version gets updated with firmware version less than V02.20	<ul style="list-style-type: none"> • Using the SICAM FCG Web UI, first update the SICAM FCG version to V02.13 or higher. • Then update the SICAM FSI firmware to the latest available version (greater than V02.20) as per the firmware compatibility matrix (Table A-1).
SICAM FSI basic parameter is showing <i>Invalid</i> setting when SICAM FSI is connected to SICAM FSI configurator	<ul style="list-style-type: none"> • Close the SICAM FSI Configurator page • Check if the UART cable is connected properly to the PC or laptop computer. • Perform magnetic reset of the device and then re-login to SICAM FSI Configurator.

If the above troubleshooting checklist does not help in correcting the problem, contact the local Siemens office or contact customer support.

Our customer support center provides a 24-hour service.

Siemens AG

Smart Infrastructure – Digital Grid

Customer Support Center

Phone: +49 911 2155 4466

E-Mail: energy.automation@siemens.com

9.2 Shipping Instructions – Field Returns

In the event of shipping the SICAM FSI back to Siemens factory or any Siemens locations, follow instructions from customer support and also mandatory procedure below.

Note the SICAM FSI device serial number for future reference. Refer to label on the housing for device serial number [Figure 9-1](#).



[le_sfsi_devsemo, 1, -_-]

Figure 9-1 SICAM FSI Device Serial Number

(1) Device Serial Number Location

Before performing following procedure, identify the wires and connectors in the device housing and PCBA as shown in [Figure 3-3](#).

- Remove the transparent cover from the device housing.
- Switch the 3-pin (X6) jumper pin from ON to OFF position on the PCBA.

- Measure the battery voltage across the terminals on the PCBA with a multimeter as shown in [Figure 9-2](#).
 - If the battery is found healthy i.e. voltage is ≥ 3.5 V, disassemble the battery and then store for future use as per the storage conditions. Refer to [Environmental Tests, Page 129](#) for storage temperature.
 - If the battery is not healthy i.e. voltage is < 3.5 V, then dispose battery according to the local regulations as hazardous waste.
Refer to [8.1 Replacing the Battery](#) for procedure to unpack the battery from SICAM FSI housing.

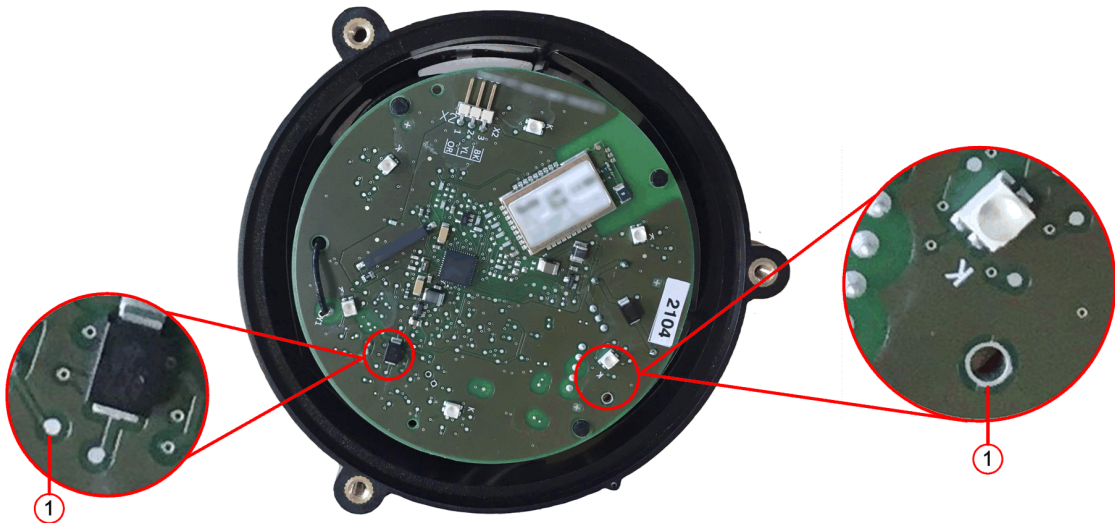

[dw_sfsi_batvolser, 1, --]

Figure 9-2 PCBA Terminal Location to Check Battery Voltage

(1) Terminals

- Disconnect the 2-pin (X3) battery polarized connector from the PCBA.
- Disconnect the 5-pin (X5) connector from the PCBA.
- Unscrew voltage detection plate wires 1 and 2 from the voltage detection plate.
- Remove the battery from the SICAM FSI housing. Refer to [8.1 Replacing the Battery](#) for battery removal procedure.
- Place the PCBA in the housing such that the 3 mounting bosses of the housing are locked into the assembly holes of the PCBA.

- Place the transparent cover in the device housing and tighten screws using a torque screw driver.
- Repack the SICAM FSI as shown in [Figure 9-3](#).

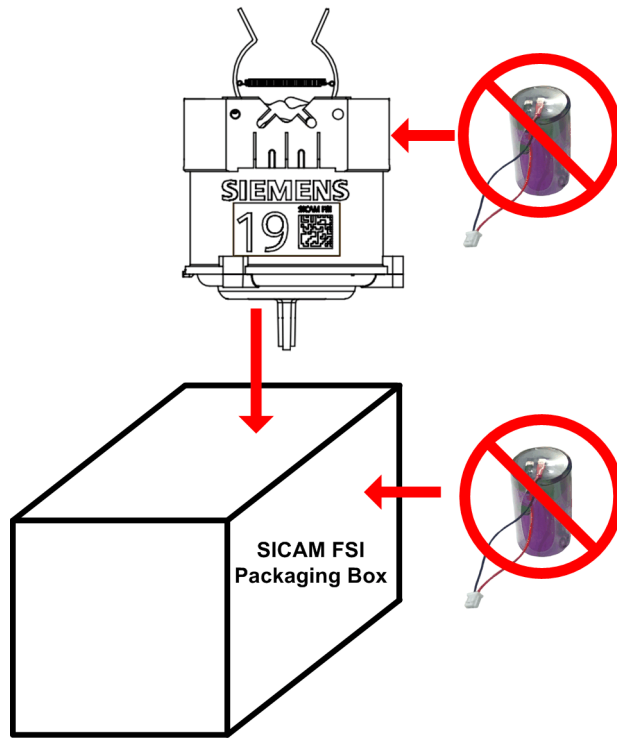

[dw_sfsi_dangdsrepkg, 1, --]

Figure 9-3 Repacking SICAM FSI and PCBA without Battery



NOTE

- SICAM FSI packed with HLC-1020 only, is treated as Exempted Dangerous Goods according to the Dangerous Goods Regulations.
- The classification is: UN 3481, Lithium-ion batteries contained in equipment, 9; preconditions of Special Provision 188 and Packing instruction 967 Section II met.
- For packing, marking, and declaration, follow the Packing instruction 967 Section II of the IATA-DGR for airfreight or the Special Provision 188 for all other modes of transport (for example, ADR/IMDG-Code).

A Firmware and Configurator Version Compatibility with SICAM FSI

A.1	Firmware and Configurator Version Compatibility with SICAM FSI	150
-----	--	-----

A.1 Firmware and Configurator Version Compatibility with SICAM FSI

Following table provides firmware and configurator version compatibility with SICAM FSIs:

Table A-1 Firmware Versions Compatibility

MLFB of SICAM FSI with Hardware Version	SICAM FSI Firmware Compatibility	SICAM FCG Firmware Compatibility	SICAM FSI Configurator
6MD2314 - 1AB10 BB 6MD2314 - 1AB11 BB	V01.XX	V01.XX or V02.XX or V03.XX or V04.XX	V01.XX or V02.XX
6MD2314 - 1AB10 DD 6MD2314 - 1AB11 DD	V01.XX	V01.XX or V02.XX or V03.XX or V04.XX	V01.XX or V02.XX or V03.XX
6MD2314 - 1AB10 EE 6MD2314 - 1AB11 EE	V02.XX	V02.XX or V03.XX or V04.XX	V02.XX or V03.XX
6MD2314 - 1AB10 FF 6MD2314 - 1AB11 FF	V02.2X and higher Less than V03.00	V02.13 and higher V03.XX V04.XX	V2.02 and higher V03.XX
6MD2314 - 1AB10 GG 6MD2314 - 1AB11 GG	V03.XX	V04.XX	V03.XX
6MD2314 - 1AC10 GG 6MD2314 - 1AC11 GG	V03.1X and higher	V04.XX	V03.XX

B SICAM FSI ACSR Cable Types and Diameter

B.1	Aluminum Conductor Steel Reinforced (ACSR) Cable Type and Diameter	152
-----	--	-----

B.1 Aluminum Conductor Steel Reinforced (ACSR) Cable Type and Diameter

Following table provides list of ACSR cable types and diameter as per BS 215 standard:

ACSR Cable Type	Approximate Overall Diameter
Rose	5.8 mm
Squirrel	6.3 mm
Weasel	7.7 mm
Rabbit	10.0 mm
Racoon	12.2 mm
Dog	14.5 mm
Wolf	18.0 mm
Panther	21.0 mm
Bear	23.4 mm
Zebra	28.6 mm
Moose	31.7 mm

Literature

- /1/ Siemens AG, SICAM FSI, Catalog
E50417-K1040-C587-A6
- /2/ Siemens AG, SICAM FSI, Quick Reference Guide
E50417-F1040-C587-A6
- /3/ Siemens AG, Pole Mounted SICAM FCG with Photovoltaic System, Application Guide
E50417-T1040-C587-A4
- /4/ Siemens AG, SICAM FCG, Product Information
E50417-X1040-C584-A5
- /5/ Siemens AG, SICAM FCG, Manual
E50417-H1040-C584-A8
- /6/ Siemens AG, SICAM FCG, Configuration/Interoperability Guide
E50417-T1040-C584-A1
- /7/ Siemens AG, Application Note SICAM FCG Control Center Connectivity using ScalanceS Security Module
E50417-T1040-C592-A1

Index

1,2,3 ...

6MD23 17

A

Advanced parameter settings 106
Application data 125
Applications 15
Auto reset 69

B

Backup device settings 111
Basic parameter settings 104
Battery health 71
Battery replacement 132

C

Commissioning 47
Communication test mode 76
Computer configuration requirements 81
Configurator installation 82
Configurator uninstallation 122
Control center 69
Control elements 98
Control functions 98
Current measurement 64

D

Delete log 75
Device info 110
Device information 101, 101
Device inspection 20
Device ordering information 17
Device unpacking 20
di/dt fault 66

E

Electrical tests 128
EMC tests for immunity 128
EMC Tests for noise emission 128
Energy harvesting 72
Environmental tests 129

F

Fault alarms 75
Fault detection 65
Fault detection parameters 125
Fault indication 126
Fault resets 68
Firmware update 59

I

Information section 105
Inrush restraint 69
Installation 21
Insulation test 129

L

LED flashing sequence 72
Log off 121

M

Magnet adaptor 47
Manual reset 69
Measured values 74
Mechanical 126
Mechanical tests 129
Mounting Methods 30

O

Operational log 75
Optical tests 130

P

Pairing SICAM FSI with SICAM FCG 48
Permanent fault 14
Permanent phase fault 66
Permanent-fault verification time 64
Power frequency 64

Q

QR code scanner 48

R

Remote reset 69
Reset 126
Reset to factory settings 111
Restore the device settings 112

S

Safety testing 128
Settings 101
Short-range radio (wireless) communication 73
Short-range radio (wireless) testing 130
Short-Range Radio Communication 126
SICAM FSI 14
SICAM FSI configurator settings 102
SICAM FSI Configurator user interface 99
SICAM FSI with integrated communication 14

T

Temporary fault 14
Temporary phase fault 65
Troubleshooting 142

U

UART serial cable 59
Unmounting 56
Update firmware 116

V

Voltage detection 64
Voltage reset 68